

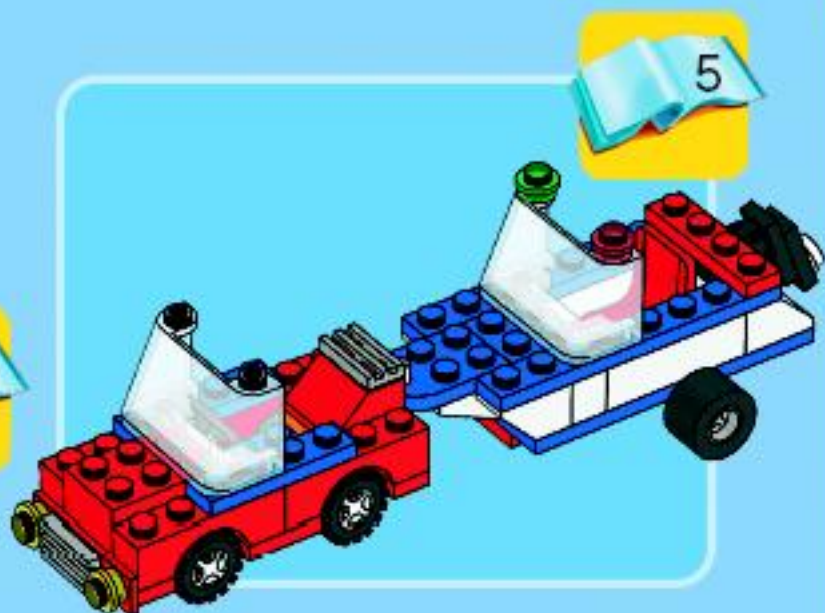

5508



**WARNING: CHOKING HAZARD.**  
Small parts. Not for children under 3 years.



1

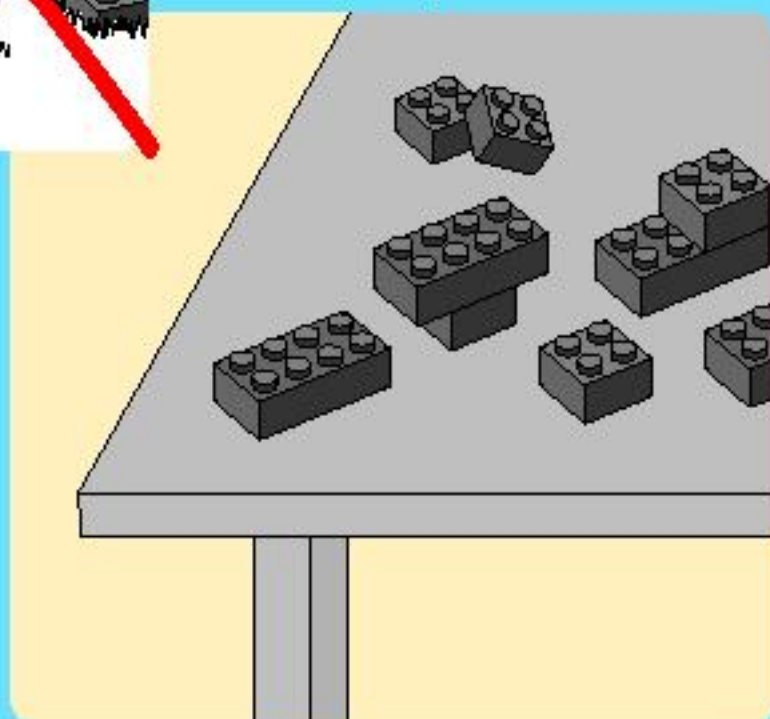

2

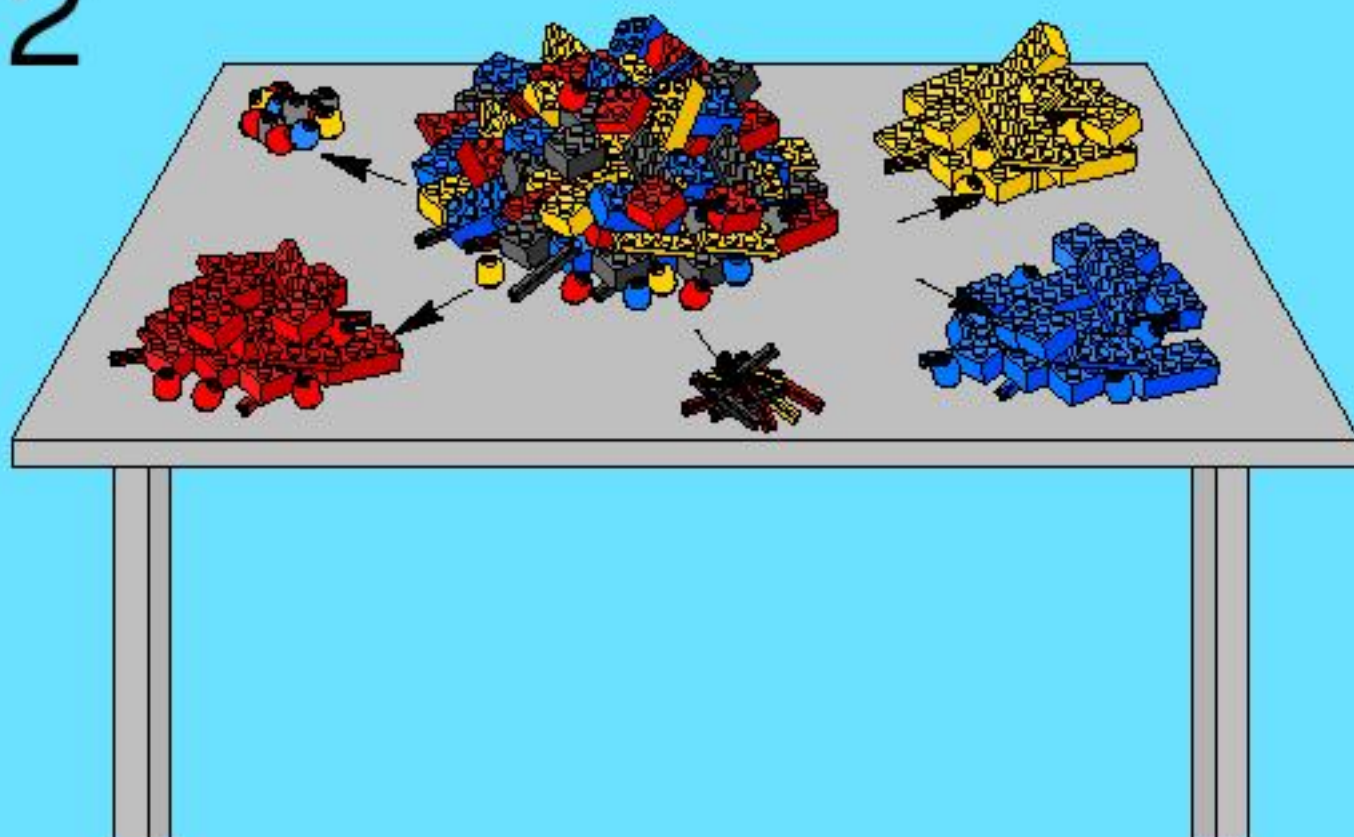

3

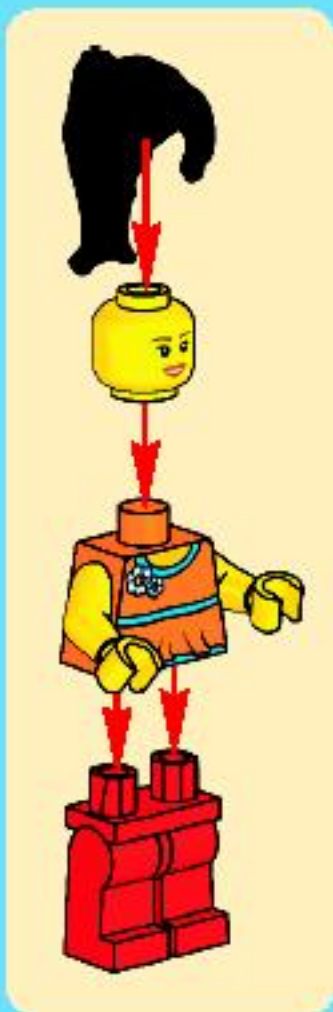

1

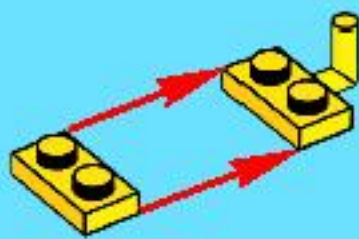

2

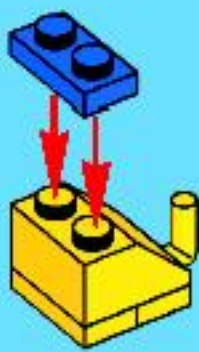

3



1



2

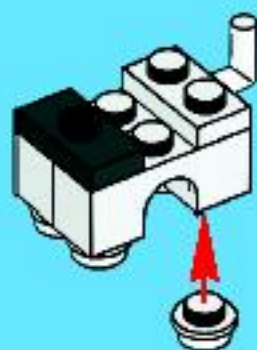

3



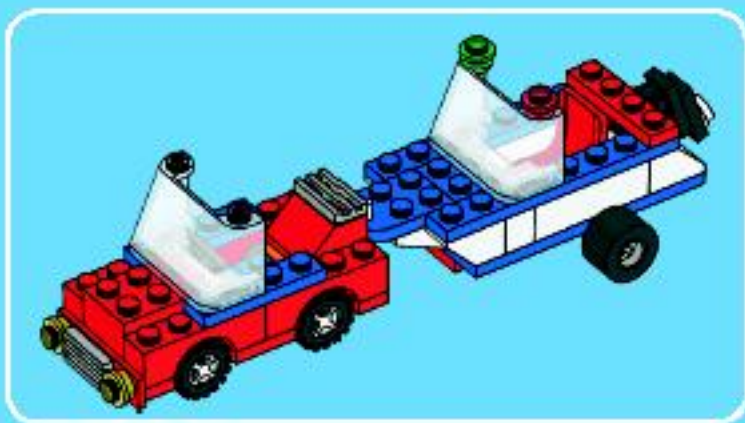

1



2

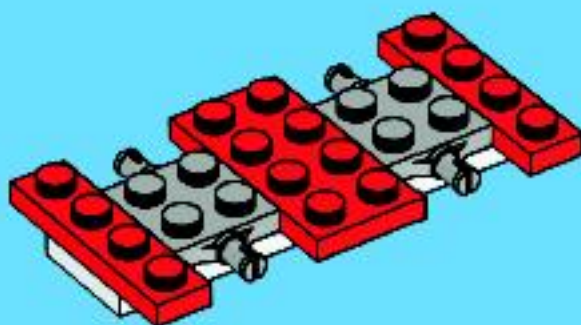

3

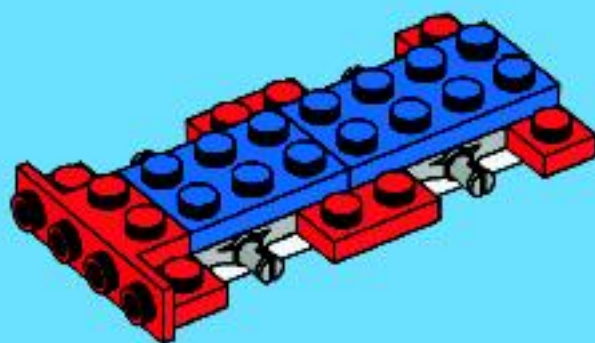

4

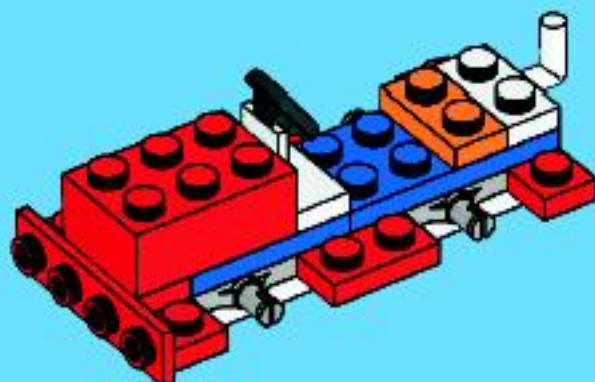

5

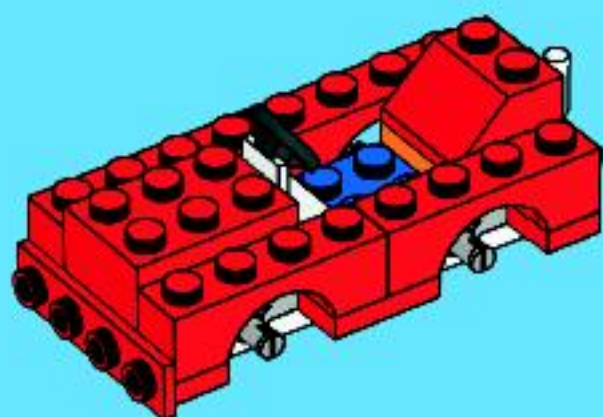

6

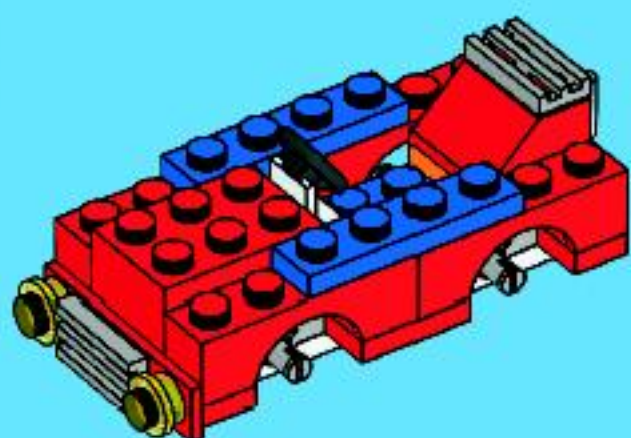

7

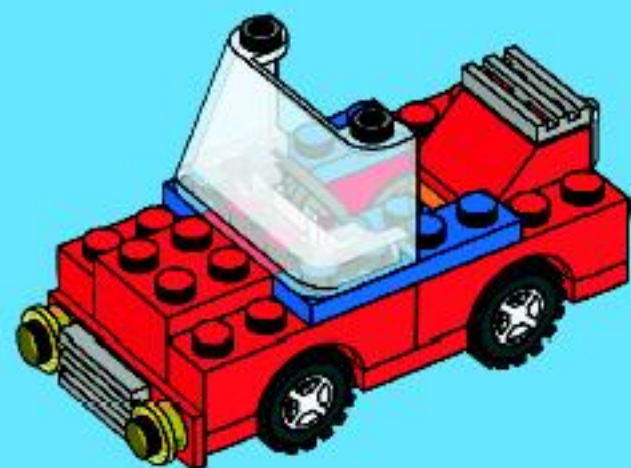

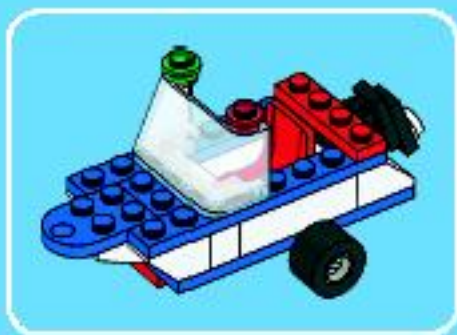

1

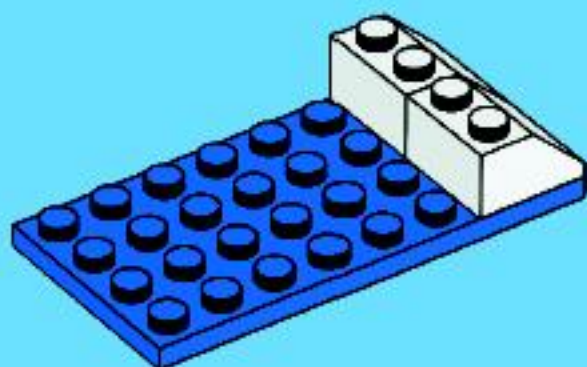

2

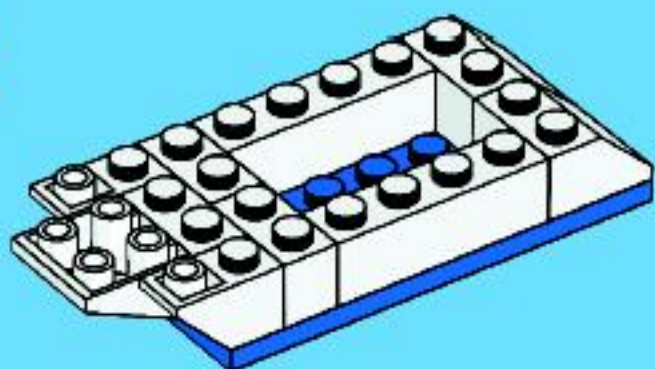

3

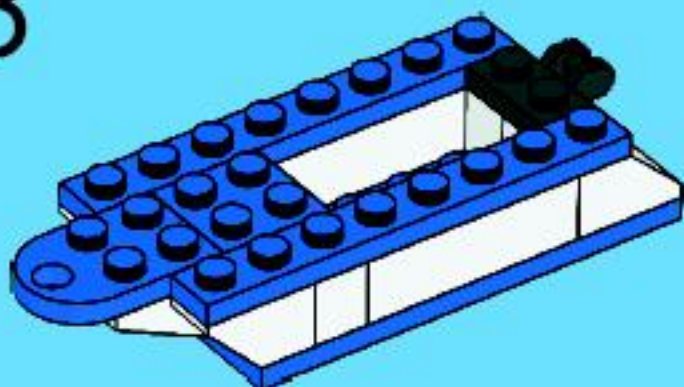

4

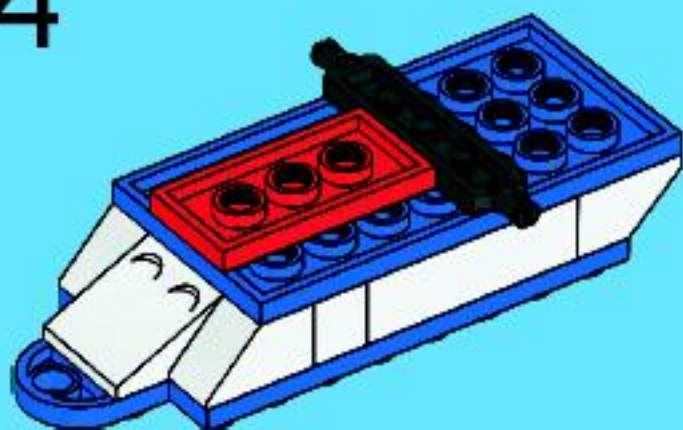

1



2



5

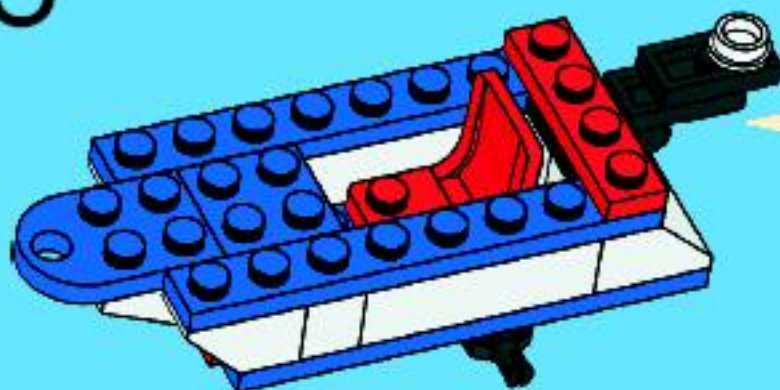

6

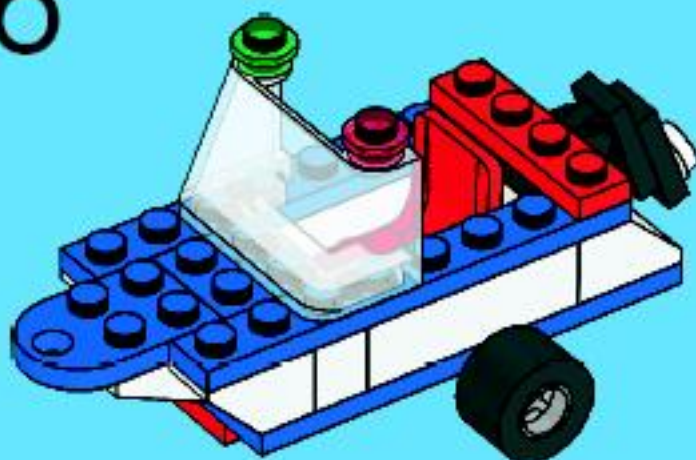





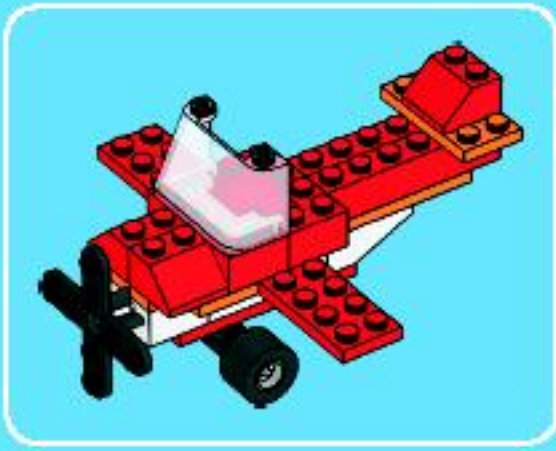

1

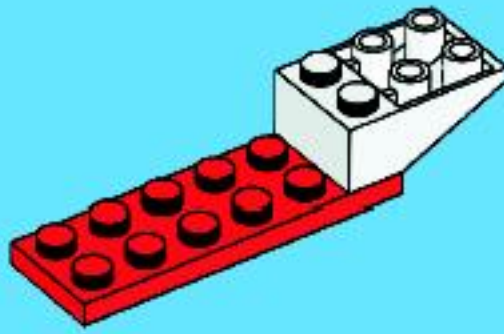

2

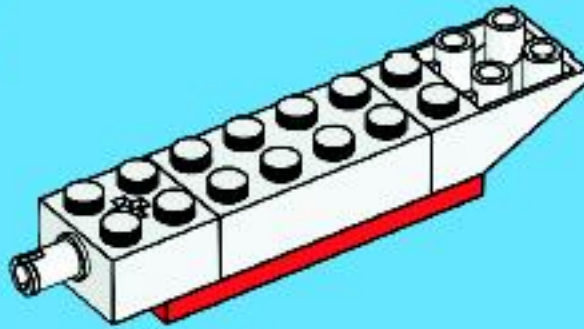

3

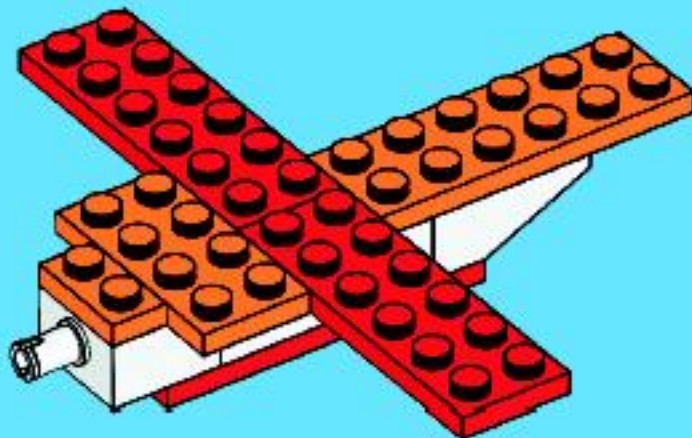

4

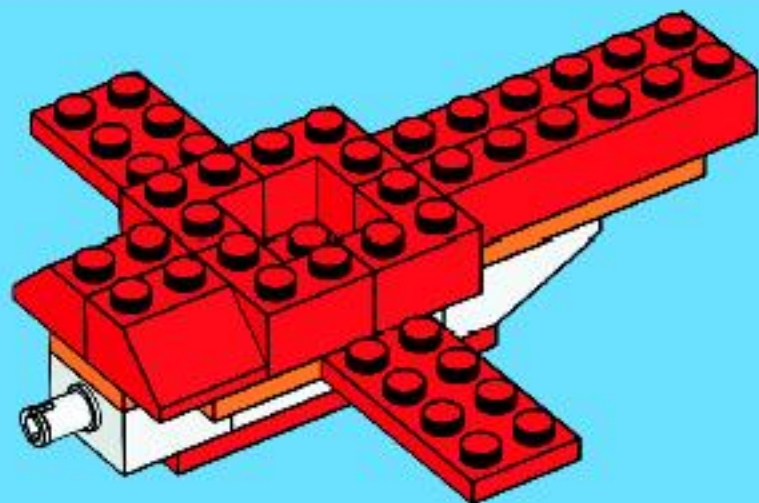

5

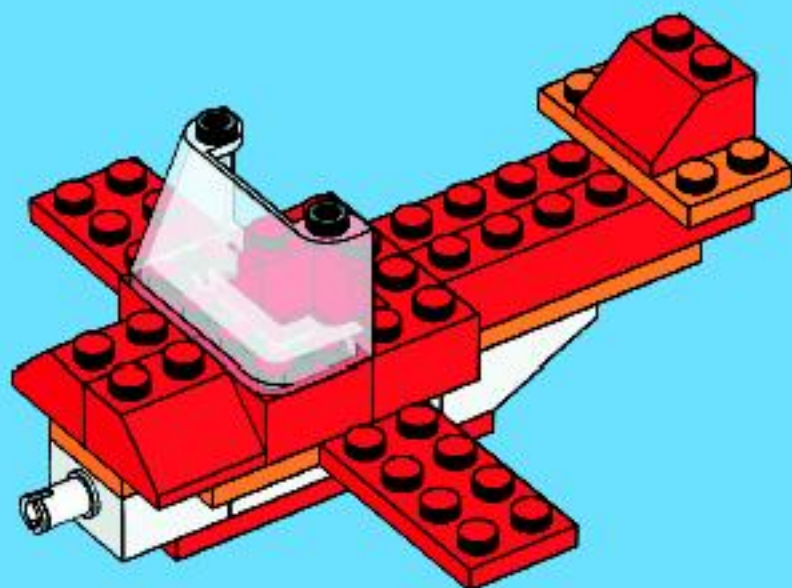

6

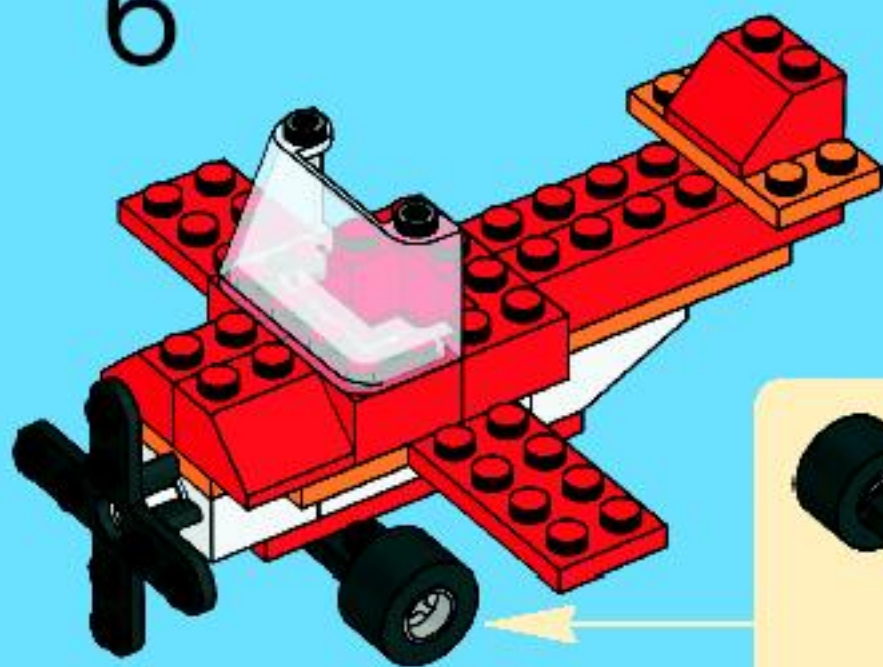







1

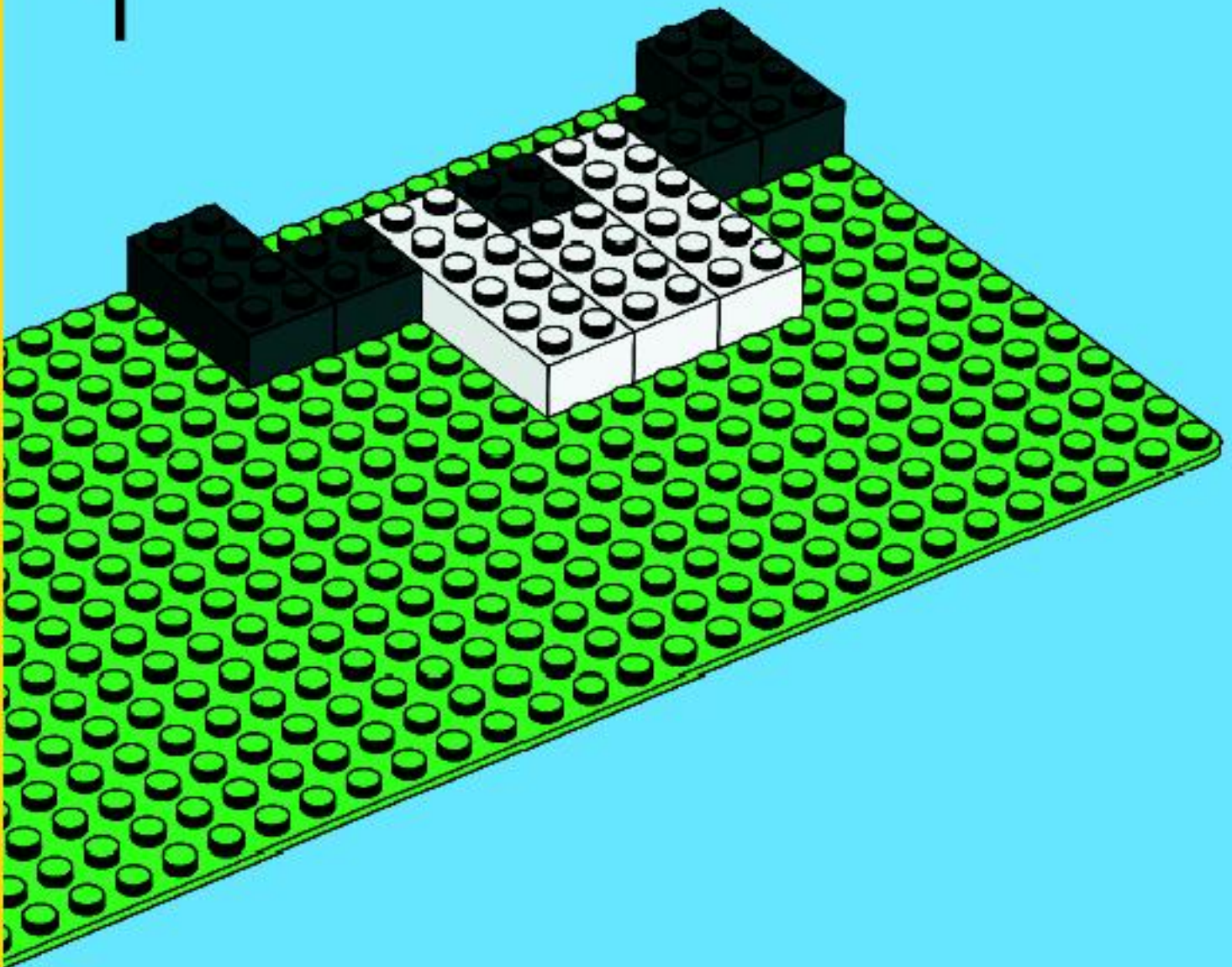

2

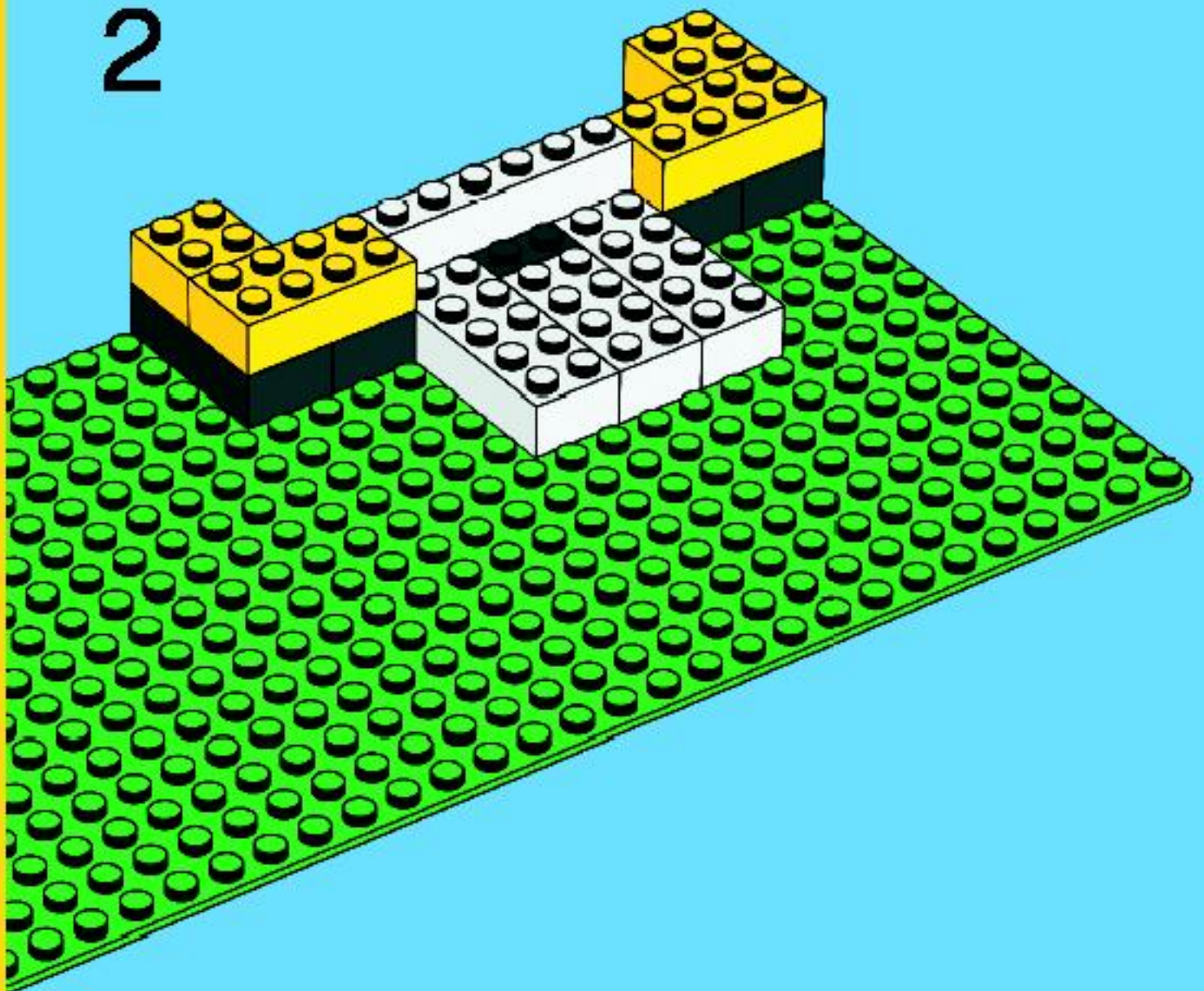

3

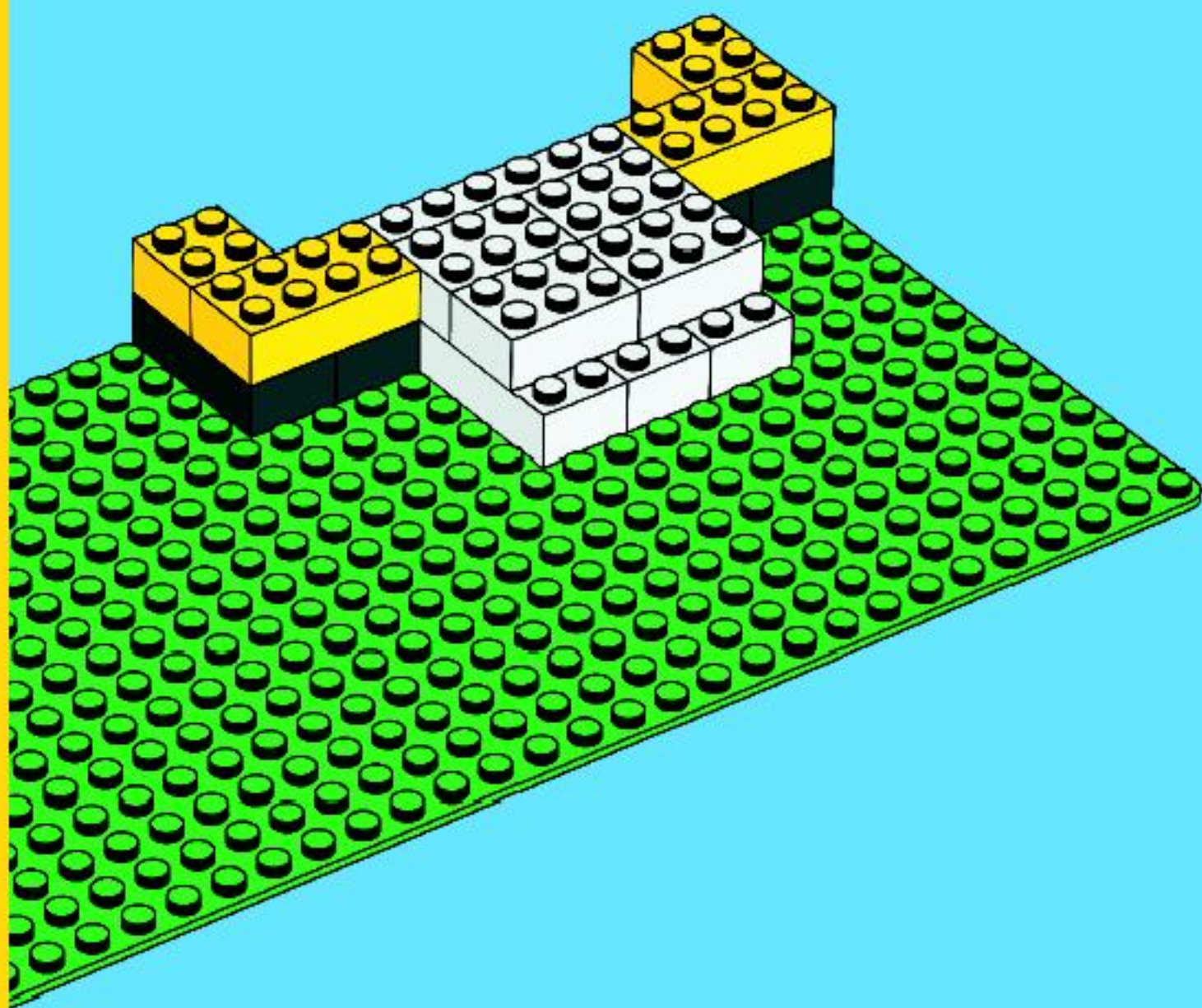



4

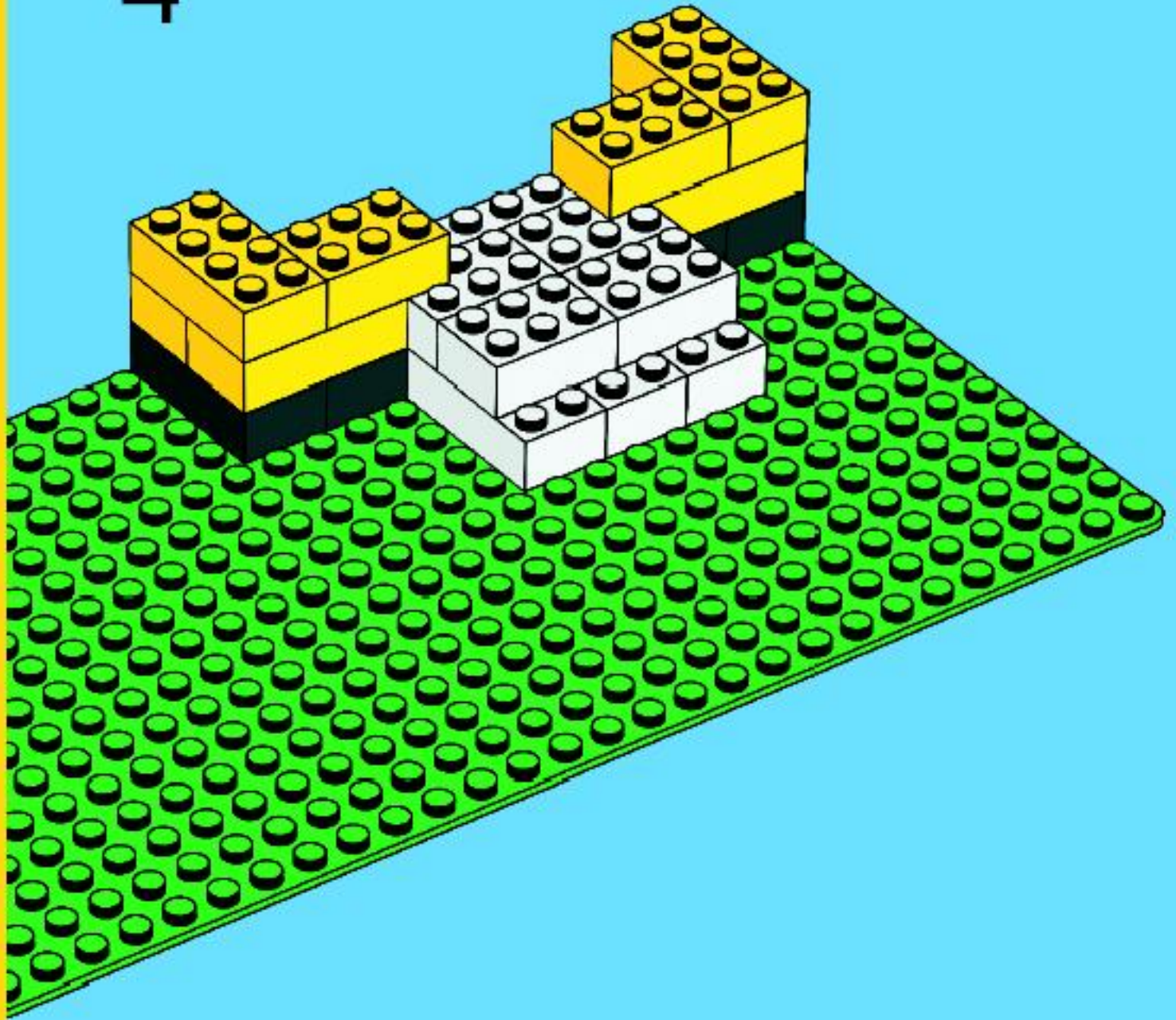

5

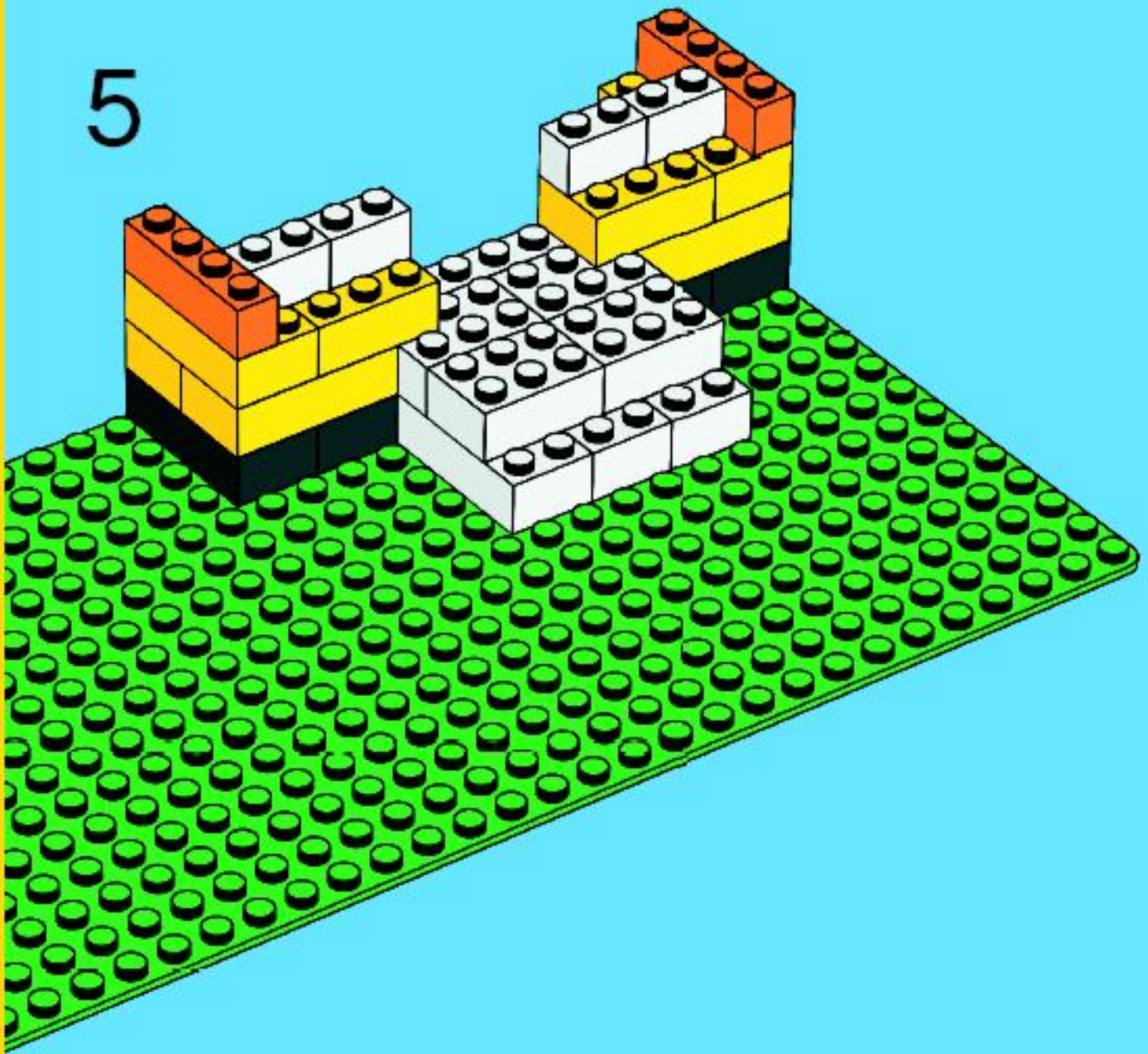

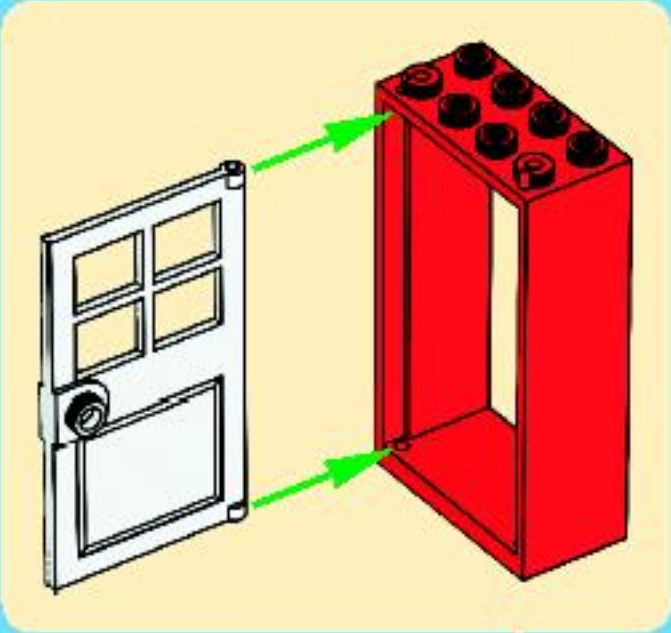

6

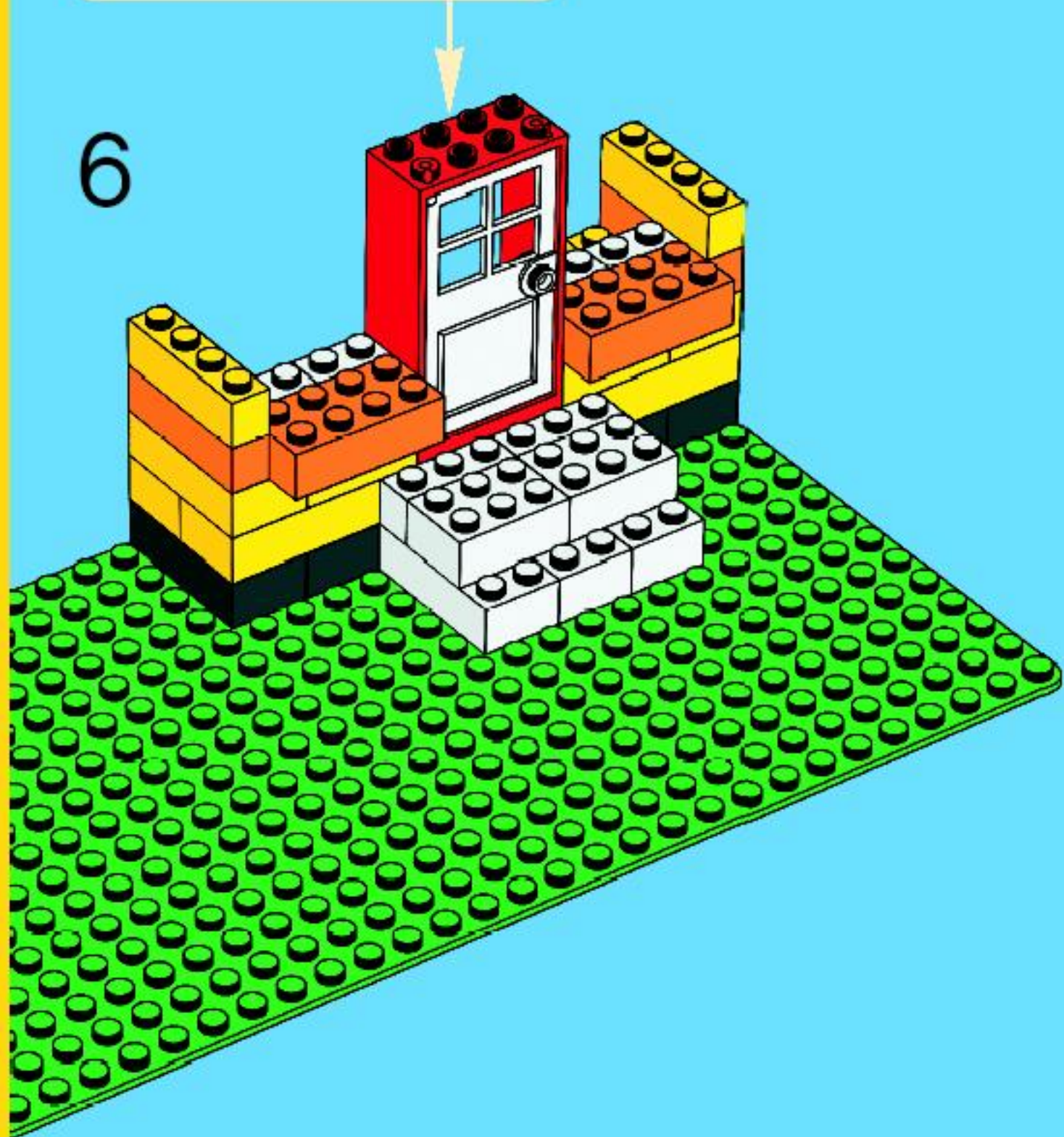

7

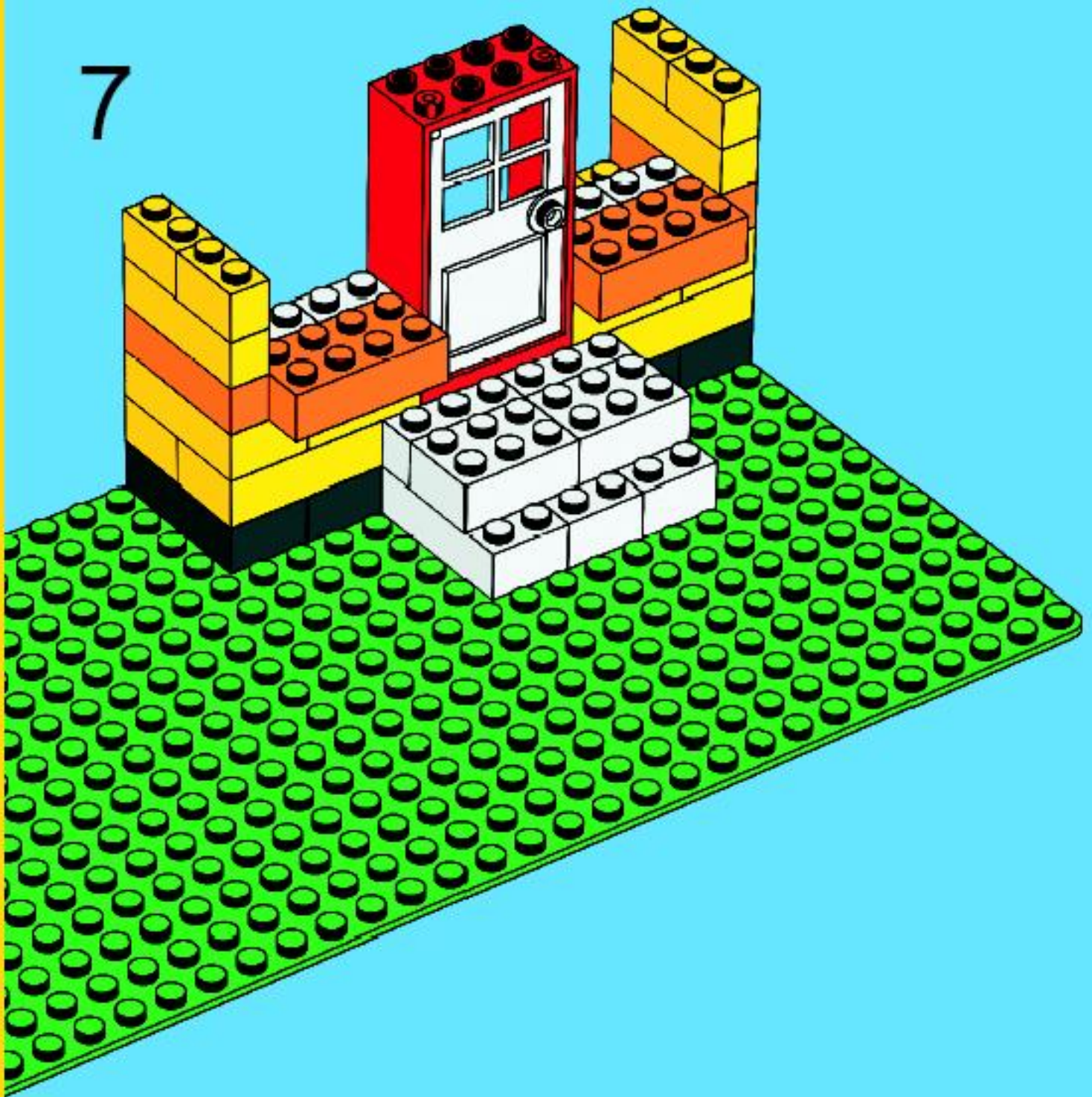

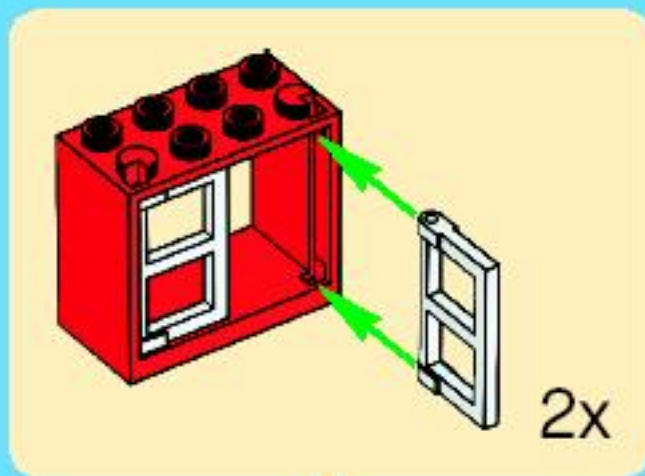

8

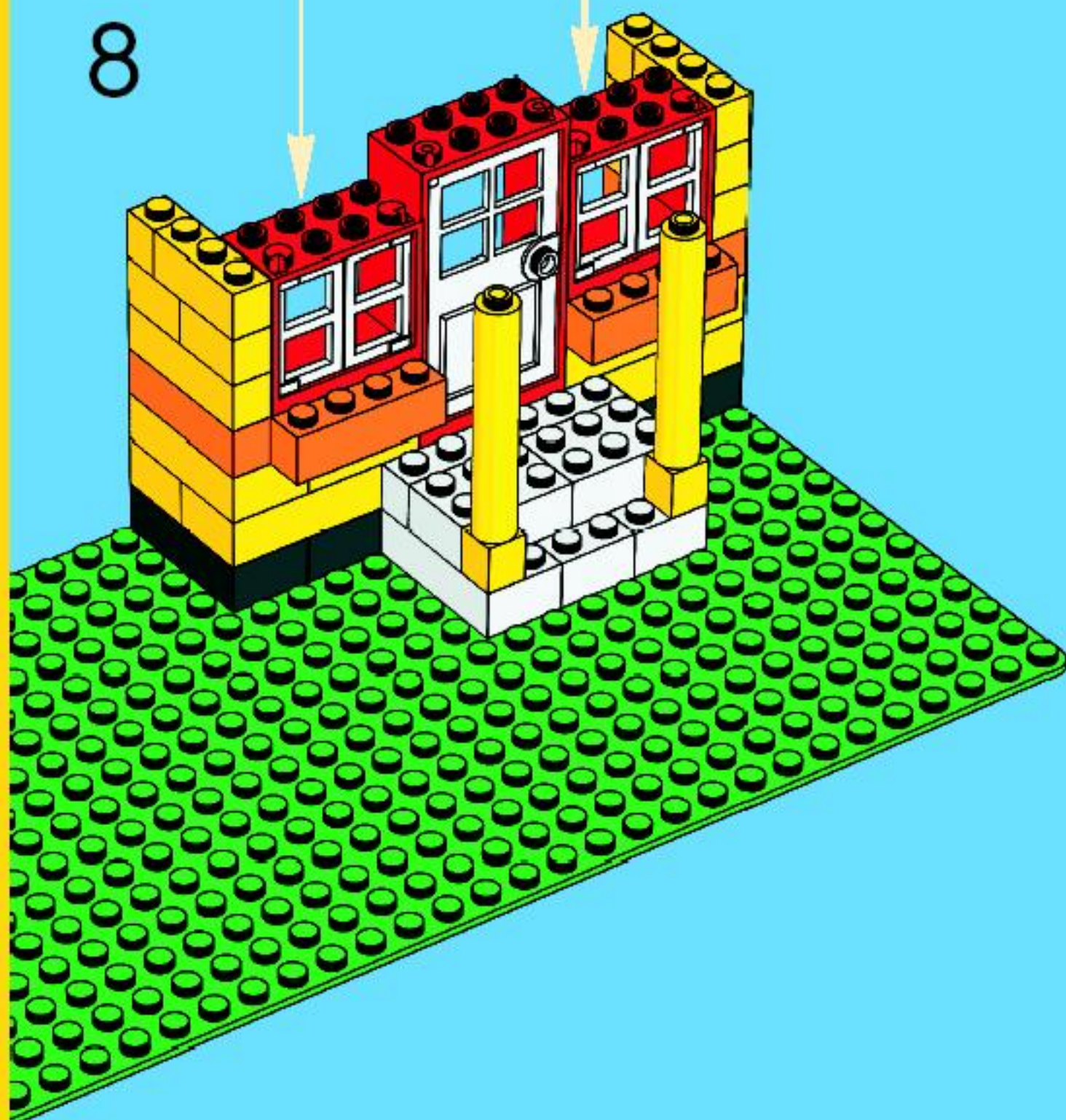

9

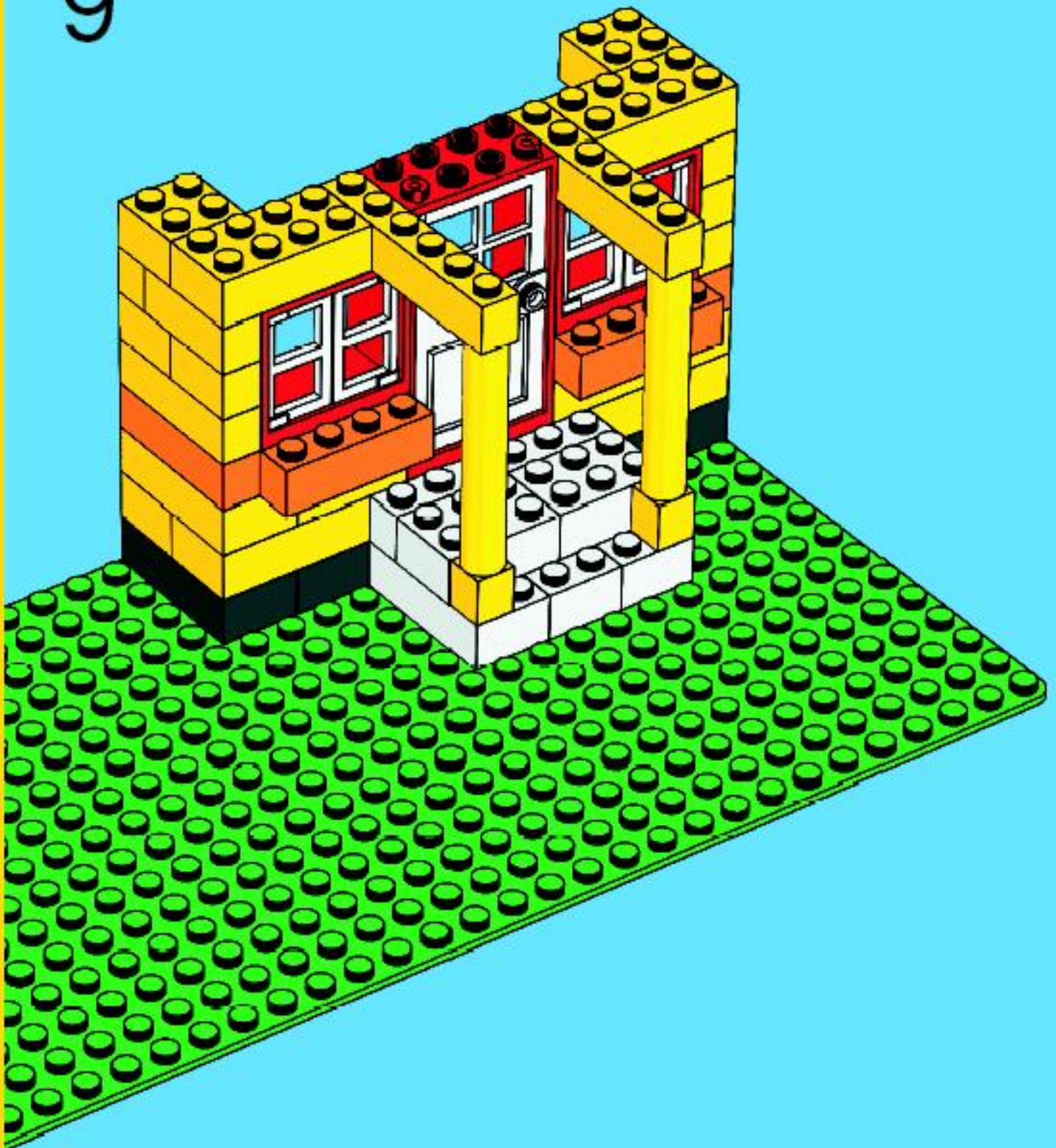

10

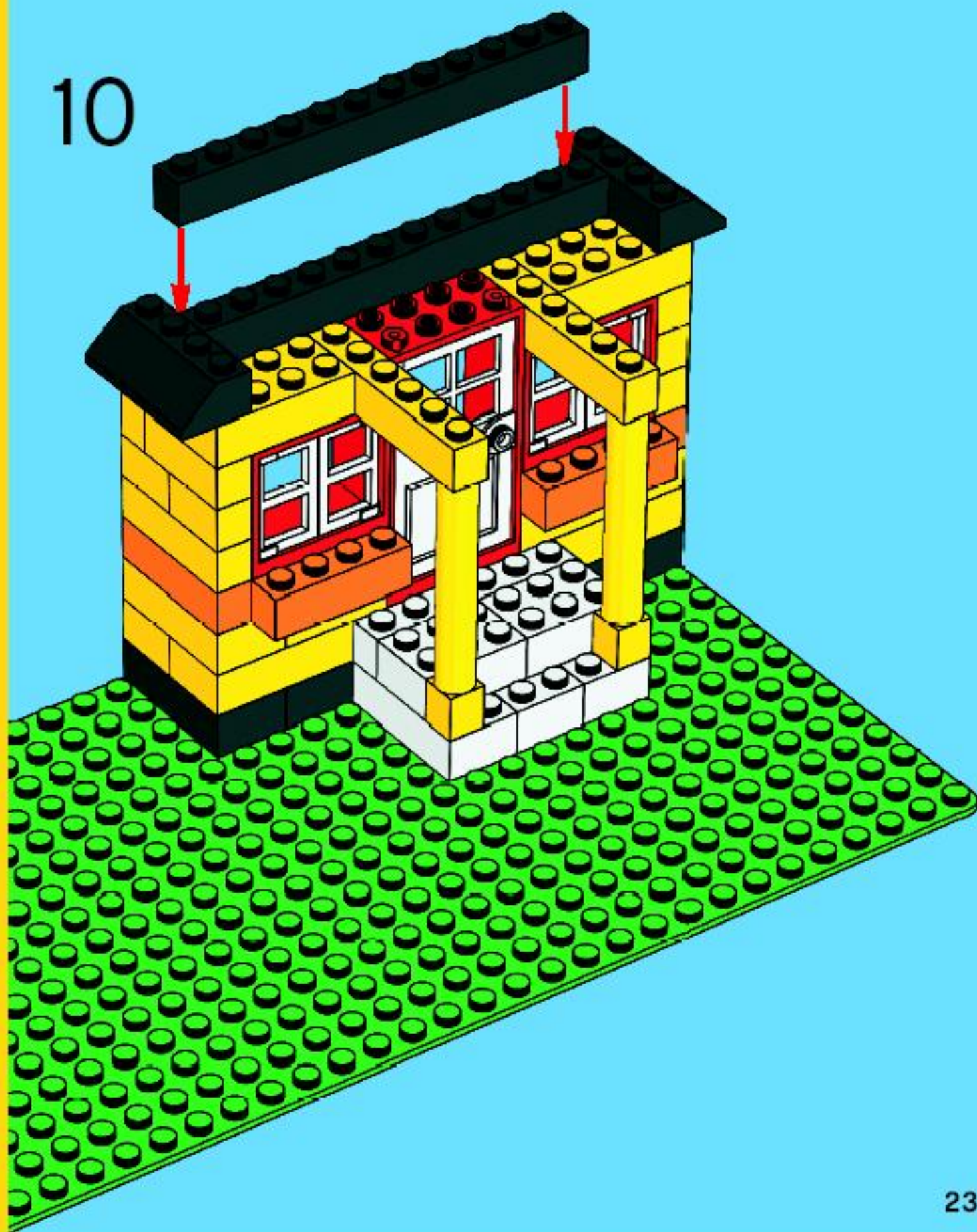

11

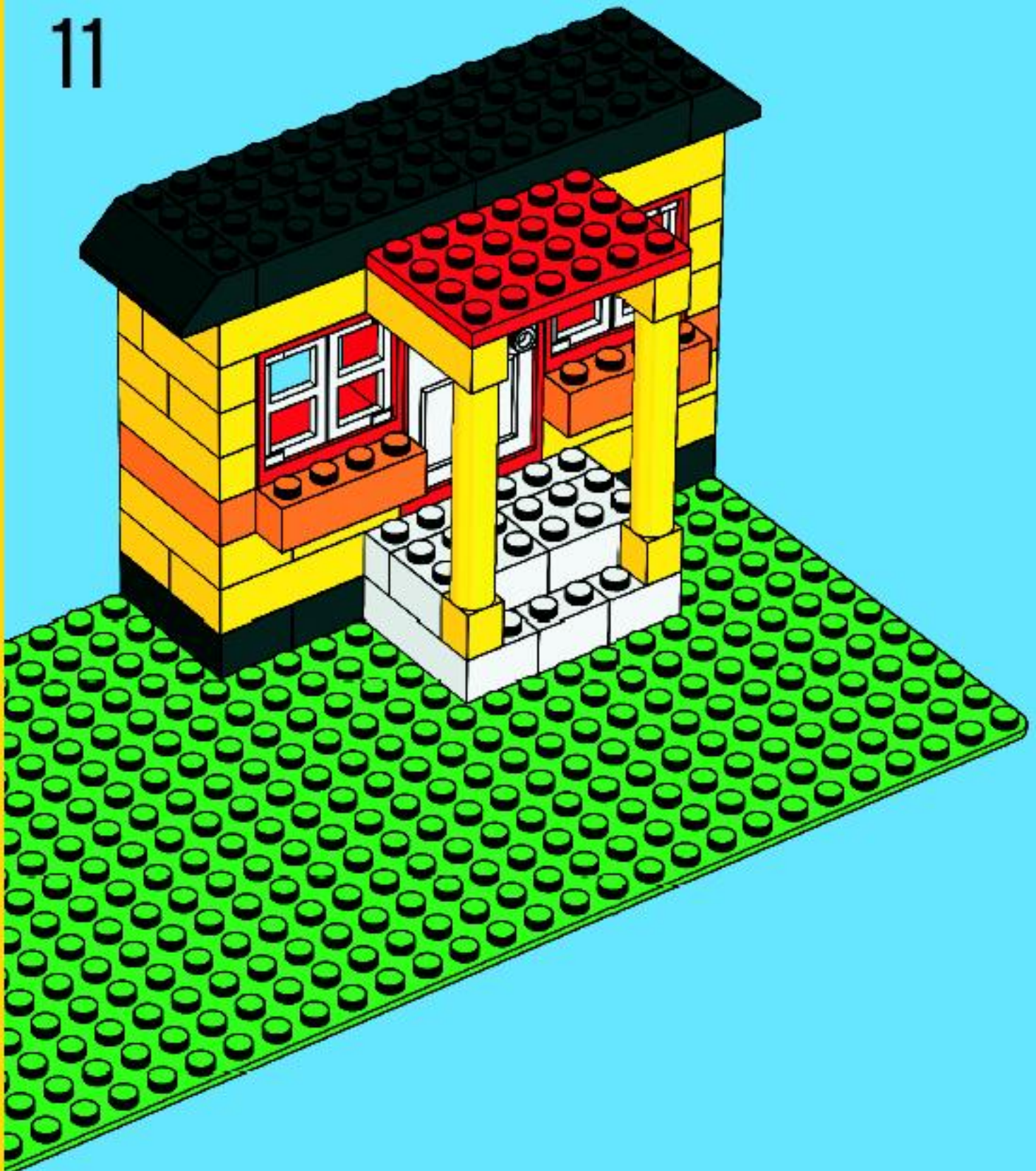



12

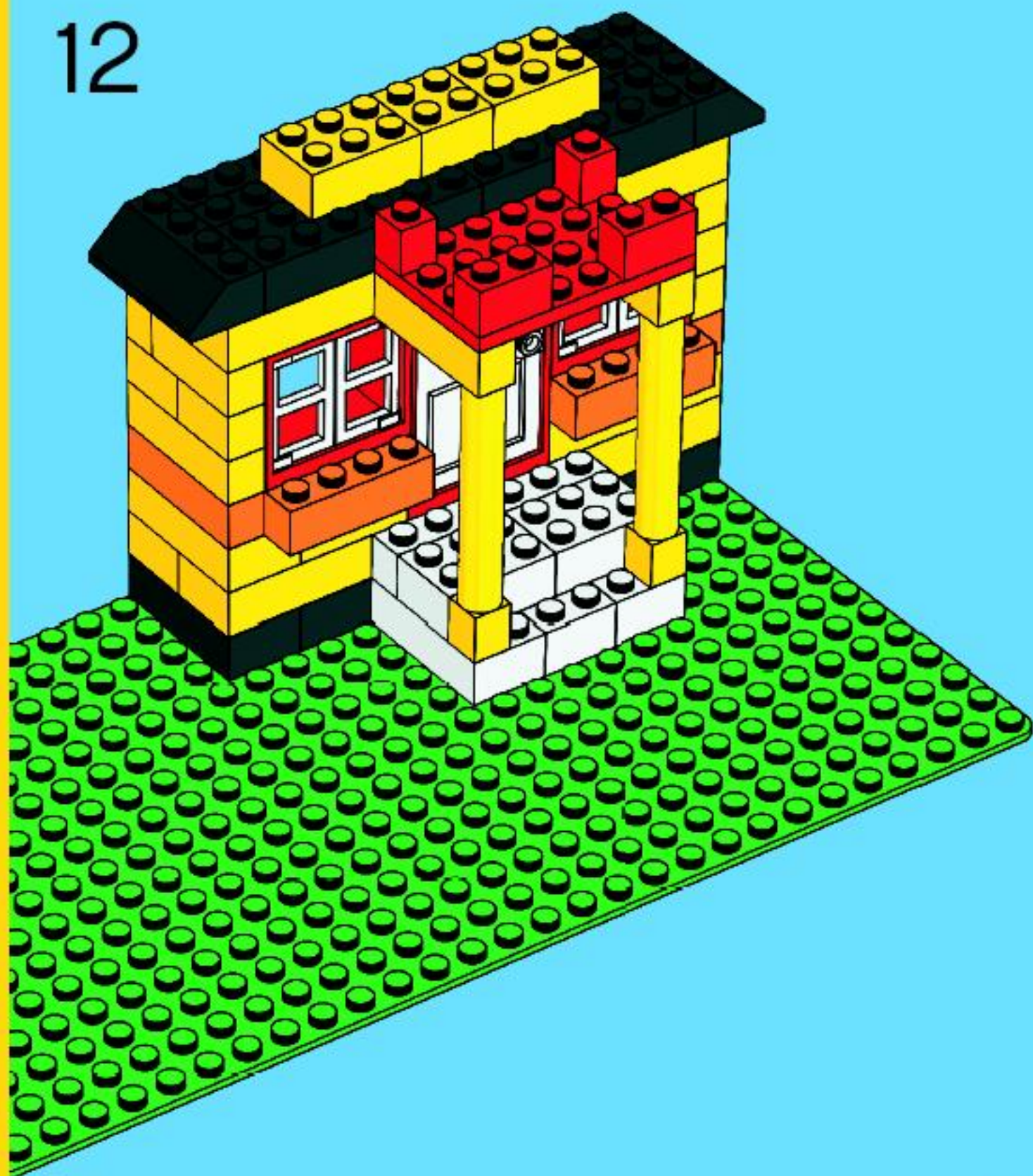

13

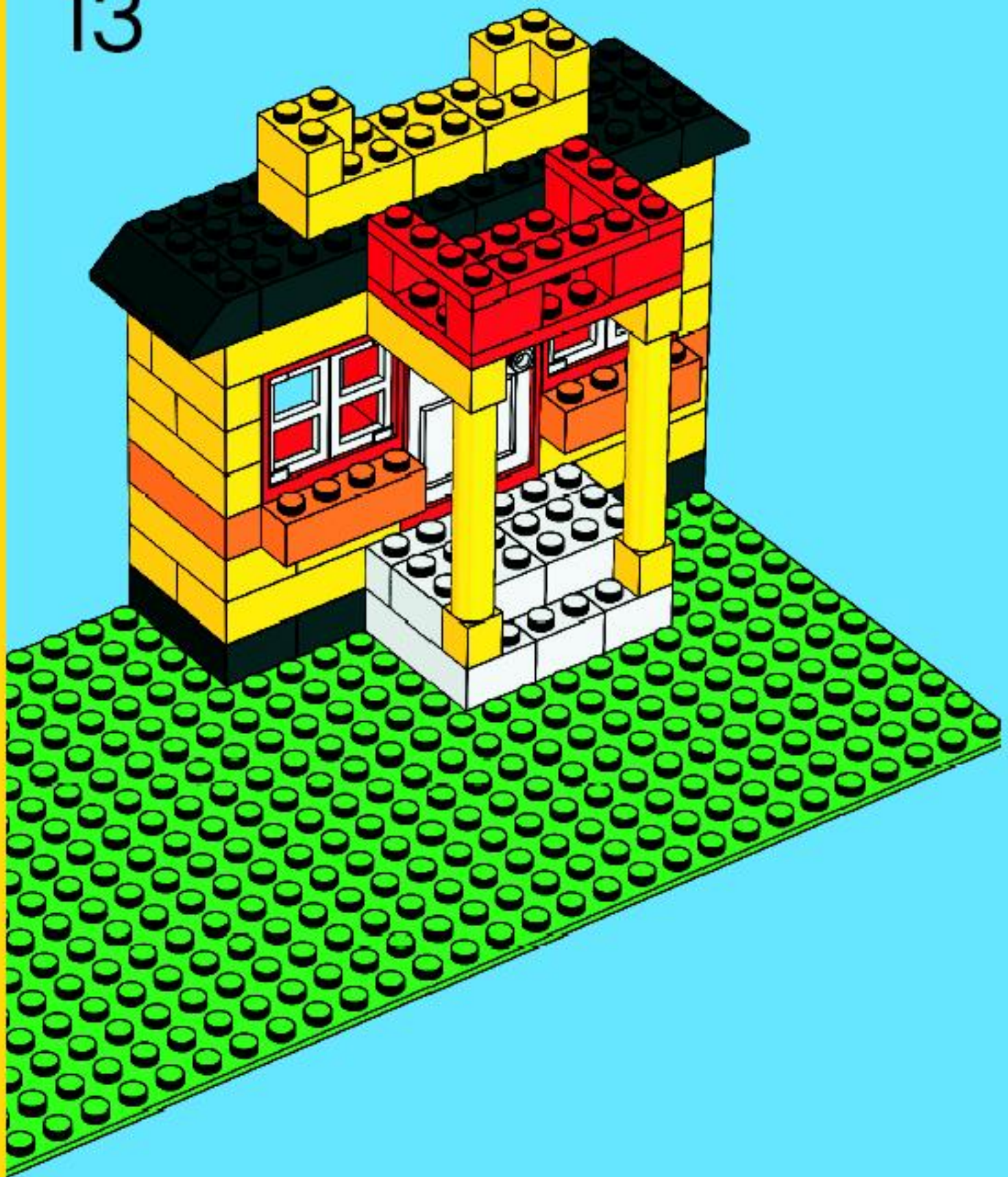

14

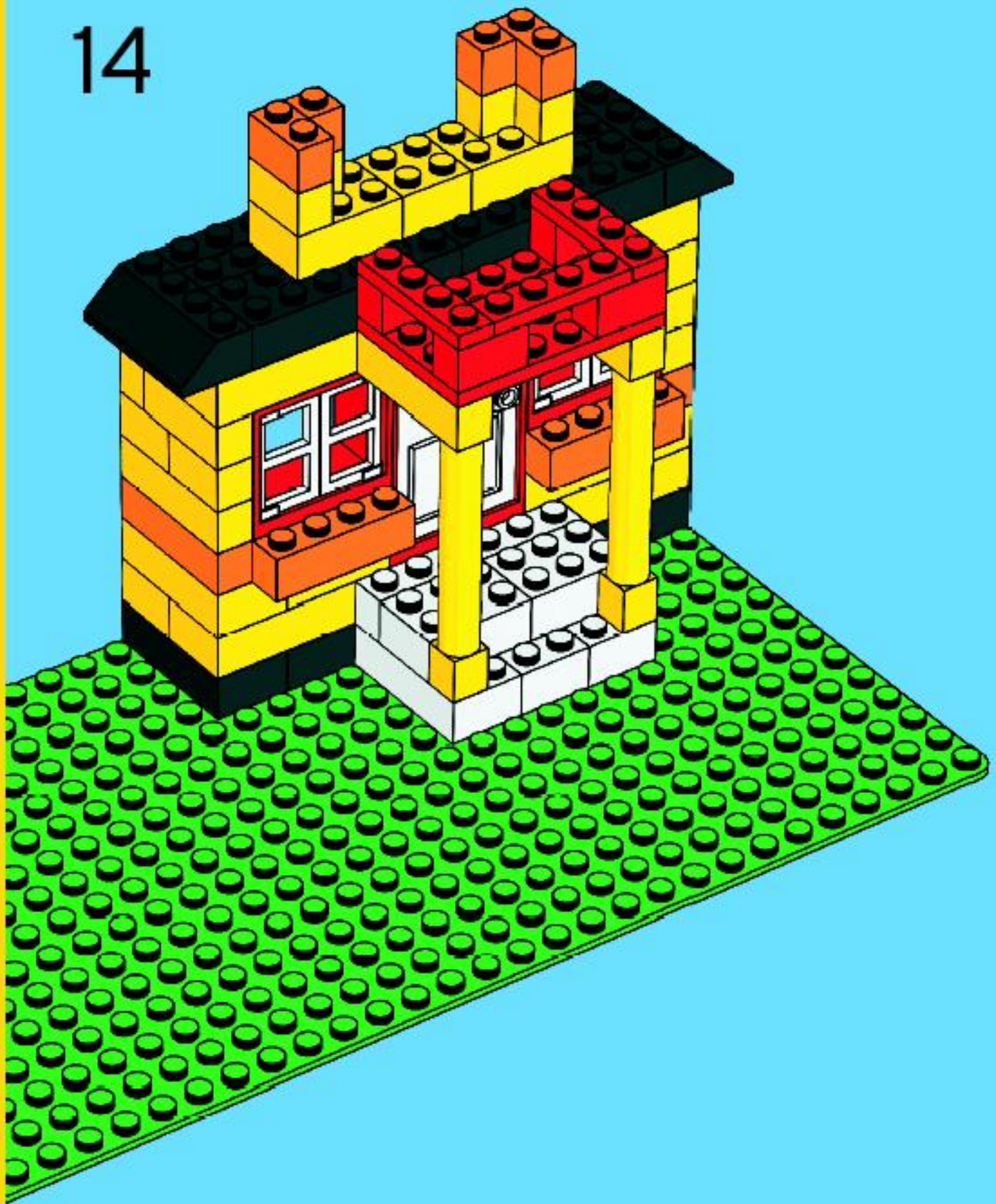

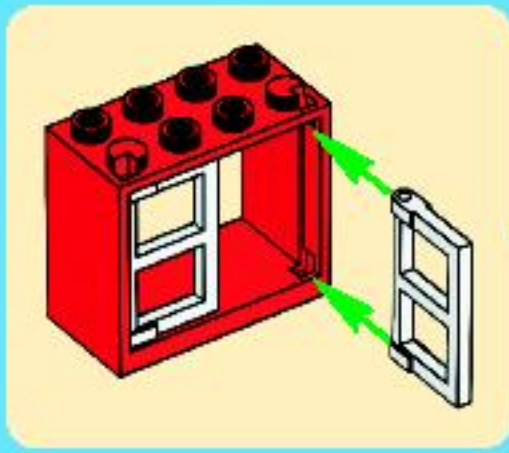

15



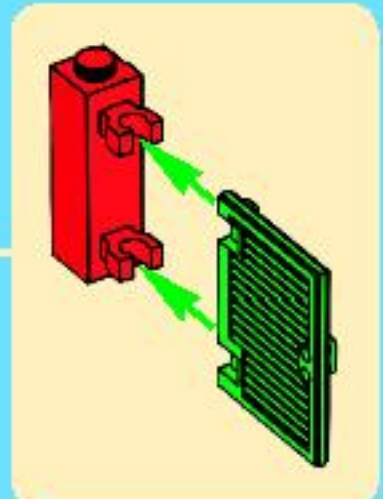
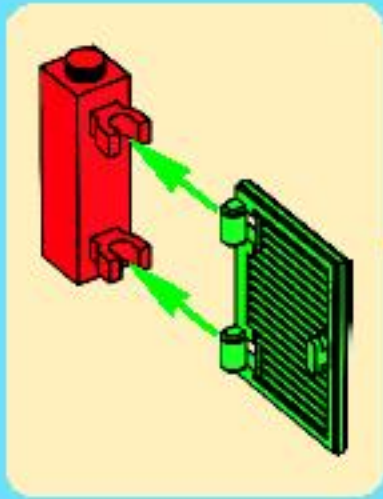

16



17



18



19





20

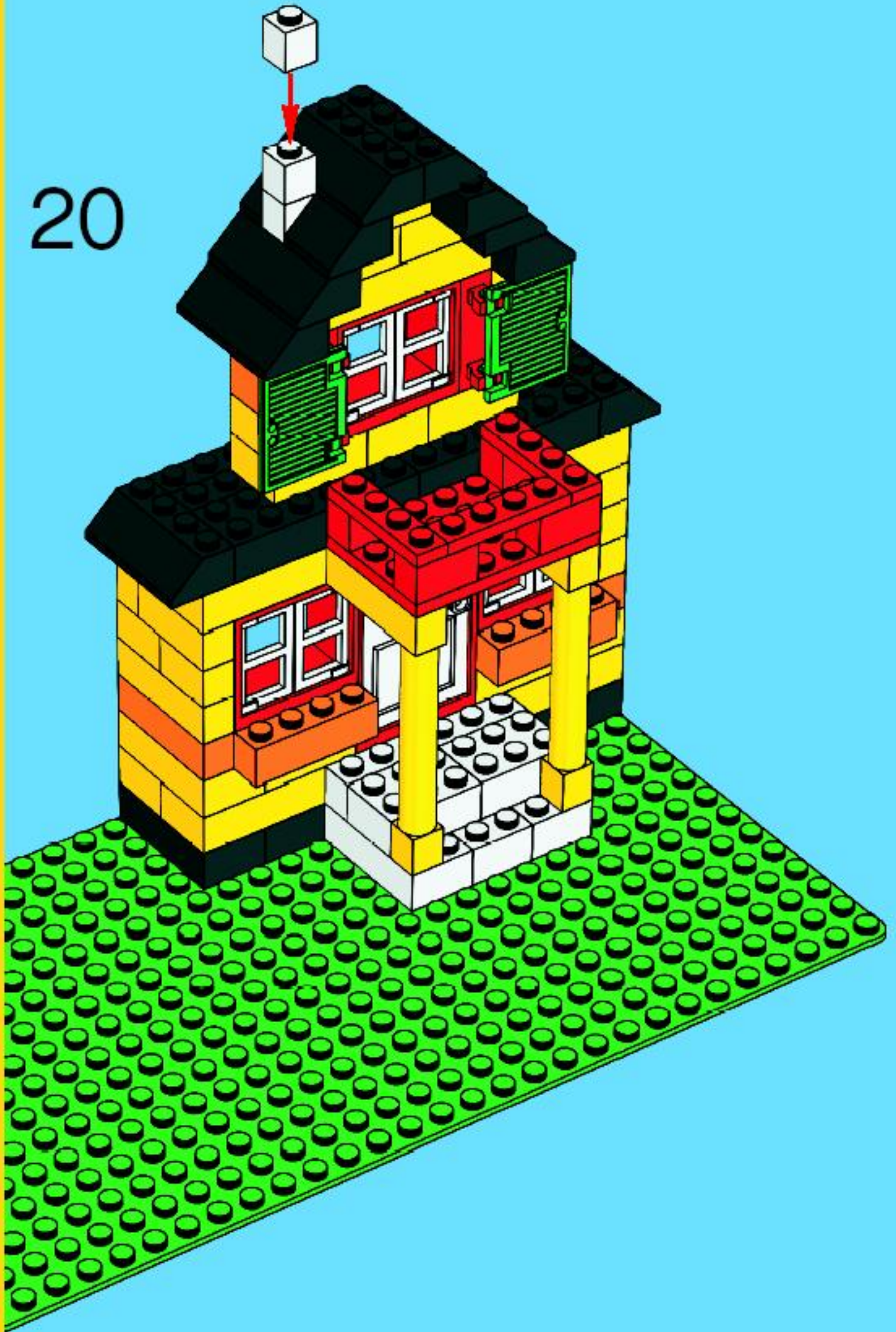







1

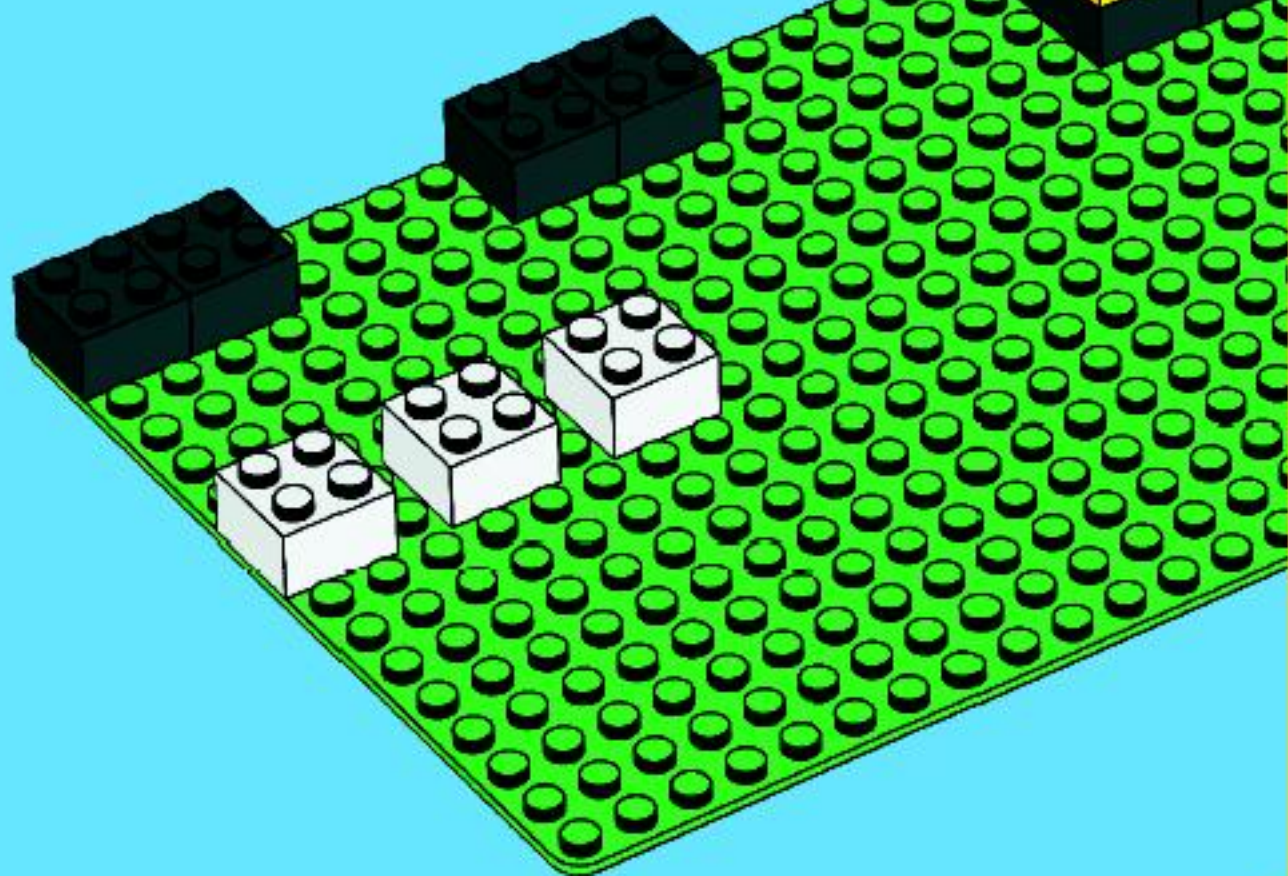

2

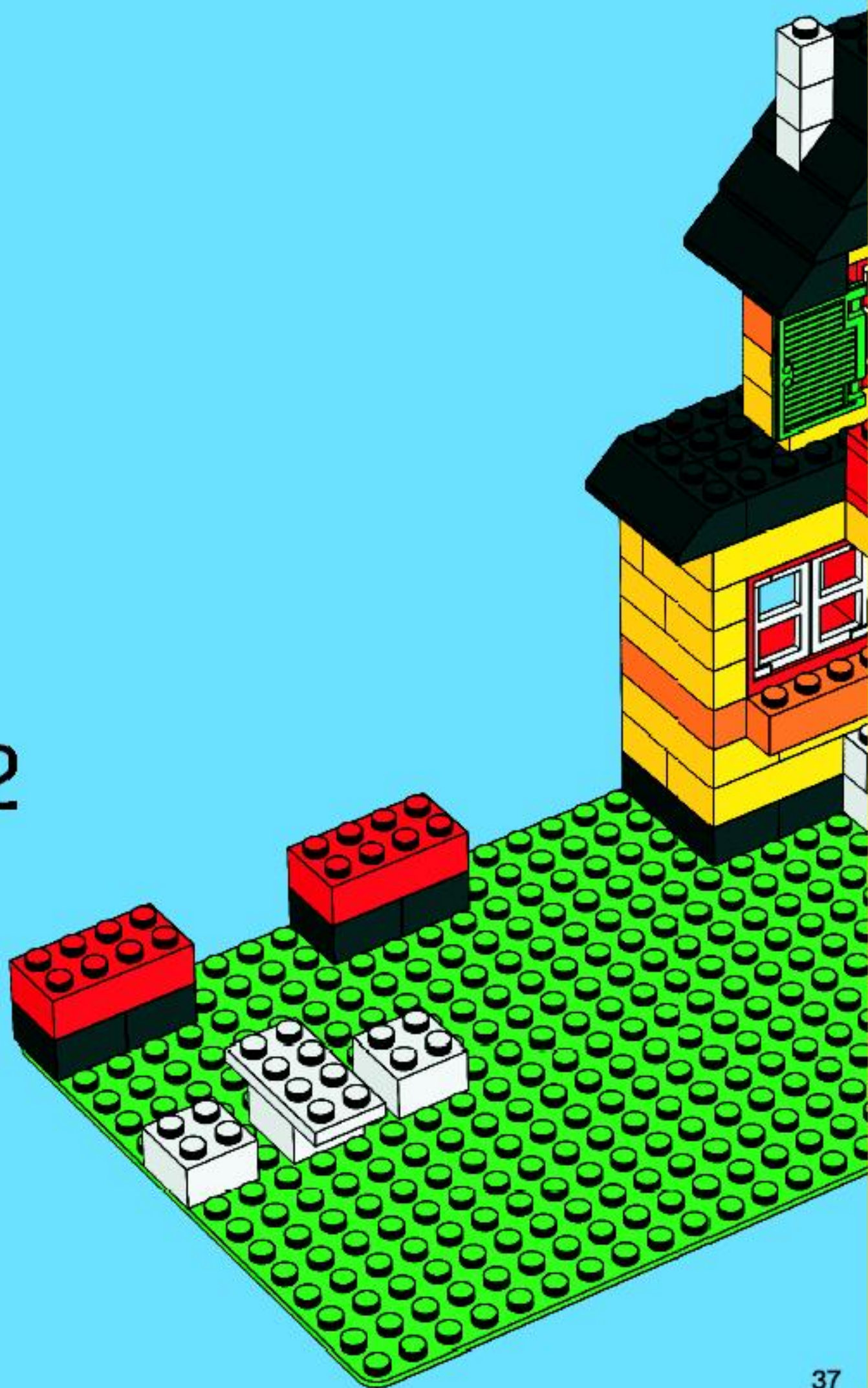

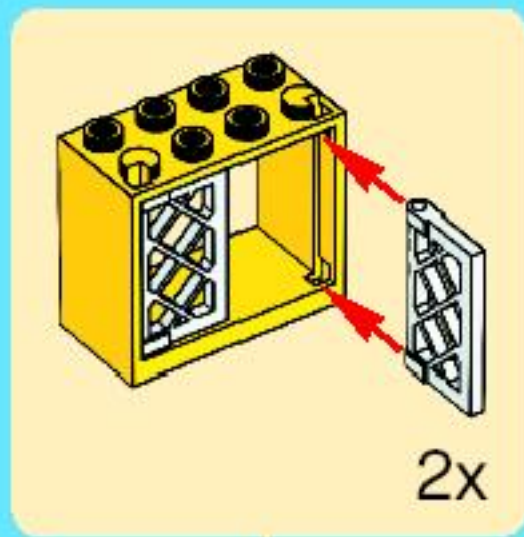

3



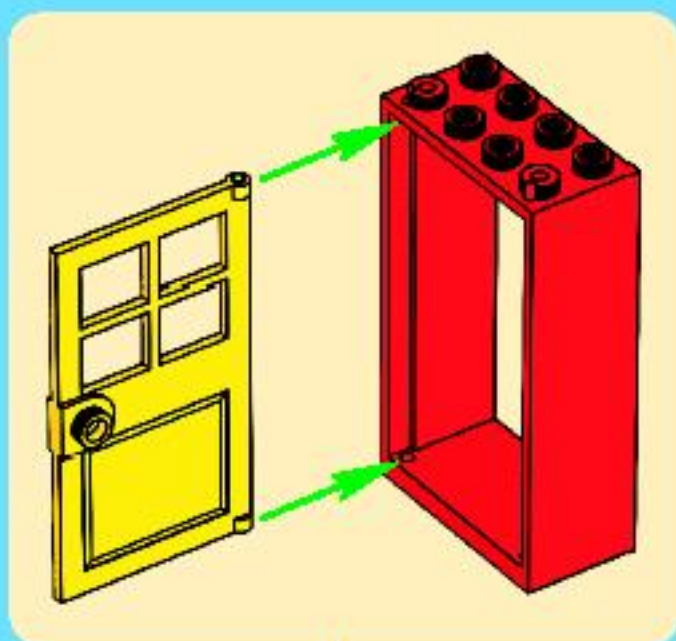

4



5

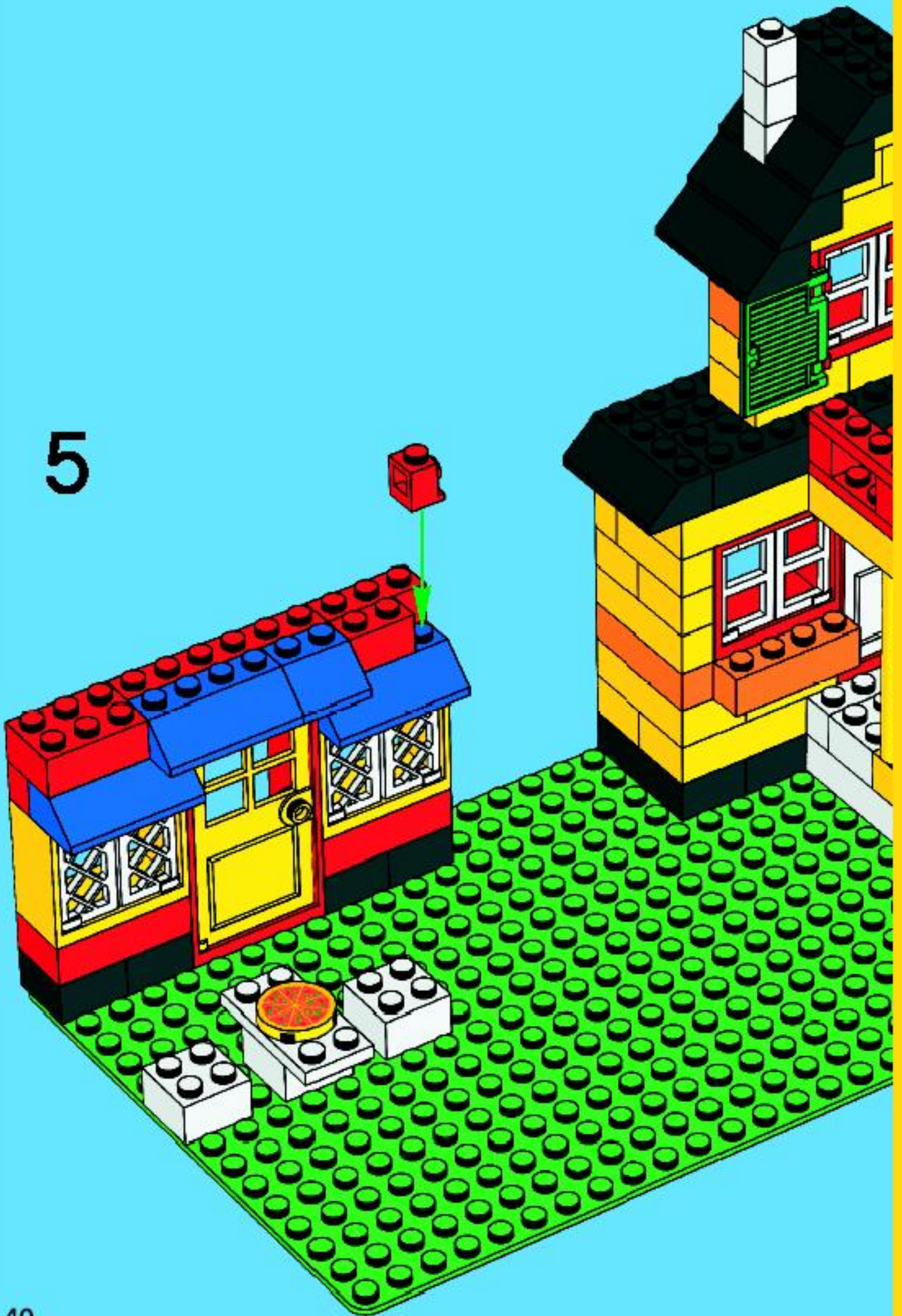



1



2



6

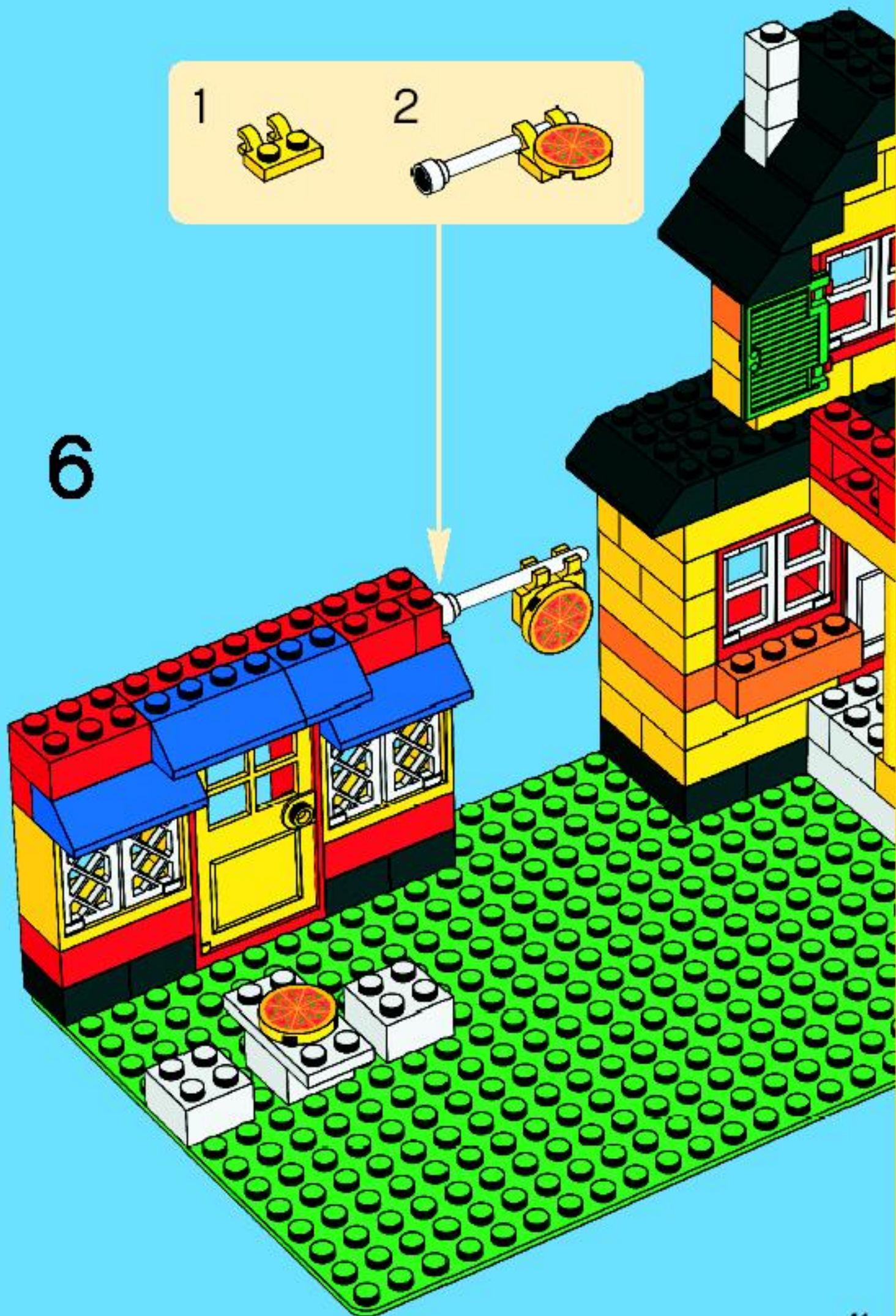

7



8



9



10



1



2



3



1



2



3



2x

1

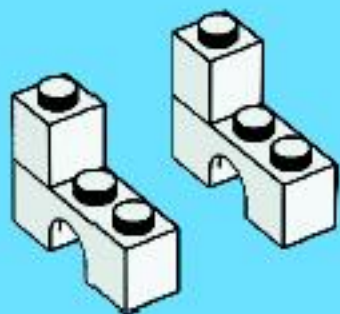

2

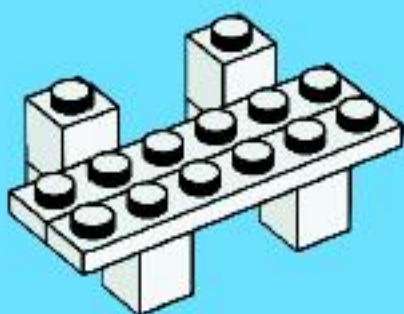

3

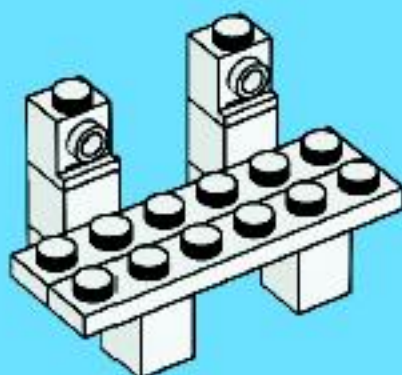

4

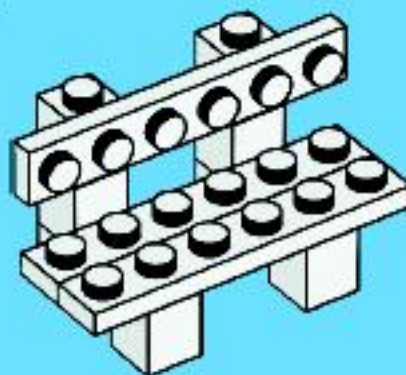







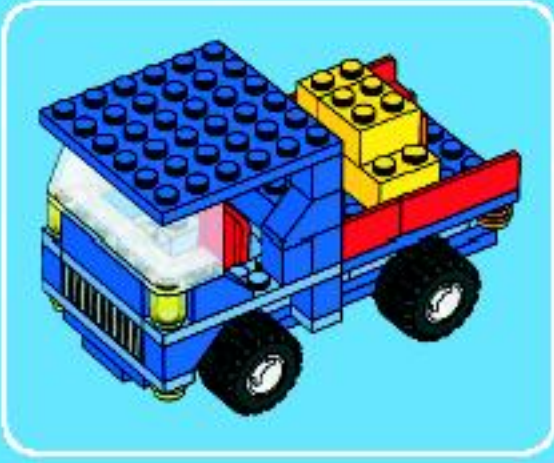

1

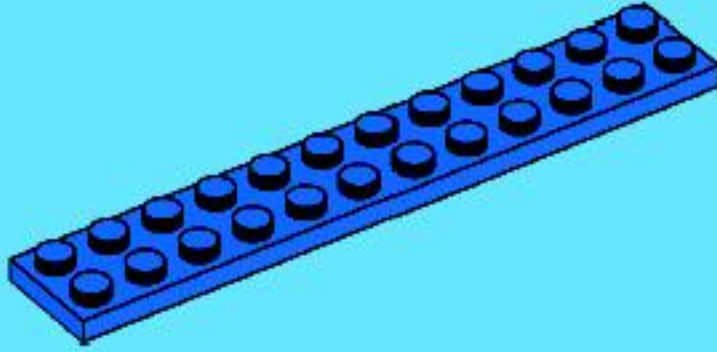

2

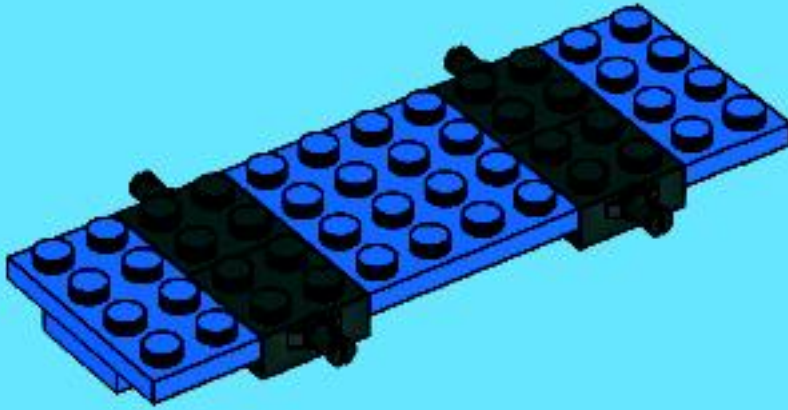

3

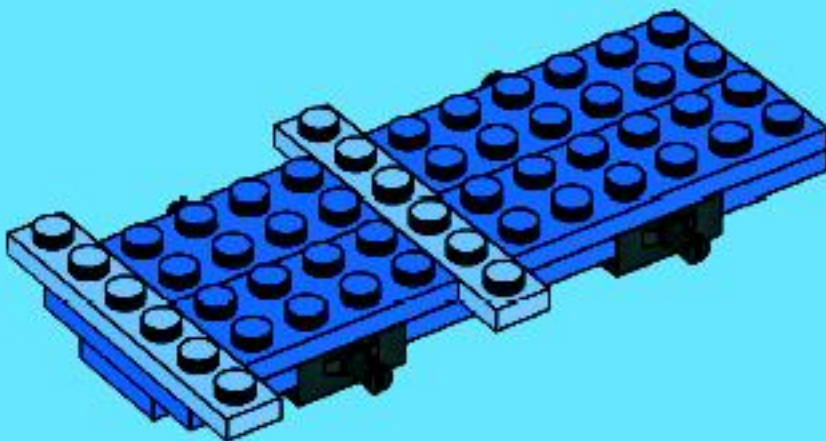

4

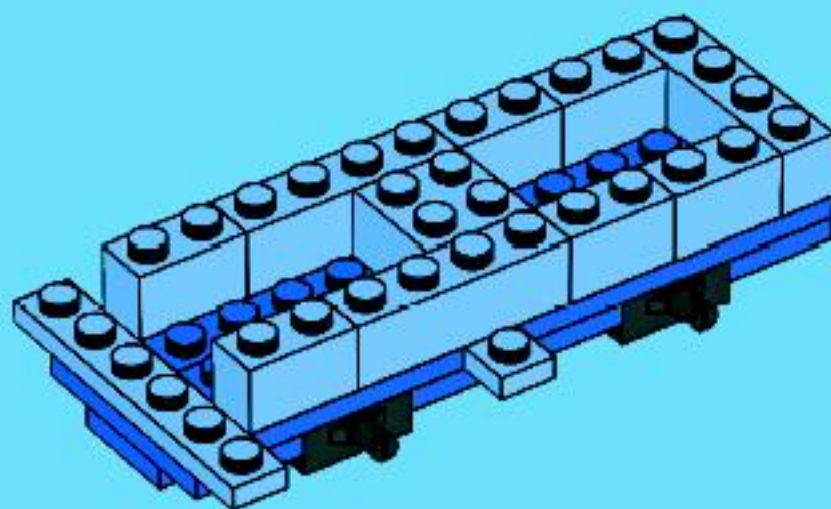

5

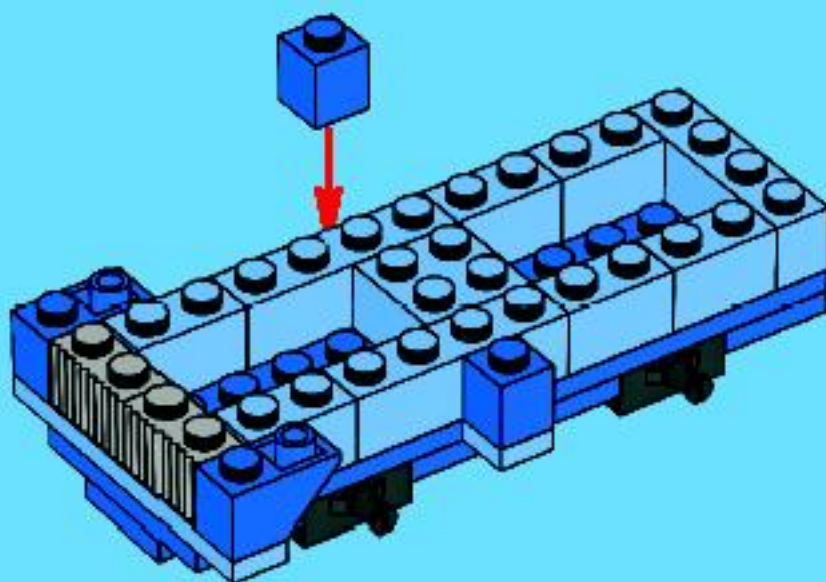

6

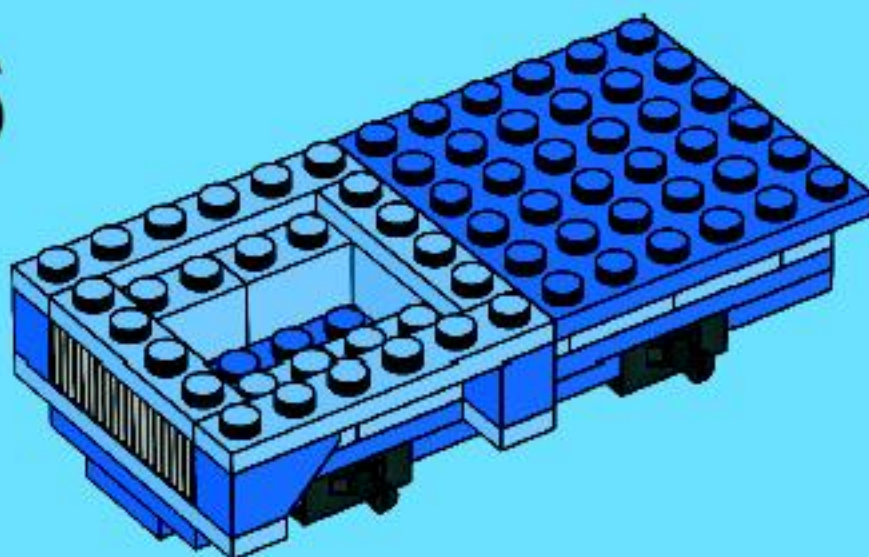

7

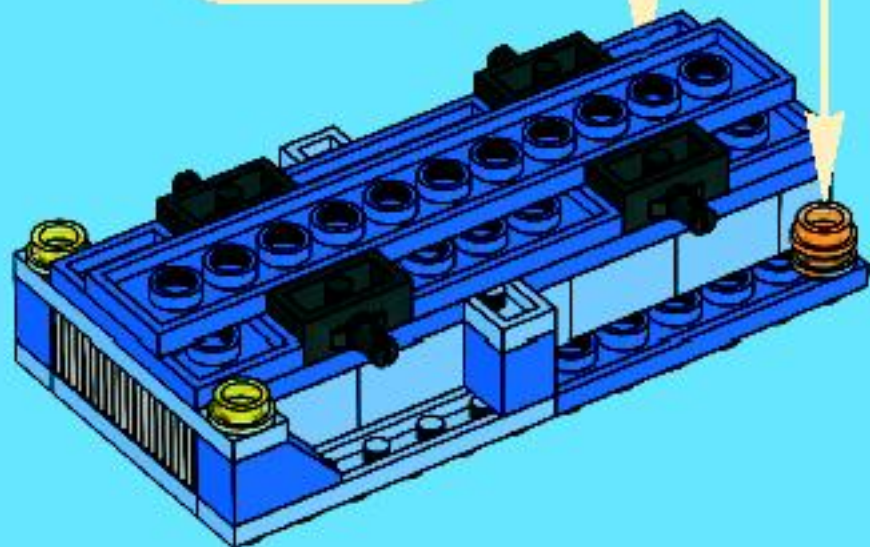

8

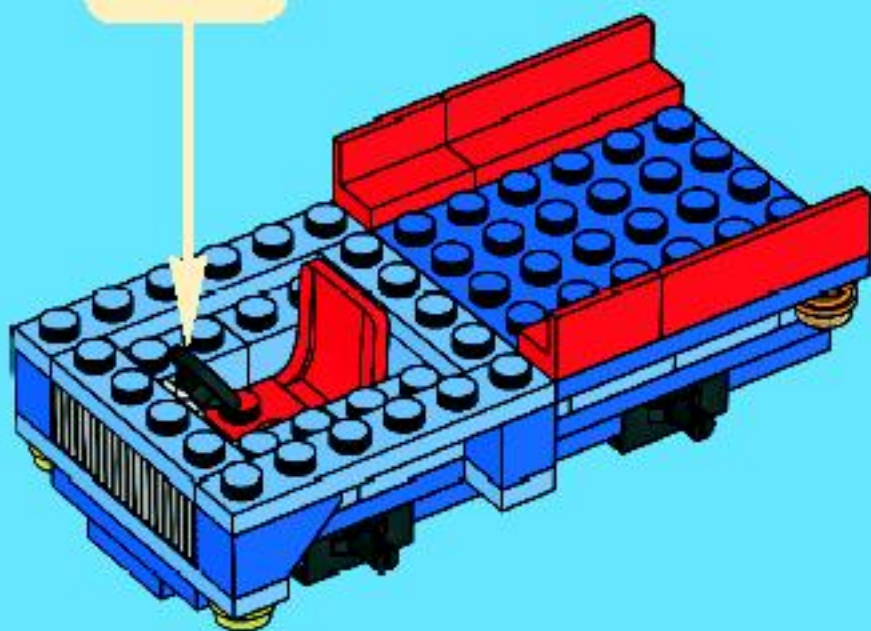

9

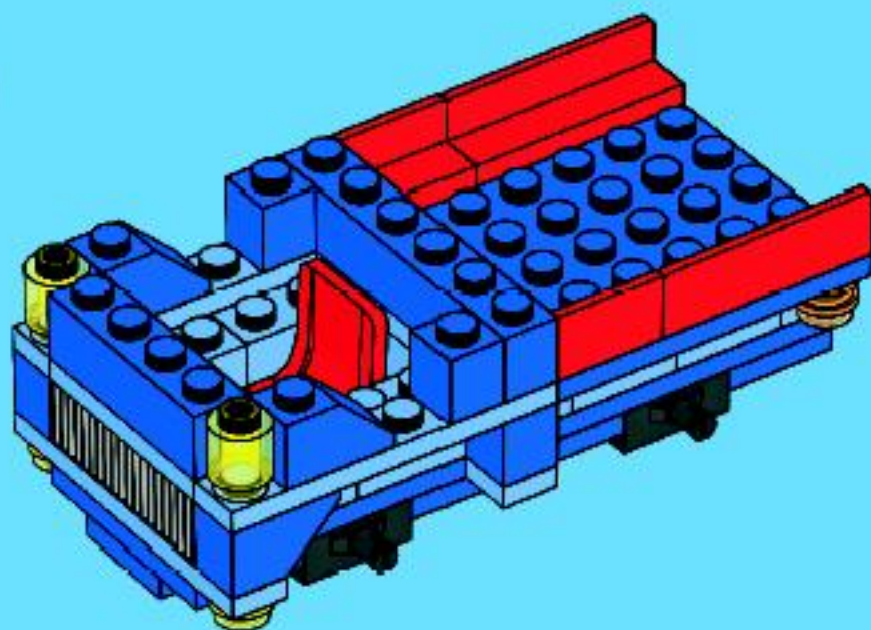

10

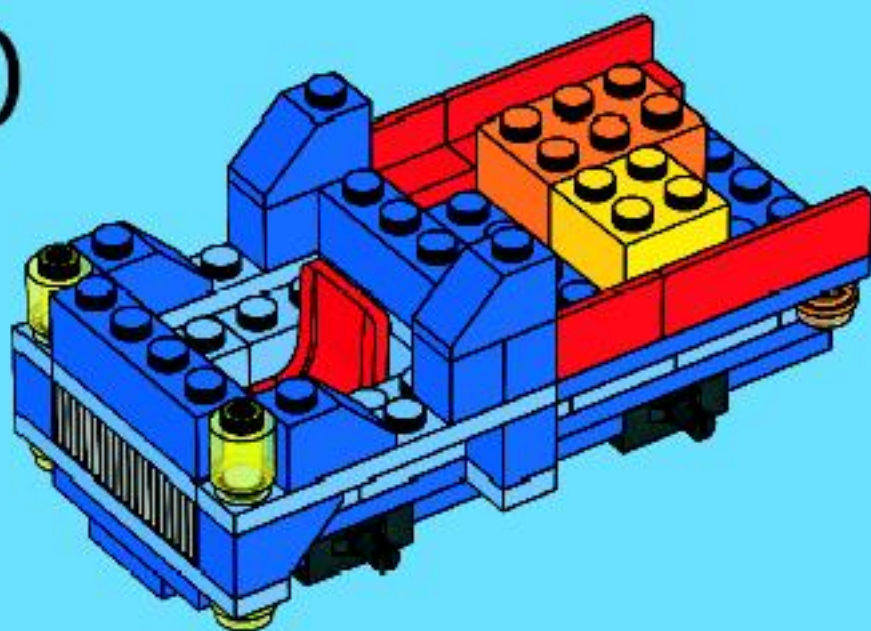

11

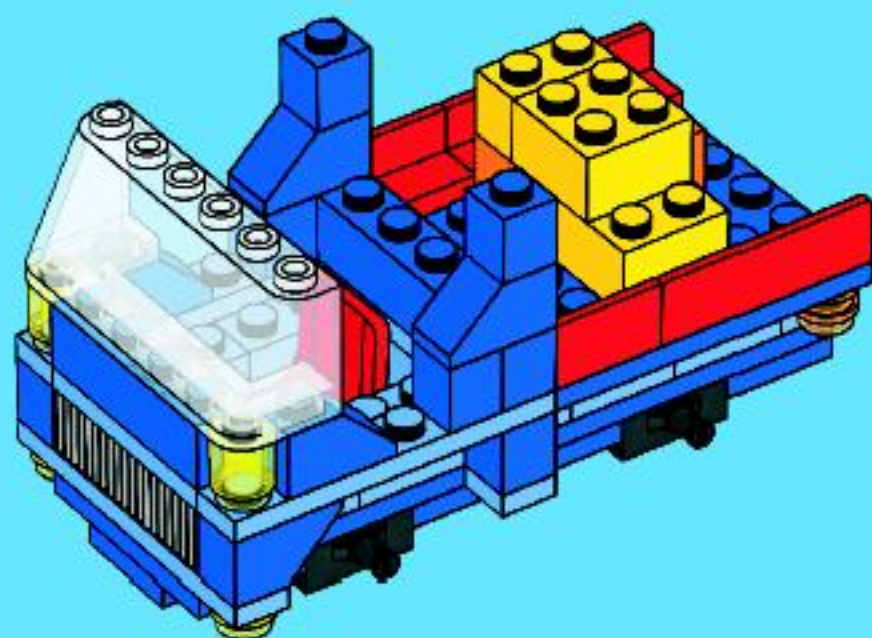

12

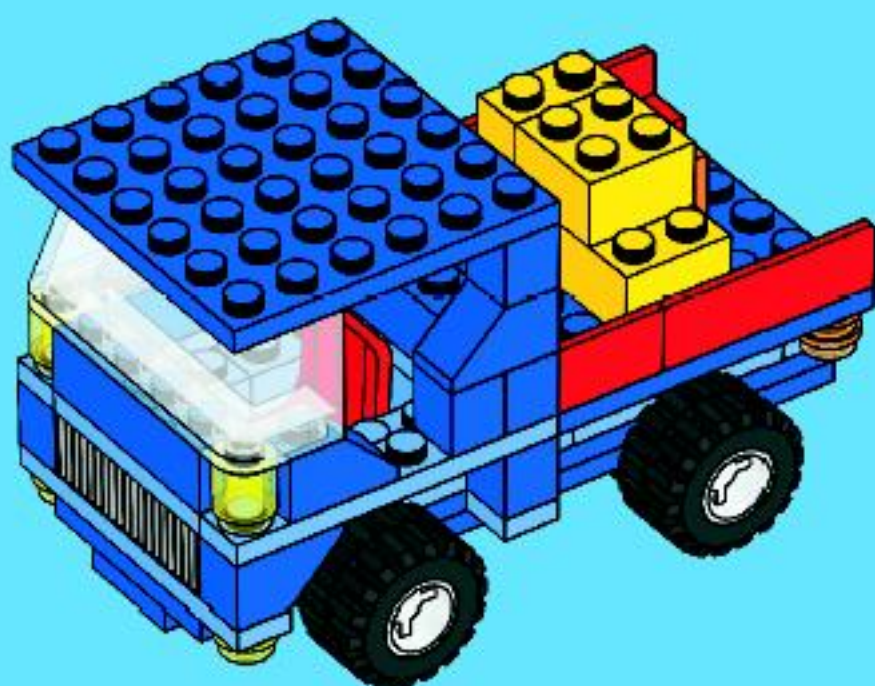









6177



6194



626



626

617



6116



6119



620

5898



5898



































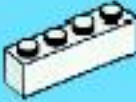



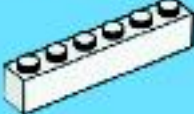







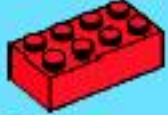



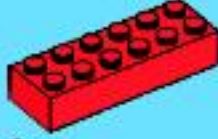





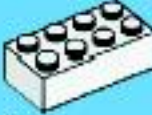
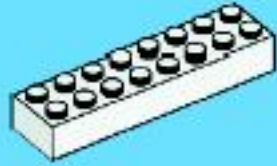

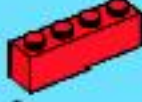





5660



5488



 2x 407001	 1x 4521943	 6x 614101	 4x 4173805	 1x 9342
 6x 300501	 4x 4521210	 2x 462301	 6x 4121739	 1x 4580475
 6x 4569080	 4x 4538968	 4x 462401	 2x 4118827	 2x 242021
 12x 300401	 4x 4504369	 4x 4170457	 6x 4153825	 2x 472821
 4x 362201	 6x 4520842	 4x 366501	 2x 4153826	 4x 235721
 3x 301001	 2x 302001	 2x 303901	 4x 4153827	 16x 300321
 4x 300901	 2x 395701	 4x 366001	 1x 4282742	 8x 300221
 16x 300301	 2x 4181142	 2x 4500469	 2x 407021	 6x 300121
 1x 4143137	 4x 366601	 2x 329701	 8x 300521	 2x 4181138
 6x 300201	 2x 300801	 2x 4580295	 4x 4563682	 1x 300721
 6x 300101	 1x 300701	 4x 4157103	 12x 300421	 3x 301021
 4x 4520970	 4x 4158355	 4x 4177932	 4x 362221	 4x 300921
 2x 9551	 2x 4121741	 4x 365921	 4x 303921	 2x 300821
 1x 4570026	 1x 303401	 1x 4121741		



2x  
407921



2x  
486521



2x  
4171662



3x  
4528164

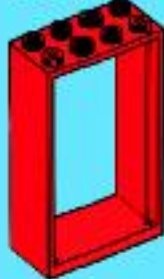

2x  
4528139



6x  
371021



2x  
302021



3x  
379521



1x  
303221



2x  
472823



1x  
317623



4x  
302323



4x  
371023



8x  
300523



12x  
300423



4x  
362223



3x  
301023



4x  
300923



6x  
300123

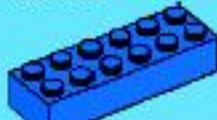

2x  
4181139



8x  
300223



16x  
300323



1x  
9341



4x  
4121936



2x  
303923



3x  
4107437



4x  
242023



2x  
366523



4x  
302223



2x  
302123



8x  
302023



2x  
379523



1x  
4243815



2x  
4199519



1x  
303523

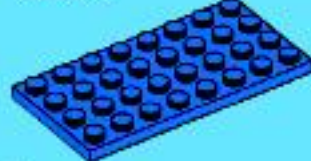

2x  
346023



2x  
300723

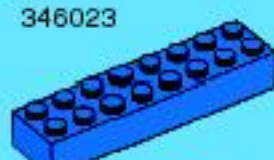

1x  
300723



2x  
300823



1x  
244523



1x  
4261269



1x  
9336



8x  
300524



12x  
300424



4x  
362224

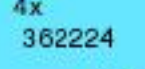

3x  
301024



4x  
300924



2x  
300824

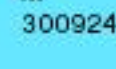

16x  
300324



8x  
300224



6x  
300124



2x  
4181143



1x  
300724



2x  
302324



1x  
4556156



2x  
4501109



4x  
4504381



2x  
303924



2x  
81867

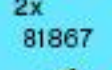

4x  
235724

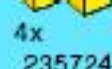

1x  
4569077



2x  
4180814



1x  
4528550



2x  
4520844



1x  
4502193



3x  
382340



4x  
3005748



4x  
3005741



4x  
4222960



2x  
3006844



4x  
3005744



4x  
300526



6x  
300426



4x  
362226



2x  
301026

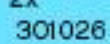

8x  
300326

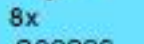

4x  
300226



3x  
300126



2x  
4181144



4x  
448826



2x  
379426



1x  
4515340



1x  
4144575



1x  
4515122



2x  
4121966



7x  
303926



16x  
303726

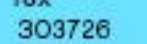

1x  
247926



4x  
4501046



4x  
4508215



4x  
4514560



2x  
292626



2x  
611226



2x  
4143562



4x  
300528



6x  
4107736



4x  
4109679



2x  
4112838



8x  
300328



4x  
4109674



3x  
4106356



4x  
4552353



1x  
347028



1x  
4116671



1x  
600728



1x  
4219648



4x  
4220634



6x  
4164022



6x  
4220632



2x  
4220631



2x  
4165967



2x  
4211504



2x  
4211383



2x  
4211350



4x  
4211765



1x  
4116671



1x  
600728



1x  
4116671



1x  
600728



1x  
4116671



1x  
600728



1x  
4116671



1x  
600728



1x  
4116671



1x  
600728



1x  
4529755



4x  
4179830



6x  
4179833



3x  
4163696



6x  
4201235



2x  
4205058



2x  
4179828



4x  
4179829



4x  
4179829



4x  
4179829



4x  
4179829



4x  
4179829



4x  
4179829



4x  
4179829



4x  
4179829



4x  
4179829



4x  
4179829



4x  
4179829



4x  
4179829



Customer Service

Kundenservice

Service Consommateurs

Servicio Al Consumidor

www.lego.com/service or dial



: 00800 5346 5555

: 1-800-422-5346

**FREE! GRATIS! GRATUIT!**



**club**  
MAGAZINE™

**www.LEGOclub.com**



**00800 5346 5555\***



**1-866-534-6258 • 1-877-518-5346**

US & Canada only

Canada seulement

\* FreePhone. Mobile charges may apply. \* Numéro sans frais. Les Frais peuvent s'appliquer avec les téléphones cellulaires.  
\* Gebührenfrei. Nur bei Festnetz oder Mobilfunknetzen können abgerufen. \* Gratis telefonnummer van vaste lijn.  
\* Kísérletkísérlet ingyenes szám, de díjat lehet kell fizetni. \* Det är gratis, när du ringer från en fasttelefon.



VISIT THE WORLD'S  
BIGGEST LEGO® SHOP!

**www.LEGOshop.com**



**YES! I want to join the LEGO Club FREE! OUI! Je veux m'abonner au Club LEGO GRATUITEMENT!**

**Ja! Ich möchte Mitglied im kostenlosen LEGO Club werden. Ja! Ik wil graag GRATIS lid worden van de LEGO Club.**

**Ja! Jeg ønsker å melde meg inn i LEGO Club gratis! Ja! Jag vill gå med i LEGO Club GRATIS!**

First name - Prénom  
Vorname - Voornaam  
Fornavn - Förnamn

Last name - Nom de Famille  
Name - Achternaam  
Etternavn - Efternavn

Date of Birth - Date de naissance  
Geburtsdag - Geboortedatum  
Fødselsdato - Födelsedatum

Boy - Garçon  
Junge - Jongen  
Gutt - Pojke

Girl - Fille  
Mädchen - Meisje  
Jente - Flicka

Street - Adresse  
Straße, Hausnr.  
Straat, hûsnr. - Adress

City - Ville  
Ort - Woonplaats  
Poststed - Postort

State  
Prov.  
County

Zip/Postcode - Code Postal  
PLZ - Postcode - Postnummer

Country  
Pays - Land

Please tick below if you would like to receive other communication from the LEGO Group. Si vous aimeriez recevoir d'autres communications de la part de la Compagnie LEGO, veuillez sv.p. cocher ici. Als u graag andere informatie van de LEGO Groep wilt ontvangen, kruis dan a.u.b. dit vakje aan. Ich möchte über Produkte, Angebote, Aktionen und weitere interessante Themen von der LEGO Gruppe informiert werden\* (bitte ankreuzen). Om du vil få annen informasjon fra LEGO Gruppen, slått kryss her. Hvis du ønsker å motta annen informasjon fra LEGO Gruppen, merker du av her.

Post - Poste  
Per Post

Email - Courriel  
Per E-Mail  
E-Mail

Ich möchte über Produkte, Angebote, Aktionen und weitere interessante Themen von sonstigen LEGO Partnerunternehmen informiert werden\* (bitte ankreuzen).  Per Post  Per E-Mail

The English language version of the magazine can only be mailed to addresses in the US, Canada, the UK, and Republic of Ireland. Club membership is valid for two years and includes free copies of the LEGO Club Magazine. In the US and Canada please allow up to 6 weeks for delivery of your first magazine. In the UK and Republic of Ireland please allow six to 14 weeks for delivery of your first magazine. By signing this form you consent the LEGO Club to use your child's data for LEGO mailings. The data will only be used for LEGO mailings and will not be sold, rented or otherwise disclosed to any company outside the LEGO Company except for disclosure to companies acting as our agents to help us provide services requested by the child. This coupon is valid for one free membership per person, group or organisation. Photocopied coupons are accepted. La version française du magazine peut être postée uniquement au Canada. L'abonnement est valide pour 2 ans et inclut des exemplaires gratuits du Magazine LEGO. Aux E-U. et au Canada, allouer 6 semaines pour la livraison initiale. En remplissant ce formulaire, vous consentez à ce que LEGO utilise les informations de votre enfant pour des envois postaux de LEGO. L'information sera utilisée uniquement pour des envois postaux par LEGO et ne sera en aucun cas, vendue, louée, échangée ou divulguée à d'autres compagnies autres que la compagnie LEGO, à l'exception des compagnies affiliées qui nous procurent des services auxquels l'enfant en a fait la demande. Das deutschsprachige LEGO Club Magazin kann nur an Adressen in Deutschland, Österreich und der Schweiz verschickt werden. Die kostenlose Mitgliedschaft beinhaltet die Zusendung des LEGO Club Magazins und endet nach zwei Jahren. Mit der Anmeldung gehen Sie keine Verpflichtungen ein. Es kann bis zu drei Monate dauern, bis das erste Magazin zugestellt wird. Mit Ihrer Unterschrift erklären Sie sich damit einverstanden, dass die Daten Ihres Kindes zum Zweck einer LEGO Club Mitgliedschaft von der LEGO Gruppe gespeichert und verarbeitet werden. Die Daten werden vertraulich behandelt, nicht an Dritte weitergegeben und nicht veräußert. Externe Dienstleister erhalten Ihre Daten nur, soweit es für die Abwicklung von LEGO Kommunikation erforderlich ist. Wenn Sie von uns nicht mehr kontaktiert werden möchten, können Sie der Verwendung Ihrer Daten für Werbezwecke widersprechen unter: 00800 5346 5555 (Anruf gebührenfrei, Kosten für Anrufe aus Mobilfunknetzen können abweichen). \* Die Einwilligungen kann ich jederzeit (insgesamt oder zum Teil) ohne Einfluss auf die LEGO Club Mitgliedschaft bei der LEGO Gruppe widerrufen. Het LEGO Club Magazine kan alleen worden gestuurd naar adressen in Nederland. Het lidmaatschap is 2 jaar geldig en geeft recht op toezending van het gratis LEGO Club Magazine. Het eerste magazine zal na 12 tot 14 weken toezegd worden. Het lidmaatschap kan op ieder moment opgezegd worden. Door dit formulier te tekenen geeft u de LEGO Club toestemming om bovenstaande gegevens te gebruiken voor het toesturen van LEGO mailings. Uw gegevens worden uitsluitend gebruikt voor mailings van LEGO en zullen niet worden verkocht, verhuurd of op welke wijze dan ook verstrekt aan derden buiten de LEGO Groep, uitgezonderd de organisaties die namens ons optreden om de service te verlenen waar uw kind om gevraagd heeft. Den norske utgaven av magasinet sendes kun til adresser i Norge. Medlemskap i klubben gjelder i 2 år og inkluderer gratisutgaver av LEGO Magazine. Påregnet opp til seks uker leveringstid for første magasin. Ved å undertegne dette skjemaet, gir du ditt samtykke til at LEGO Club kan bruke opplysningene om barnet ditt i LEGO forsendelser. Dataene vil utelukkende bli brukt i LEGO forsendelser og vil ikke bli solgt, utleid eller på annen måte gjøres tilgjengelig for selskaper utenfor LEGO gruppen, unntatt selskaper som er våre agenter og som hjelper oss å tilby tjenestene barnet etter spør. Dette skjemaet gjelder for ett gratis medlemskap per person, gruppe eller organisasjon. Den svenska versionen av tidningen kan endast skickas till adresser i Sverige. Club-medlemskapet är giltigt i 2 år och innefattar gratis exemplar av LEGO Club Magazine. Vänligen räkna med 6 veckor för leverans av din första tidning. Genom att skicka in det här formuläret godkänner du att LEGO Club använder barnets uppgifter för LEGO utskick. Uppgifterna kommer bara att användas för LEGO utskick och kommer inte att säljas, hyras ut eller vidarebefordras till något företag som inte tillhör LEGO Gruppen, med undantag av företag som agerar som våra ombud för att tillhandahålla tjänster som barnet har begärt. Den här kupongen gäller för ett gratis medlemskap per person, grupp eller organisation.

Mail to: / Poster à:



BG29

LEGO Club

P.O. Box 1157  
Enfield, CT USA  
06083-1157

Mail to:



BI09U

LEGO Club

33 Bath Road  
Slough SL1 3UF  
United Kingdom

Per Post an:



BI09C

LEGO Club

Postfach 14 15  
D-36243 Niederaula

Stuur op naar:



BI09N

LEGO Club

Postbus 40250  
3504 AB Utrecht

Send til:



BI09O

LEGO Club Norge

Postboks 58  
1314 Vøyenenga

Skickas till:



BI09S

LEGO Club Sverige

Ubox 841  
202 29 Malmö

Parent's signature - Signature d'un parent - Unterschrift Erziehungsberechtigte/r

Handtekening ouders - Foreldres/Foresets underskrift - Forælders / Förmyndares underskrift

Date  
Datum  
Dato



# WIN!

Go to [www.nielsen.com/LEGO](http://www.nielsen.com/LEGO) to fill out a survey for a chance to win a cool LEGO® Product.  
No purchase necessary.  
Open to all residents where not prohibited.



## [www.nielsen.com/LEGO](http://www.nielsen.com/LEGO)

### GEWINNE!

Nimm an der Umfrage auf [www.nielsen.com/LEGO](http://www.nielsen.com/LEGO) teil und hab die Chance ein cooles LEGO Produkt zu gewinnen!  
Die Teilnahme am Gewinnspiel führt zu keinerlei Kaufverpflichtungen. Teilnahme in allen nicht ausgeschlossenen Ländern möglich.

### WIN!

Ga naar [www.nielsen.com/LEGO](http://www.nielsen.com/LEGO), vul een enquêteformulier in en maak kans op een cool LEGO® product.  
Geen aankoopverplichting.  
Iedereen mag deelnemen, uitgezonderd ingezetenden van landen waar een enquêteverbod geldt.

### GAGNE!

Visite [www.nielsen.com/LEGO](http://www.nielsen.com/LEGO) pour répondre à un questionnaire et avoir une chance de gagner un produit LEGO® très cool!  
Aucune obligation d'achat.  
Ouvert à tous les résidents des pays autorisés.

### 当てよう!

[www.nielsen.com/LEGO](http://www.nielsen.com/LEGO) にアクセスして、アンケートにご記入ください。当選者にはレゴ製品を差し上げます。  
お買い上げの必要はありません。  
禁止されていない限り、すべての賞品にご利用いただけます。