

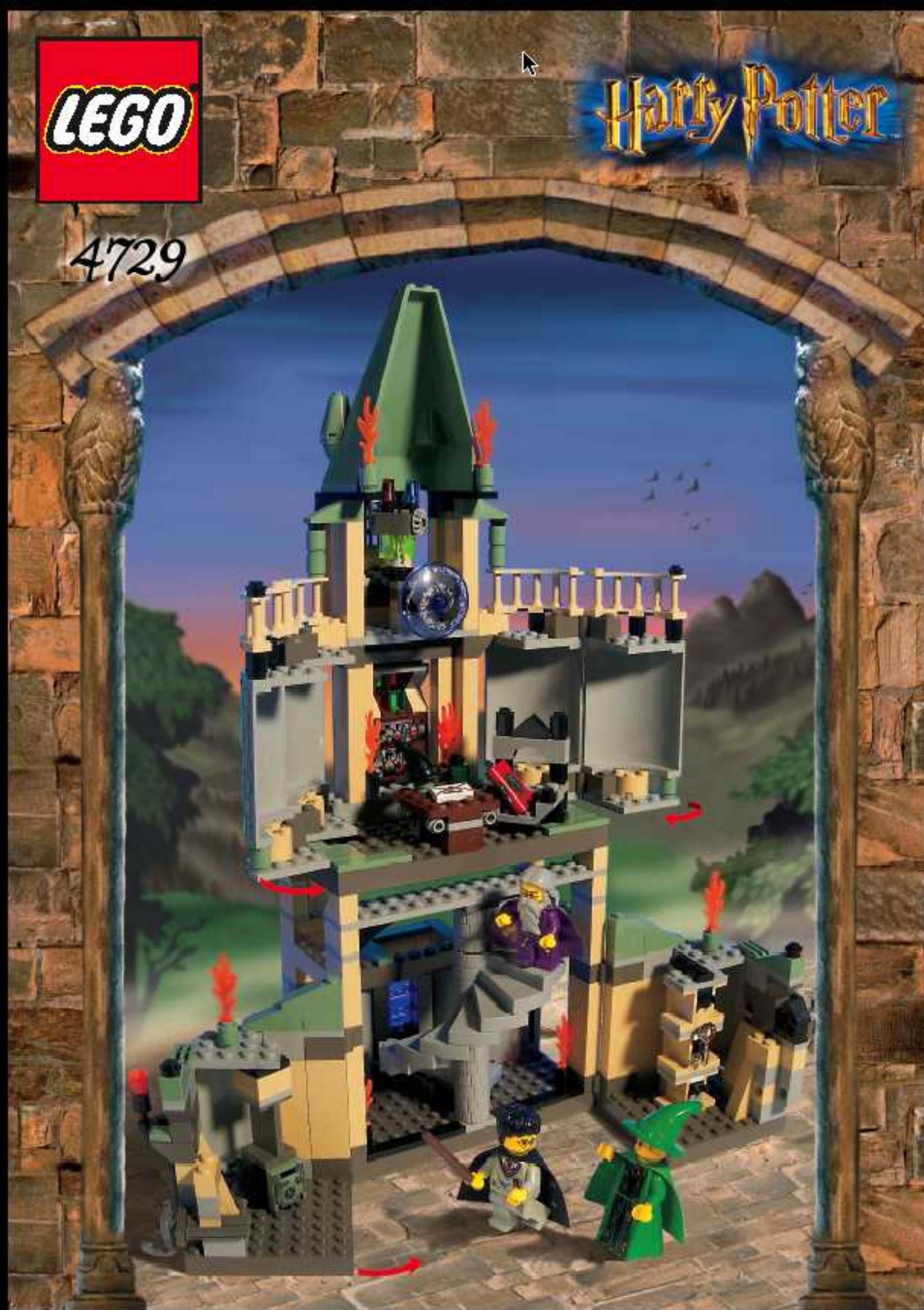

Harry Potter

4729

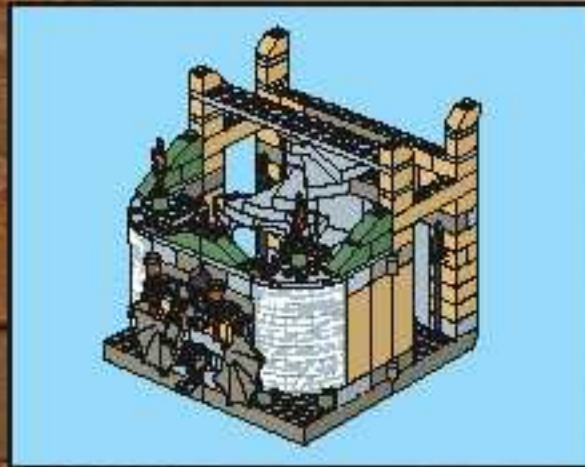

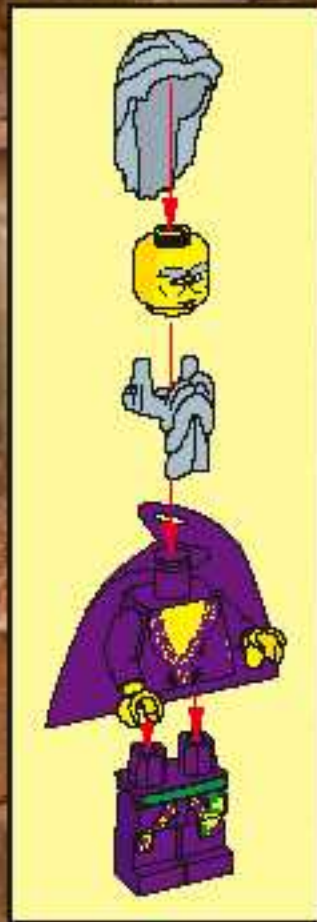

1

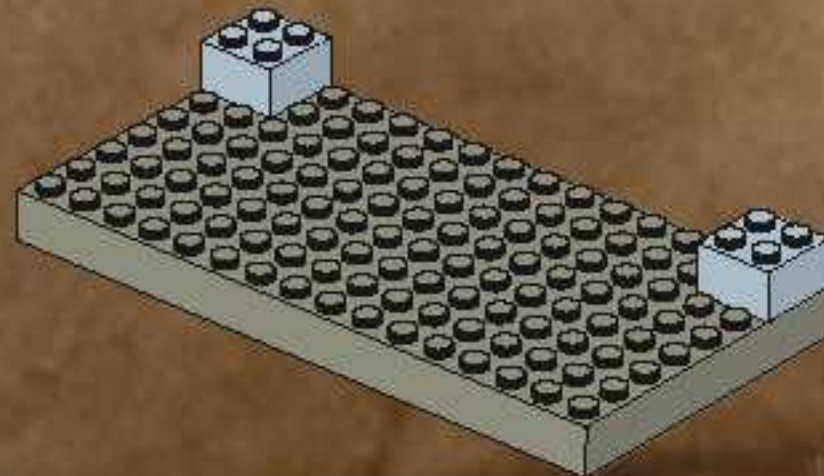

2

2

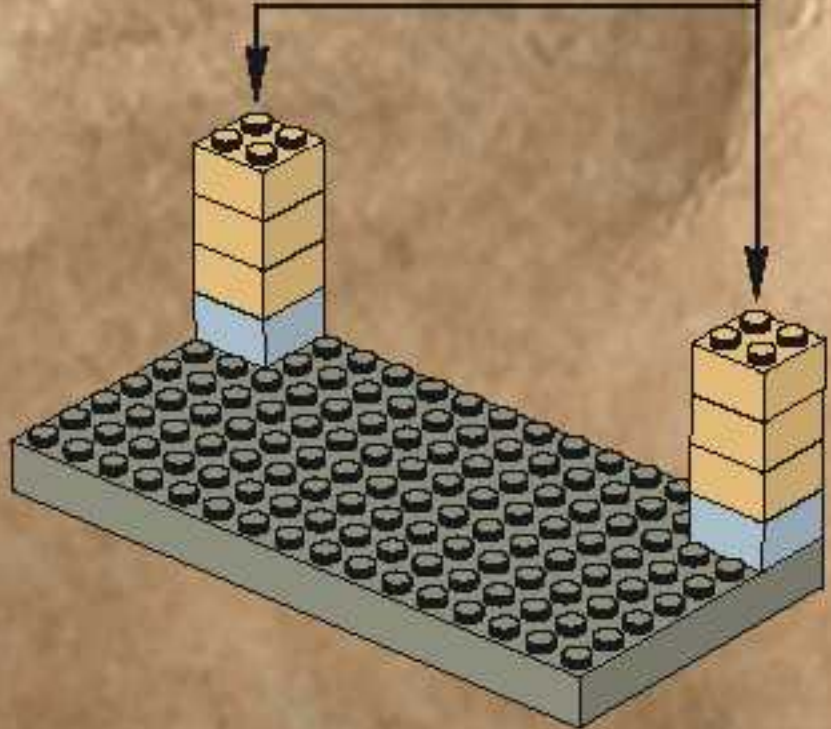
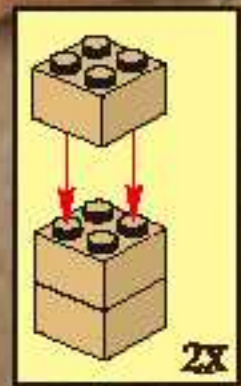

3

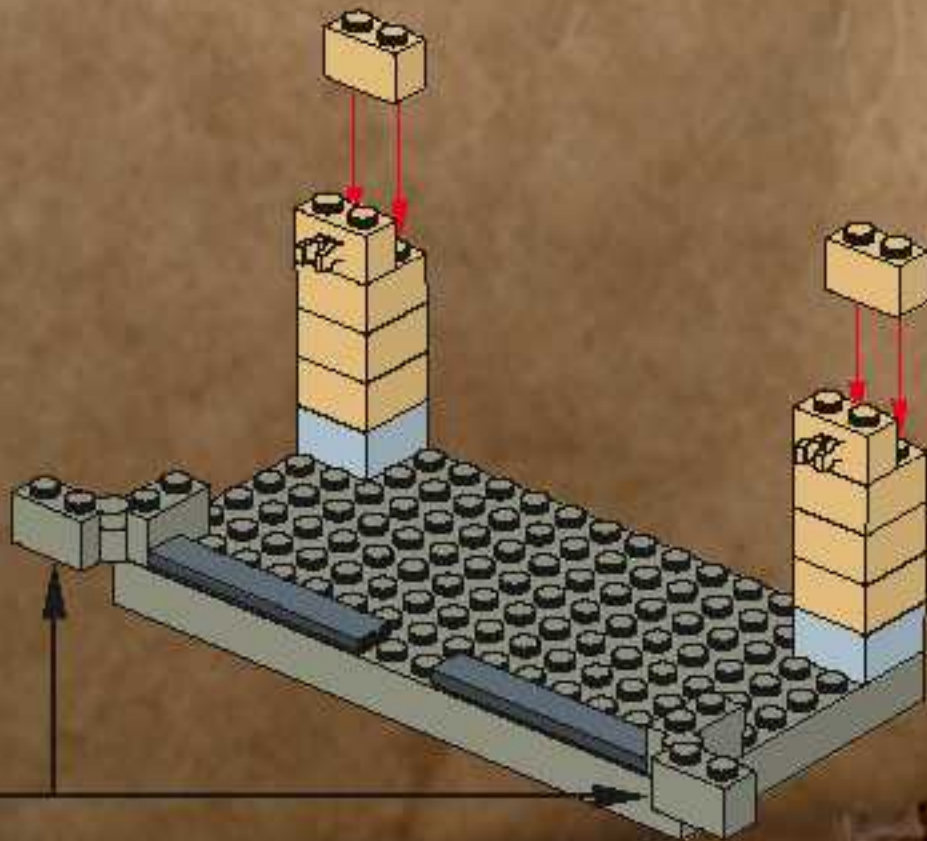
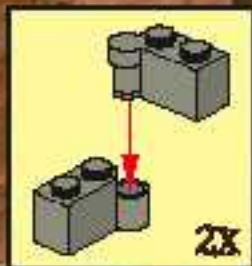

4

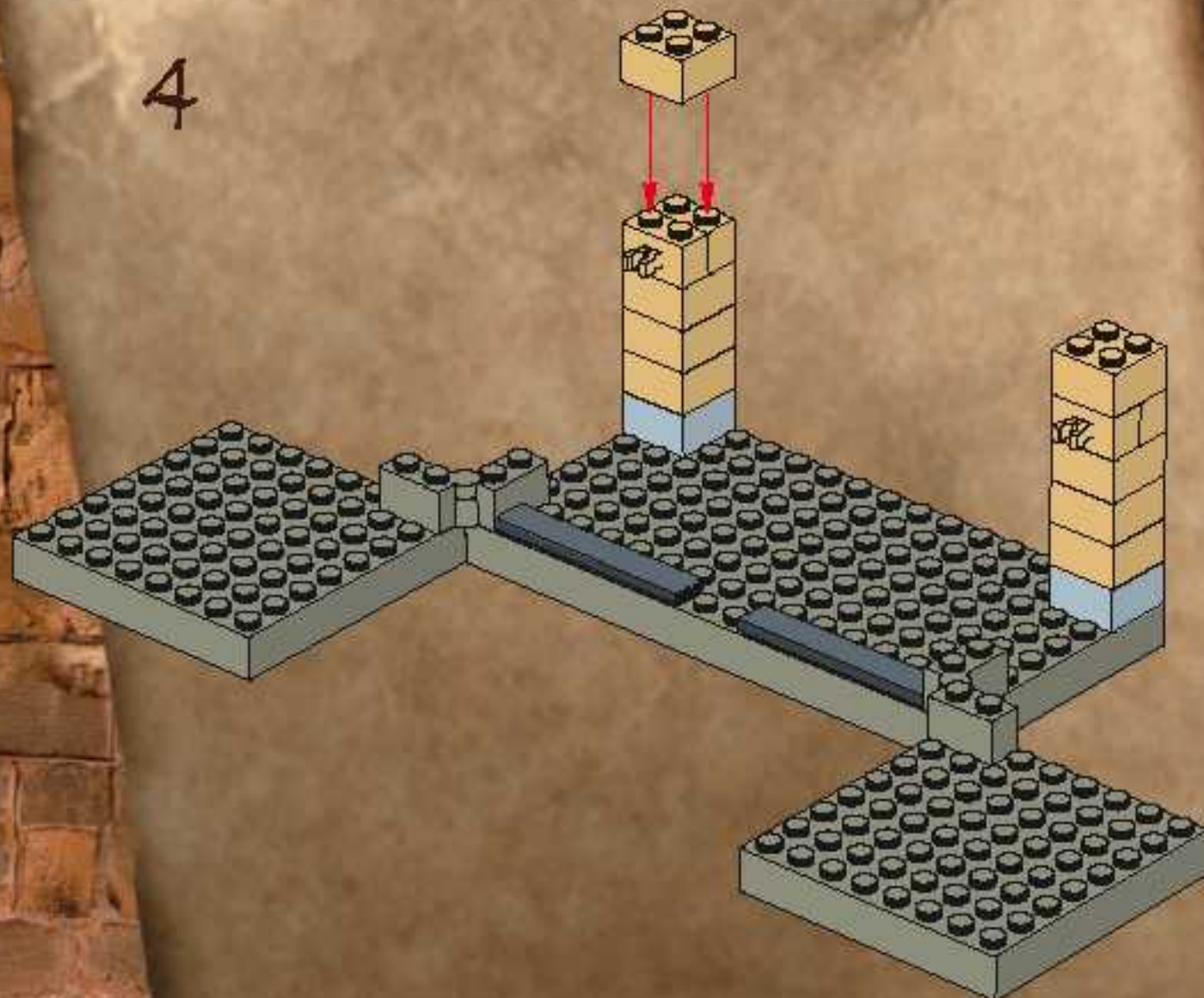

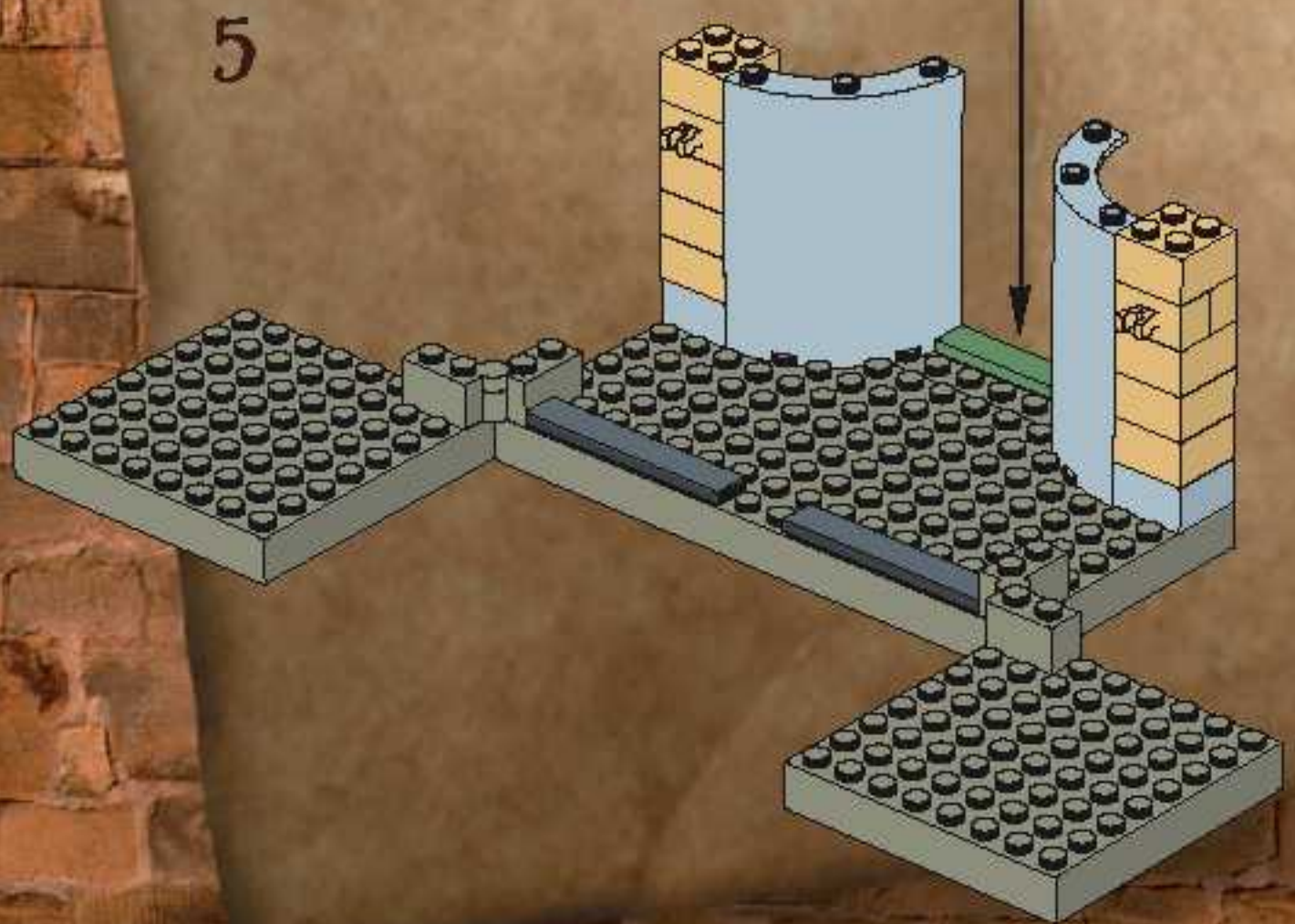
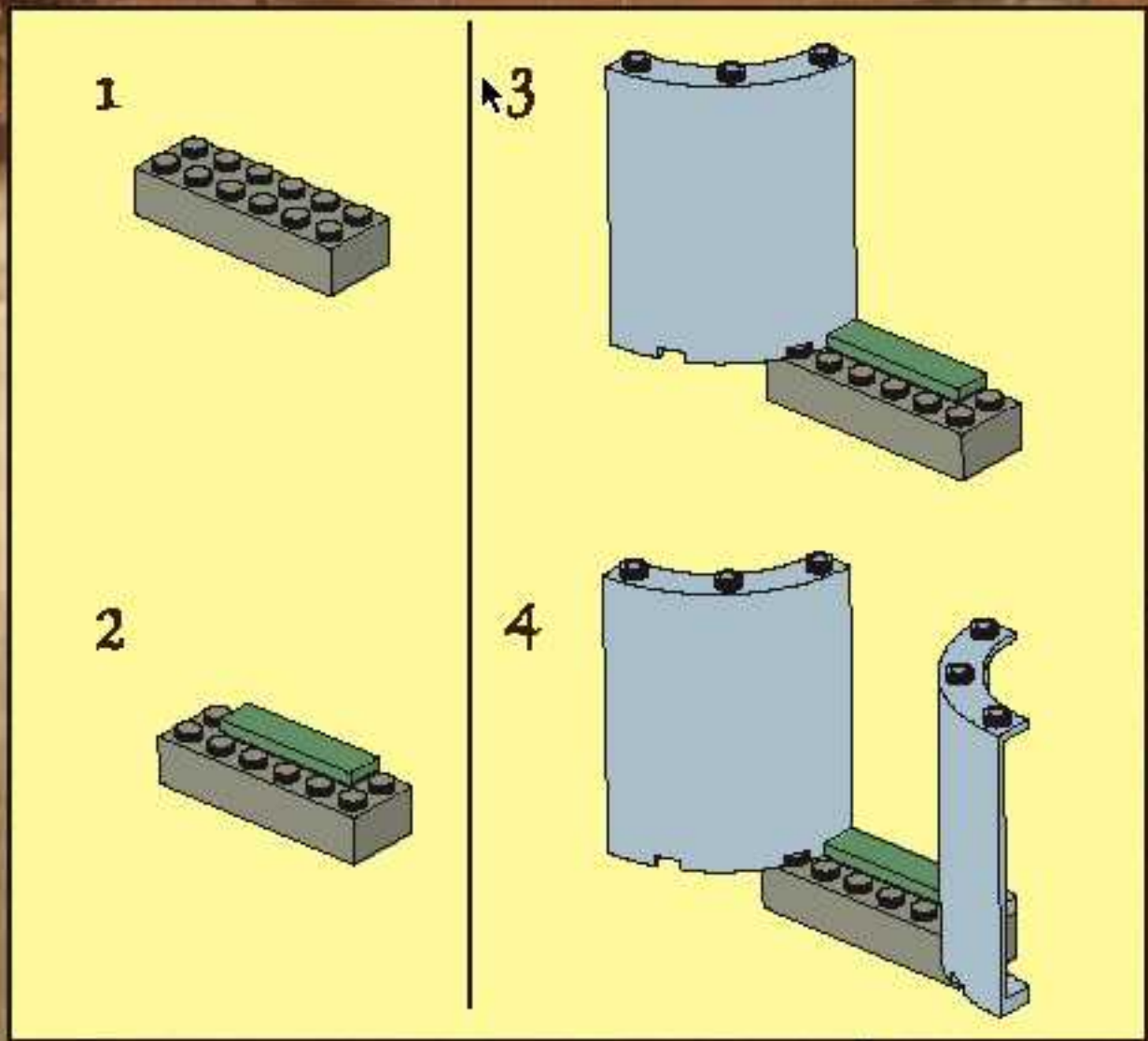

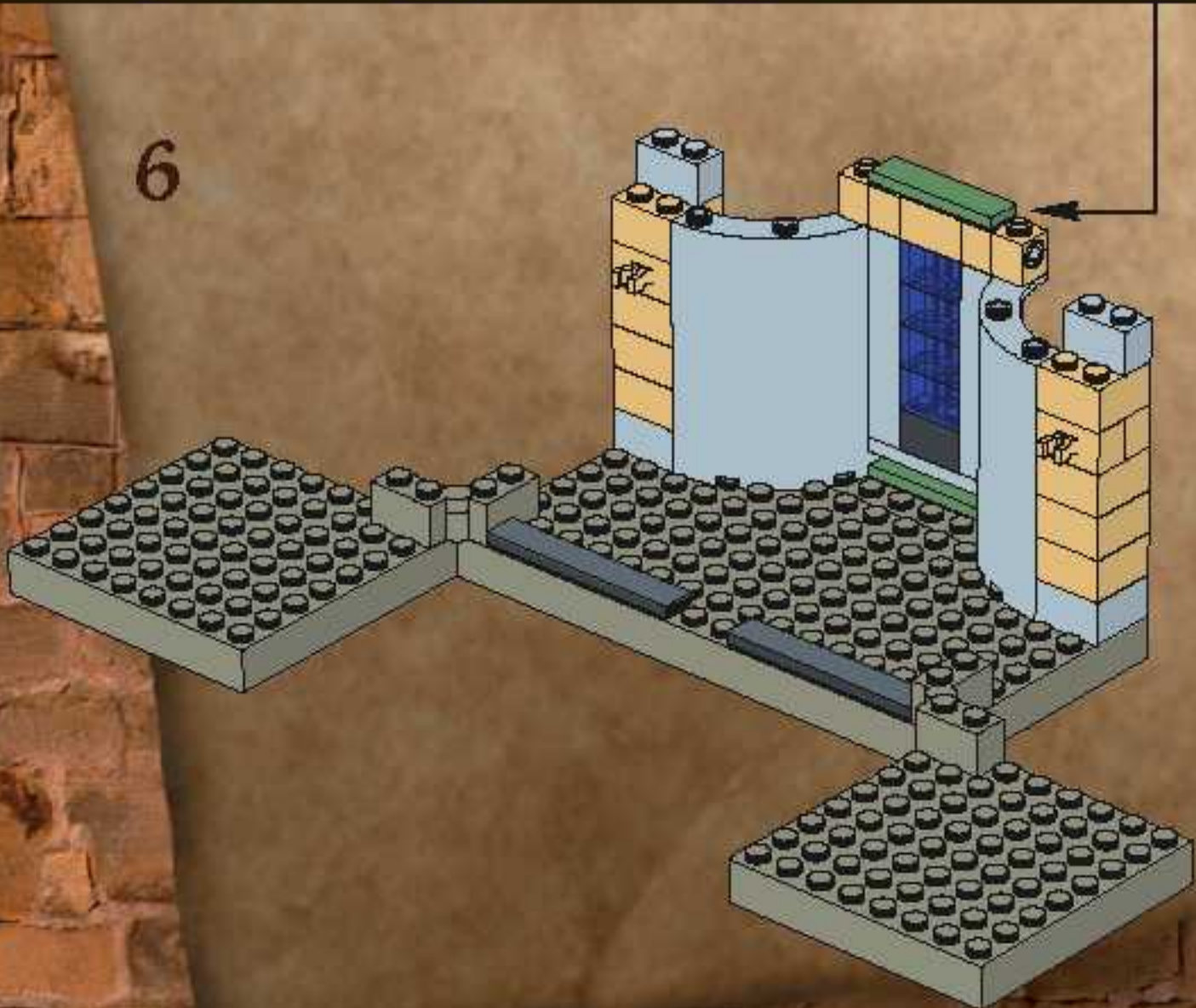
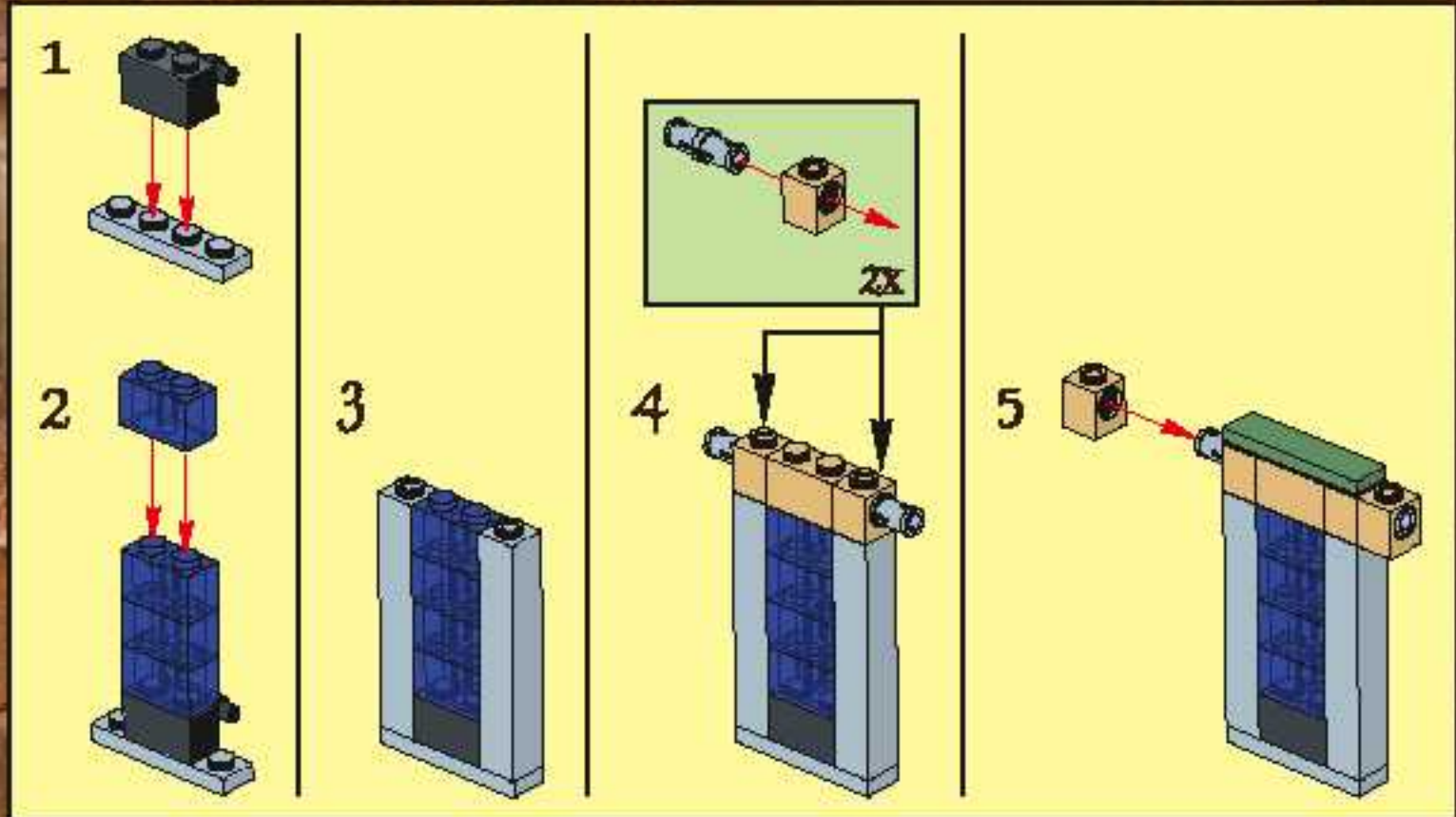

7

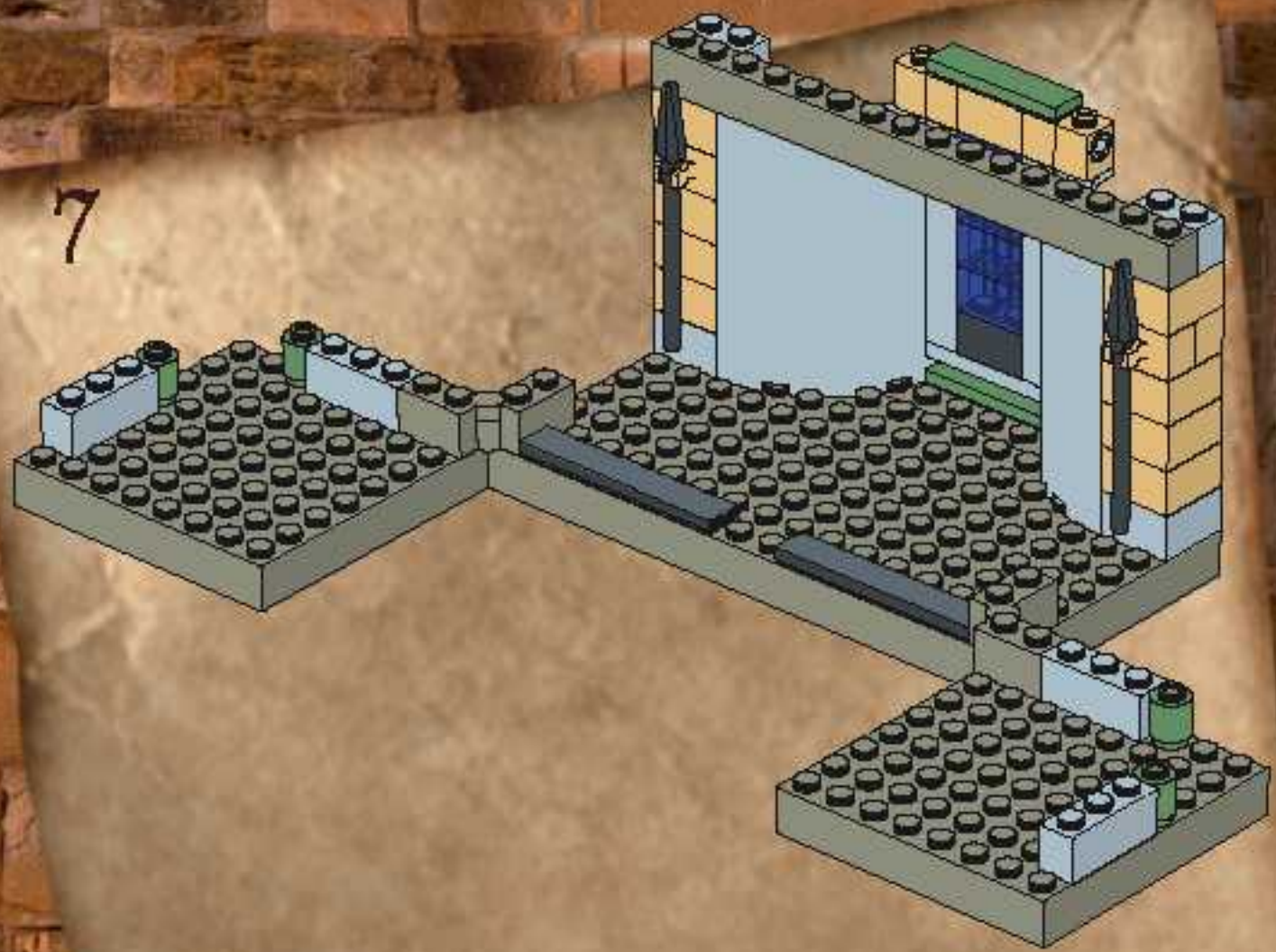

8

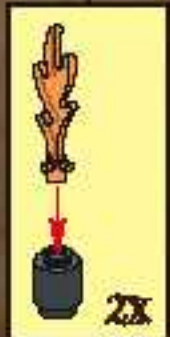
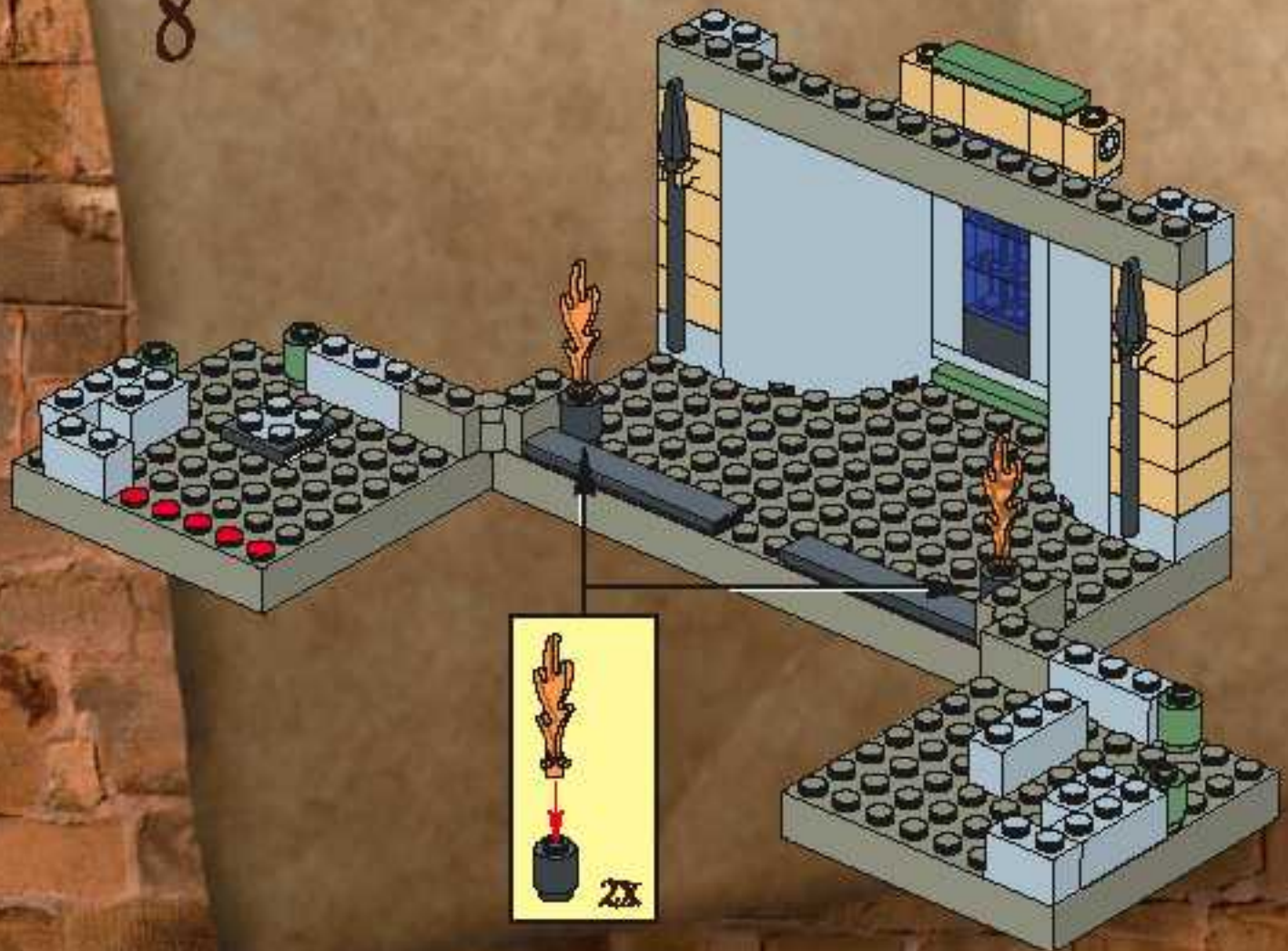

9

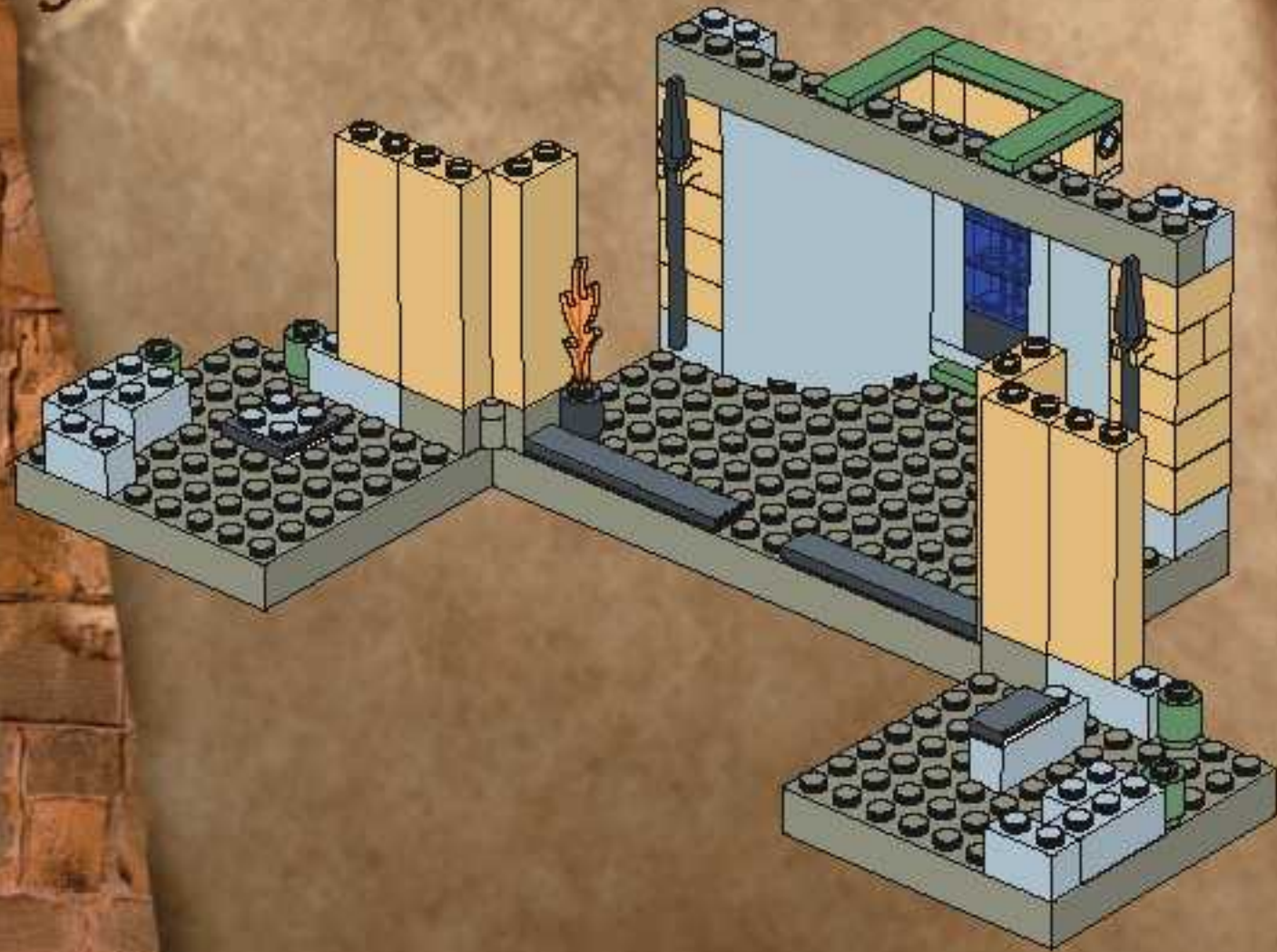

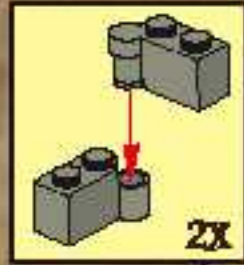

10

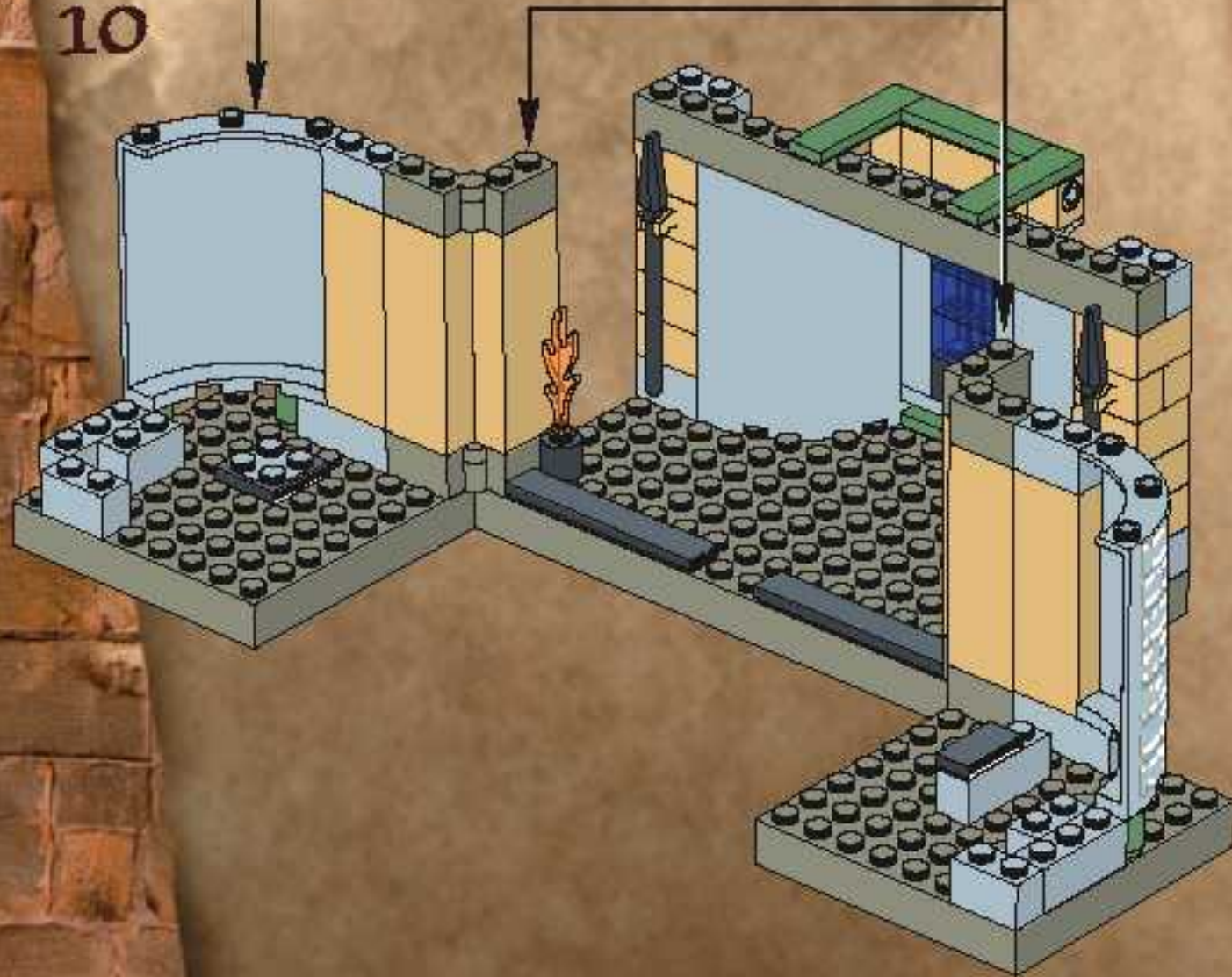

11

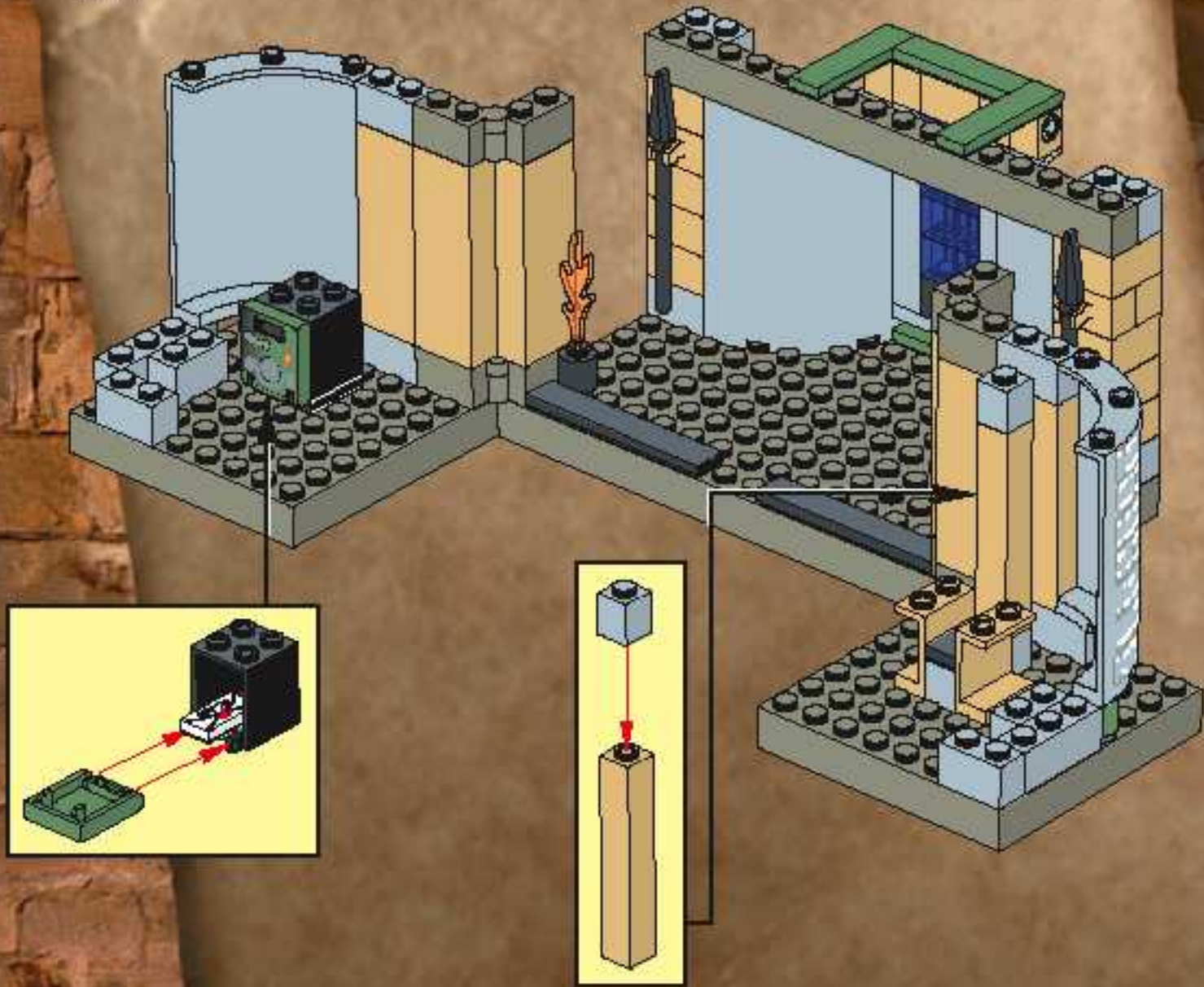

12

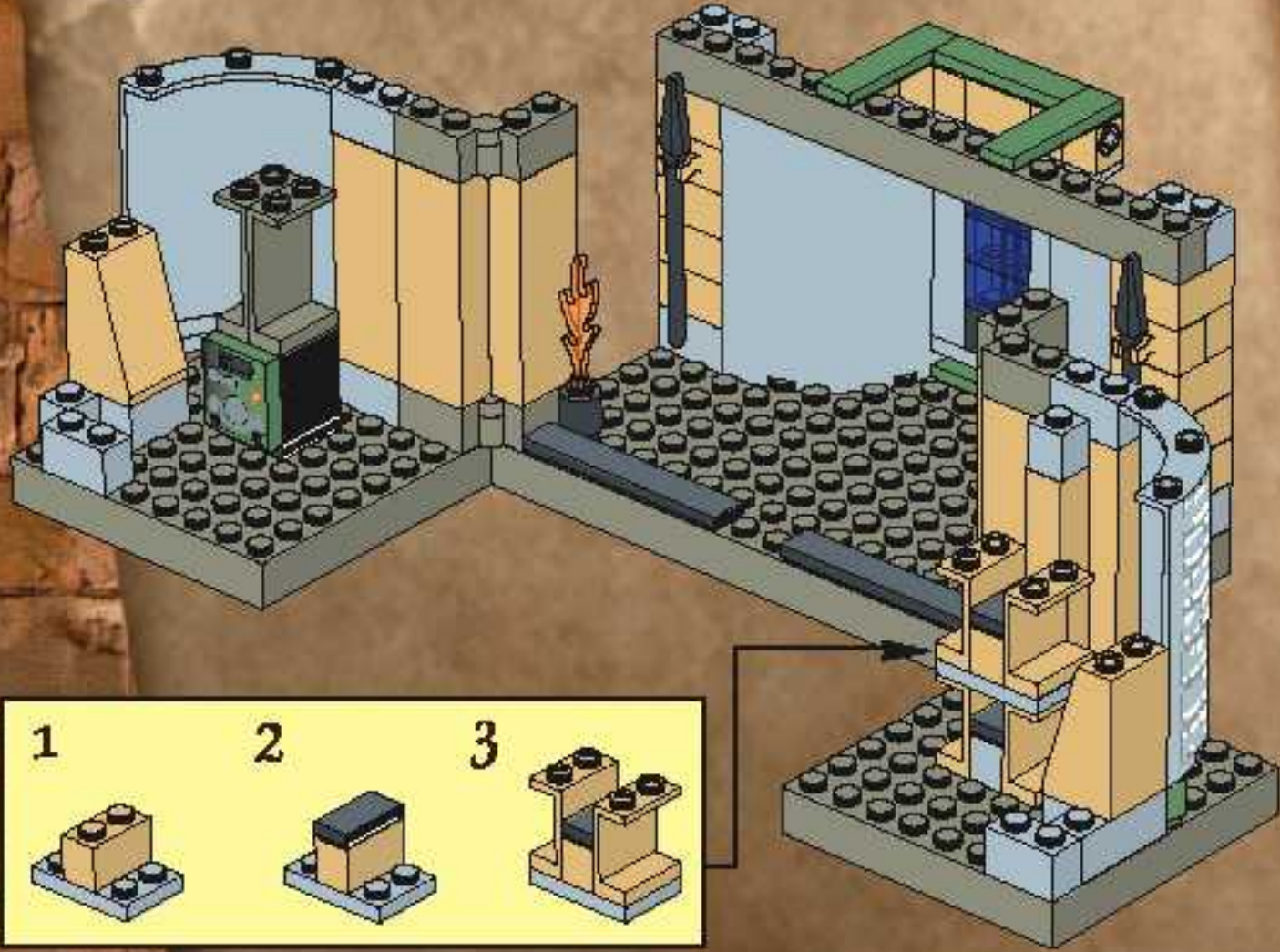

- 1
- 2
- 3

13

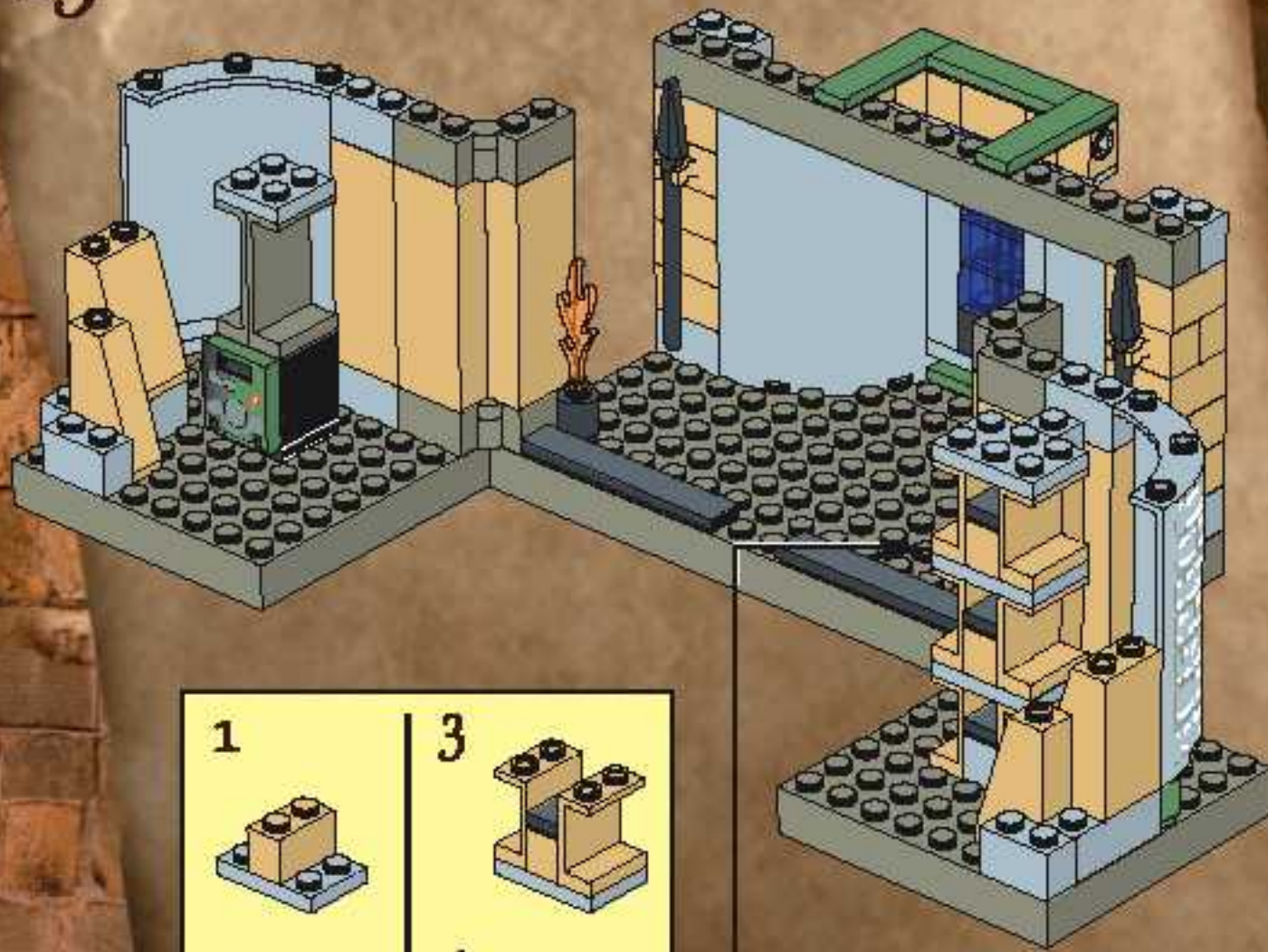

1

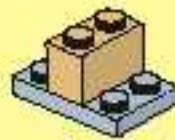

2



3



4



14

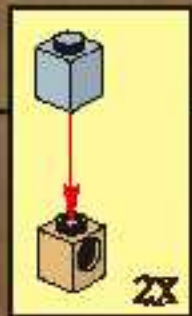
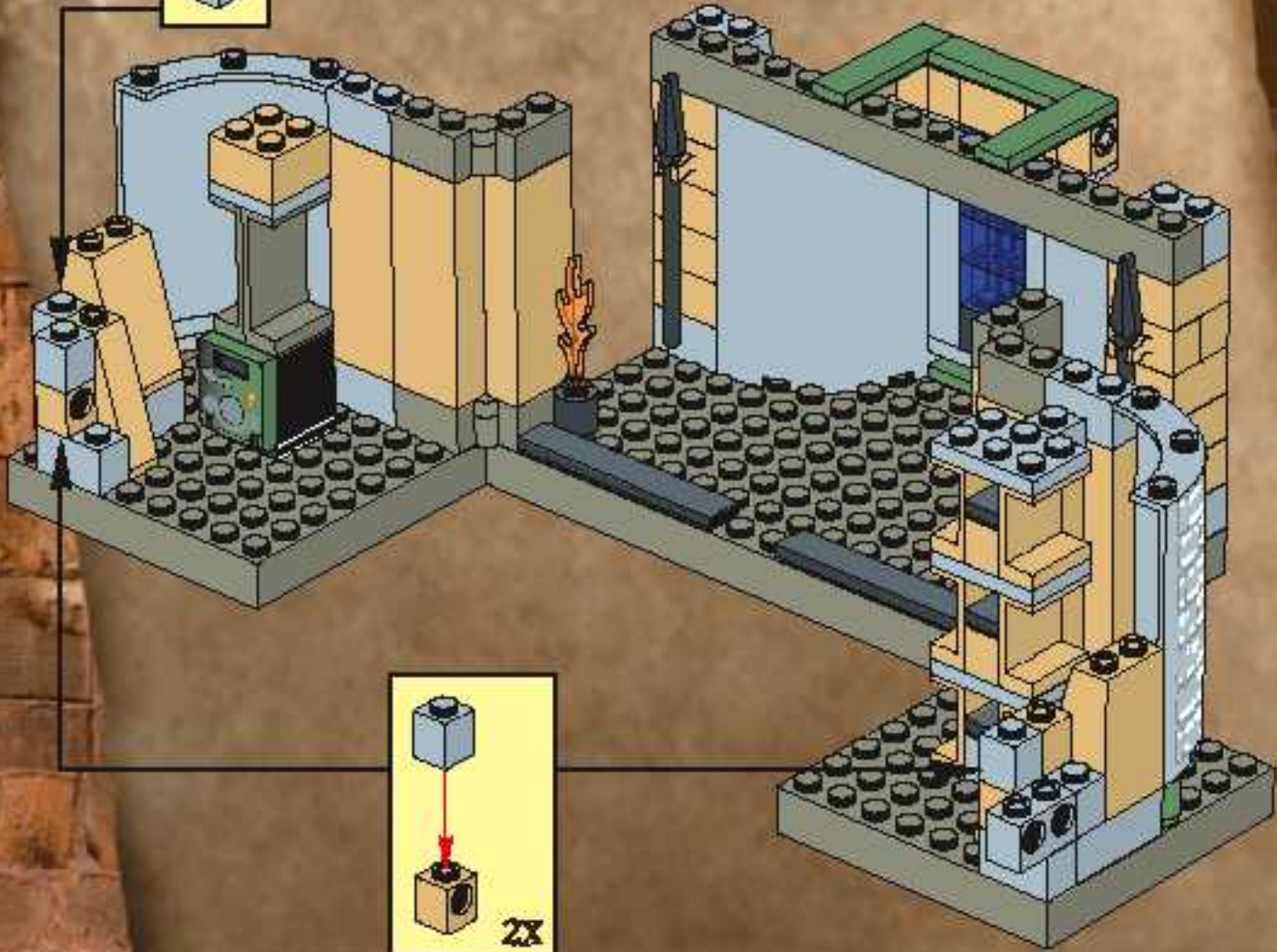
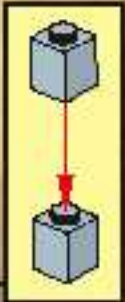

15

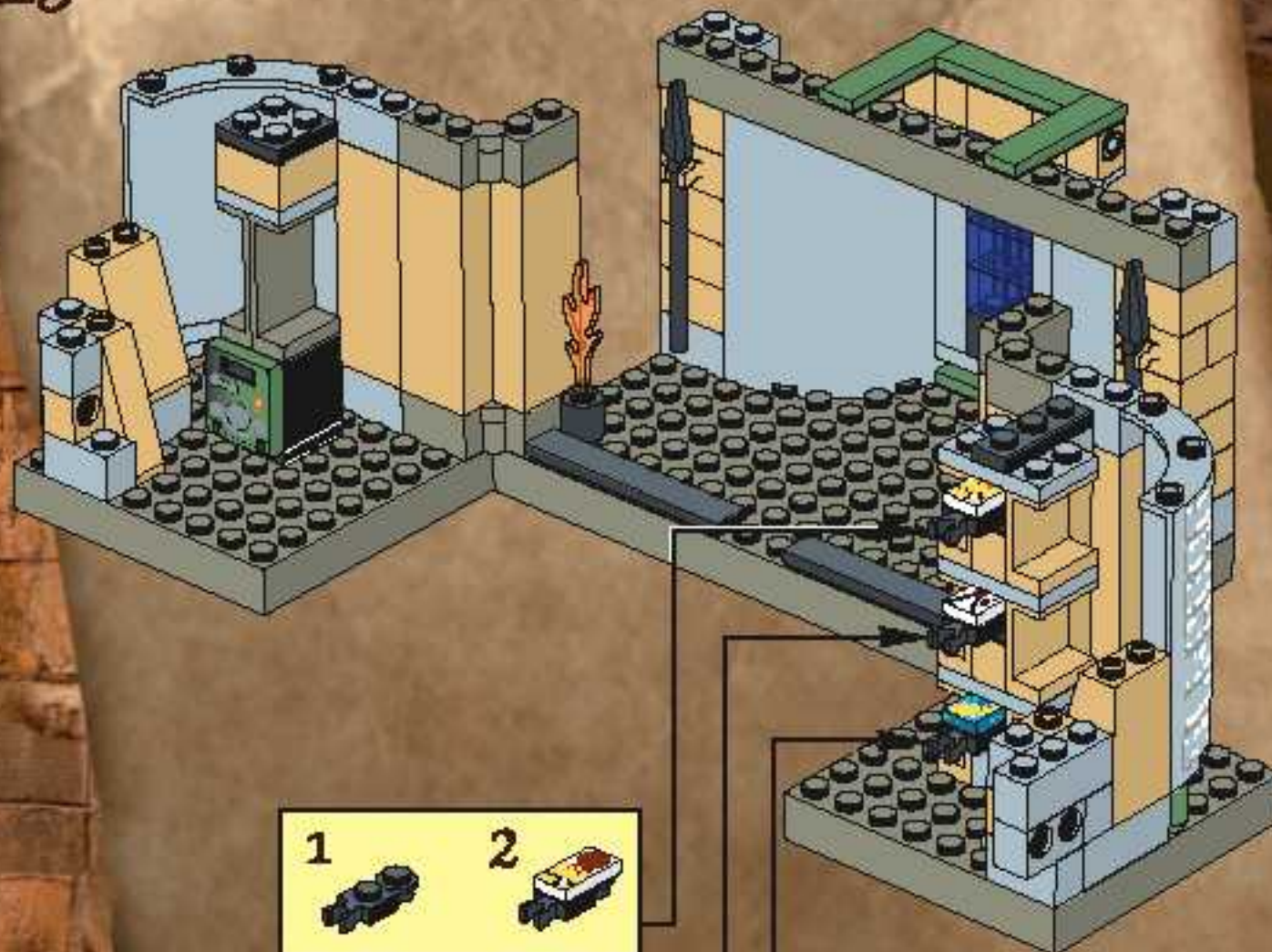

16

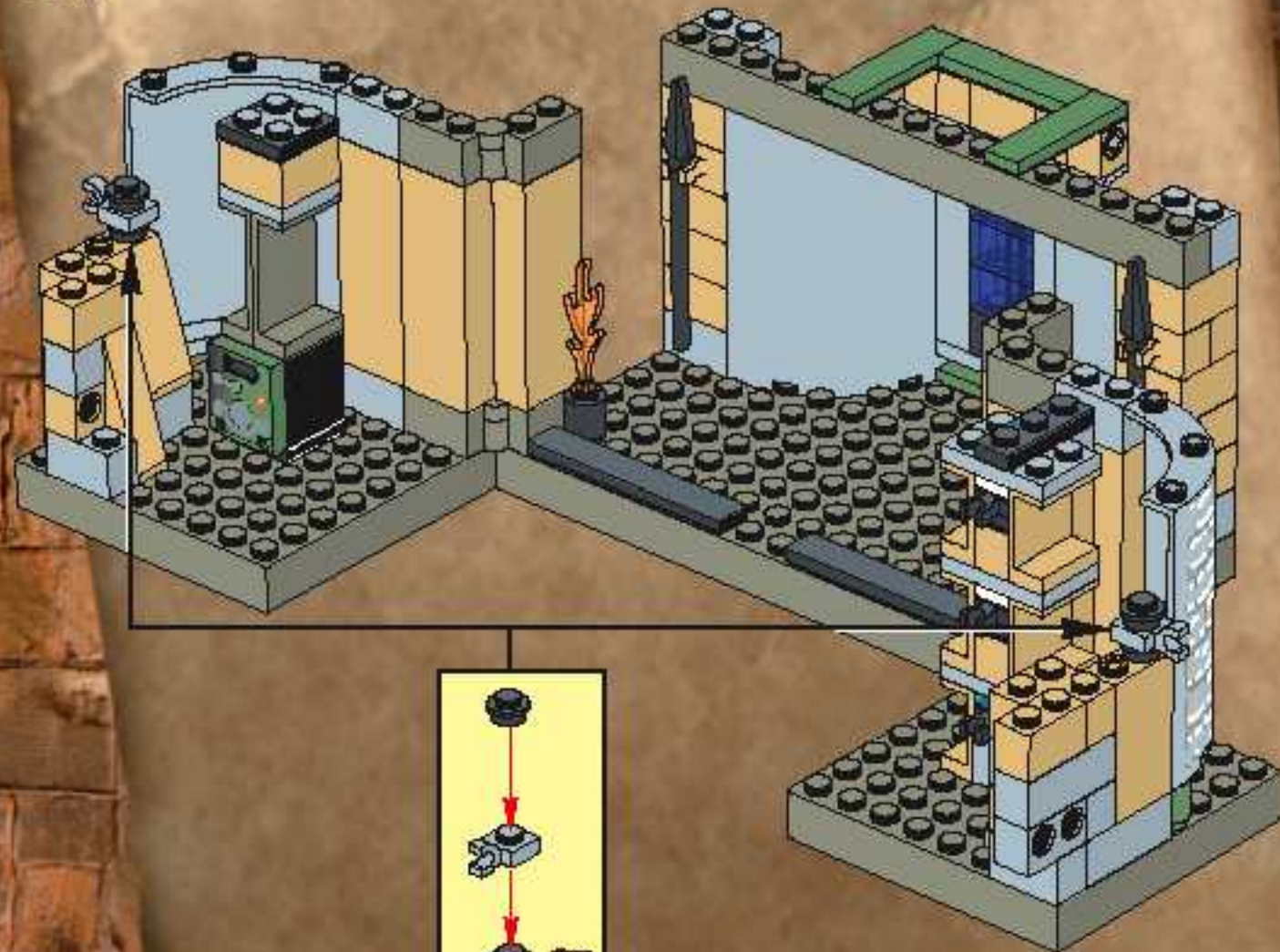

17

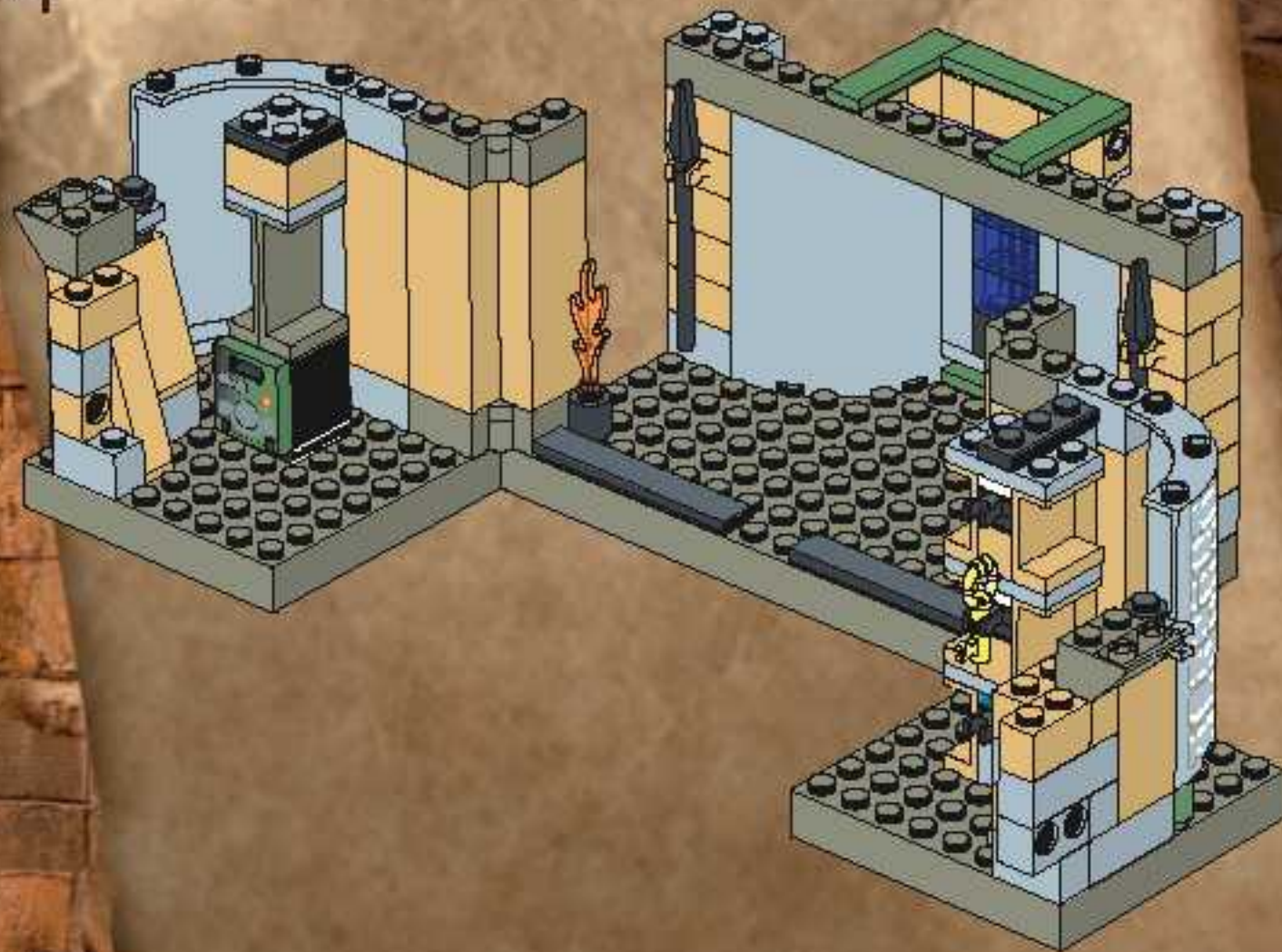

18

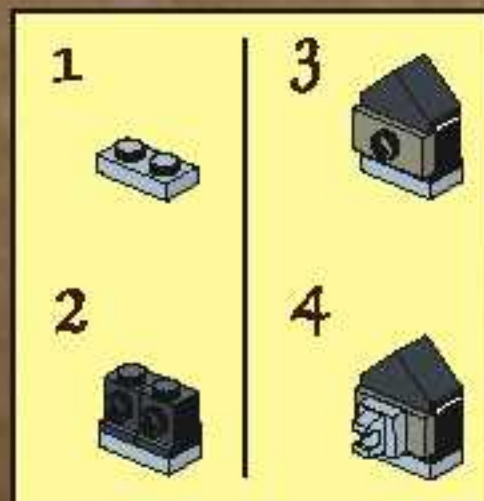
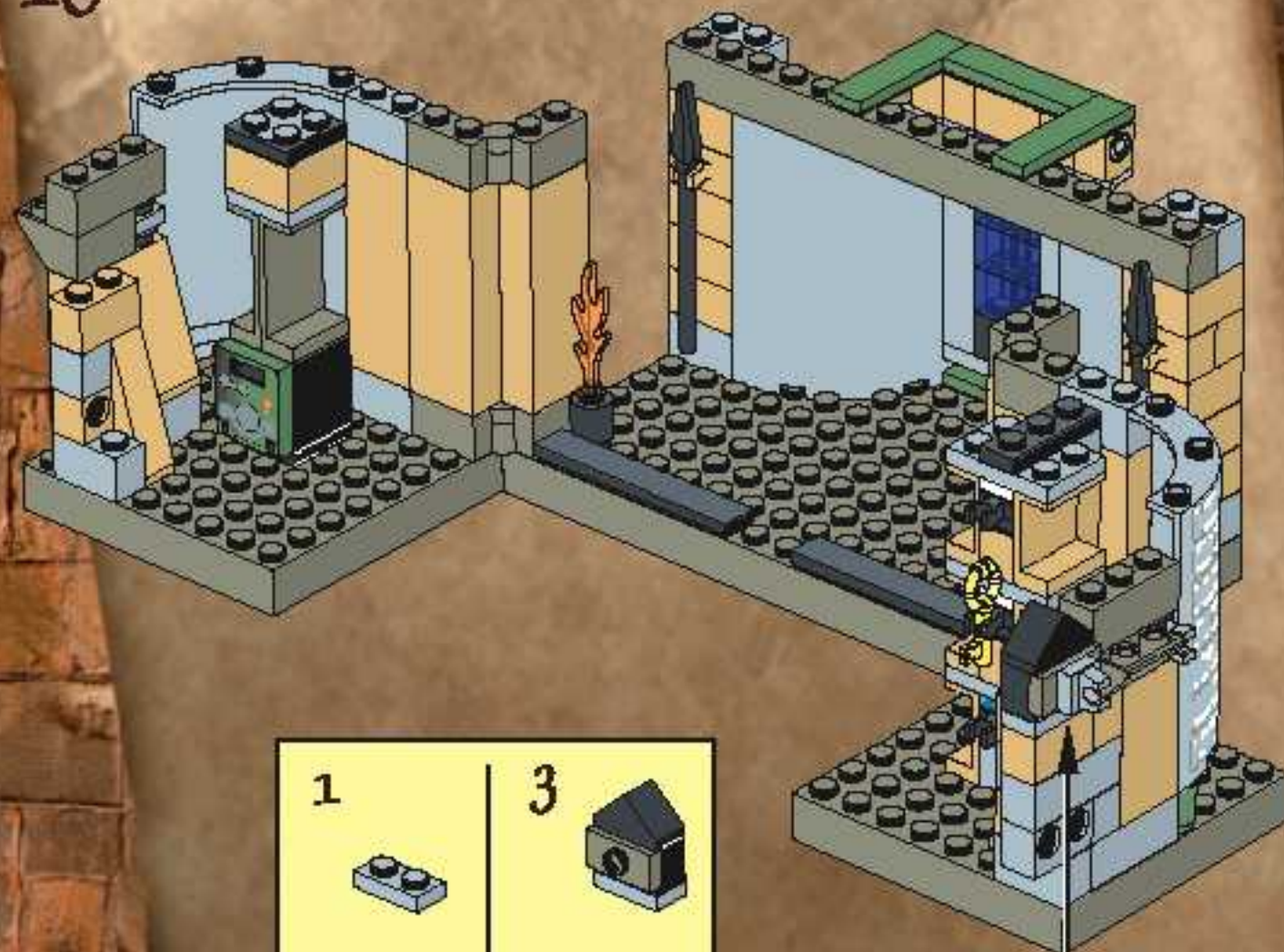

19

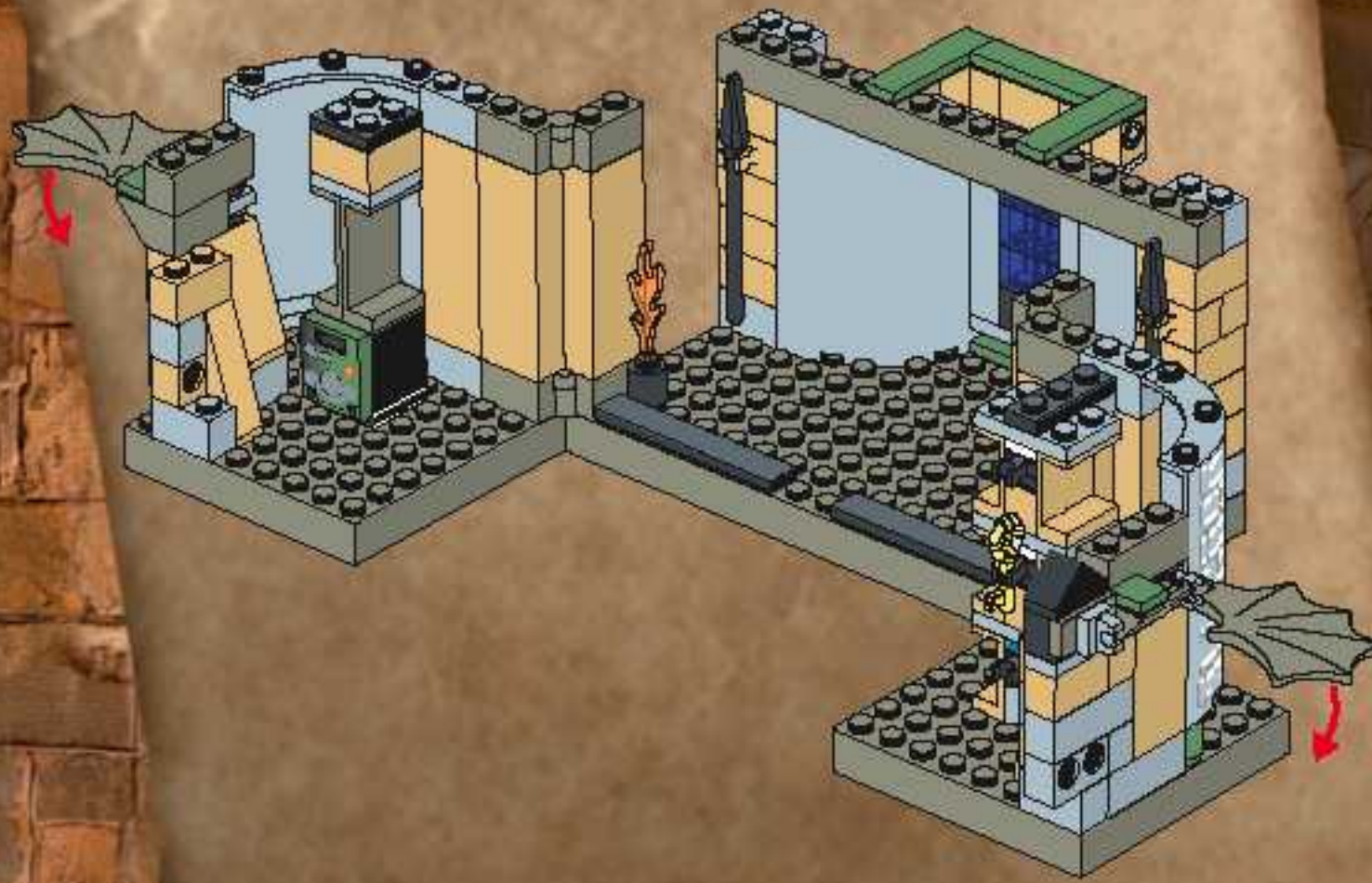

20

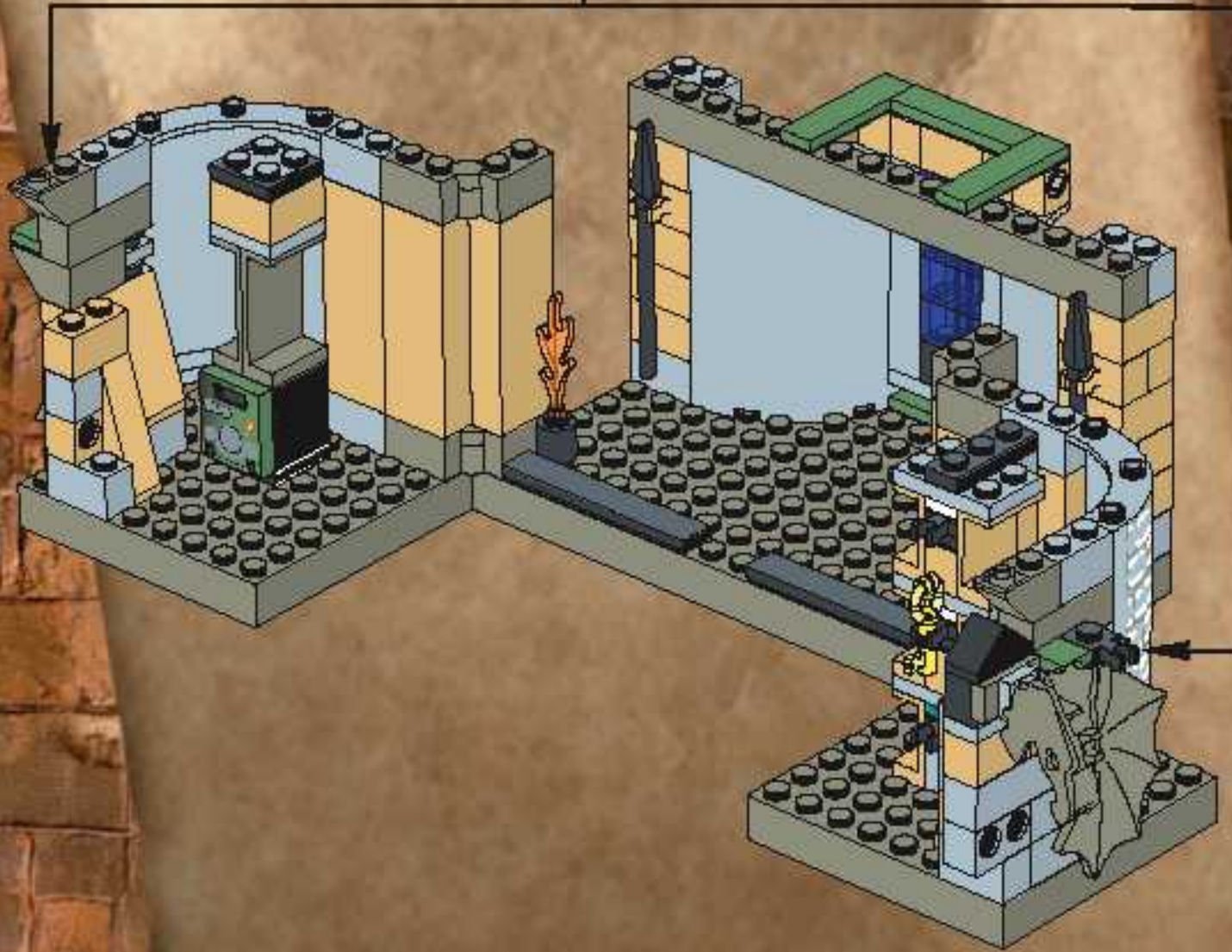



21

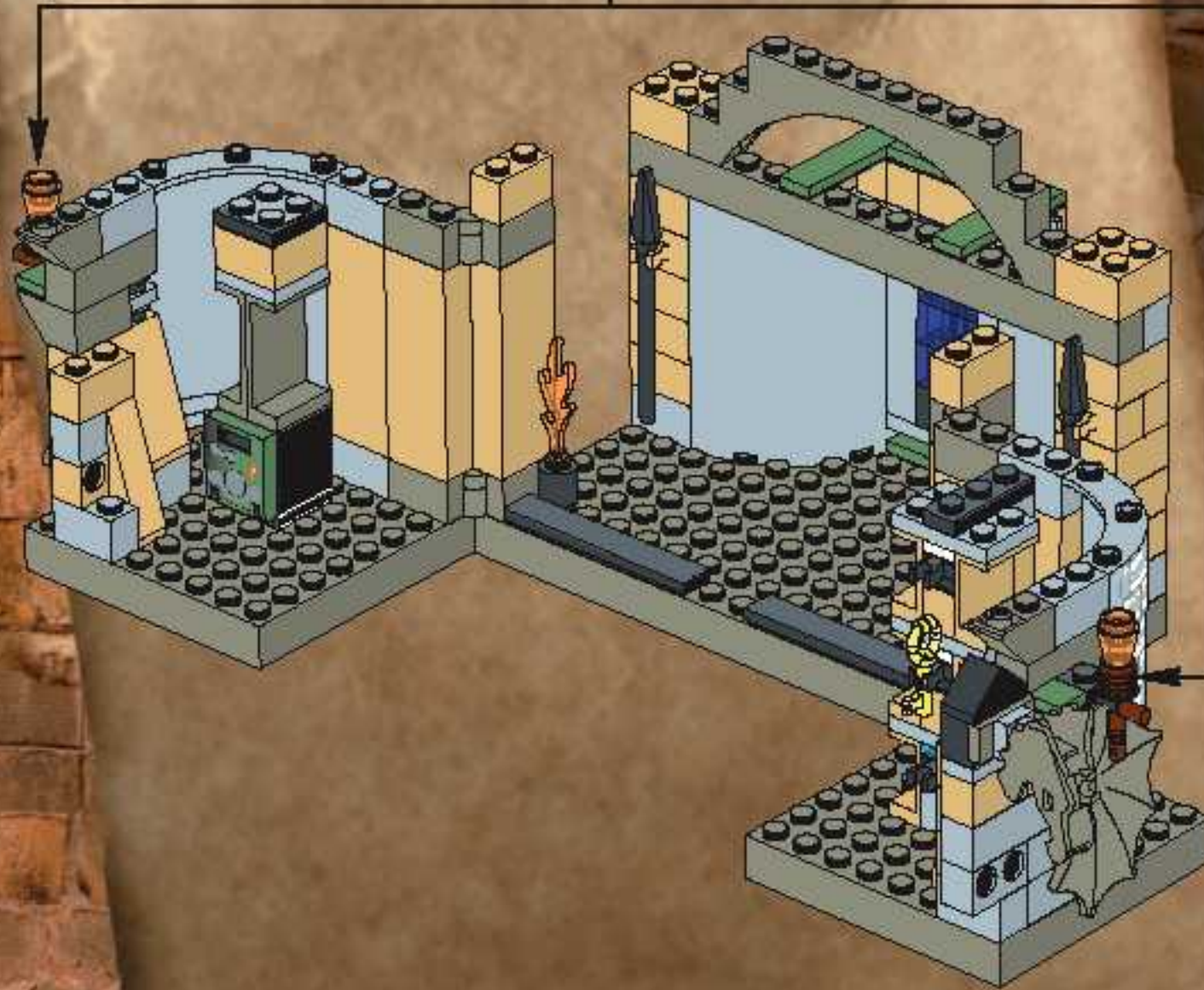

22

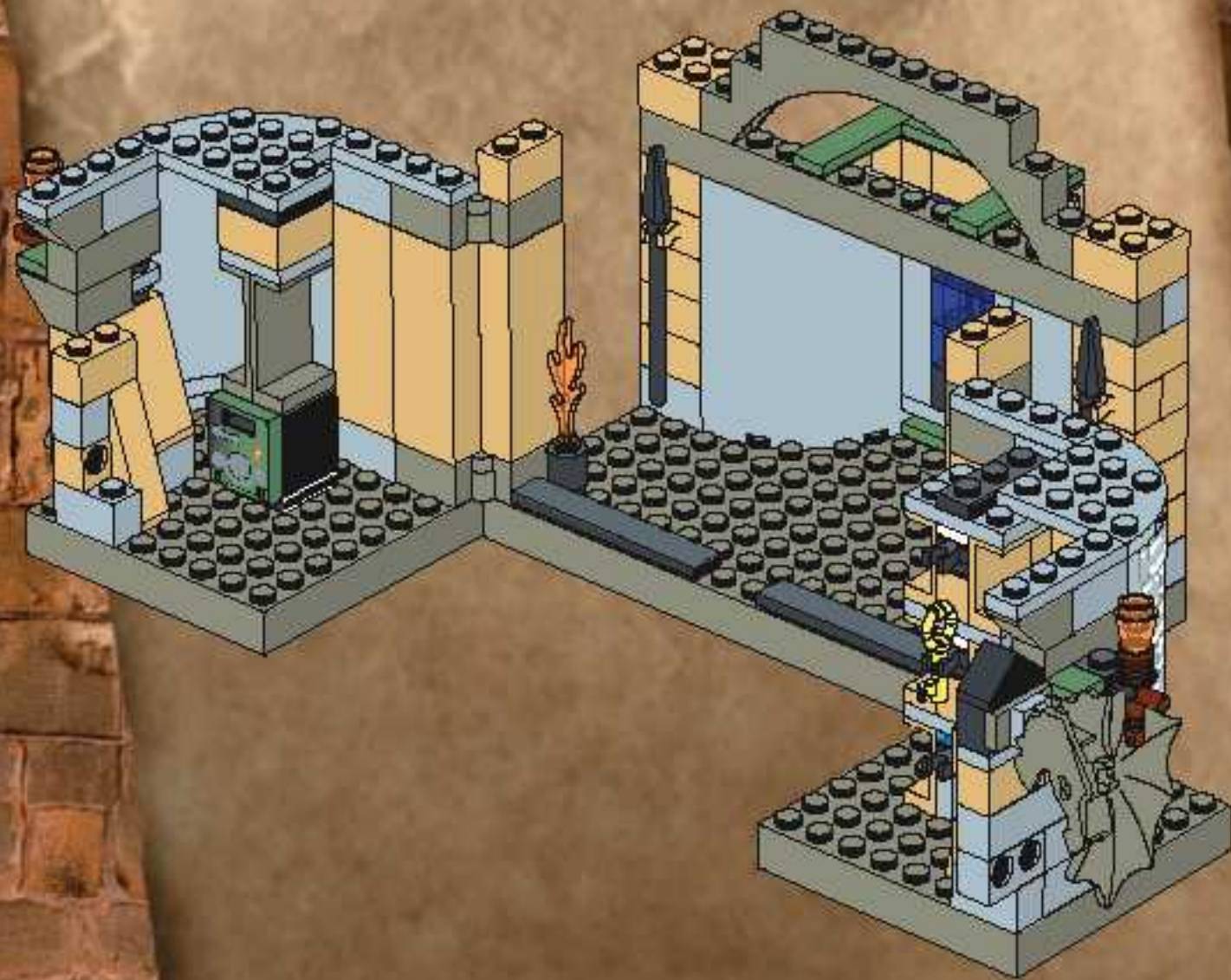

23

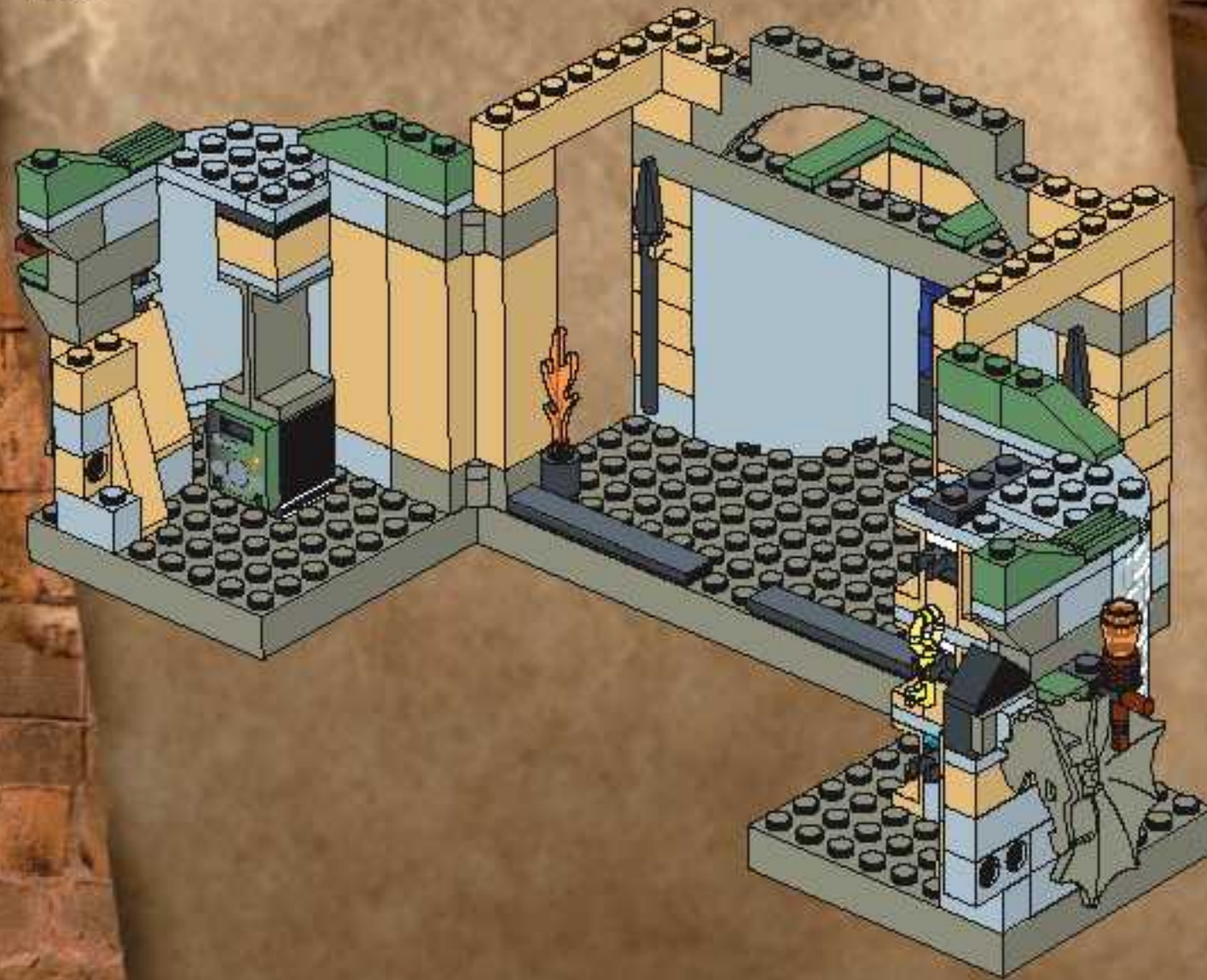

24

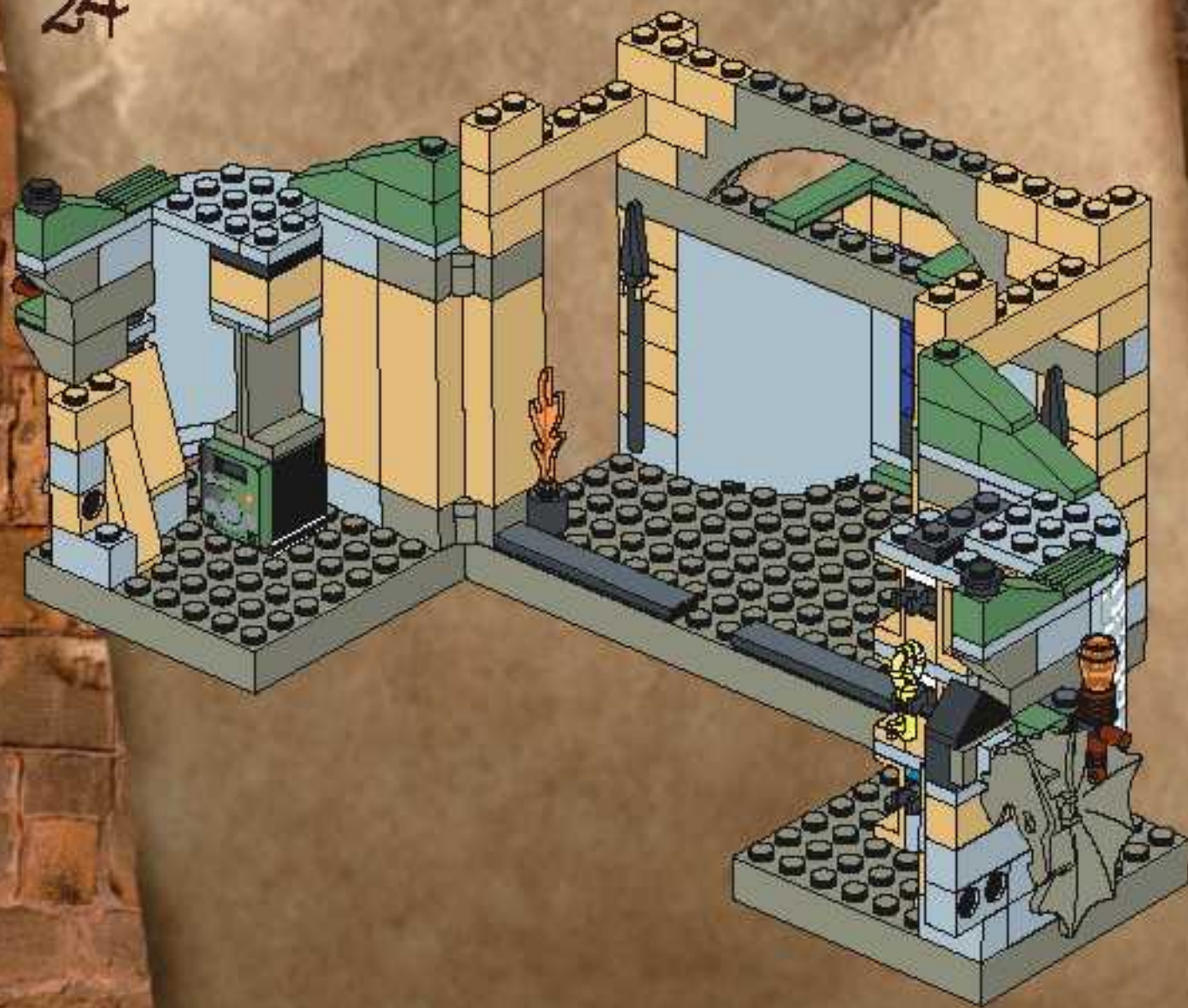

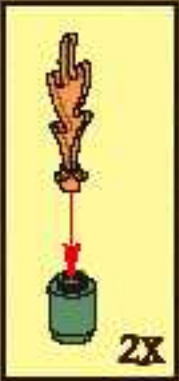

25

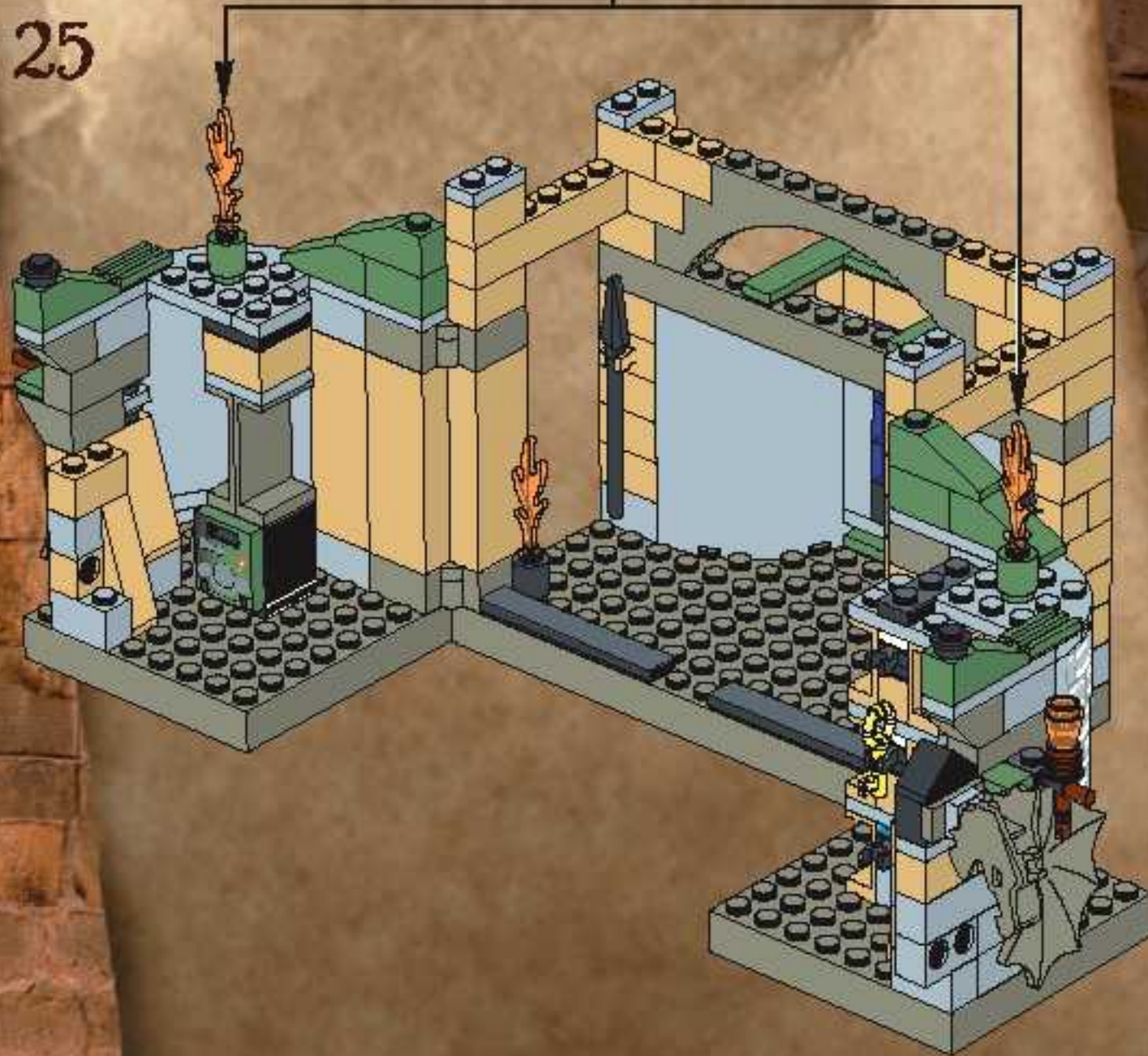

1

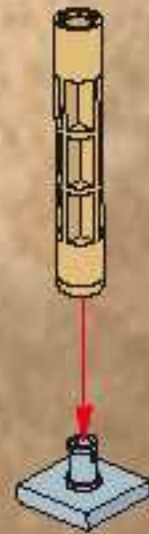

2



3

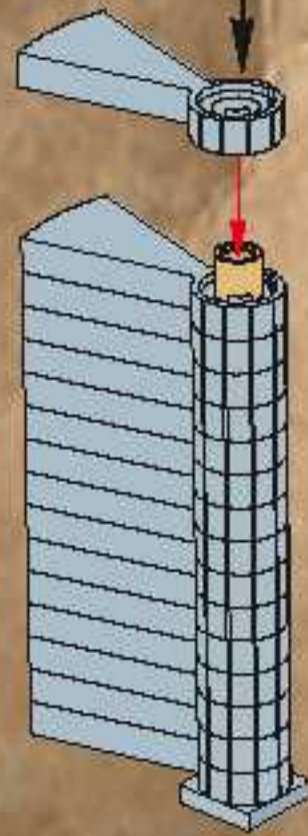
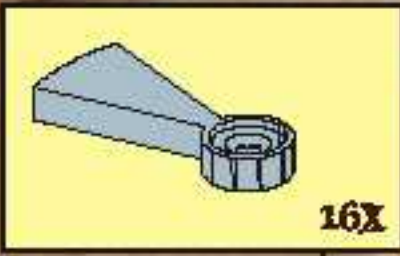

4

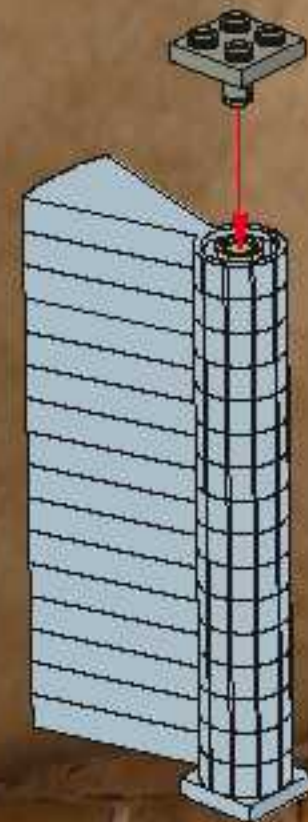

26

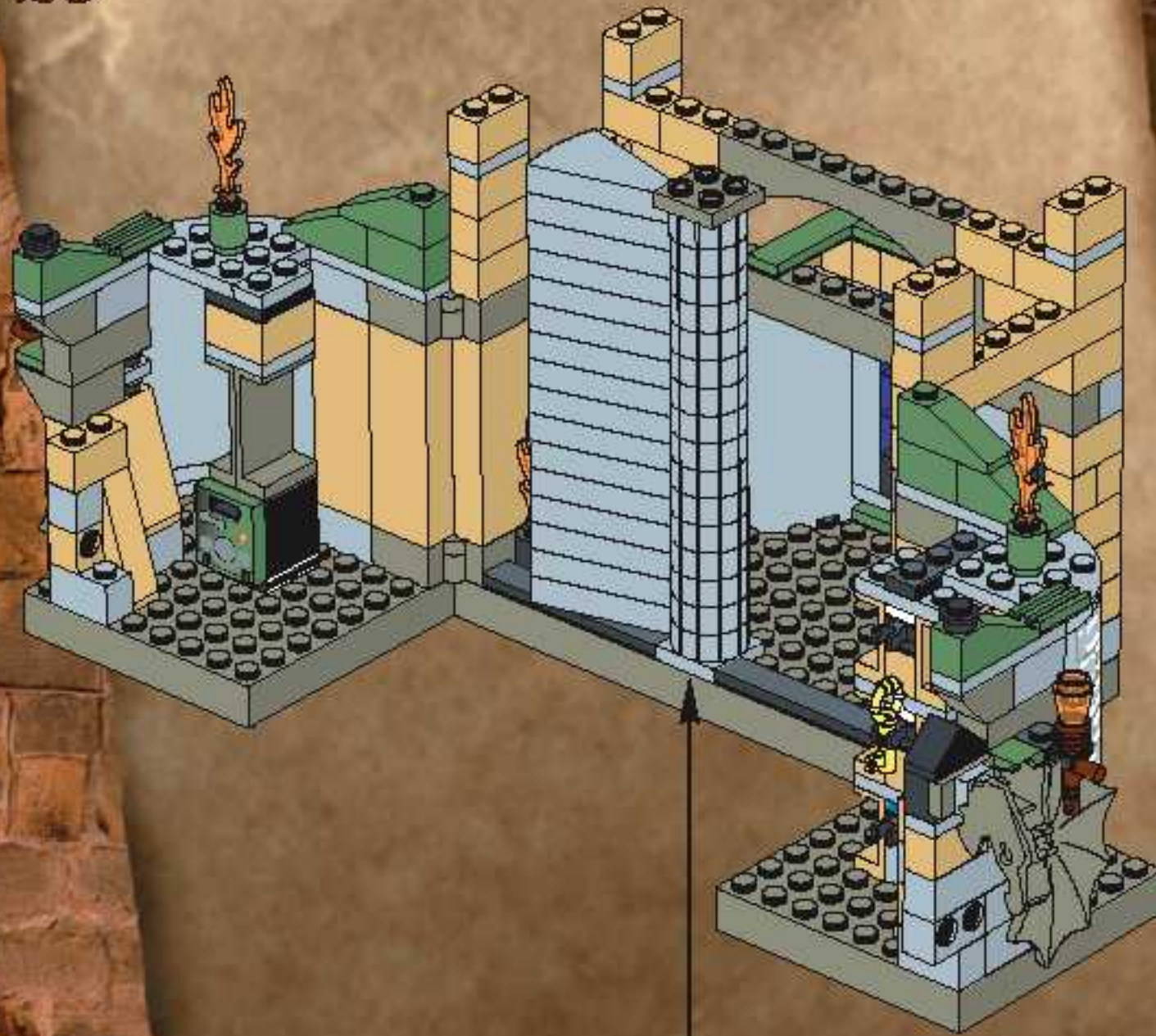

27

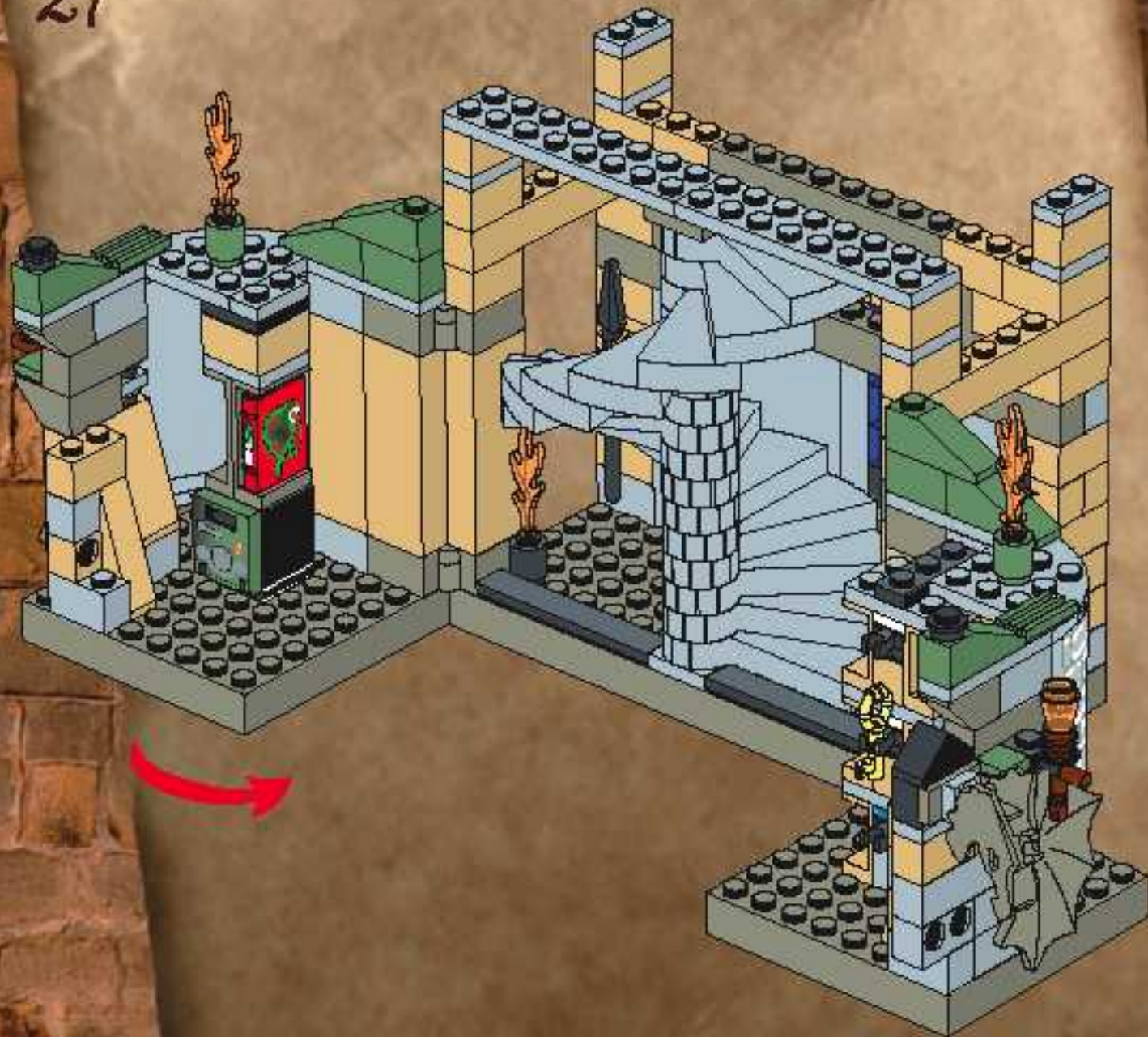

28

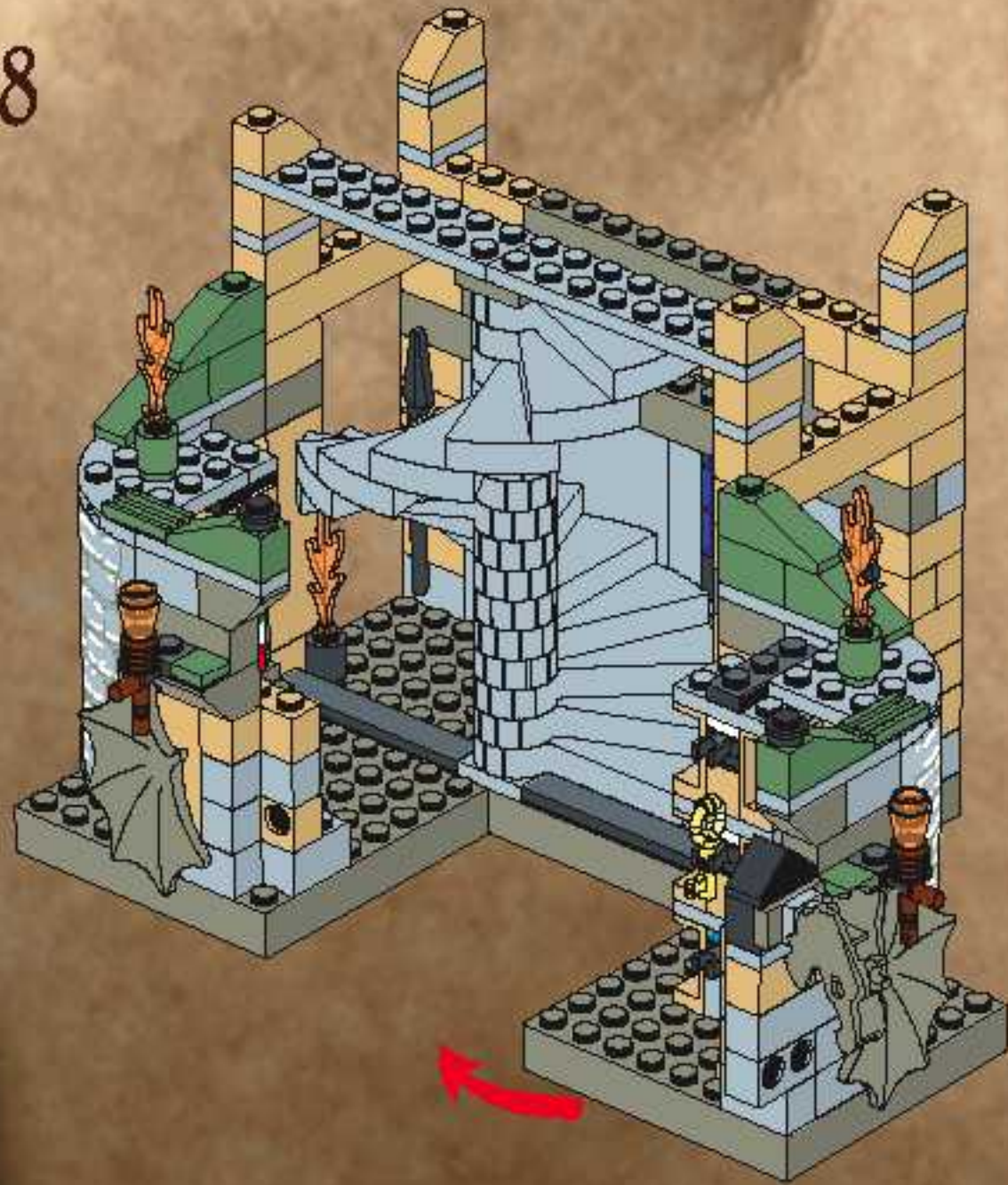

29

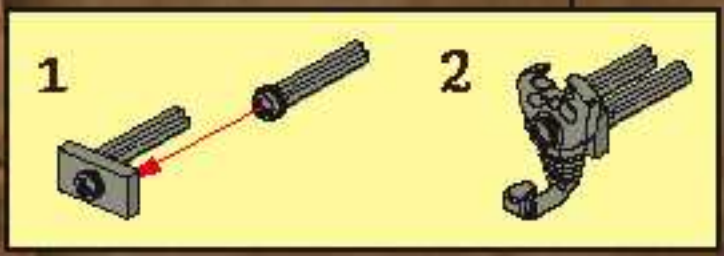

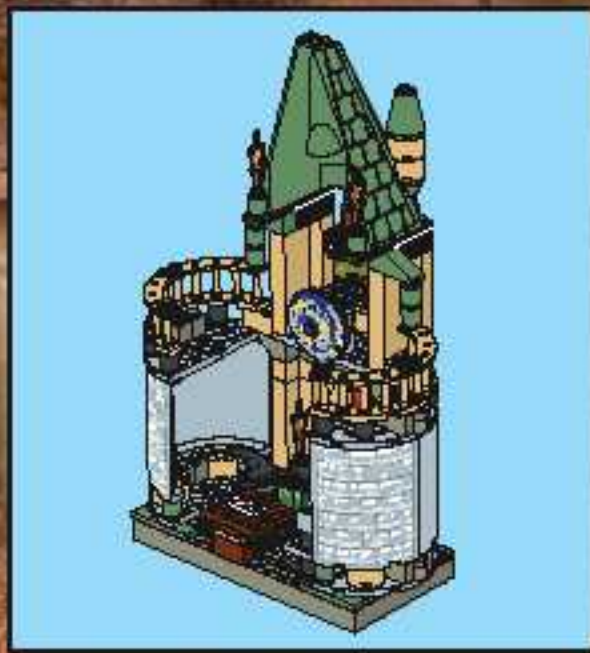

1

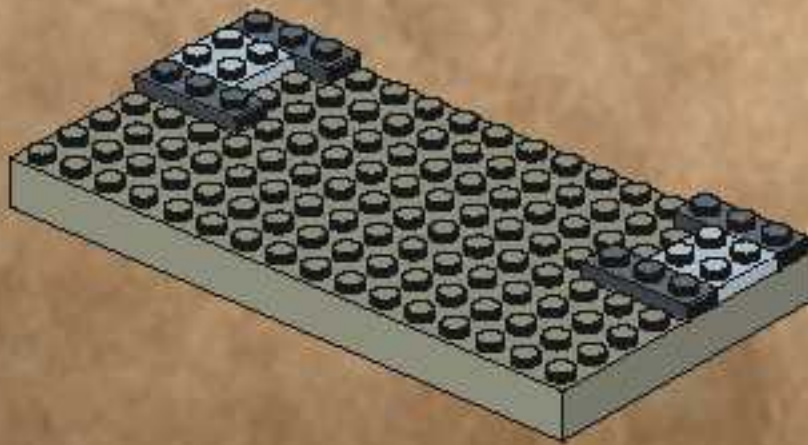

2

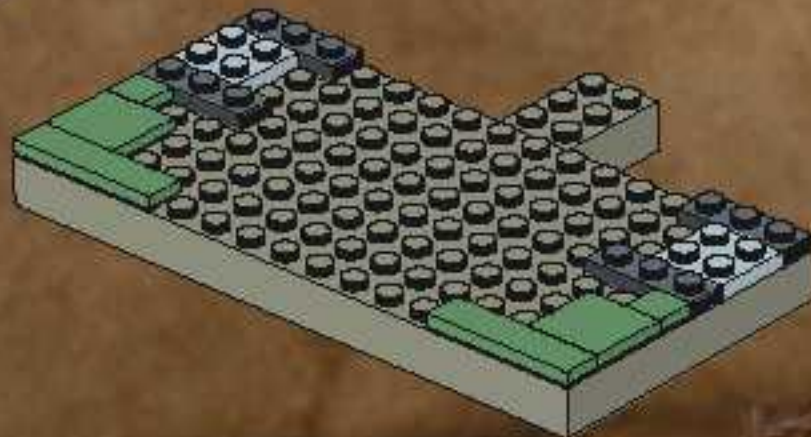

3

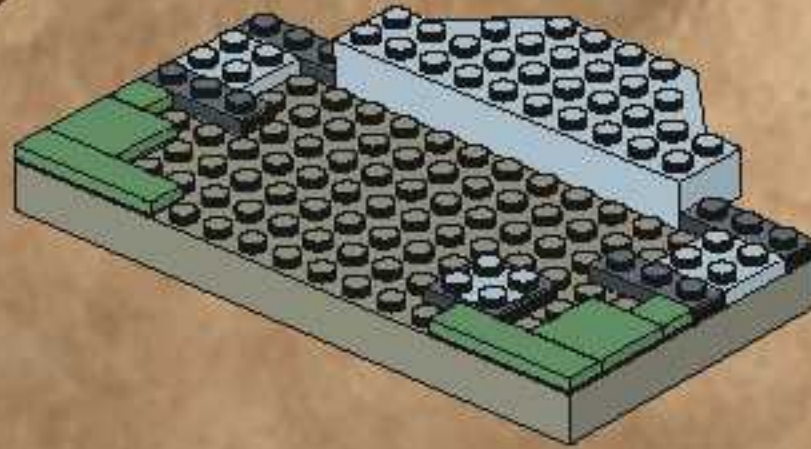

4

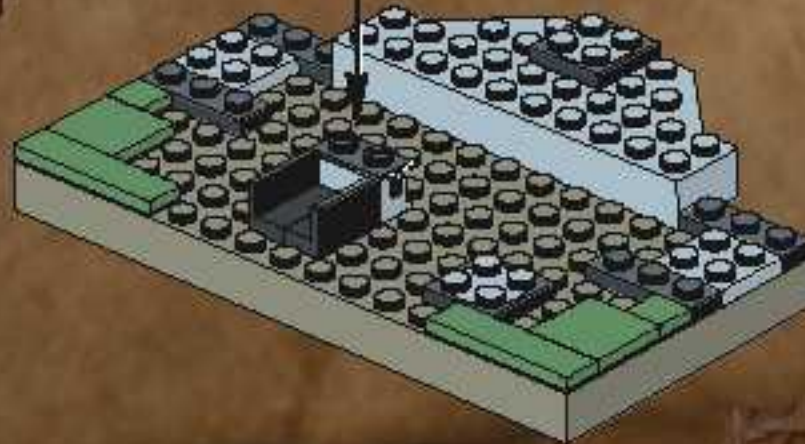

6



7

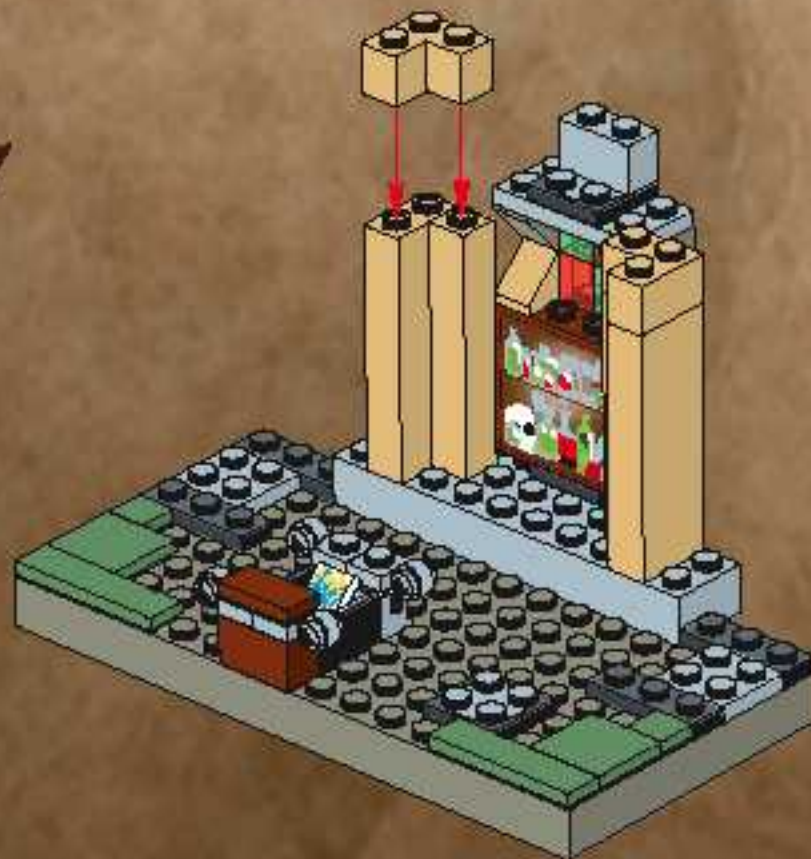

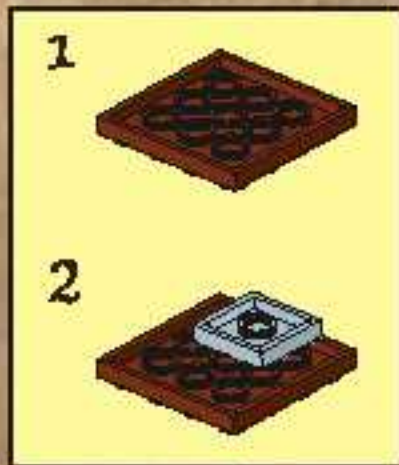

8

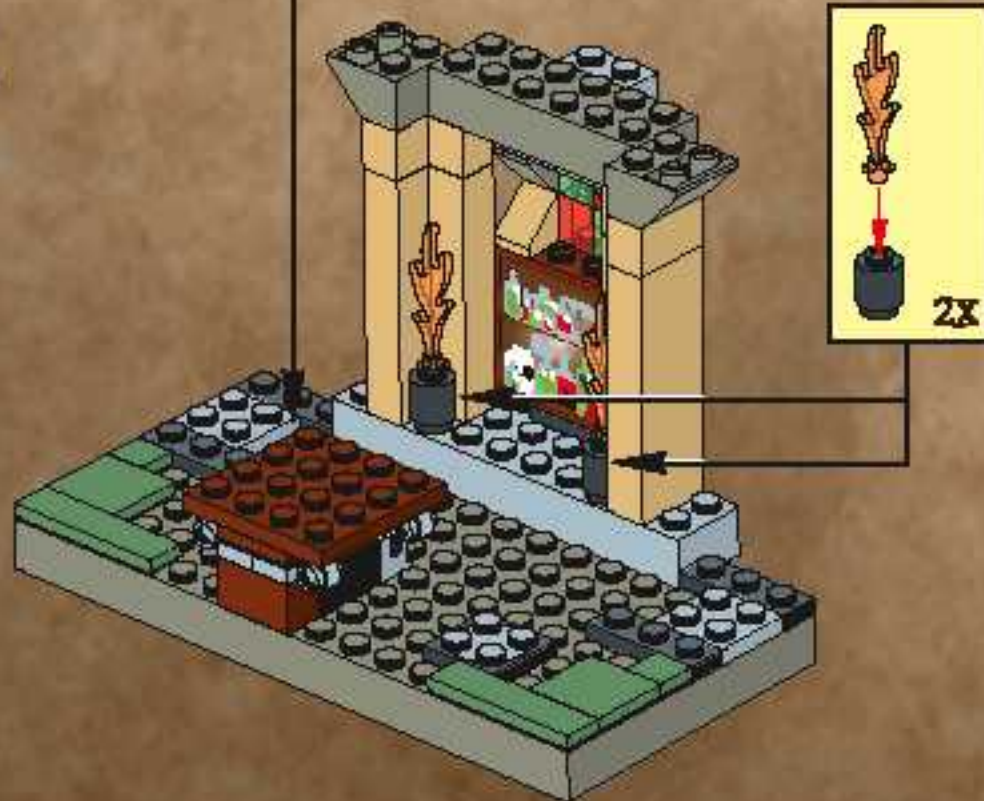

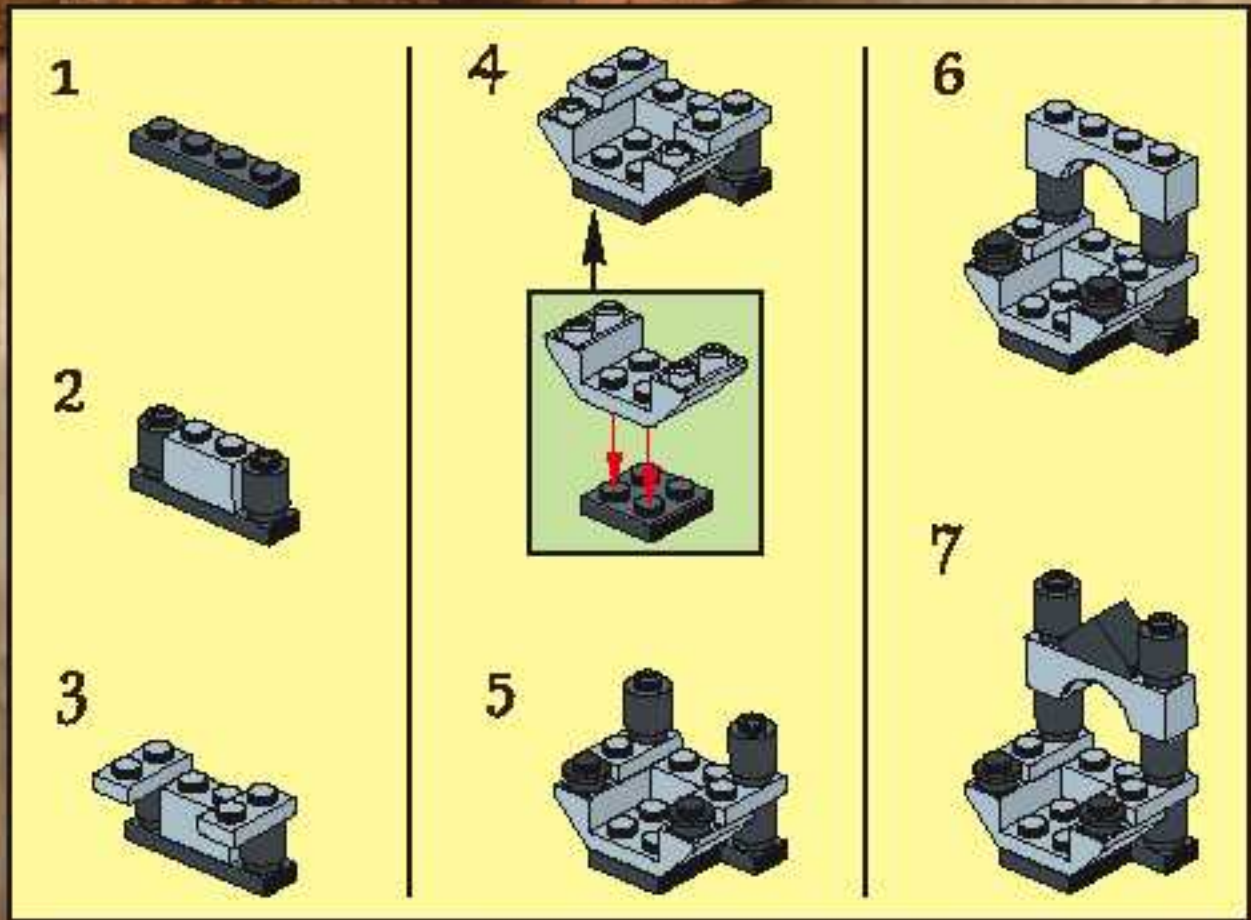

10

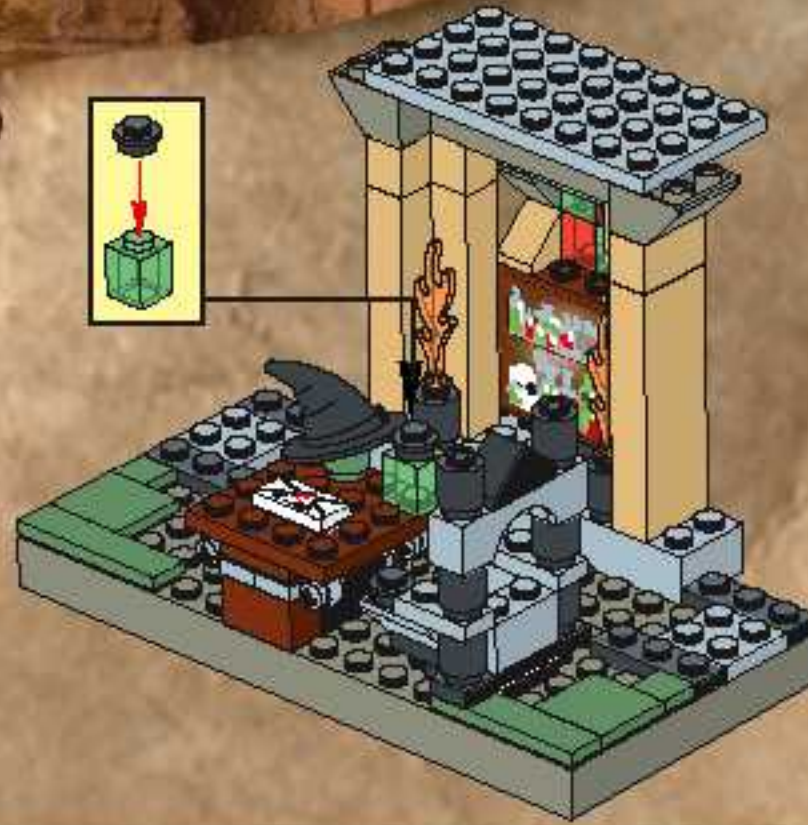
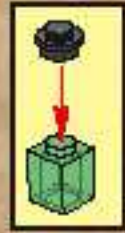

1

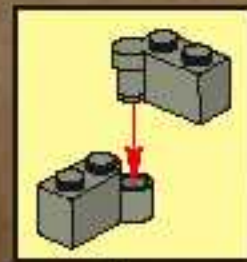

2

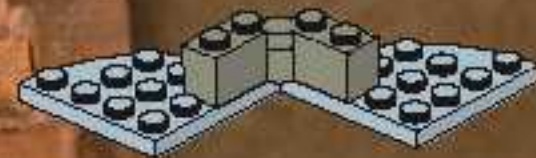

3

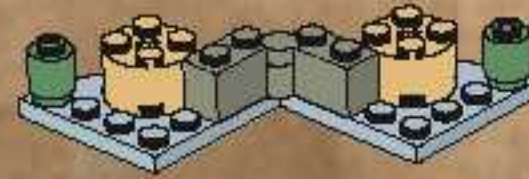

4

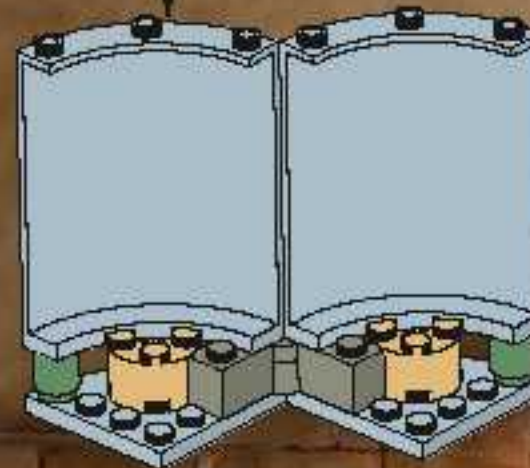

5



6

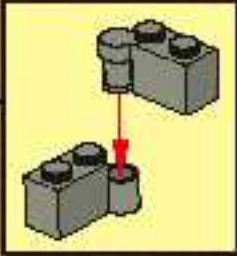
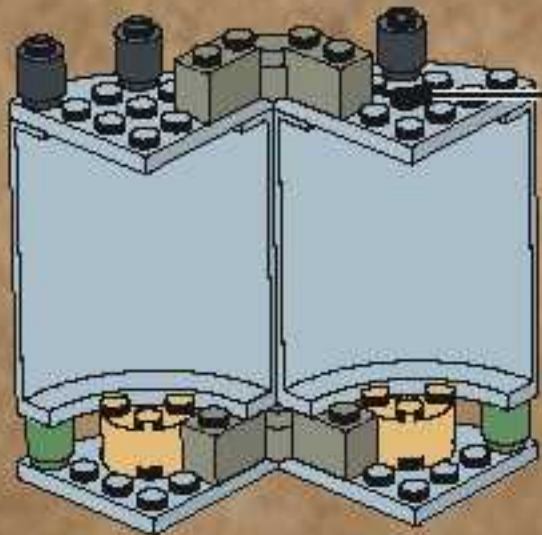

11



1



2

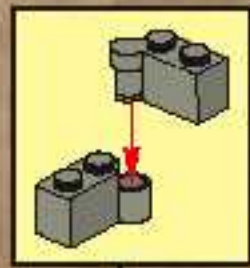

3



4

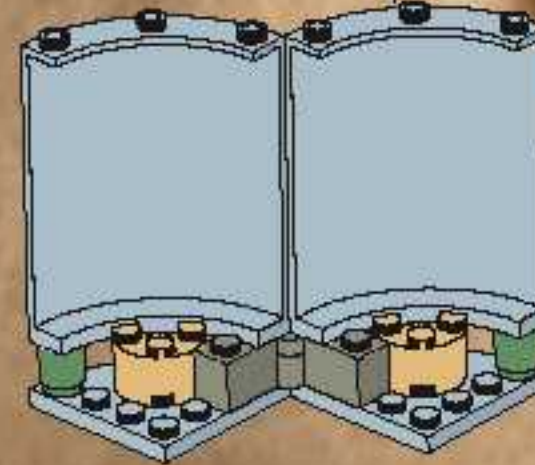

5

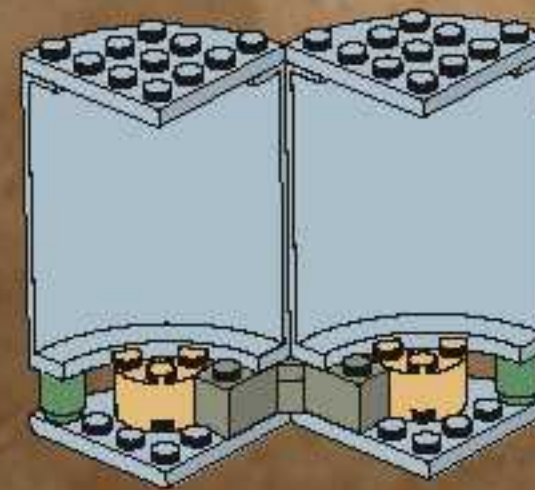

6

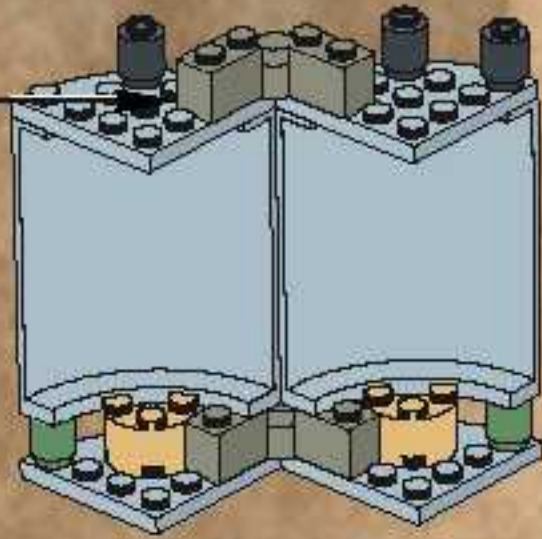
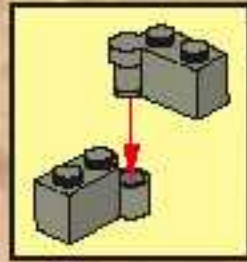

12



13

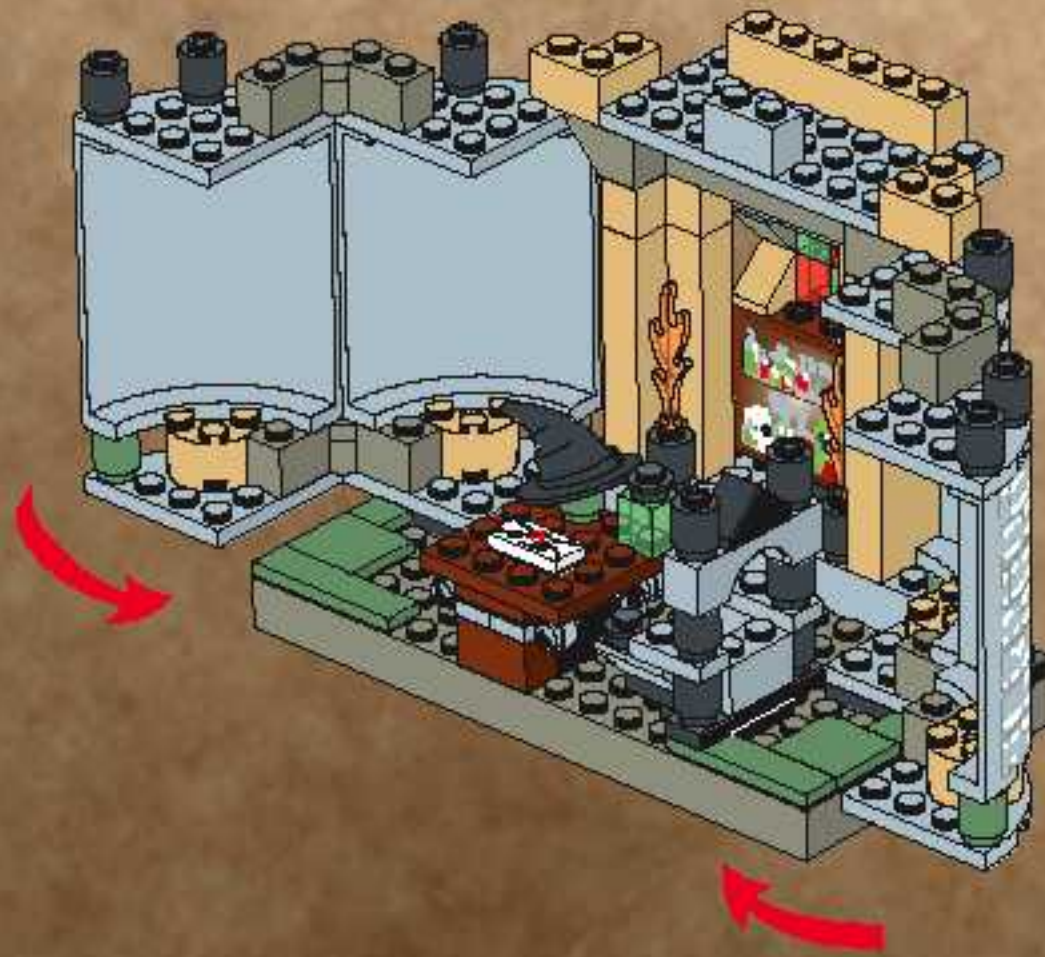

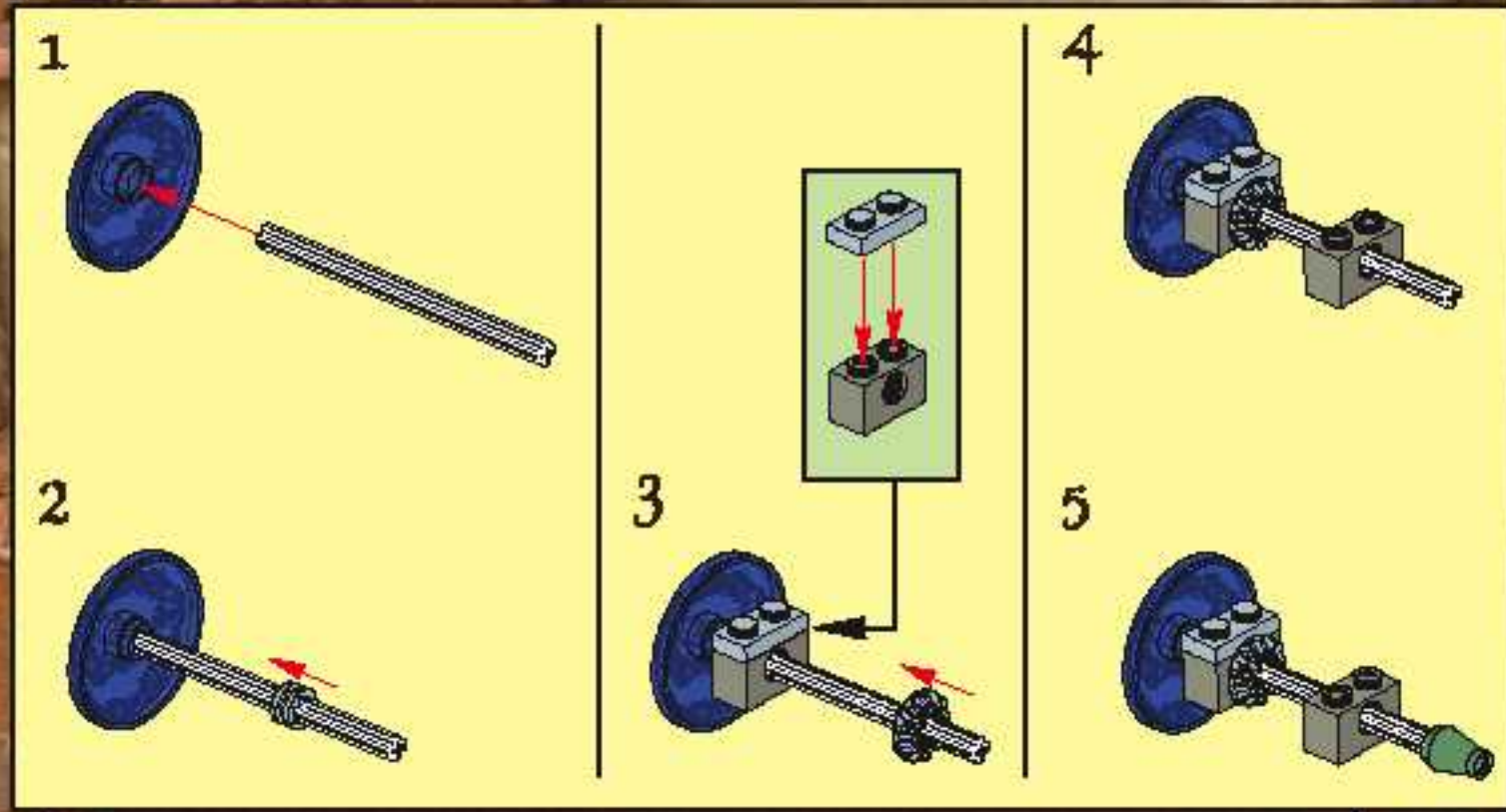

14



15

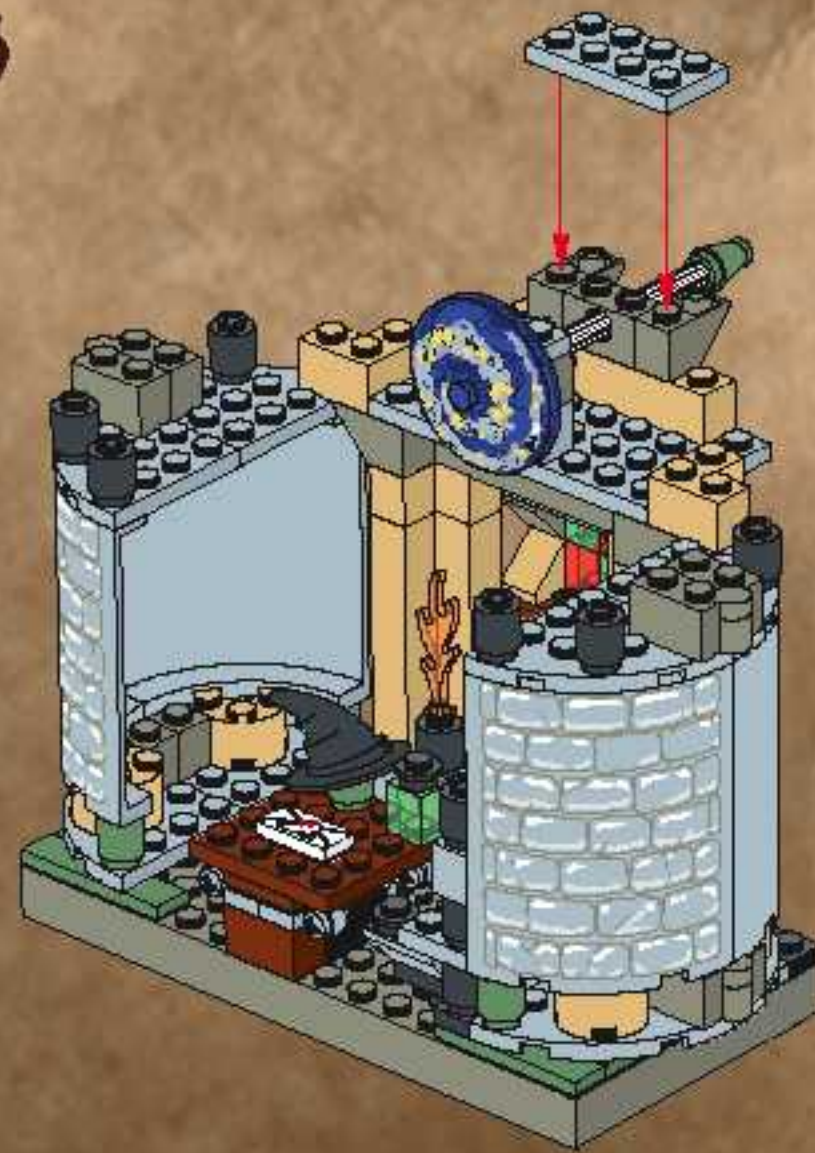

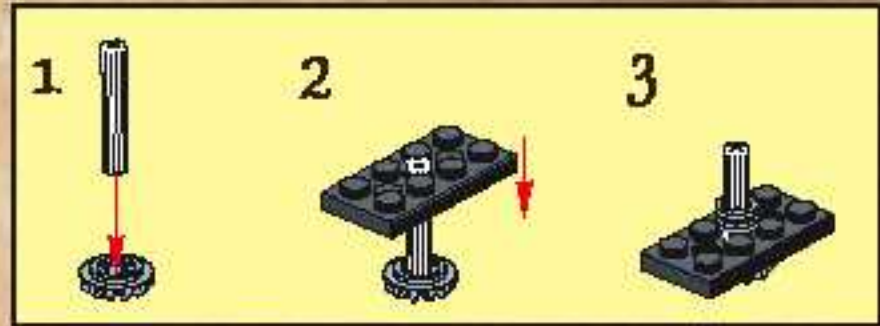

16



17

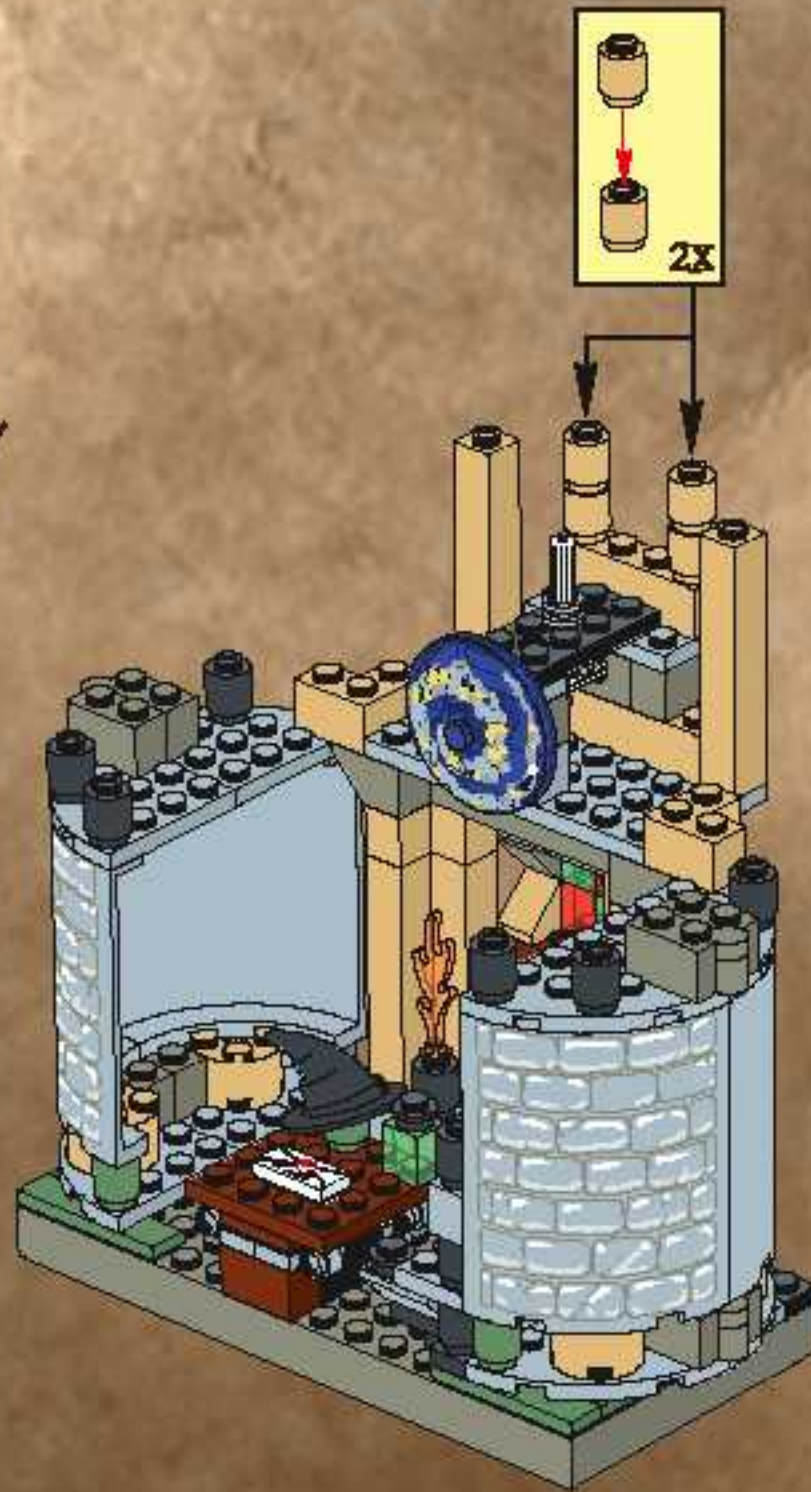

18

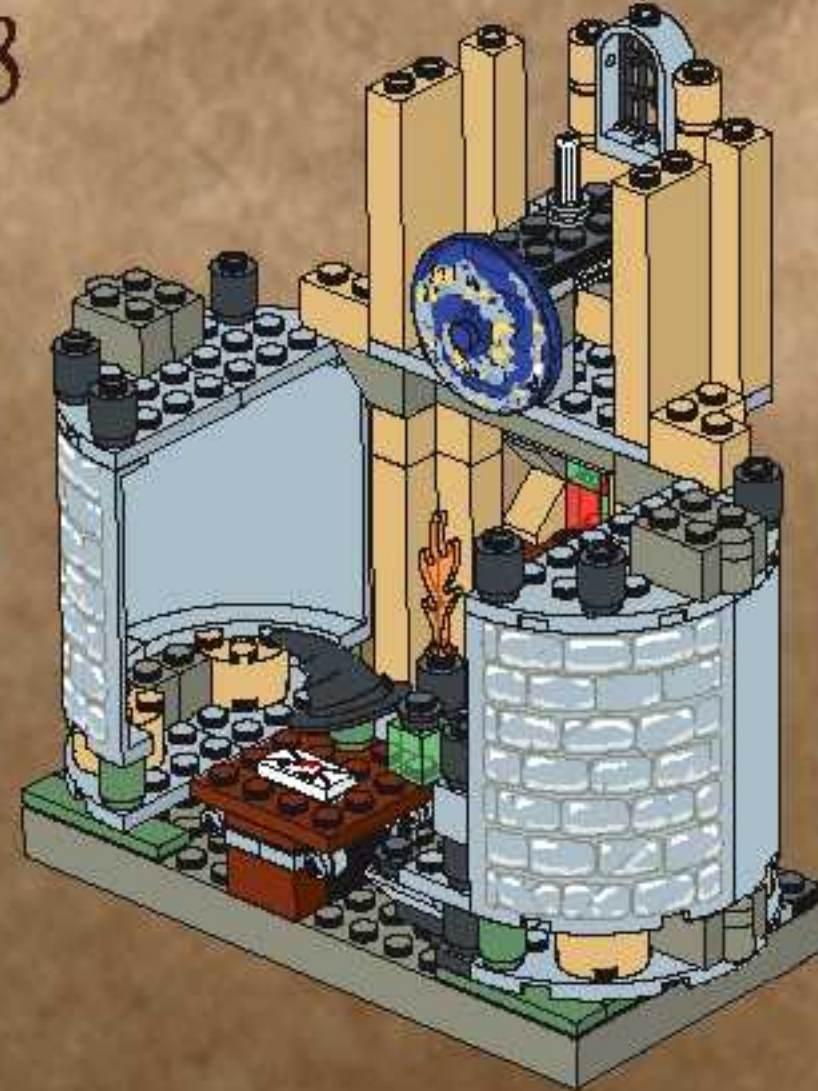

19



20

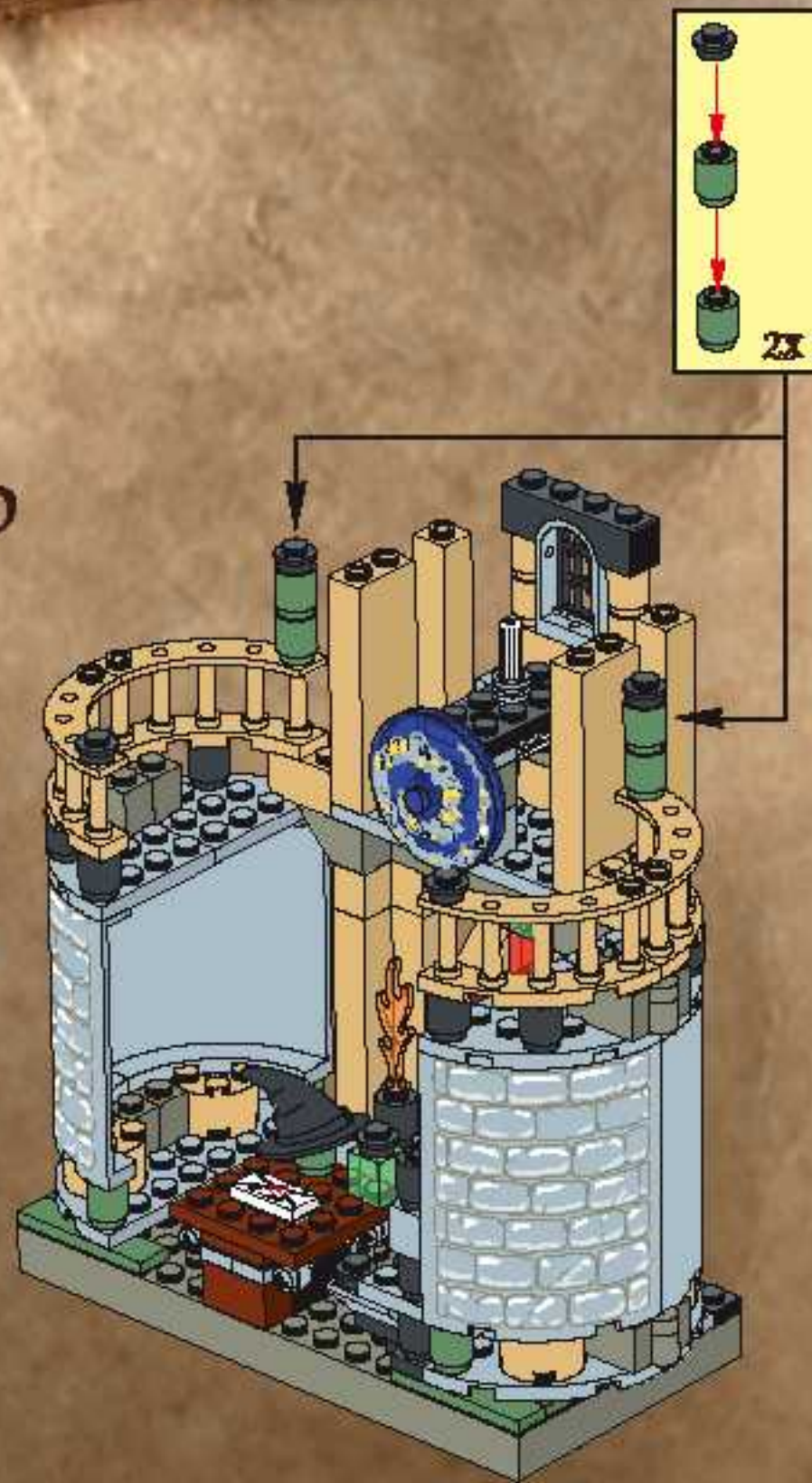

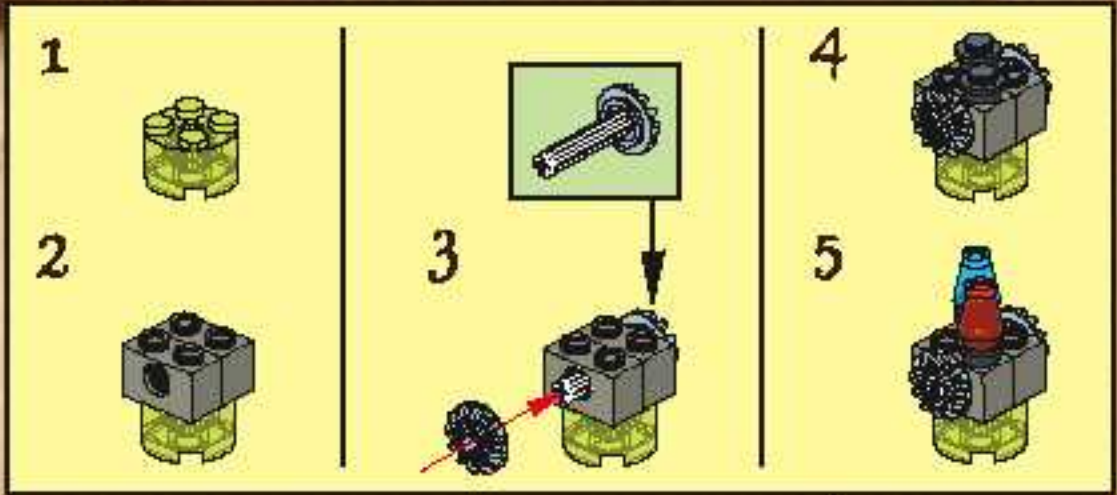

21



22

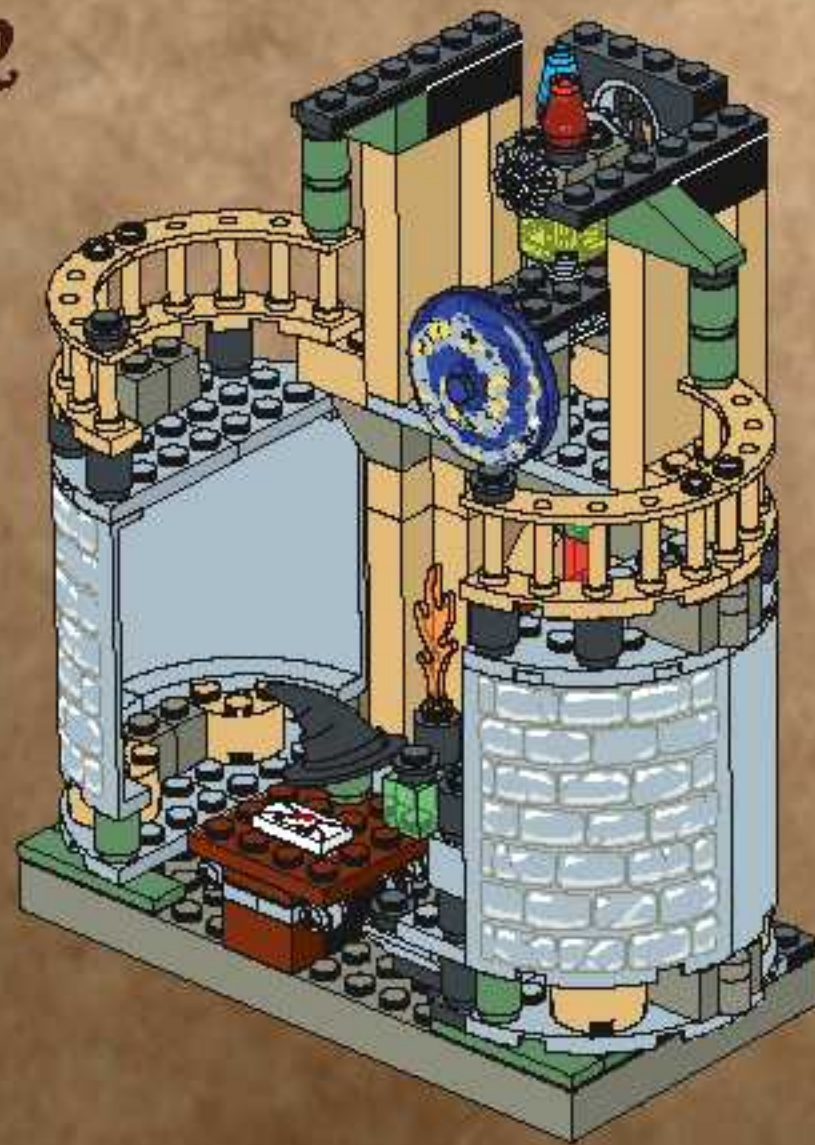

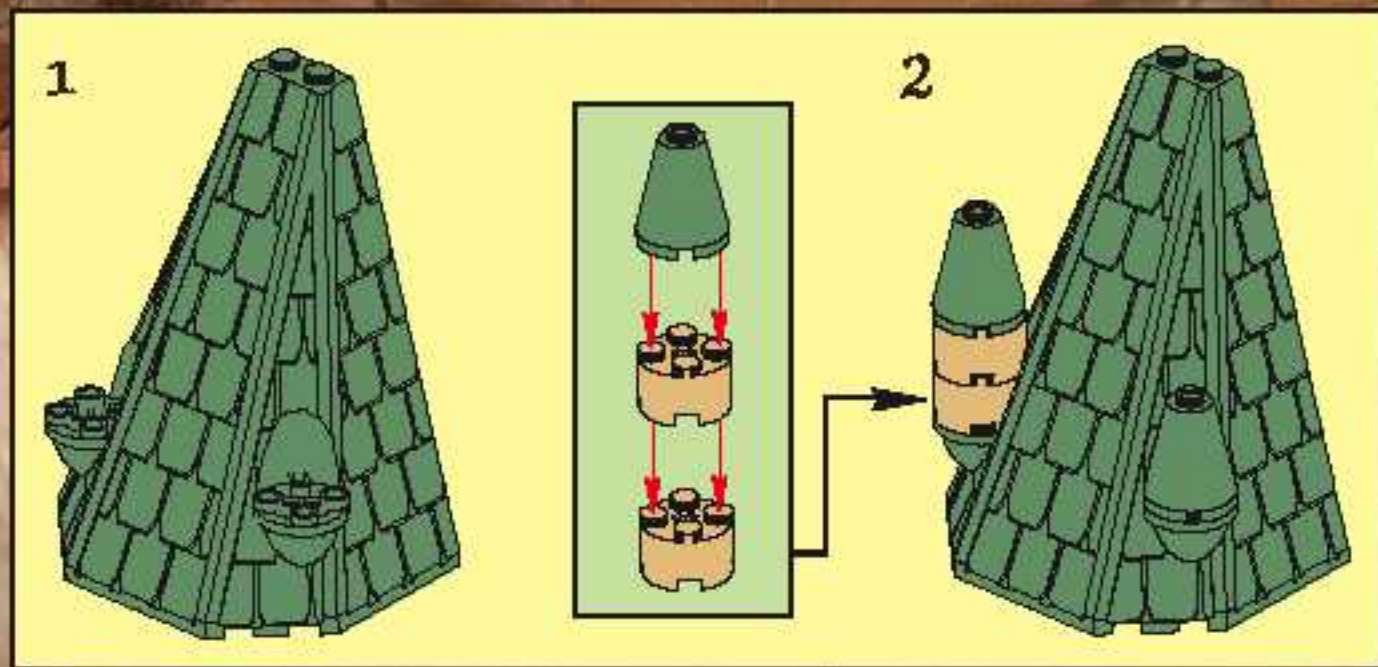

23

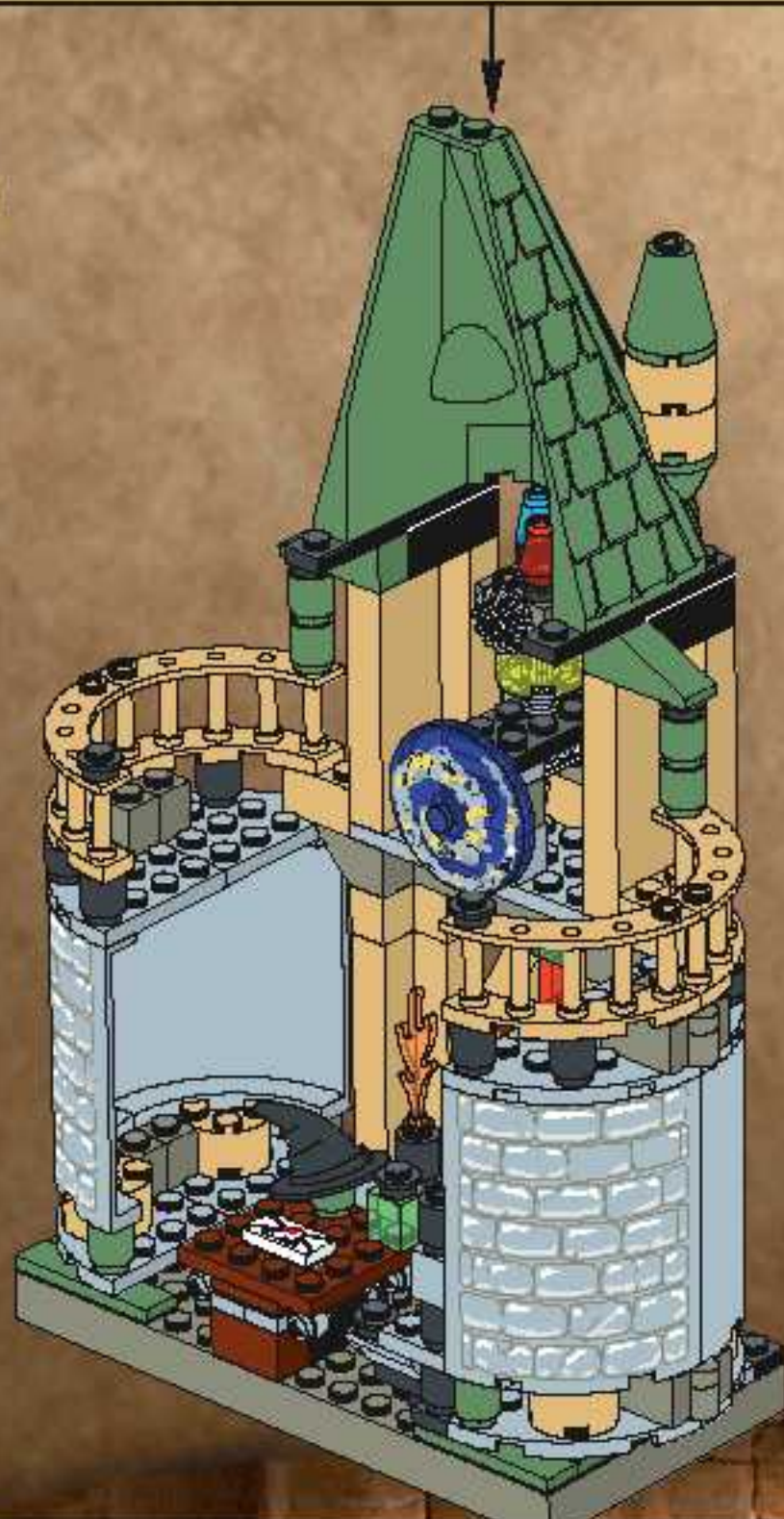

24

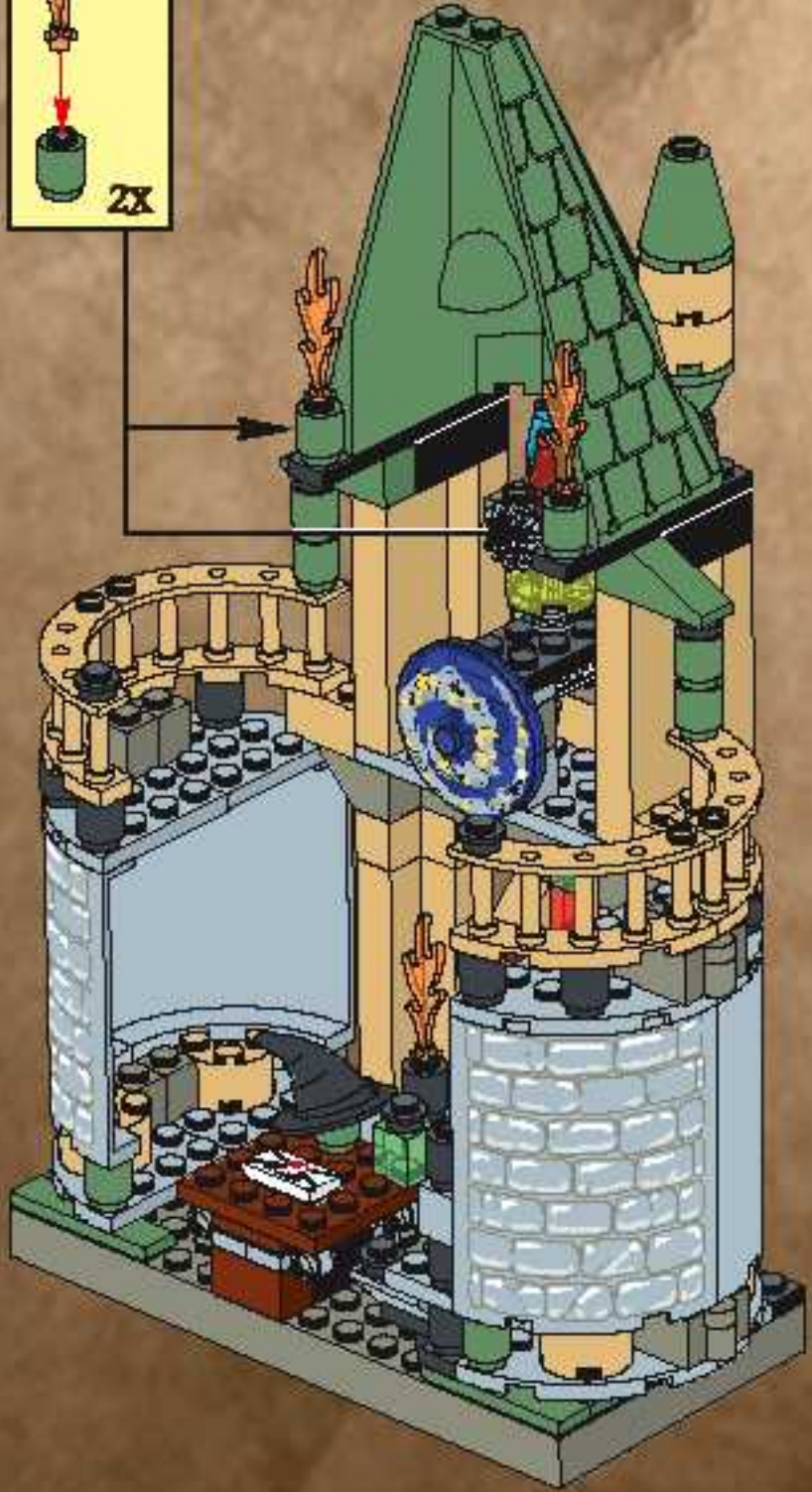

25

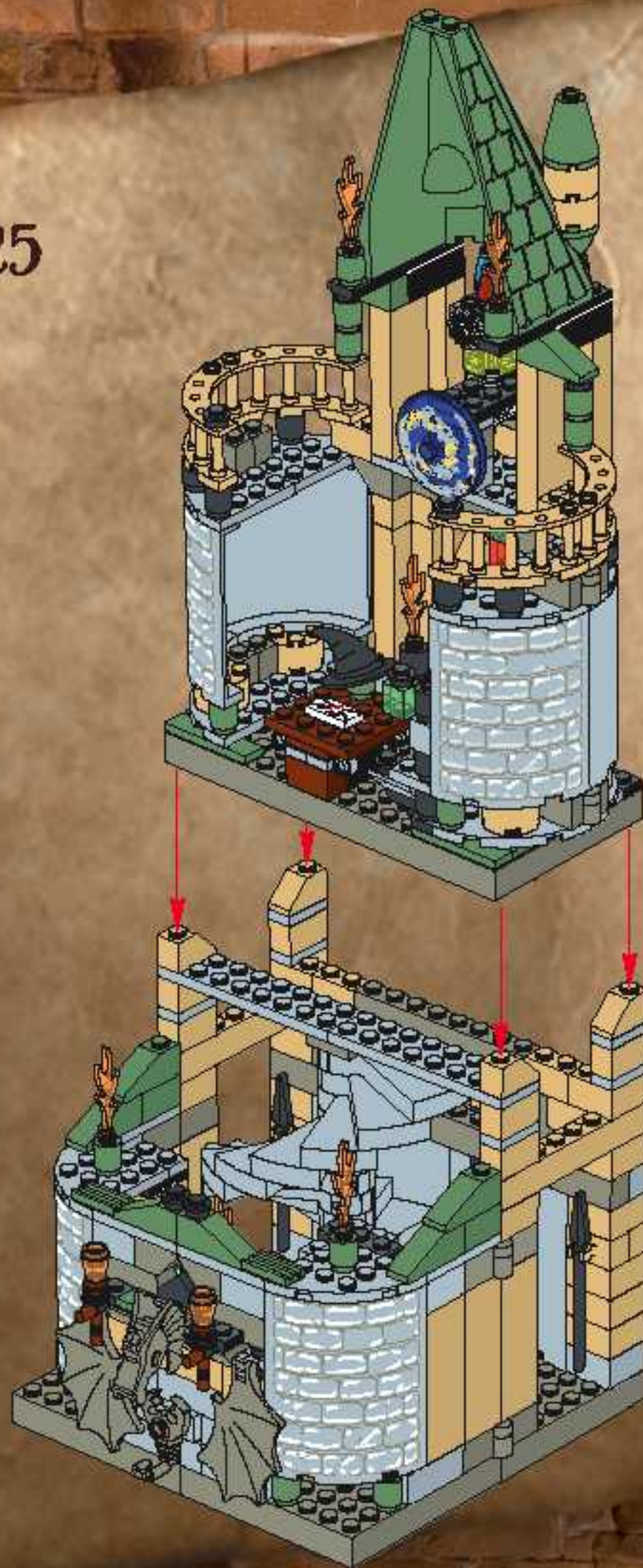

26







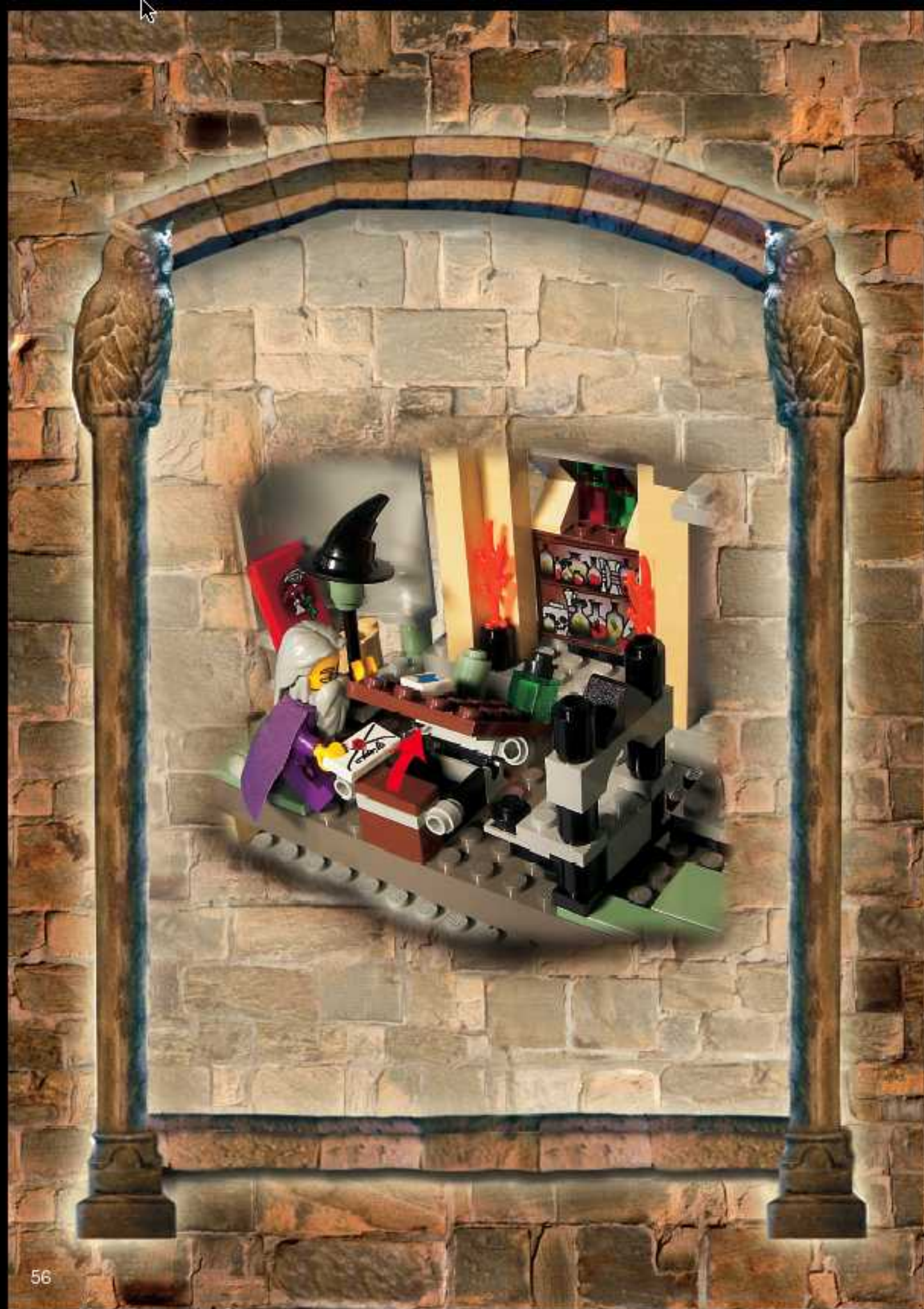



1

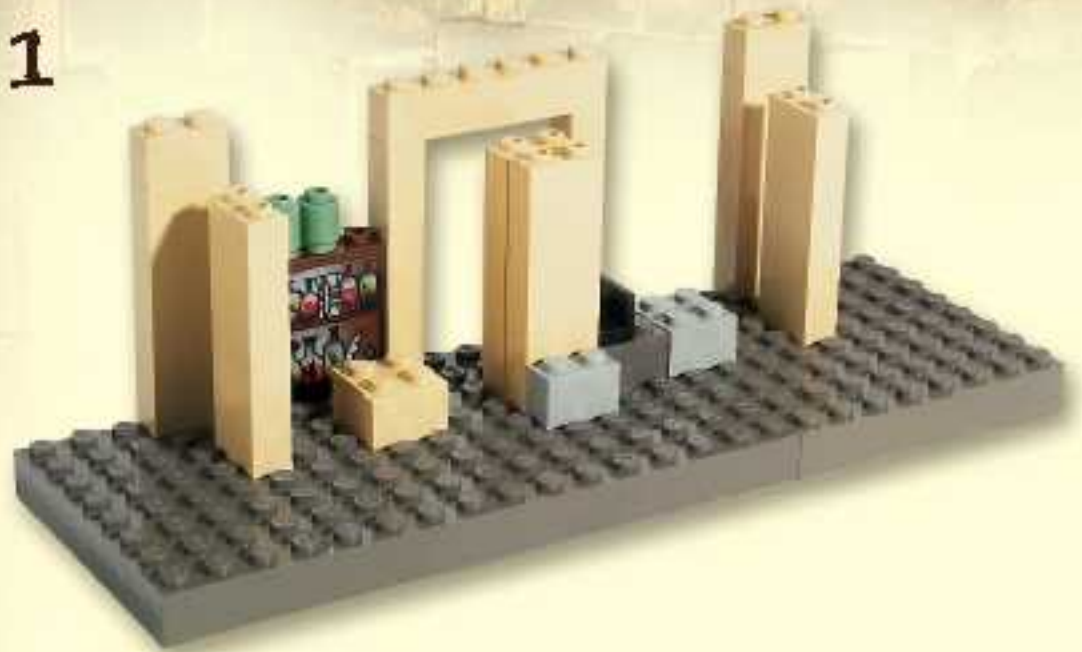

2

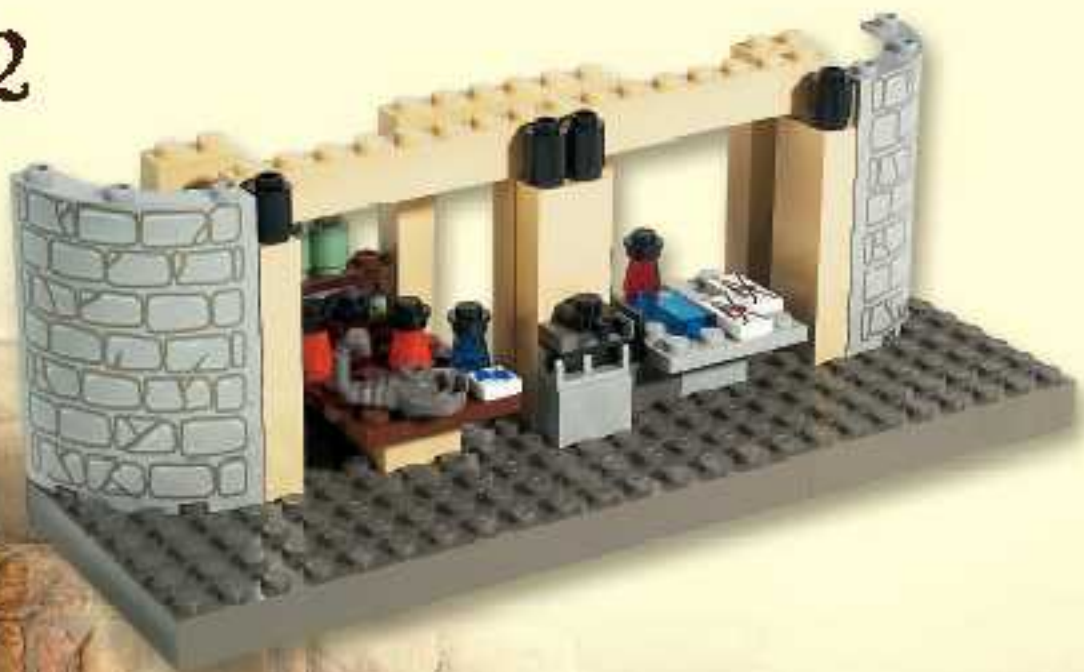

3



4



1

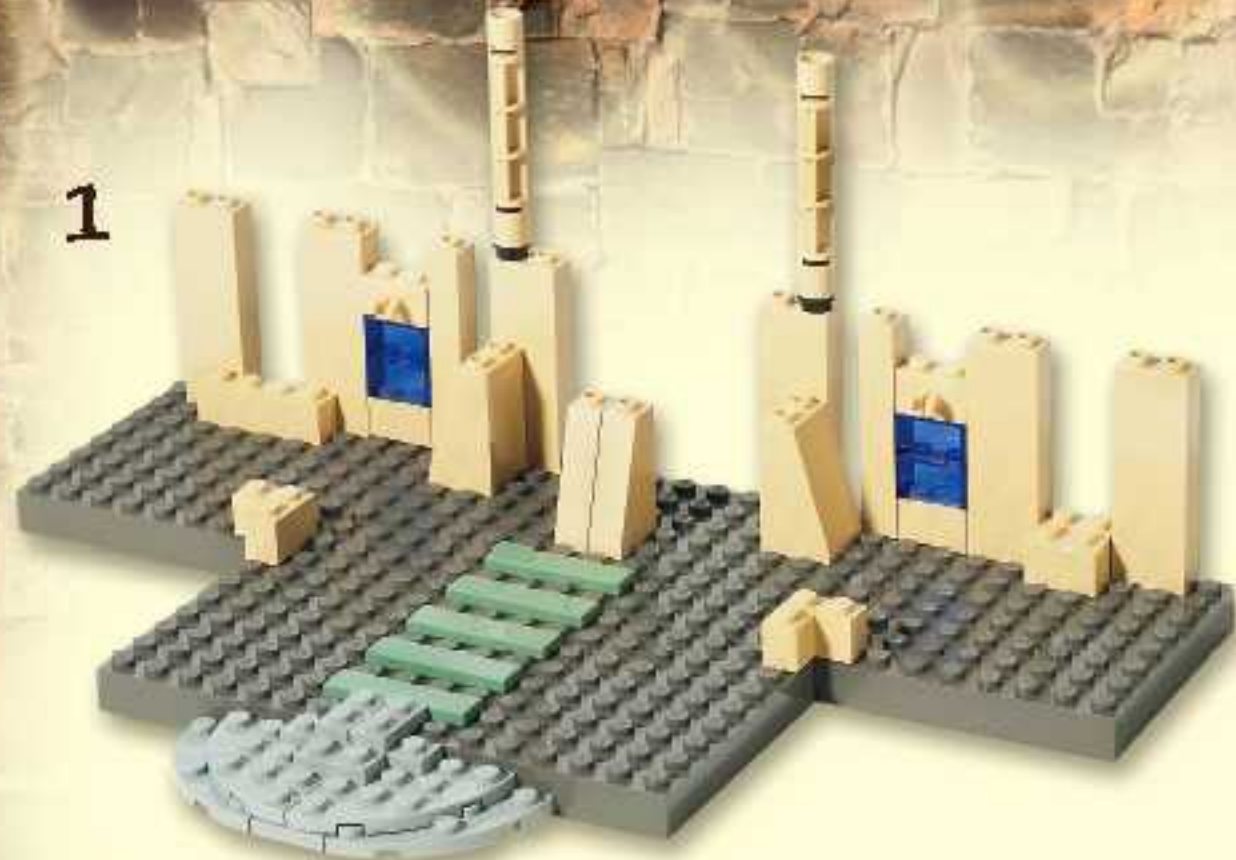

2



3



4



1



2



3



4

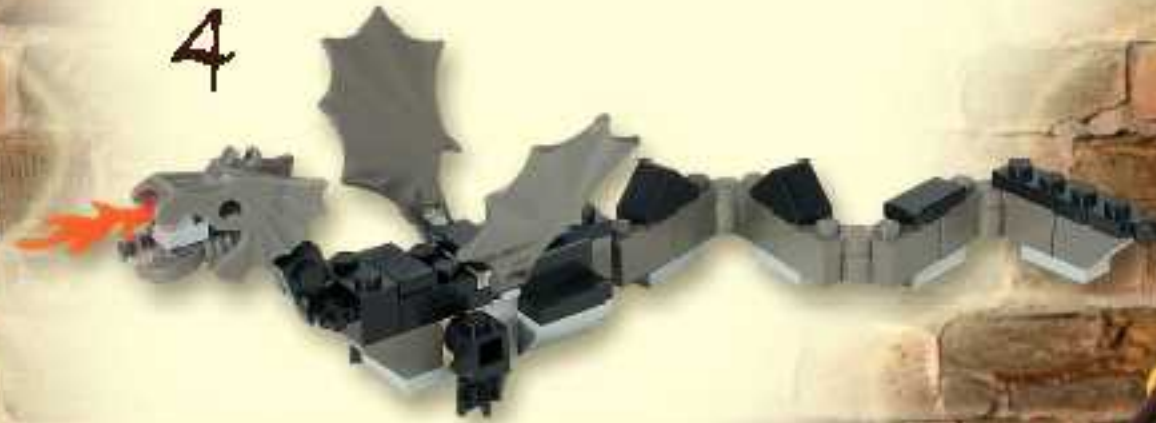



LEGO and the LEGO logo are trademarks of the LEGO Group.
© 2001 Warner Bros. Entertainment Inc. All rights reserved.
LEGO Harry Potter™ is a trademark of Warner Bros. Entertainment Inc.
LEGO Harry Potter™ is a trademark of Warner Bros. Entertainment Inc.
LEGO Harry Potter™ is a trademark of Warner Bros. Entertainment Inc.



LEGO.COM
JOIN THE FUN

www.largypuff.com



LEGO and the LEGO logo are trademarks of the LEGO Group.
© 2001 LEGO SYSTEMS A/S. All rights reserved.
LEGO, the LEGO logo, the Minifigure, and the LEGO Technic logo are trademarks of the LEGO Group.
LEGO, the LEGO logo, the Minifigure, and the LEGO Technic logo are trademarks of the LEGO Group.
LEGO, the LEGO logo, the Minifigure, and the LEGO Technic logo are trademarks of the LEGO Group.