



STAR WARS

4206866

4491

MINI BUILDING SET

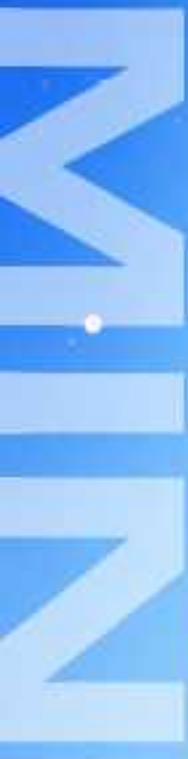

MTT™

4/4



LEGO

**STAR
WARS™**

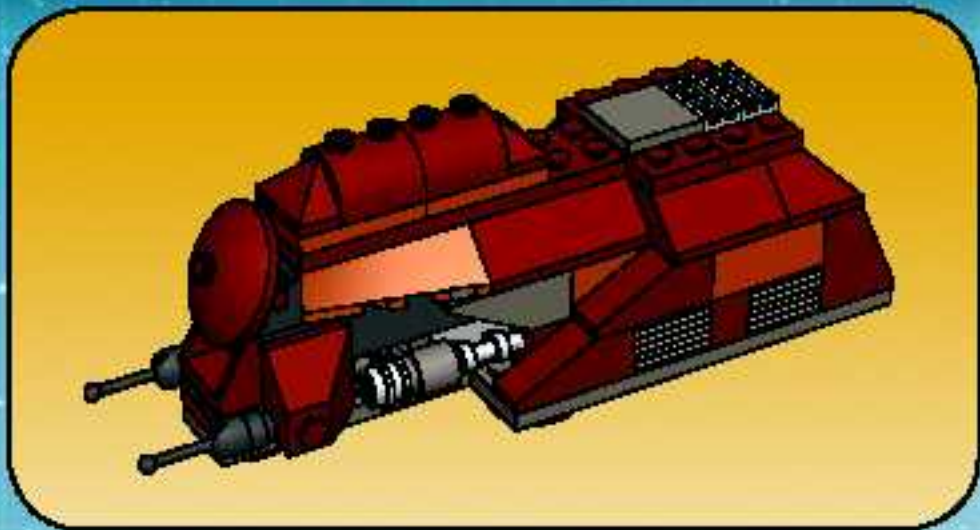

1

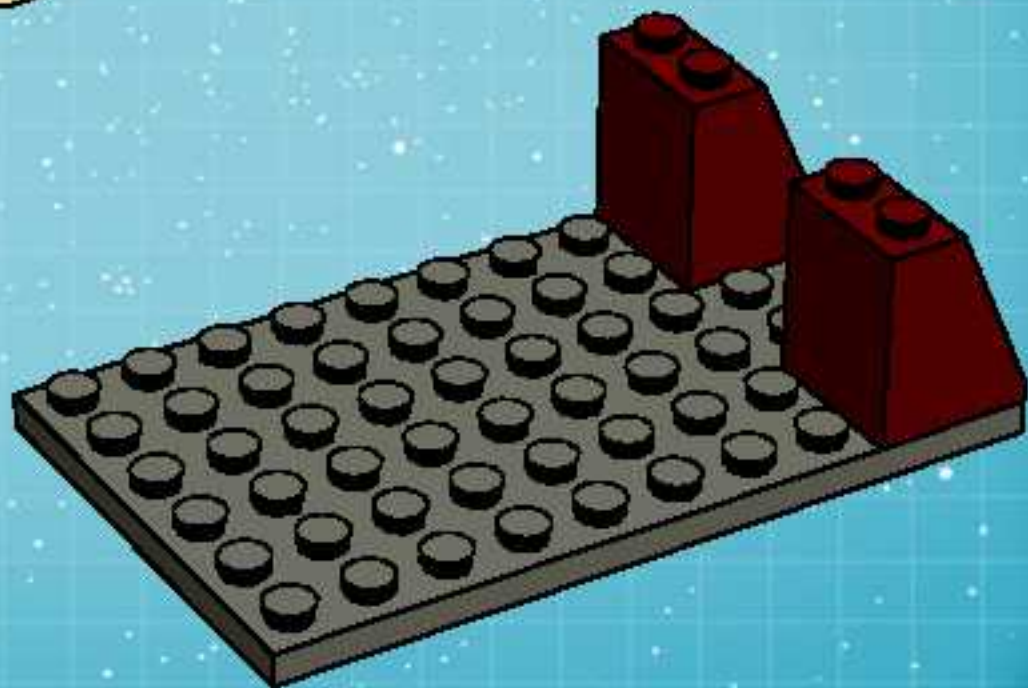

1

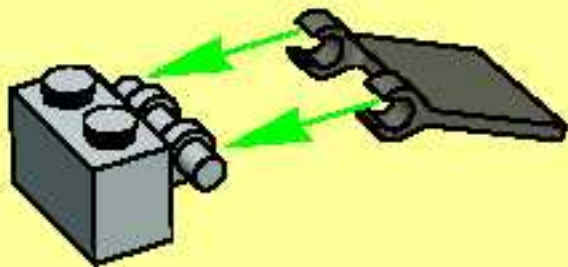

2

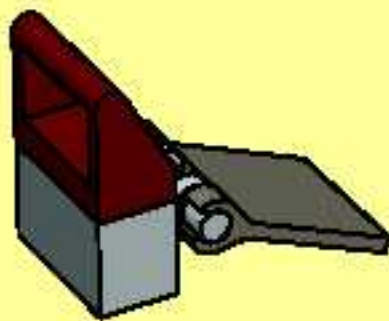

2

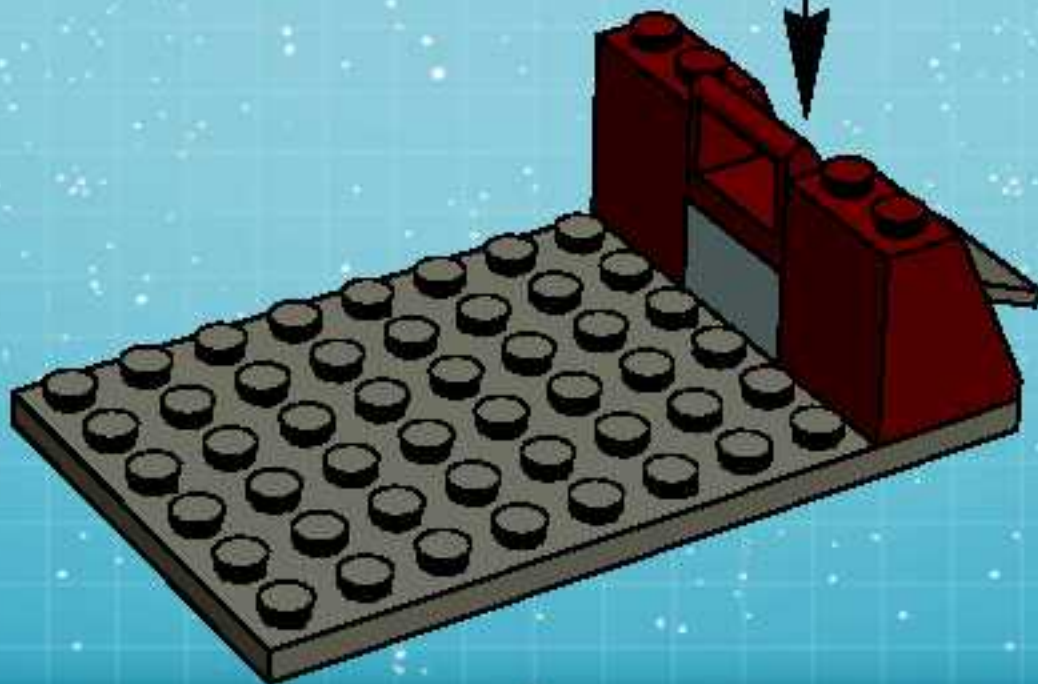

3

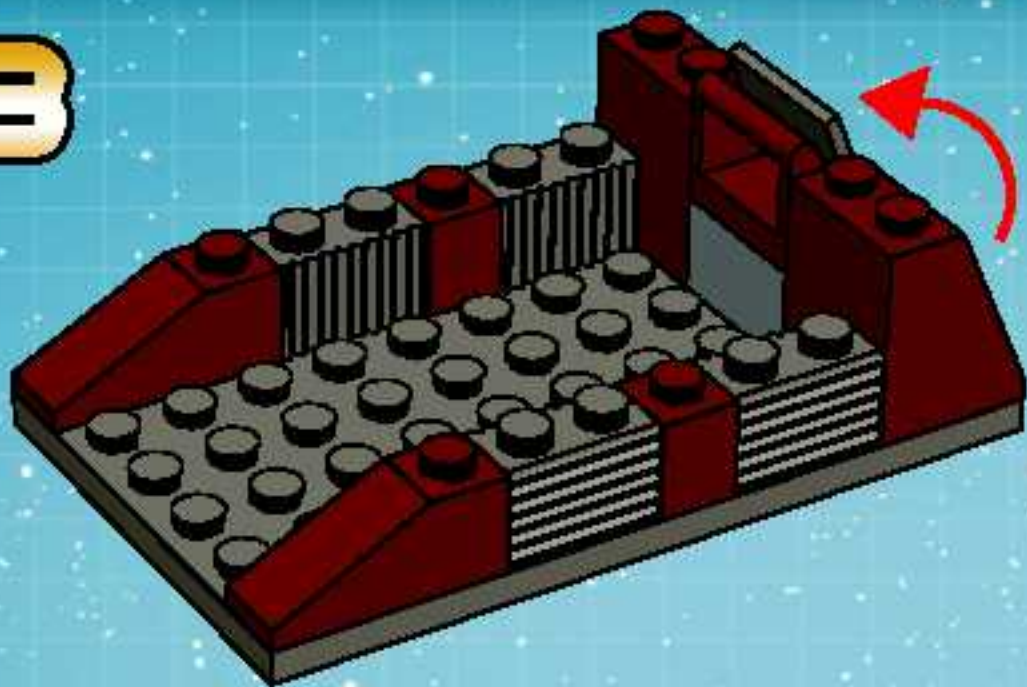

4

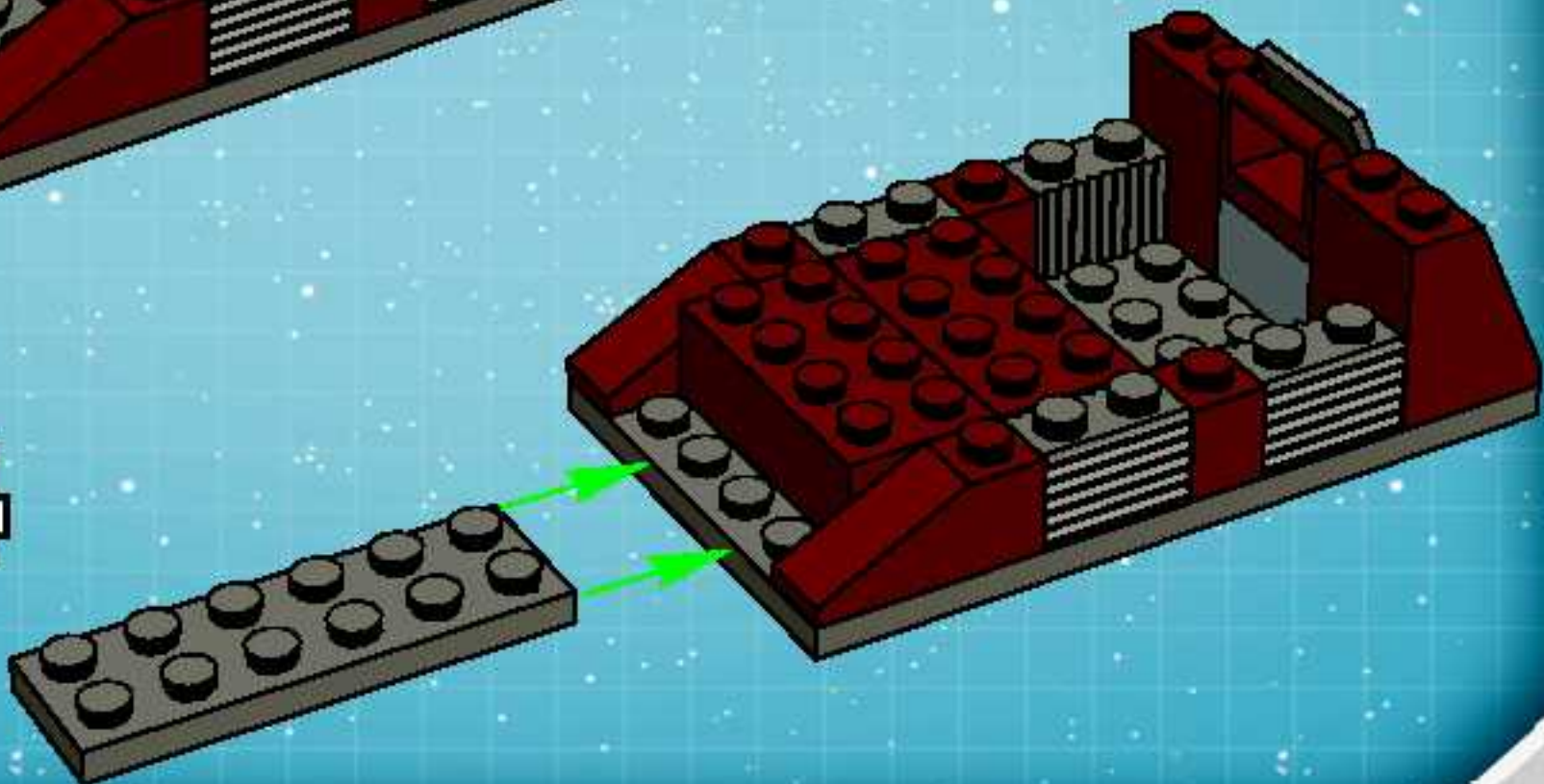

1



2

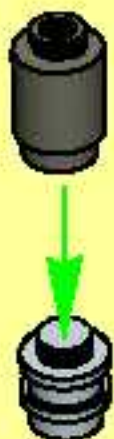

2x

6

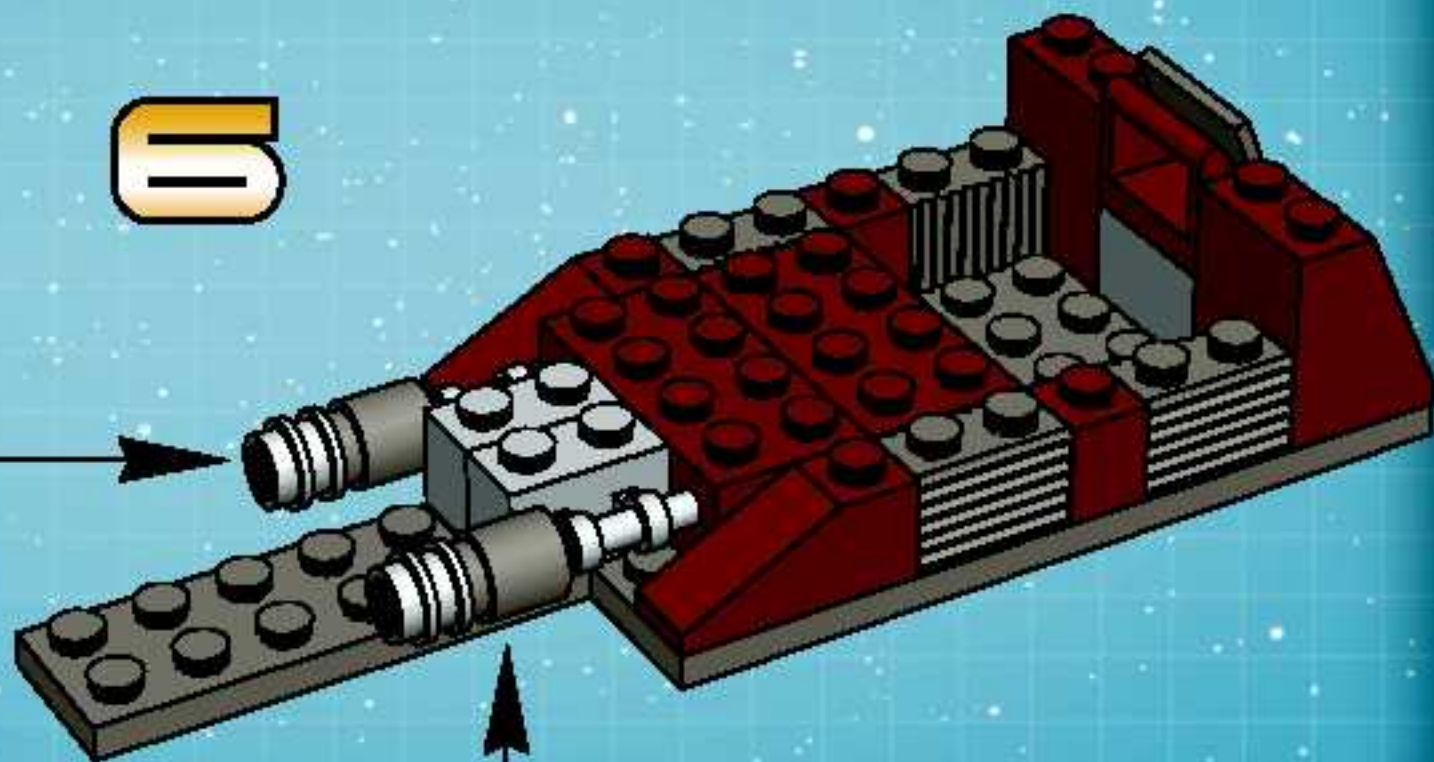

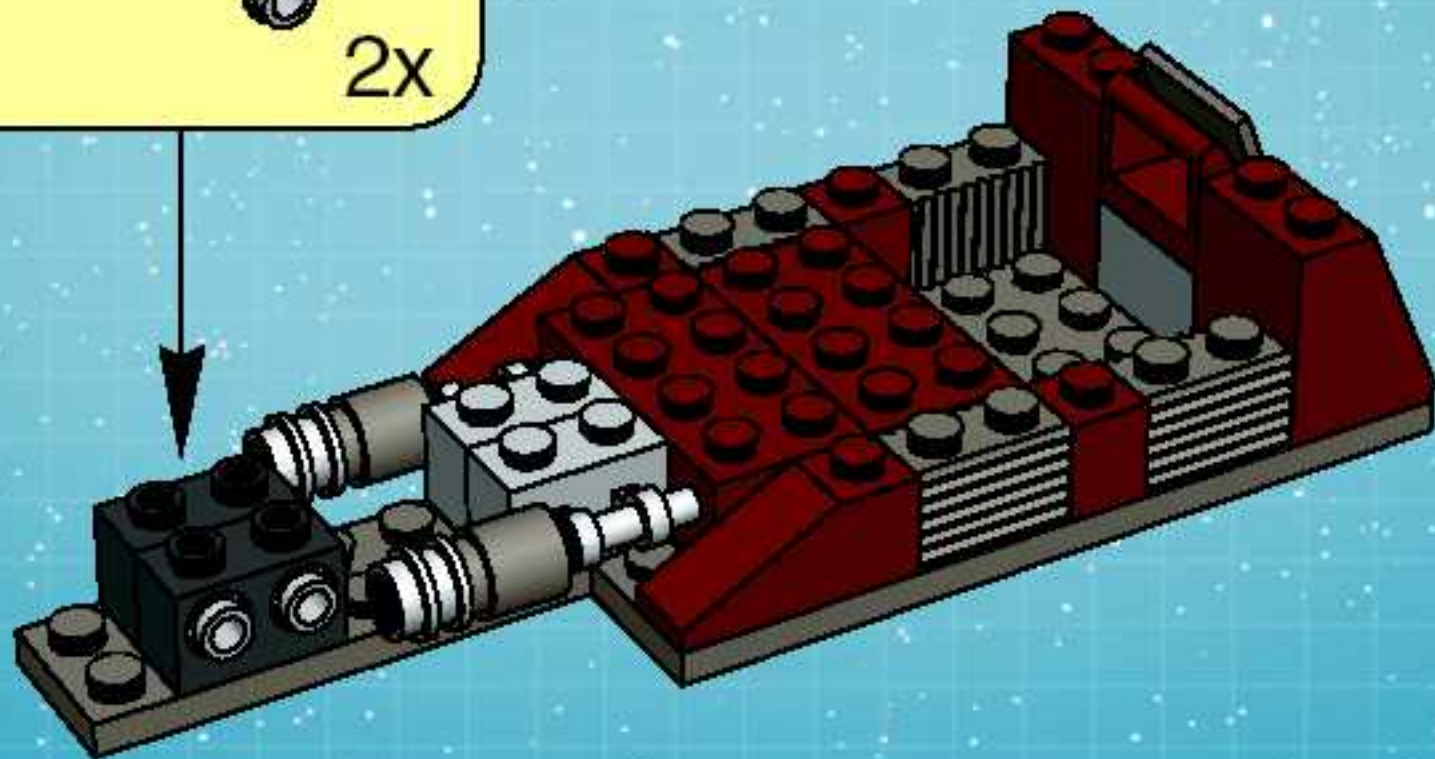
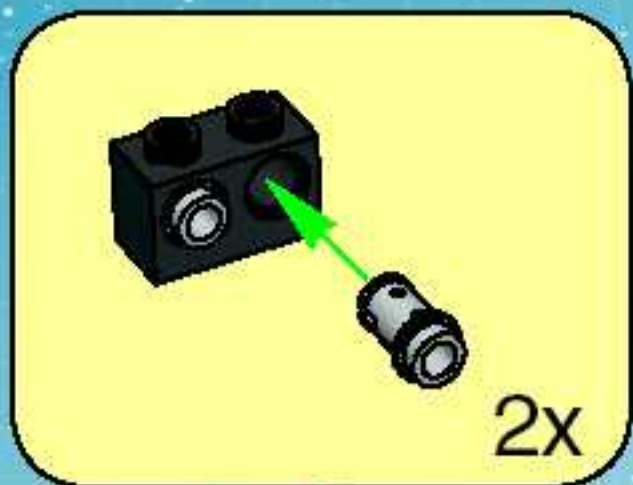

1



3



2



4

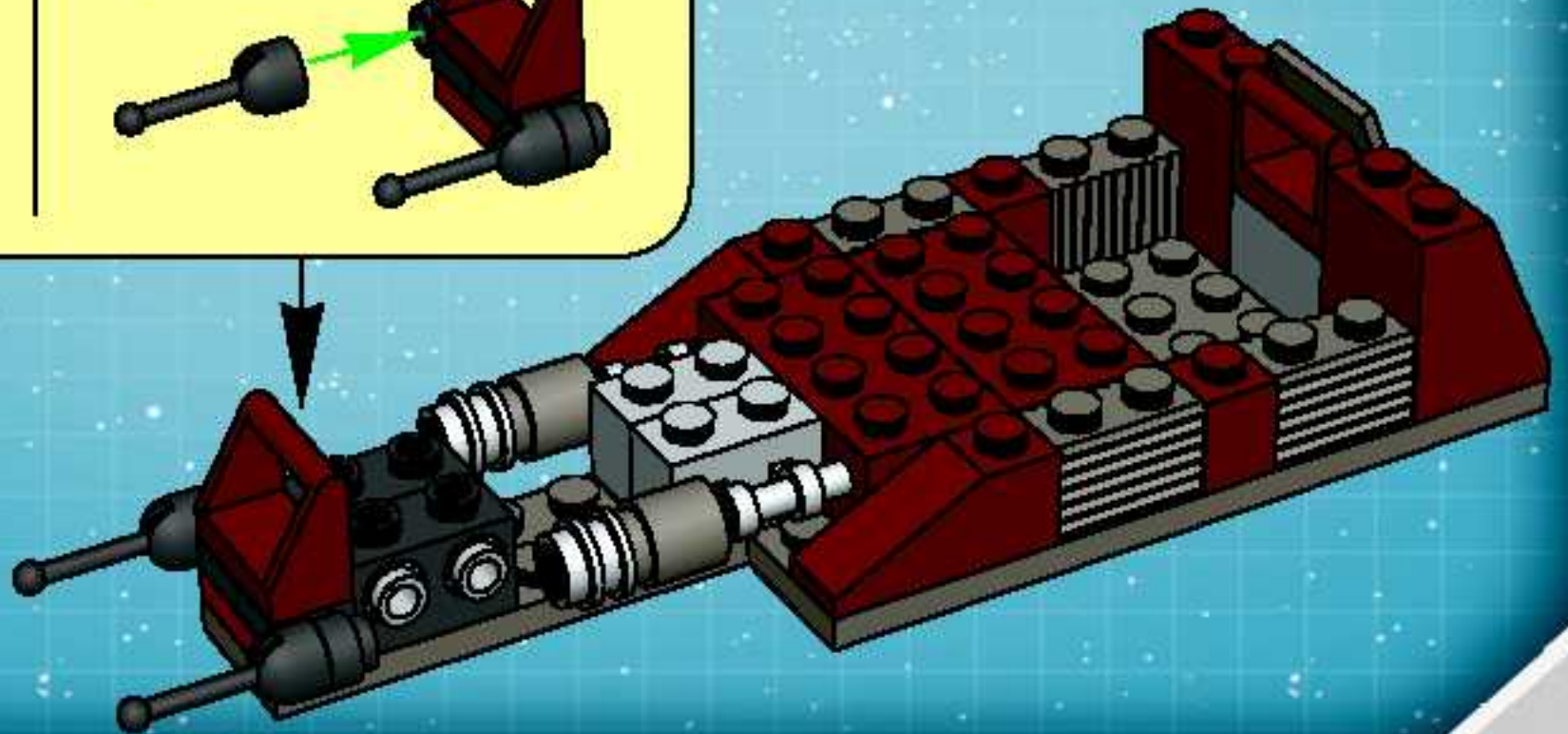
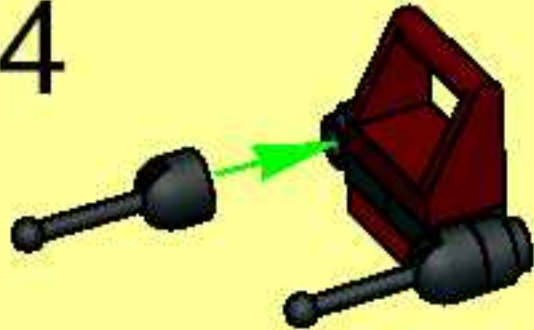

19

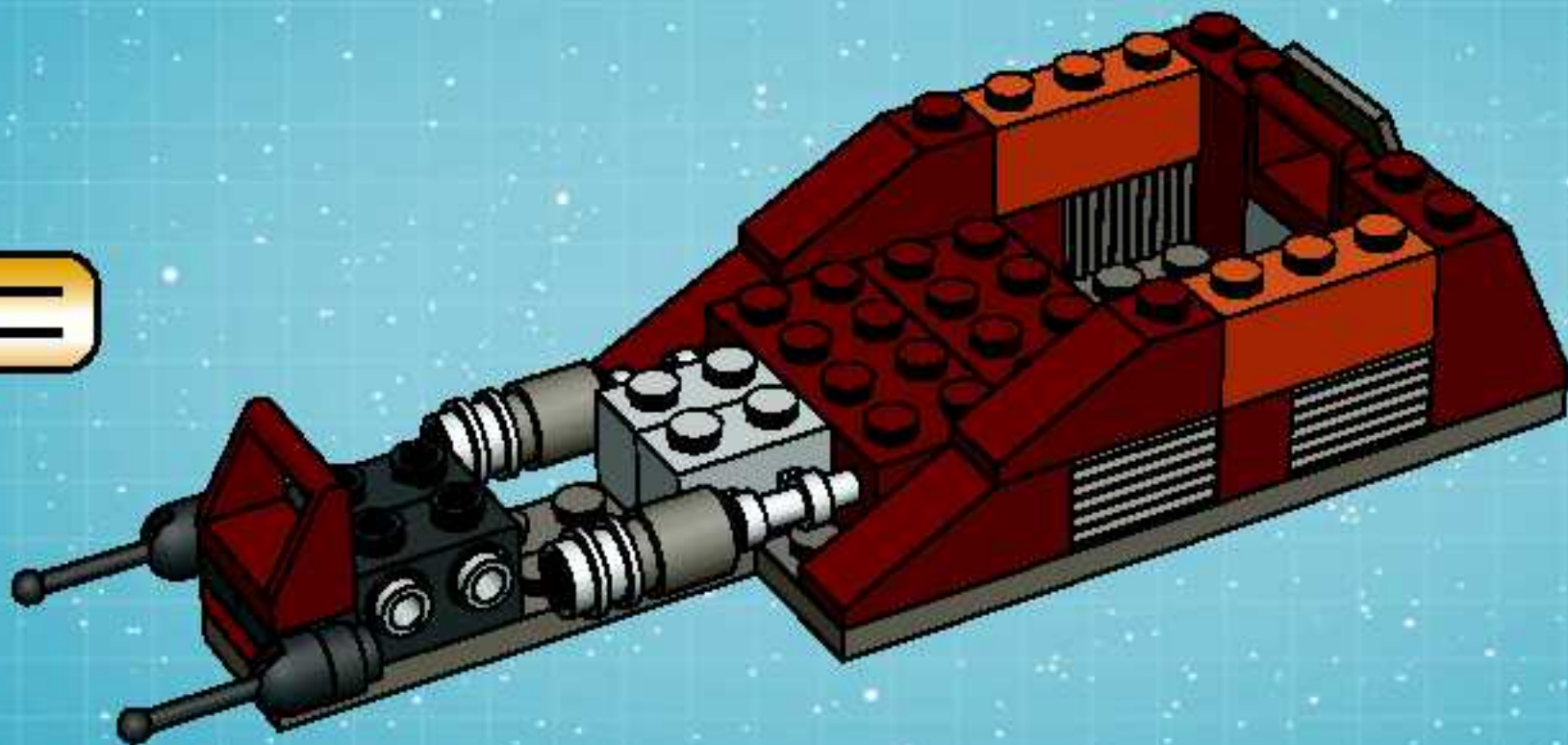

10

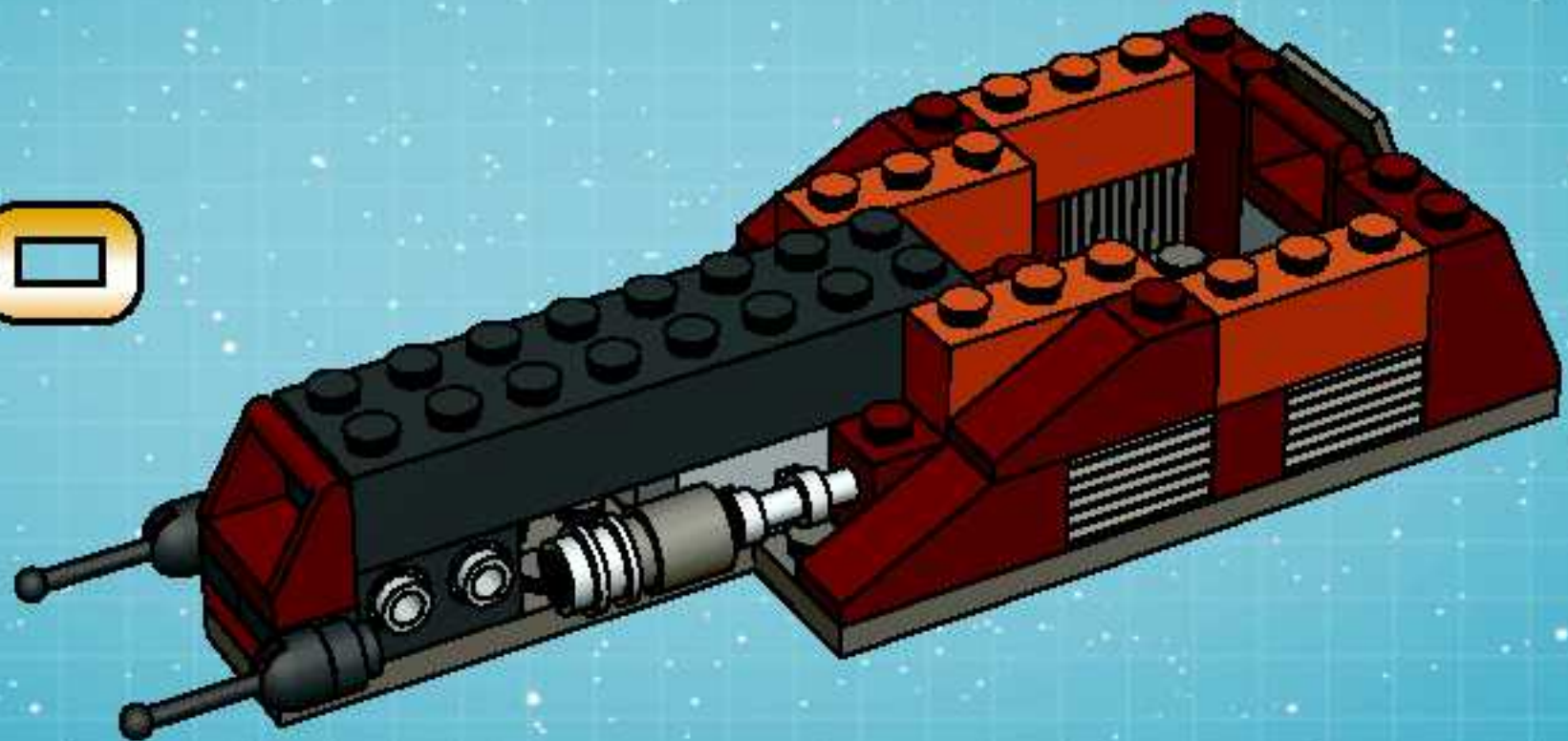



11



12

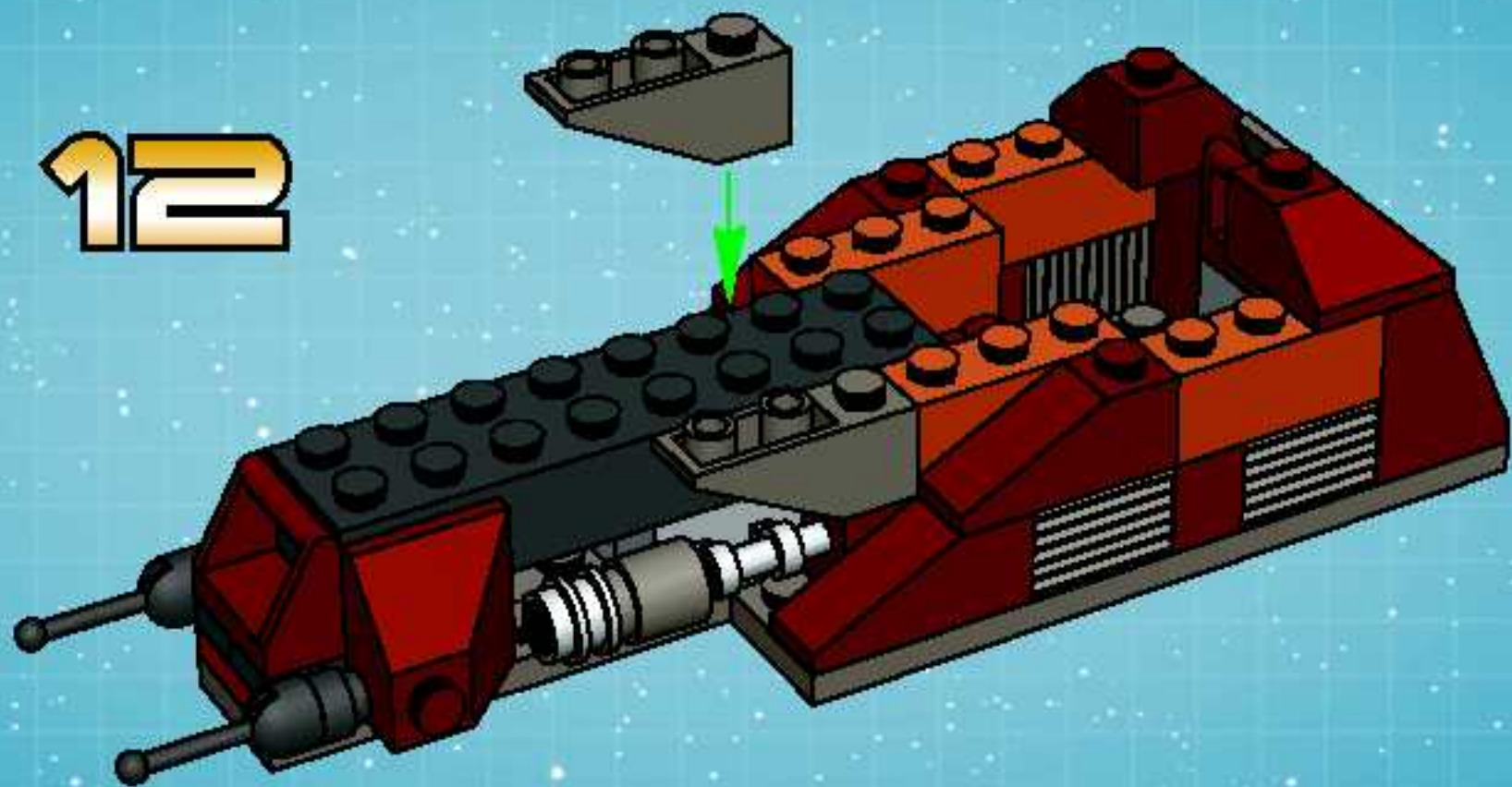

10

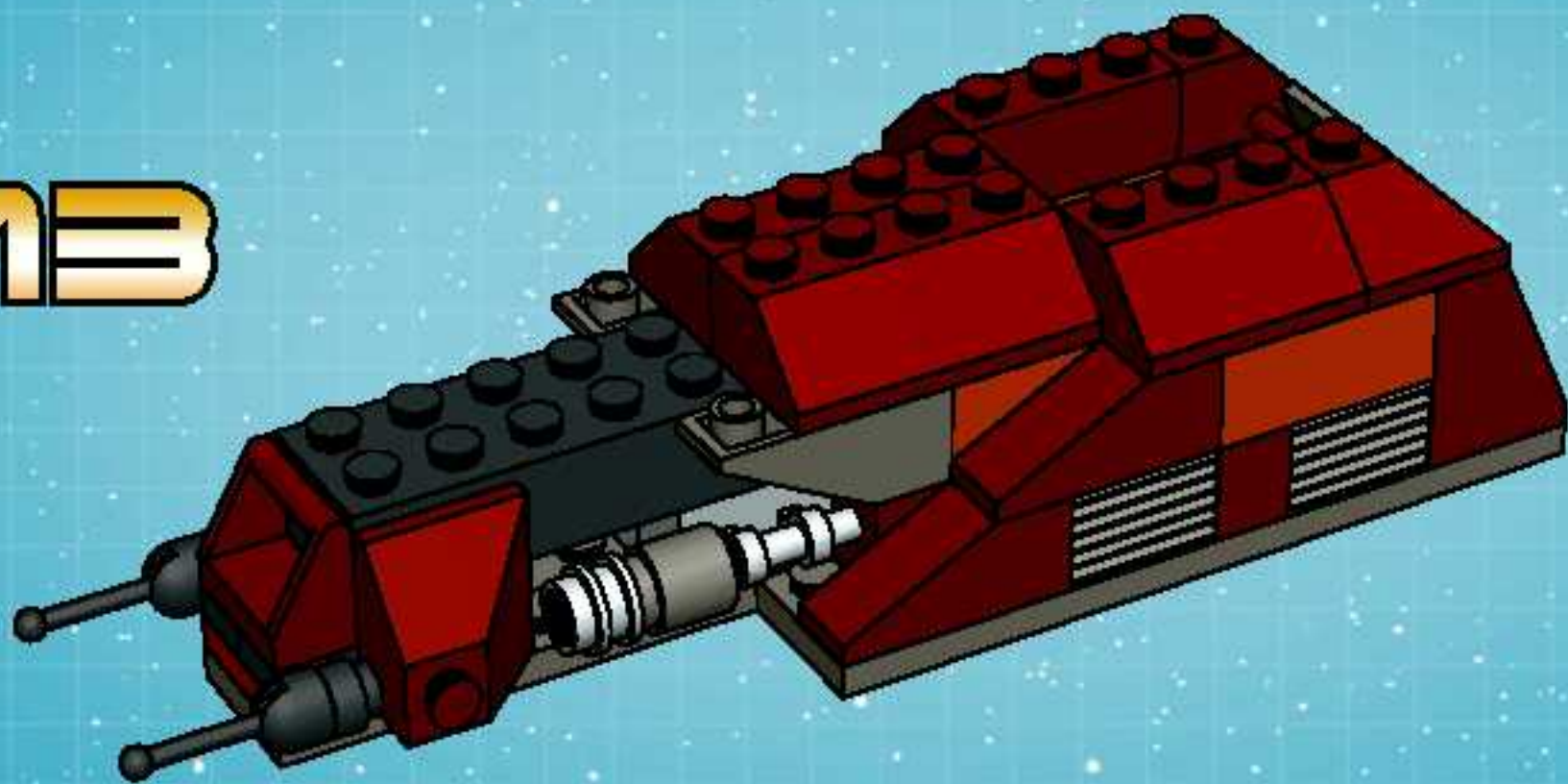

14

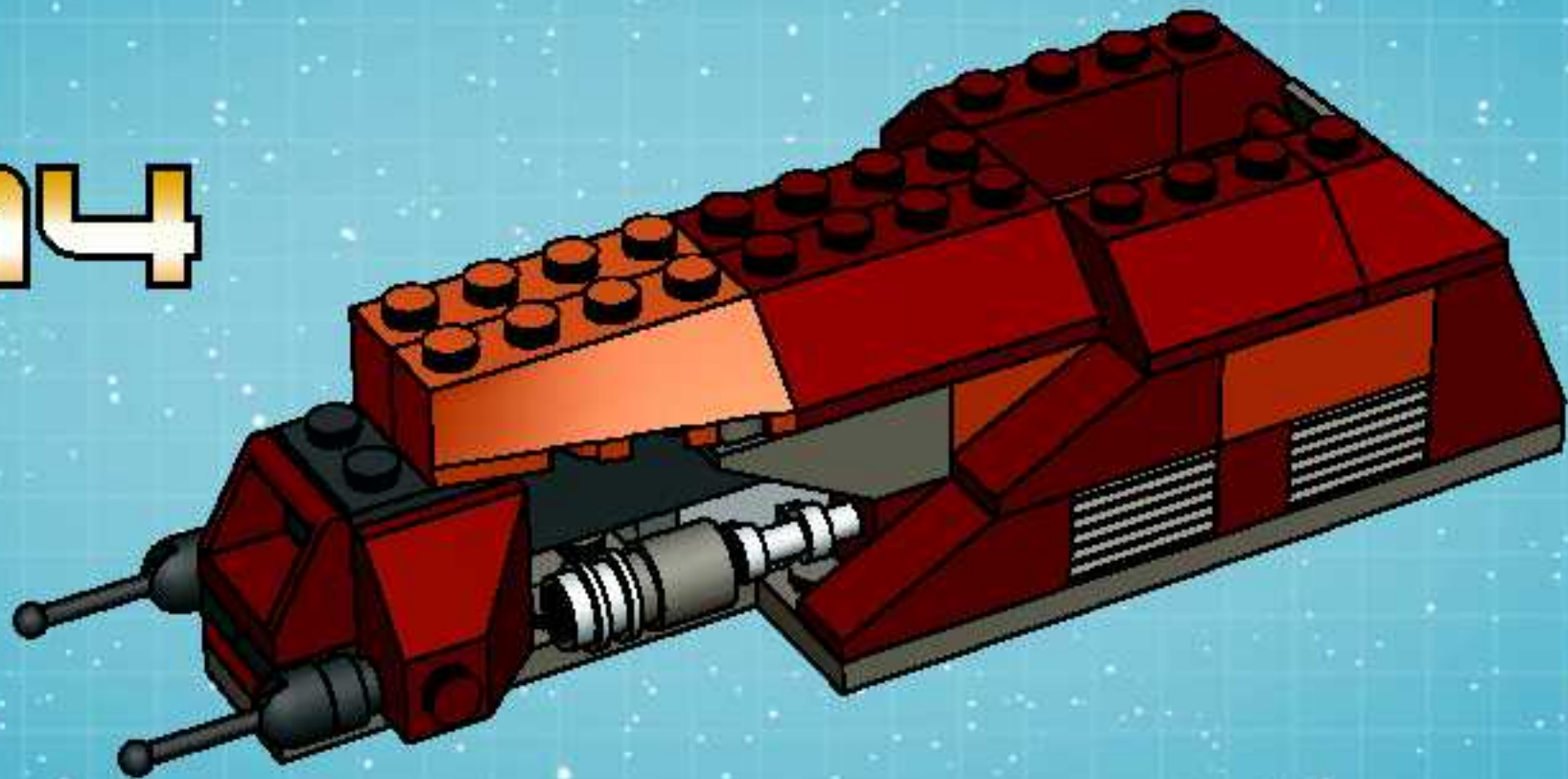

15

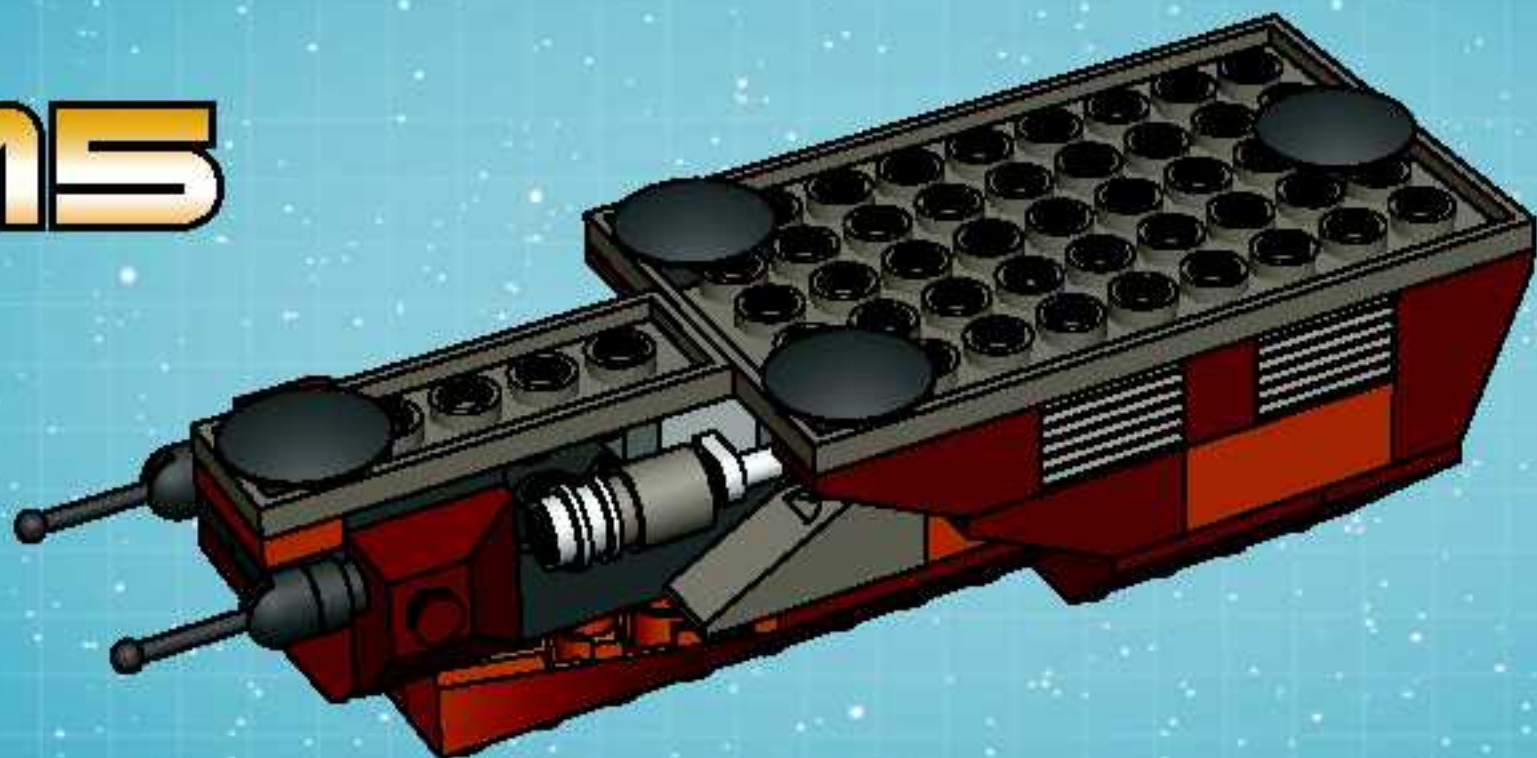

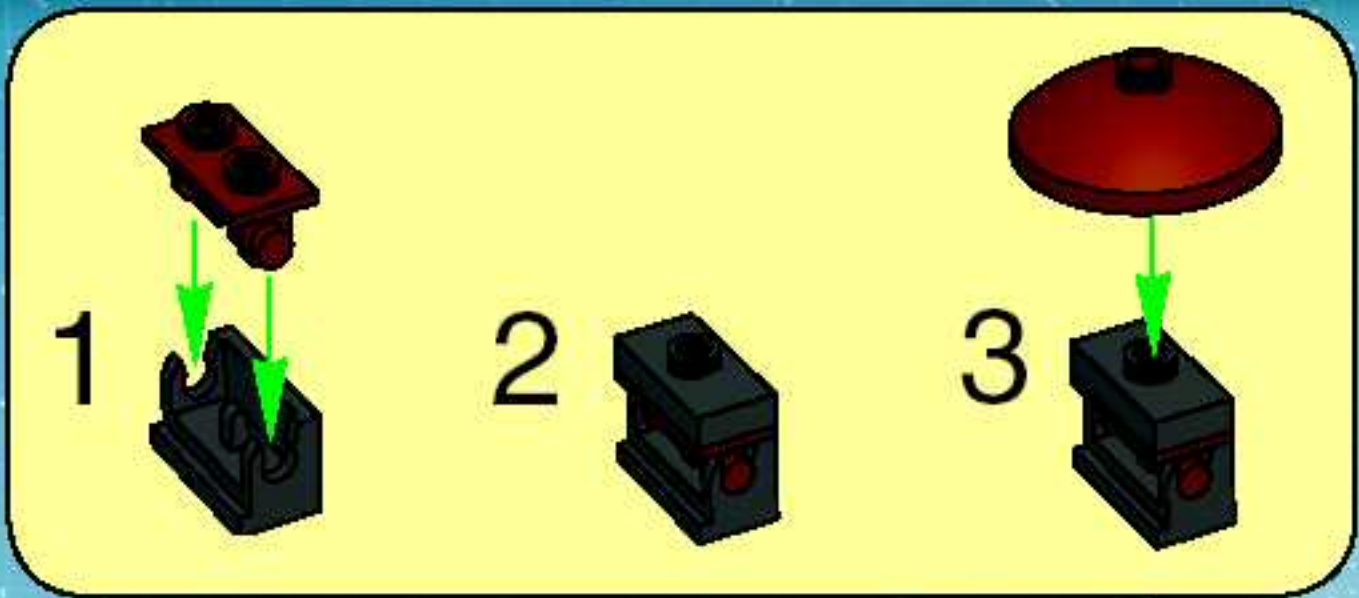

16

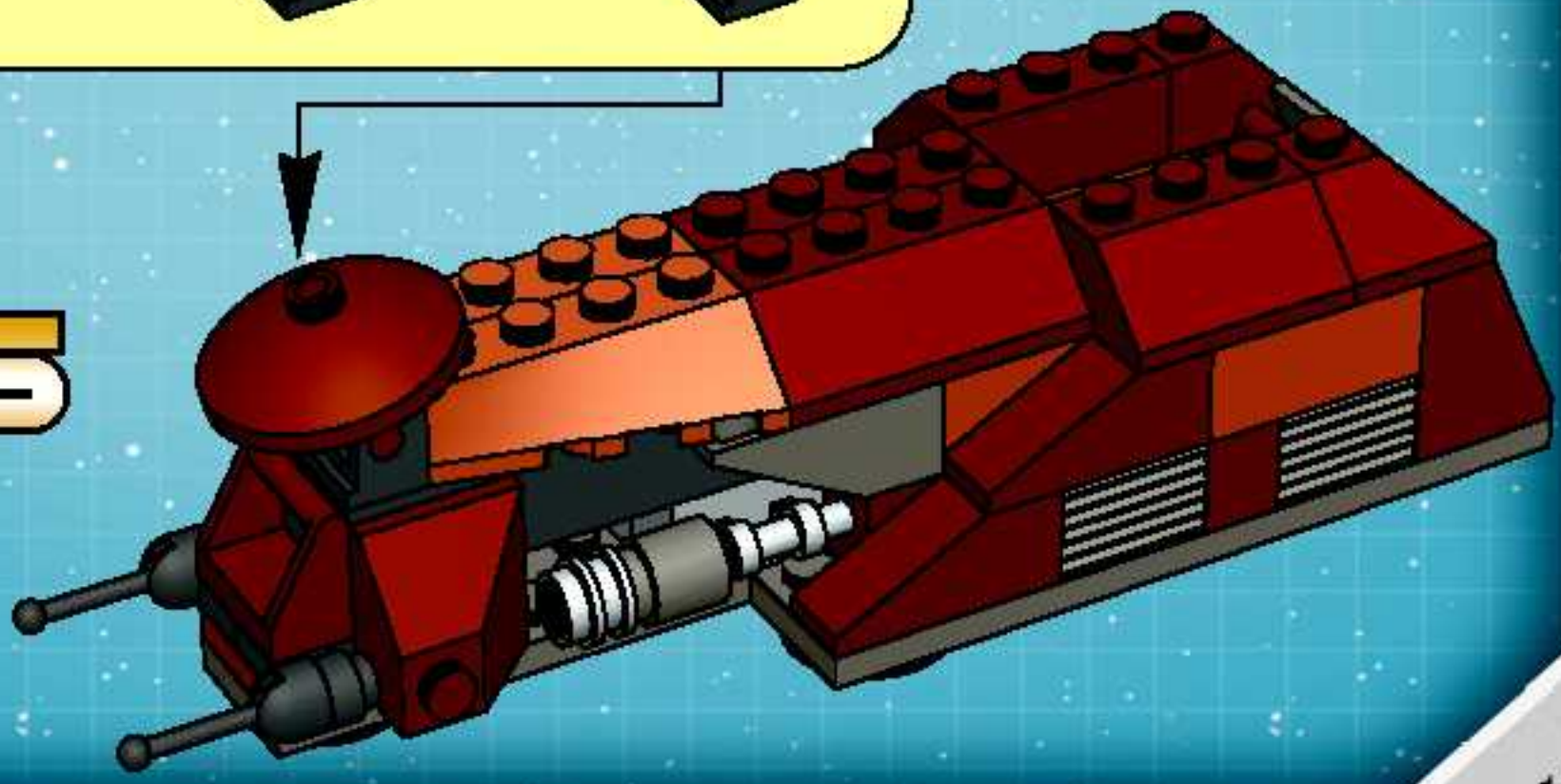

17

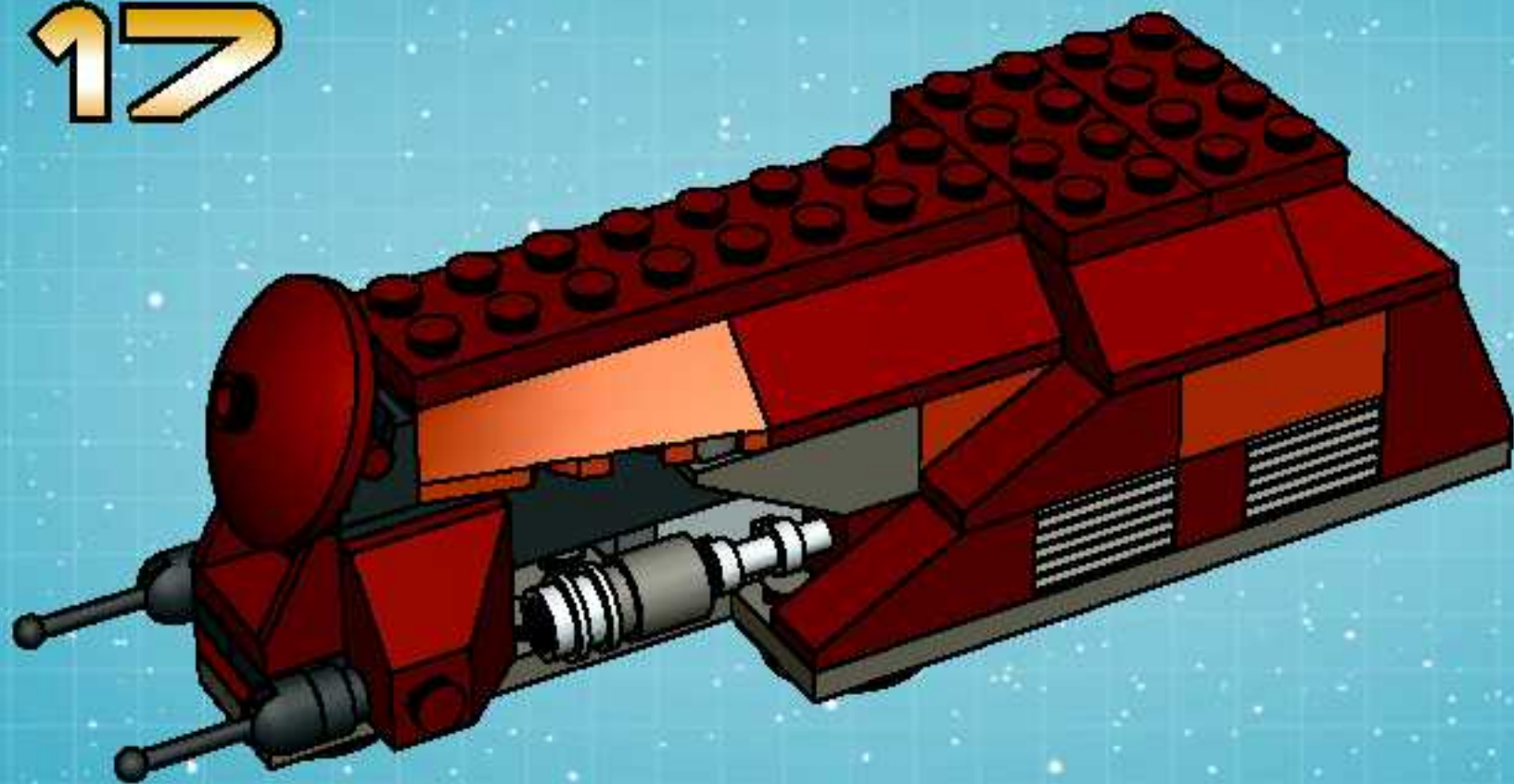

18



19





STAR WARS



120mm



4488

1/4

+



4489

2/4

+



4490

3/4

+



4491

4/4



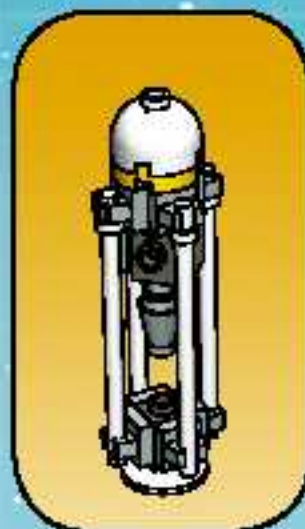

1



2

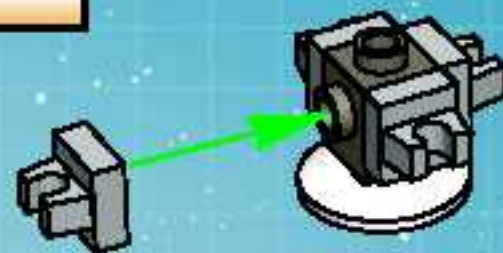

3

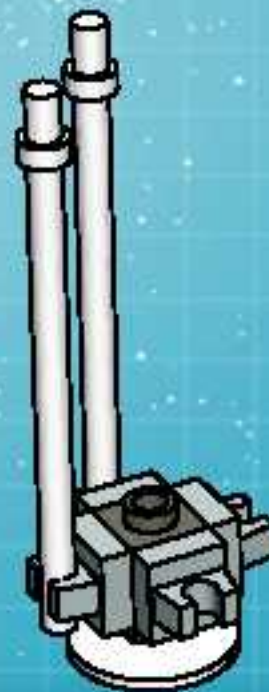

1



2

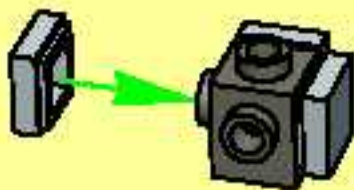

3



4

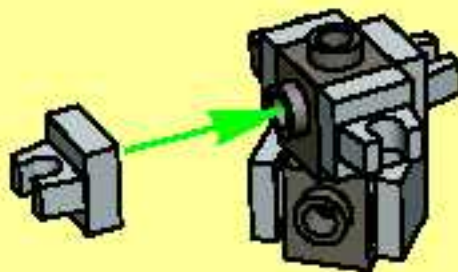

5

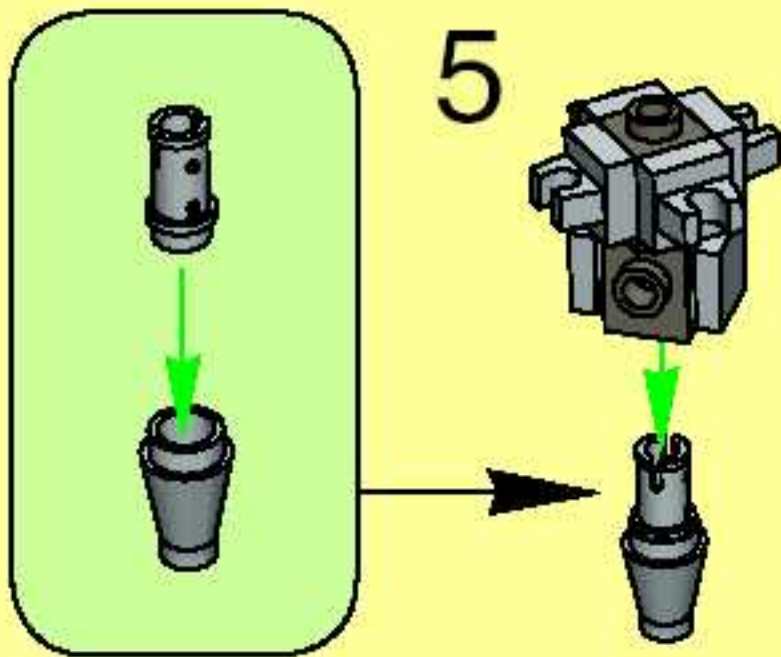

4



5

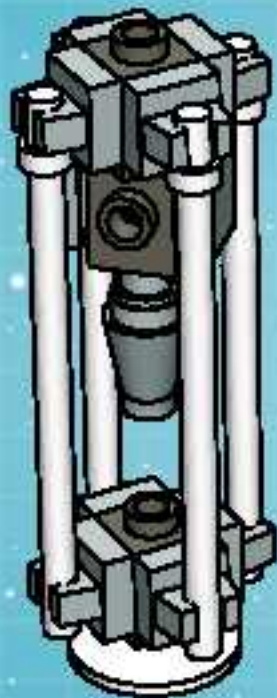

6





1



2

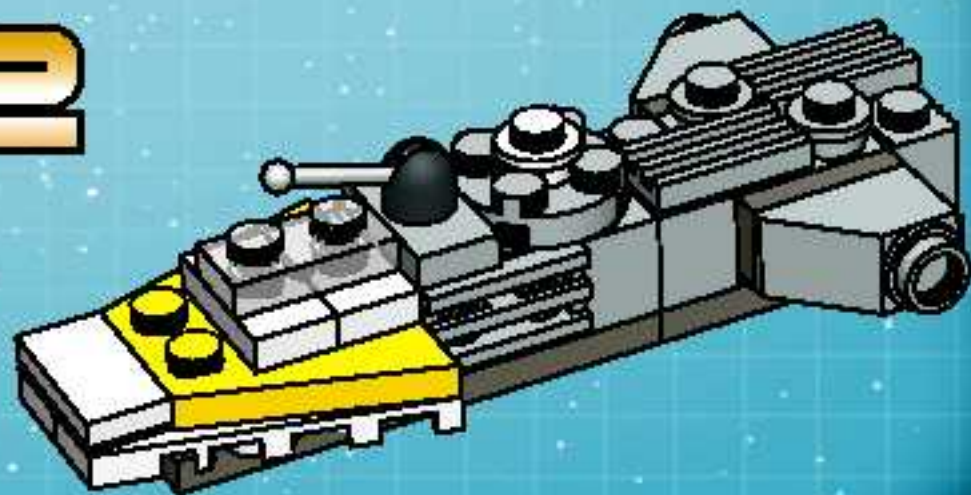

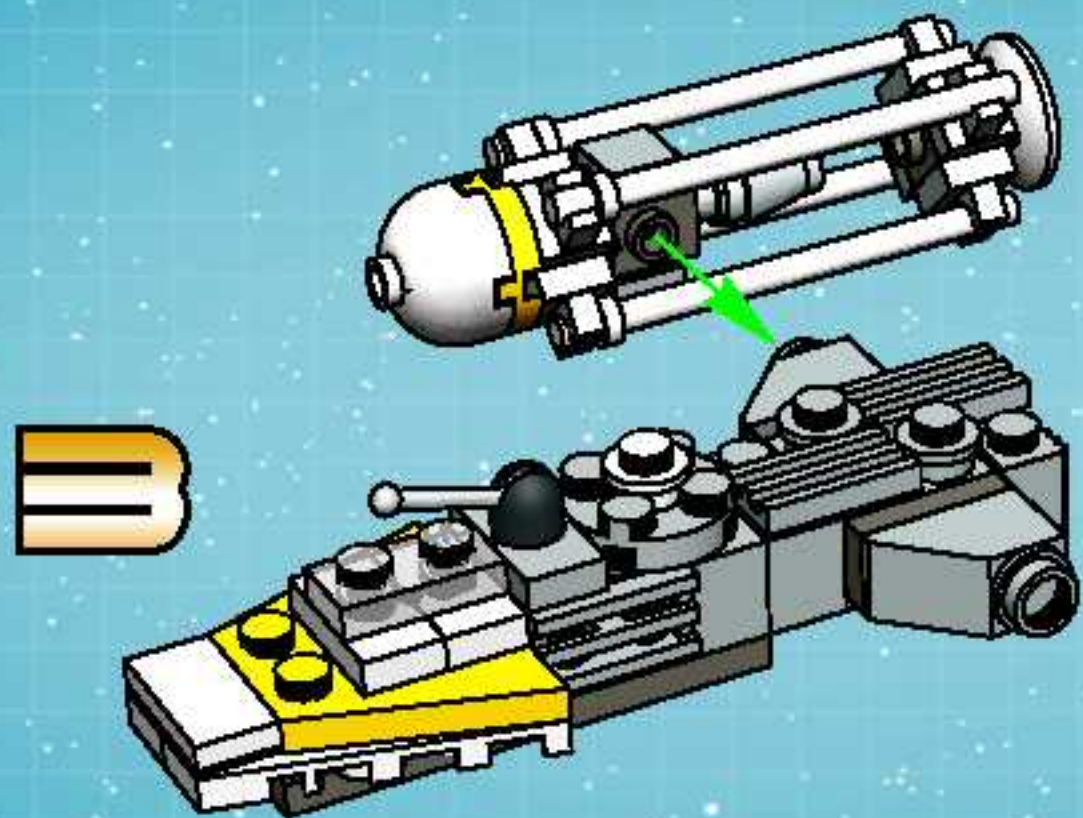

4

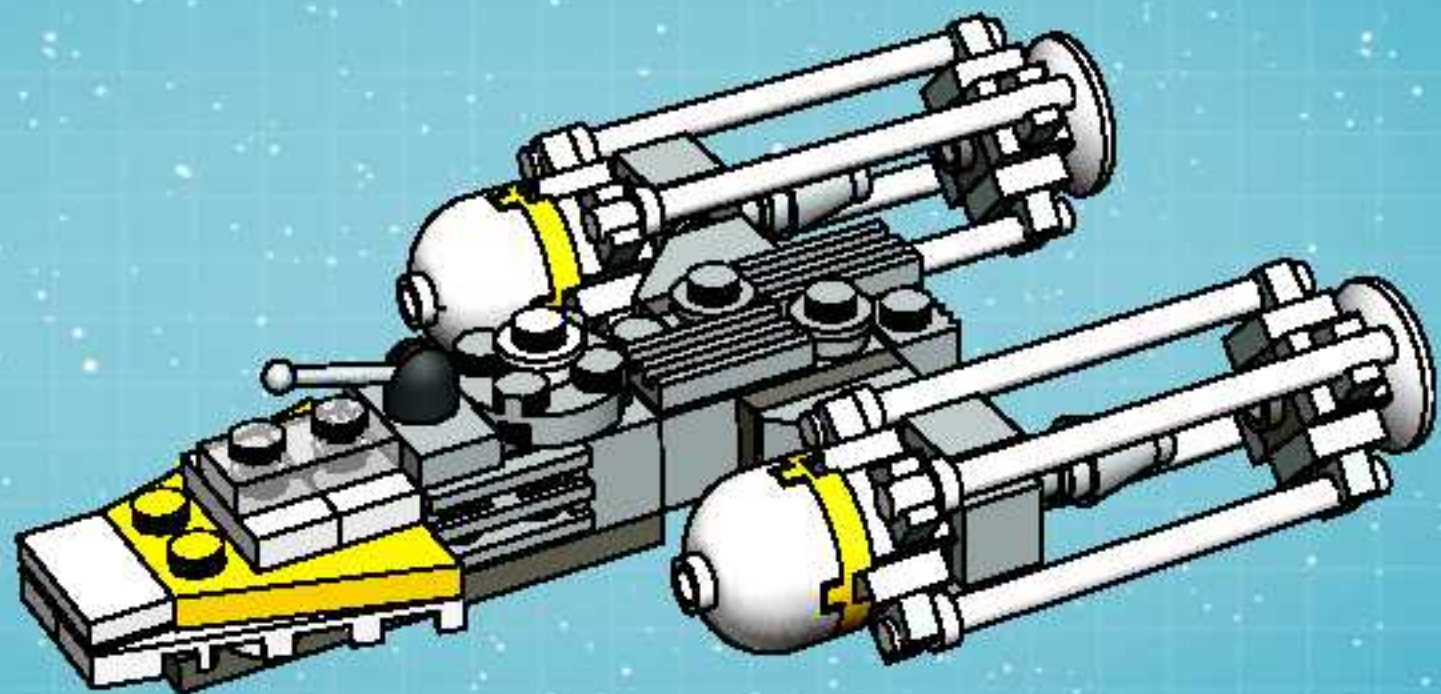



LEGO, the LEGO logo and the minifigure are trademarks of the LEGO Group.
©2003 The LEGO Group.

© 2003 Lucasfilm Ltd. & TM/MC. All rights reserved. Used under authorization.