



4207

CITY





+



5

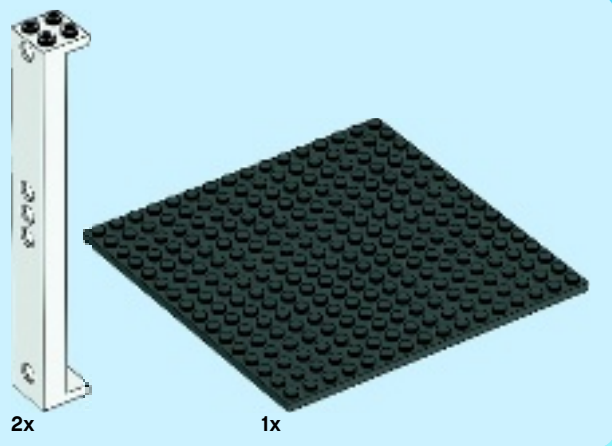
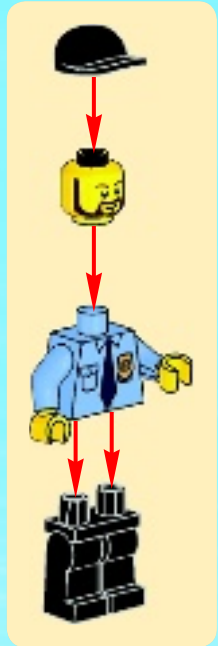

1

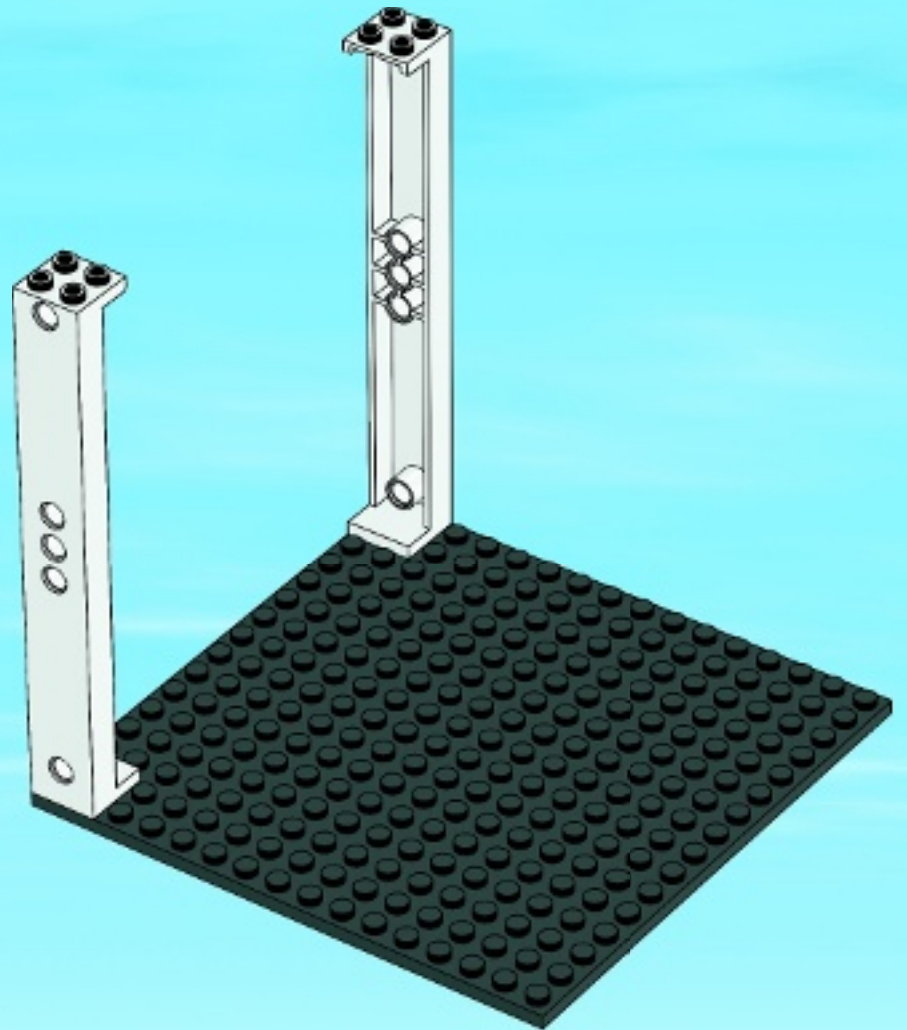

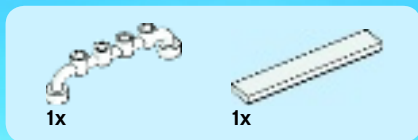

2

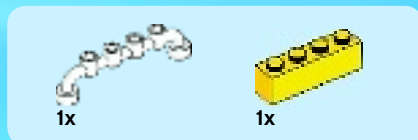
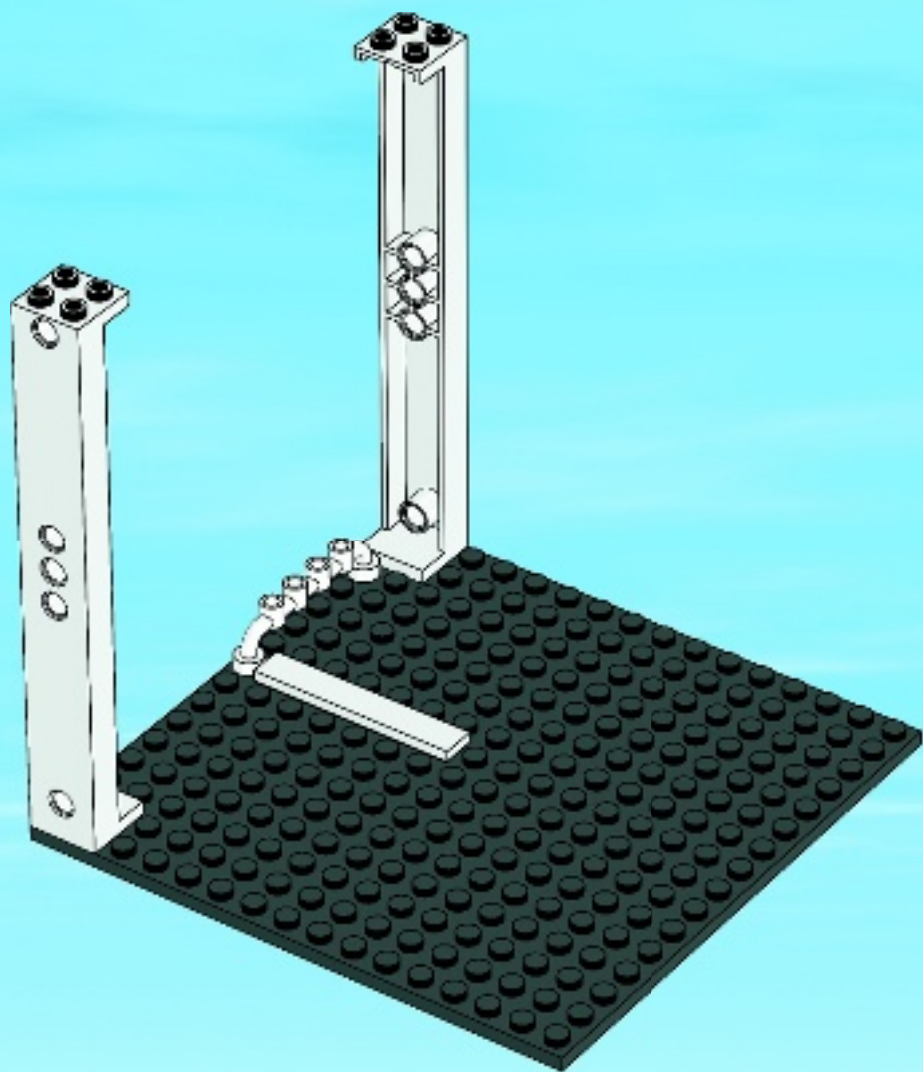

3

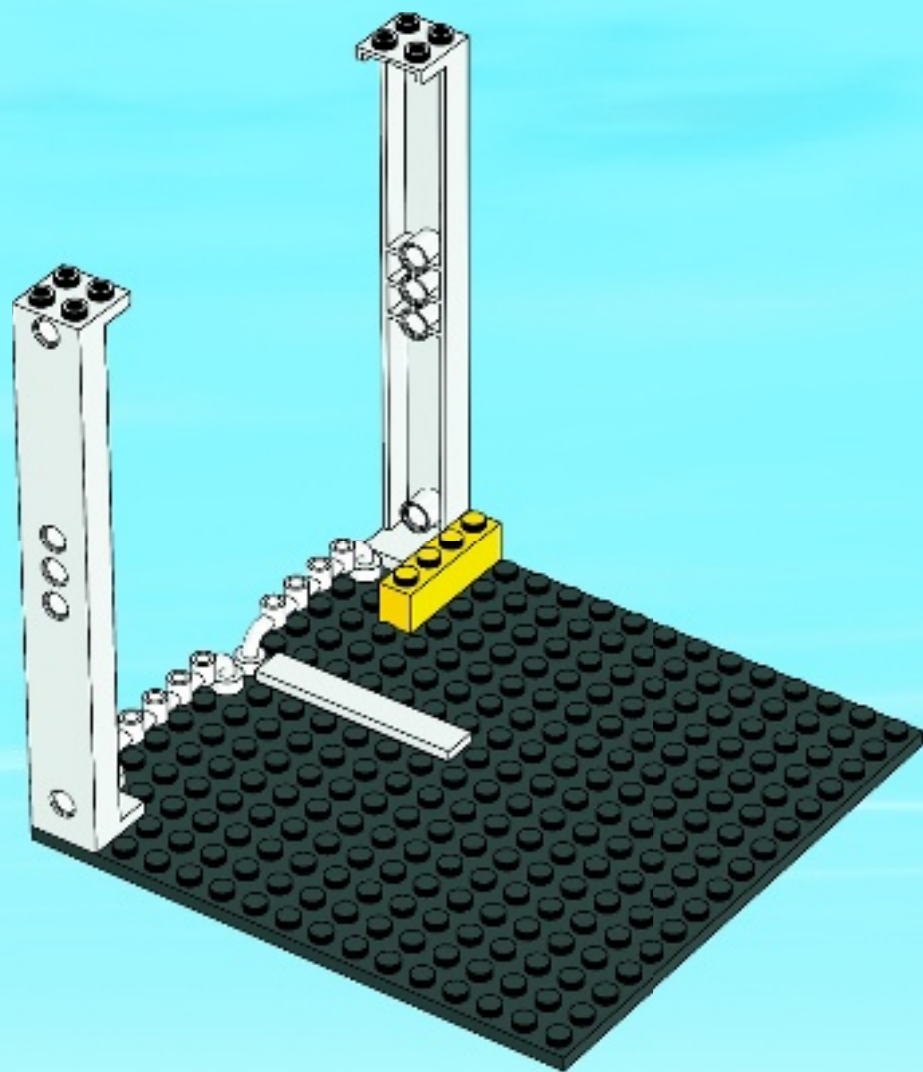

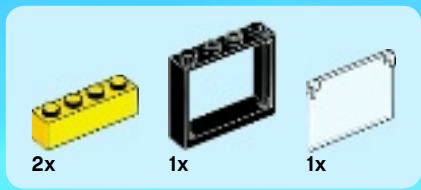

4

1

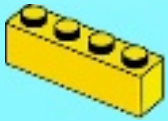

2

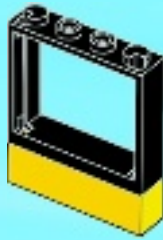

3

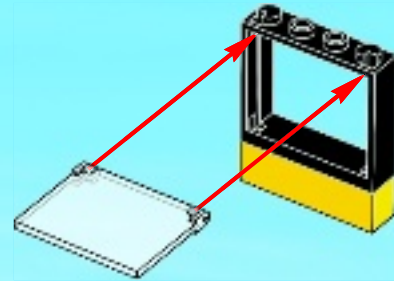

4

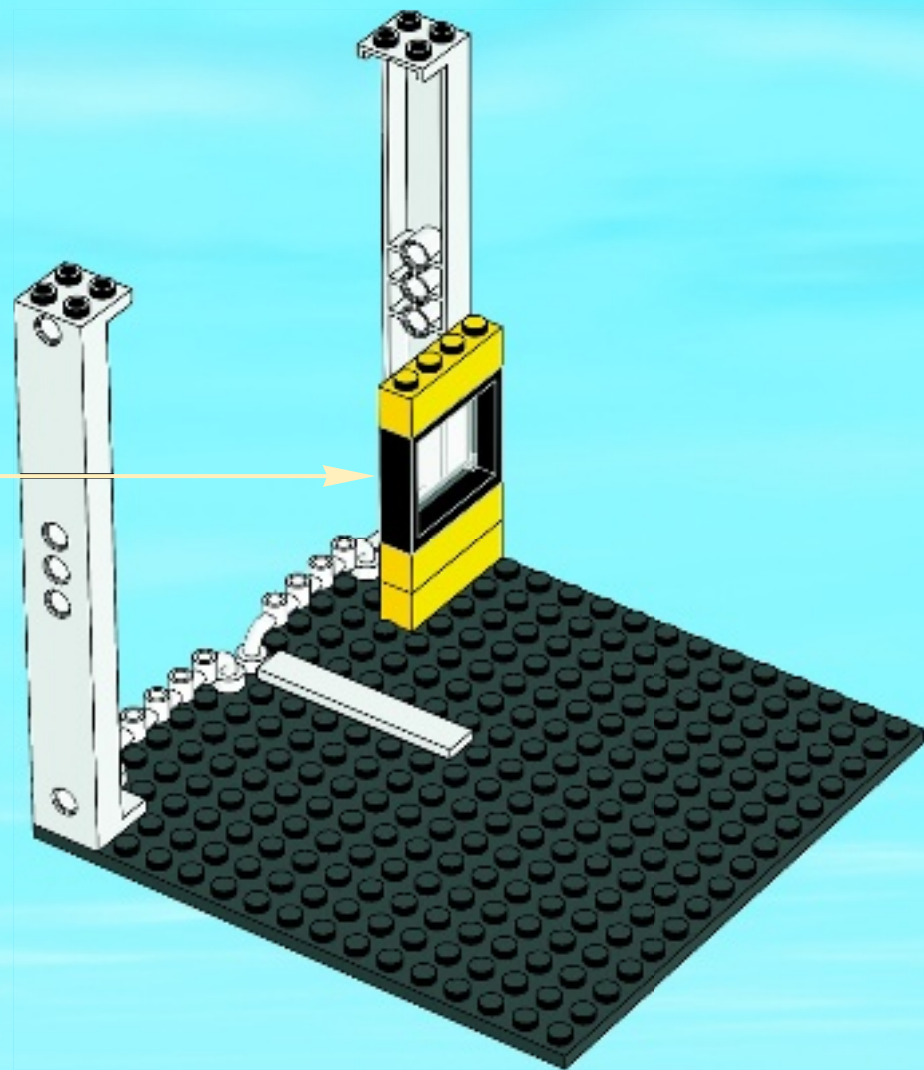

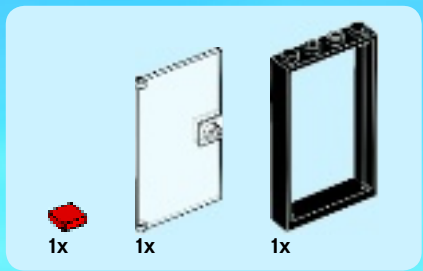

5

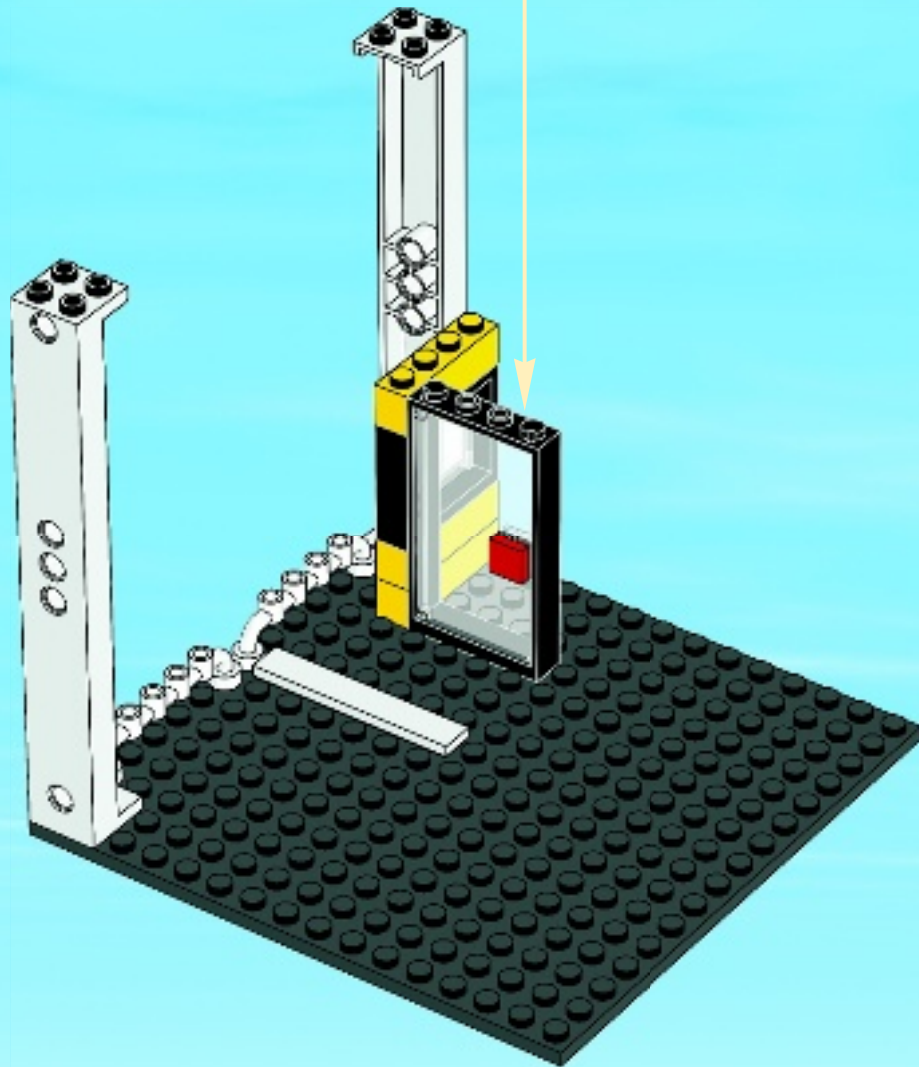
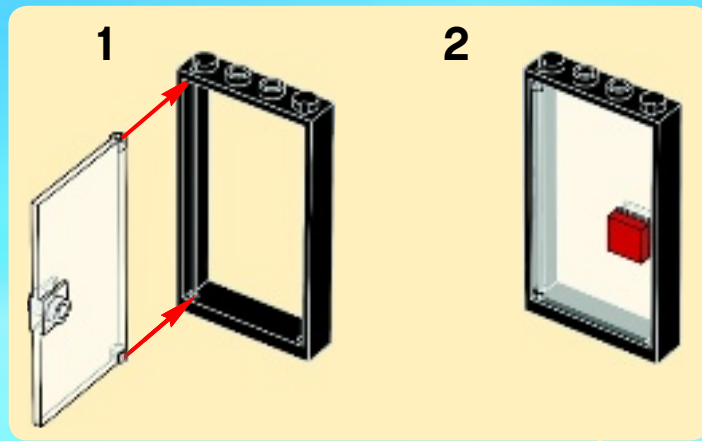

6

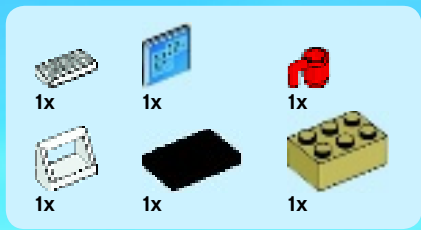

7

1

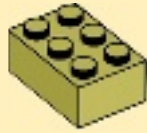

2



3



4

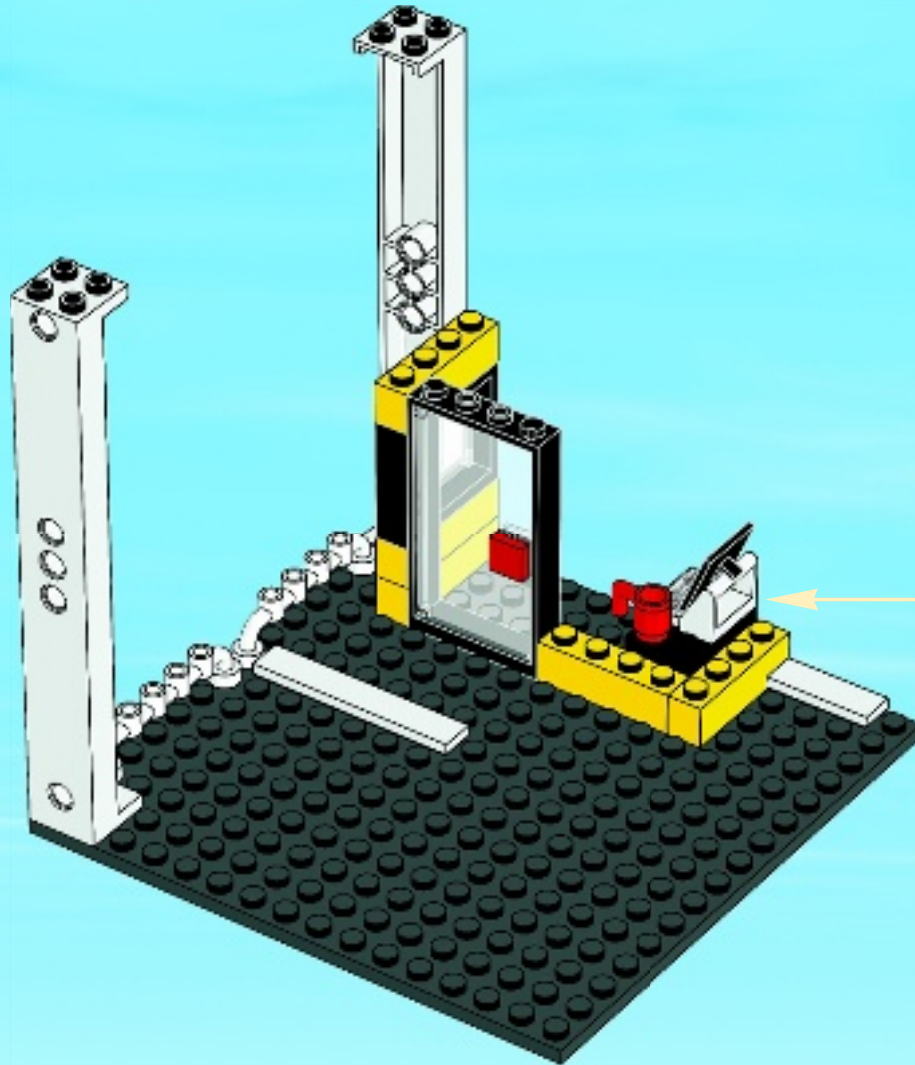



1x

8

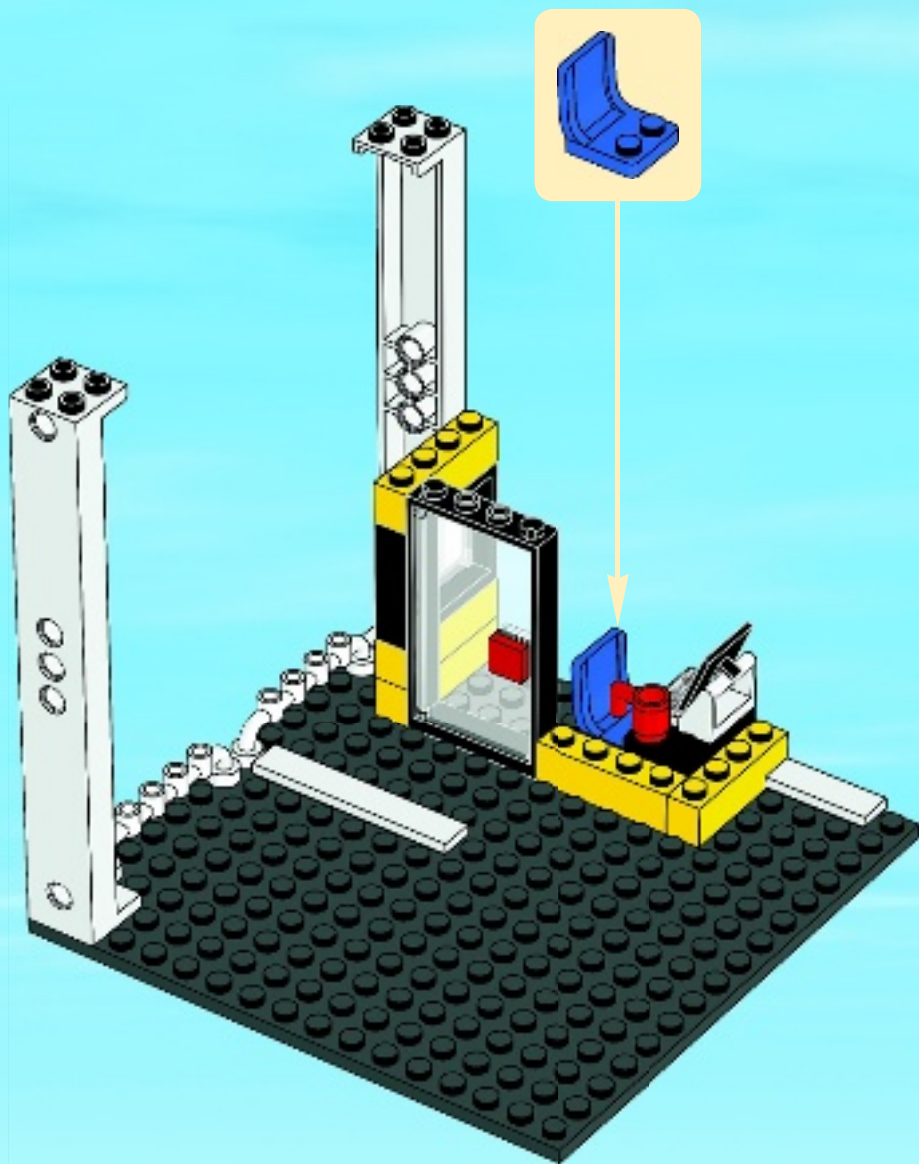

2x



1x



1x

9

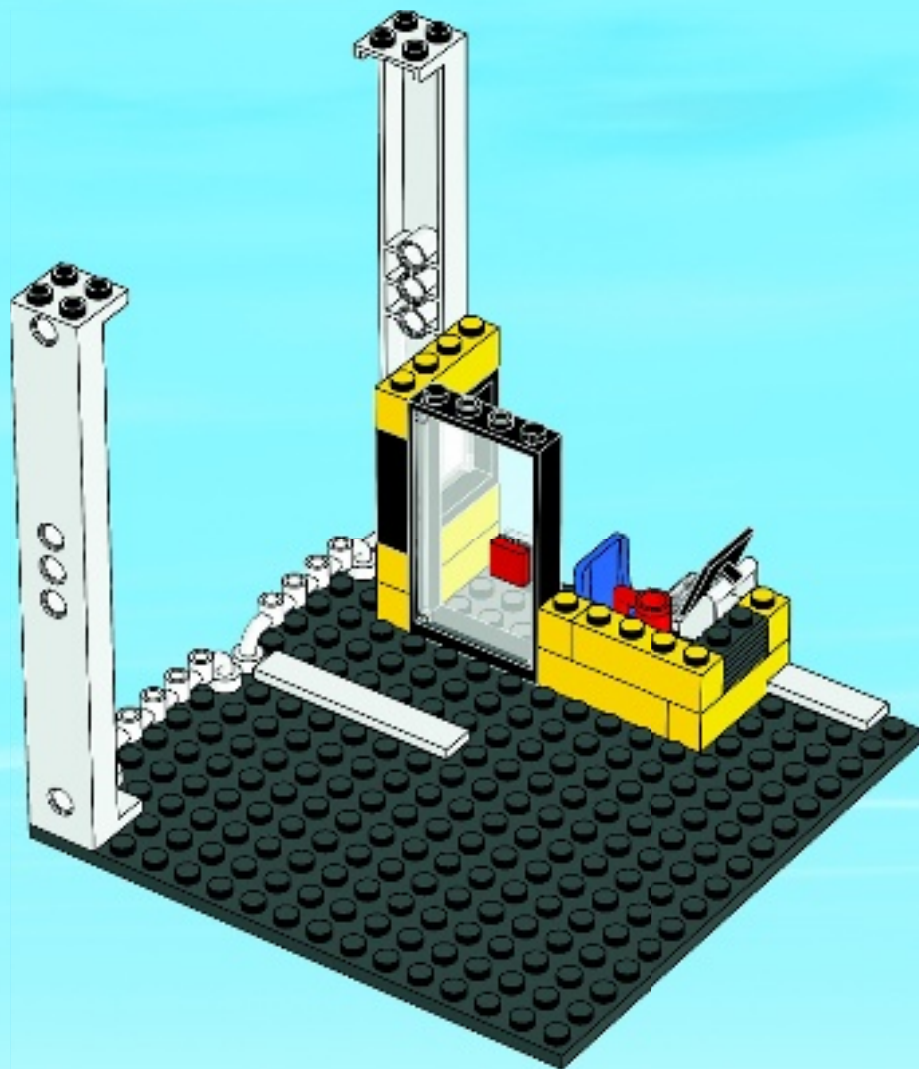

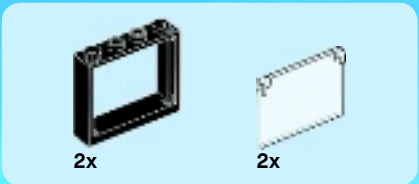

10

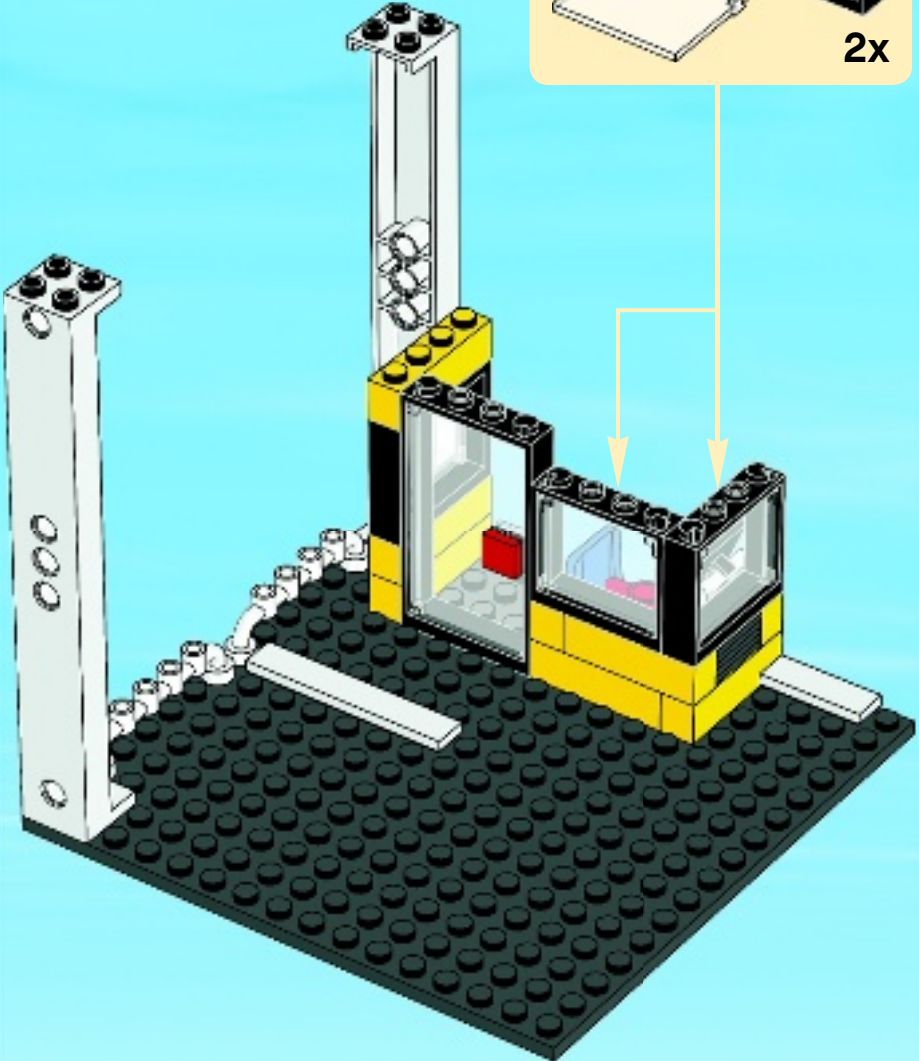
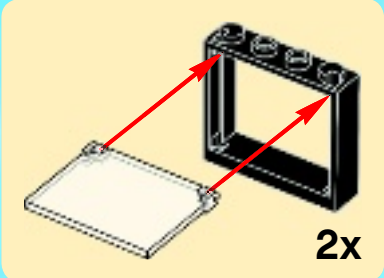

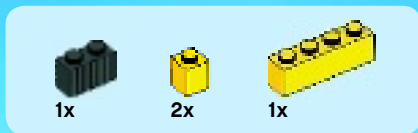

11

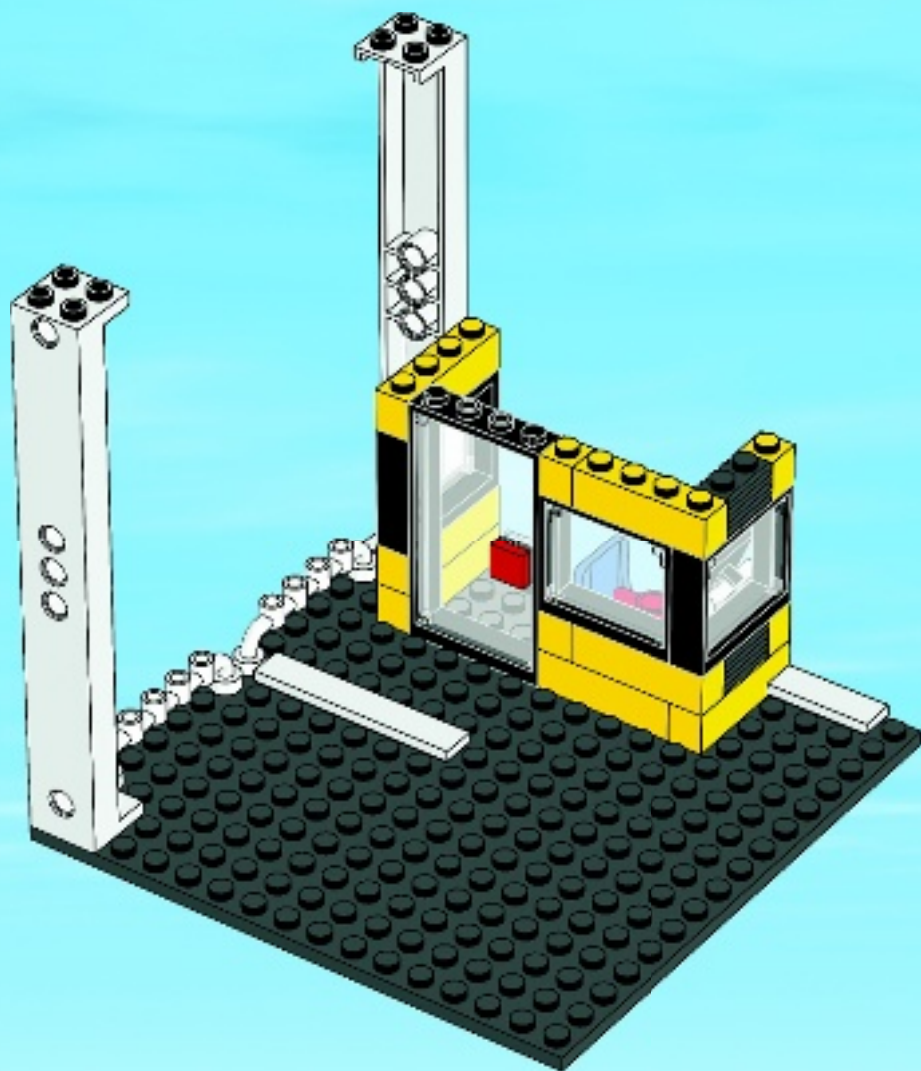

12

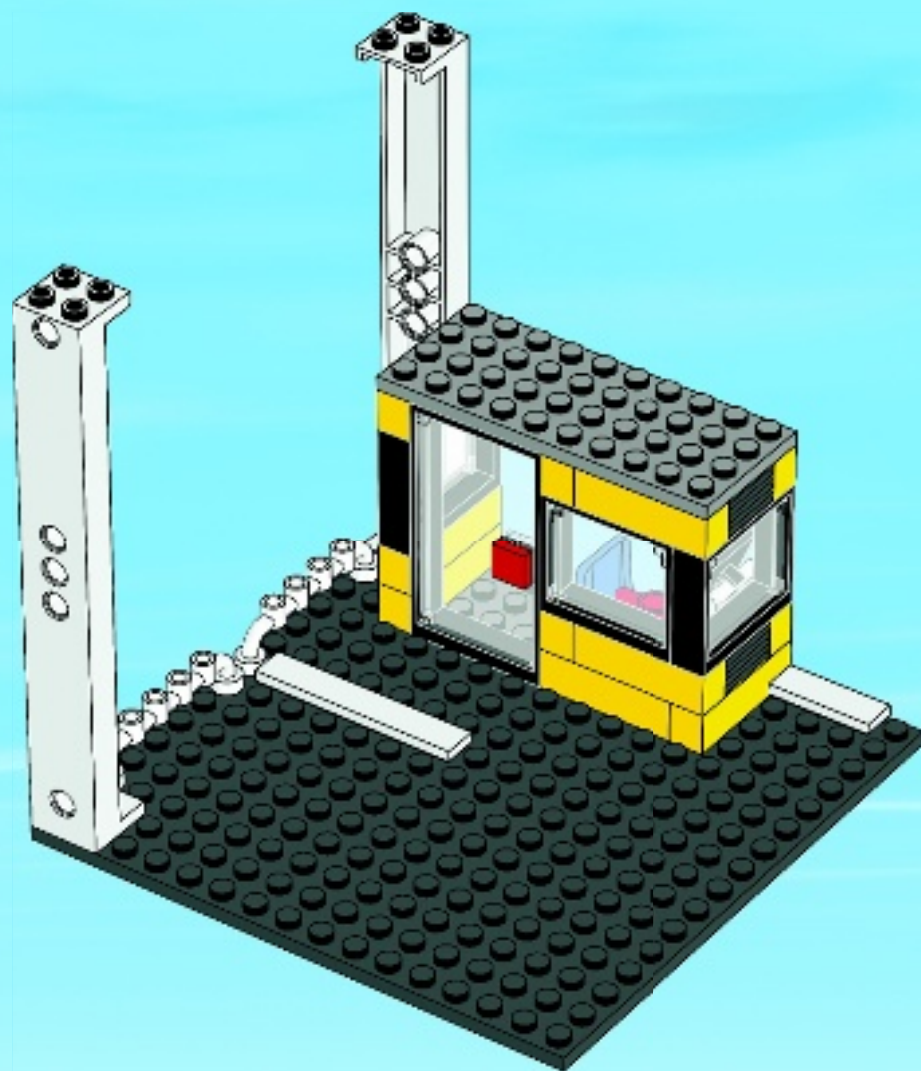



1x



1x



1x

13

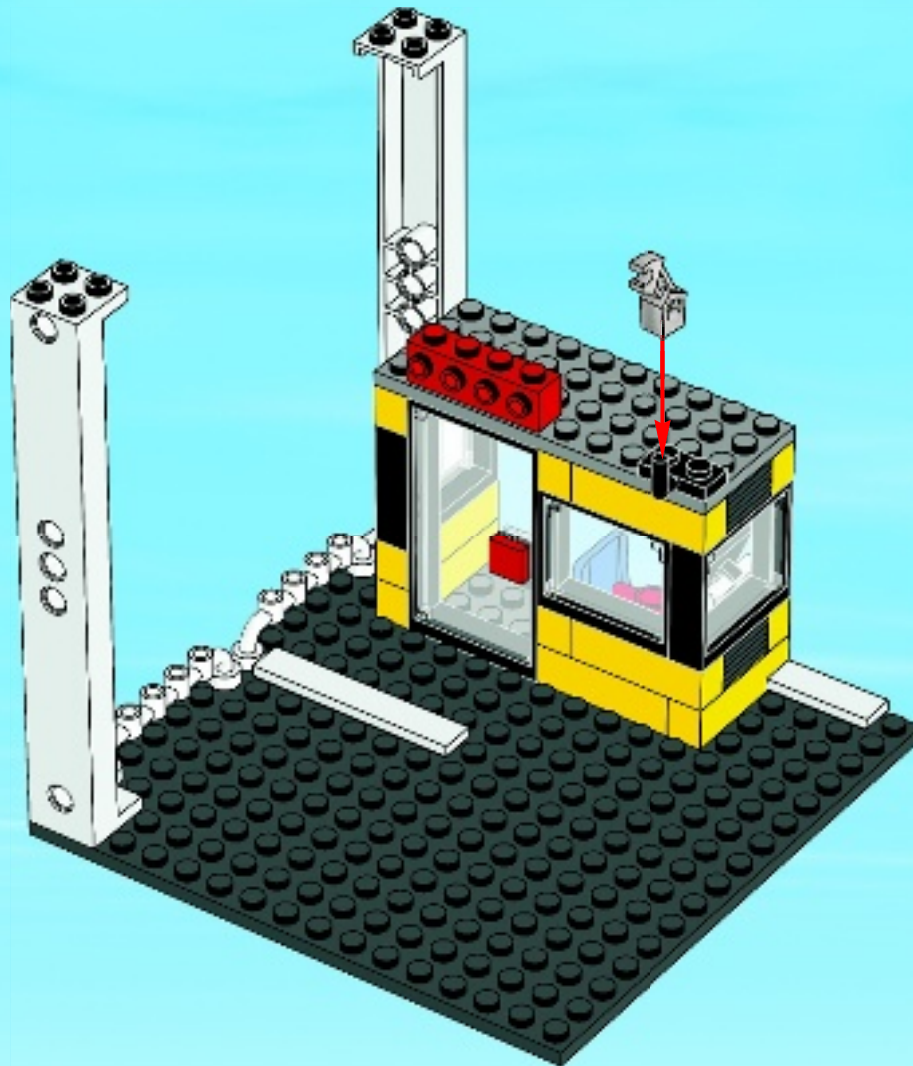

-  1x
-  1x
-  1x

14

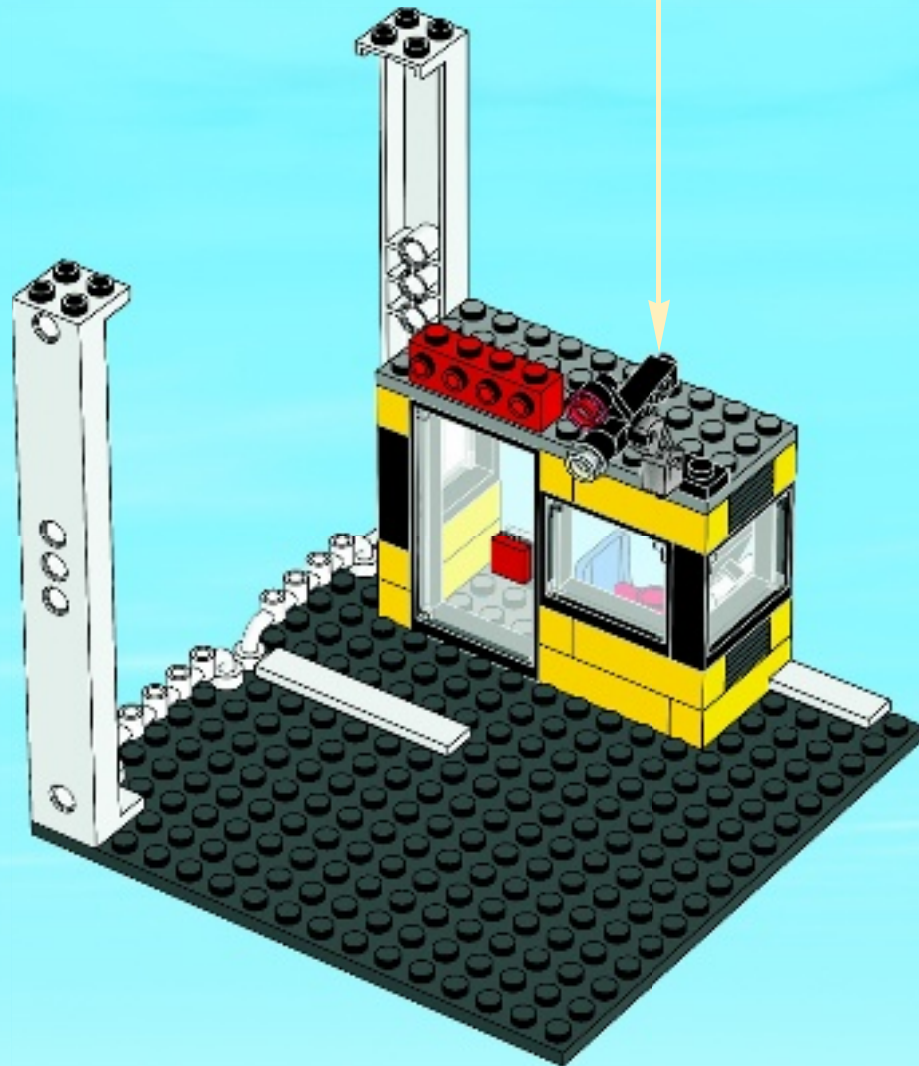
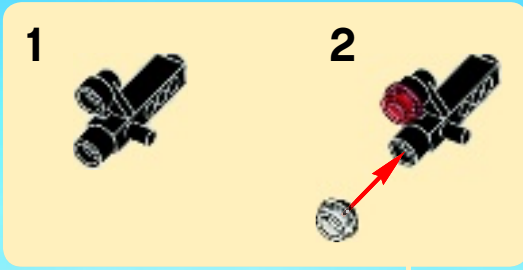



1x

15

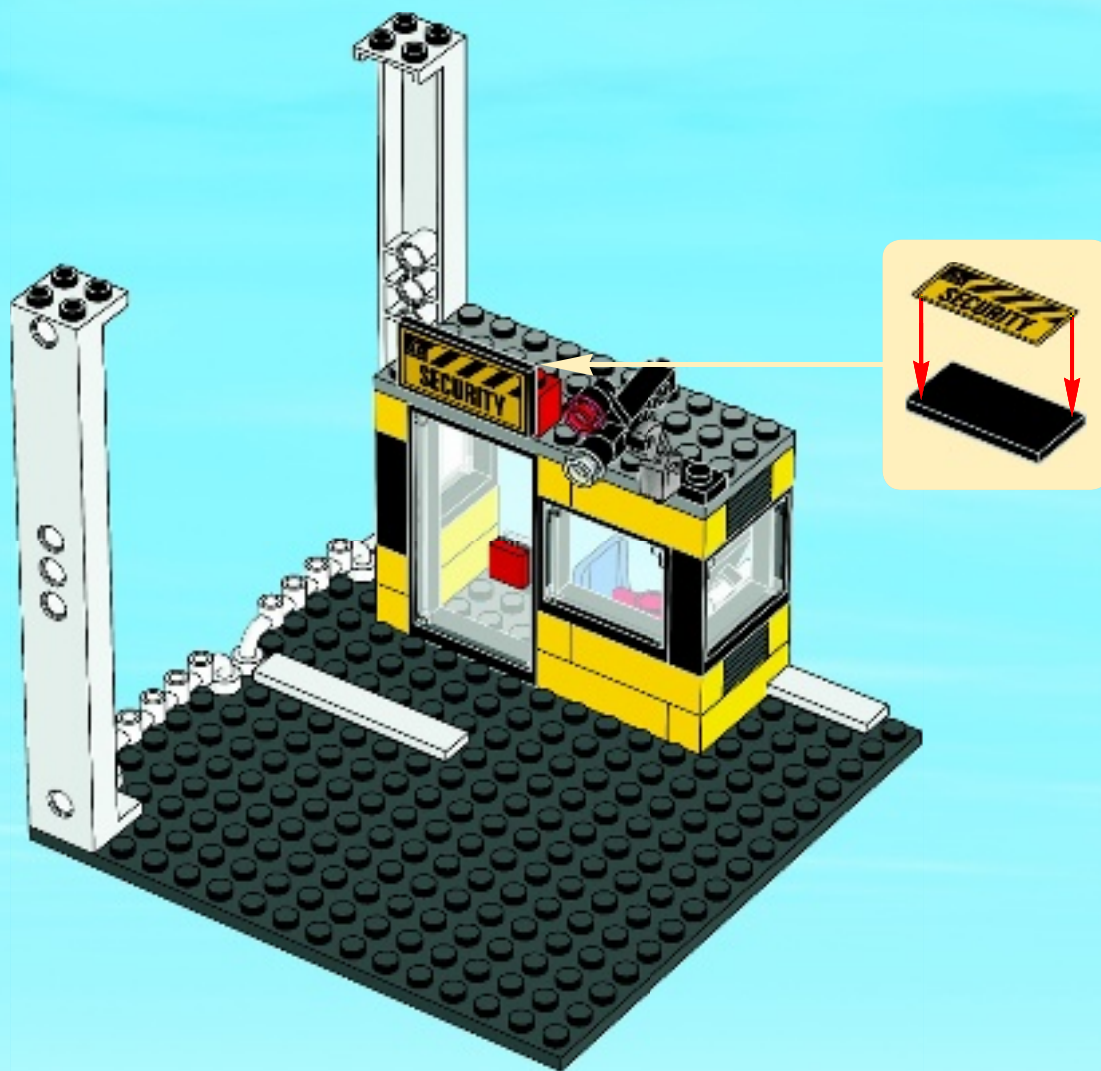

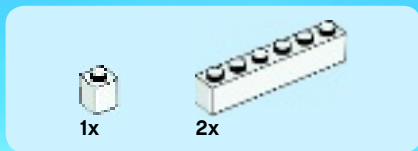

16

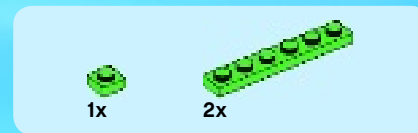
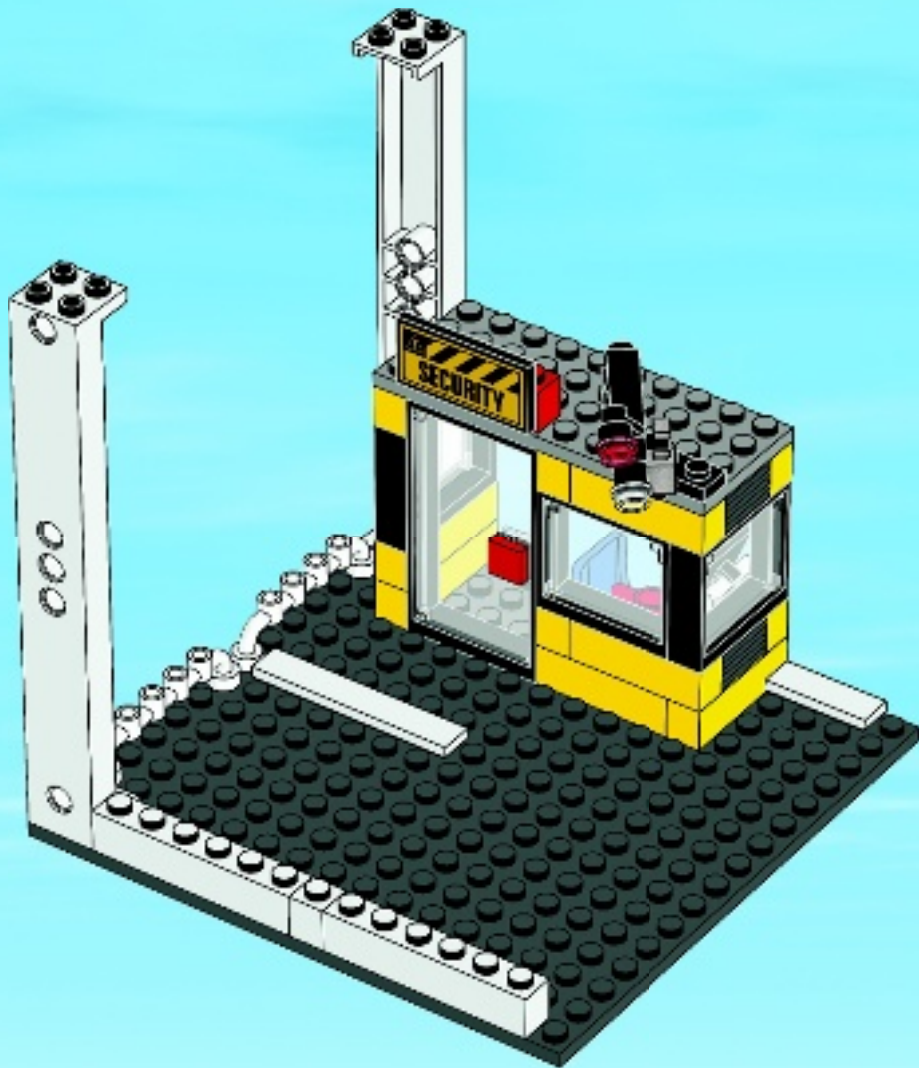

17

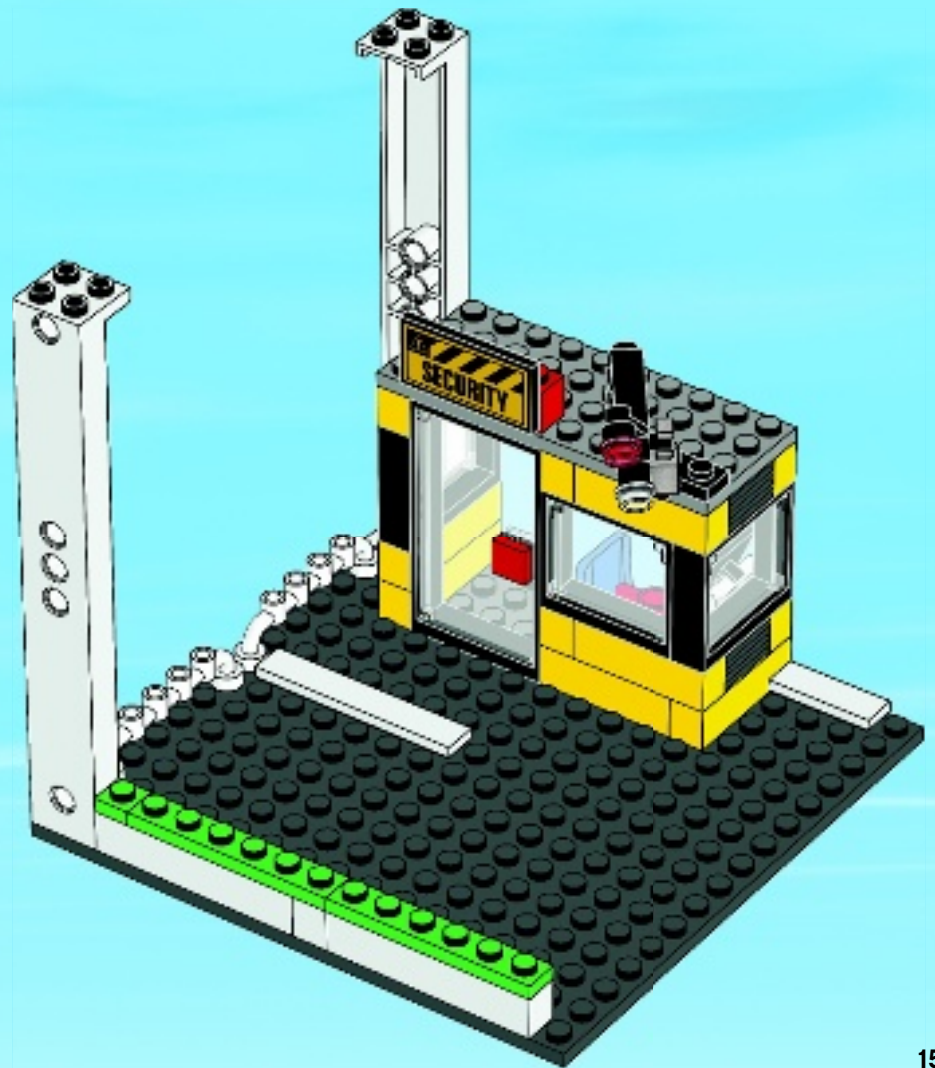

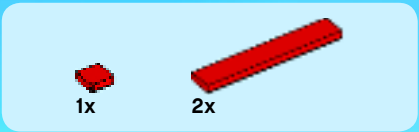

18

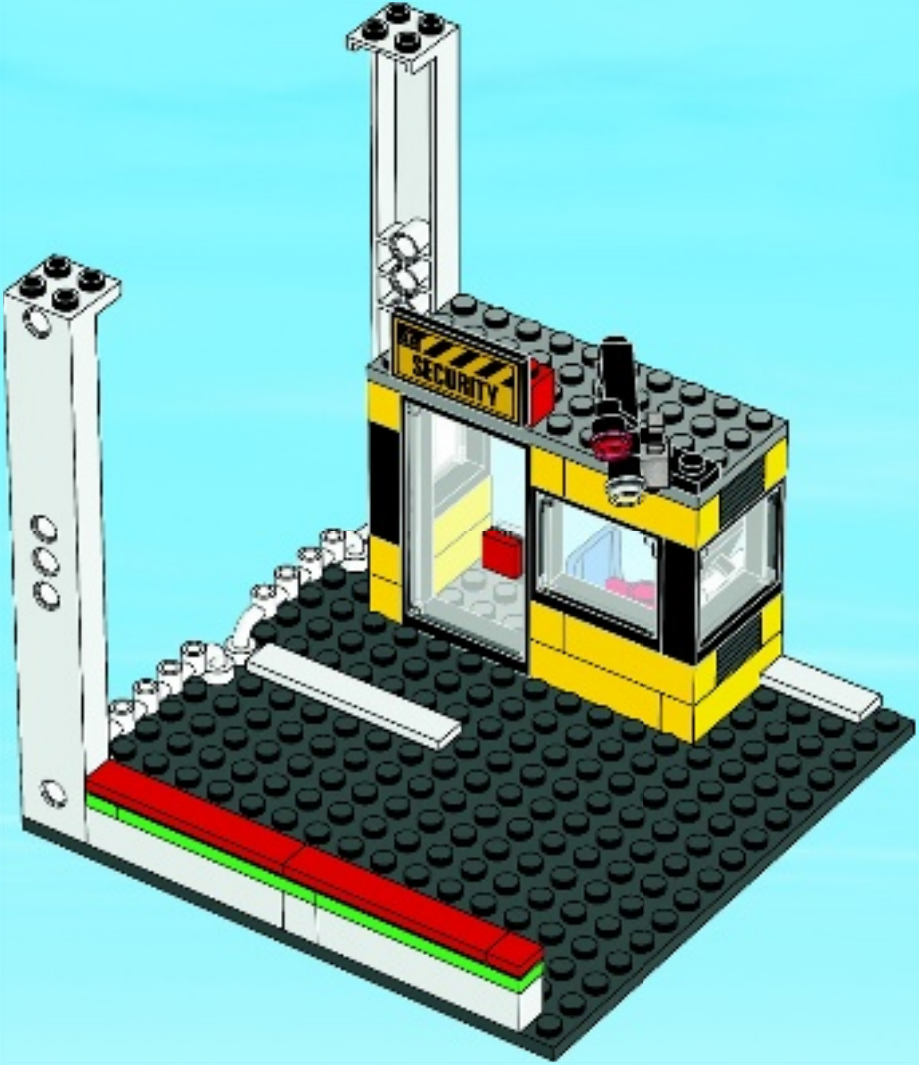

43

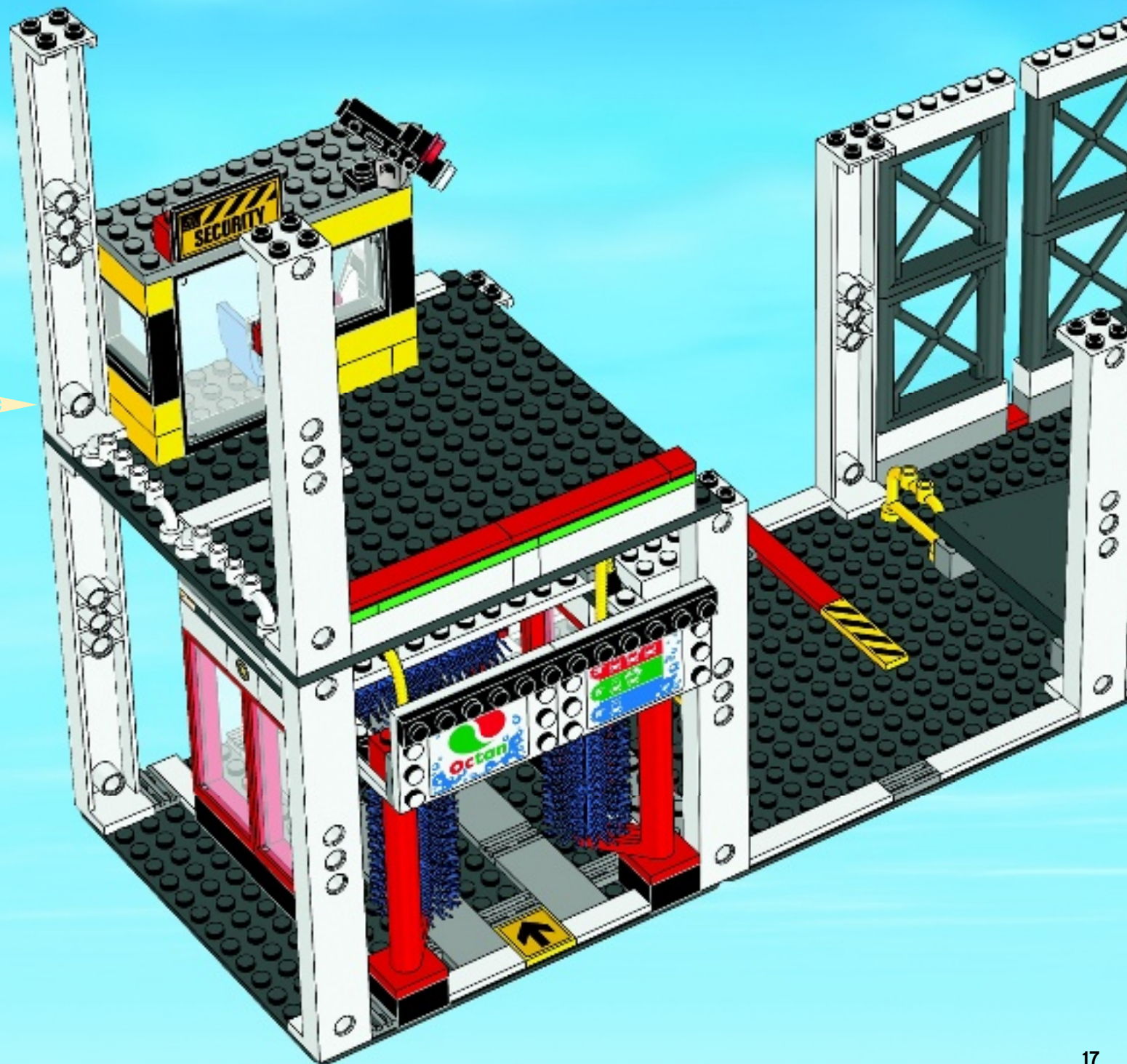



2x

44

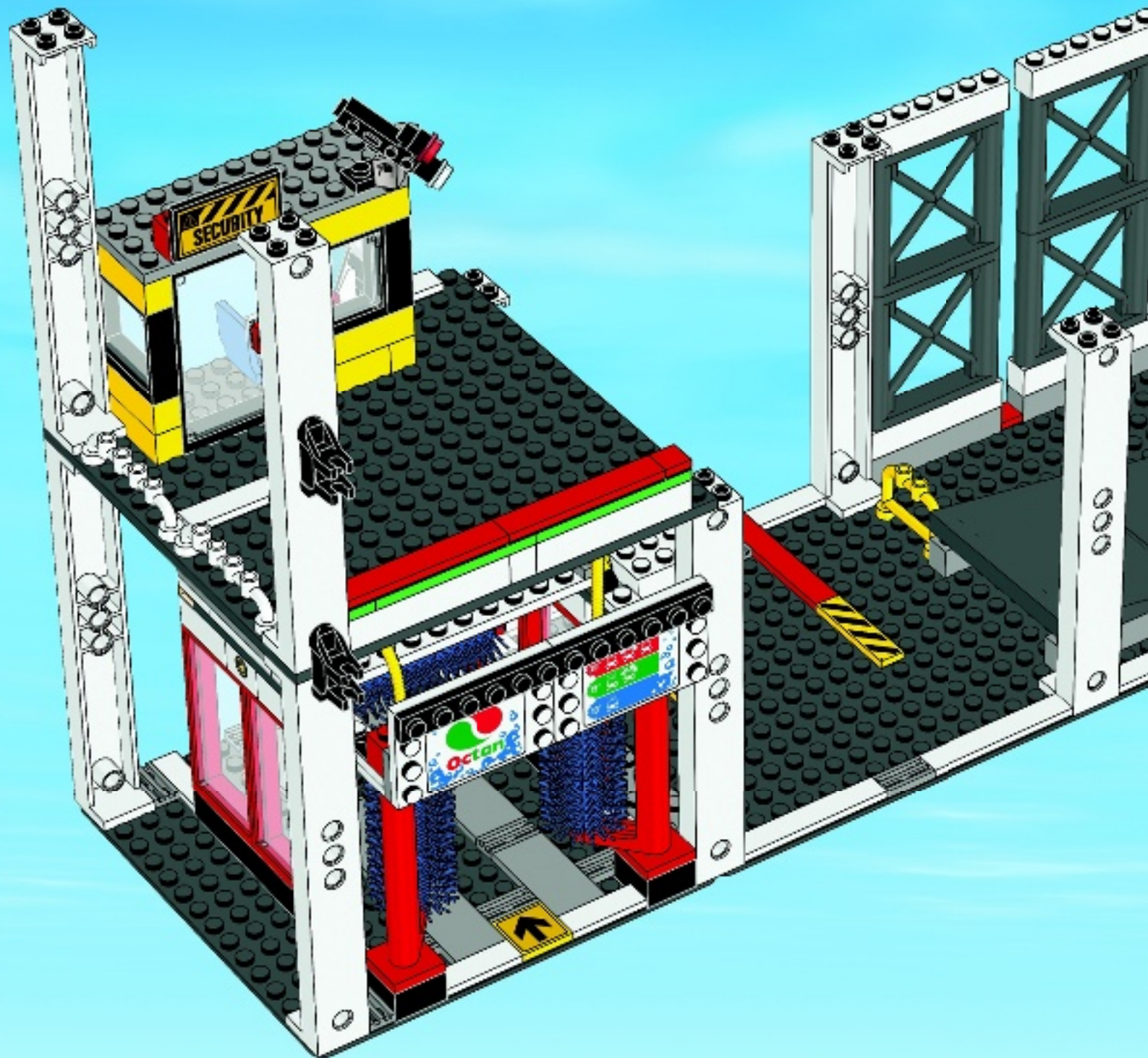

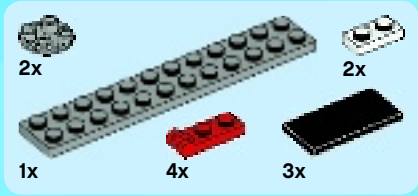

45

1

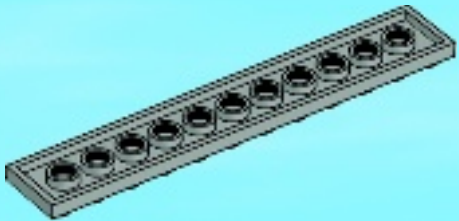

2

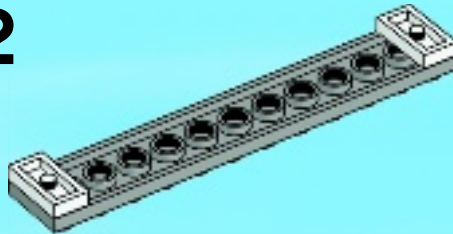

3

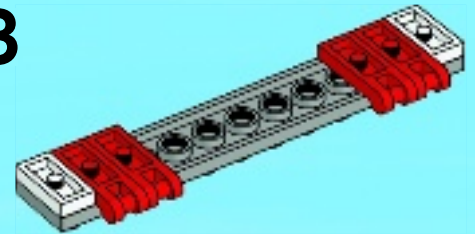

4

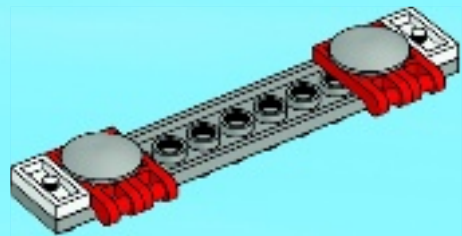

5

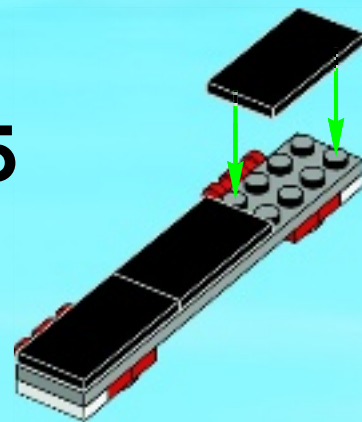

6

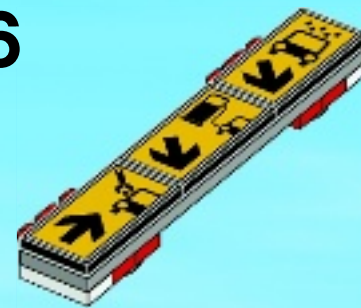

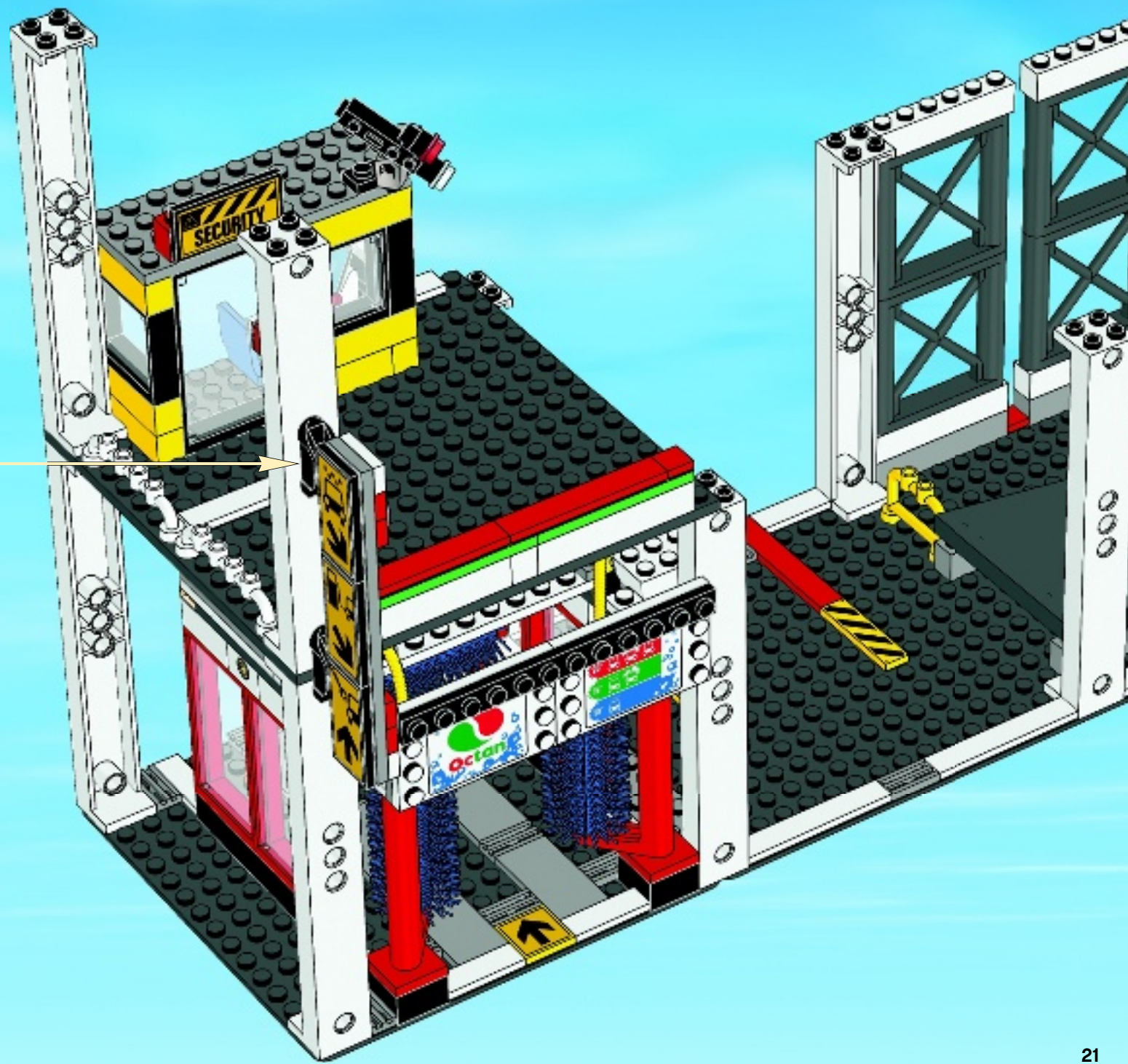

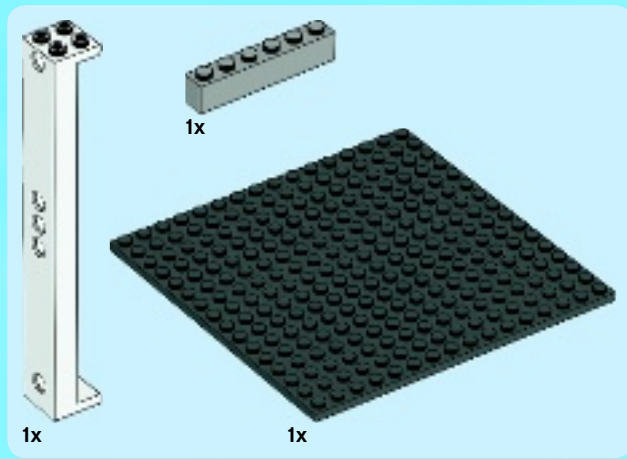
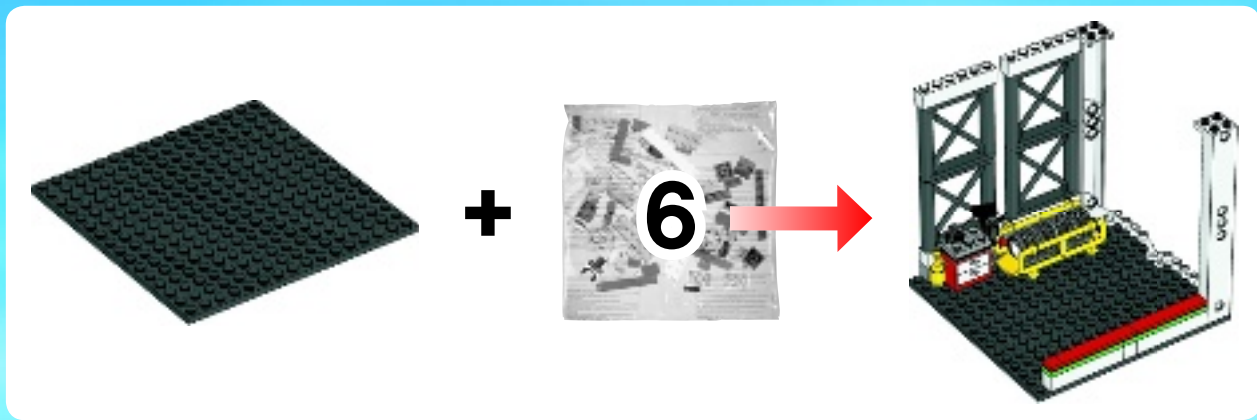

1

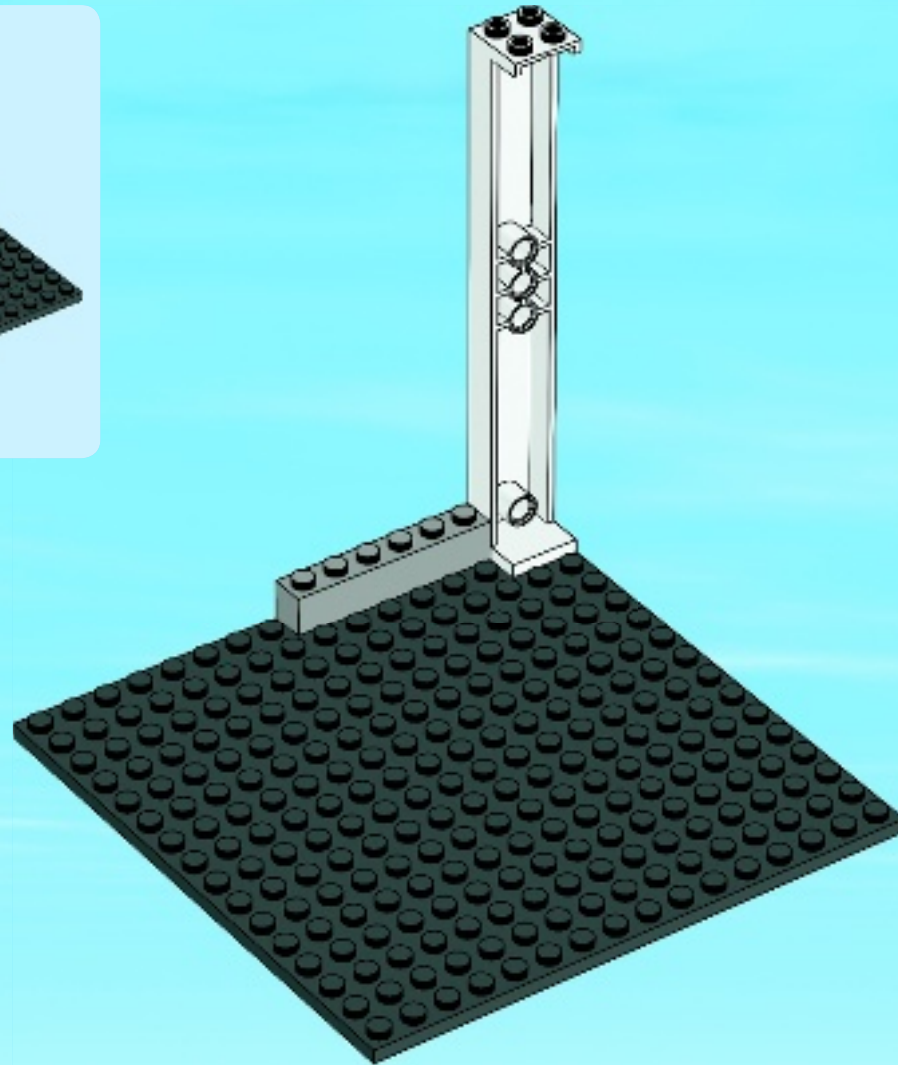

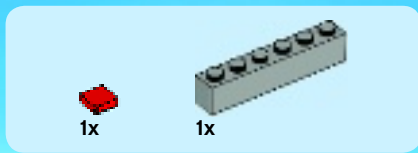

2

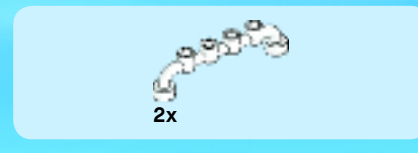
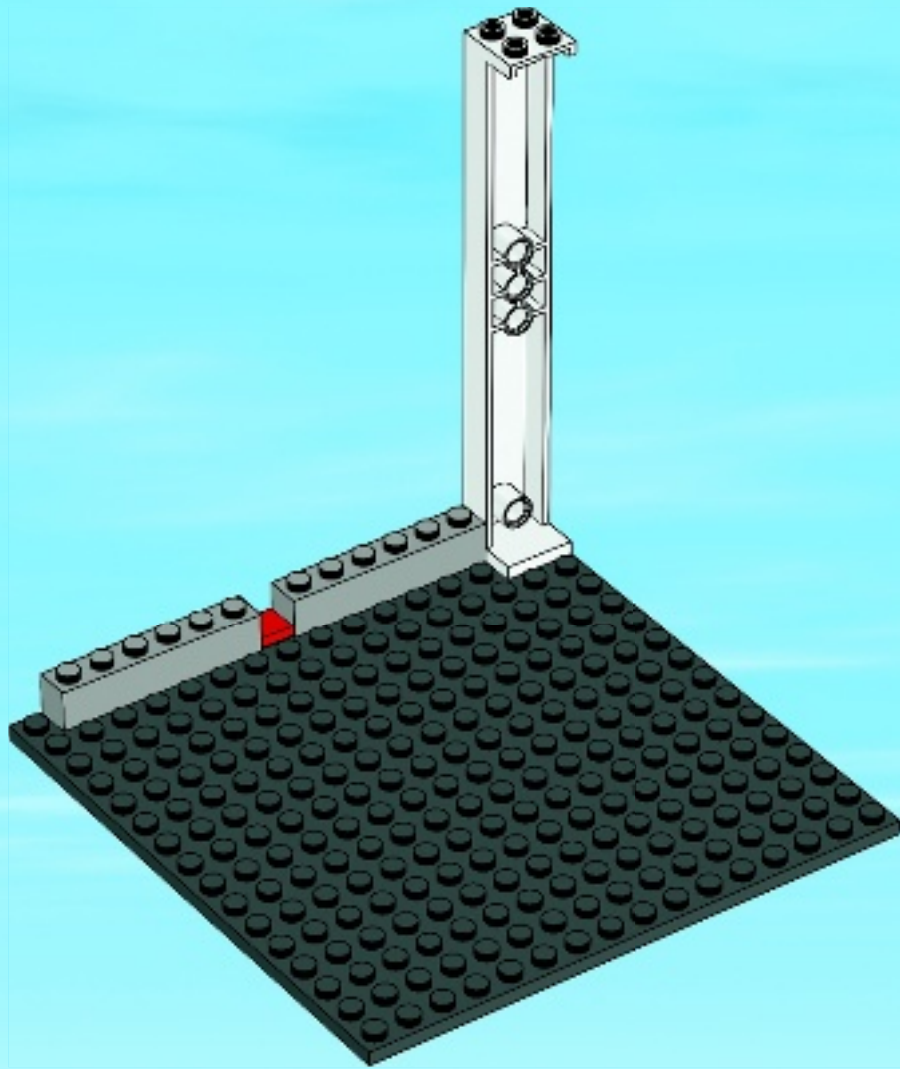

3

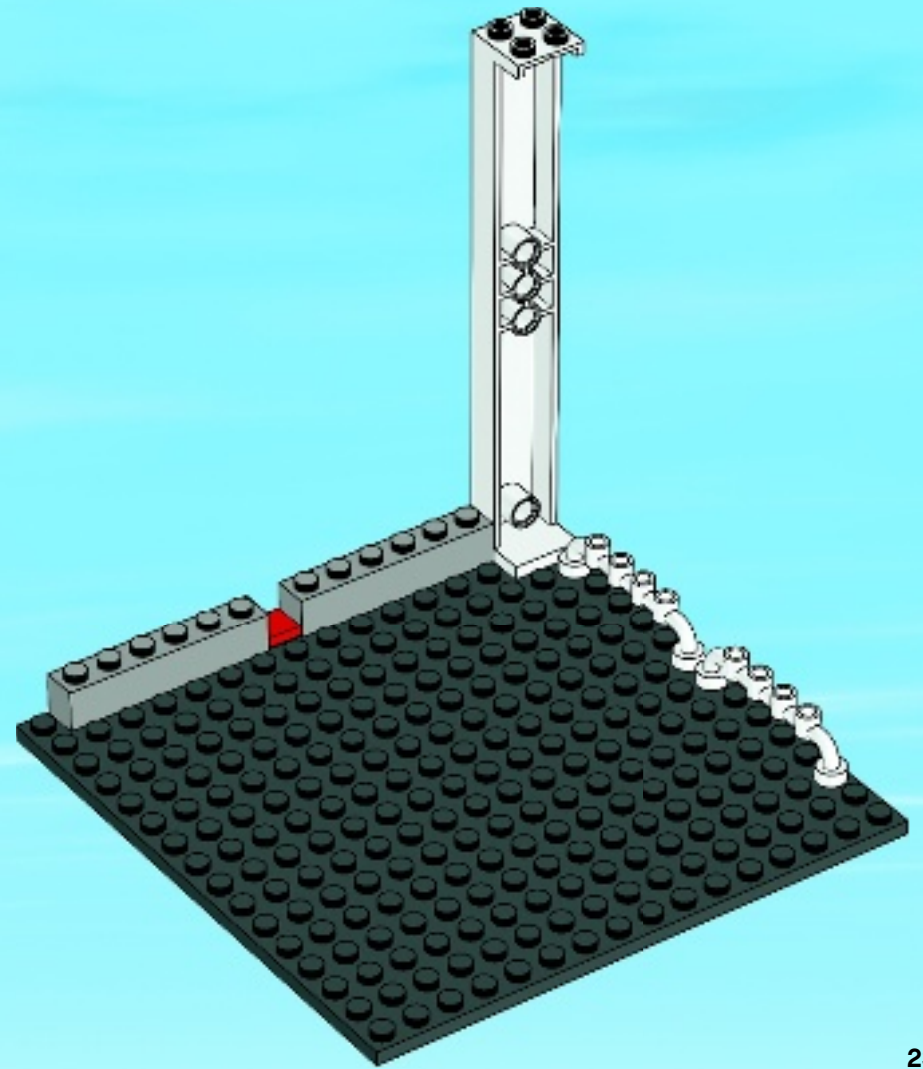

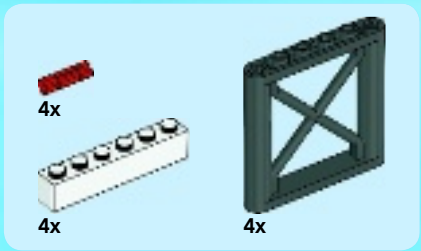

4

1

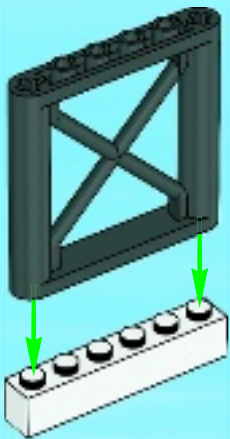

2

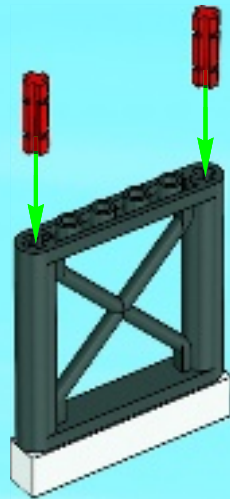

3

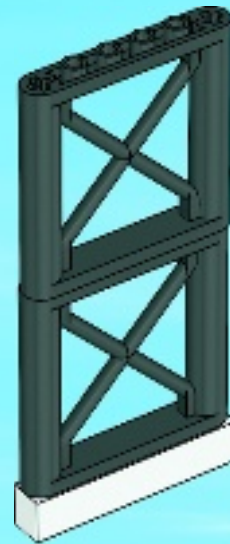

4

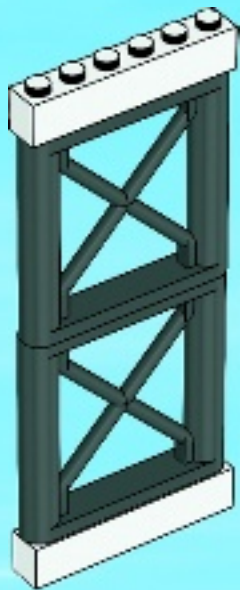

2x

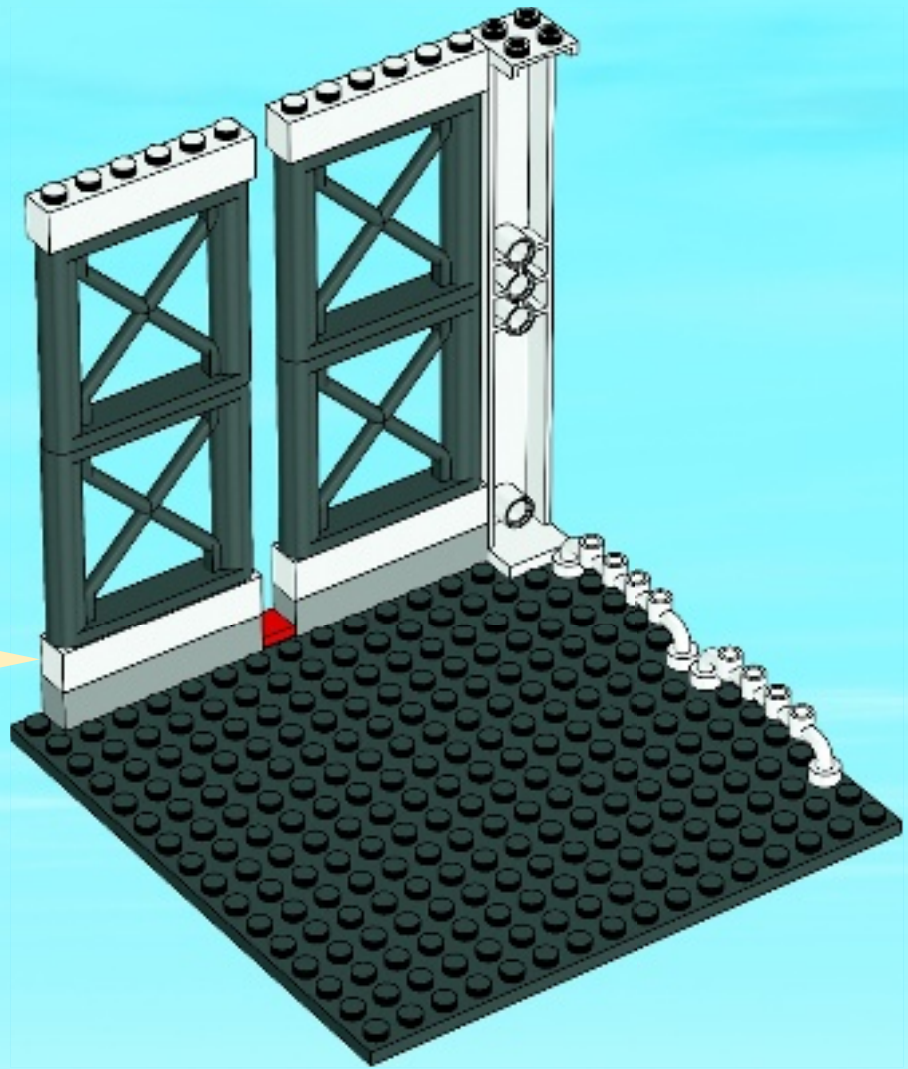



1x



1x



1x

5

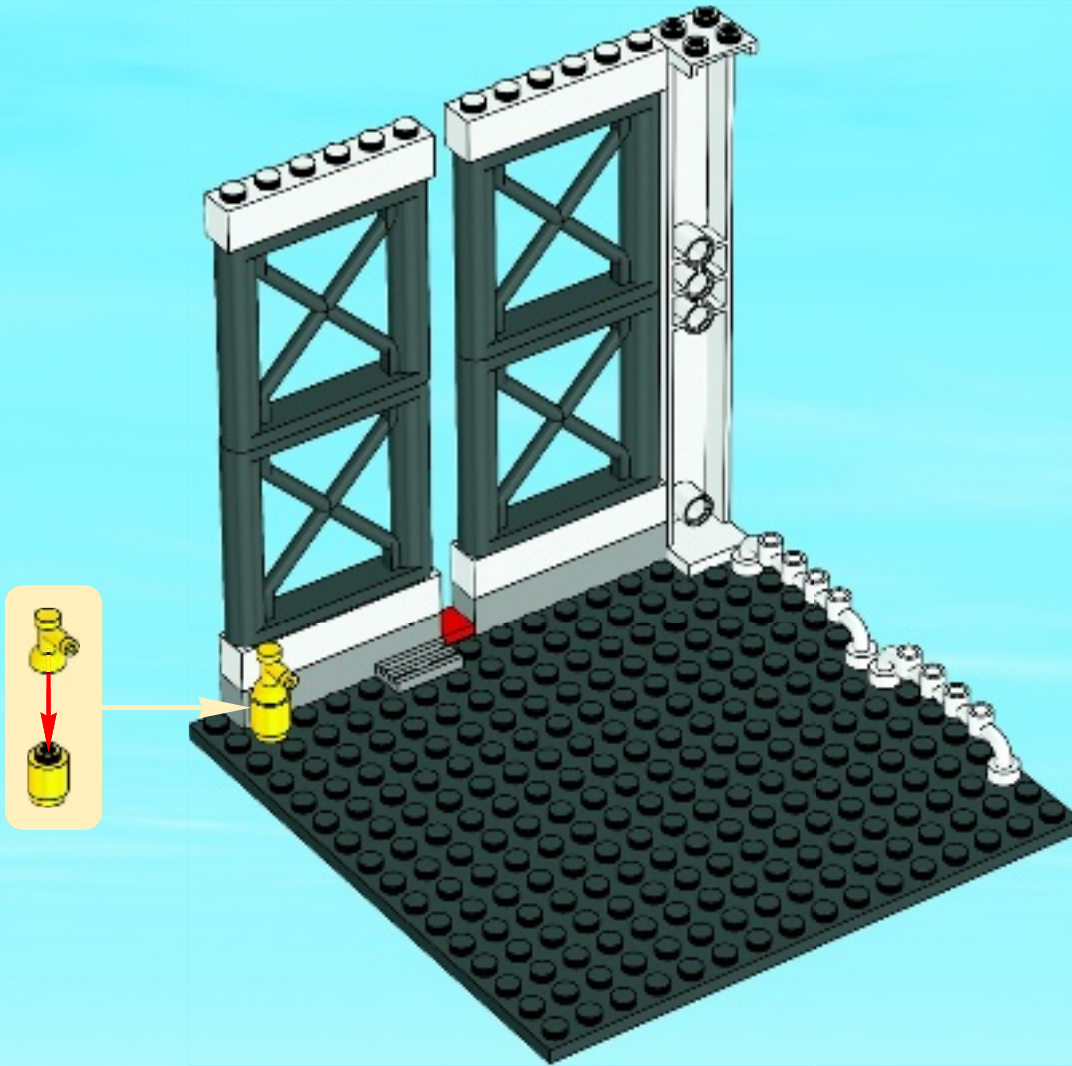

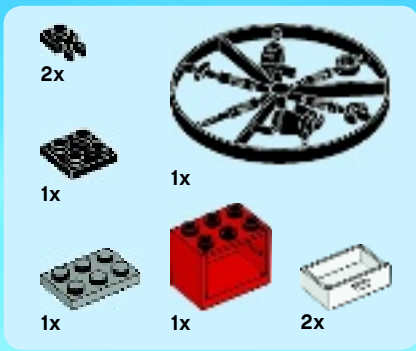

6

1



2

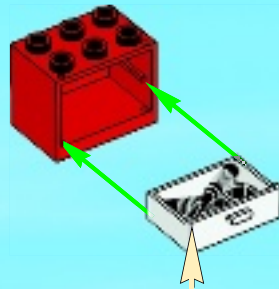

3

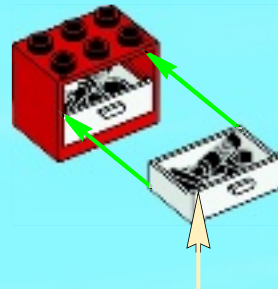

4



5



6

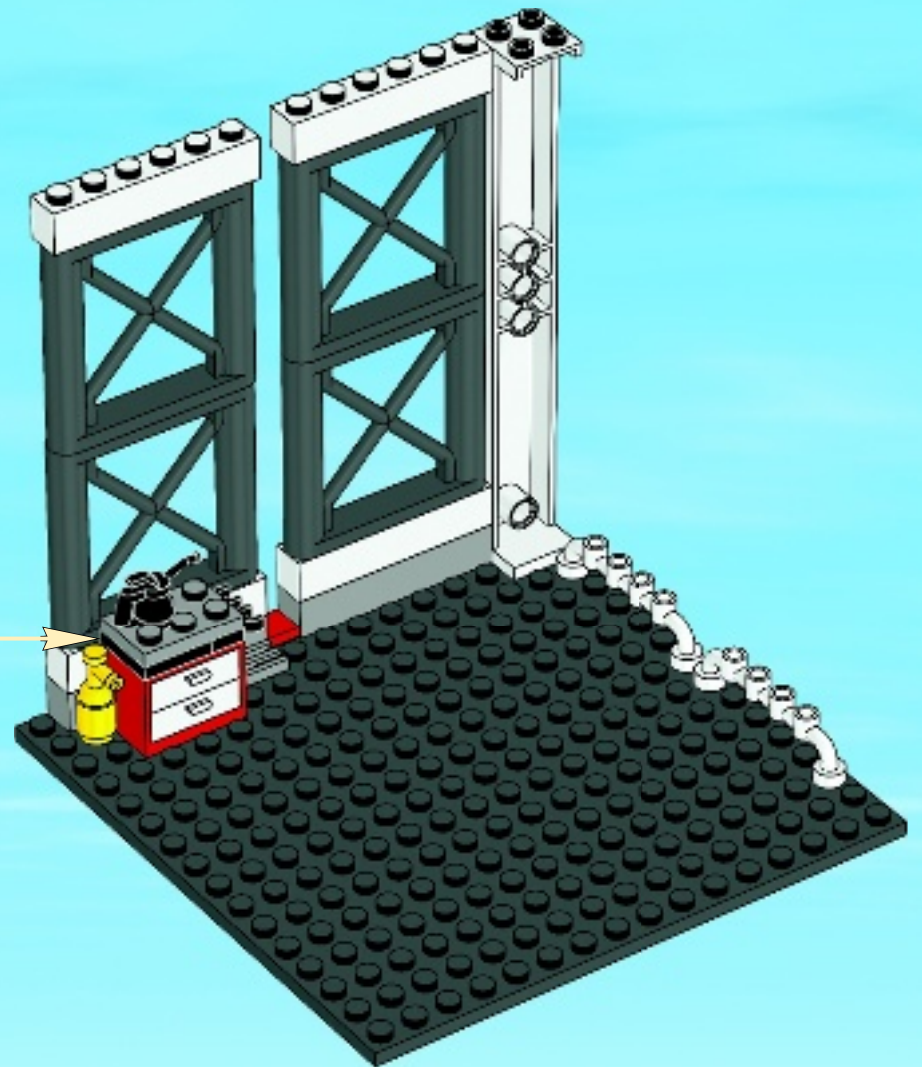

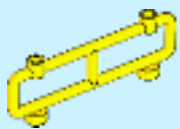

1x

7

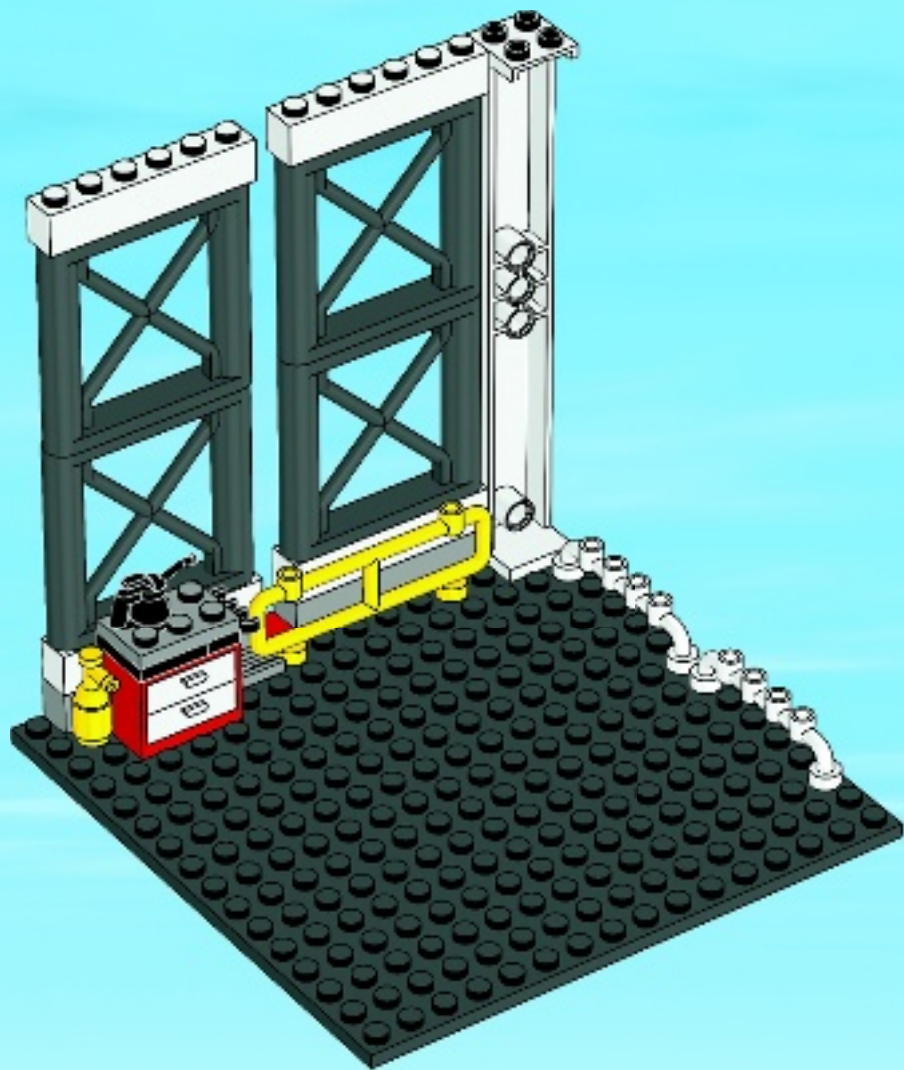

1x



2x

8

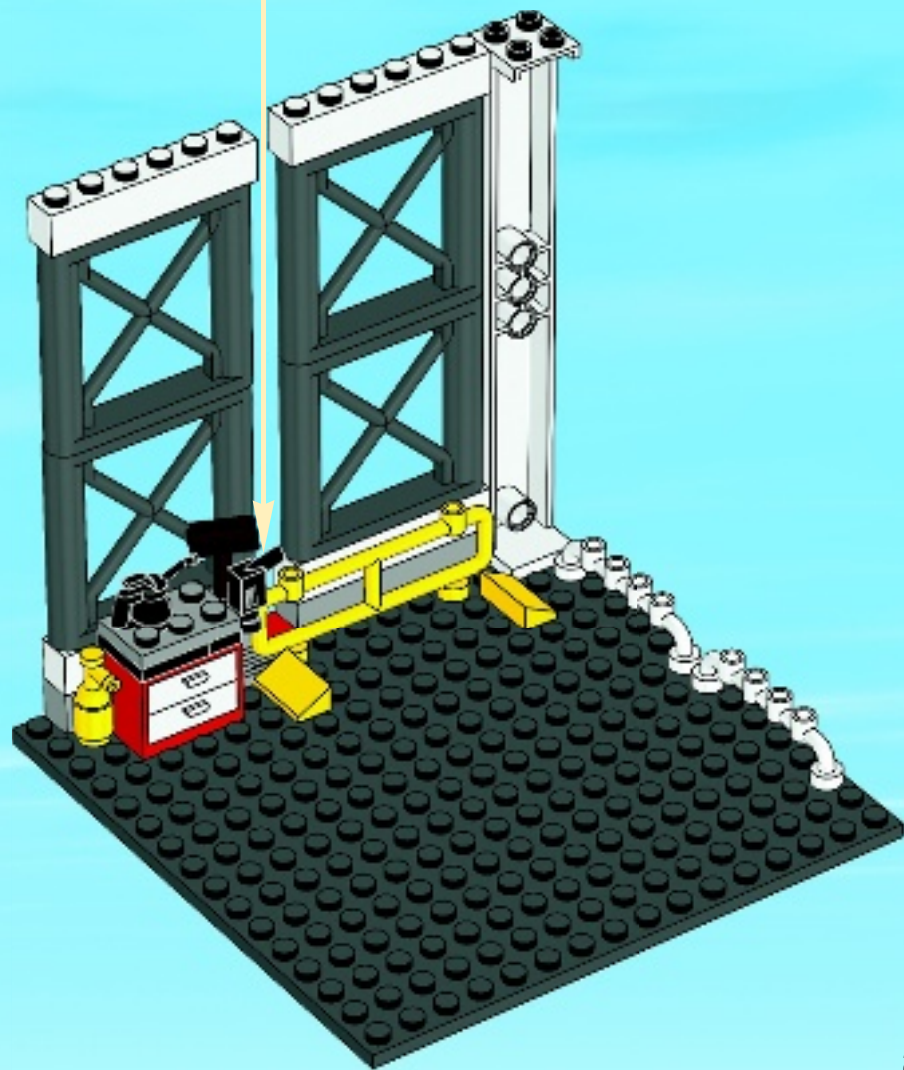

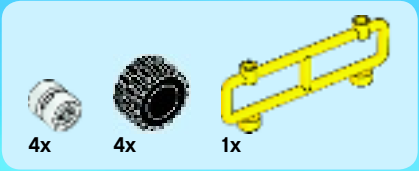

9

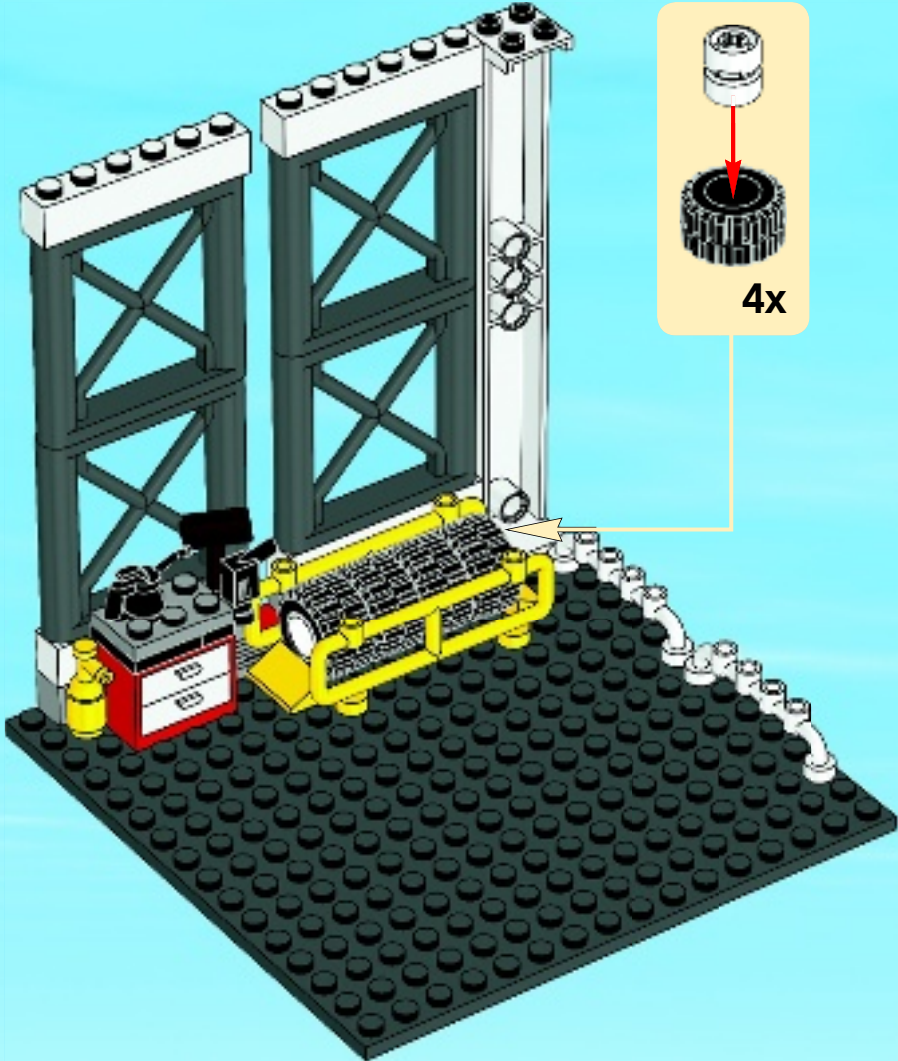

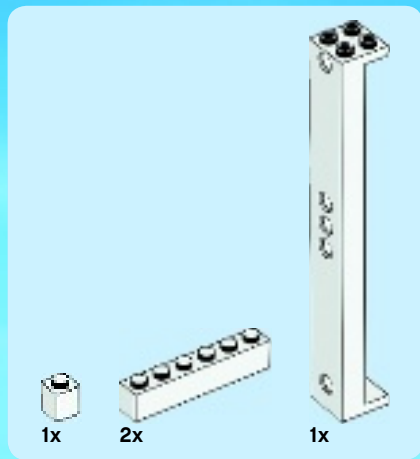

10

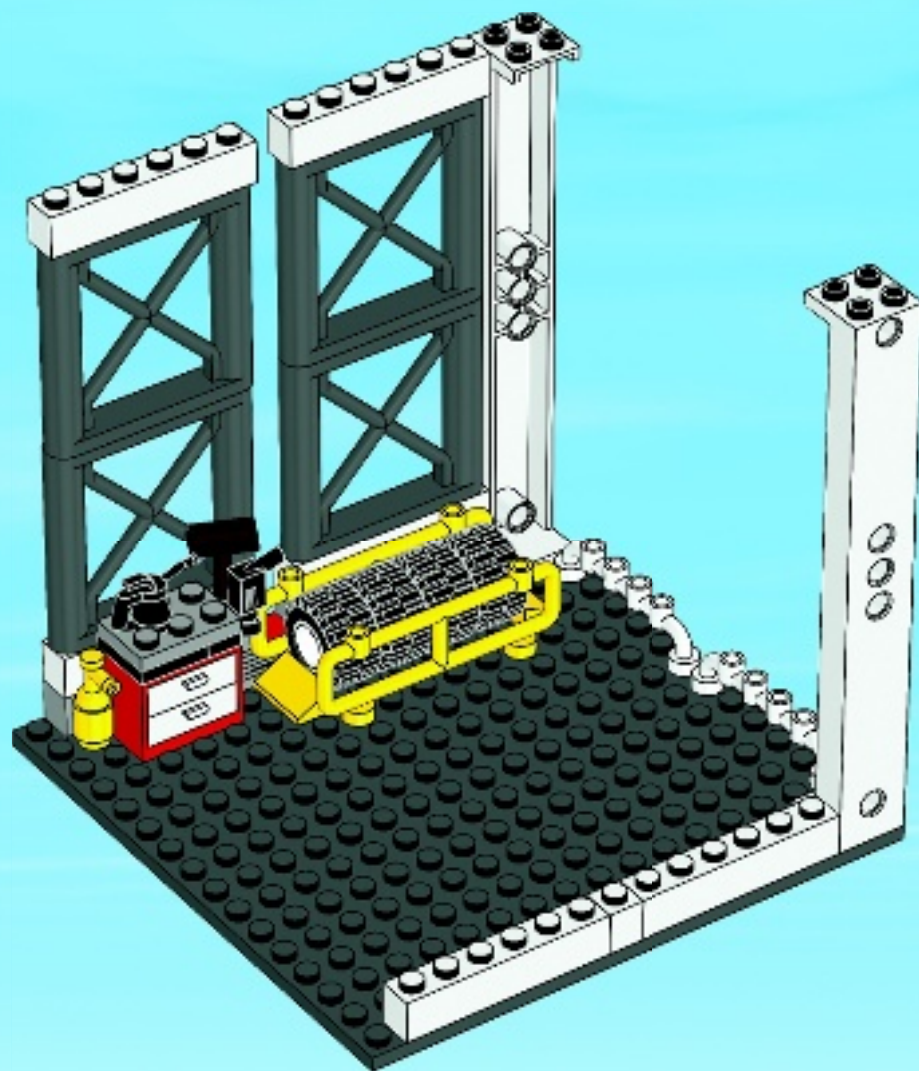

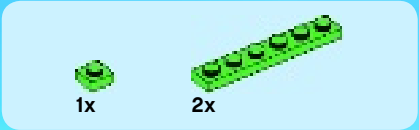

11

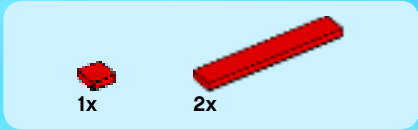
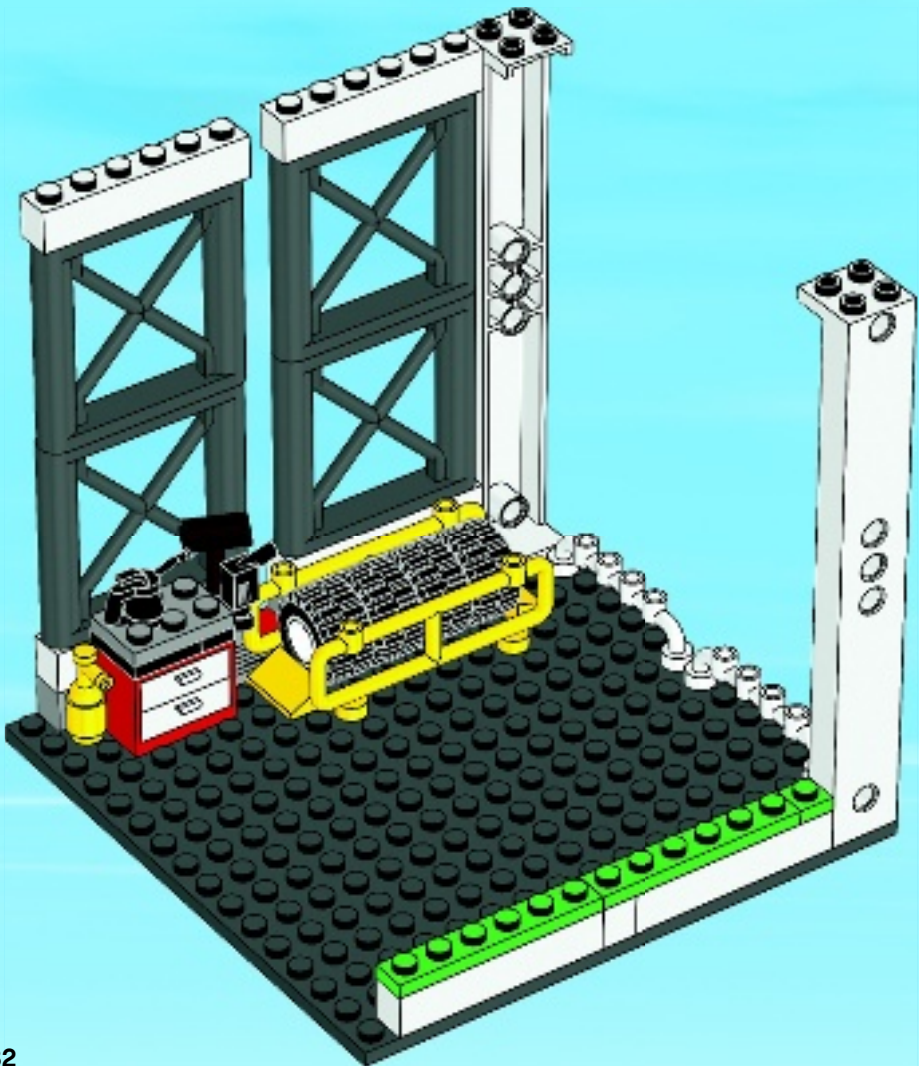

12

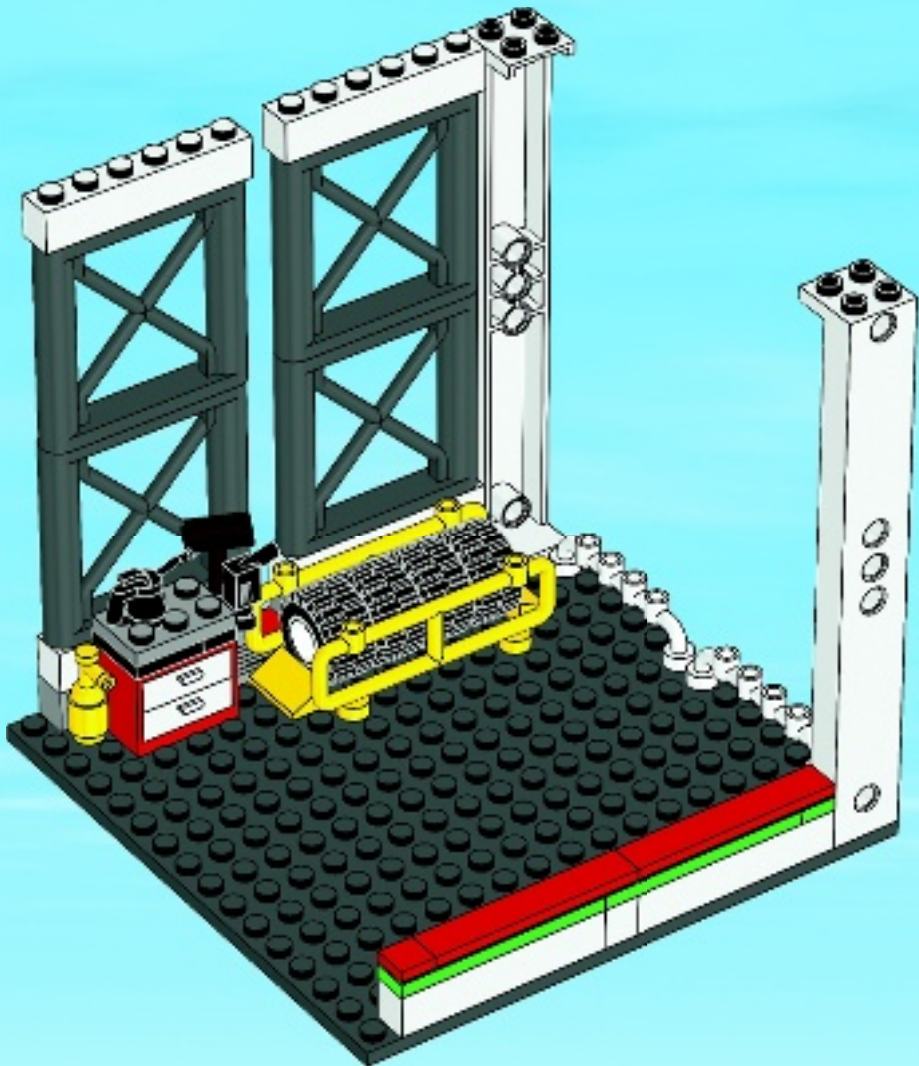

46

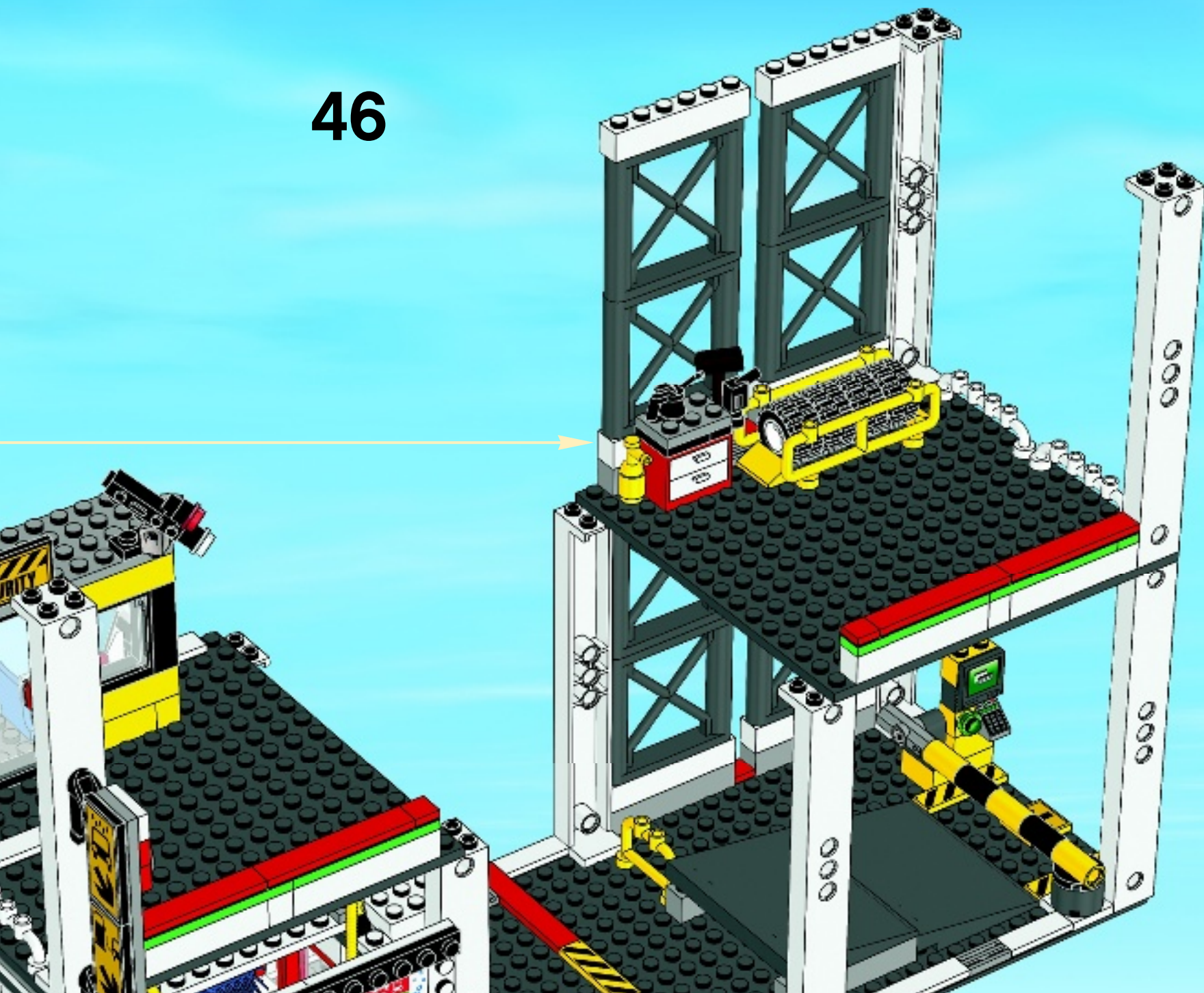

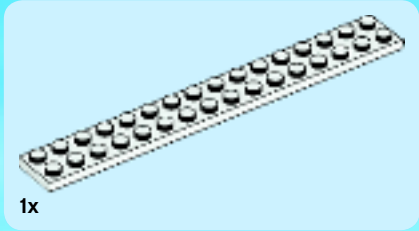

1

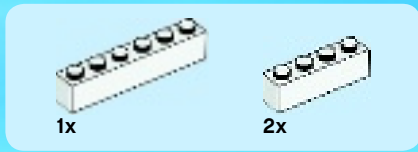
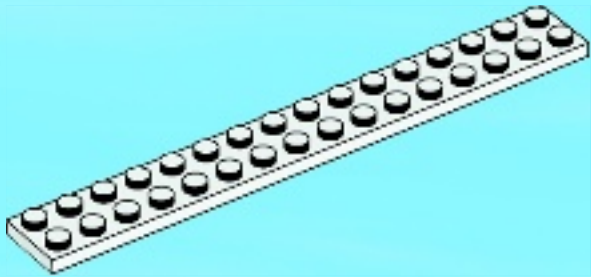

2

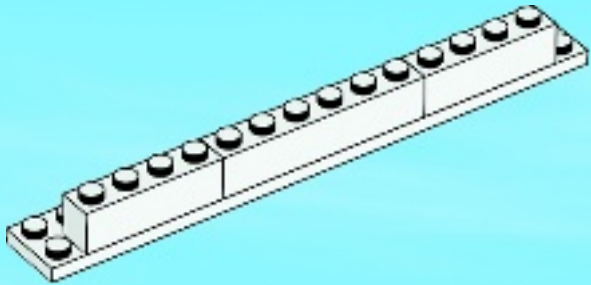

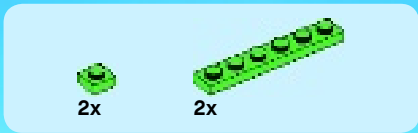

3

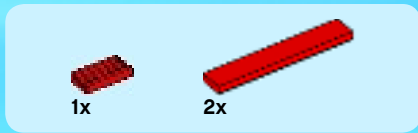
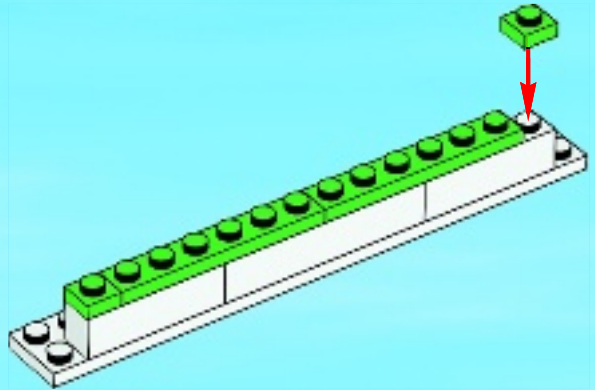

4

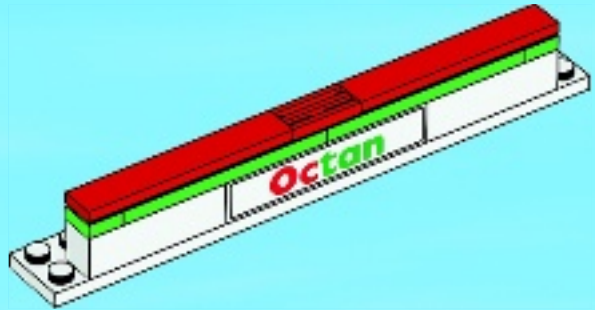

47

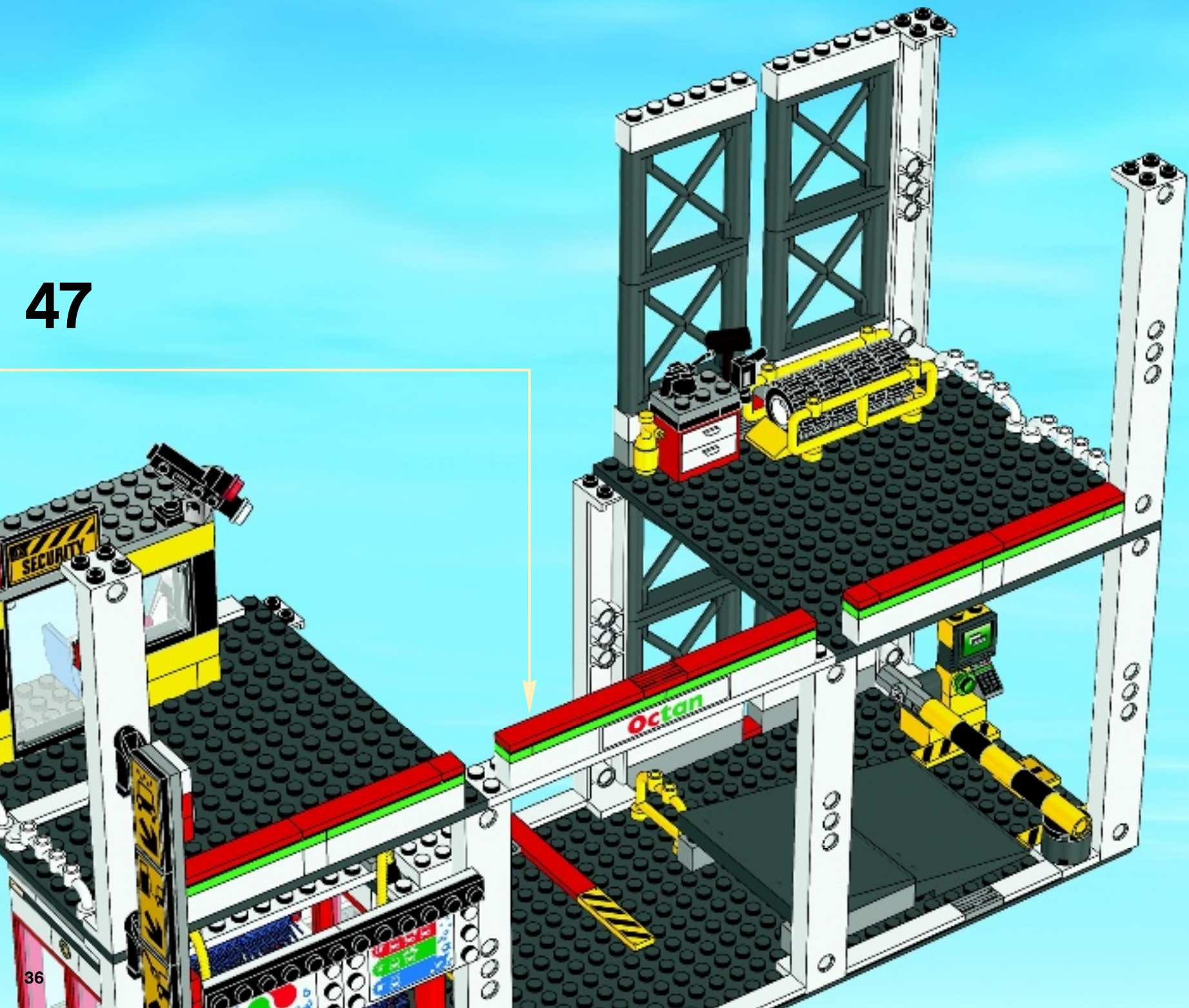



2x

48



2x

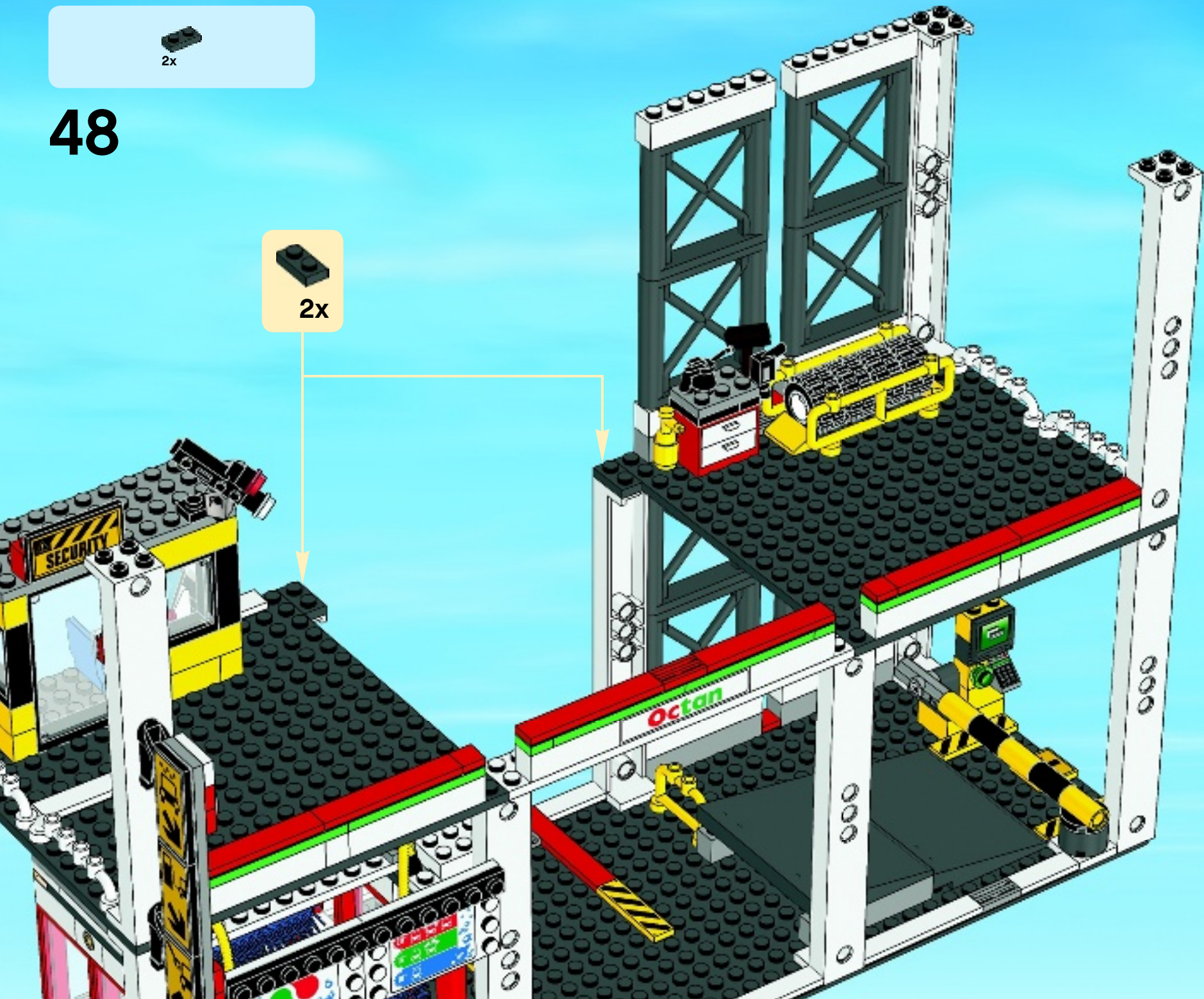

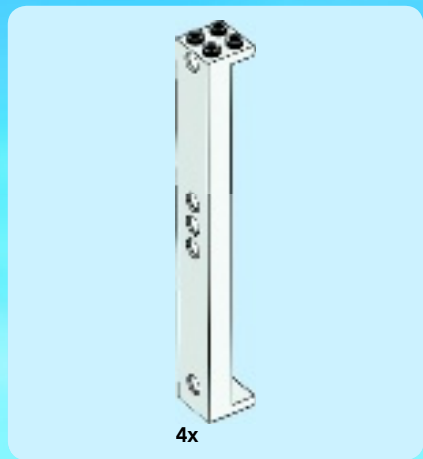

49

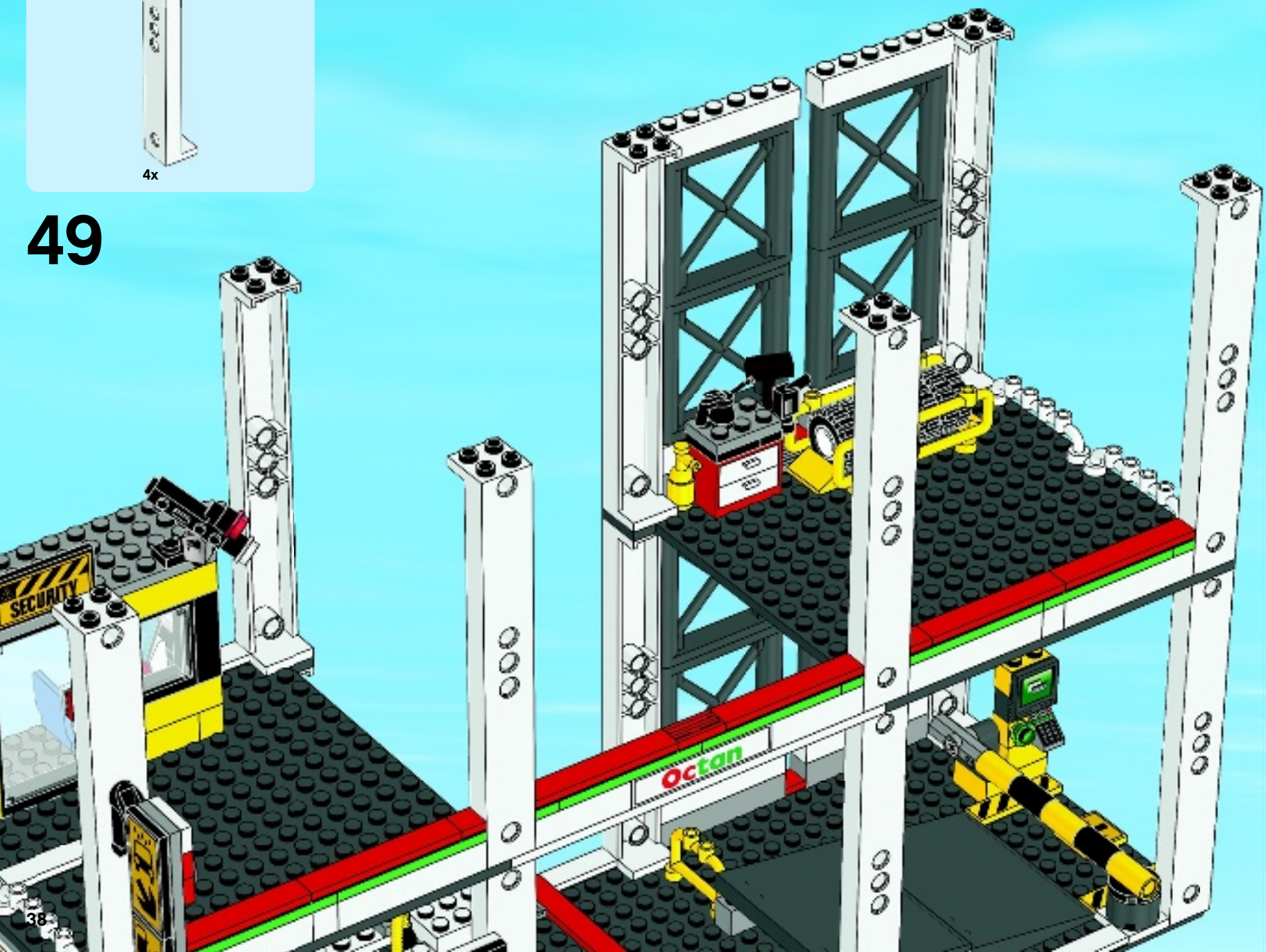



2x

50

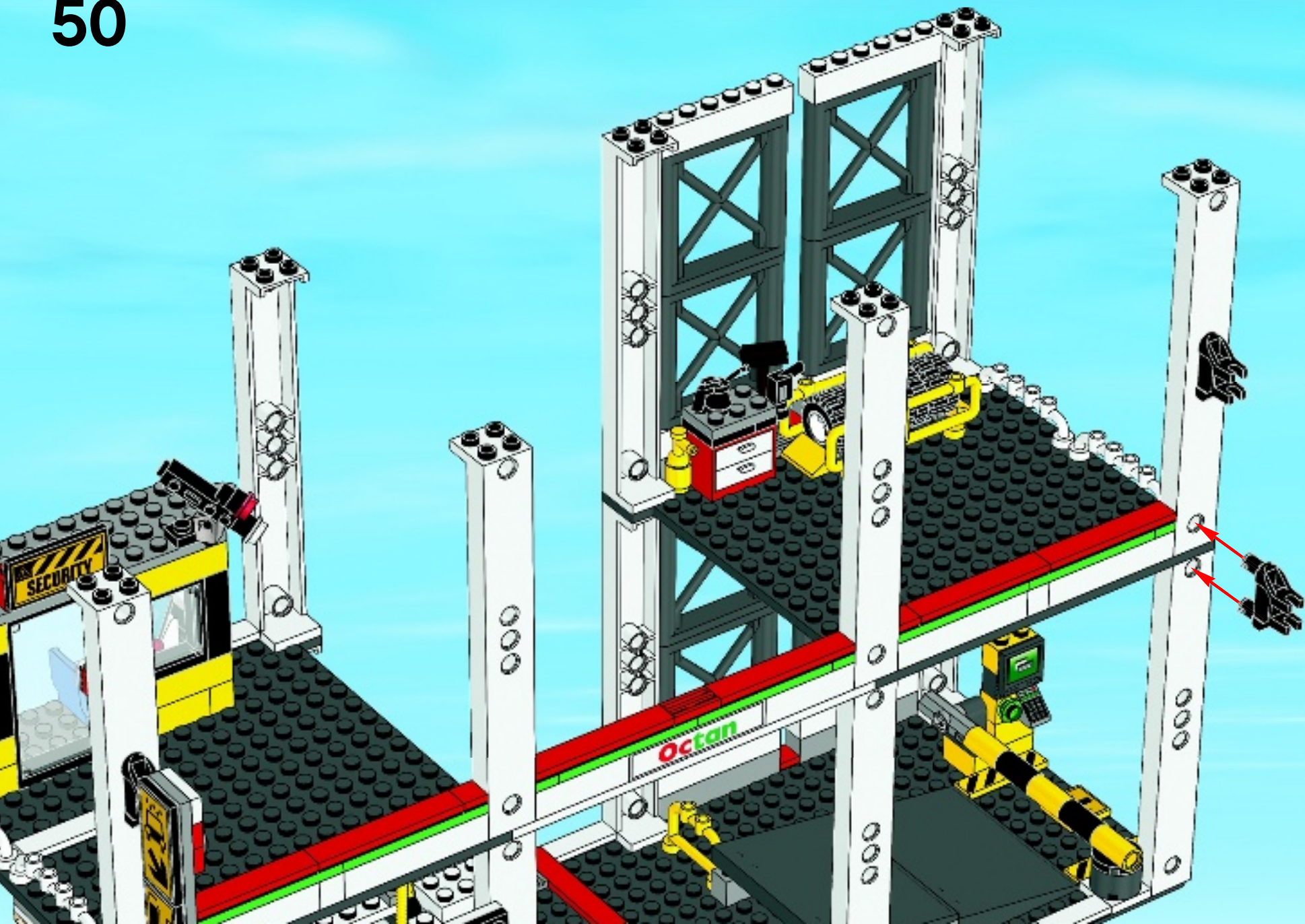

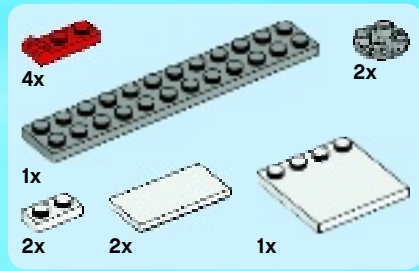

51

1

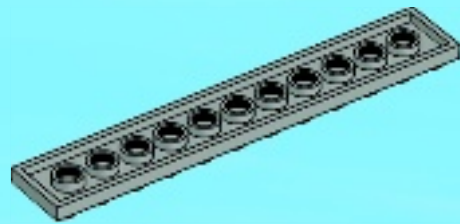

2

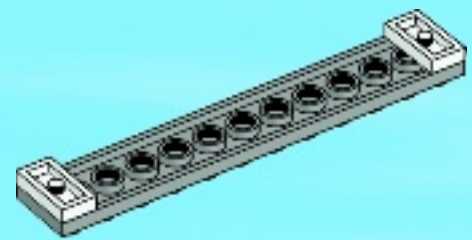

3

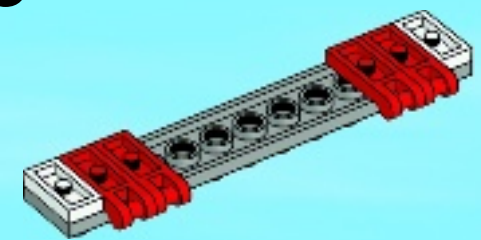

4

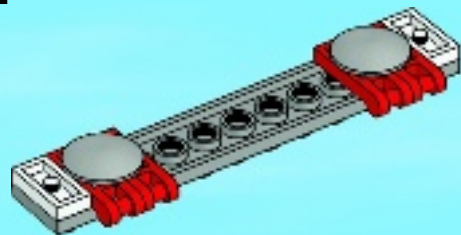

5

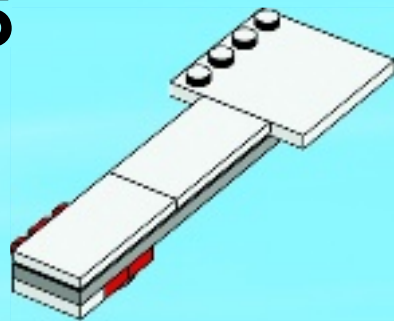

6

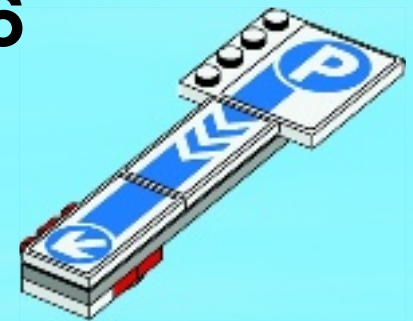

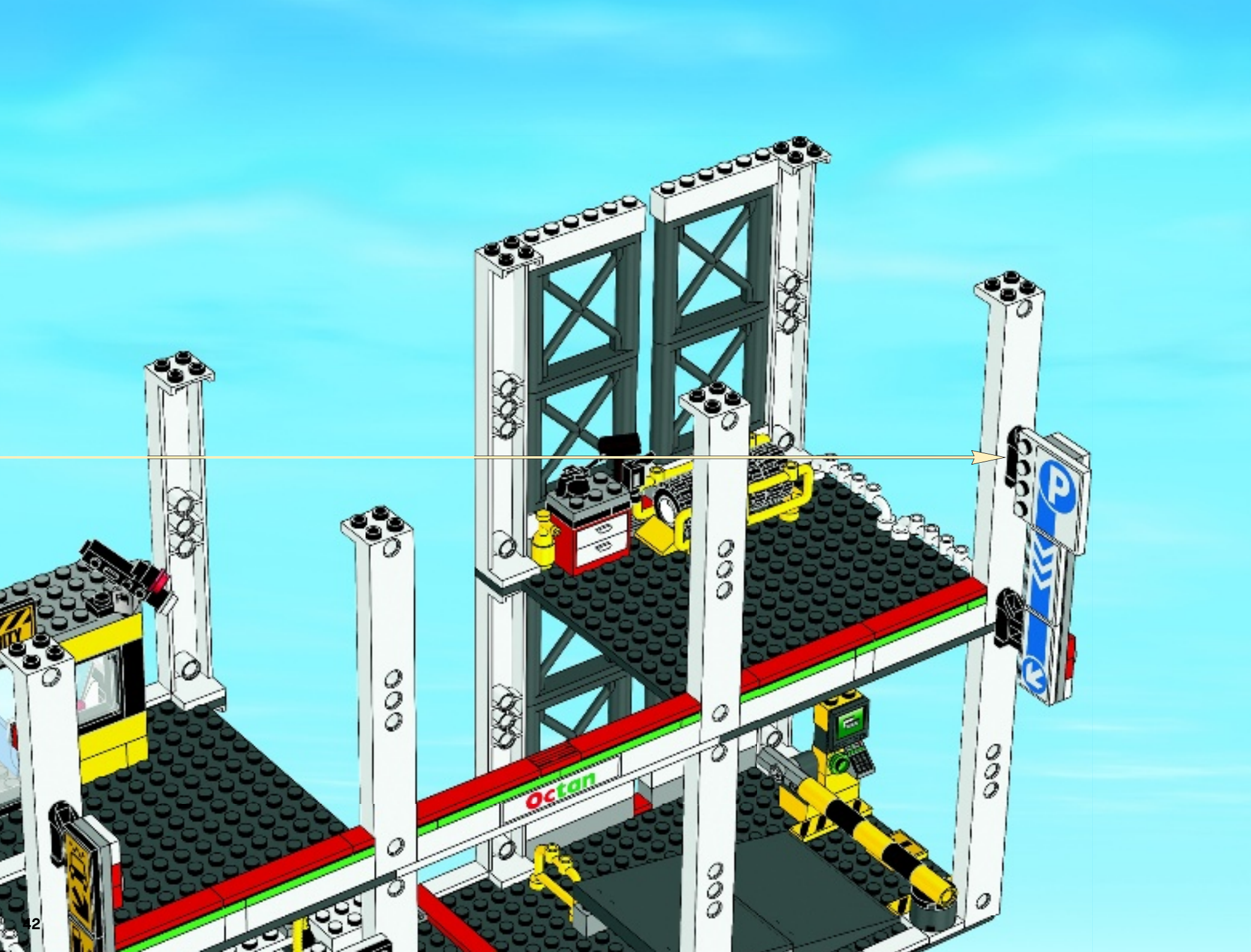

8x

52

8x

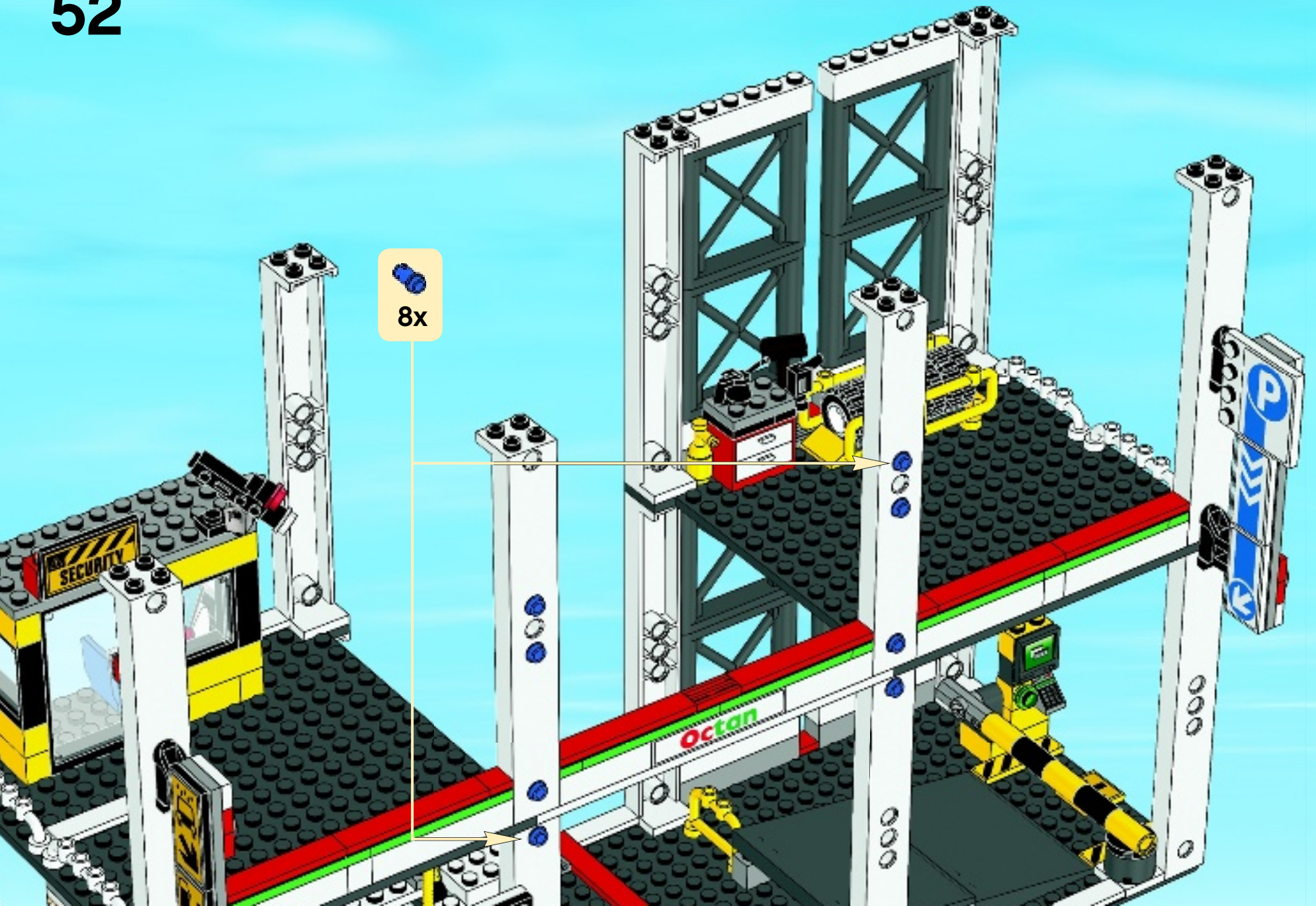



2x

53

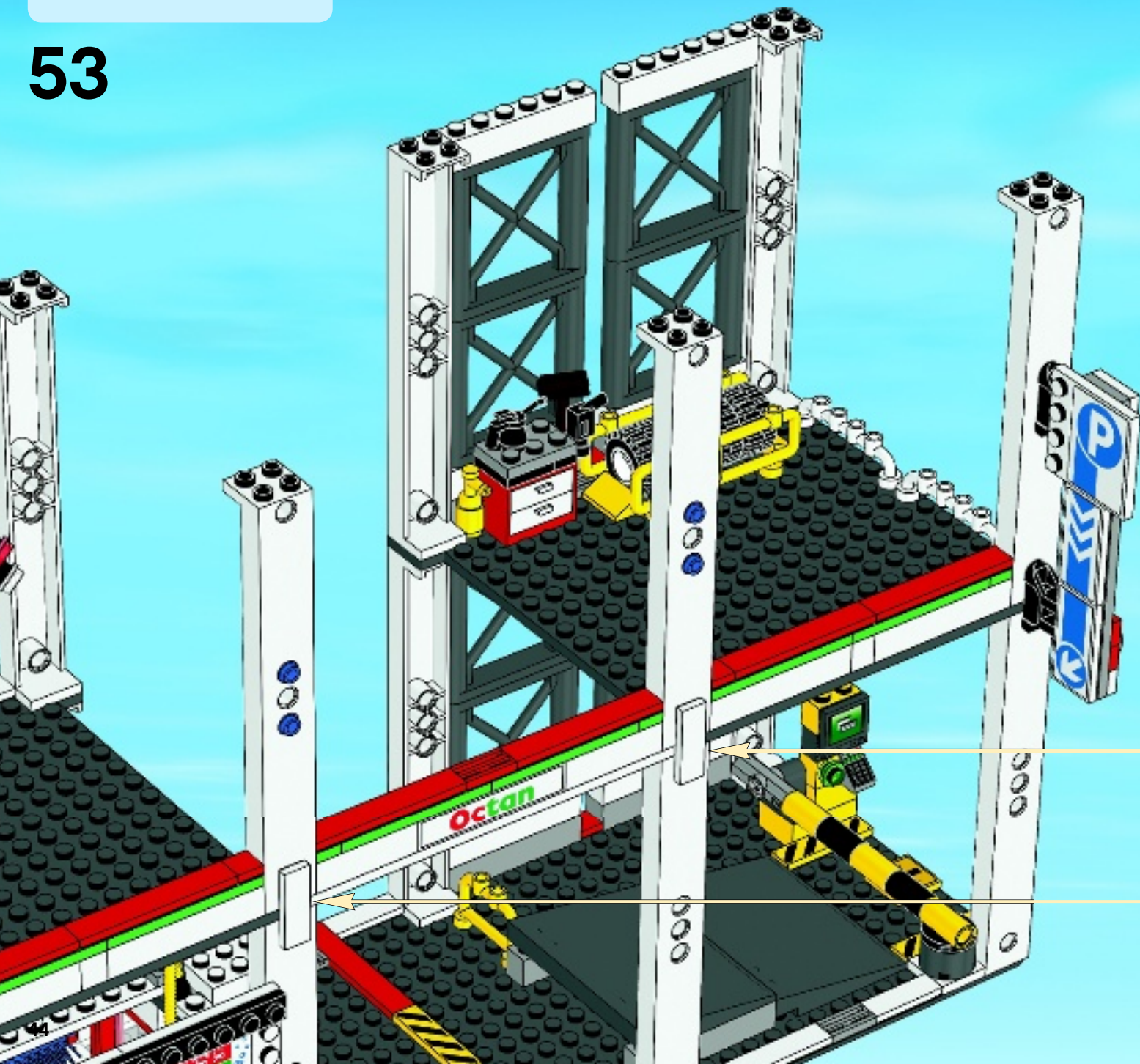

2x



2x



6x

54

1

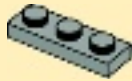

2



2x

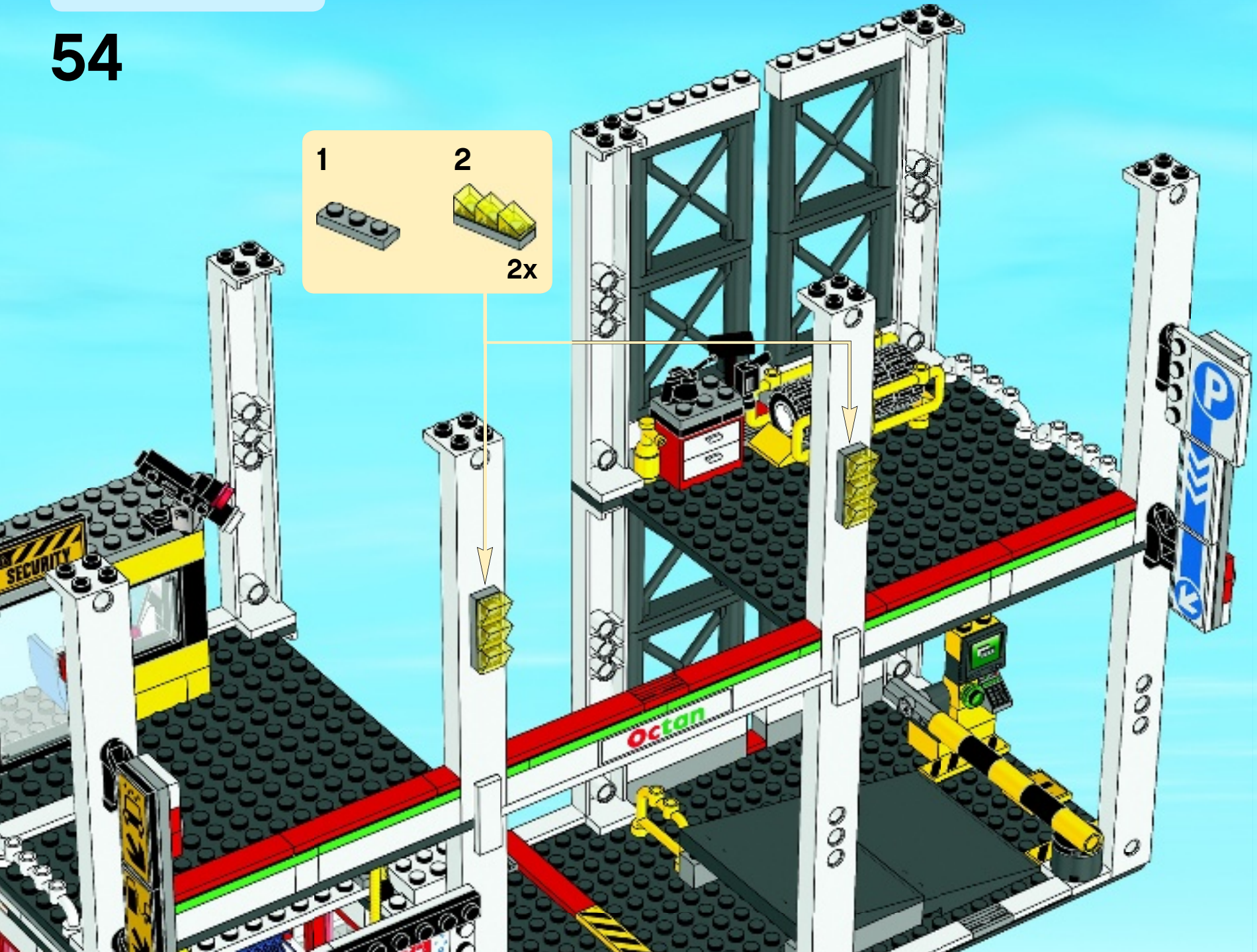

8x

55



8x

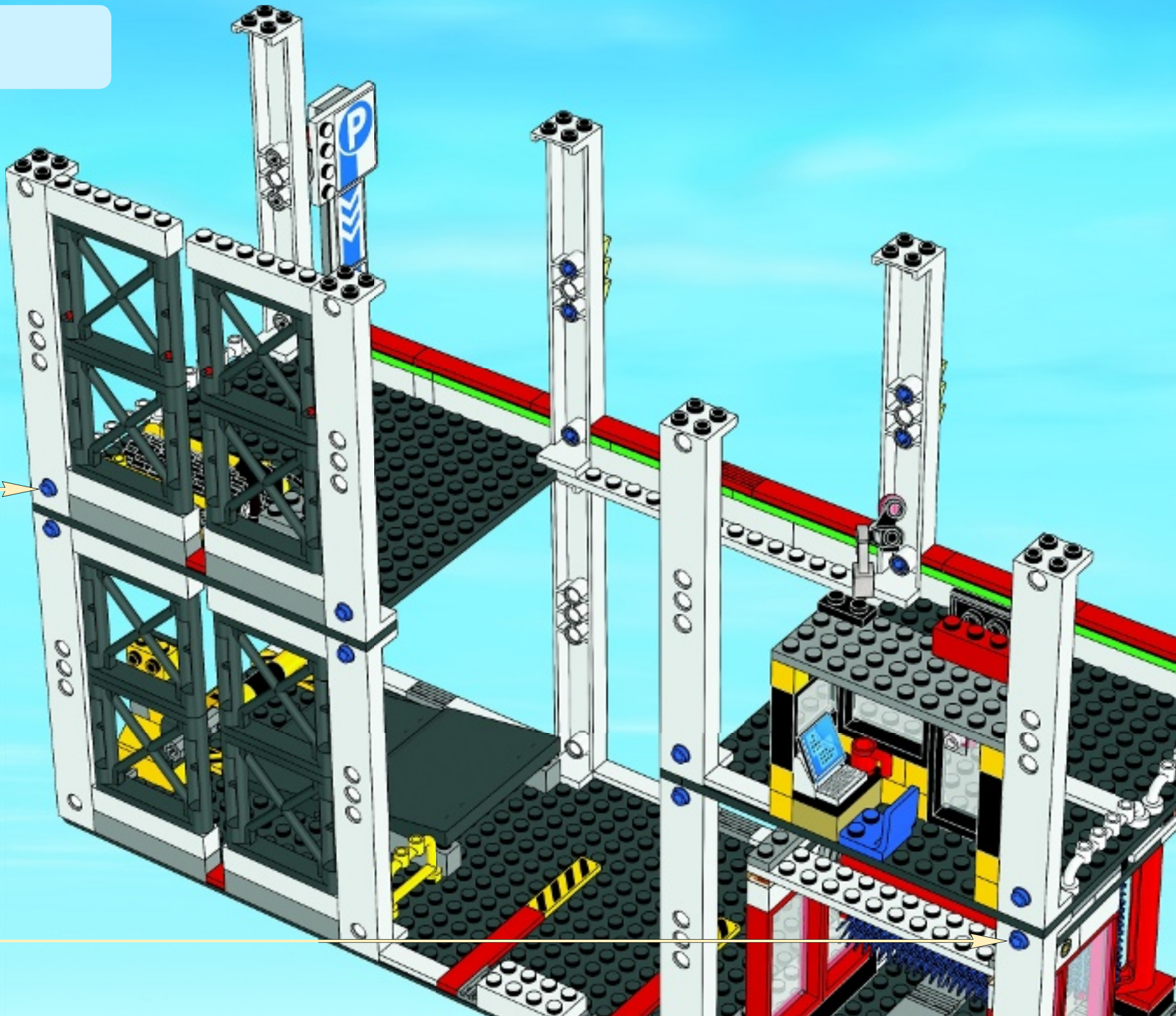



4x

56



4x

