



Friends



41037



1



2



3



4



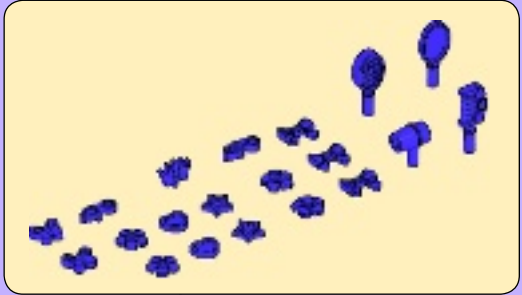
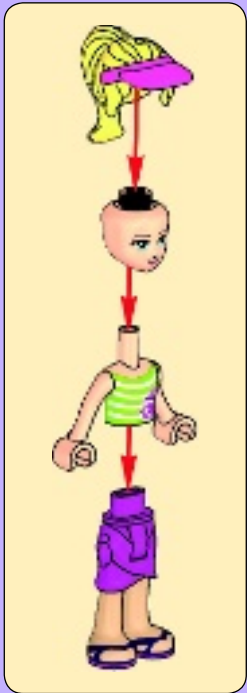
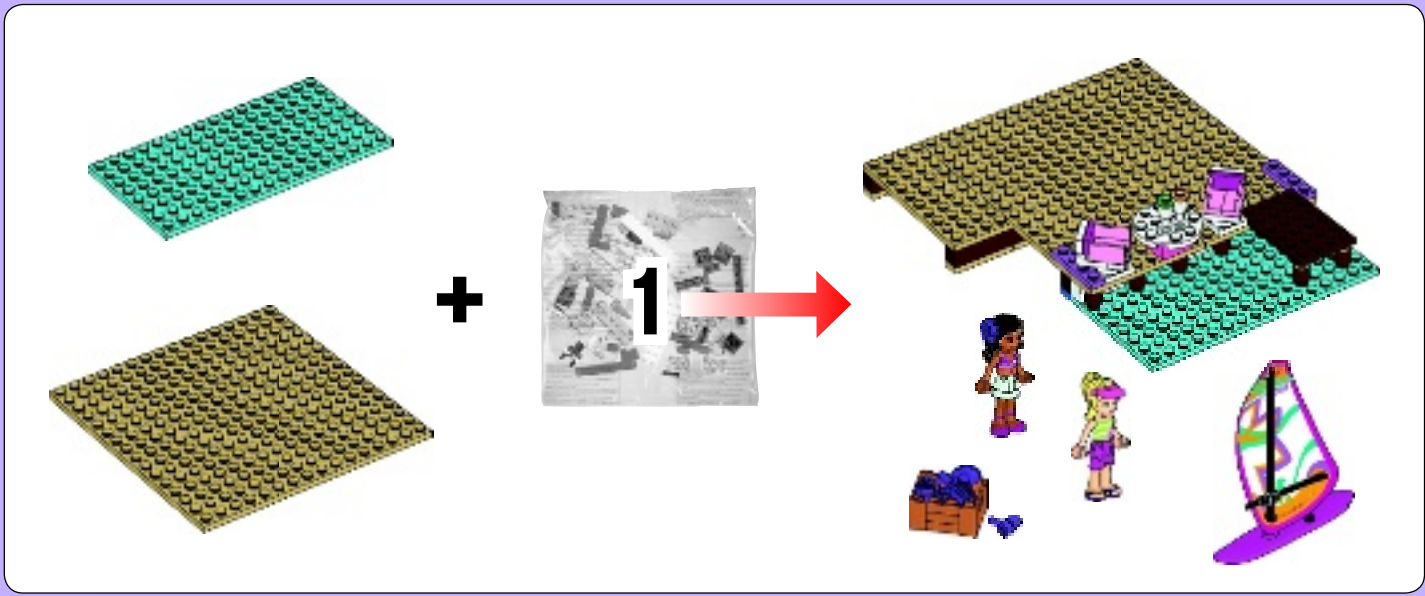

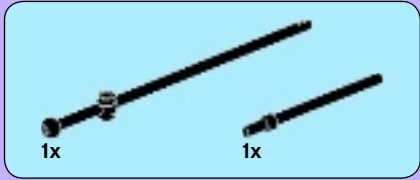

1

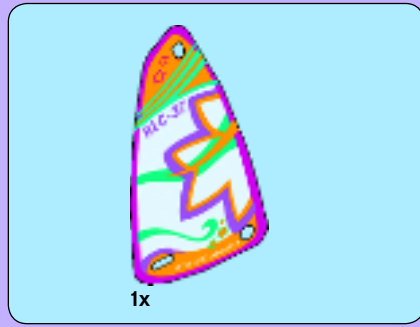

2



3



4



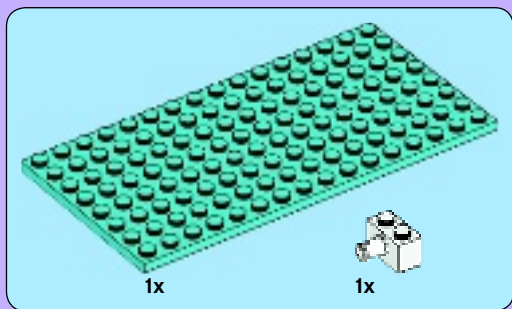
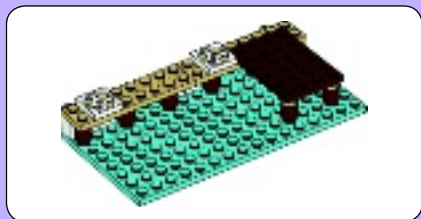

1

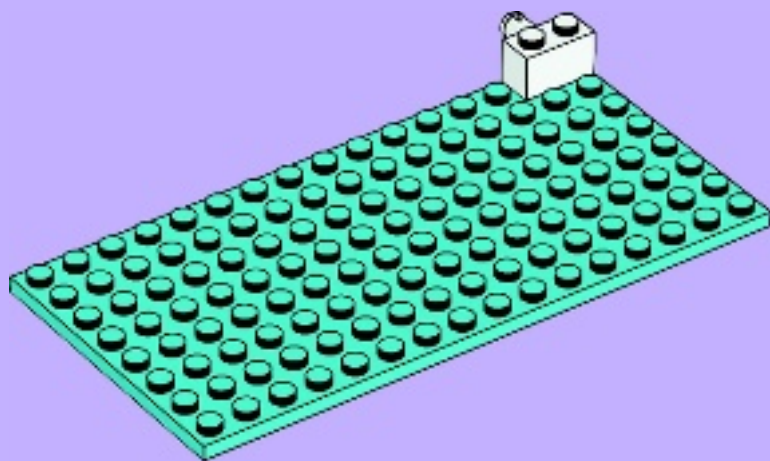

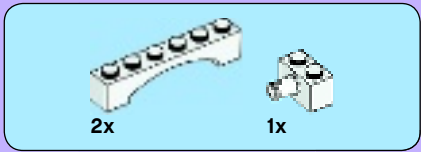

2

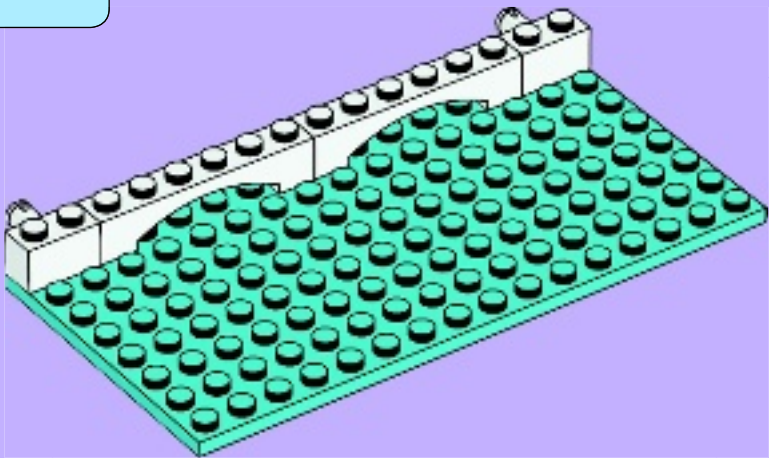

3

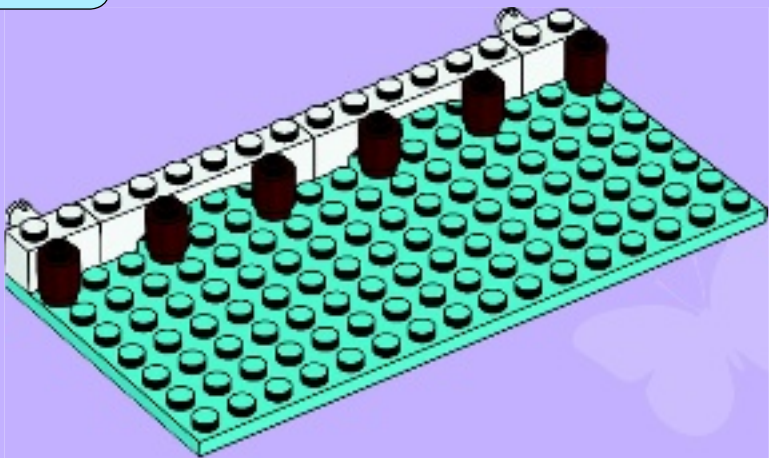

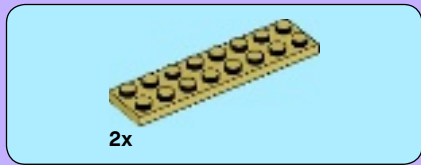

4

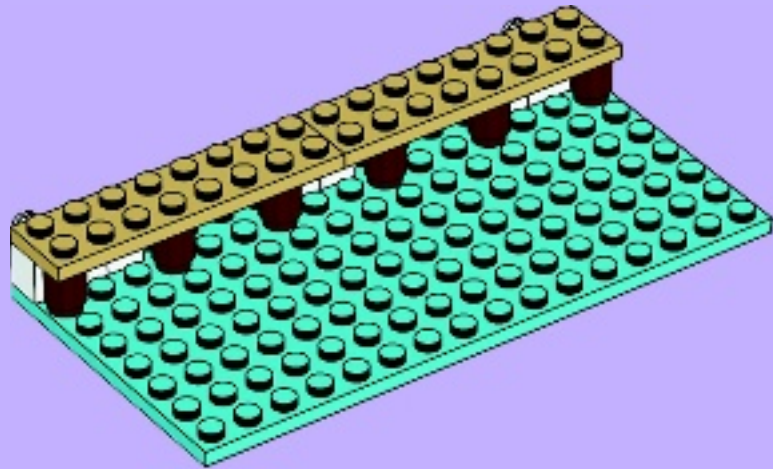

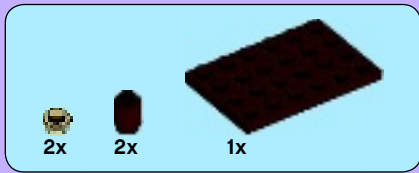

5

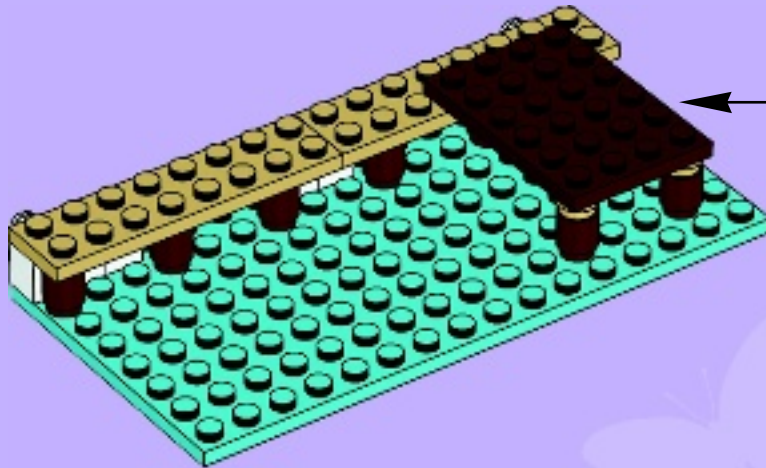
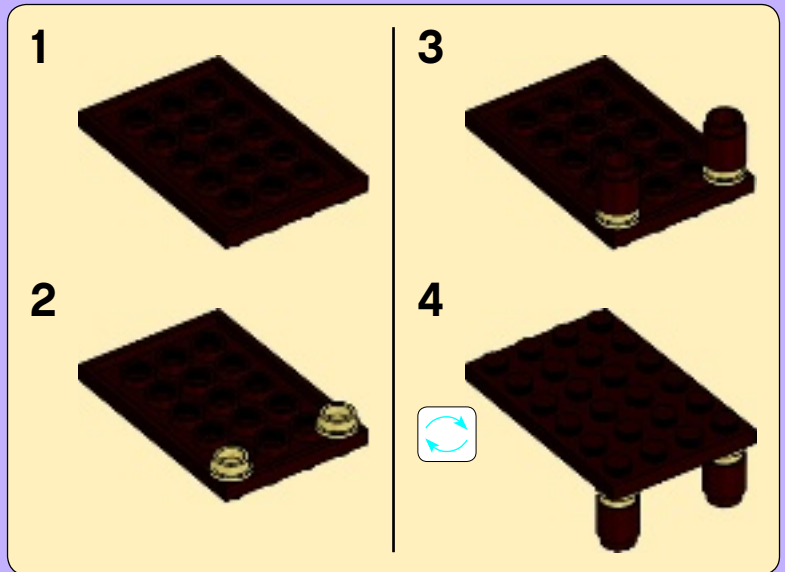

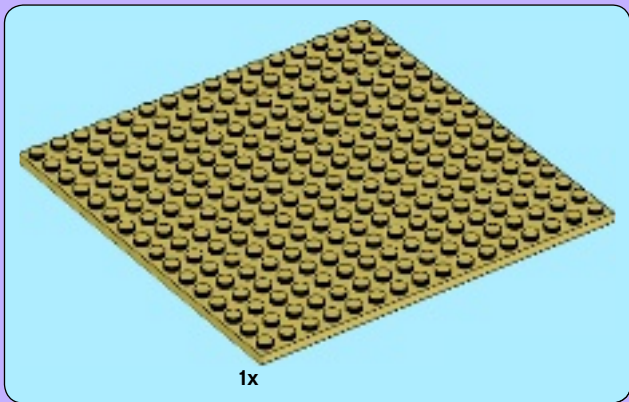
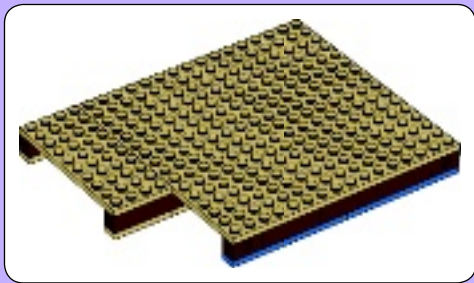

6

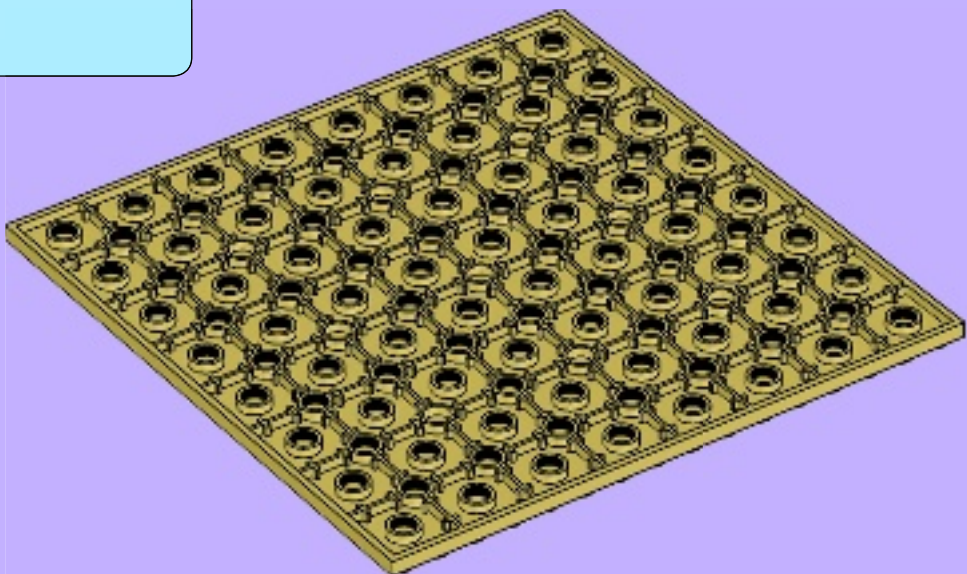



7

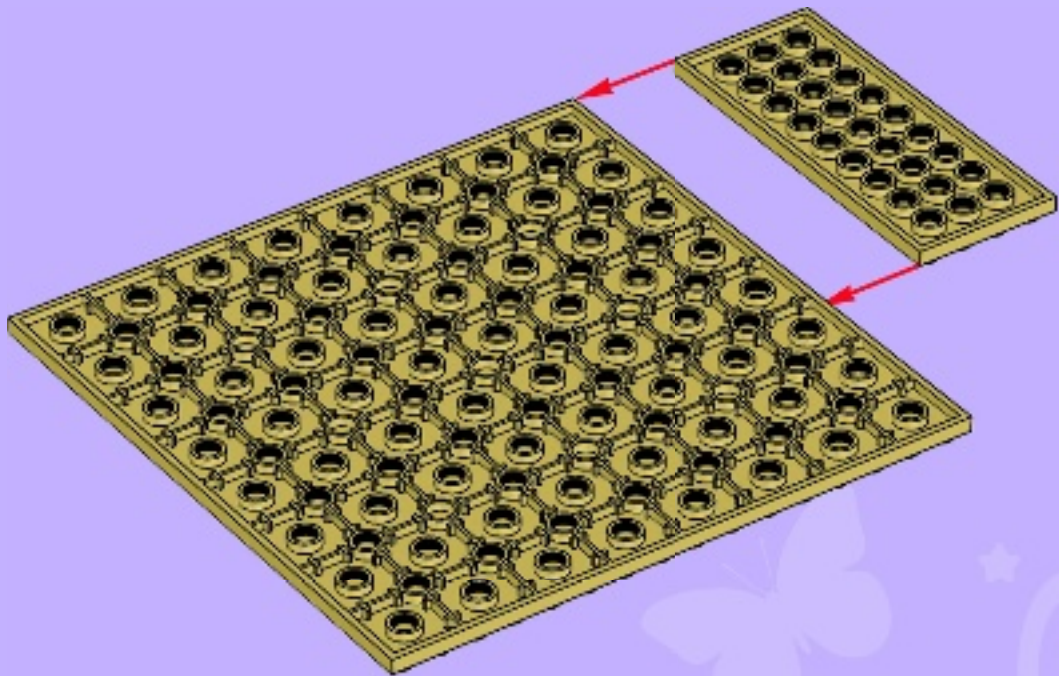



2x

8

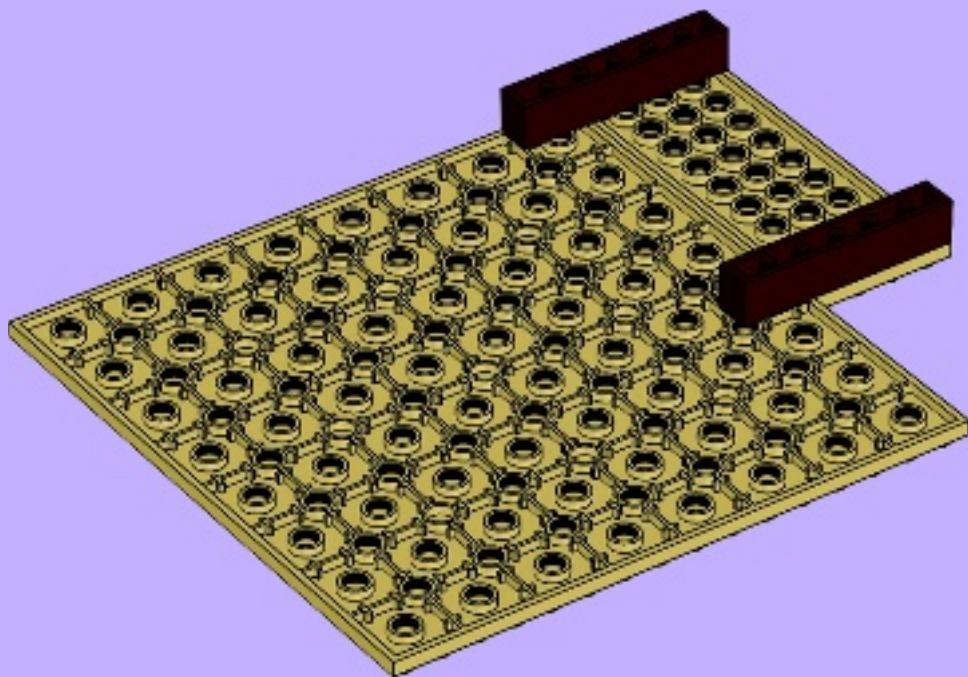



9

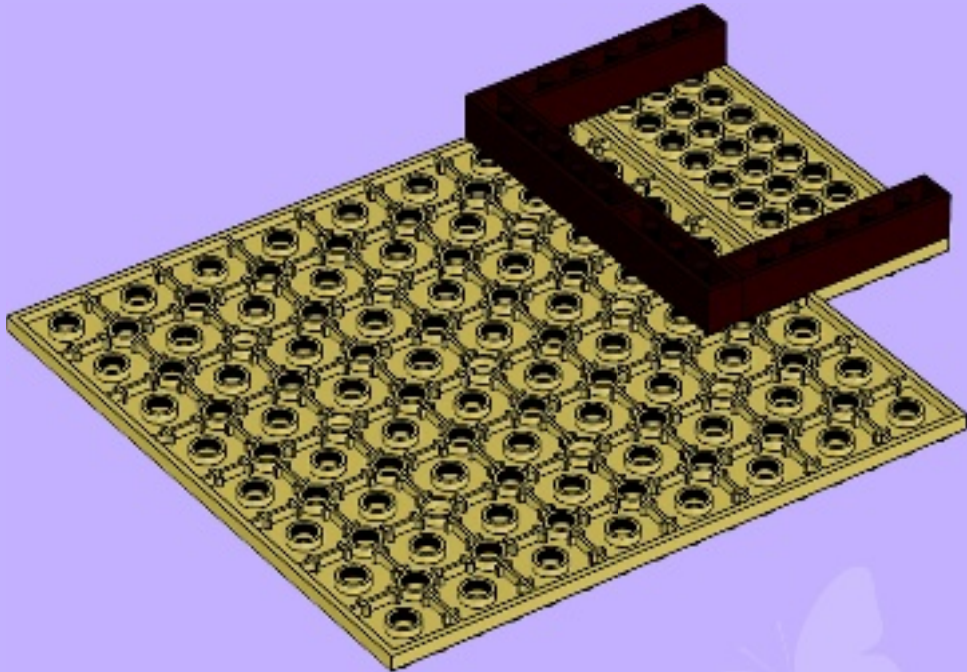

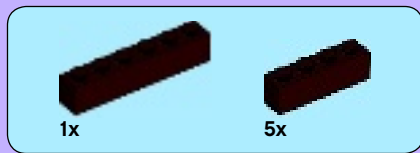

10

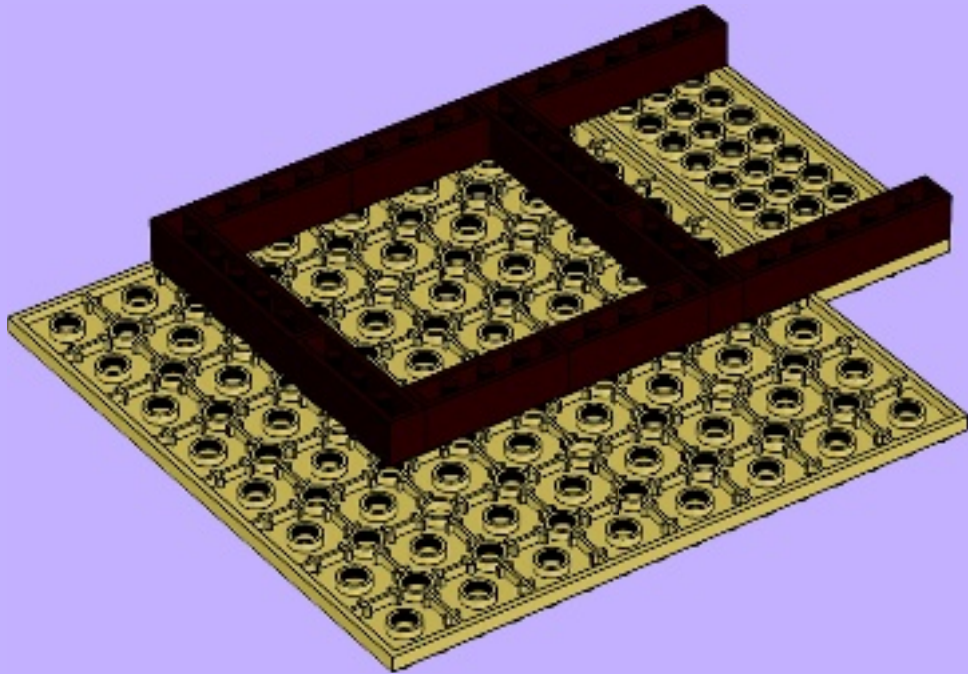



2x

11

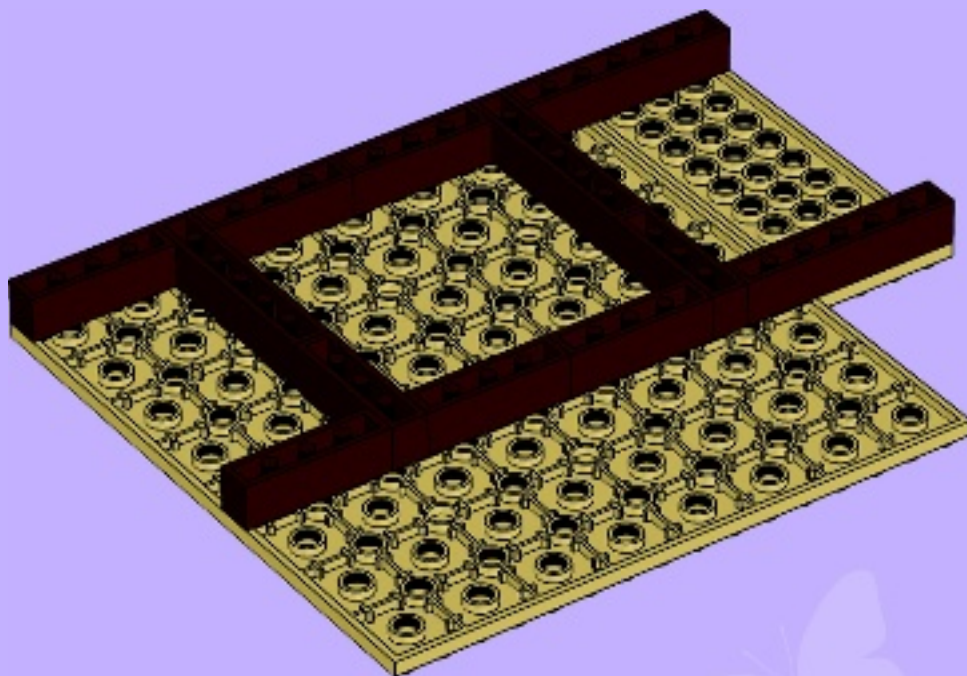

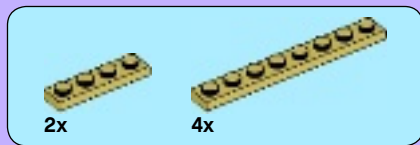

12

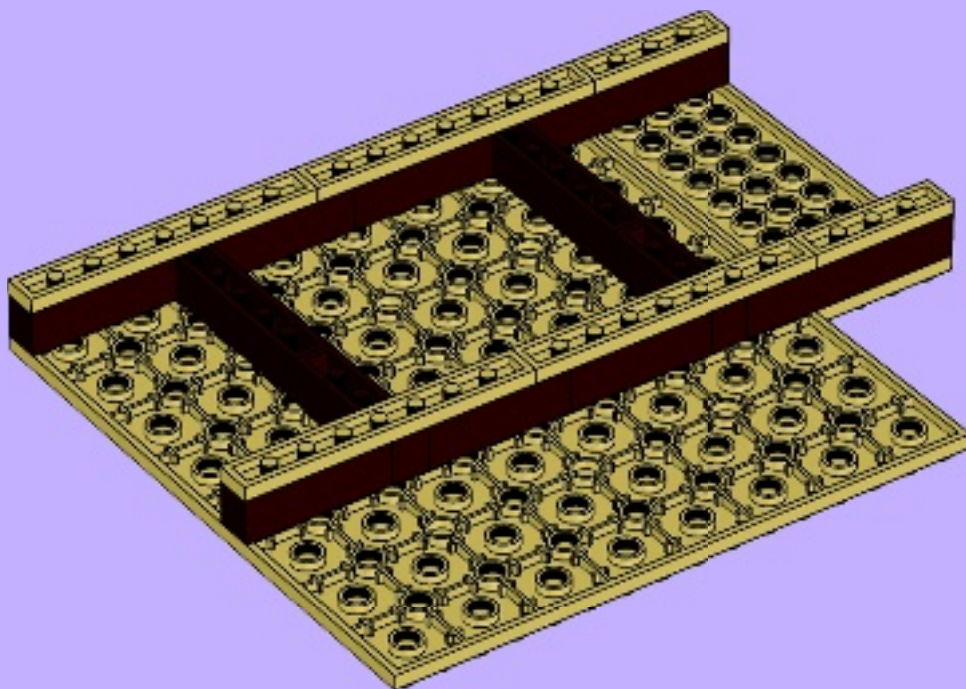

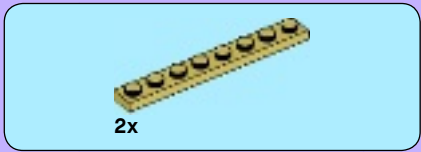

13

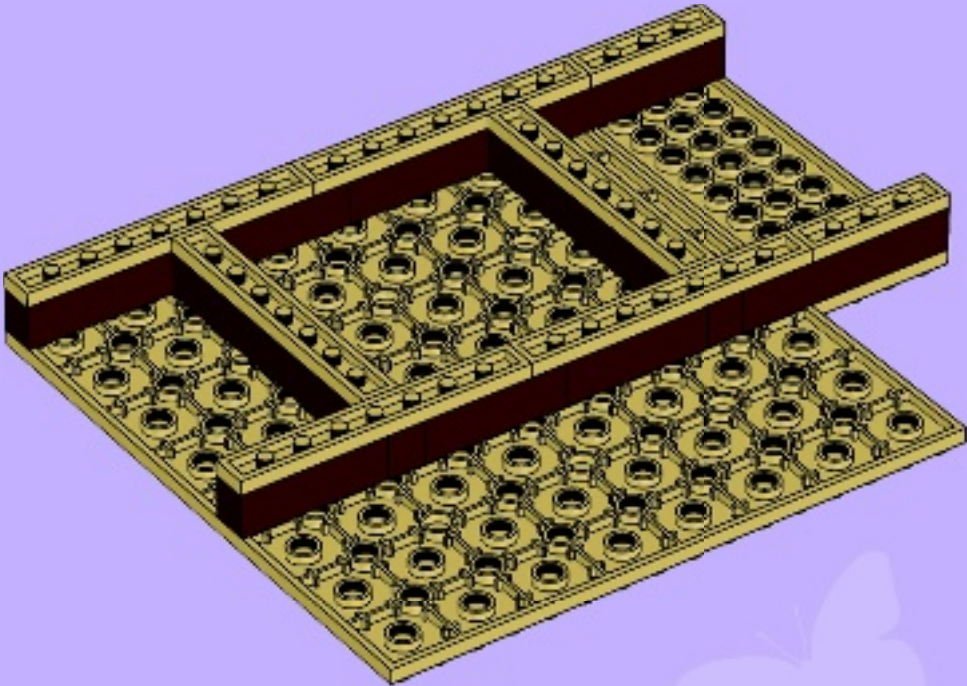

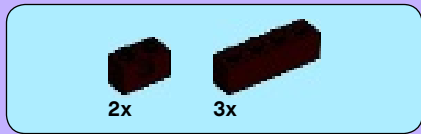

14

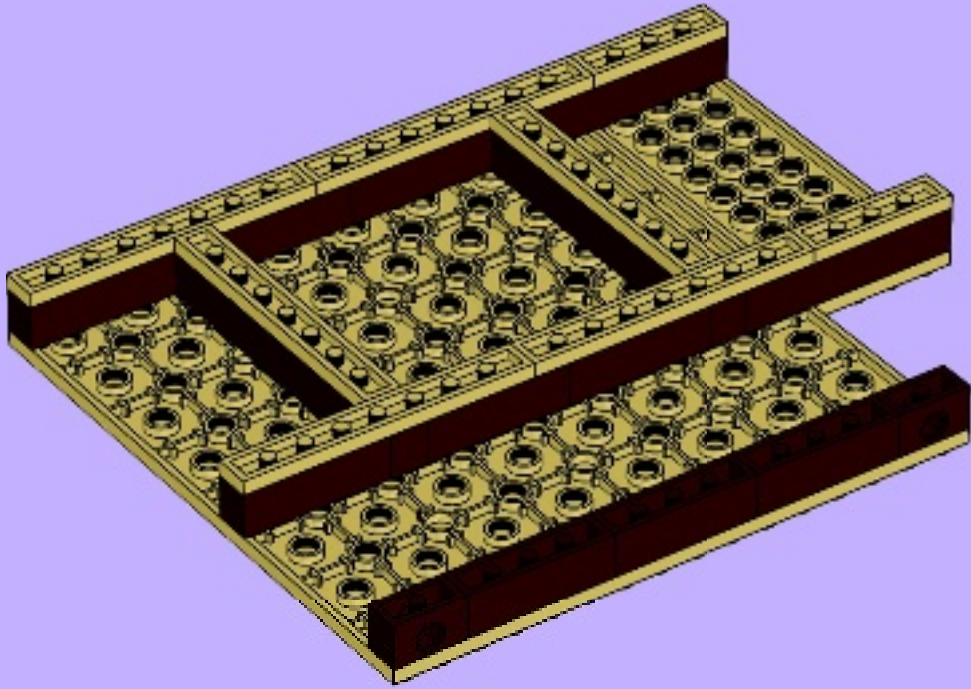

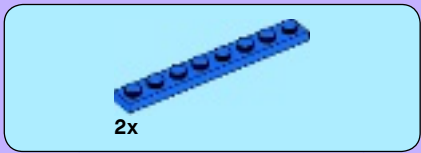

15

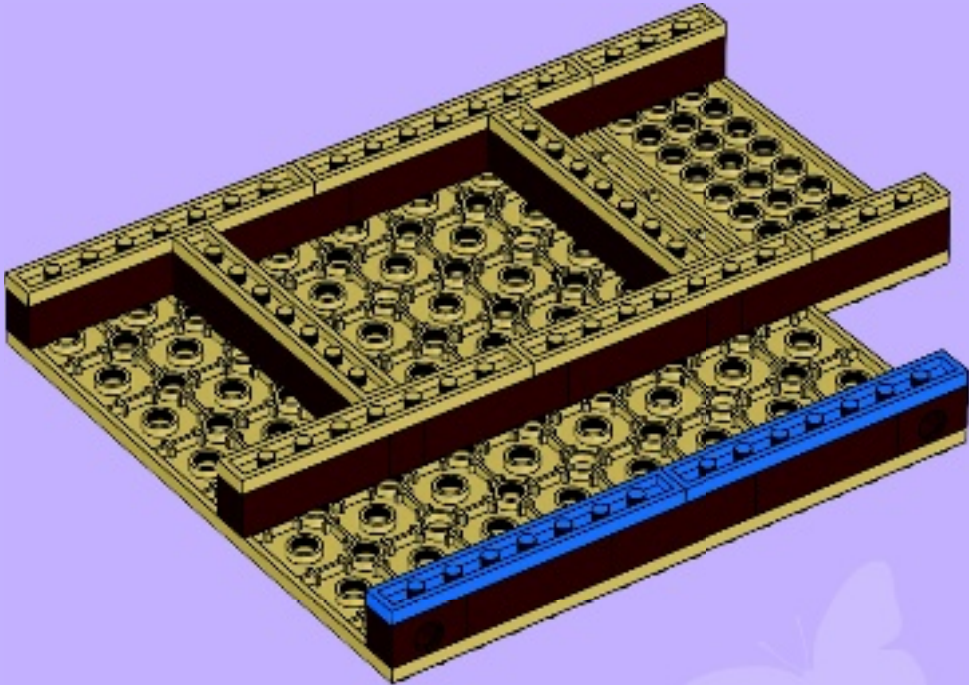

16

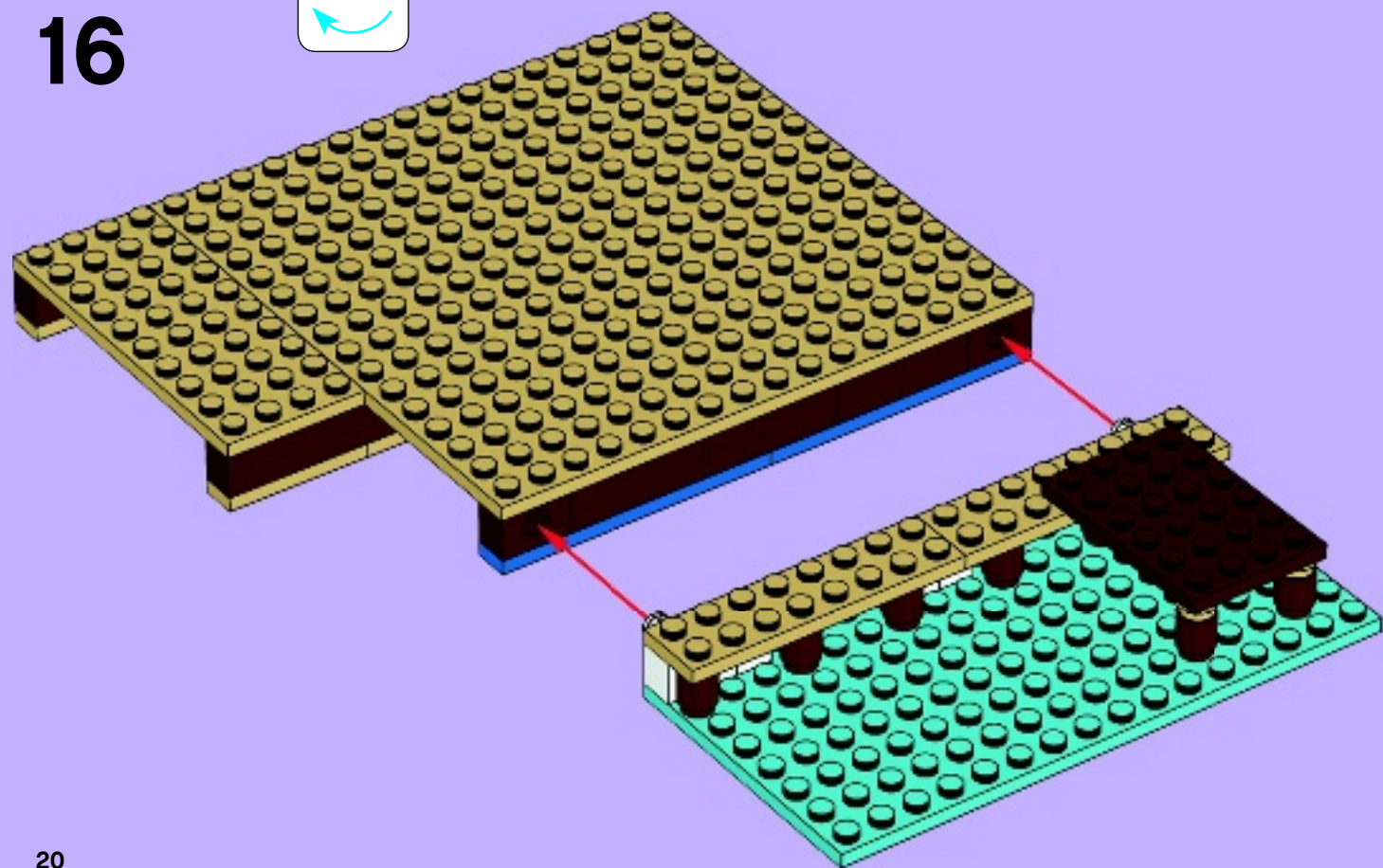
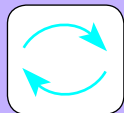



2x



2x

17

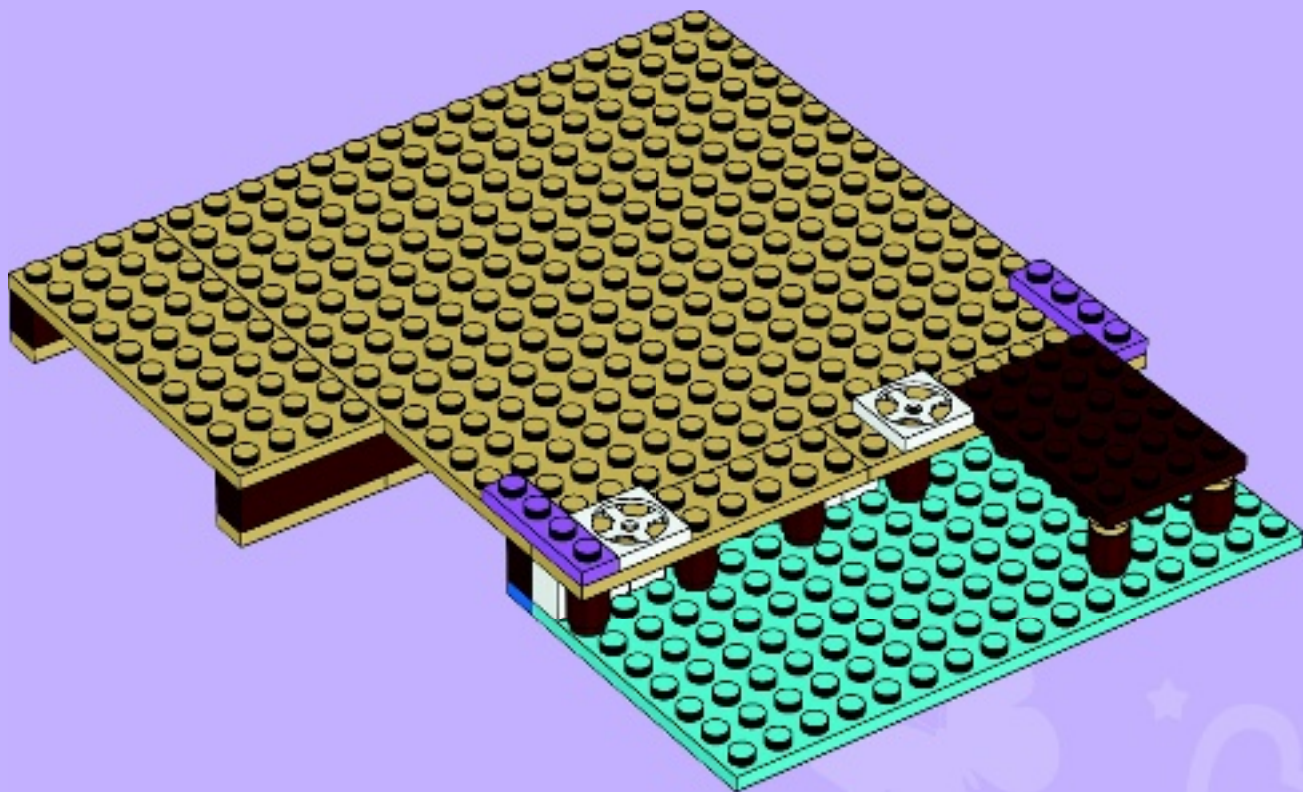

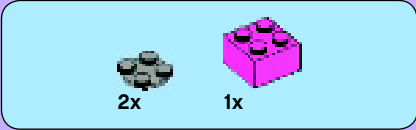

18

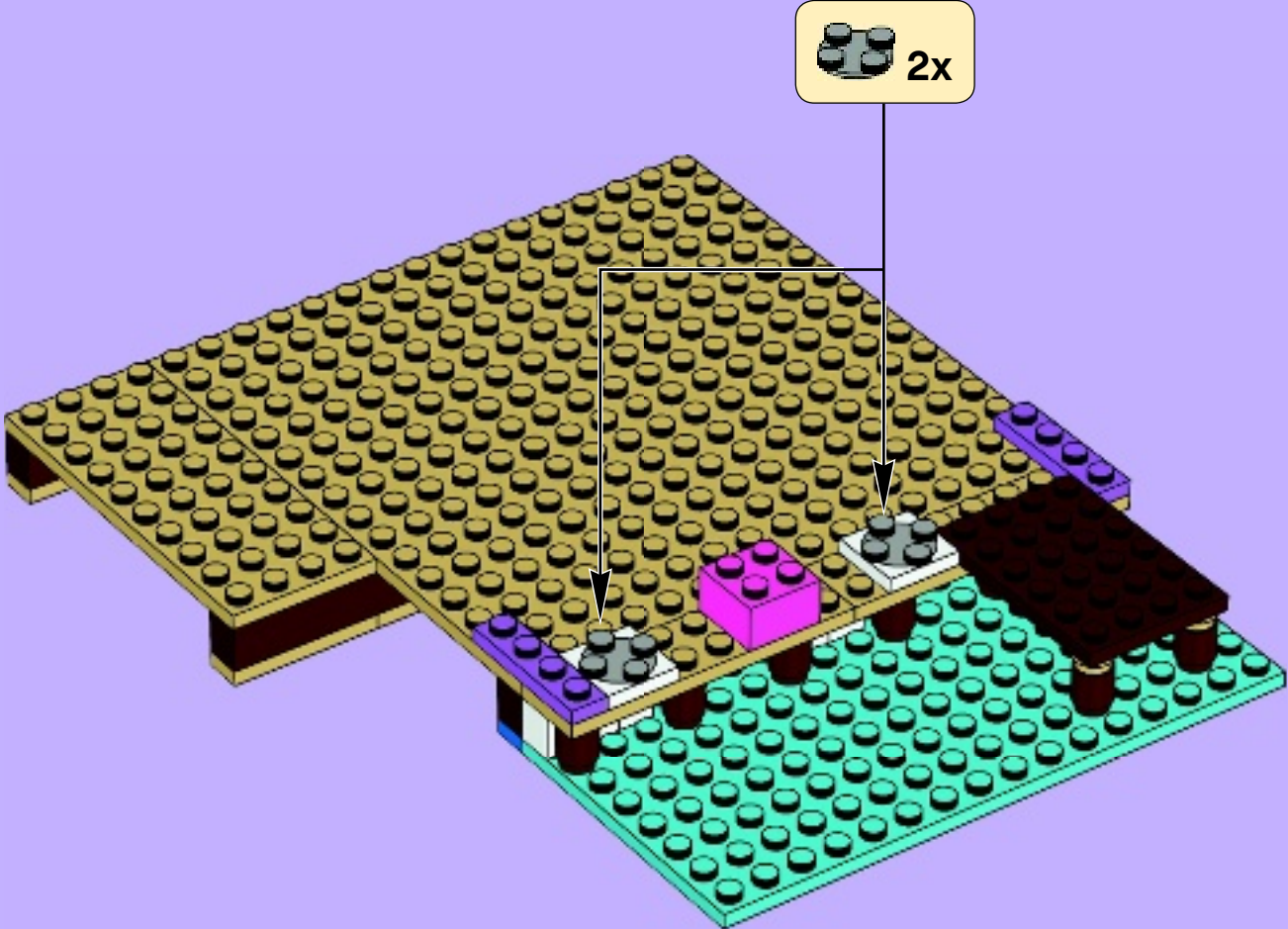



1x

19

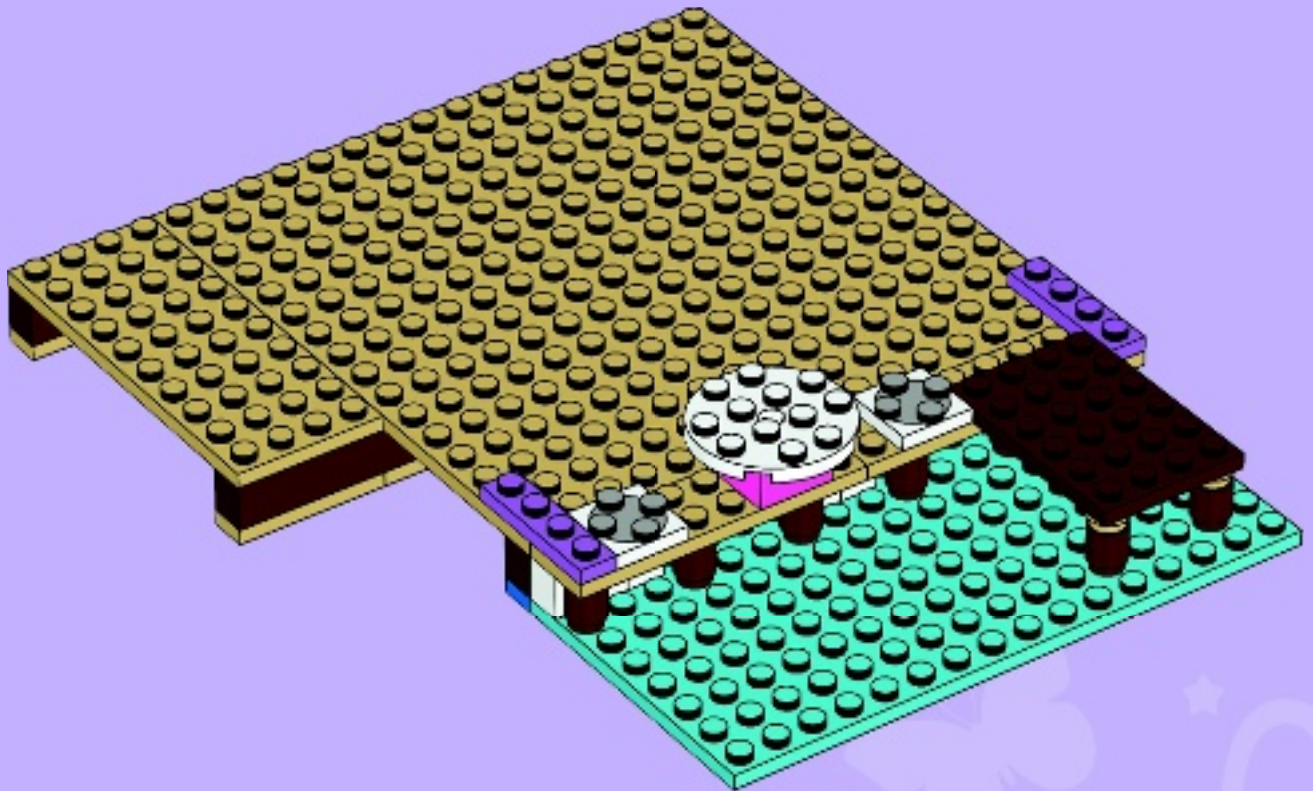

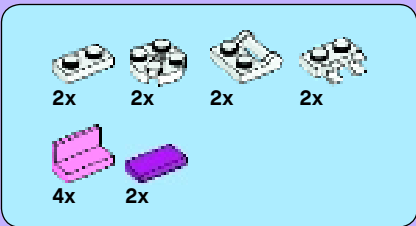

20

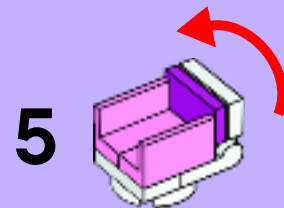
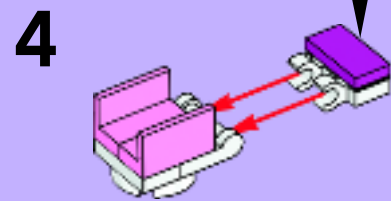
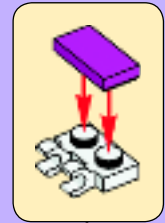
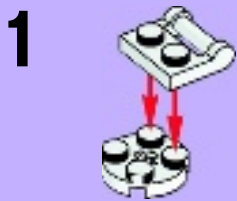

2x

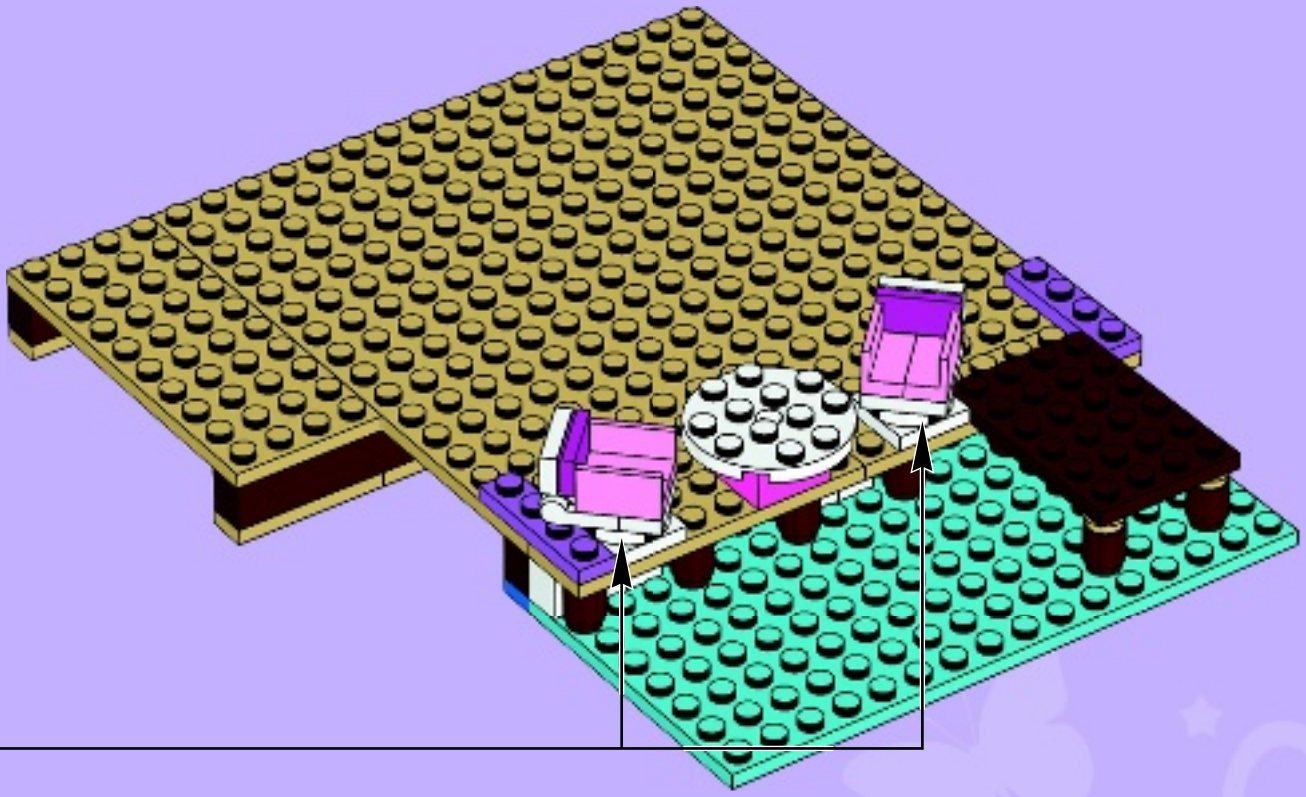

2x 1x 1x

21

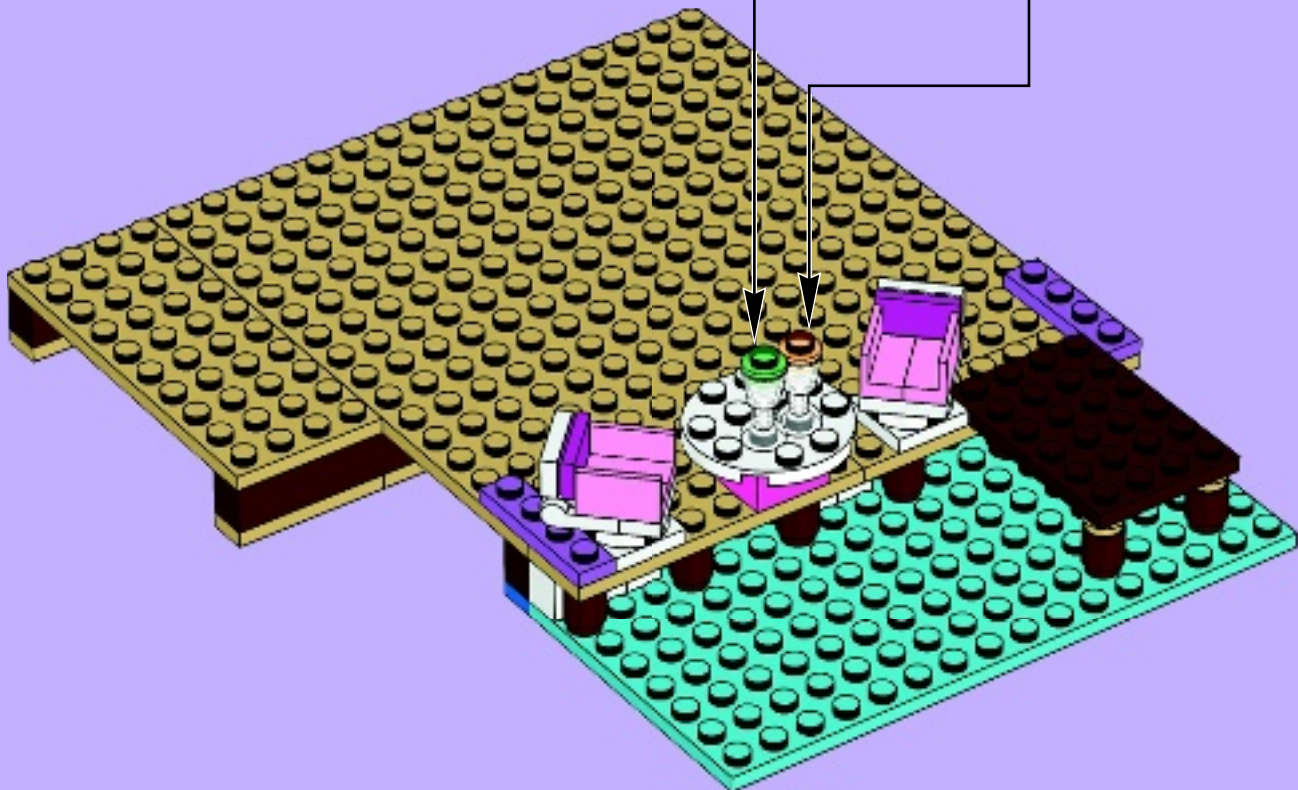



2



3x

22



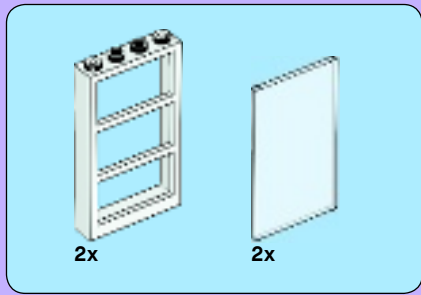

23

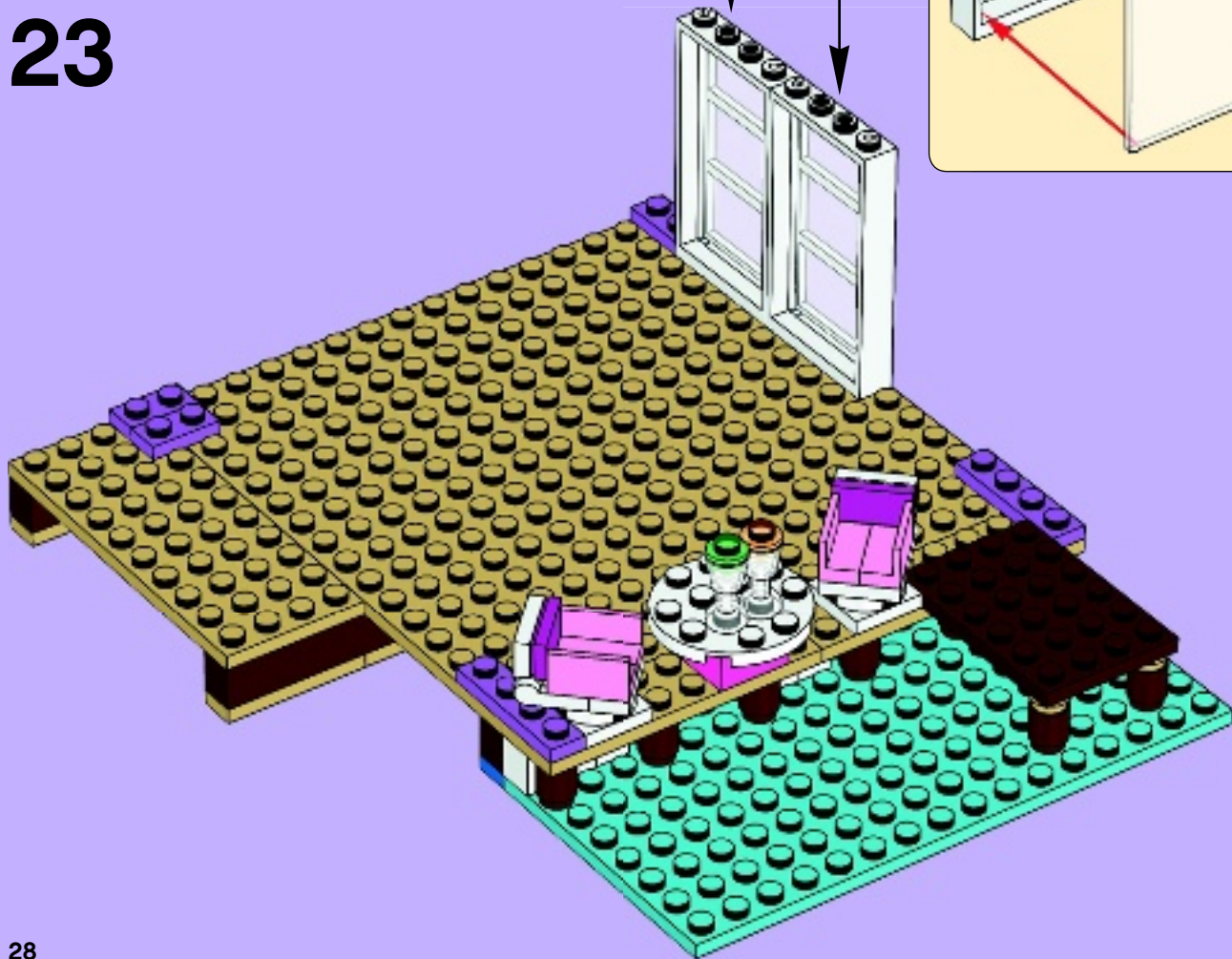
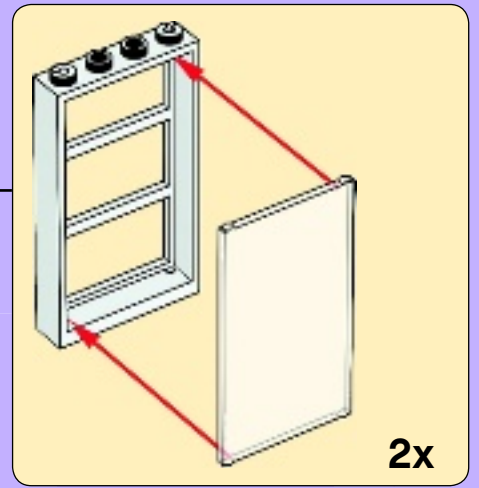

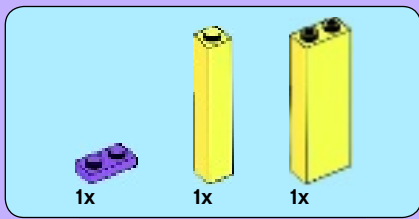

24

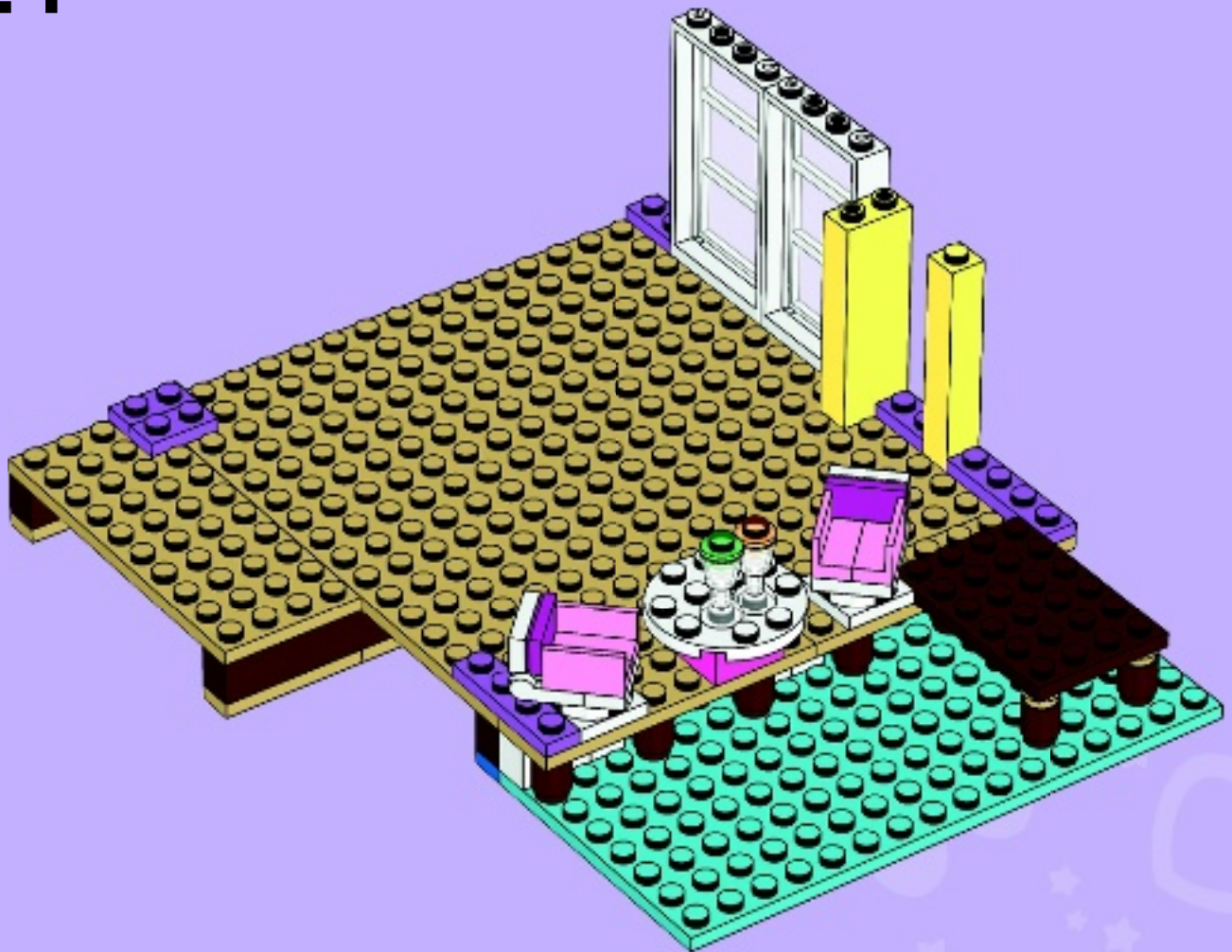



25

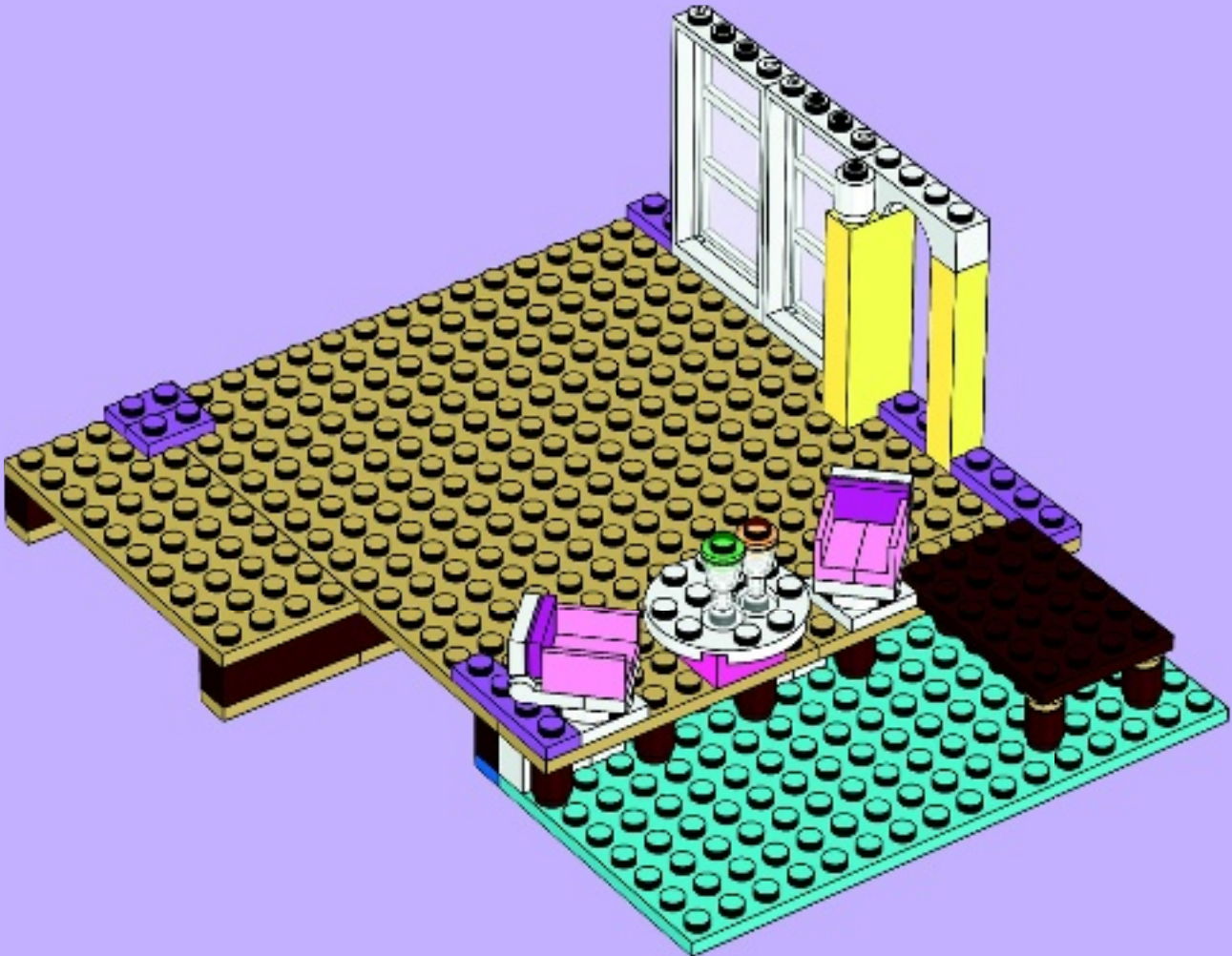

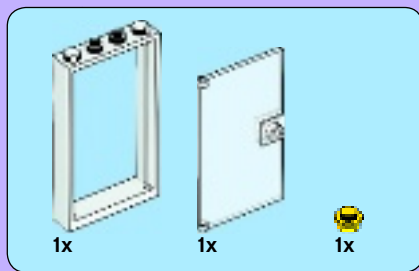

26

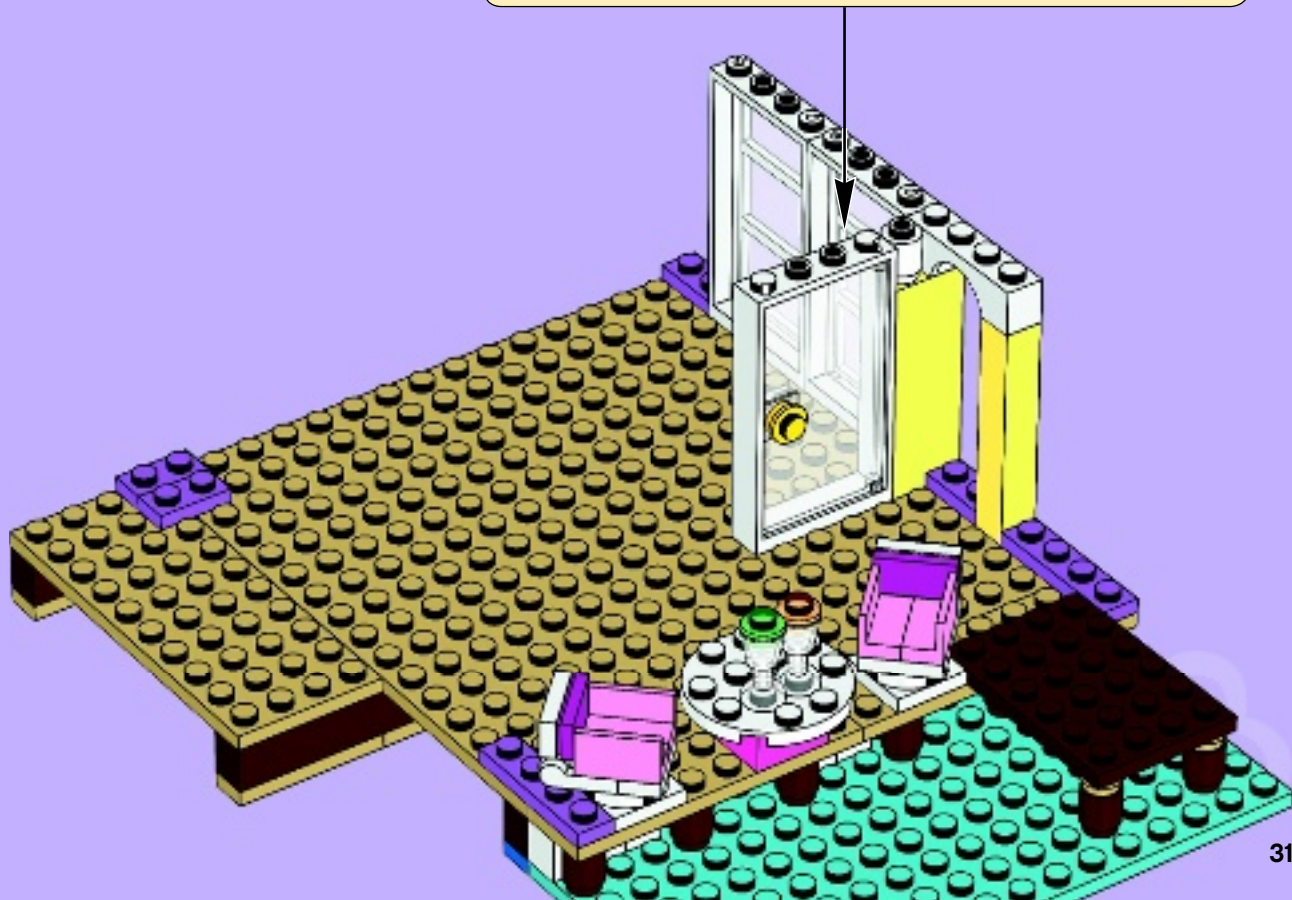
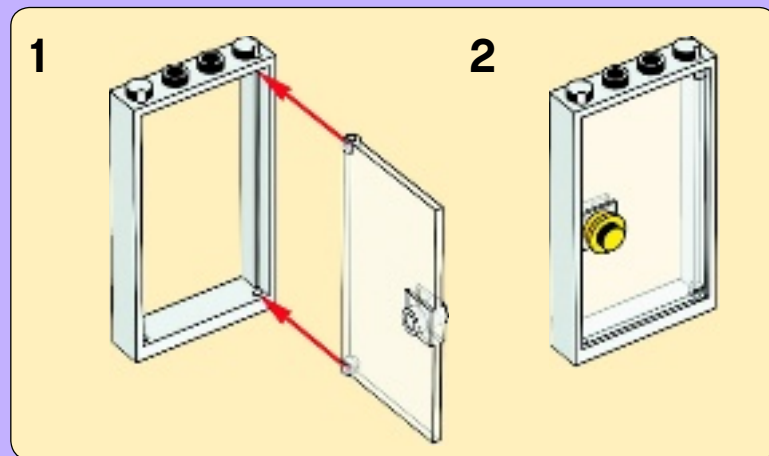

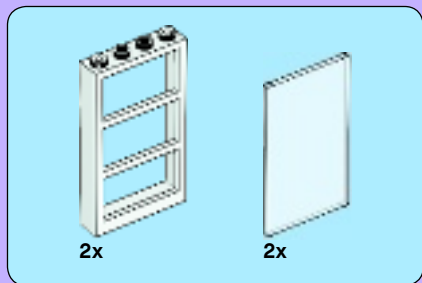

27

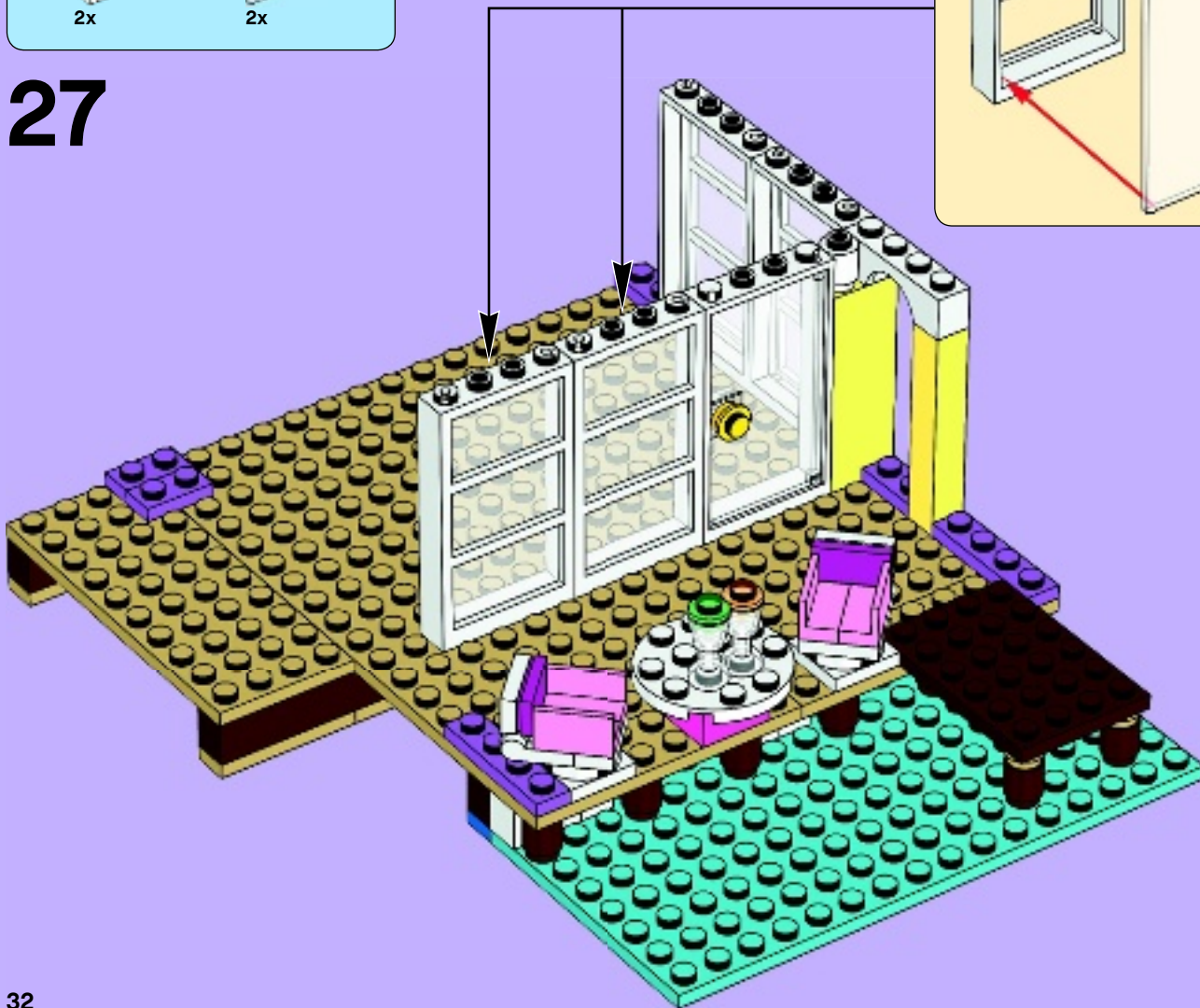
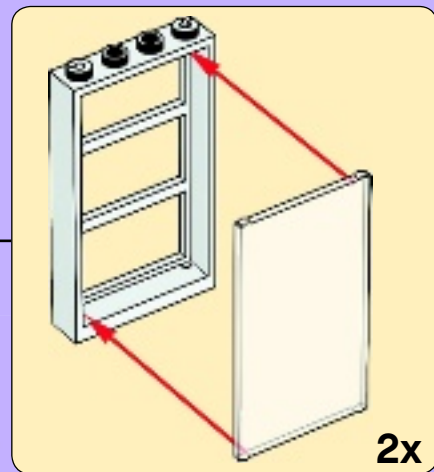

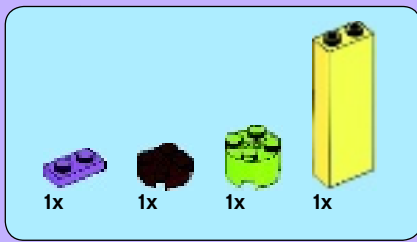

28

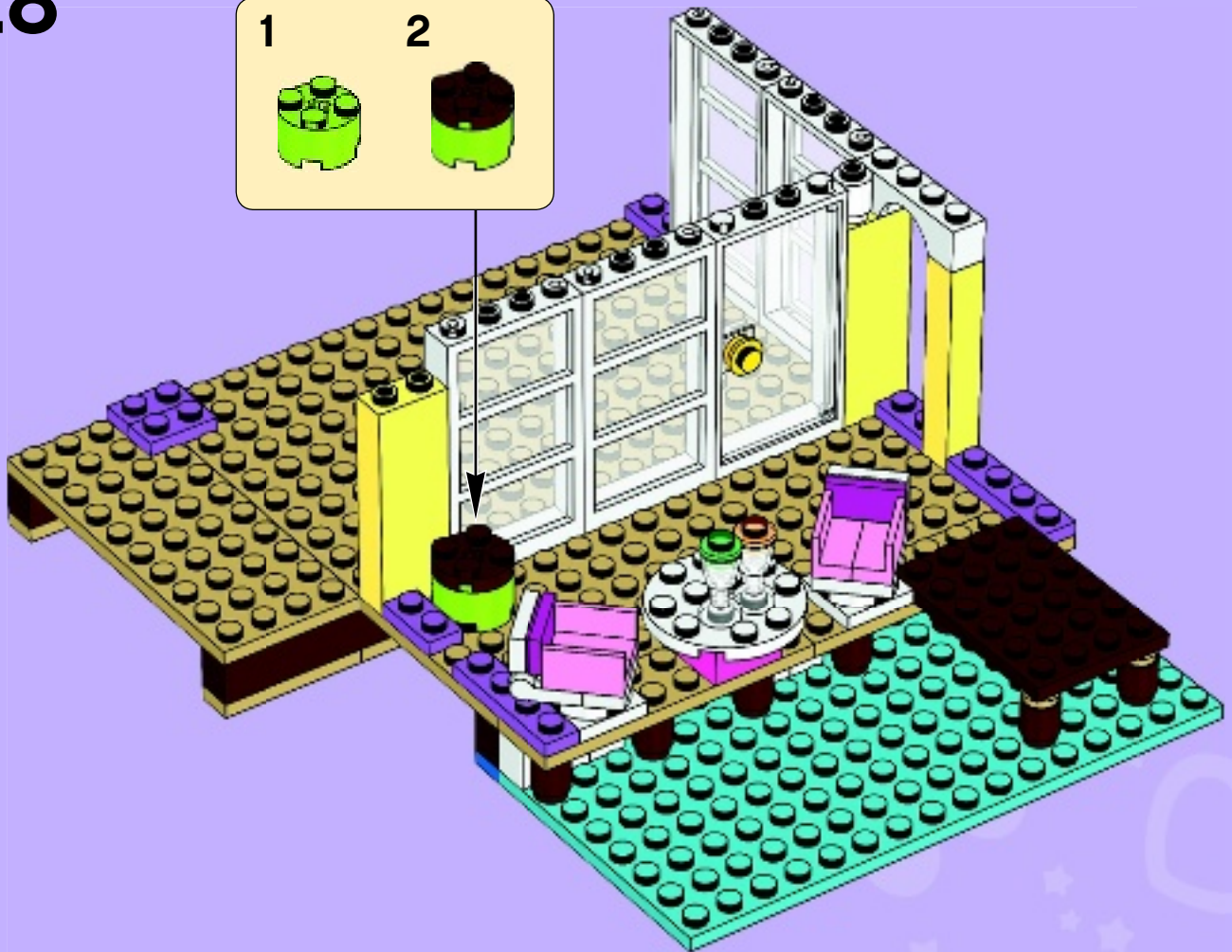

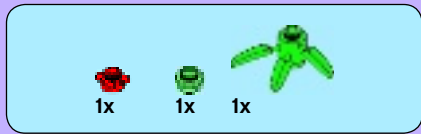

29

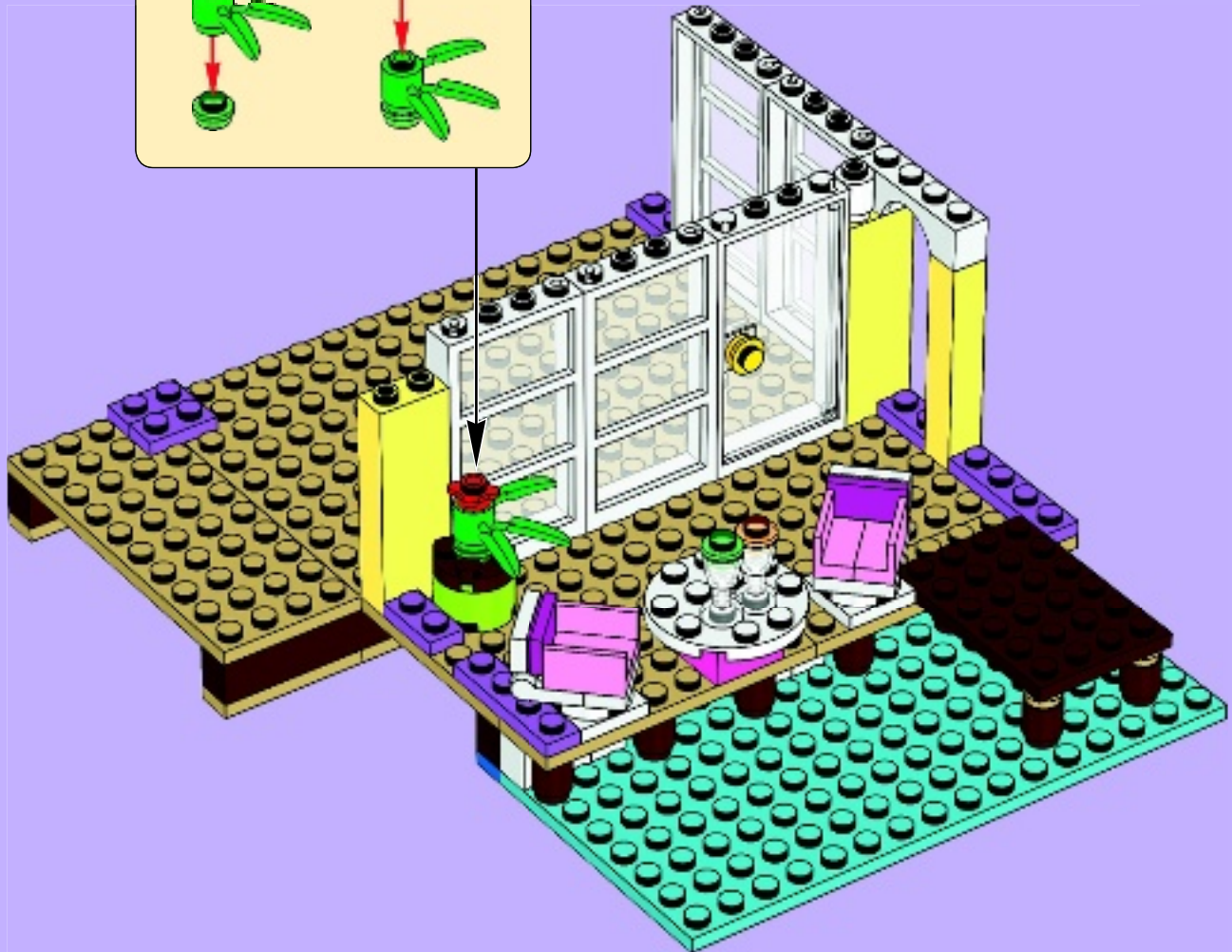
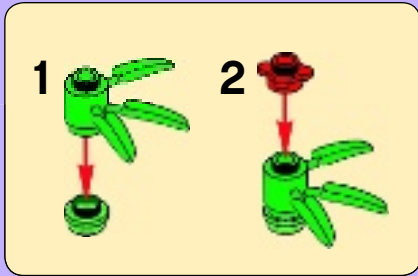

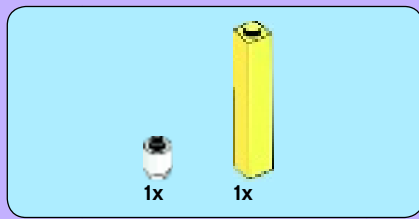

30

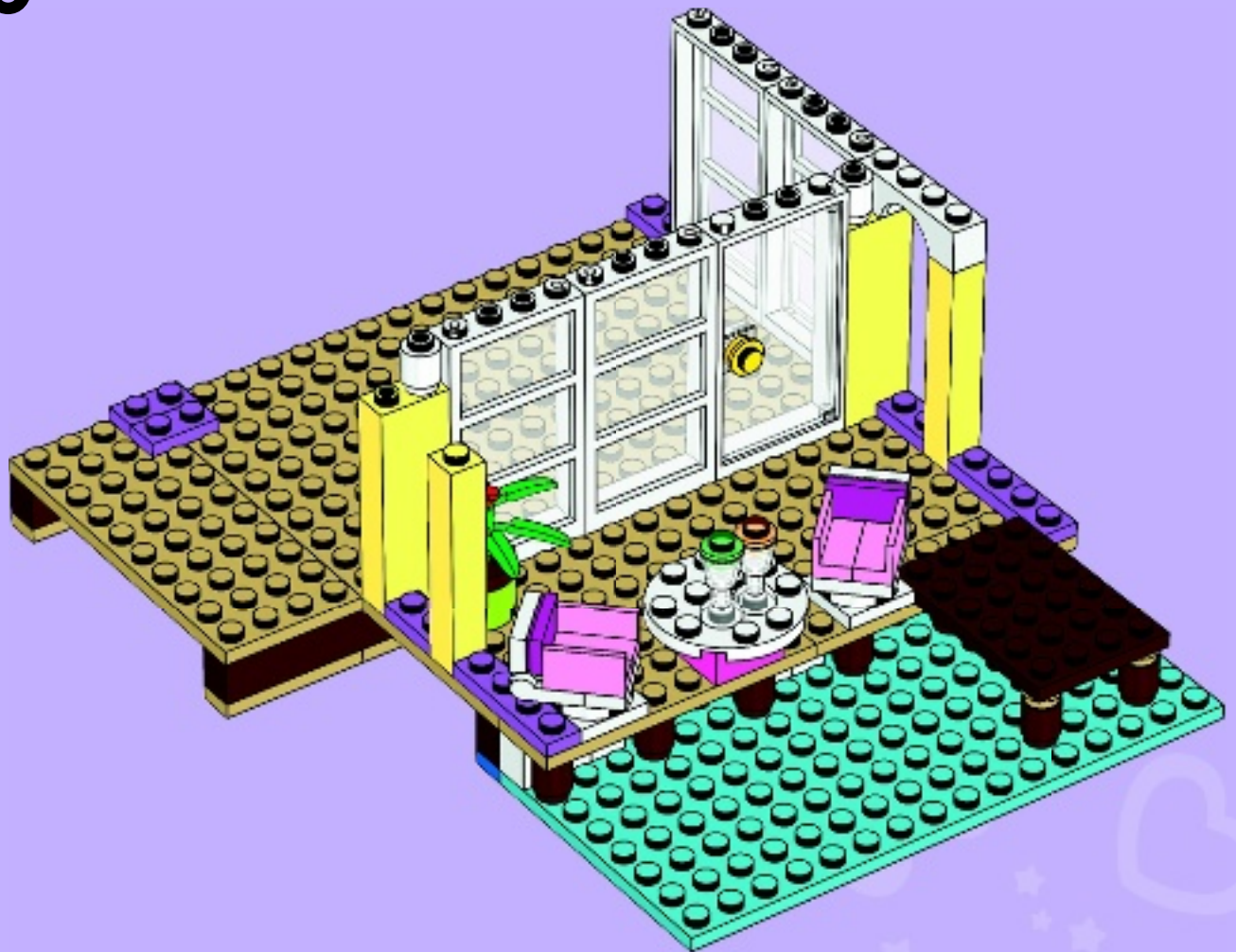

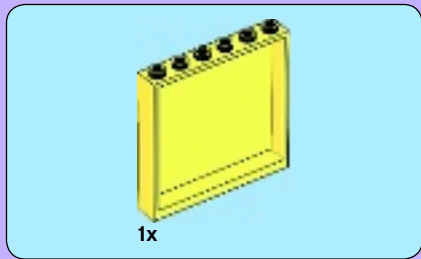

31

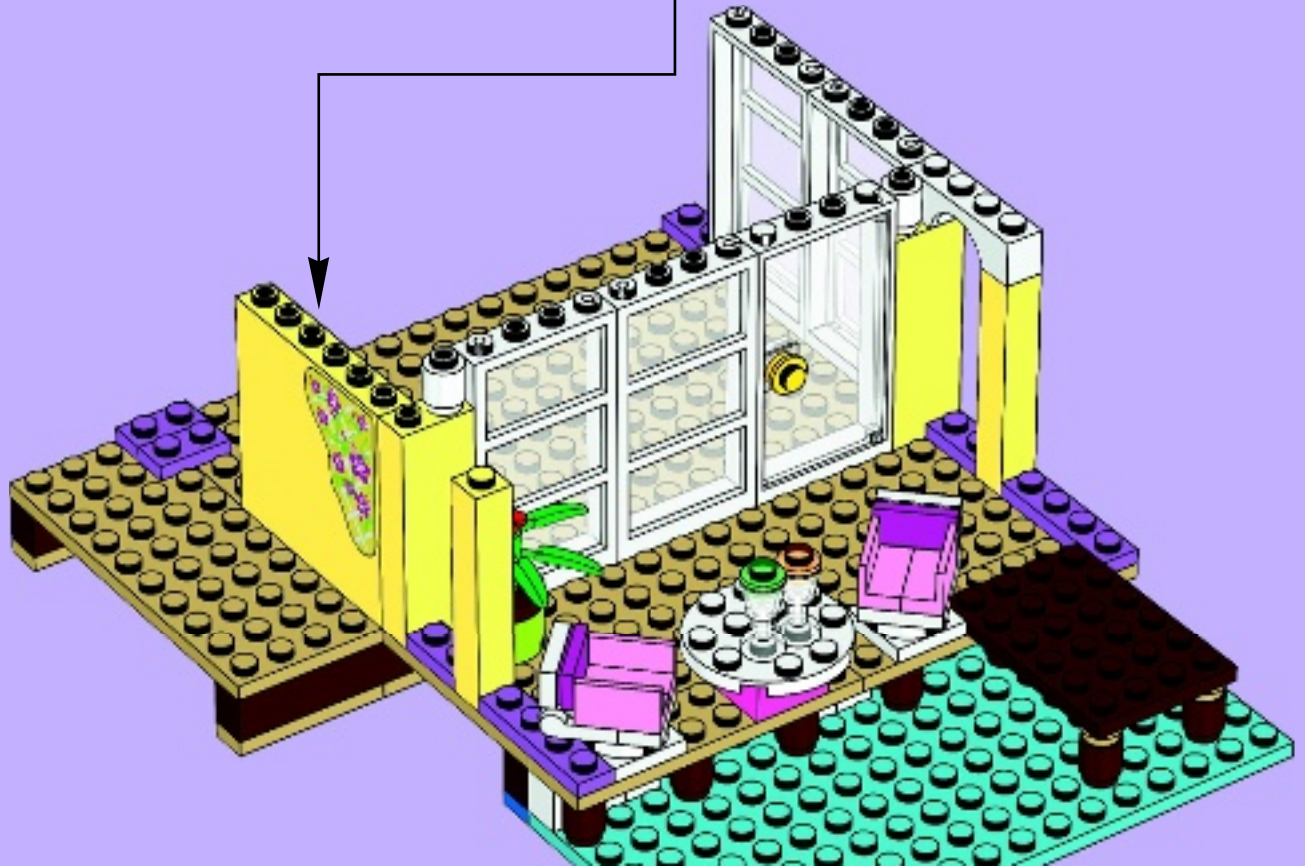
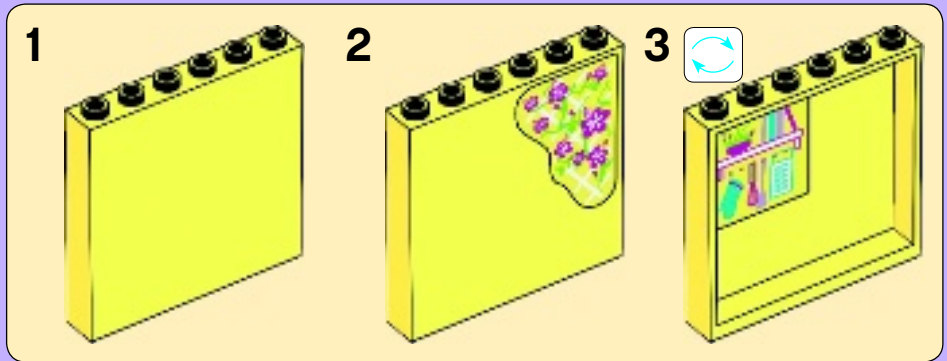

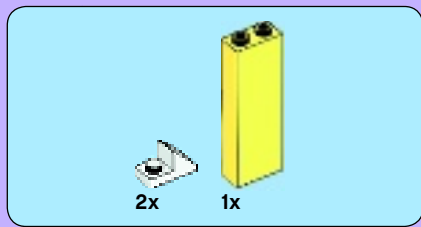

32

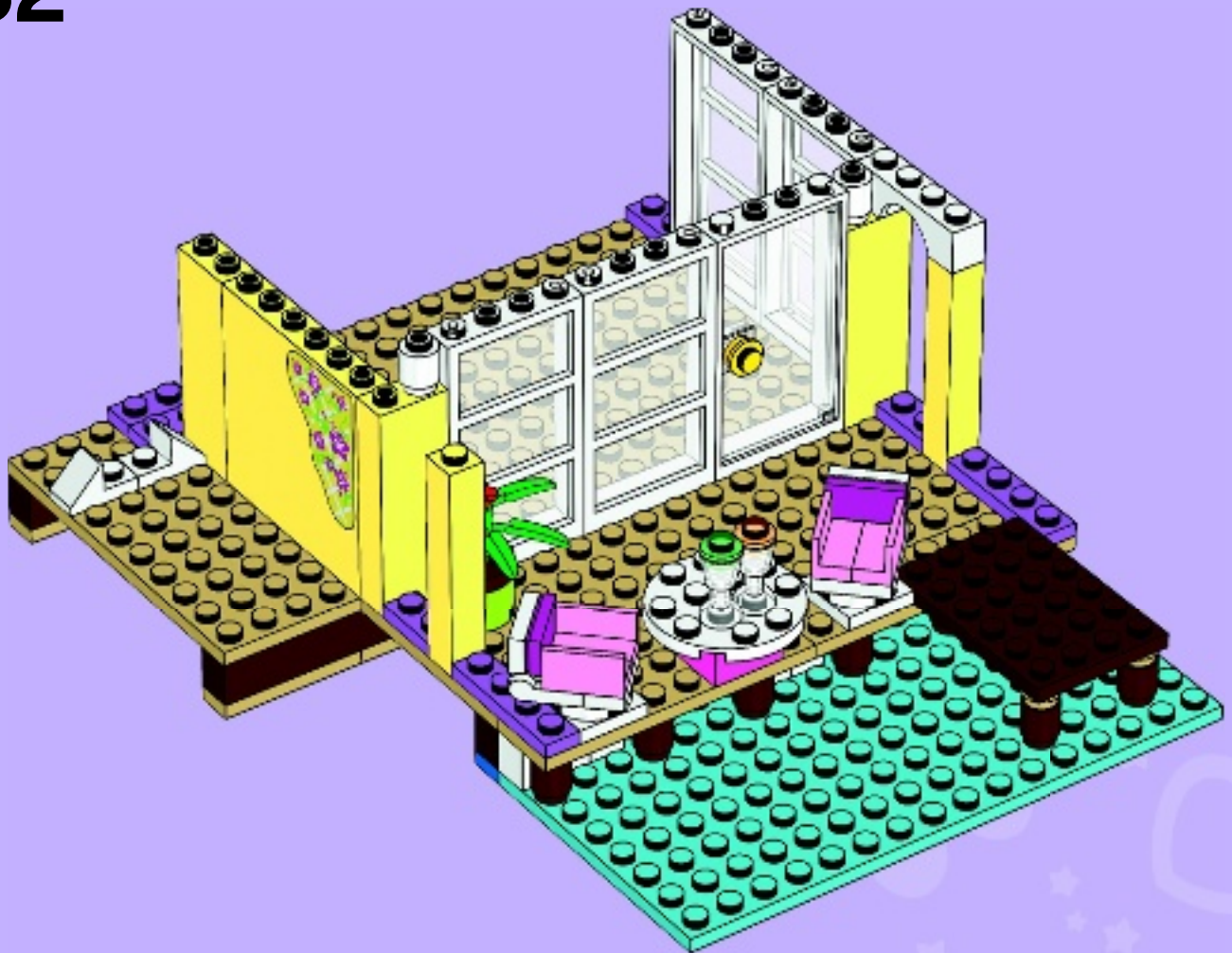

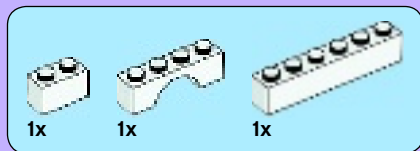

33

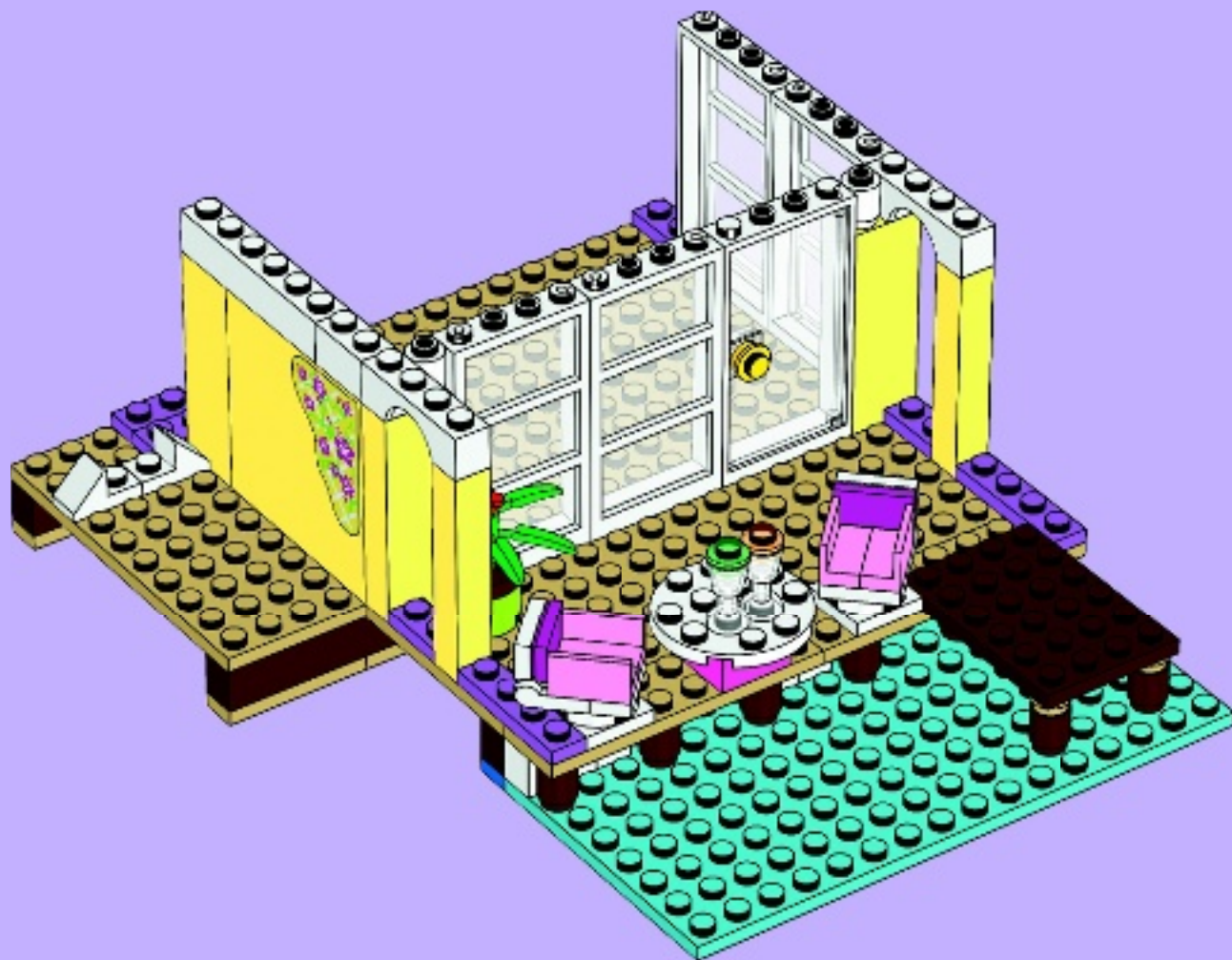

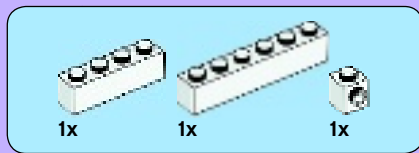

34

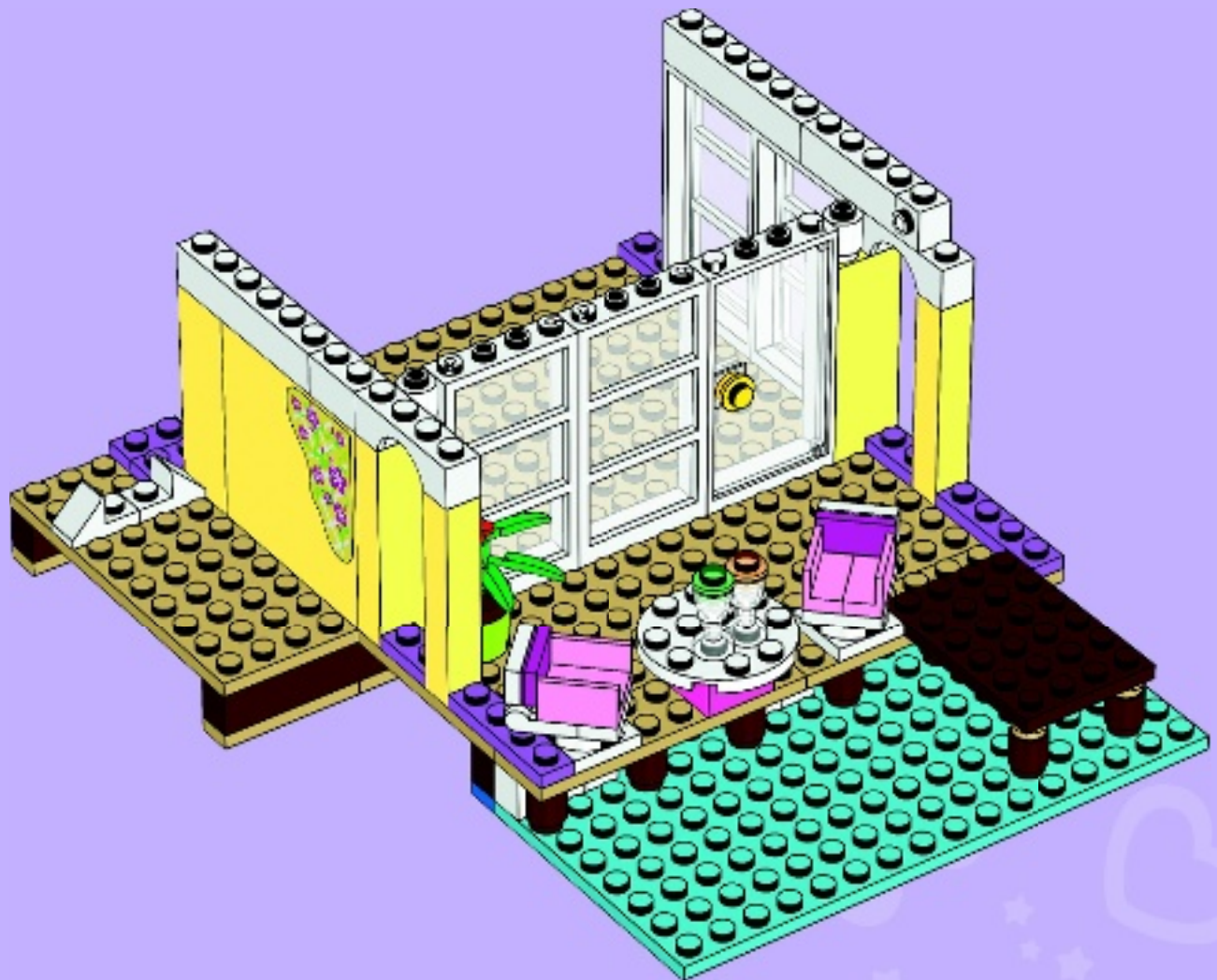



2x



1x

35

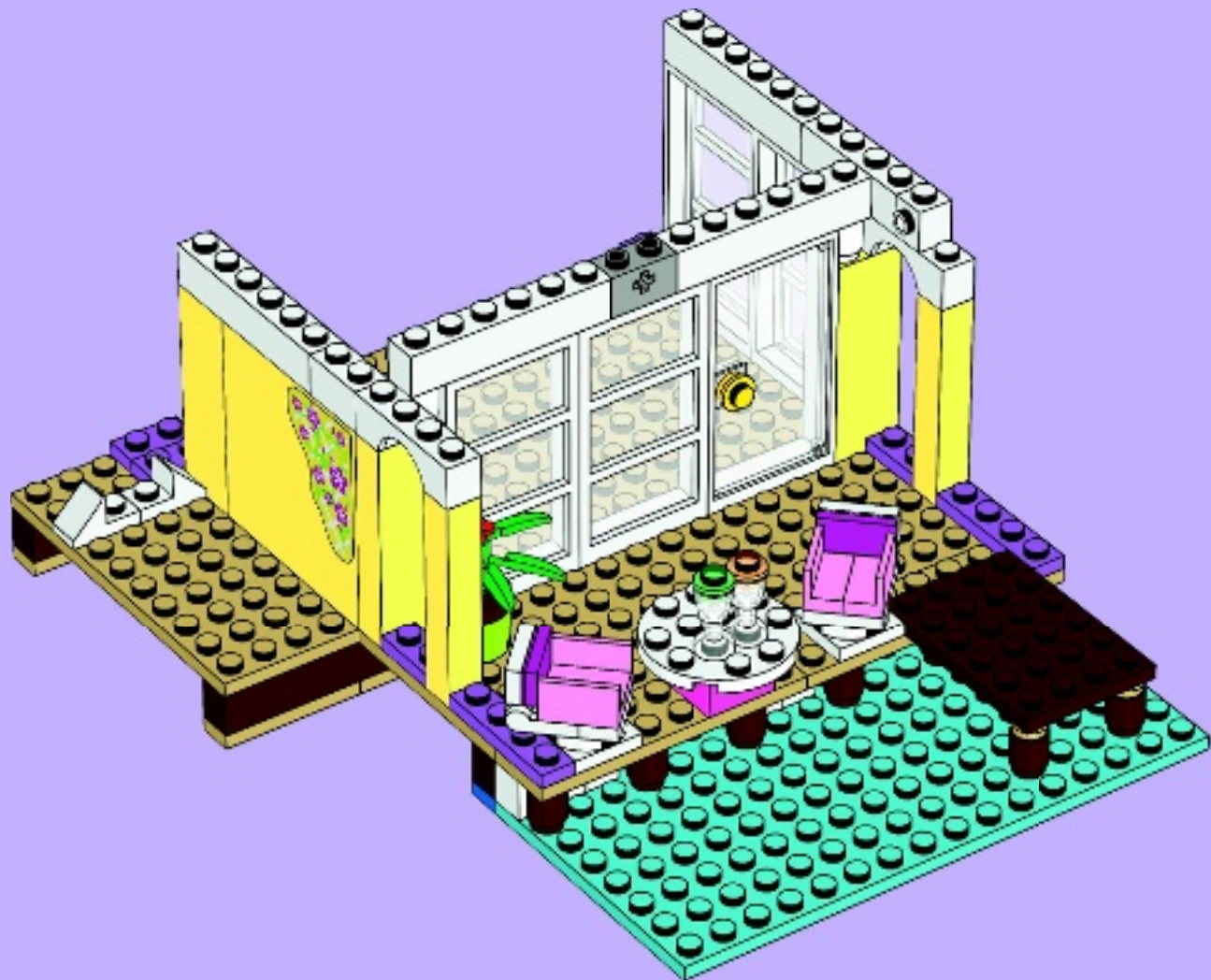

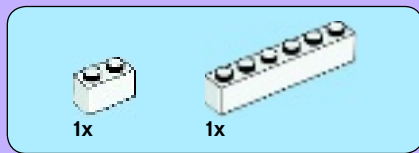

36

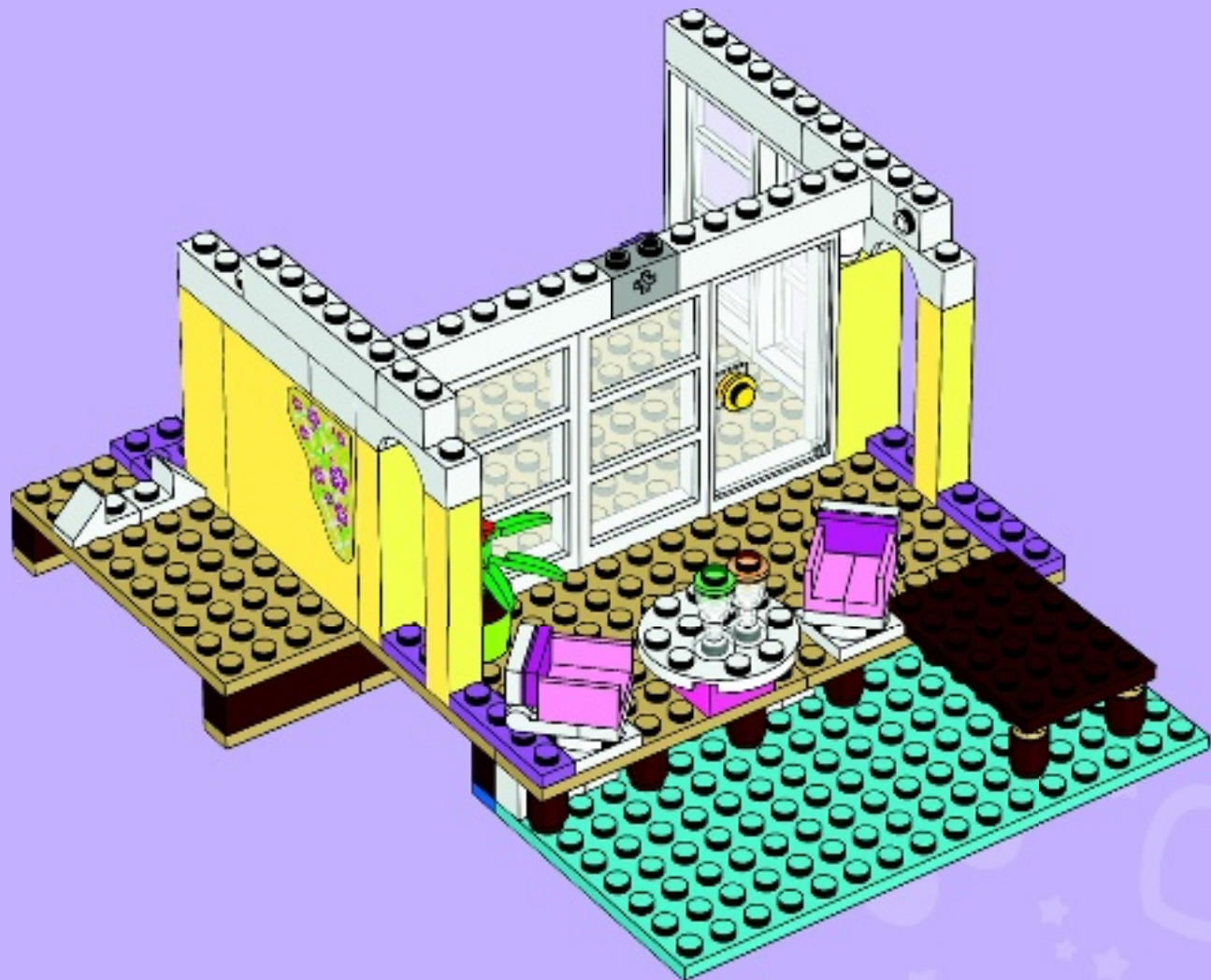

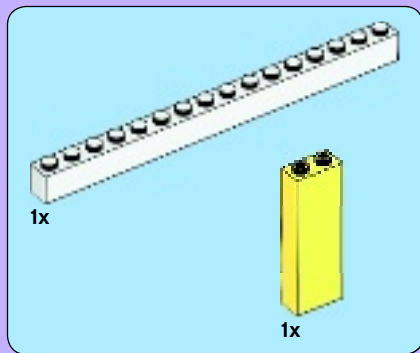

37

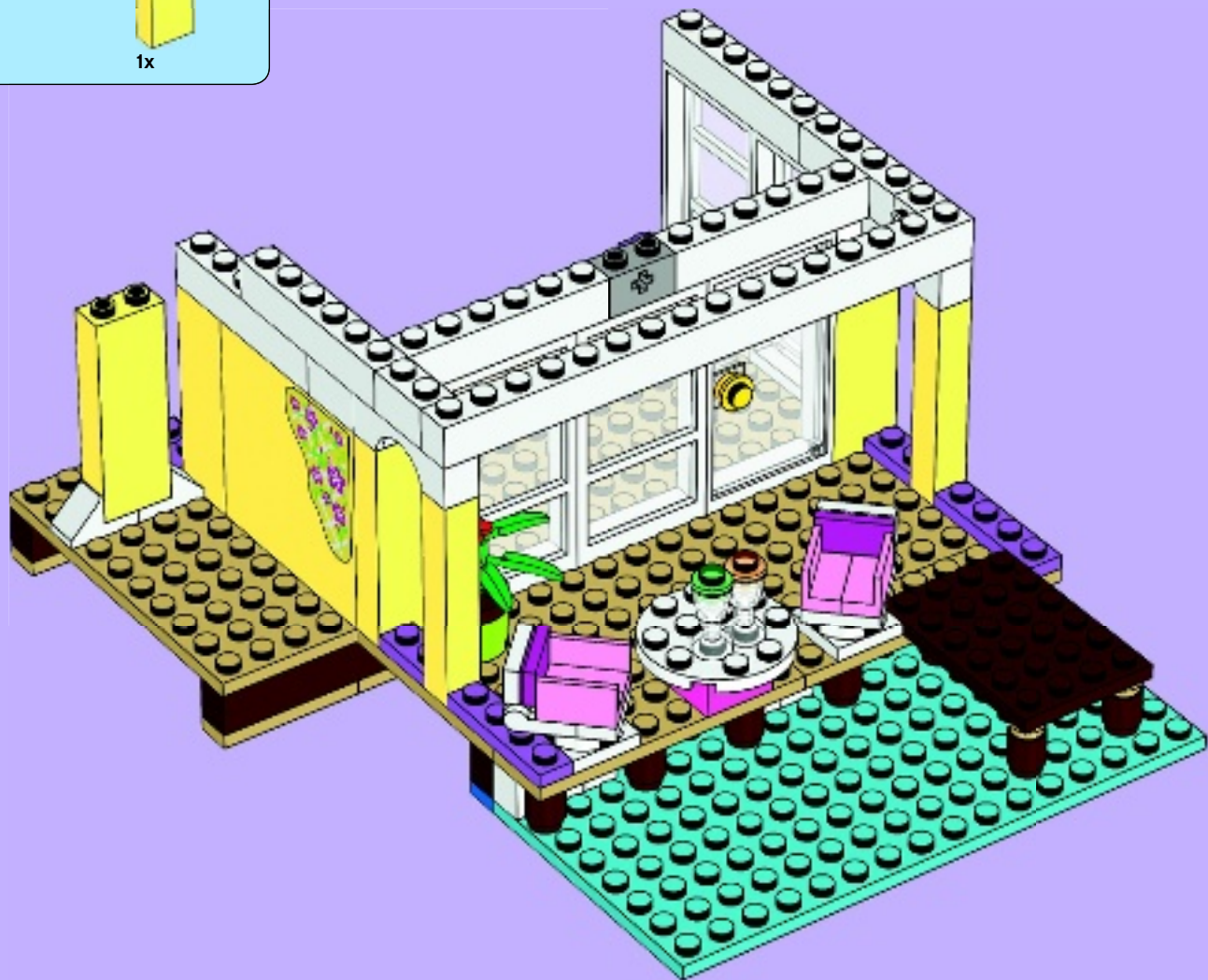

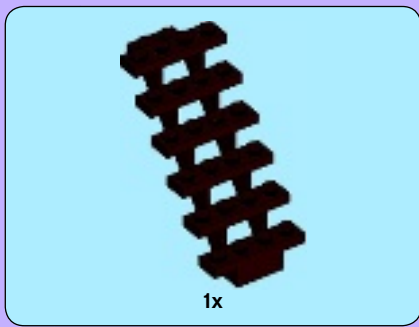

38





1x



1x

39





40





2x



6x

41

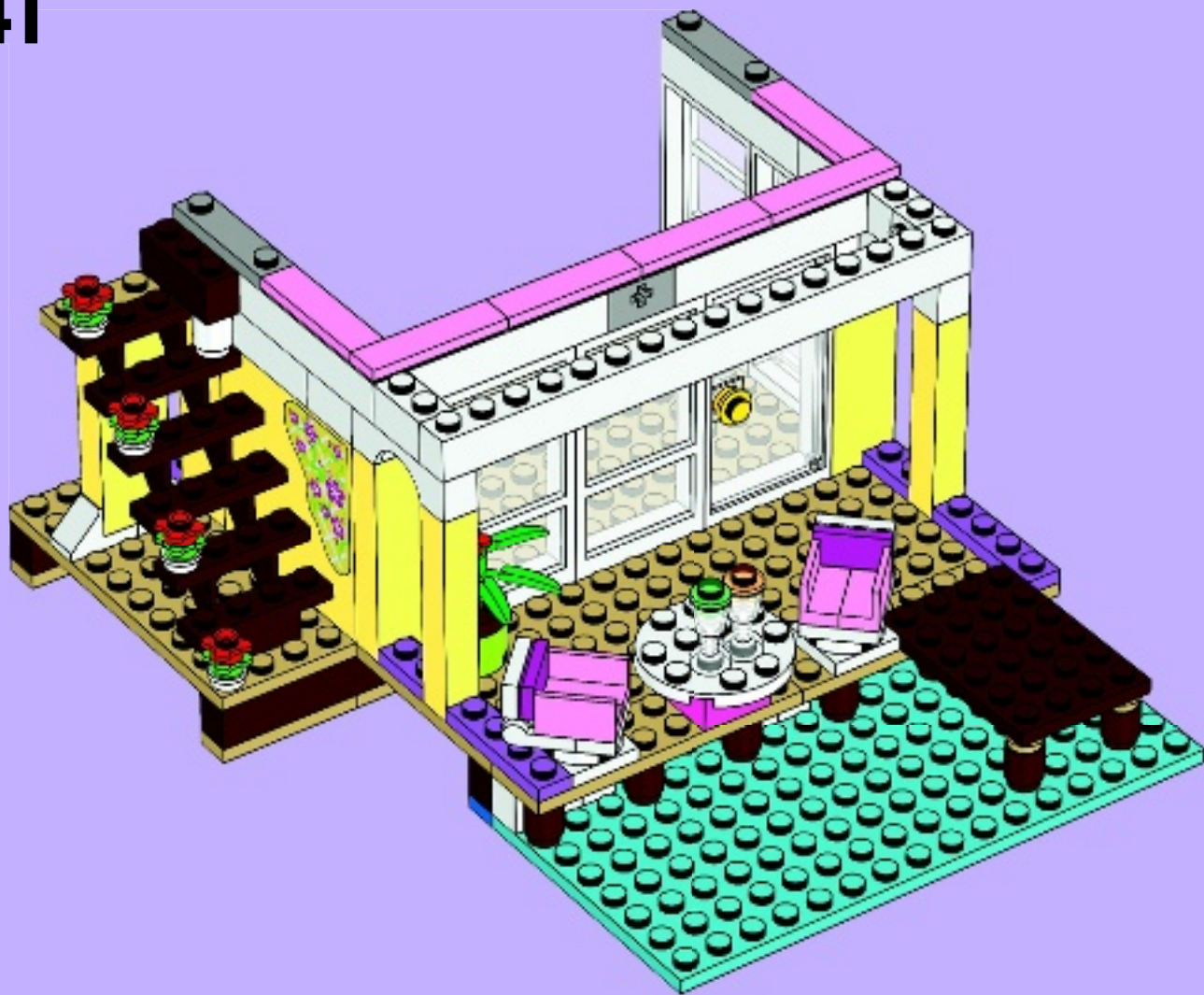



1x



5x

42





2x



4x

43

1



2



3



2x

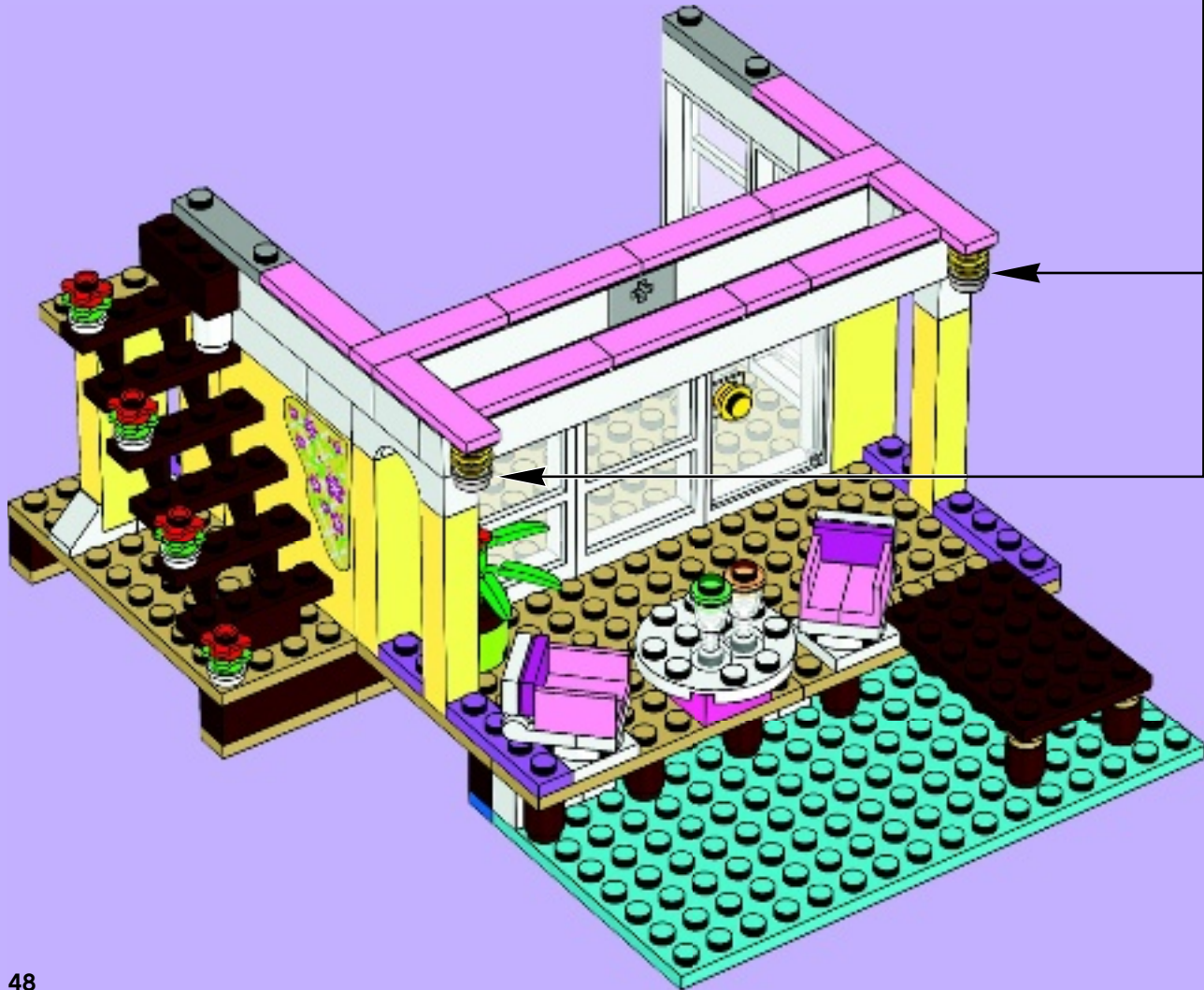



1x

44

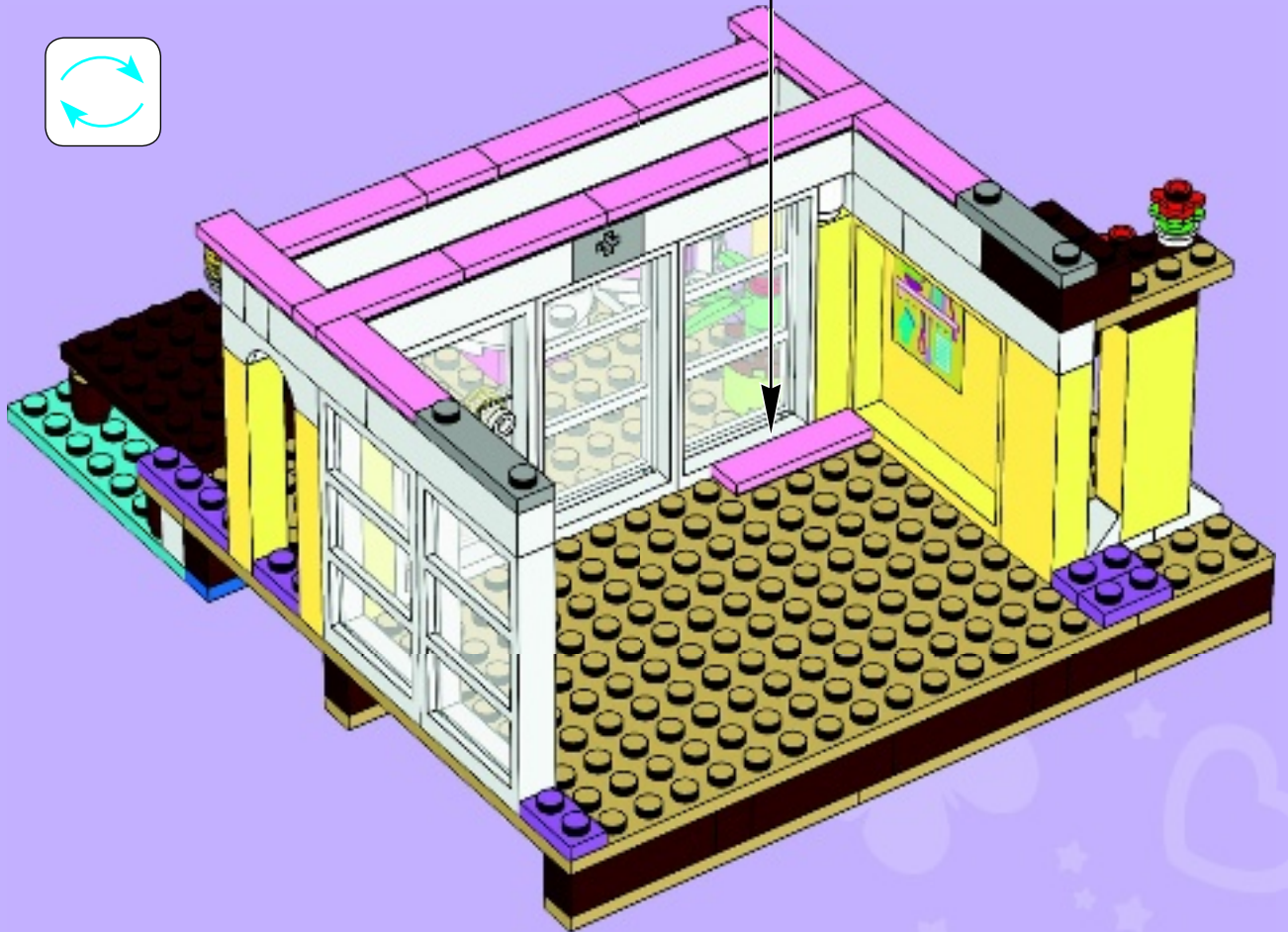
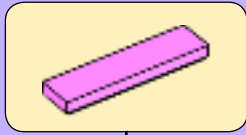
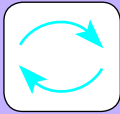

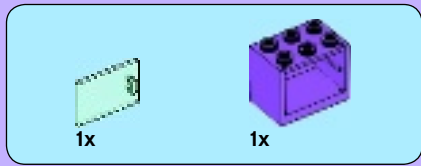

45

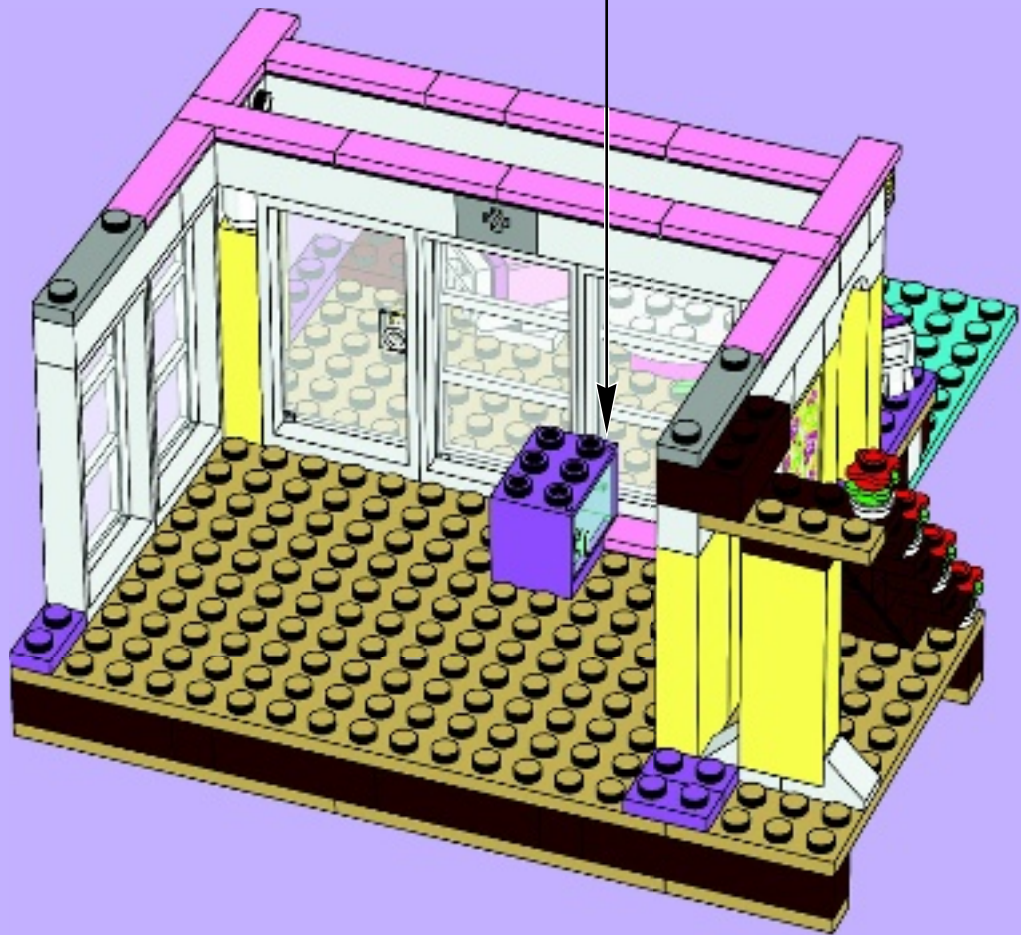
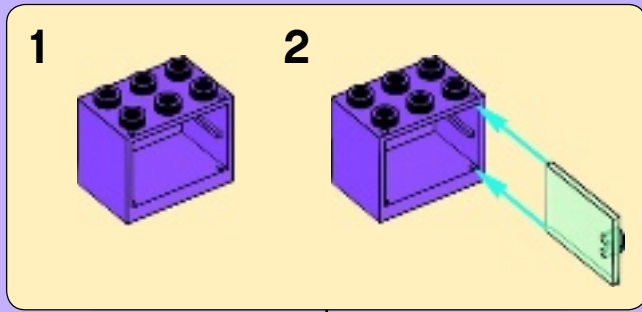

2x



1x



46

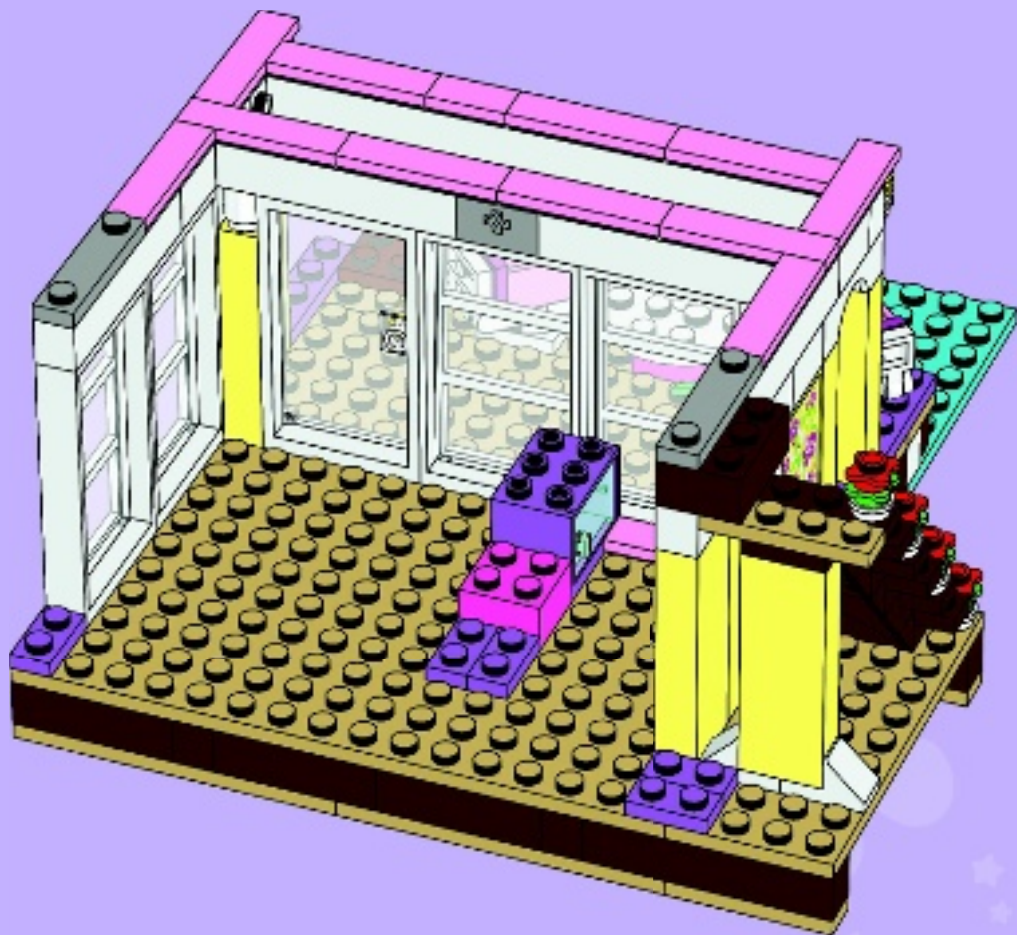



1x



2x

47

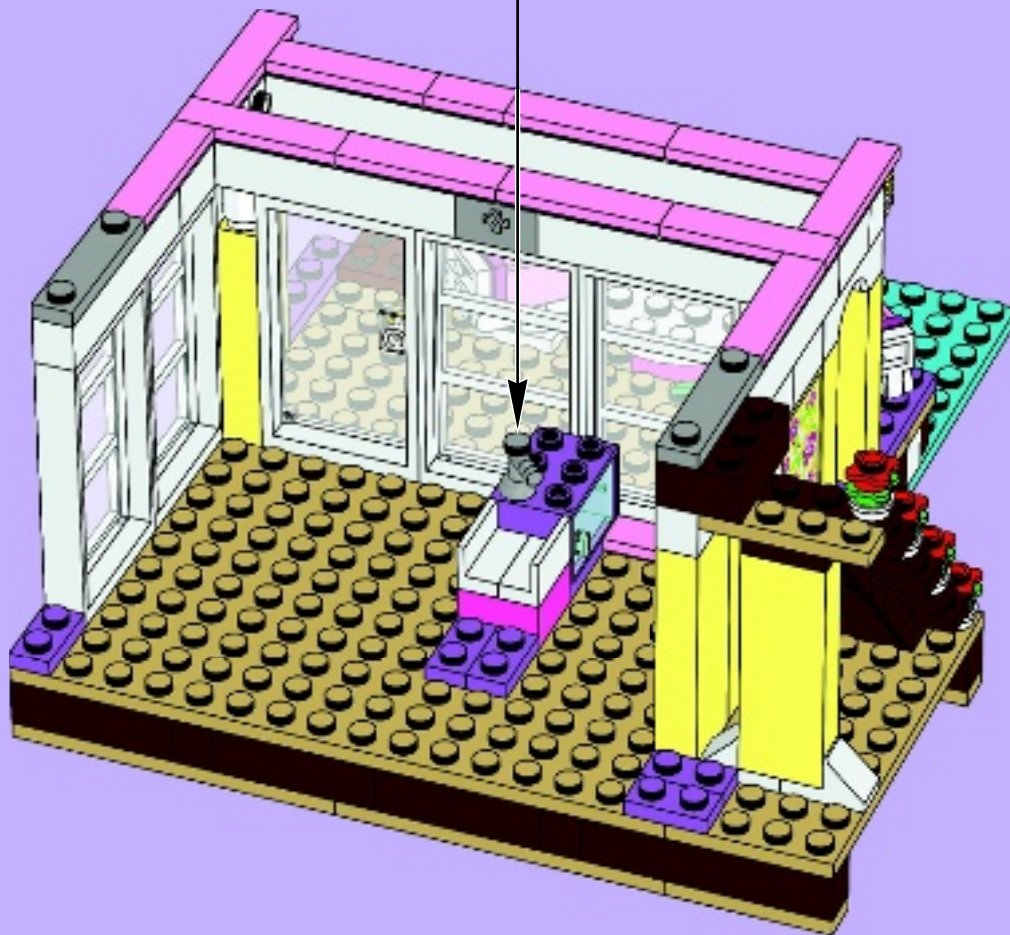

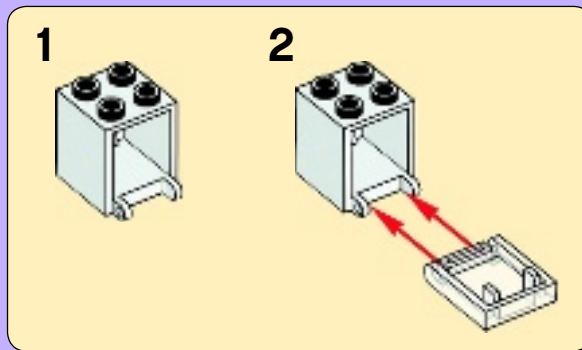
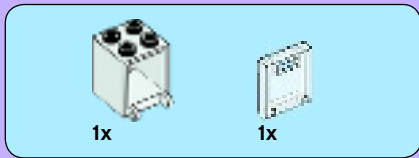

48

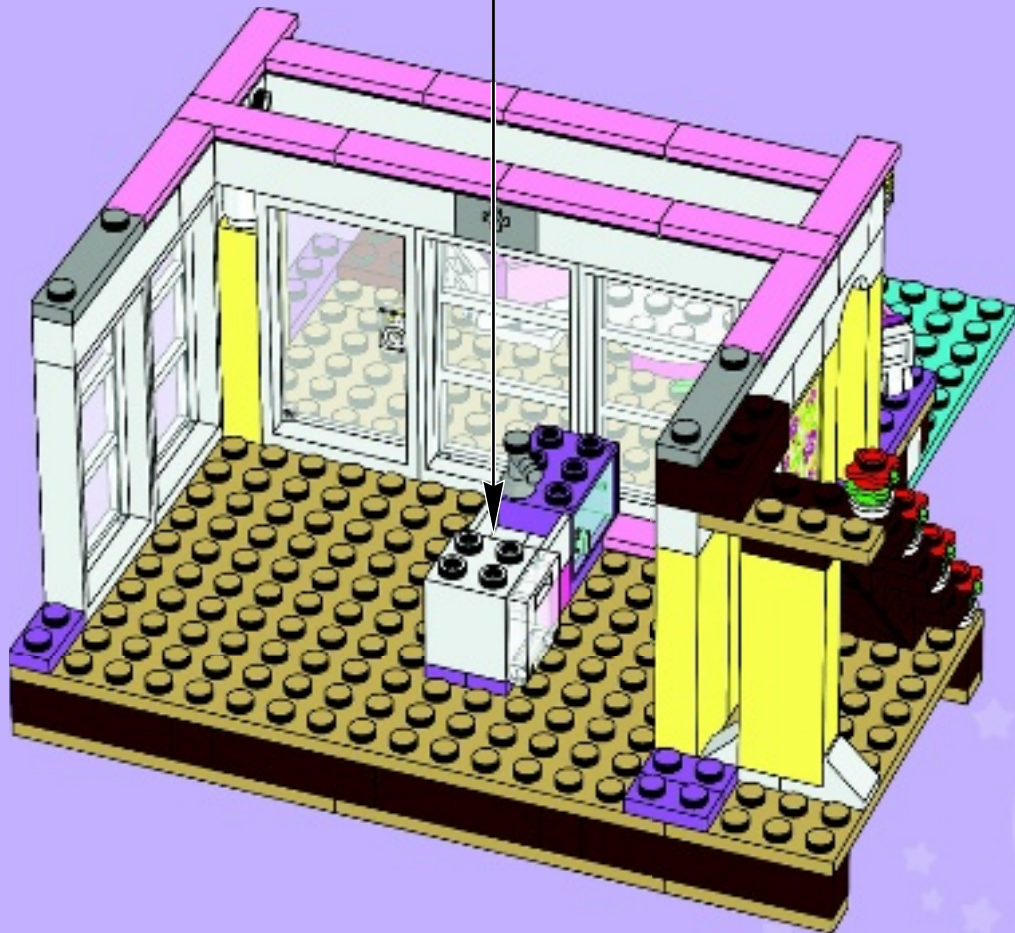



2x



1x

49

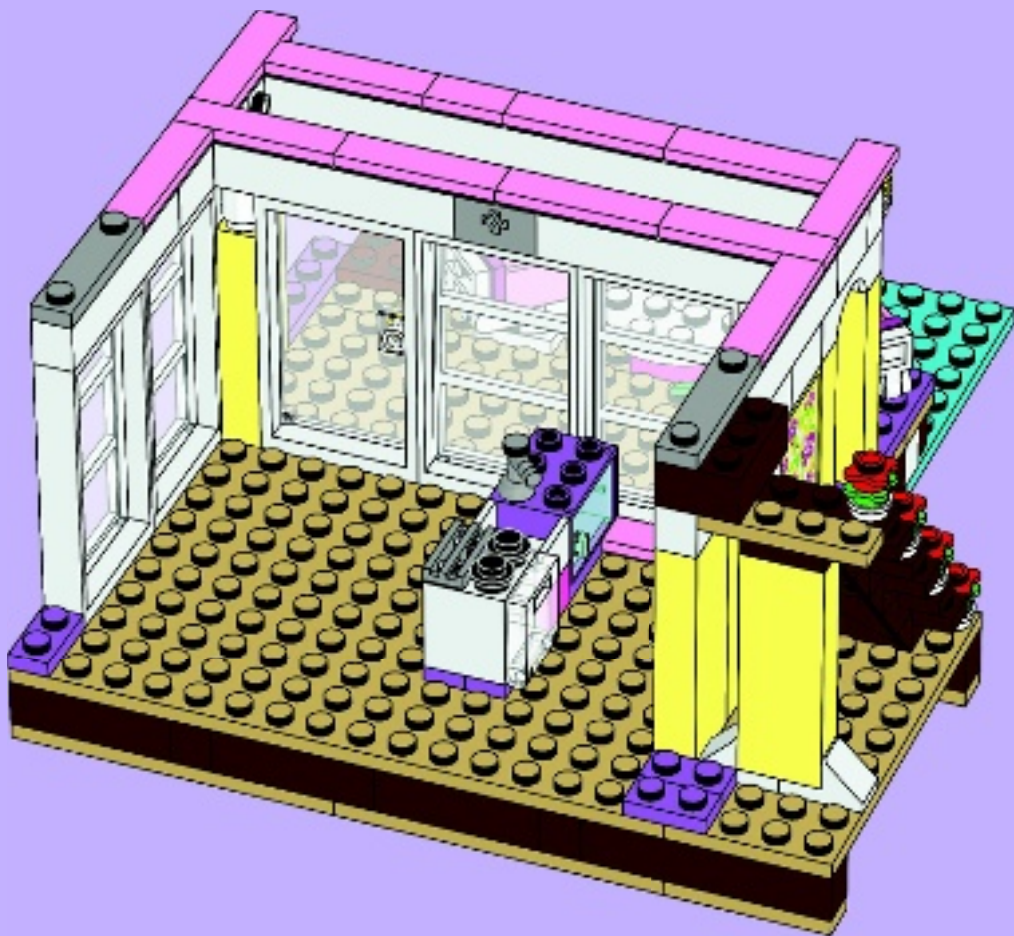

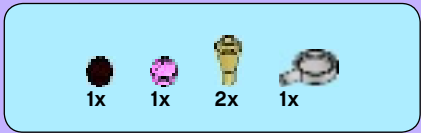

50

