



**BRICK  
HEADZ**

40632



[LEGO.com/brickheadz](https://www.lego.com/brickheadz)



 **FR**  
**DONNEZ**  
OU  
**RECYCLEZ**

 OU  OU   
ASSOCIATION MAGASIN DÉCHÈTERIE

Adresses sur [quefairedemesdechets.fr](http://quefairedemesdechets.fr)



[LEGO.com/sustainable-packaging](https://LEGO.com/sustainable-packaging)



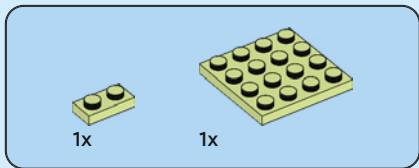

1

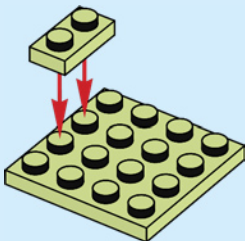



1x

2

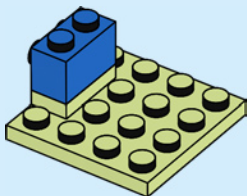

4x

3

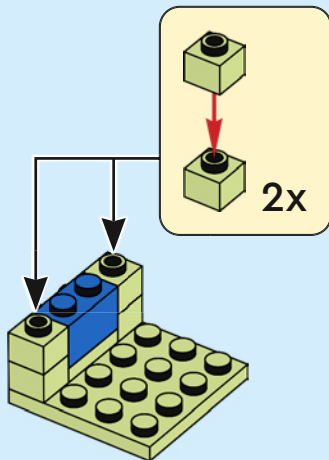

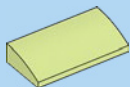

1x

4

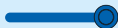
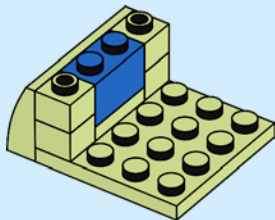



2x



2x

5

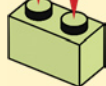
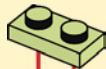

2x

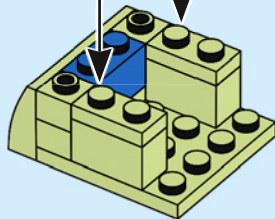

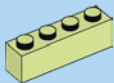

1x

6

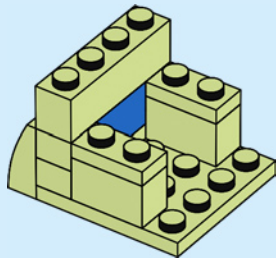





7

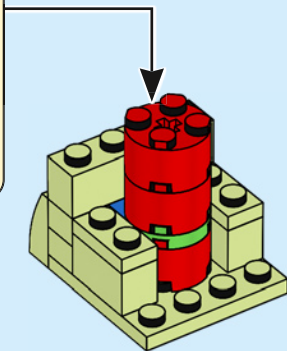
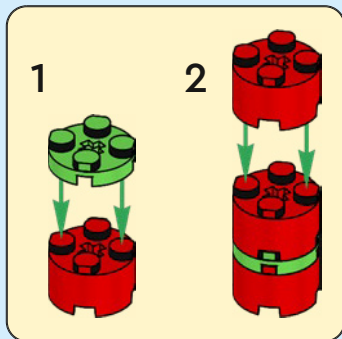

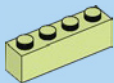

1x

8

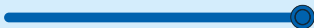
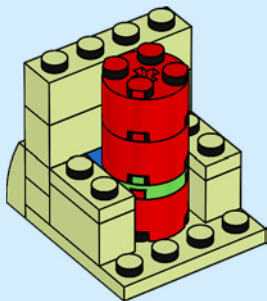



2x



2x

9



2x

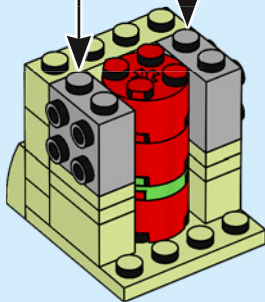

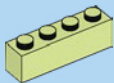

2x

# 10

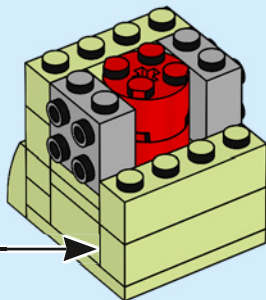
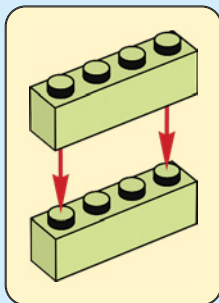

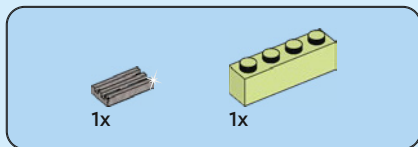

11

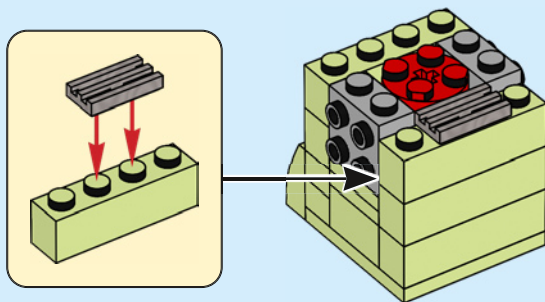



1x



2x

# 12

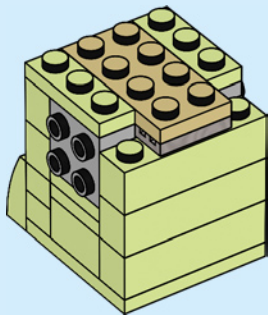



13

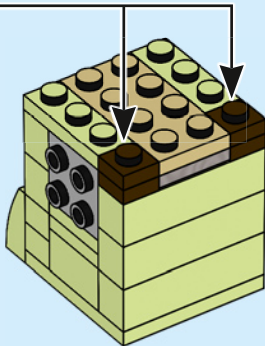
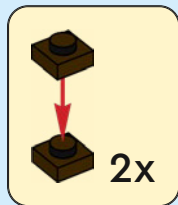



4x



2x



4x

# 14

1

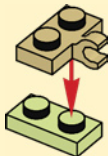

2



3

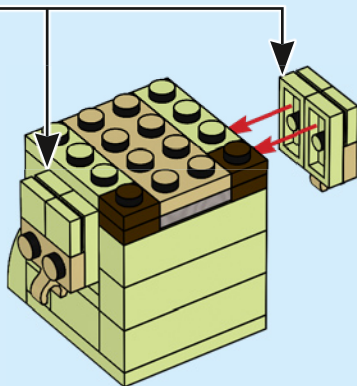
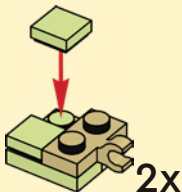





6x

15

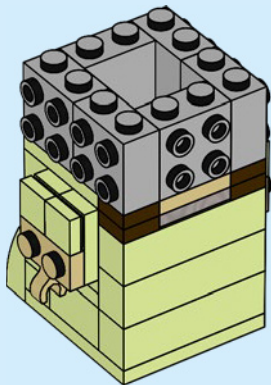

2x

16

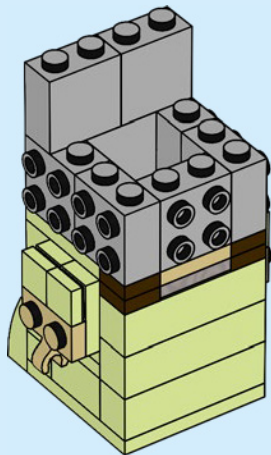



1x



1x



2x

17

1

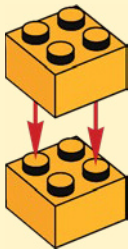

2

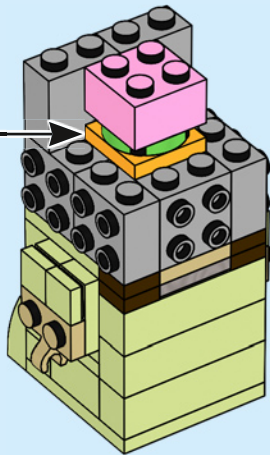
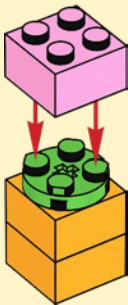



4x

18

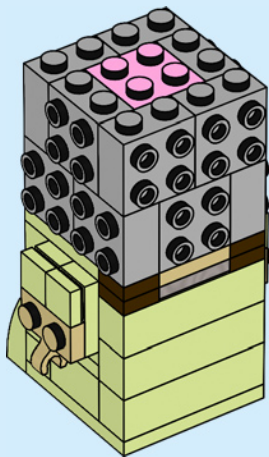

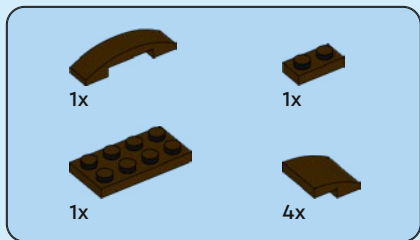

19



2



3

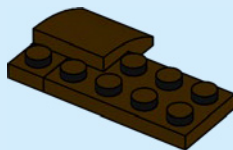

4

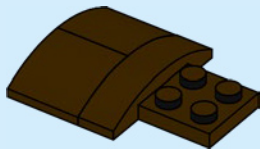

5

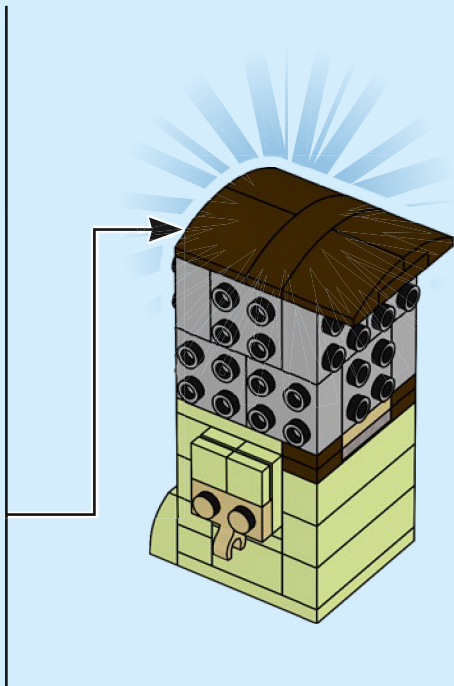
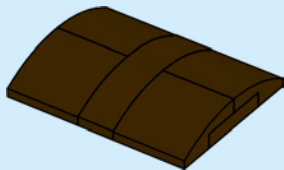

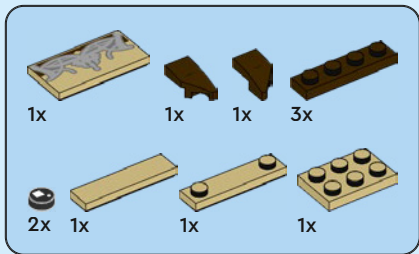

20

1

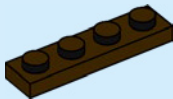

2



3



4

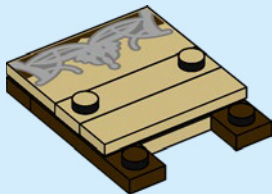

5

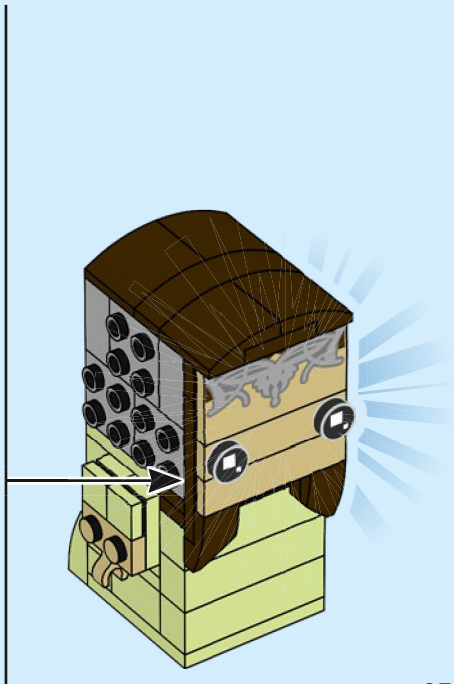
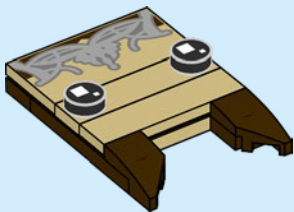



1x



2x



1x

# 21

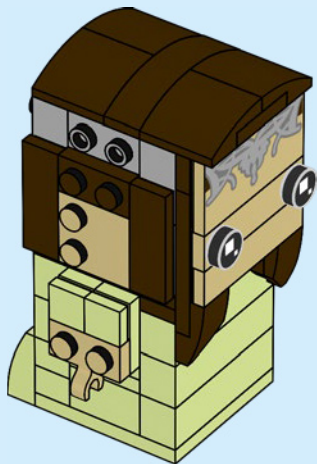





1x

22

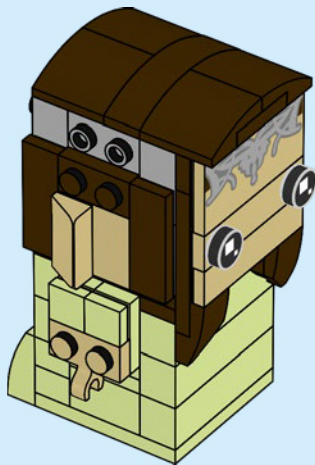



2x

# 23

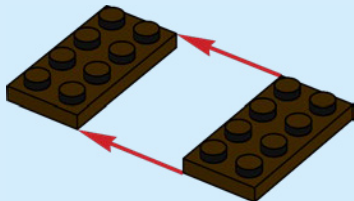



1x

24

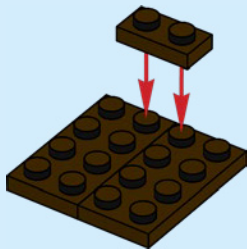

1x



1x

25

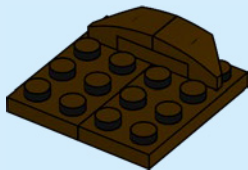

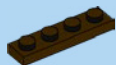

1x



2x

# 26

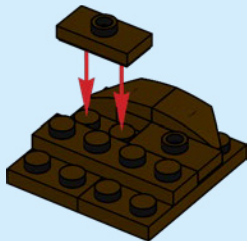



2x



1x

# 27

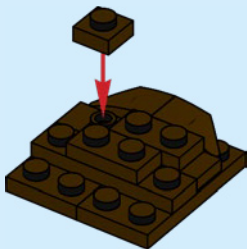

1x



1x



1x

# 28

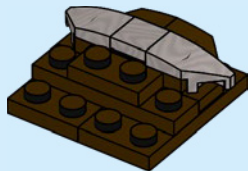



2x

29

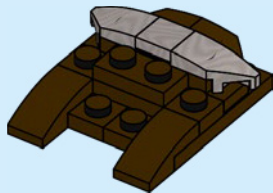

2x

30

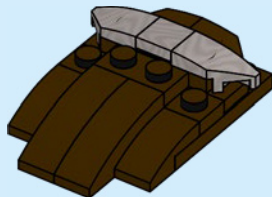

31

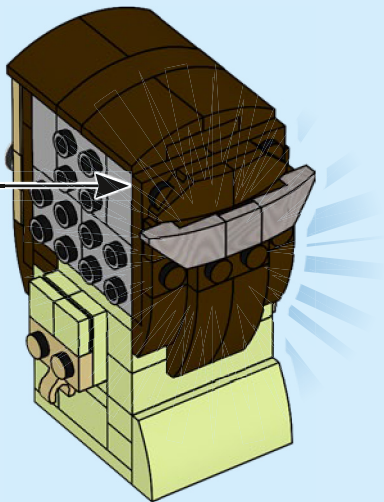

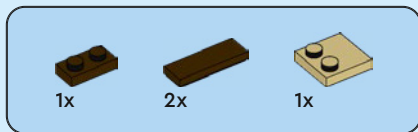

32

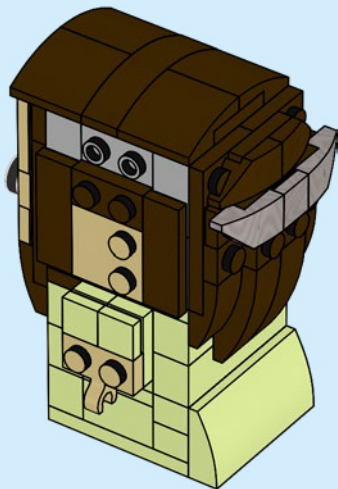





1x

33

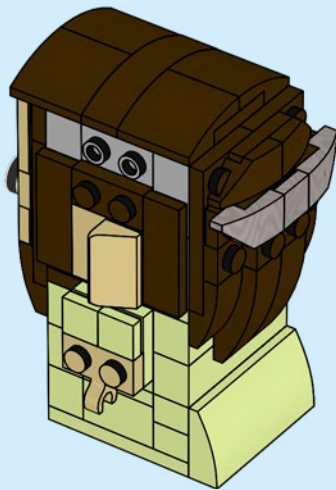



1x



1x



2x

# 34

1

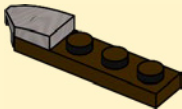

2

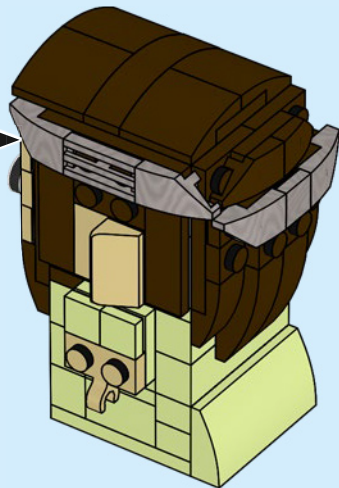
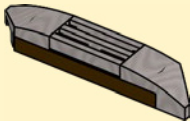

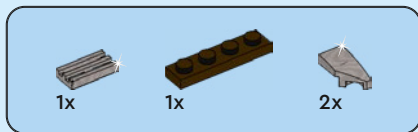

35

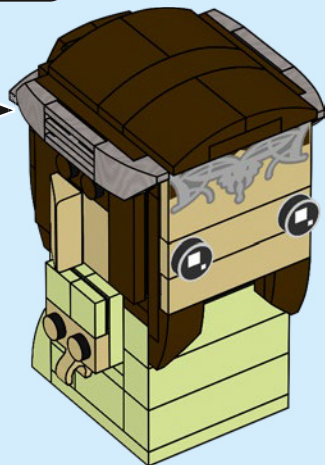
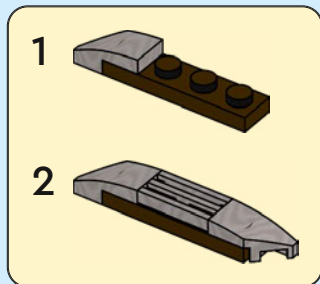

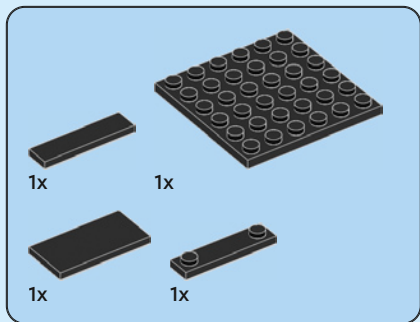

36

1

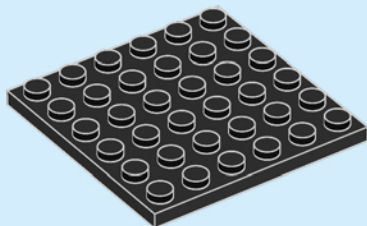

2

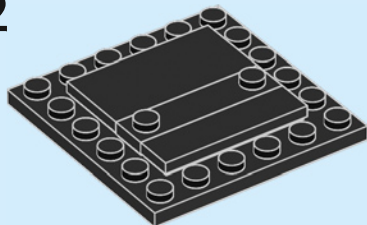

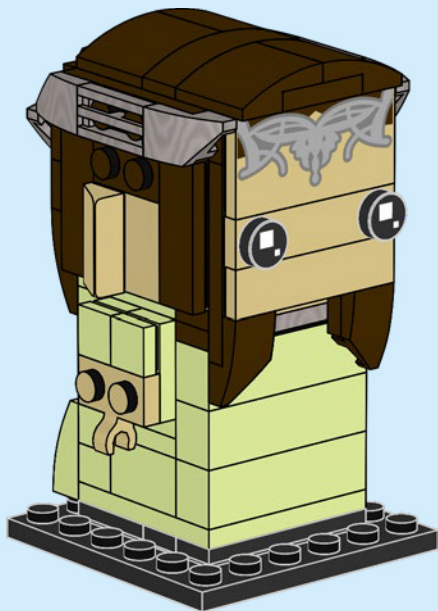

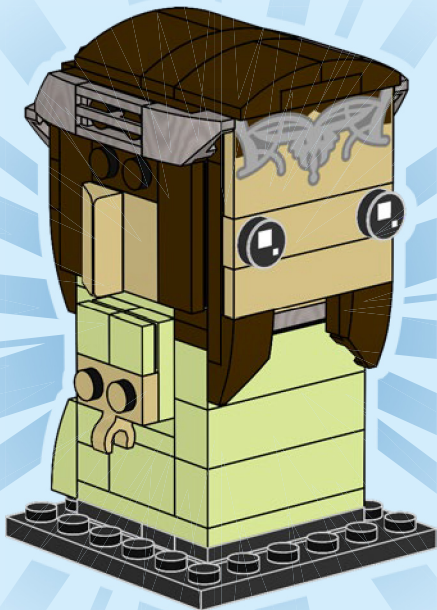



Rebuild  
the  
world™



YOU COULD

WIN



Scan this QR code or go to  
**LEGO.COM/PRODUCTFEEDBACK** and give us  
your short feedback about this LEGO® set  
for a chance to win a cool LEGO prize.

Terms and Conditions apply\*

**DE: Du könntest GEWINNEN.** Es gelten die Teilnahmebedingungen\* **FR: Tu pourrais GAGNER.** Des conditions s'appliquent\* **IT: Potresti VINCERE tu.** Termini e condizioni sono applicabili\* **ES: Puedes GANAR.** Aplican términos y condiciones\* **PT: Poderá GANHAR.** Aplicam-se termos e condições\* **JA: プレゼント付き! 利用規約が適用されます\*** **ZH: 轻松获奖. 条款和条件适用\*** **KO: 상품의 주인이 되어보세요. 소정의 약관이 적용됩니다\*** **RU: Вы можете ВЫИГРАТЬ.** Действуют положения и условия\* **PL: Szansa na WYGRANĄ.** Obowiązują warunki korzystania\* **CS: Máte šanci VYHRÁT.** Platí všeobecné smluvní podmínky\* **SK: Máte šancu VYHRATĚ.** Platia všeobecné zmluvné podmienky\* **HU: TE IS NYERHETSZ.** Felhasználási feltételek érvényesek\* **RO: Ai putea CĂȘTIGA.** Se aplică termenii și condiții\* **BG: Можете да СПЕЧЕЛИТЕ.** Има определени правила и условия\* **LV: Tu vari LAIMĒT.** Ir spēkā noteikumi un nosacījumi.\* **ET: Sul on võimalus VÕITA.** Kehtivad tingimused\* **LT: Jūs galite LAIMĖTI.** Taikomos sąlygos\*

\*[LEGO.com/productfeedback-terms](https://www.lego.com/productfeedback-terms)

LEGO and the LEGO logo are trademarks of the LEGO Group. ©2023 The LEGO Group.

©NLP TM Middle-earth Ent. Lic. to NLP.

6505937