



NINJAGO

Masters of Spinjitzu



2505



 **WARNING: CHOKING HAZARD.**
Small parts. Not for children under 3 years.

1

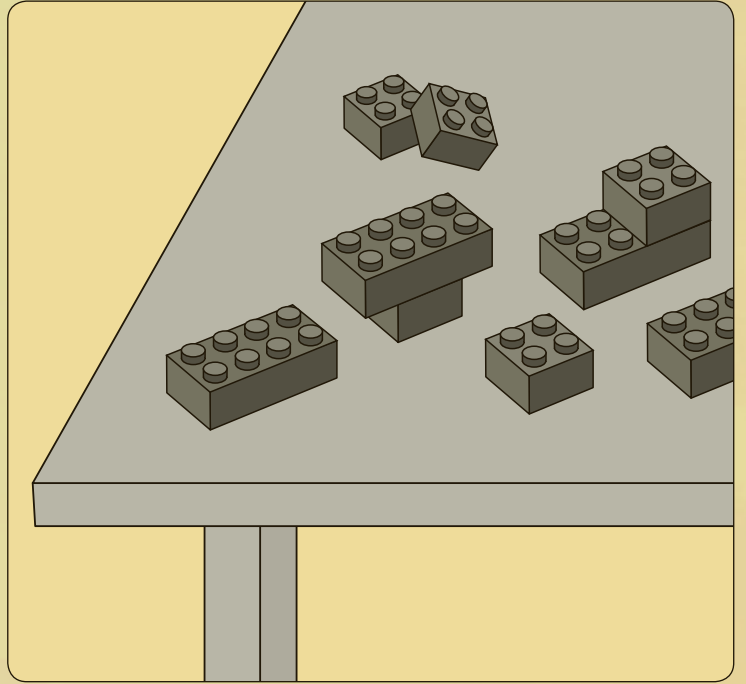
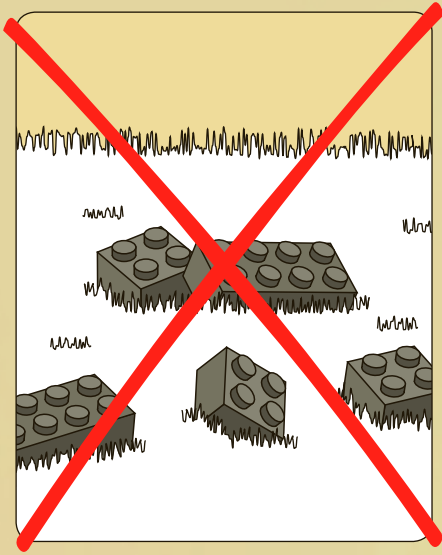

2



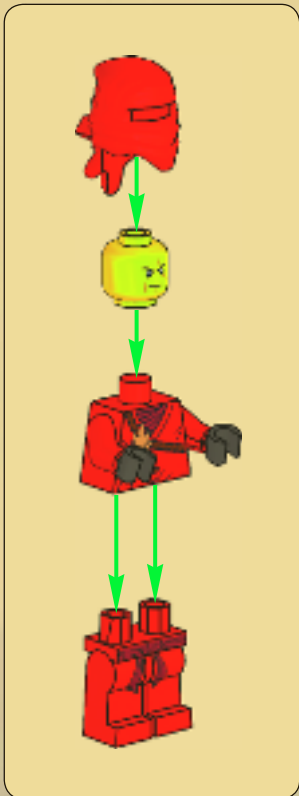

⚠ **AVERTISSEMENT : RISQUE D'ÉTOUFFEMENT.**
 Contient des petites pièces. Ne convient pas aux enfants de moins de 3 ans.

⚠ **ADVERTENCIA: PELIGRO DE ASFIXIA.**
 No recomendado para niños menores de 3 años. Contiene piezas pequeñas.

1

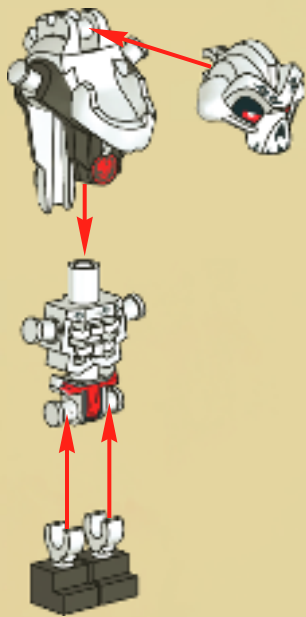

2



3

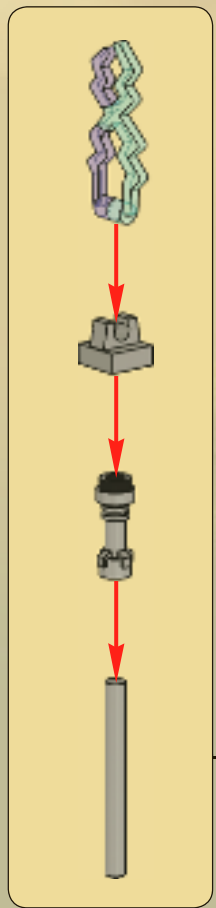
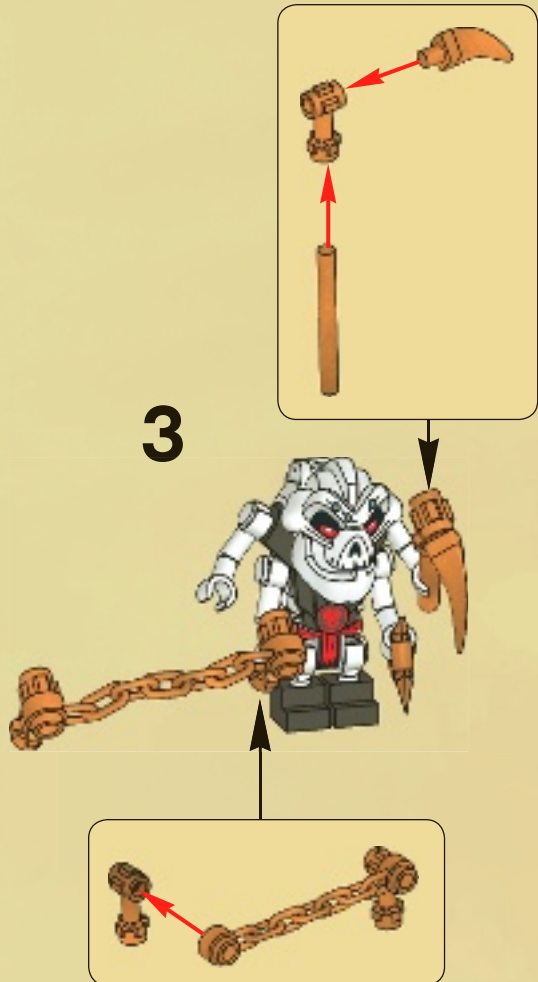

4

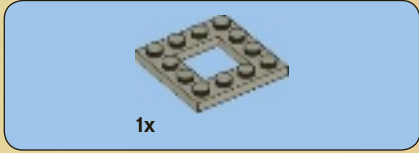

1

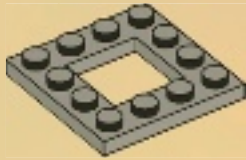

2

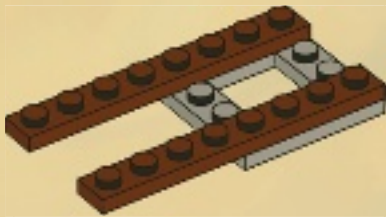

3

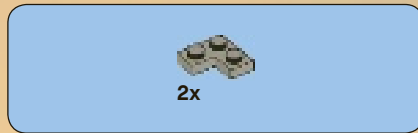
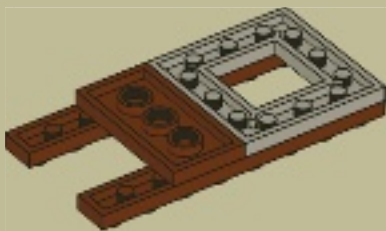

4

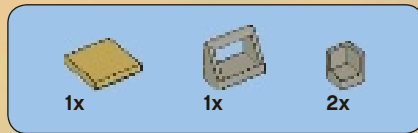
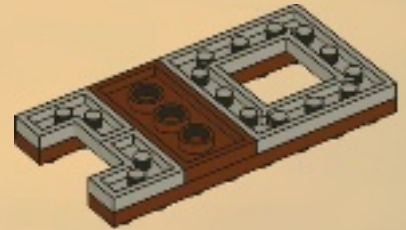

5

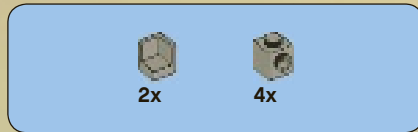
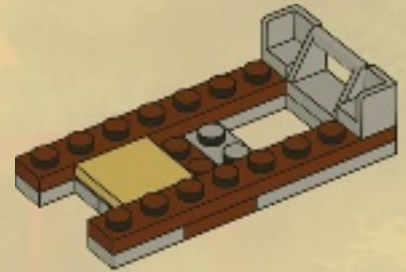

6

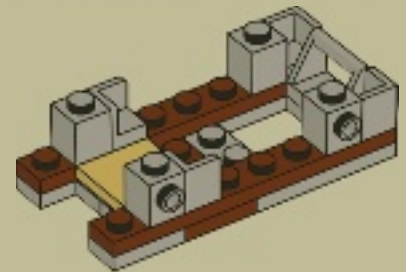

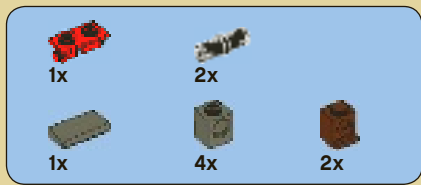

7

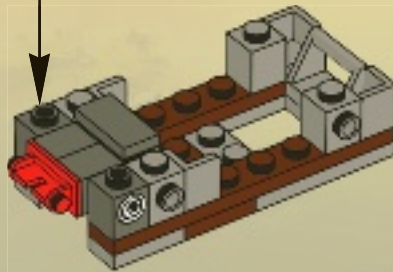
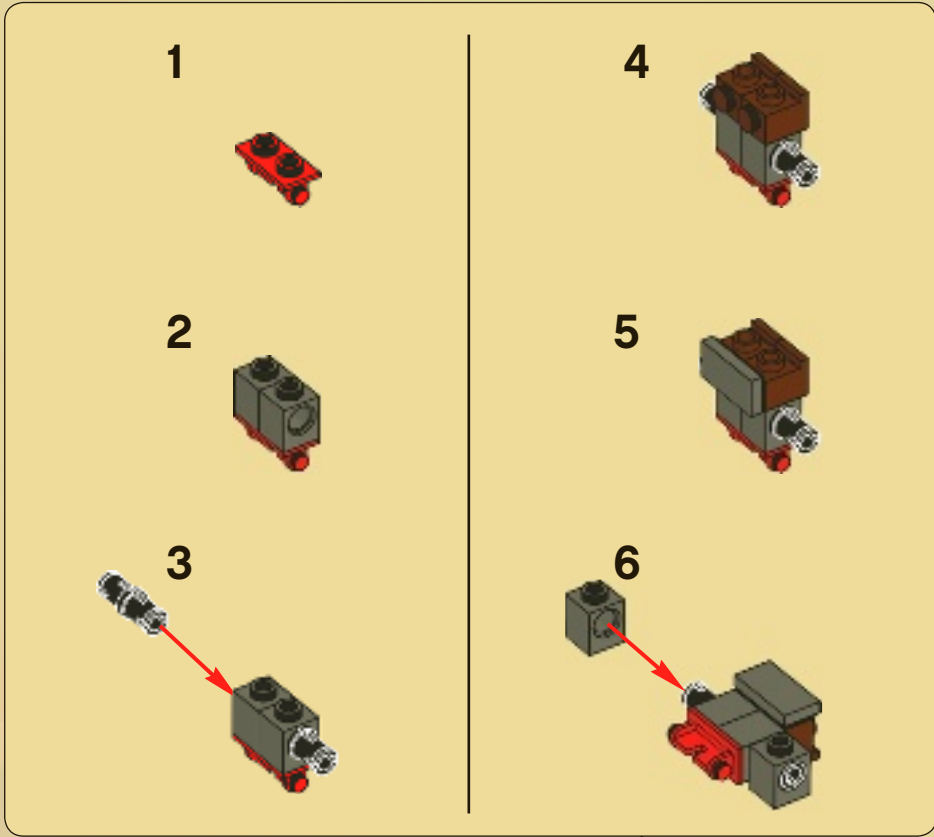

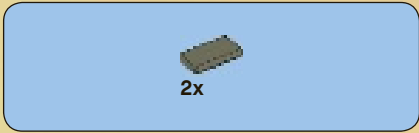

8

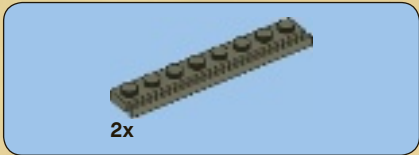
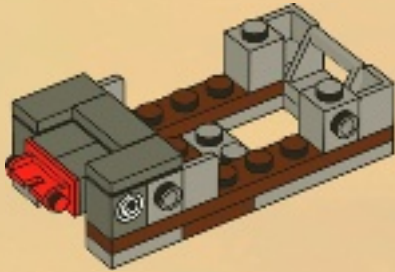

9

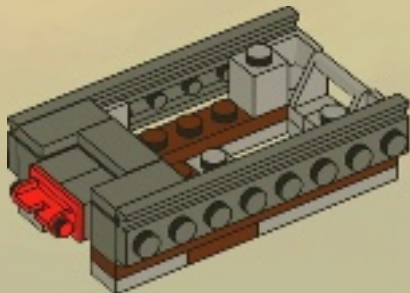

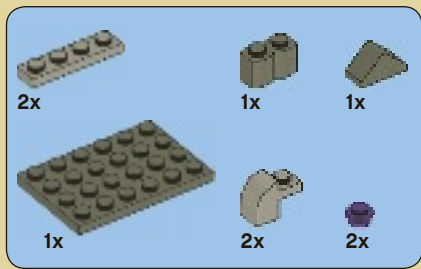

10

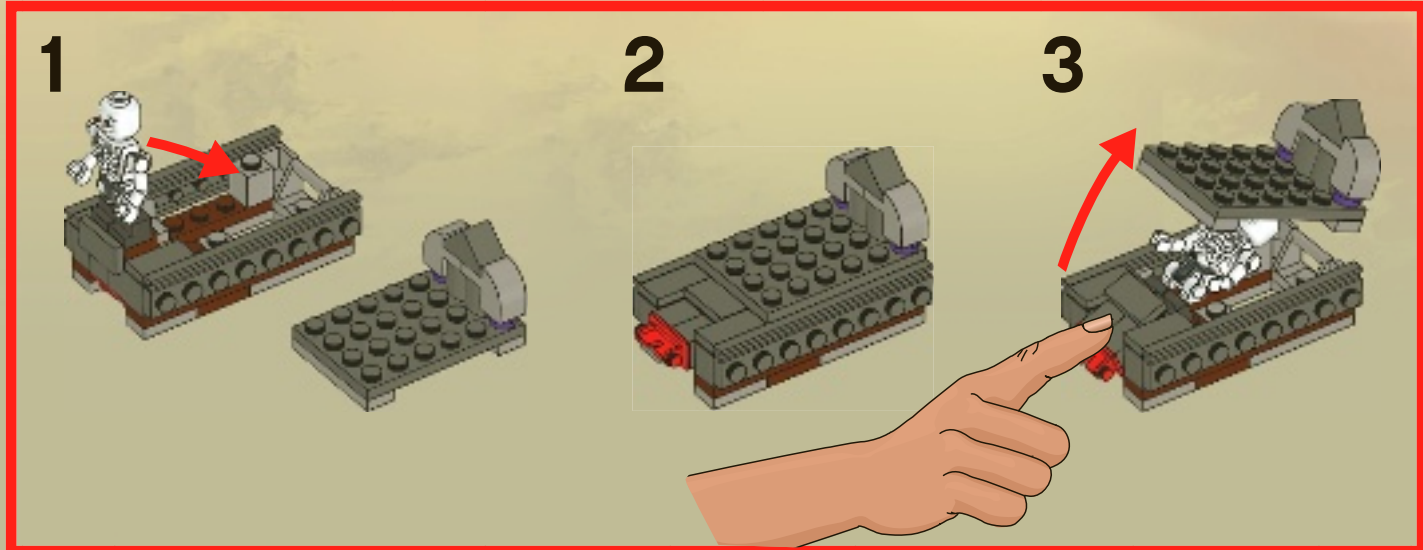
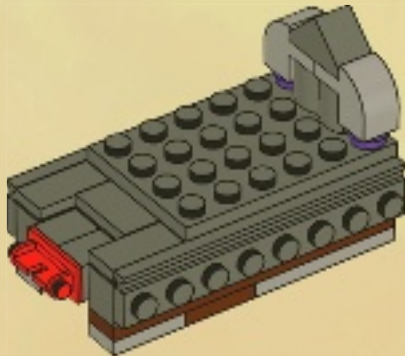
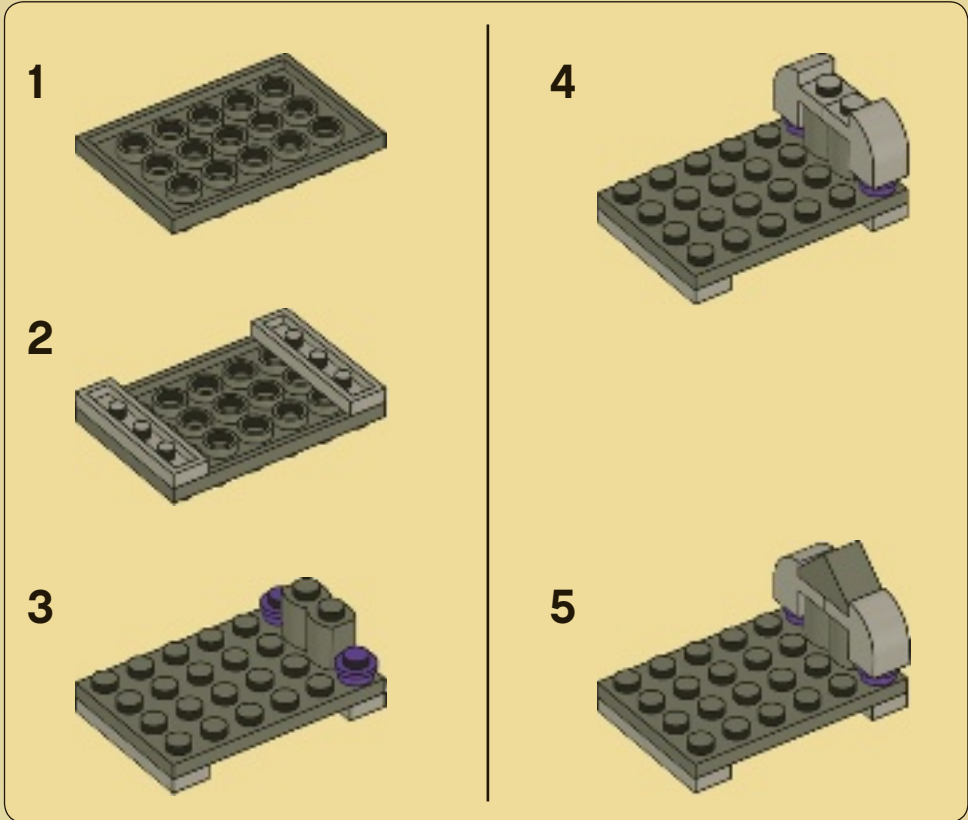

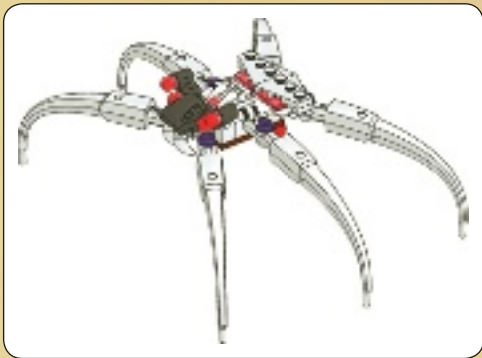

1

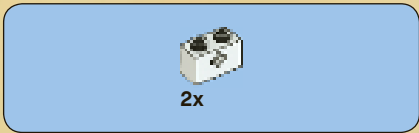

2

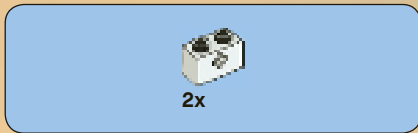
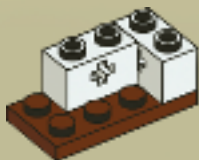

3

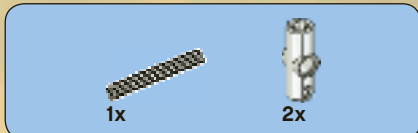

4

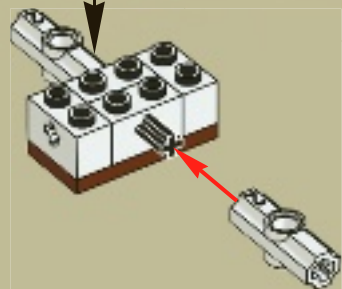
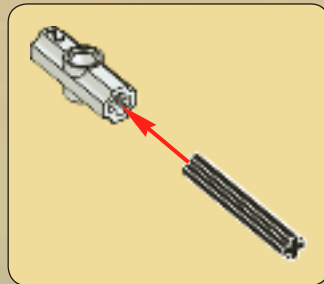



2x

5

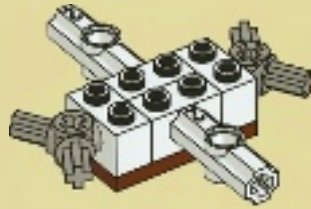

4x

6

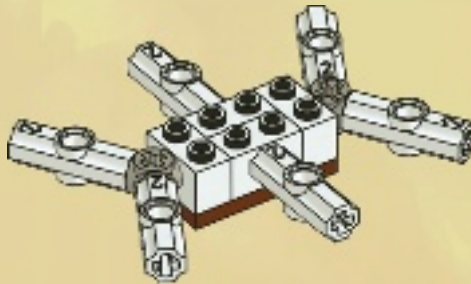

6x

7

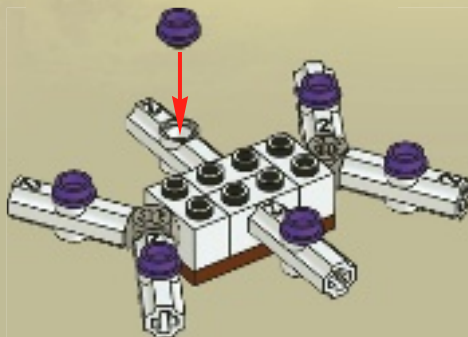

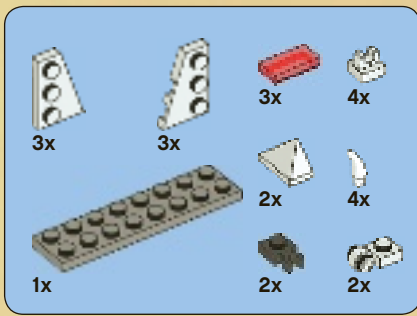

8

1

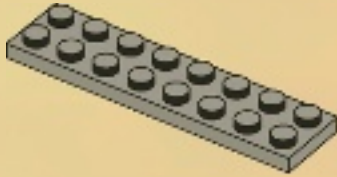

2

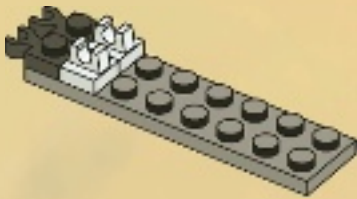

3

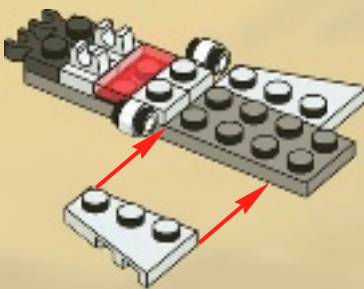

4

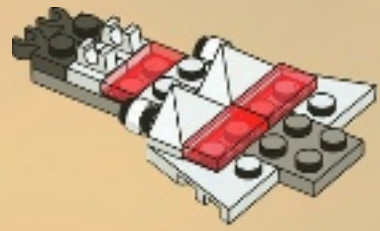

5

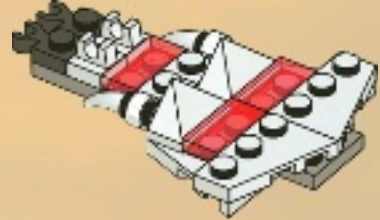

6

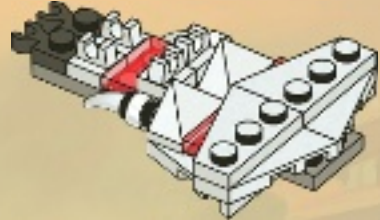

7

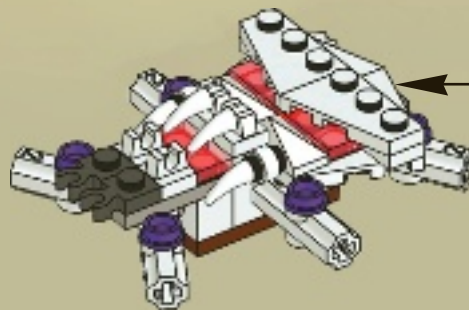
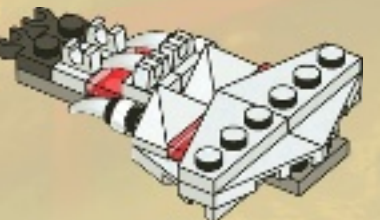



9

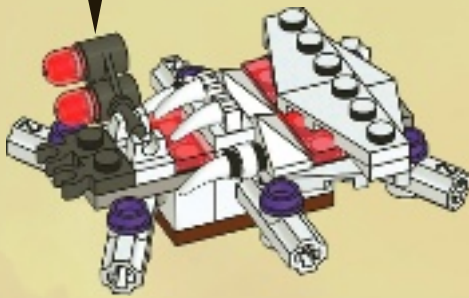

10

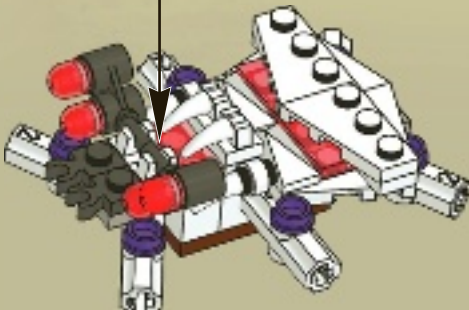
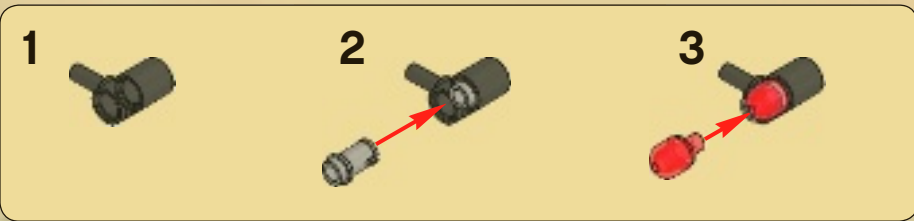



11

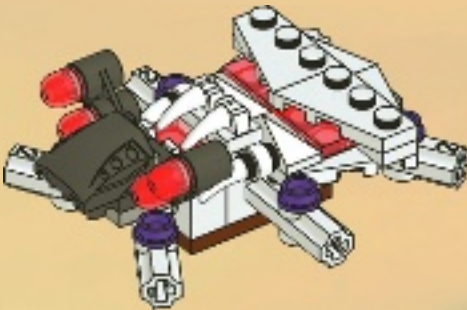

12

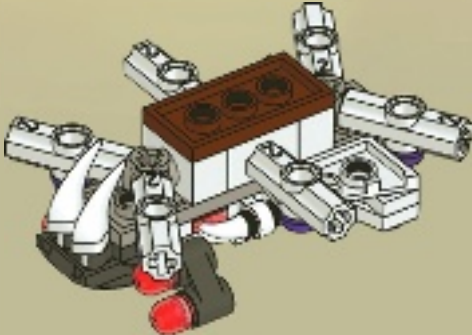

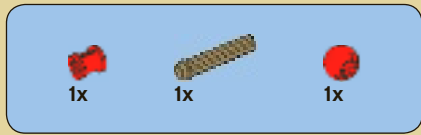

13

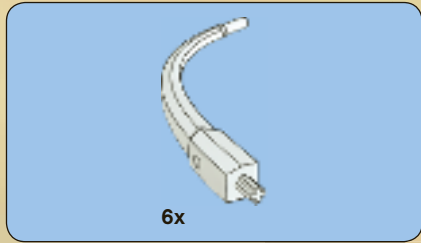
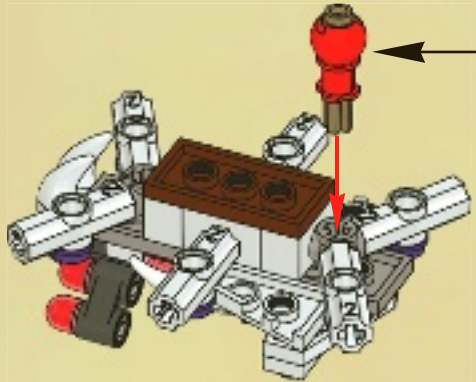
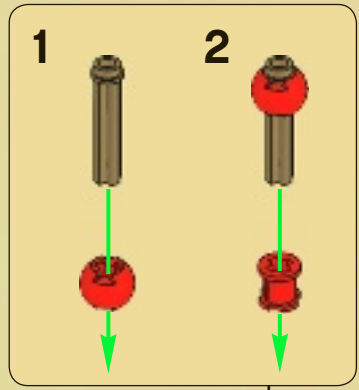

14

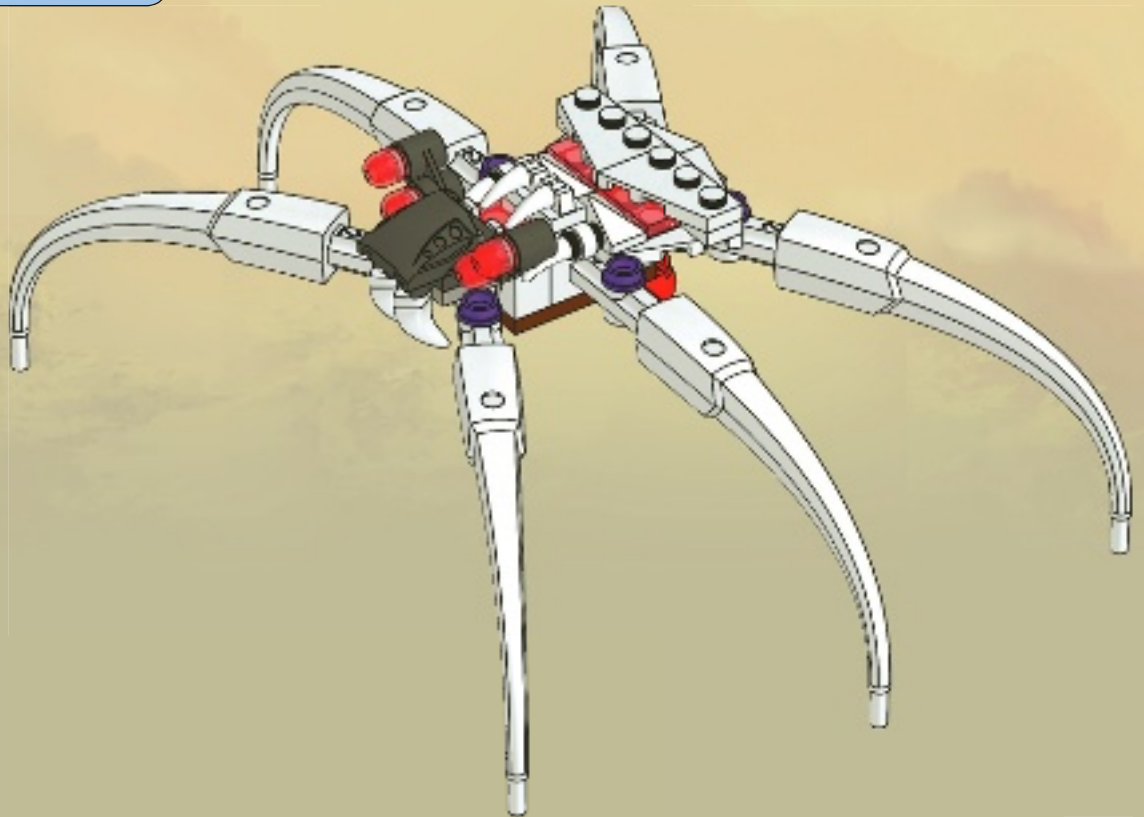

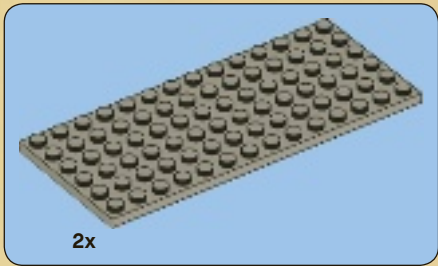
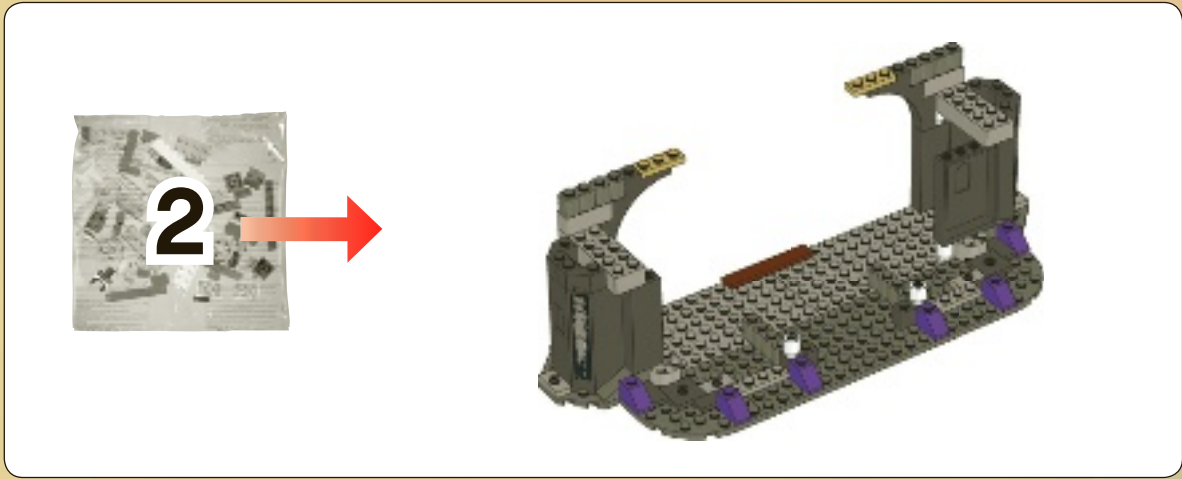

1

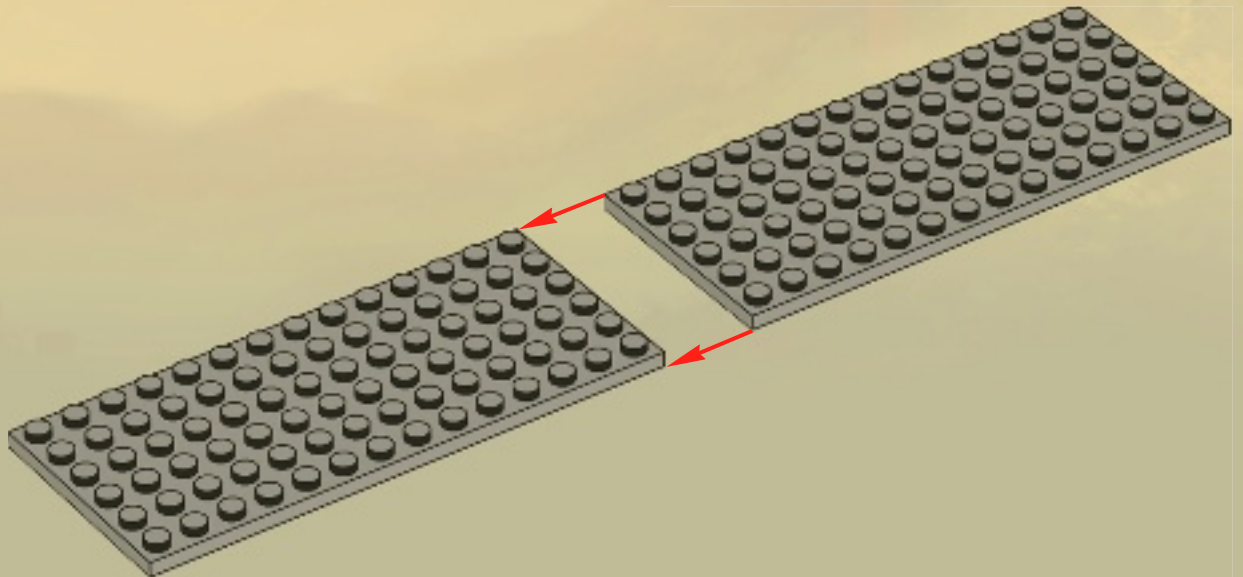



2

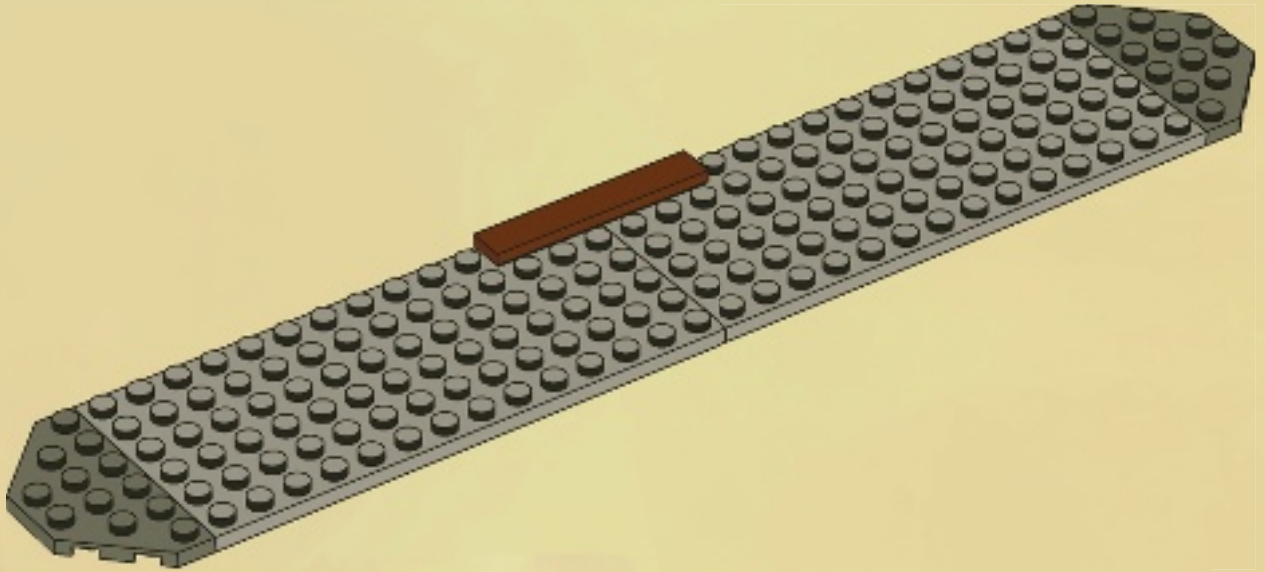

3

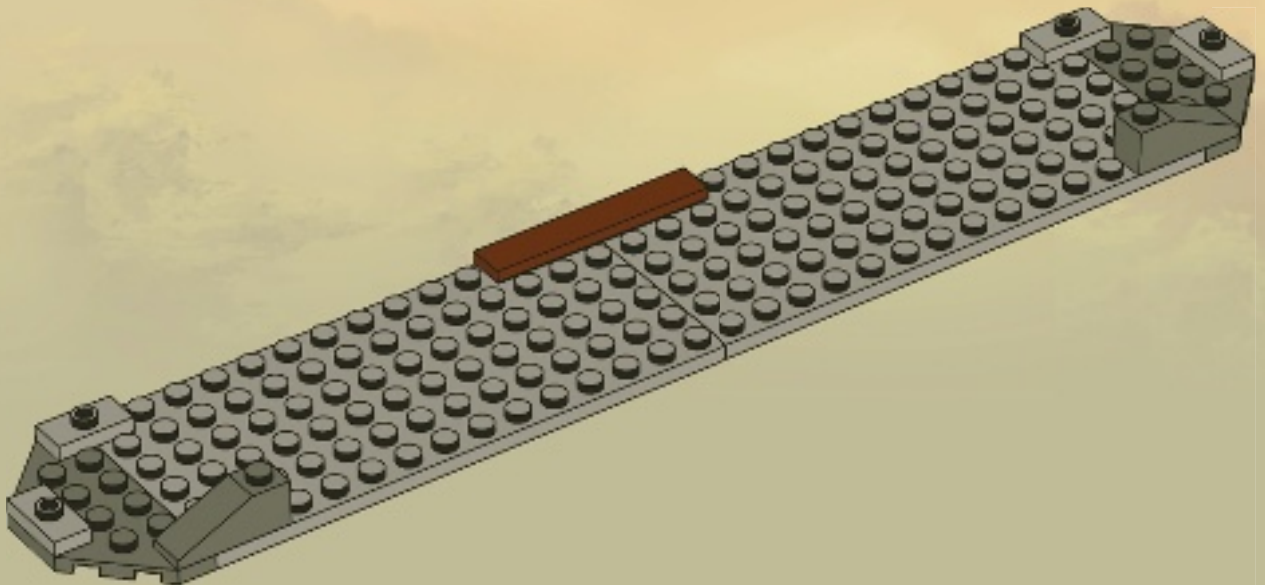



1x



2x

4

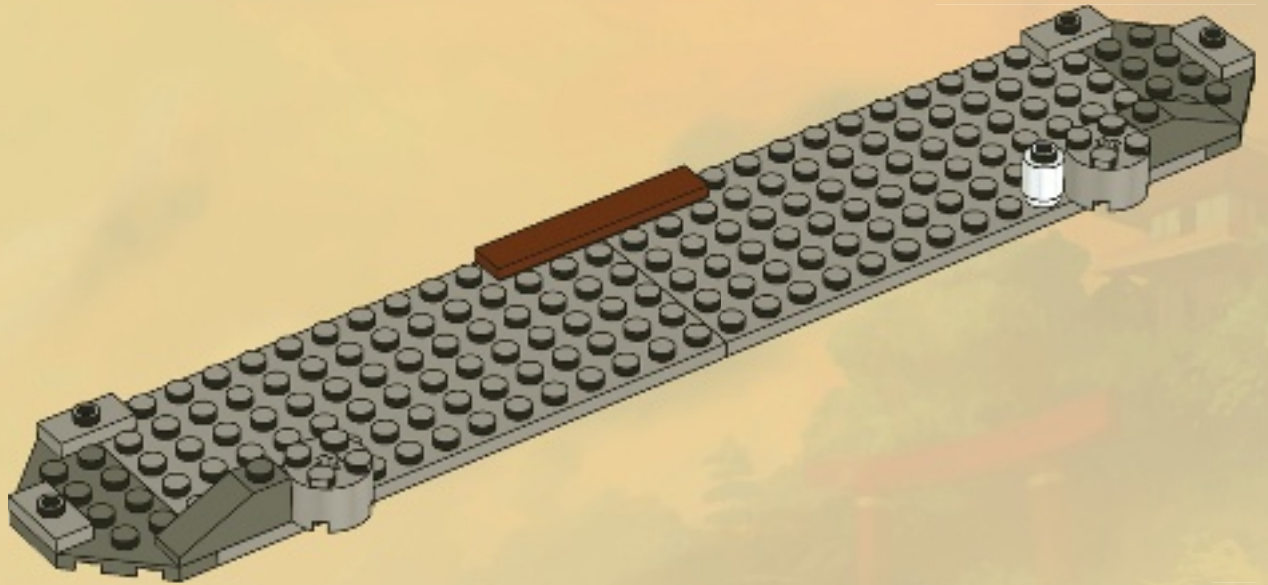



1

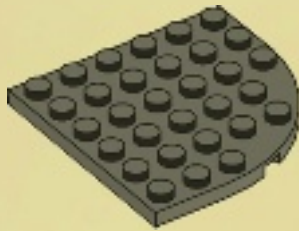

2

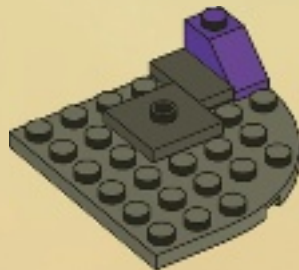

3

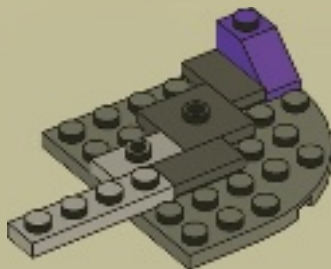

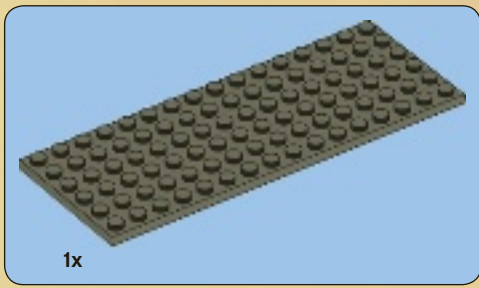

4

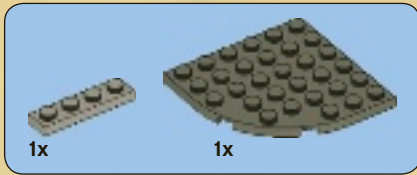
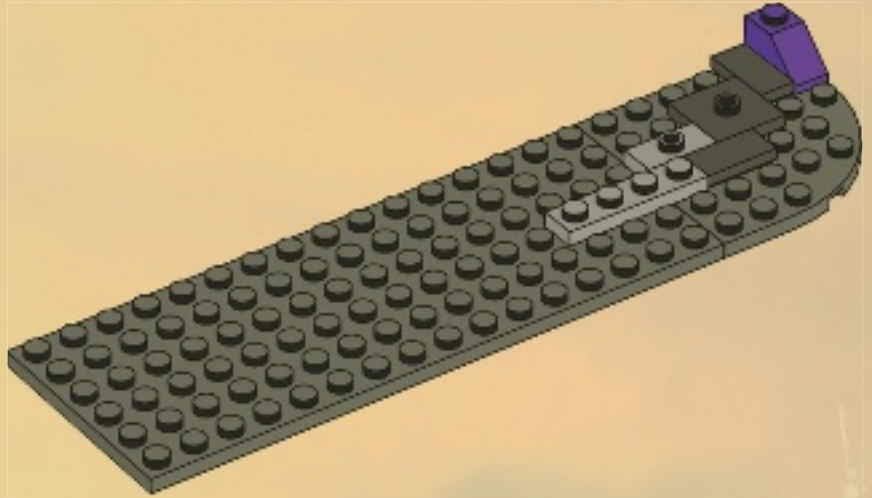

5

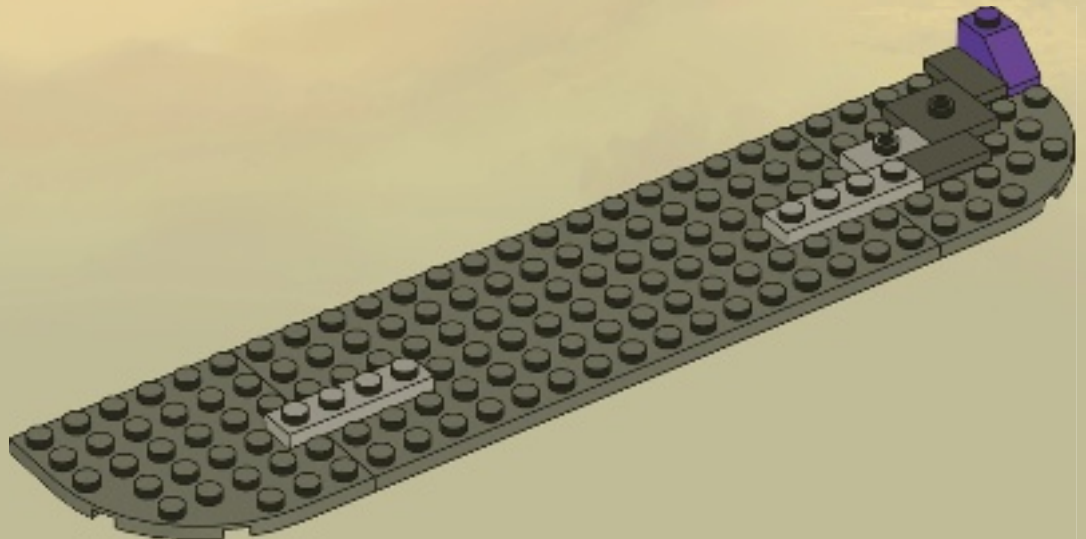

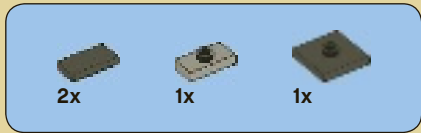

6

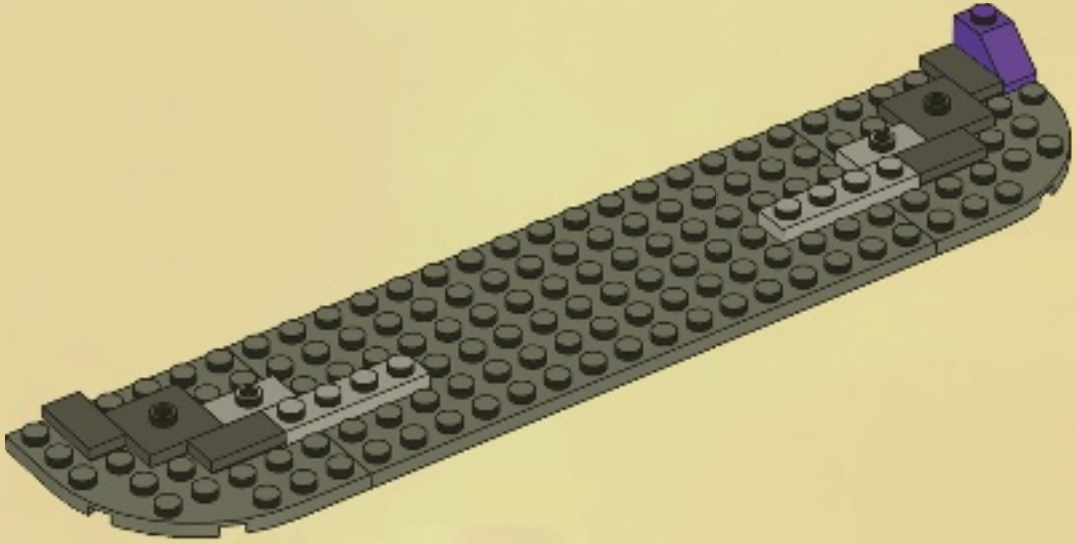

7

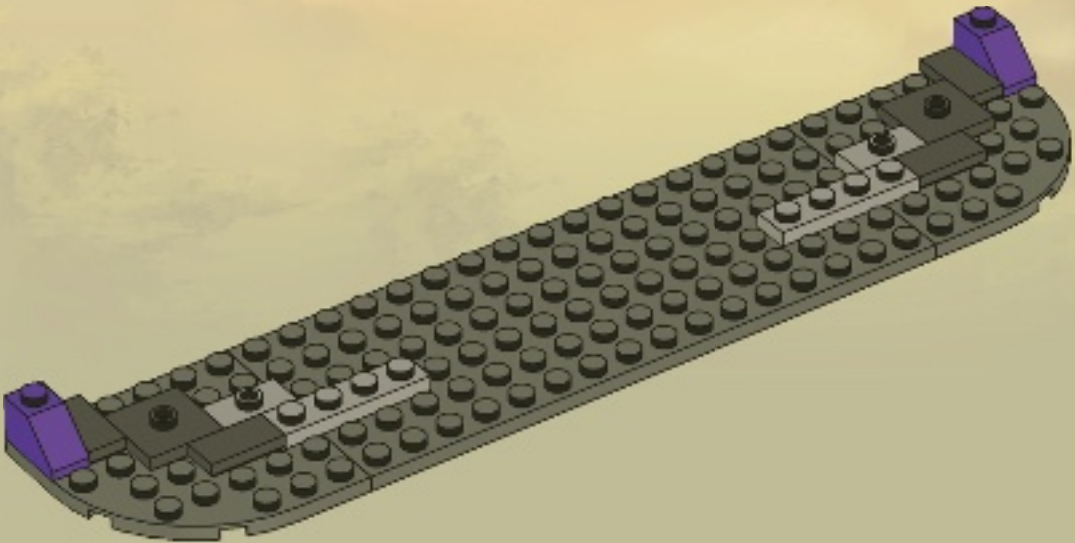

8

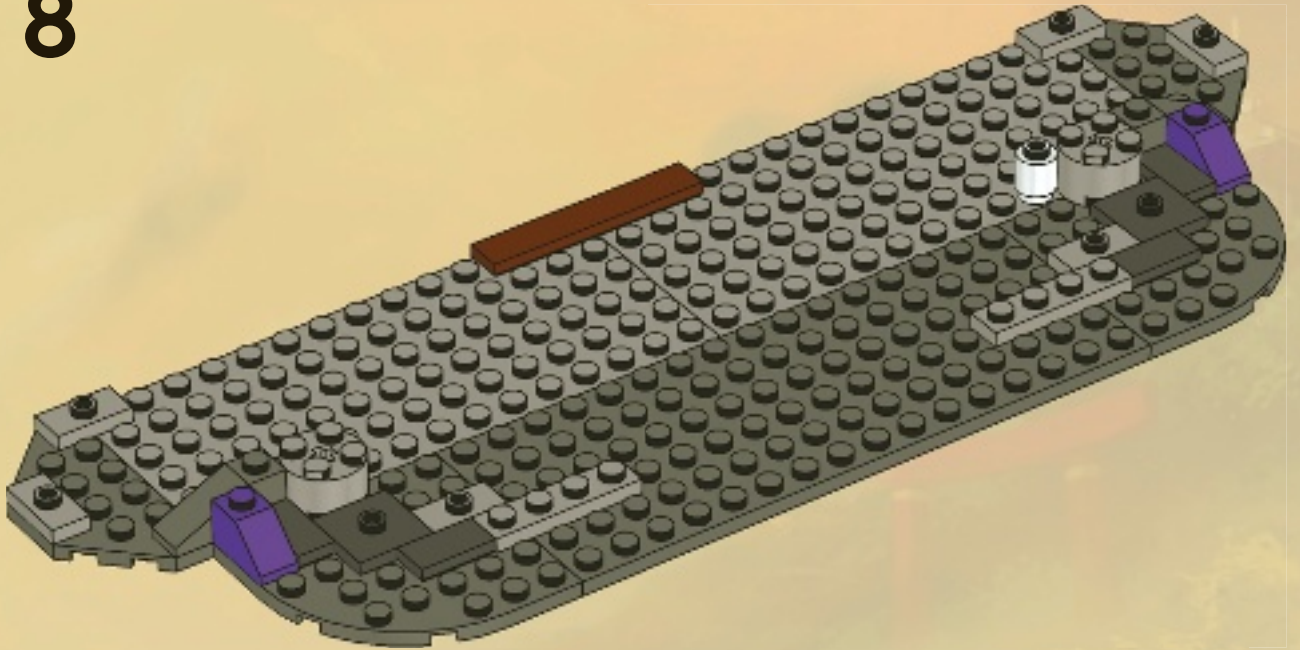



9

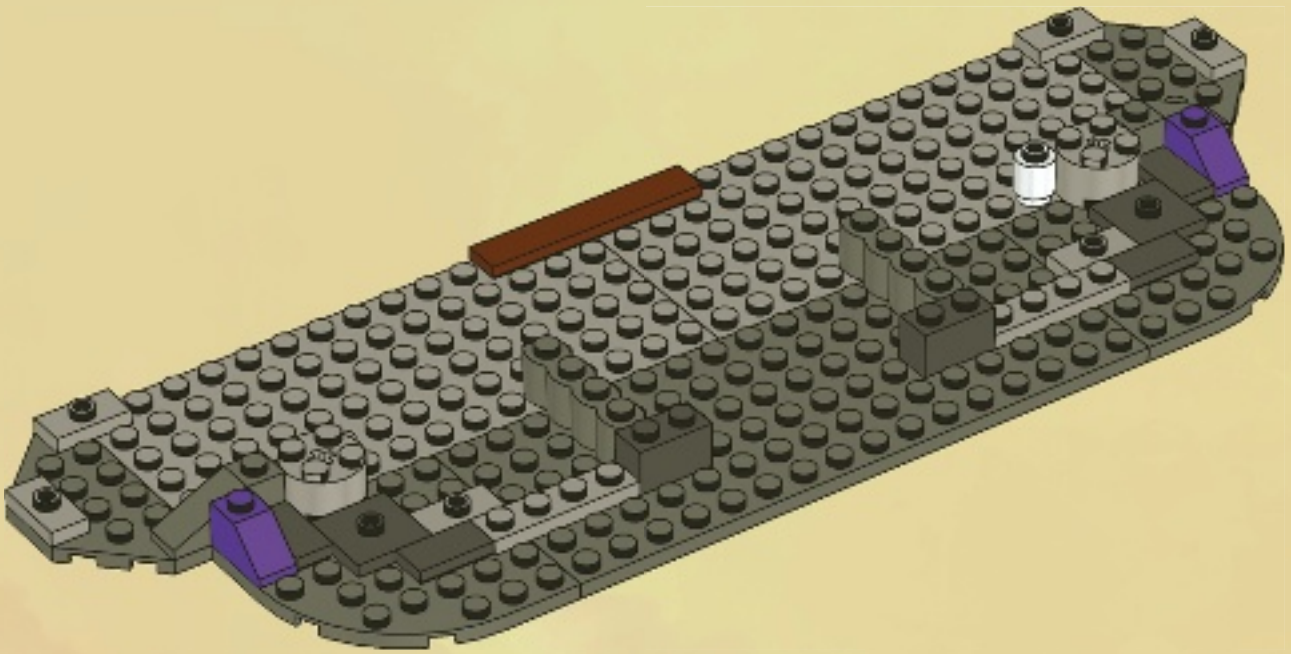

10

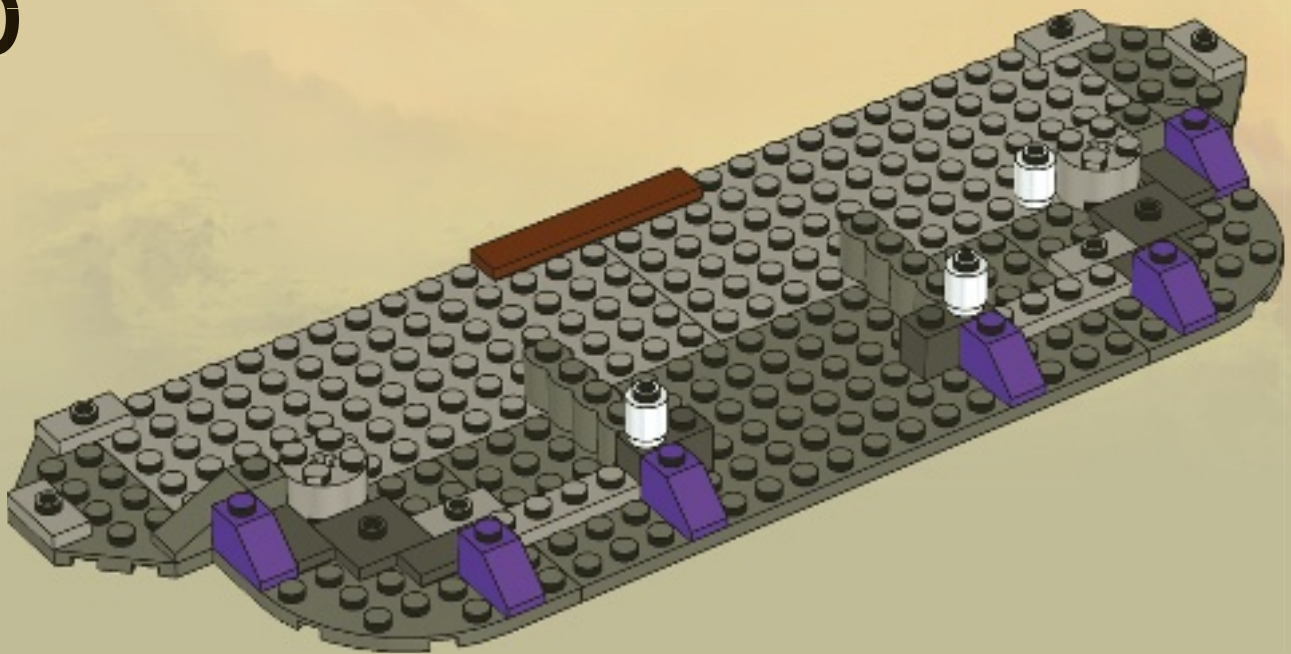

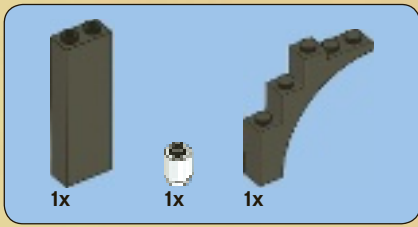

11

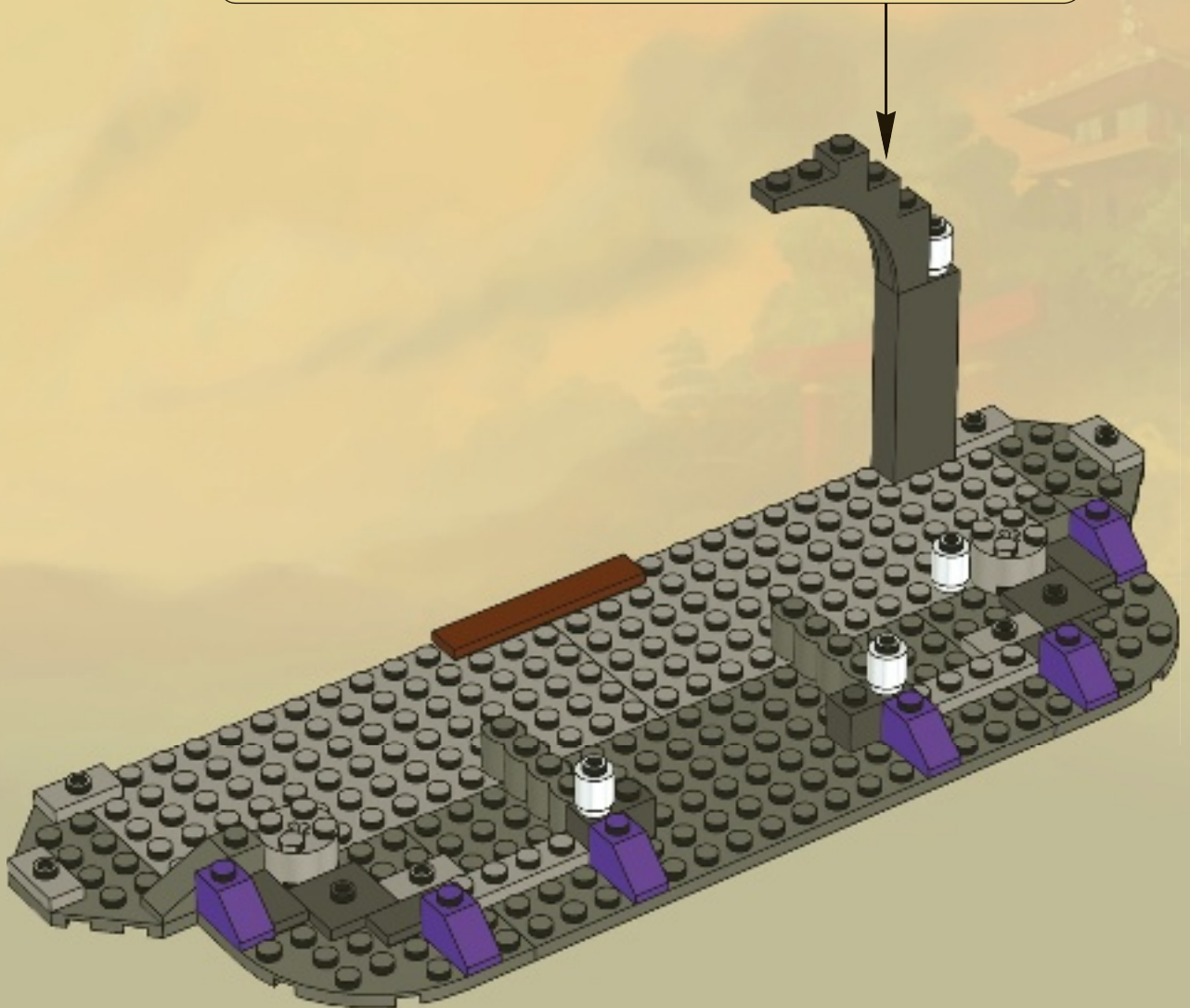
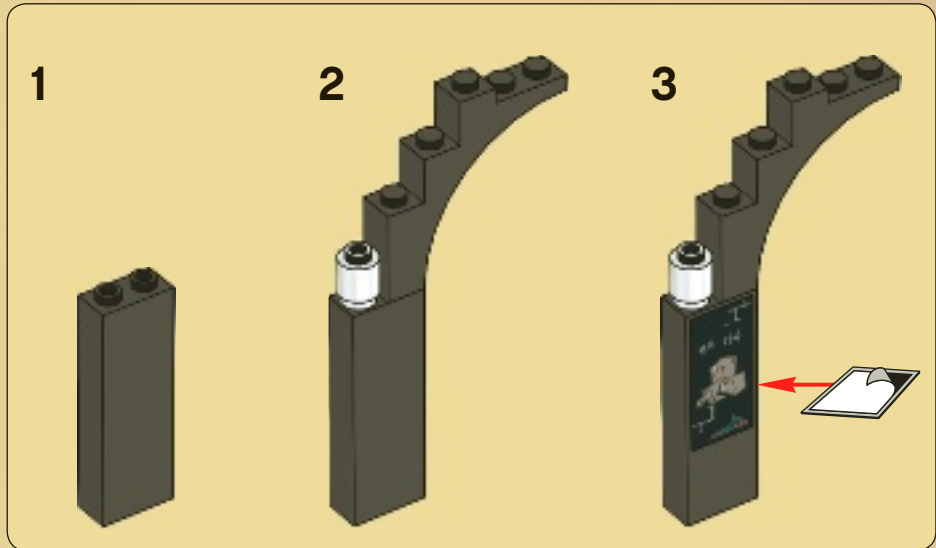

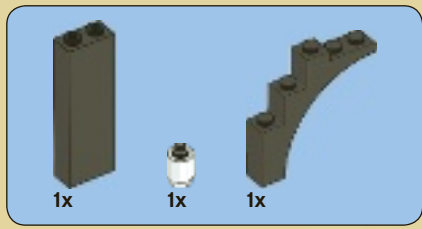

12

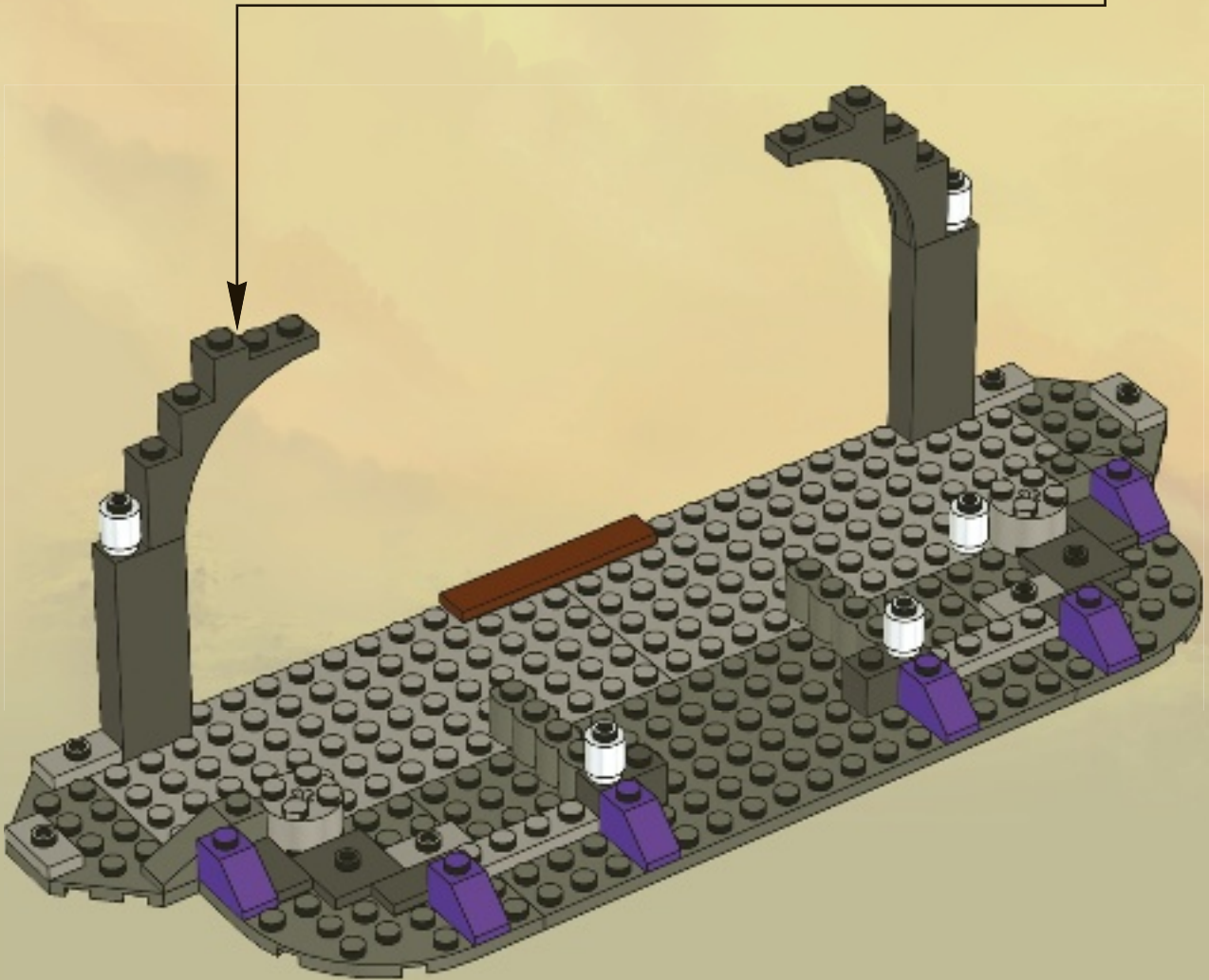
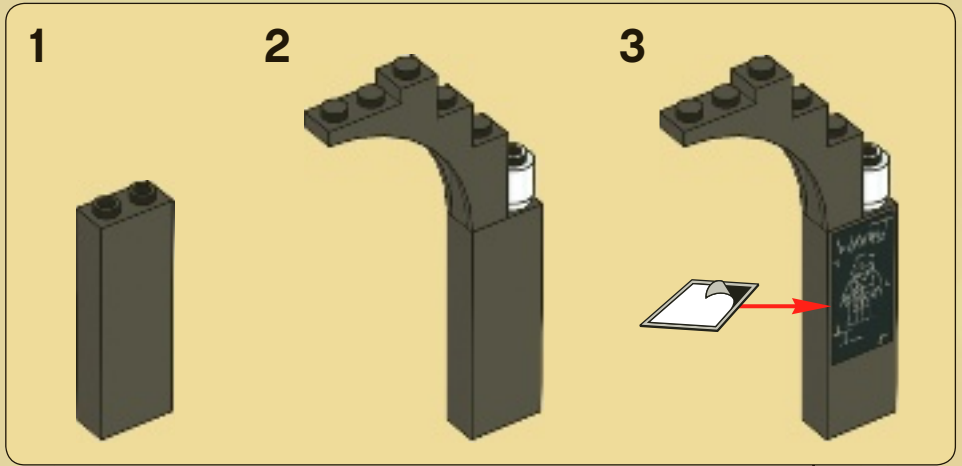

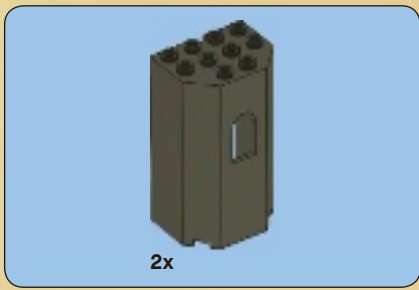

13

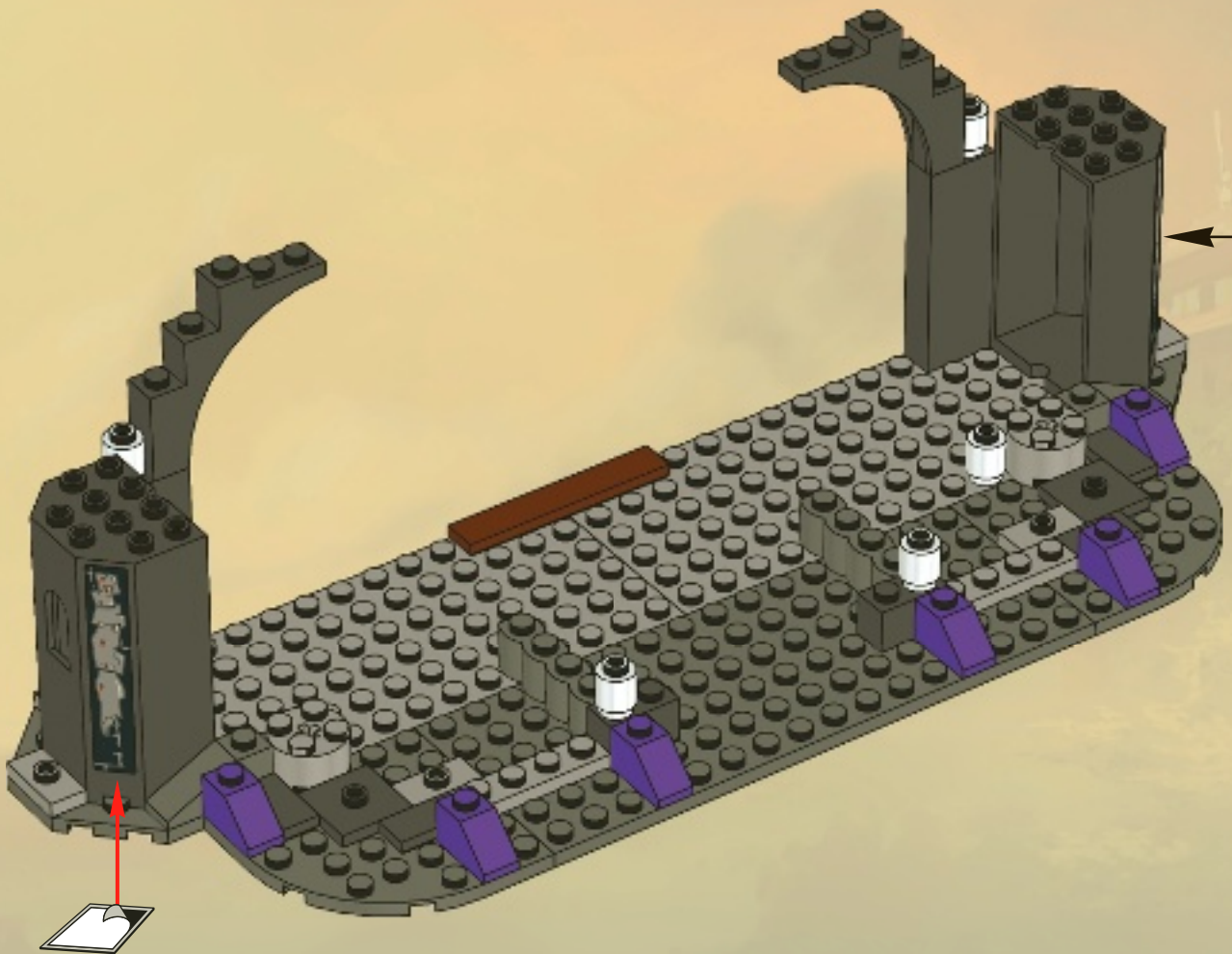

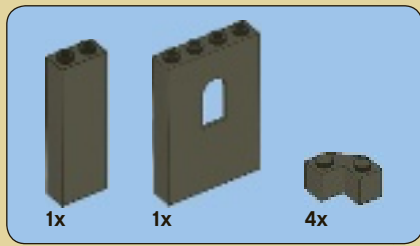

14

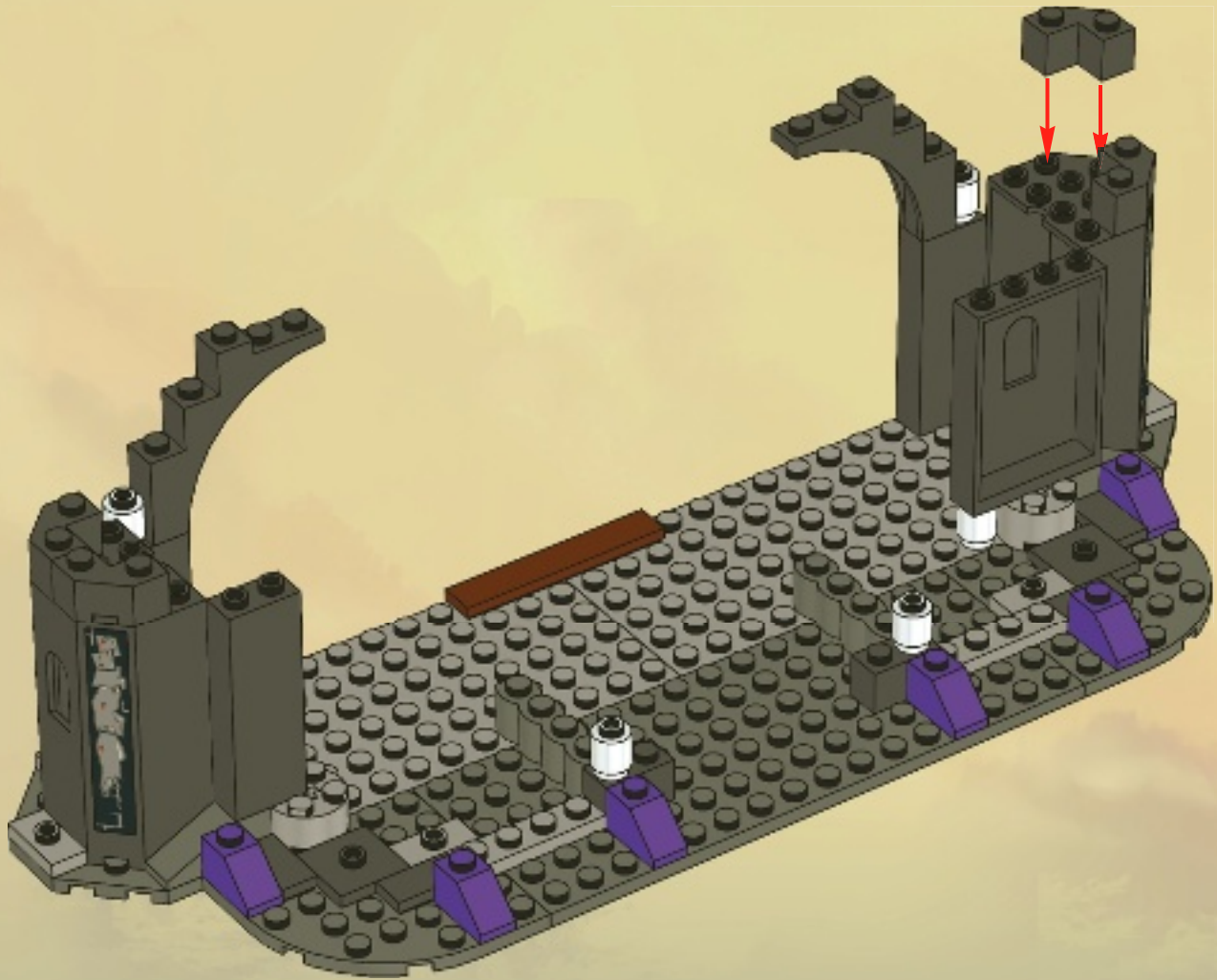

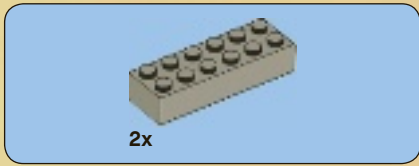

15

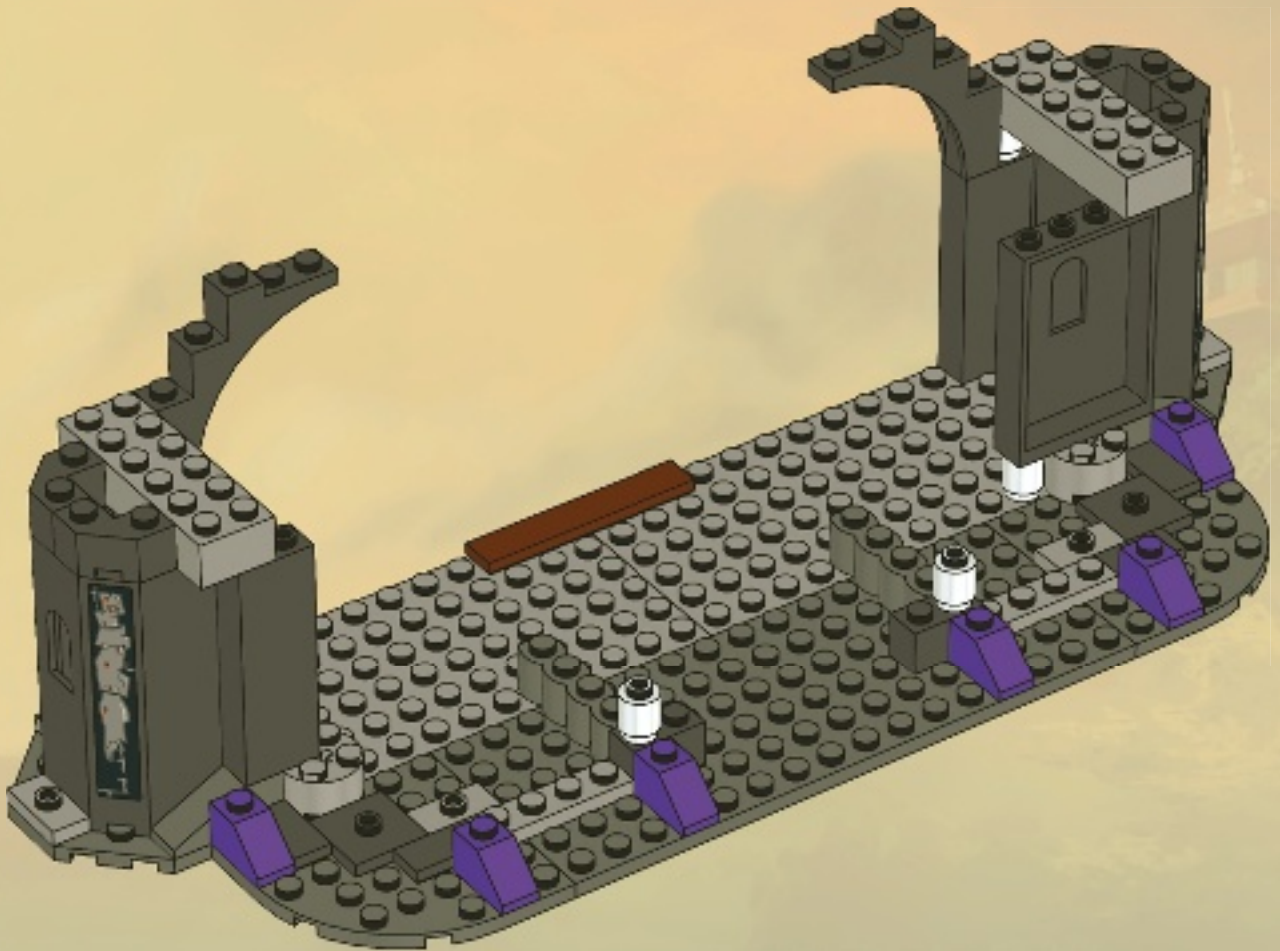



2x

16

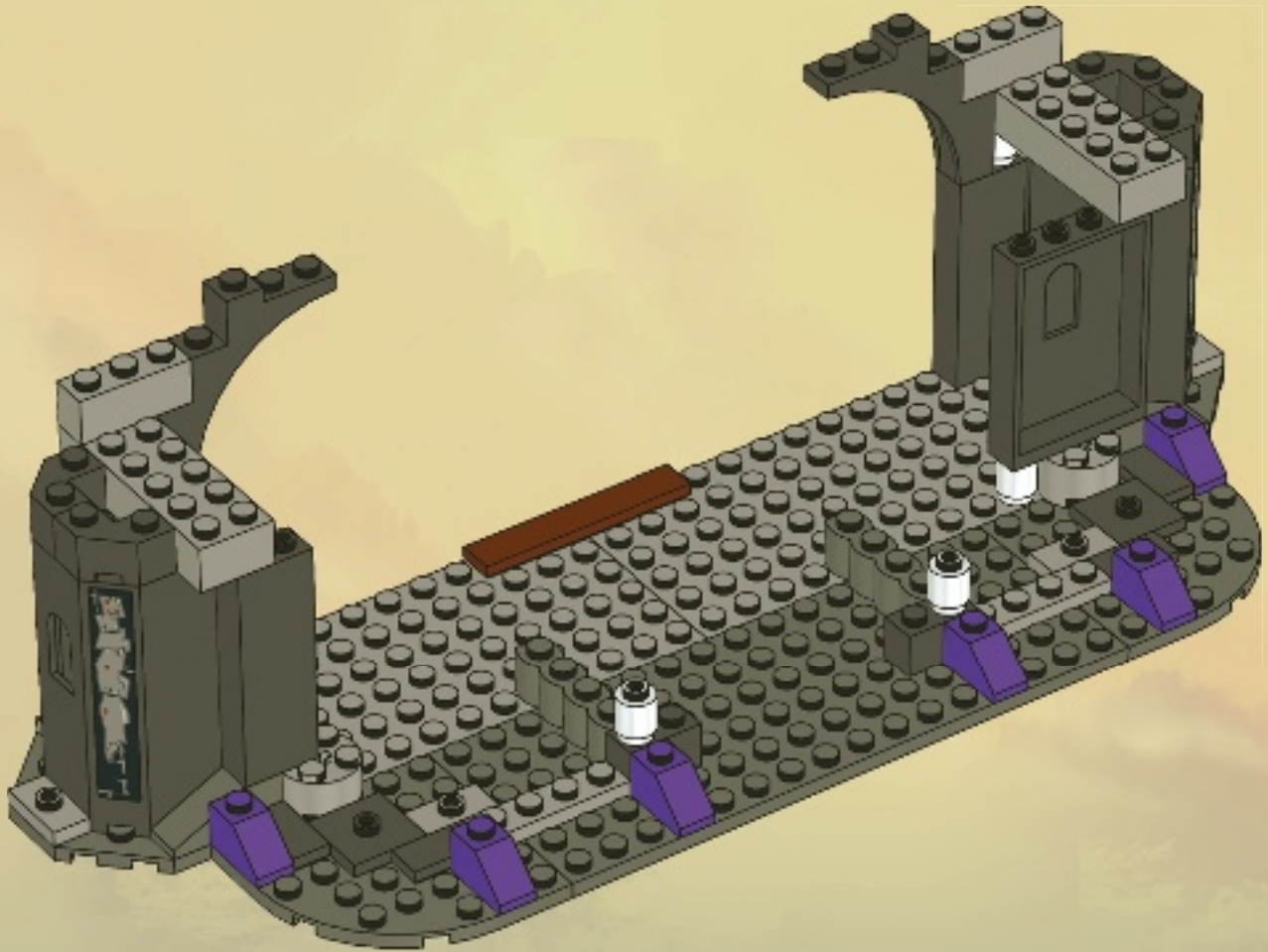

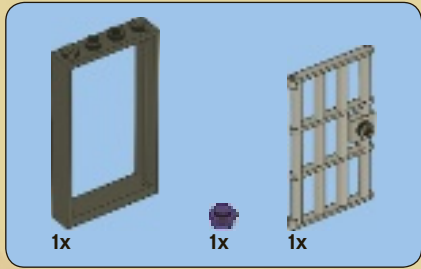
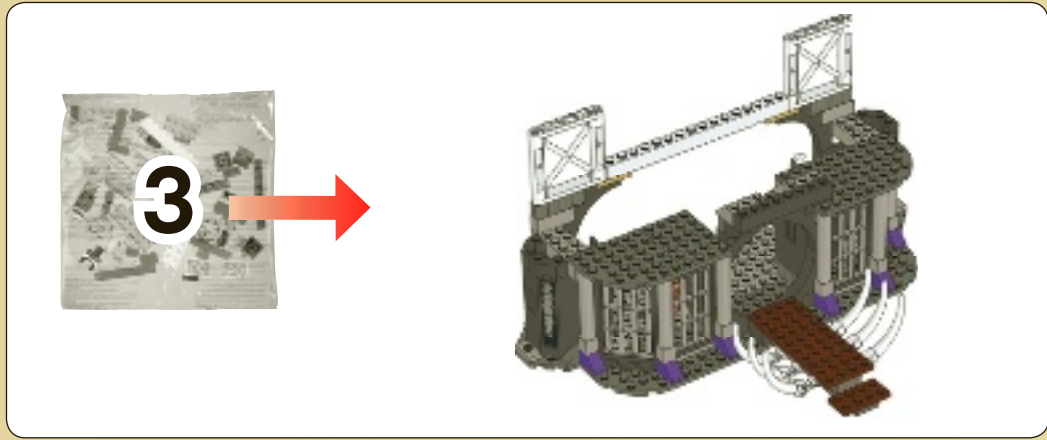

18

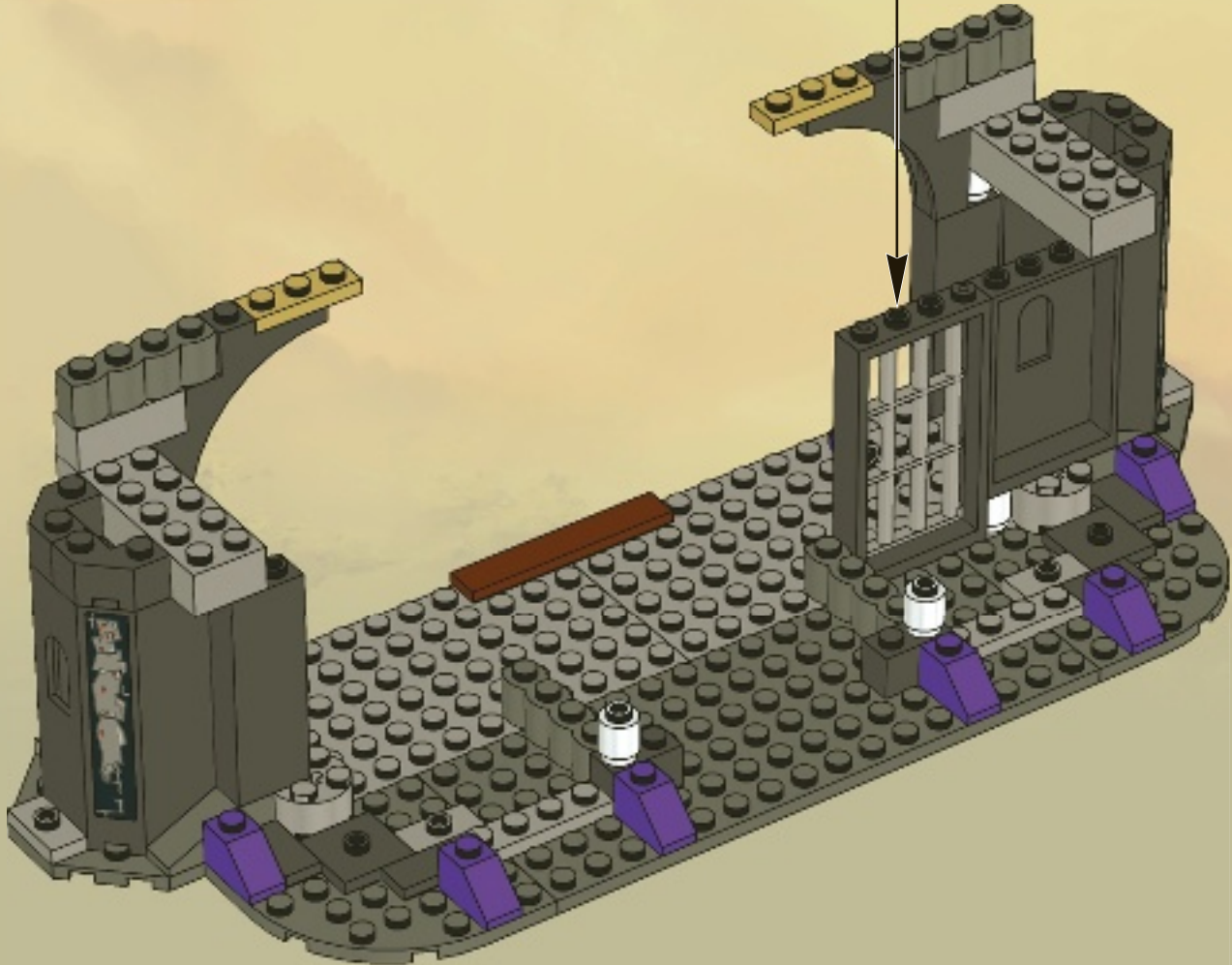
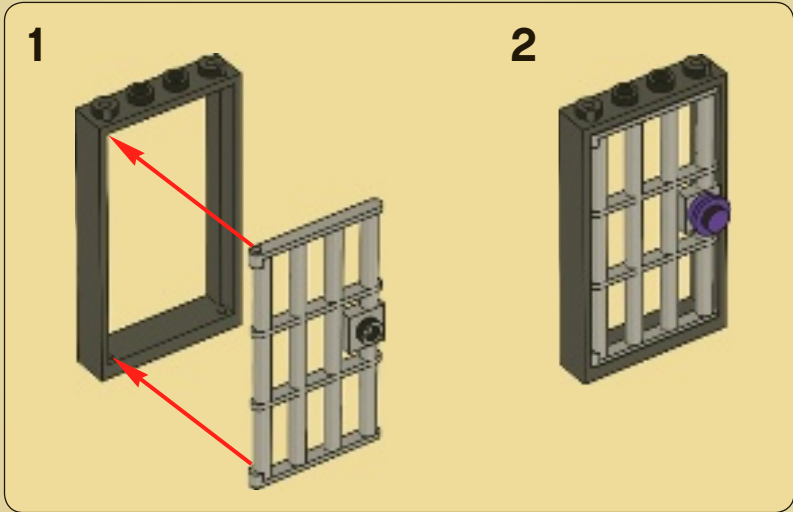

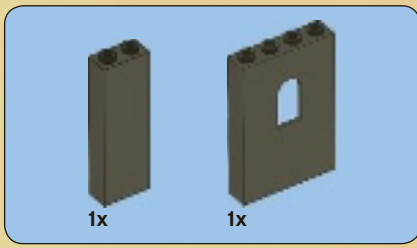

19

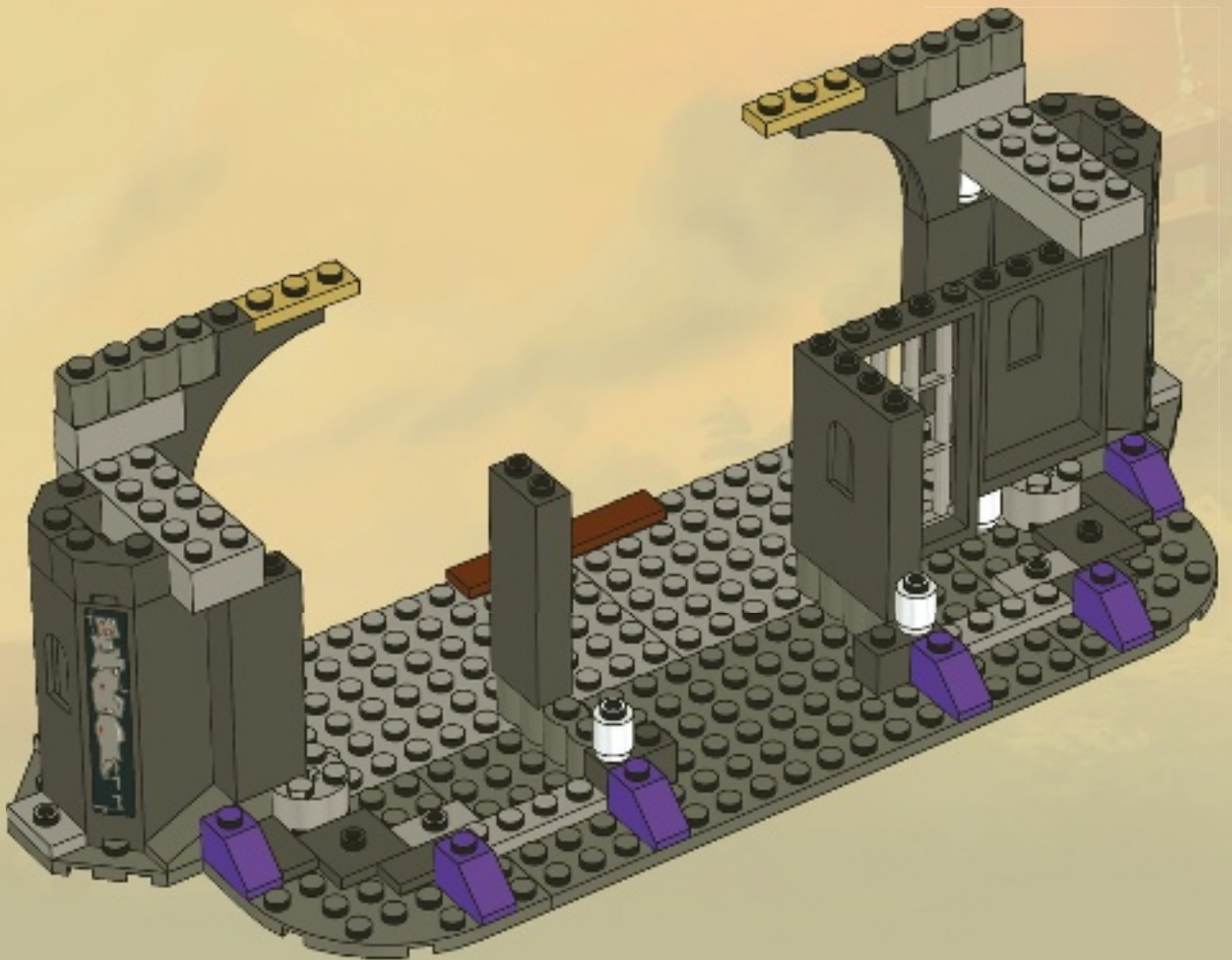

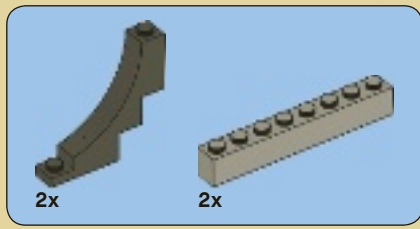

20

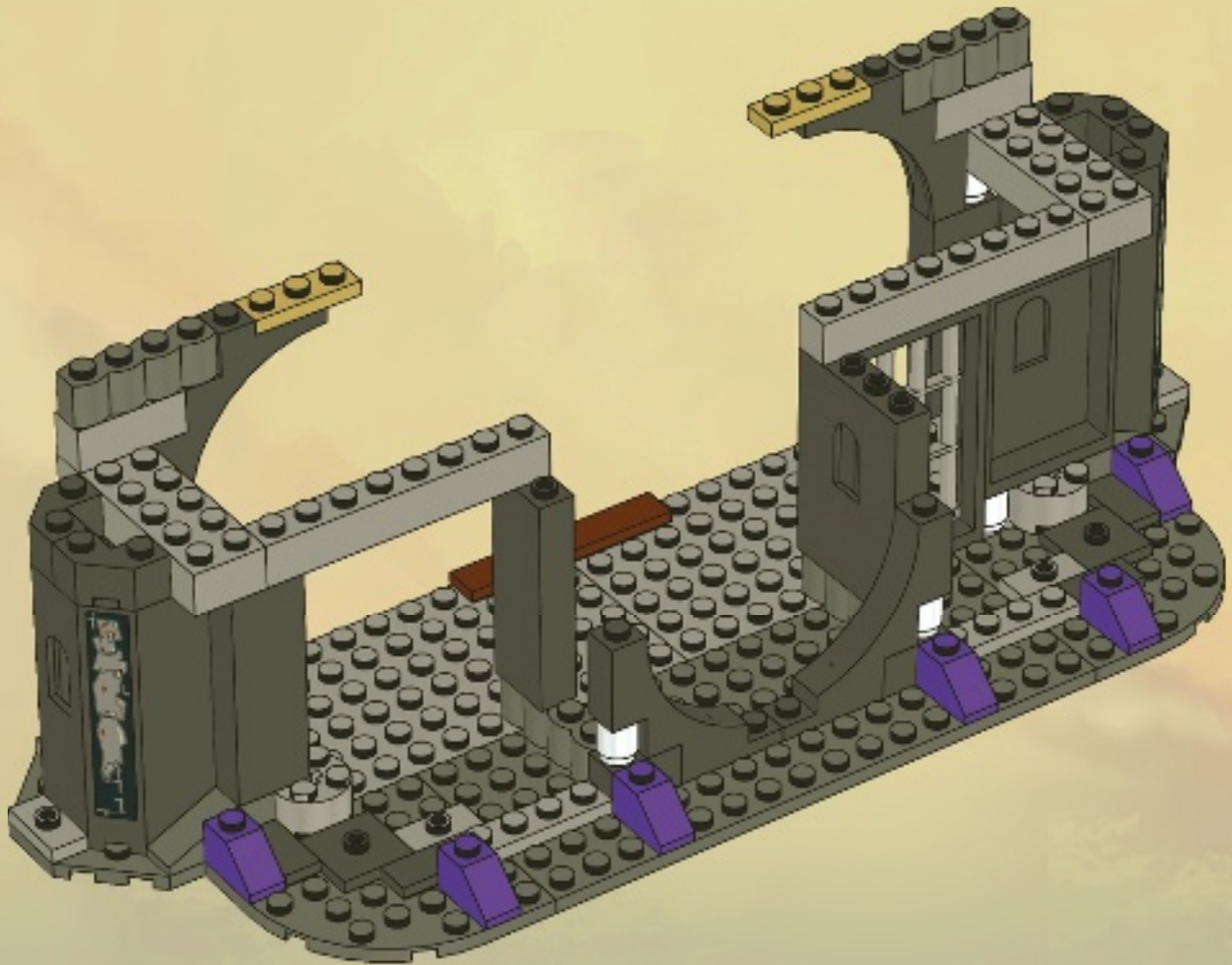

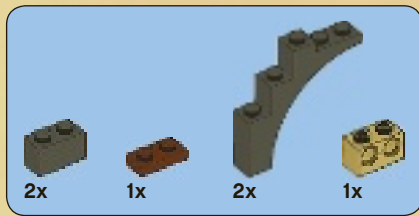

21

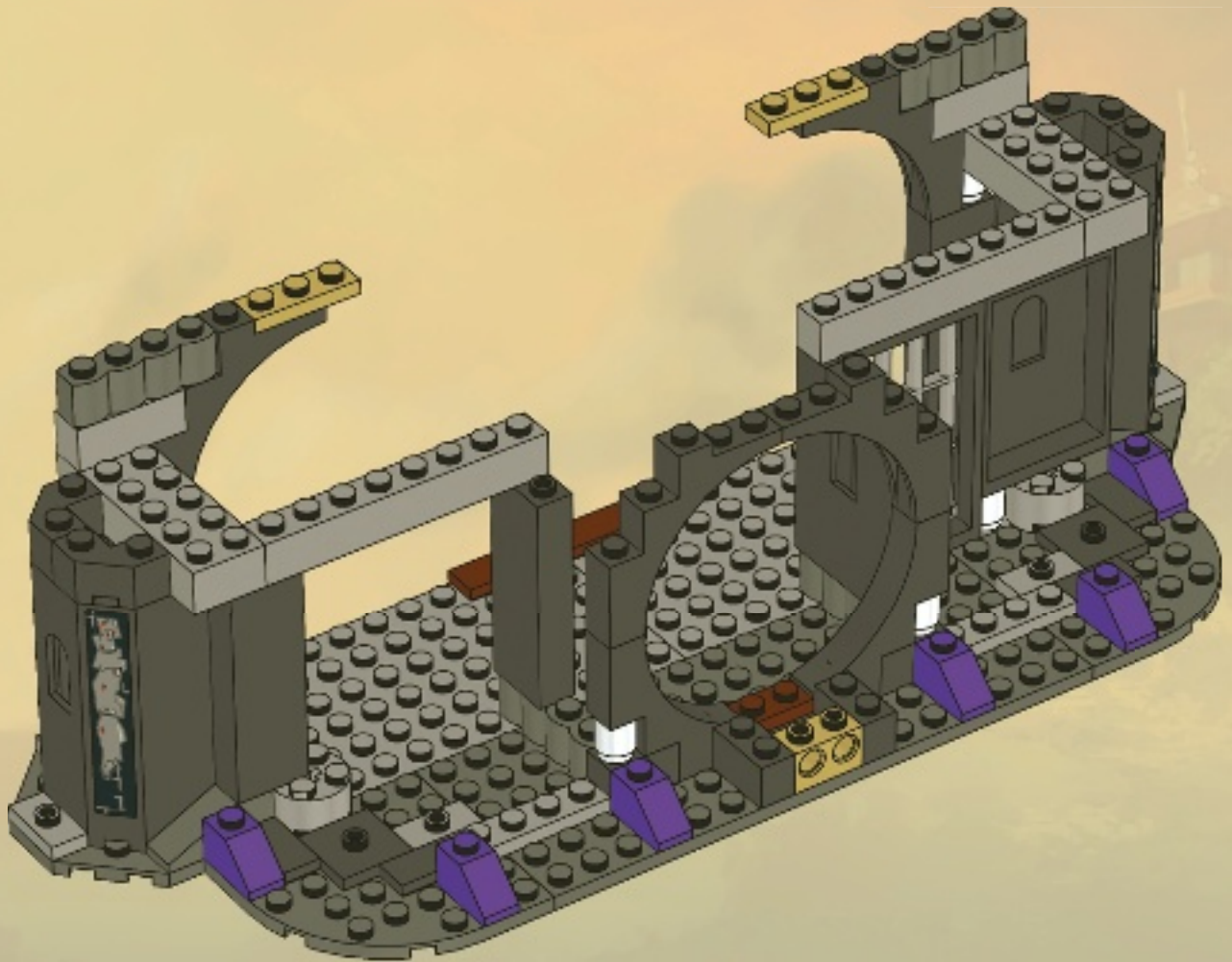

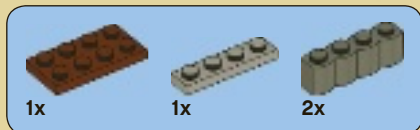

22



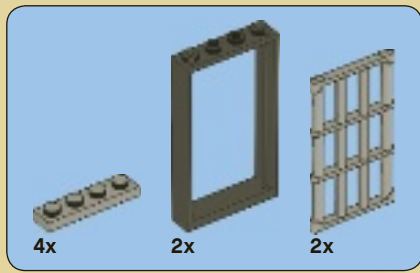

24

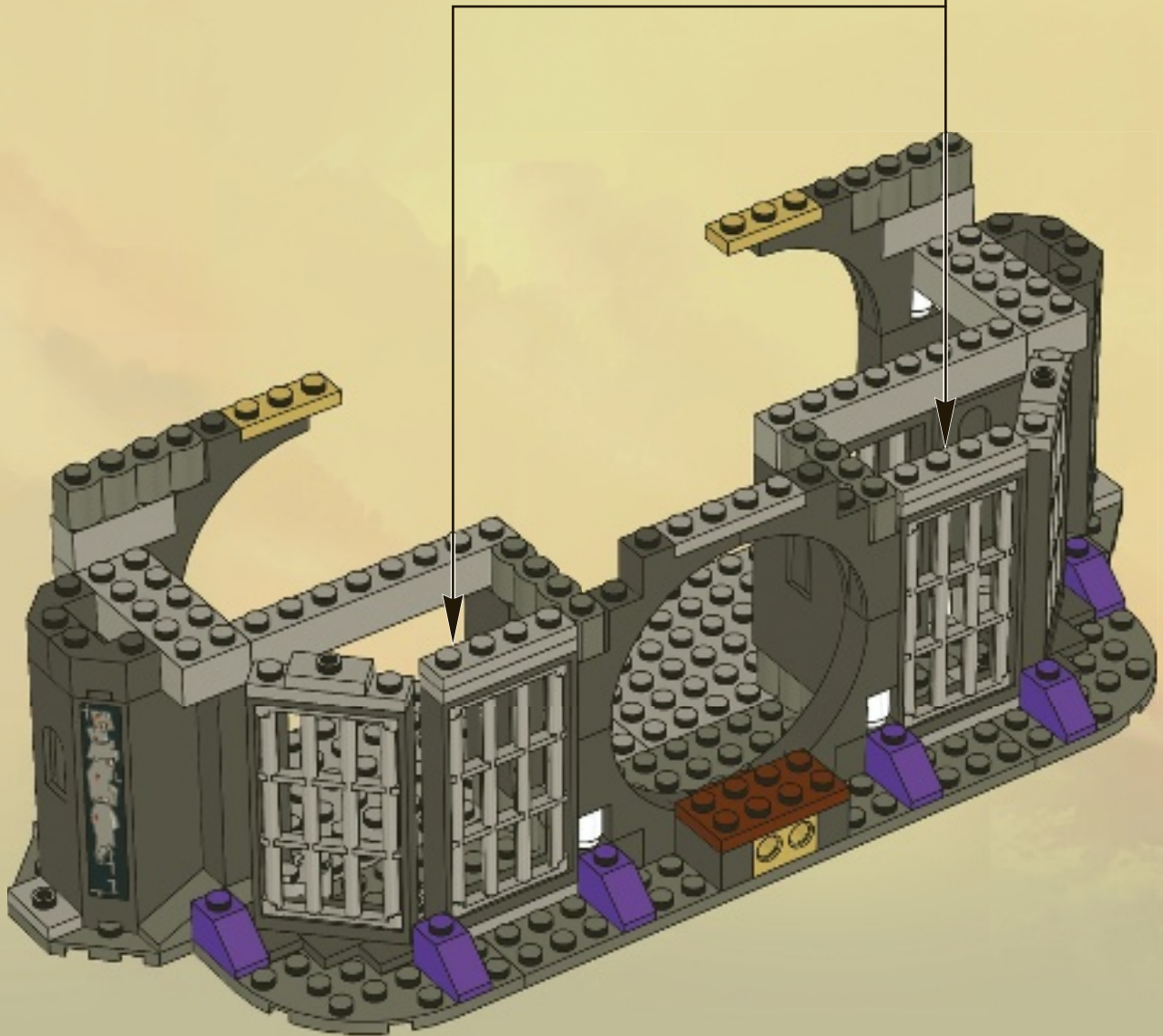
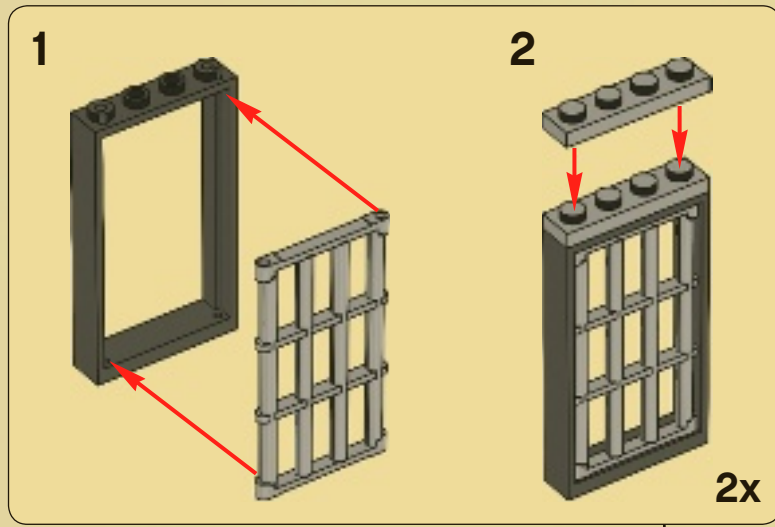

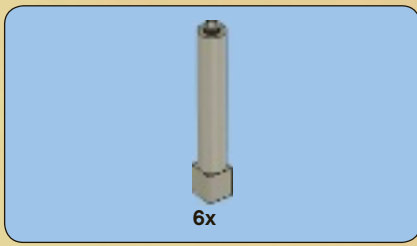

25

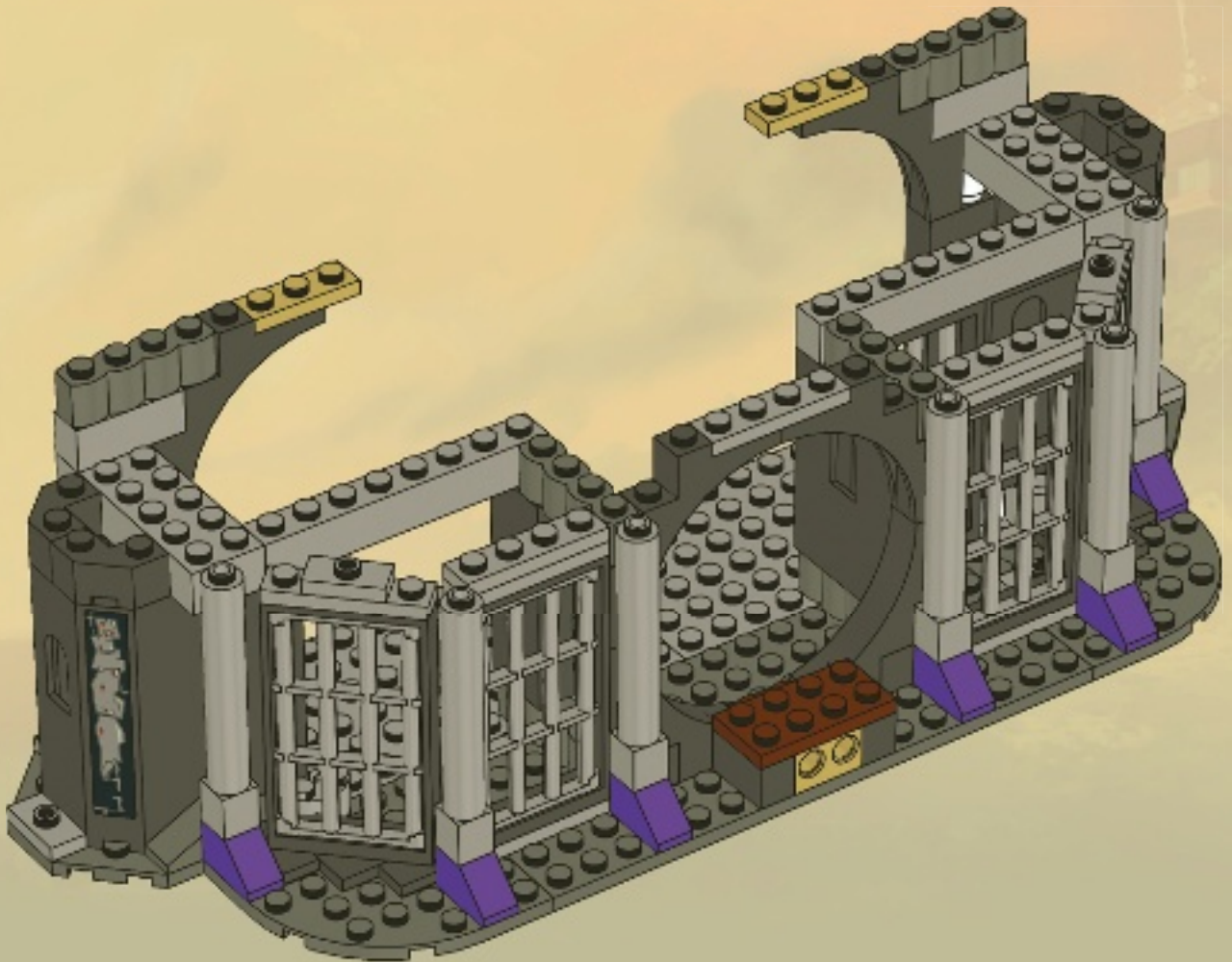



26

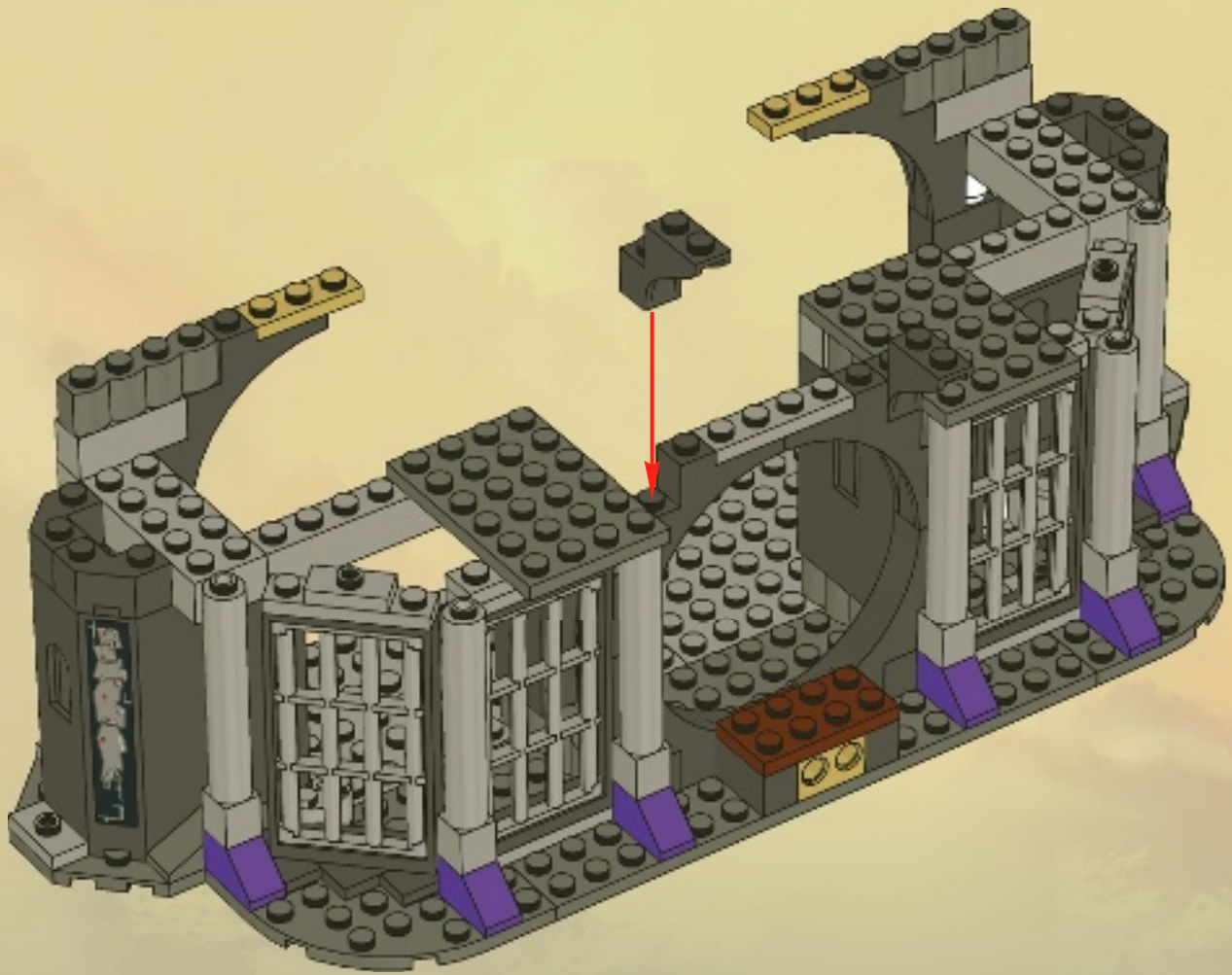

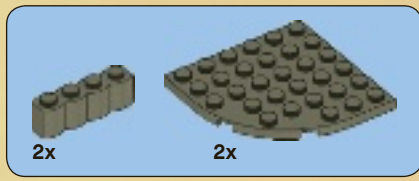

27

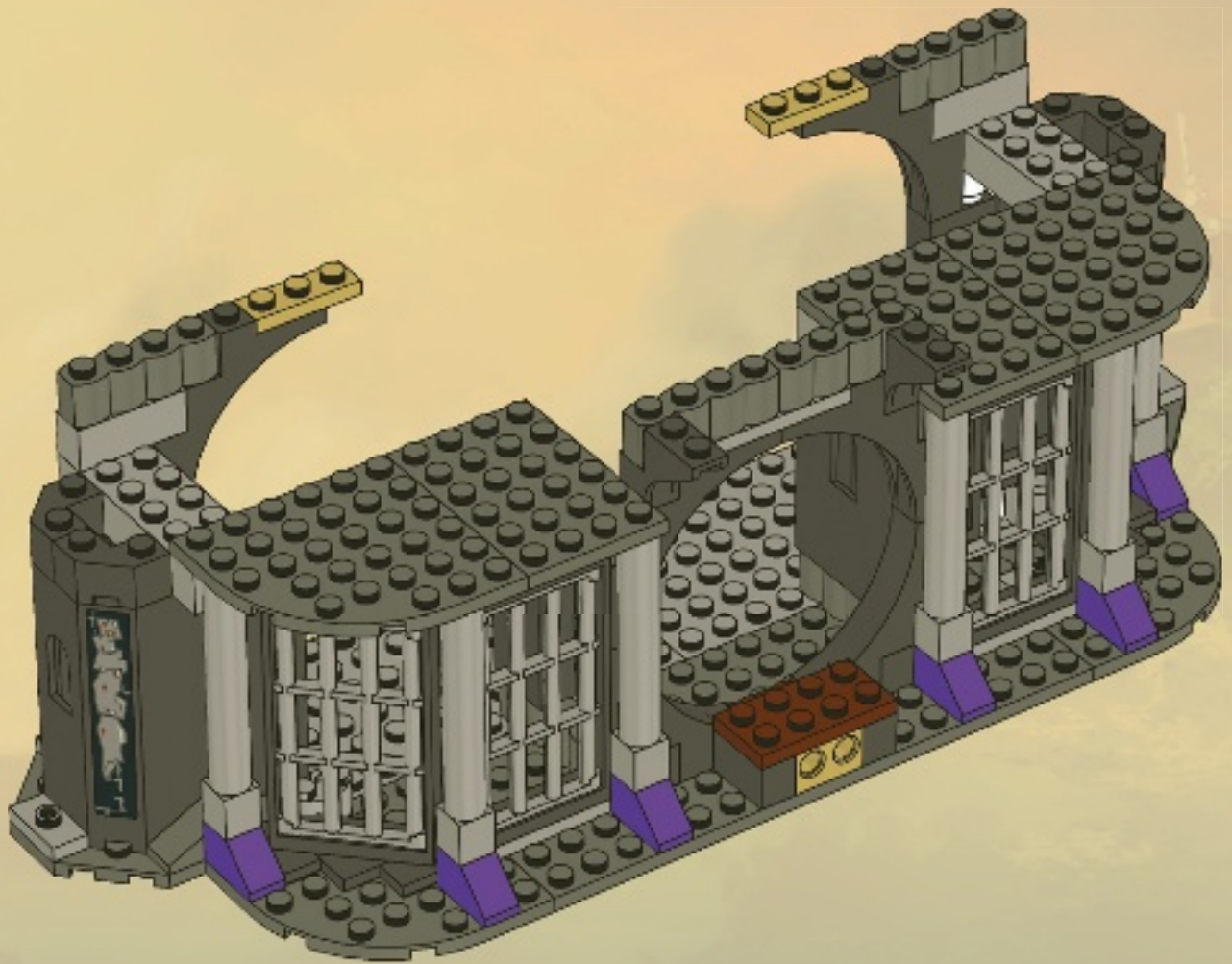

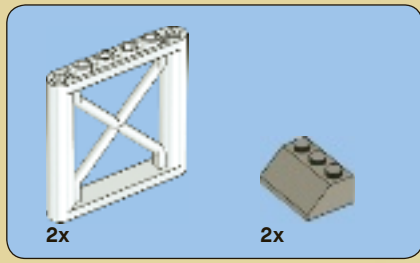

28

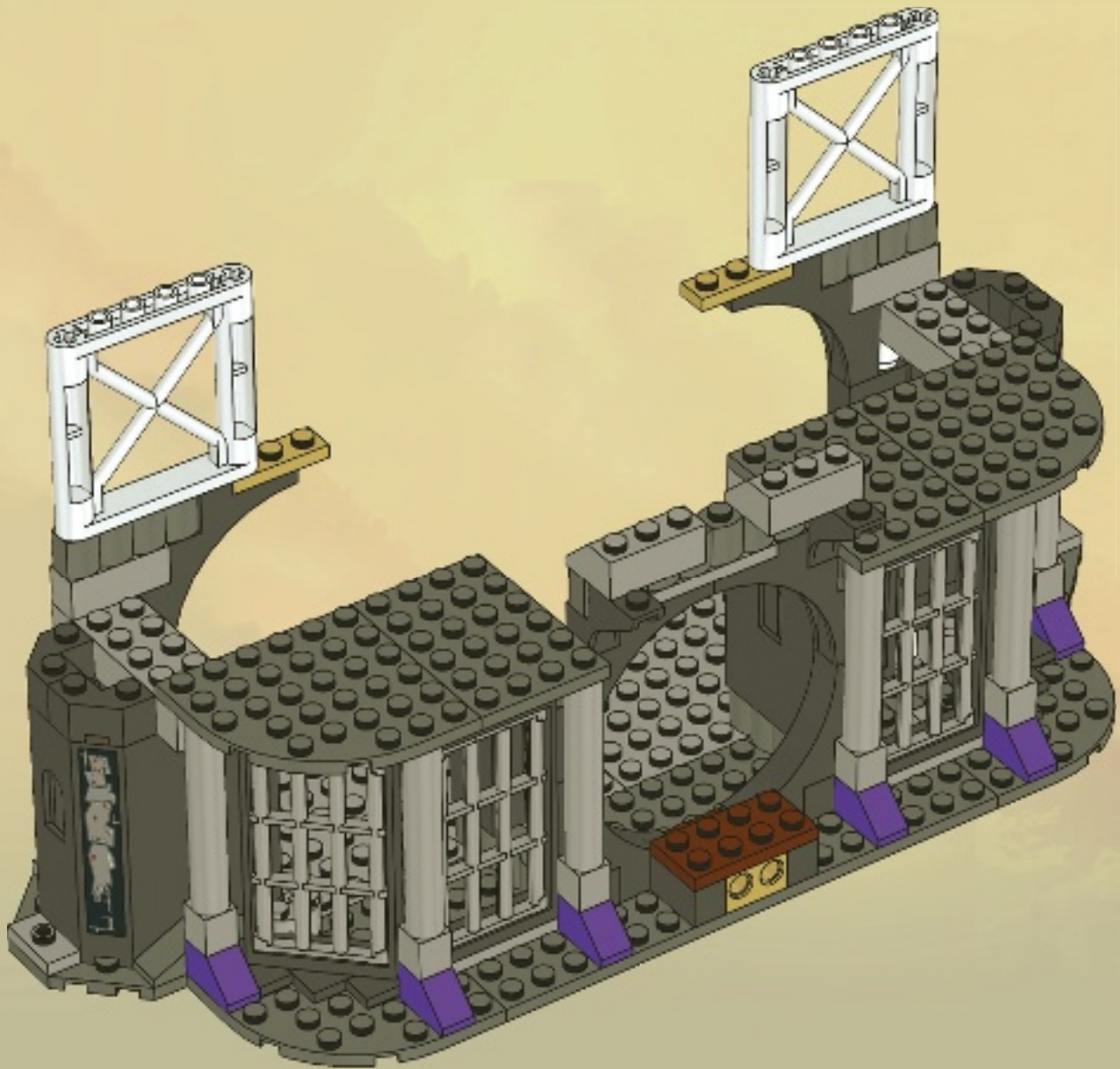

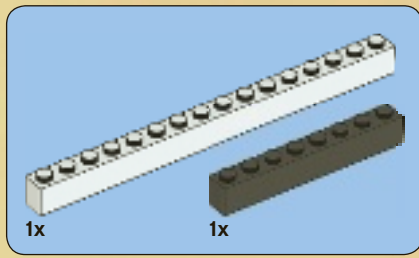

29

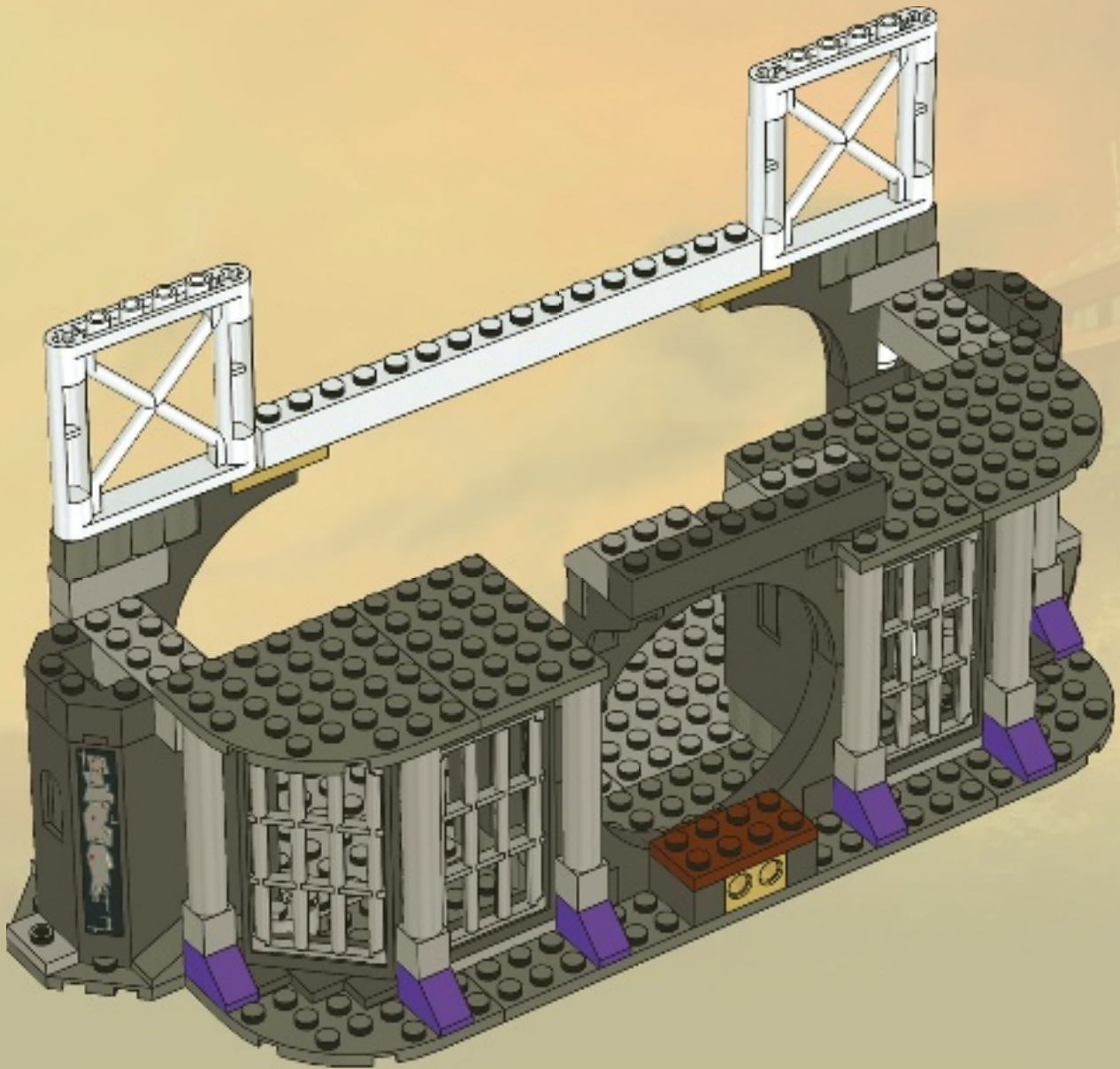

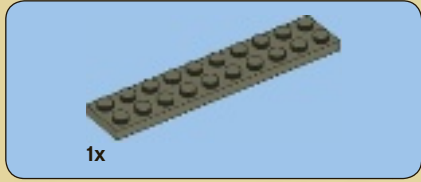

1x

1

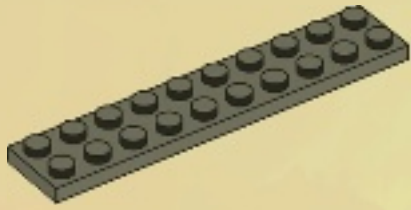

1x

2

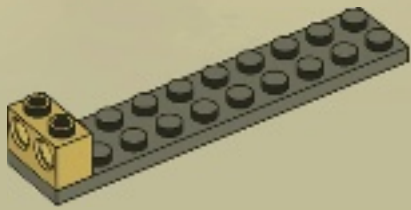

6x

3

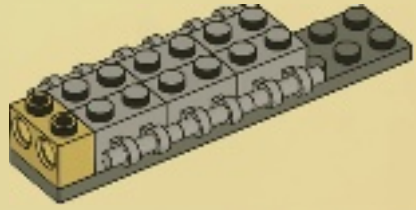

2x

1x

1x

4

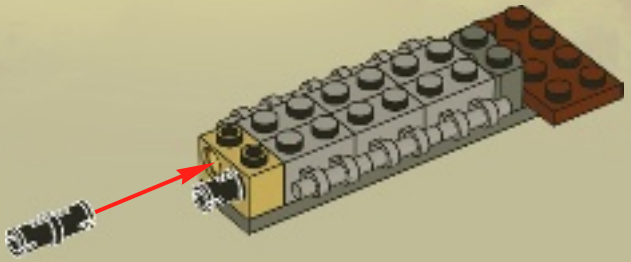



5

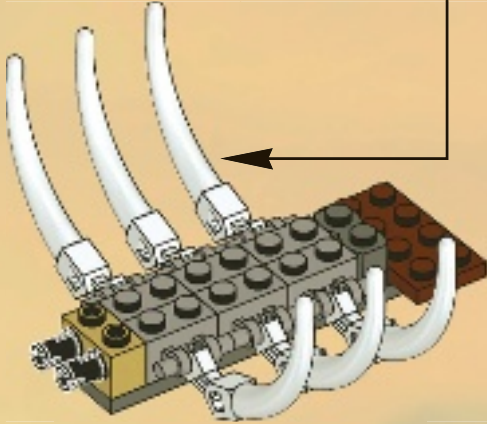
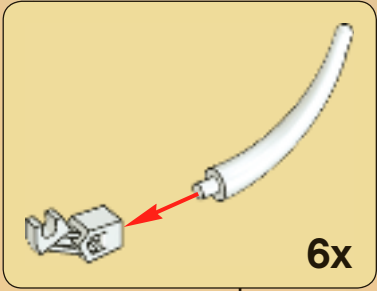

6

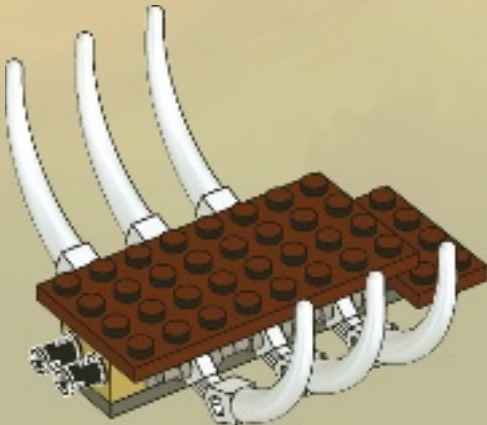

30

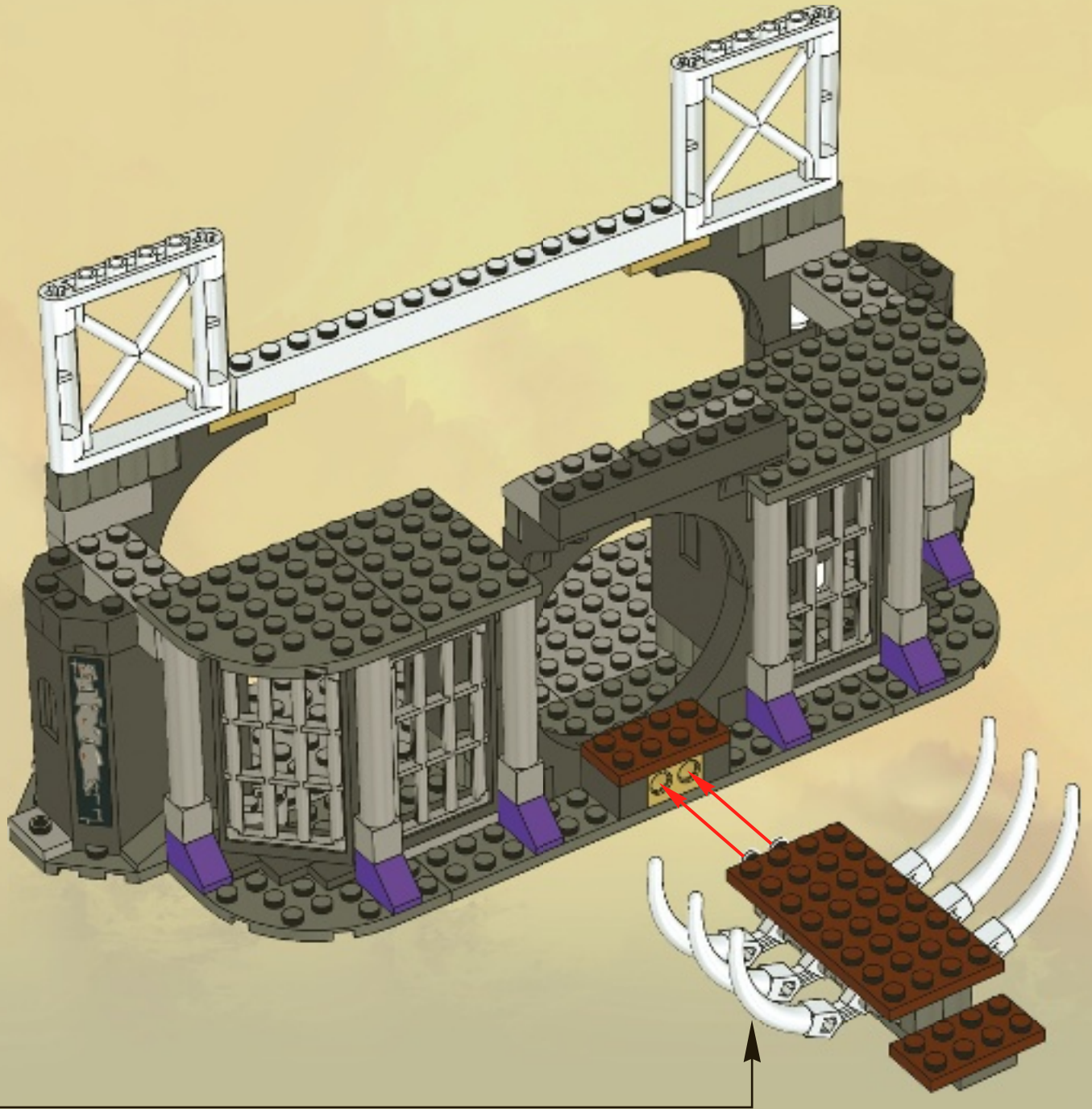

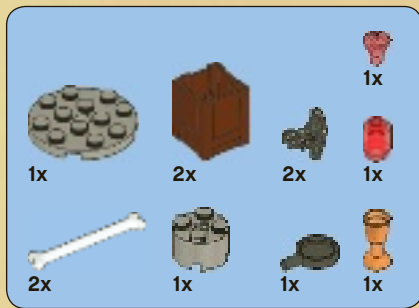

31

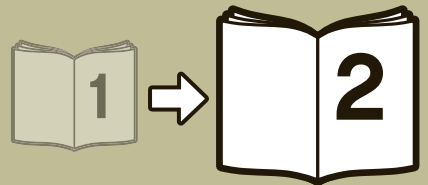
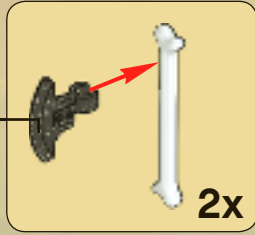
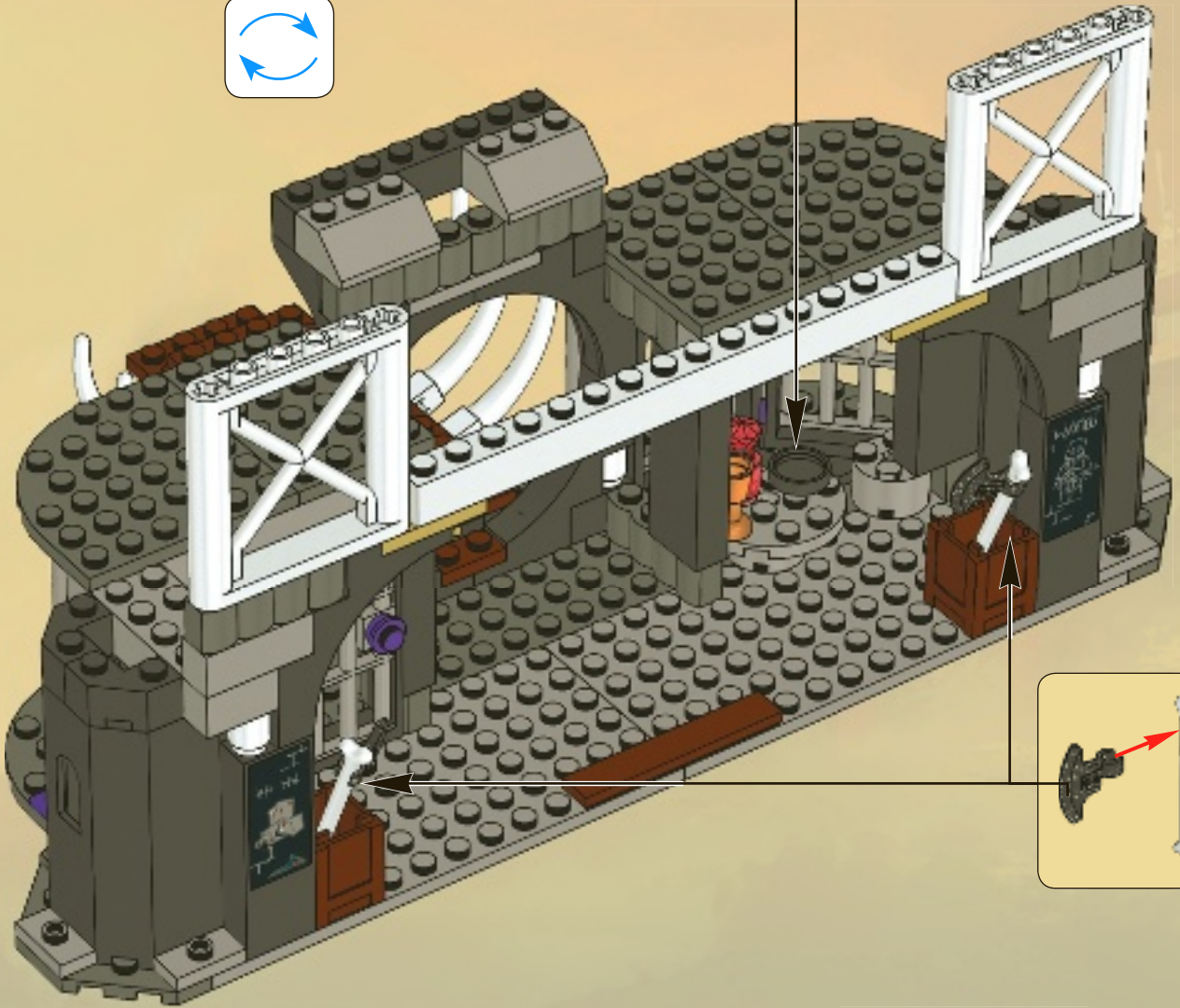



3x
300101

1x
246501

5x
4233486

2x
4542616

15x
306201

3x
614301

2x
4191825

7x
302301

4x
255501

2x
4632566

2x
4556152

2x
4222017

1x
4565324

1x
3003301

4x
370901

3x
4179874

3x
4179875

2x
486501

8x
4609295

6x
4602970

12x
4622904

1x
4612771

1x
4602984

1x
4612346

1x
4612347

4x
82359

1x
4611434

1x
4612985

1x
4611924

4x
4568387

2x
4600294

2x
4600307

12x
4566256

6x
4508454

6x
4603309

6x
4125554

2x
4523145

1x
4185177

2x
4121921

3x
4278275

1x
4631535

1x
4631529

1x
4612645

1x
4616366

1x
4641677

1x
4593768

1x
393821

1x
4615070

1x
4254606

1x
4227155

1x
4142865

1x
4513174

5x
4143005

1x
4611424

1x
4616378

4x
4239601

4x
300426

6x
245426

1x
300826

2x
4533771

16x
4584274

2x
4558957

3x
370126

2x
4143982

2x
609126

2x
4581280

4x
4519925

6x
4116854

4x
306926

1x
302026

2x
4550017

6x
379426

2x
4565323

5x
403226

5x
4535834

6x
4537058

4x
4271754

1x
4631568

1x
4616334

1x
4616311

1x
4526756

2x
4562148

1x
452826

1x
4114206

1x
4185272

4x
4121715

2x
4107081

1x
370526

2x
370726

1x
3006841

3x
4189801

4x
4497943

1x
4113954

2x
4548009

2x
4540865

1x
4514700

1x
4566927

2x
4225469

1x
4211150

4x
4211186

1x
4211204

1x
4211247

2x
4216945

1x
4211207

2x
4264669

2x
4520638

2x
4277751

4x
4211428

2x
4211795

2x
4211392

10x
4558953

6x
4211580



8x
4179576

3x
4211526

2x
4211773

2x
4211519

2x
4211353

11x
4211445

1x
4612621

1x
4211406

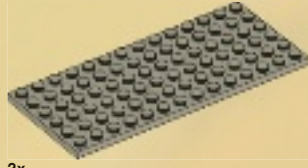

2x
4293831

1x
4211369

8x
4211451

3x
4515351

4x
4599496

4x
4215513

1x
4610149

1x
4211357

1x
4211628

1x
4539481



2x
4512049

4x
4520320

4x
4211550

4x
4211483

2x
4502595

2x
4211815

2x
4211805

6x
4211095

13x
4268139

4x
4210639

6x
4226221

2x
4211068

4x
4211045

6x
4261715

3x
4211052

3x
4211115

1x
4210678

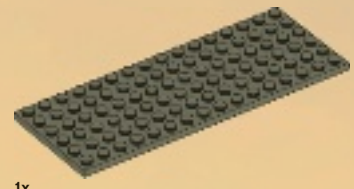

1x
4226358

1x
4211069

2x
4210967

2x
4210984

4x
4500517

2x
4289542



2x
4540178

6x
4225265

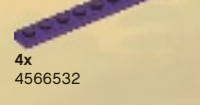

4x
4566532

2x
4566804

21x
4566522

2x
4579024

2x
4538126

1x
4600267

1x
4505990

3x
4600271

1x
4600519

1x
4611904

1x
4600501

2x
4273965

1x
4616331

1x
4612900

Customer Service
Kundenservice
Service Consommateurs
Servicio Al Consumidor

www.lego.com/service or dial



: 00800 5346 5555
: 1-800-422-5346



FREE! GRATIS! GRATUIT!



www.LEGOclub.com



LEGO Club Magazine



LEGO Club Email

www.LEGO.com

©2011 The LEGO Group, 4642940

VISIT THE WORLD'S BIGGEST LEGO SHOP!

www.LEGOshop.com

GO TO

www.LEGOclub.com

00800 5346 5555



1-866-534-6258 • 1-877-518-5346

US & Canada only

Canada seulement



* Freephone. Mobile charges may apply. * Numéro sans frais. Des frais peuvent s'appliquer avec les téléphones cellulaires. * Gebührenfrei. Kosten für Anrufe aus Mobilfunknetzen können abweichend. * Gratis telefonnummer vanaf vaste lijn. * Det er et gratis nummer, når du ringer fra fasttelefon. * Det är gratis, när du ringer från en fast telefon. * Numéro sans frais. Des frais peuvent s'appliquer avec les téléphones portables.

YES! I want to join the LEGO Club FREE! OUI! Je veux m'abonner au LEGO Club GRATUITEMENT! Ja! Ich möchte Mitglied im kostenlosen LEGO Club werden. Ja! Ik wil graag GRATIS lid worden van de LEGO Club. Ja! Jeg ønsker å melde meg inn i LEGO Club gratis! Ja! Jag vill gå med i LEGO Club GRATIS!

Registration form with fields for First name, Last name, Date of Birth, Street, City, Zip/Postcode, Email, etc.

Shipping information table with columns for Mail to, Per Post, and Stuur op naar, listing various countries and addresses.

- Fill in your email address and we will send you a membership confirmation and monthly email newsletters. If you do not wish to receive the newsletters please tick here. Remplis ton adresse e-mail et nous t'enverrons une confirmation d'adhésion ainsi que le bulletin e-mail mensuel. Si tu ne désires pas recevoir le bulletin, coche cette case. Vui je e-mailadres in en we sturen je een bevestiging van je lidmaatschap en maandelijkse e-mail nieuwsbrieven. Als je geen e-mail wilt ontvangen, kruis dan dit vakje aan.
Ich möchte per E-Mail den monatlichen LEGO Club Newsletter erhalten. Wünscht du an di skal sende en liten lisen til barnet ditt for å bekrefte medlemskapet, ber vi deg kryssse av i feltet, samt oppgi e-postadressen som hilsenen skal sendes til. Om du vill att vi ska skicka en bekräftelse på ditt barns medlemskap, ber vi dig sätta ett kryss i rutan och skriva den e-post adress som bekräftelsen ska skickas till.

The English language version of the magazine can only be mailed to addresses in the US, Canada, the UK, and Republic of Ireland. Club membership is valid for two years and includes free copies of the LEGO Club Magazine and e-mail newsletters. In the US and Canada please allow up to 6 weeks for delivery of your first magazine. In the UK and Republic of Ireland please allow six to 14 weeks for delivery of your first magazine. By signing this form you consent the LEGO Club to use your child's data for LEGO mailings. The data will only be used for LEGO mailings and will not be sold, rented or otherwise disclosed to any company outside the LEGO Company except for disclosure to companies acting as our agents to help us provide services requested by the child. This coupon is valid for one free membership per person, group or organization. Photocopied coupons are accepted. La version française du magazine peut être postée uniquement au Canada. L'abonnement est valide pour 2 ans et inclut des exemplaires gratuits du Magazine LEGO, Aux E.-U. et au Canada, allouer 6 semaines pour la livraison initiale. En remplissant ce formulaire, vous consentez à ce que LEGO utilise les informations de votre enfant pour des envois postaux de LEGO. L'information sera utilisée uniquement pour des envois postaux par LEGO et ne sera en aucun cas, vendue, louée, échangée ou divulguée à d'autres compagnies autres que la compagnie LEGO, à l'exception des compagnies affiliées qui nous procurent des services auxquels l'enfant en a fait la demande. Formulaires photocopiés acceptés. Mit der folgenden Unterschrift erkläre ich, für mein Kind den Beitritt als Mitglied zum kostenlosen LEGO Club, der von der LEGO GmbH, D-85627 Garstbrunn, betrieben wird. Die Mitgliedschaft beinhaltet die Zusendung des LEGO Club Magazine und kann beiderseits jederzeit beendet werden. Mit der Mitgliedschaft im LEGO Club sind keinerlei Verpflichtungen verbunden. Das deutschsprachige LEGO Club Magazin wird nur an Adressen in Deutschland, Österreich und der Schweiz versendet. Eine Anmeldebestätigung kann nur per E-Mail geschickt werden. Das Magazin erscheint fünfmal jährlich. Daher kann die Zustellung des ersten Heftes bis zu drei Monate dauern. Die Mitgliedschaft ist beidseitig jederzeit kündbar, ohne dass Ihnen Kosten entstehen. Sie können der werblichen Nutzung Ihrer Daten jederzeit widersprechen, Kündigung und Widerspruch können Sie telefonisch erklären (00800 / 5346 5555, Anruf gebührenfrei. Kosten für Anrufe aus dem Mobilfunknetz können abweichen) oder an die LEGO GmbH senden. Het Nederlandse LEGO Club Magazine kan alleen worden gestuurd naar adressen in Nederland. Het lidmaatschap is 2 jaar geldig en geeft recht op toezending van het gratis LEGO Club Magazine en LEGO Club e-mails. Het eerste magazine zal binnen 12 tot 14 weken toegestuurd worden. Het lidmaatschap kan op ieder moment opgezegd worden en kan na 2 jaar gratis worden verlengd, tenzij LEGO met deze activiteit stopt. Uw gegevens worden uitsluitend gebruikt voor mailings van LEGO en zullen niet worden verkocht, verhuurd of op welke wijze dan ook verstrekt aan derden buiten de LEGO Group, uitgezonderd de organisaties die namens ons optreden om de informatie te sturen waarvoor toestemming is verleend. Dit coupon wordt alleen gebruikt voor één gratis lidmaatschap per persoon, groep of organisatie. In Nederland wordt het LEGO Club Magazine vijf keer per jaar uitgegeven. Daarom kan de levering van het eerste tijdschrift tot drie maanden in beslag nemen. Het lidmaatschap is beidzijds te allen tijde opzegbaar, zonder dat u hiervoor kosten hoeft te betalen. U kunt de commerciële verwerking van uw gegevens te allen tijde weigeren, intrekking en bezwaar kunt u telefonisch verklaren (00800 / 5346 5555, aanroep is gratis. Kosten voor oproepen vanuit het mobiele netwerk kunnen afwijken) of naar de LEGO GmbH, D-85627 Garstbrunn, worden verzonden. Den norske utgaven av magasinet sendes kun til adresser i Norge. Medlemskap i klubben gjelder 12 år og inkluderer gratisutgaver av LEGO Club Magazine. Påregnet minimum oppsett seks uker leveringstid for første magasin. Ved å undertegne dette skjemaet, gir du ditt samtykke til at LEGO Club kan bruke opplysningene om barnet ditt i LEGO forsendelser. Dataene vil utelukkende bli brukt i LEGO forsendelser og vil ikke bli solgt, utleide eller på annen måte gitt tilgjengelig for selskaper utenfor LEGO gruppen, unntatt selskaper som er våre agenter og som hjelper oss å tilby tjenestene barnet etterspør. Dette skjemaet gjelder for ett gratis medlemskap per person, gruppe eller organisasjon. Den svenske versionen av tidningen kan endast skickas till adresser i Sverige. Club-medlemskapet är giltigt i 2 år och inkluderar gratis exemplar av LEGO Club Magazine. Vänligen räknat med minimum 6 veckor för leverans av din första tidning. Genom att skicka in det här formuläret godkänner du att LEGO Club använder barnets uppgifter för LEGO utskick. Uppgifterna kommer bara att användas för LEGO utskick och kommer inte att säljas, hyras ut eller vidarebefordras till något företag som inte tillhör LEGO Gruppen, med undantag av företag som agerar som våra ombud för att tillhandahålla tjänster som barnet har begärt. Den här kupongen gäller för ett gratis medlemskap per person, grupp eller organisation. I Sverige används informationen om ditt barns medlemskap endast för att skicka ut LEGO Club Magazine. Informationen kommer endast att användas för LEGO Club utskick och kommer inte att säljas, hyras ut eller vidarebefordras till något företag som inte tillhör LEGO Gruppen, med undantag av företag som agerar som våra ombud för att tillhandahålla tjänster som barnet har begärt. Den här kupongen gäller för ett gratis medlemskap per person, grupp eller organisation. En complément ce bulletin d'adhésion, vous acceptez que LEGO Club utilise les données relatives à votre enfant pour l'envoi de courriers concernant LEGO. Ces données seront uniquement utilisées pour l'envoi d'information concernant LEGO et ne seront ni vendues, ni louées, ni utilisées par d'autres sociétés que le groupe LEGO, à l'exception des sociétés agissant pour le compte de LEGO en tant que sous-traitant de services divers. L'abonnement au LEGO Club est valable pour une période de 2 ans. Il inclut l'envoi par courrier du magazine LEGO Club et par email des newsletters. Un délai de 6 à 14 semaines est à prévoir pour la réception de votre premier magazine. Ce bulletin d'adhésion gratuit est valable pour l'inscription d'une seule personne. Les photocopies sont acceptées. ATTENTION! Le bulletin d'adhésion doit être rempli et signé par un parent ou un tuteur.

Parent's signature / Signature d'un parent ou d'un tuteur / Unterschrift Erziehungsberechtigter / Handtekening ouders / Foreldres/foresattes underskrift / Förälders /förmyndares underskrift

Date Datum Date