

1

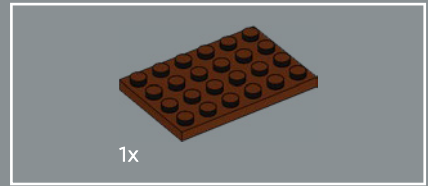

2

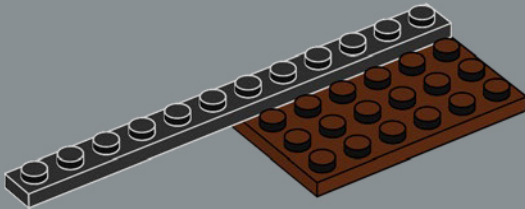

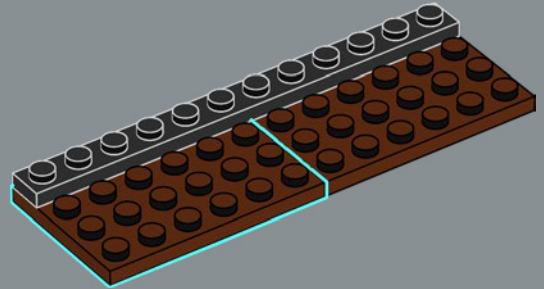

3

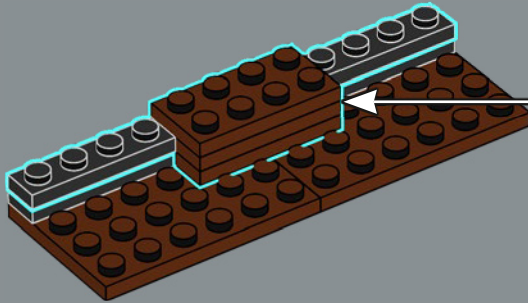
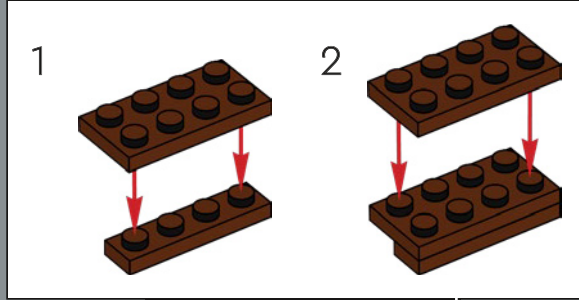

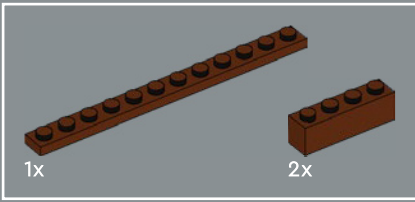

4

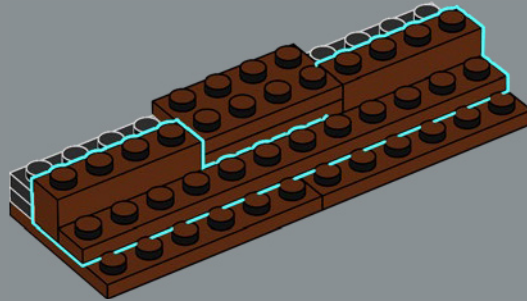
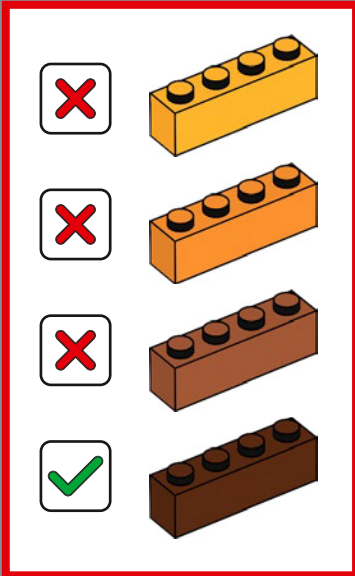



2x



4x

5

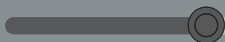
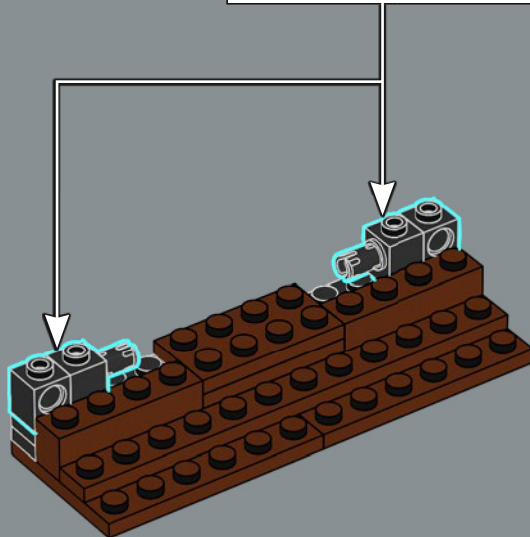
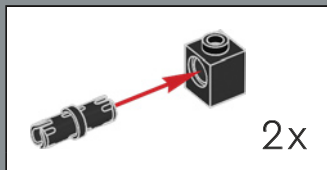

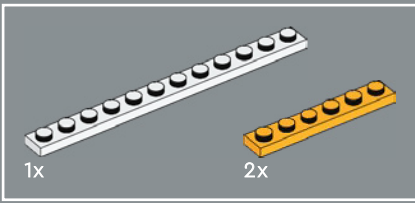

6

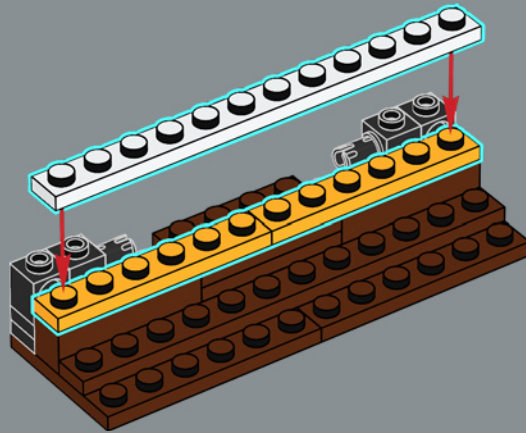
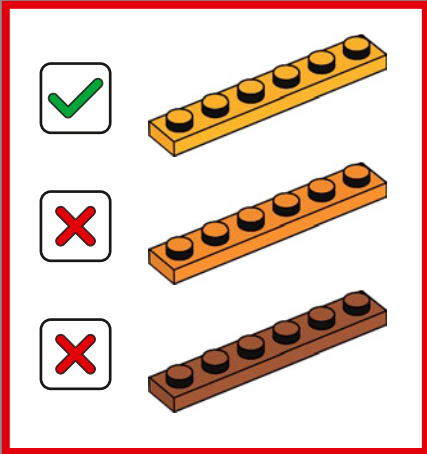

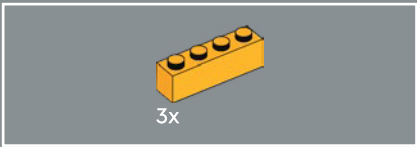

7

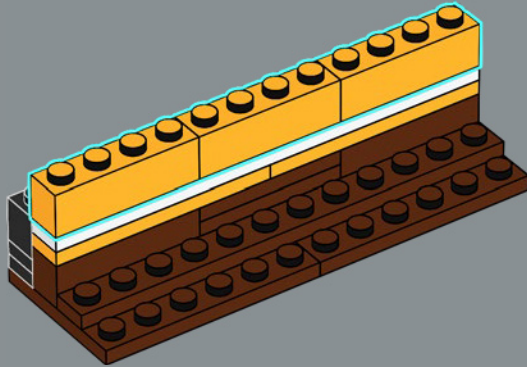
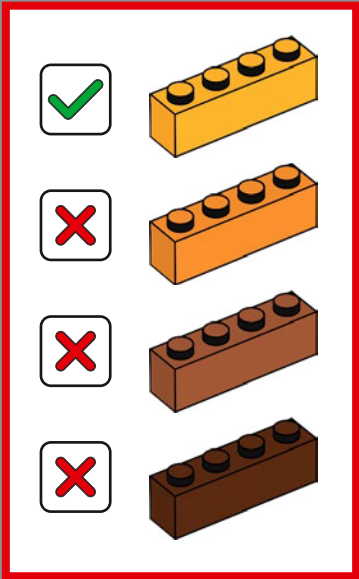



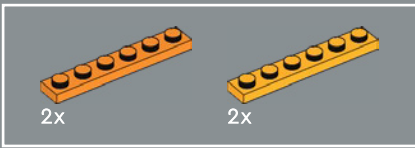

8

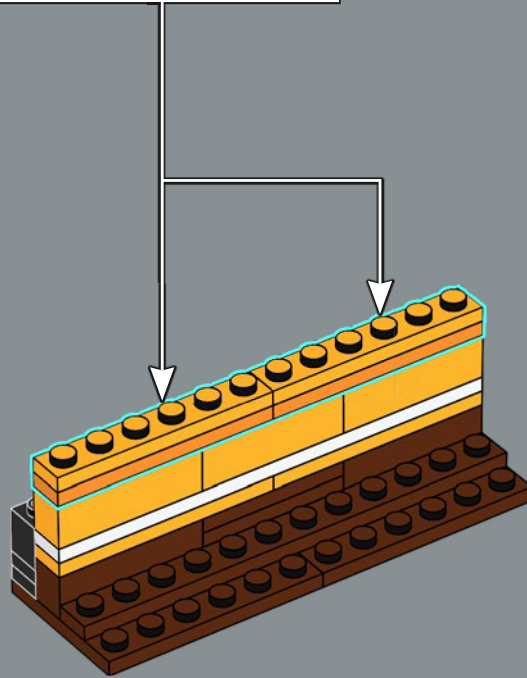
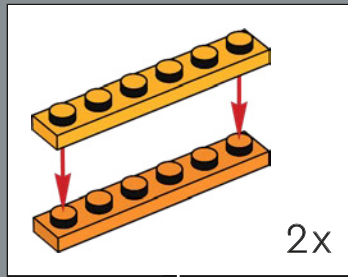
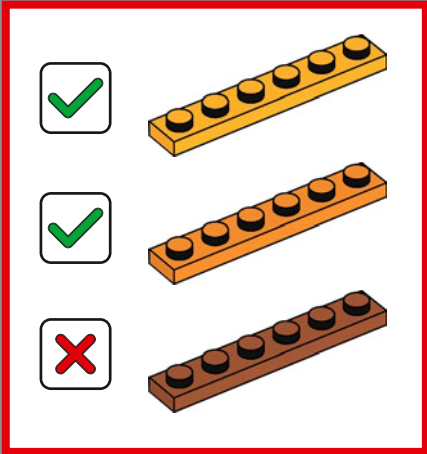

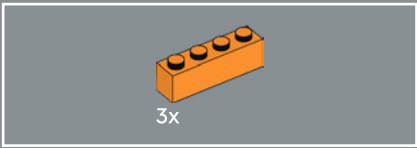

9

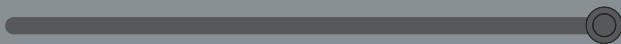
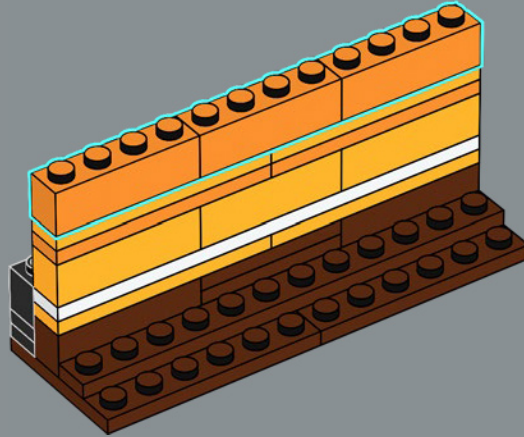
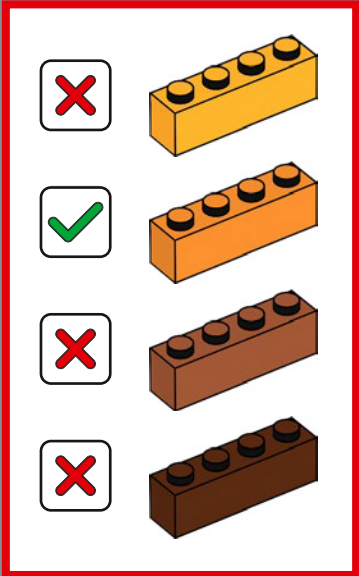

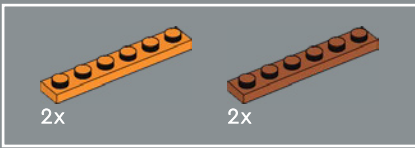

10

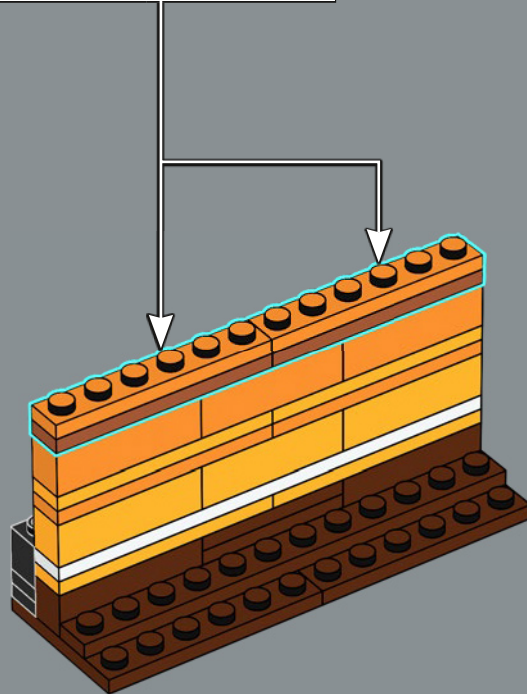
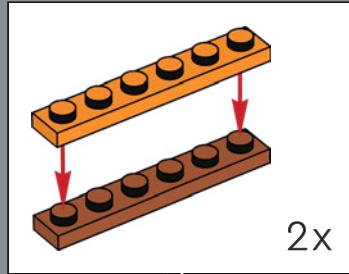
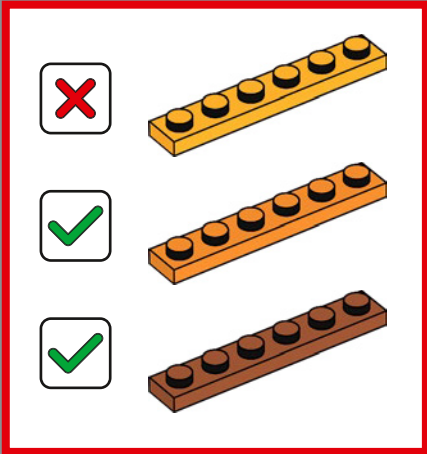

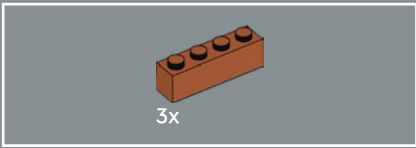

11

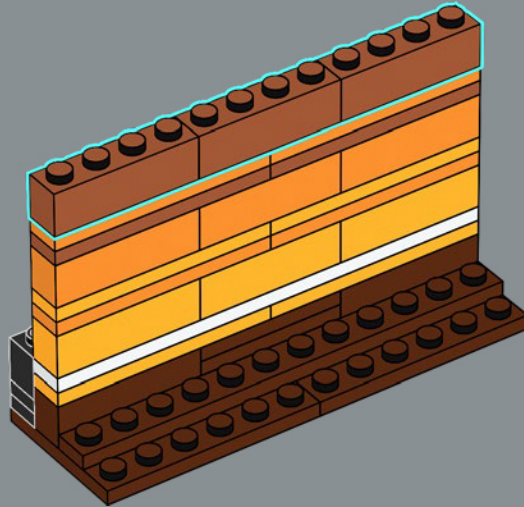
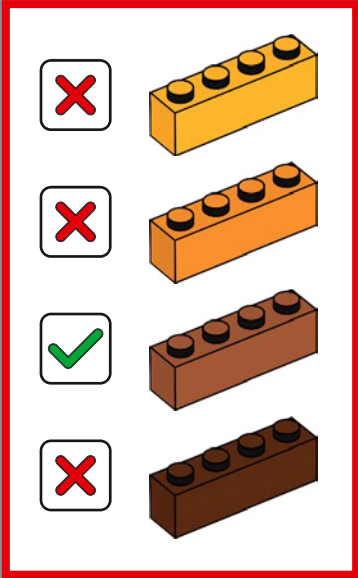

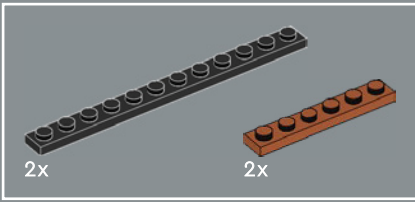

12

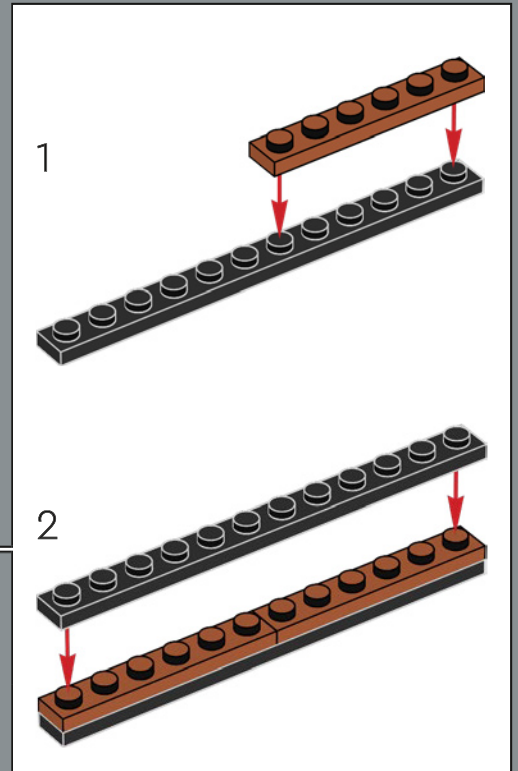
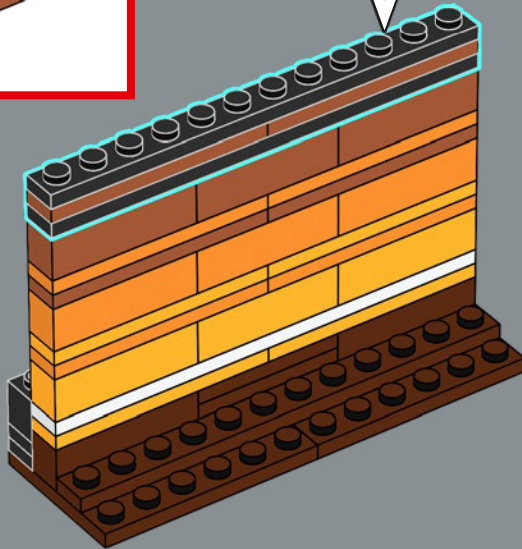
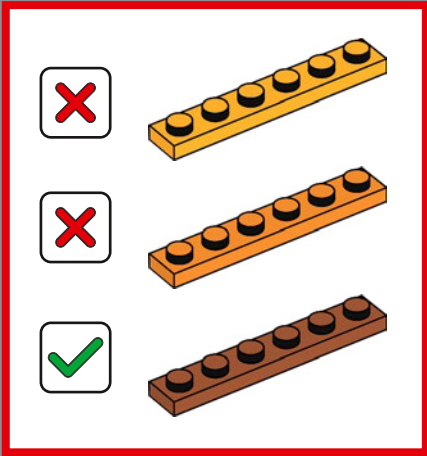

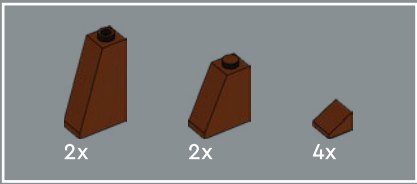

13

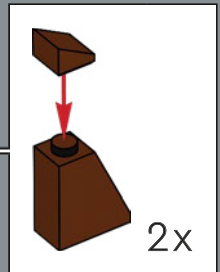
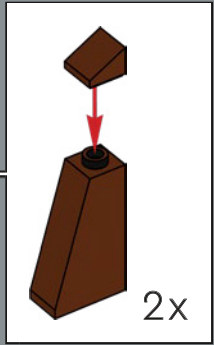
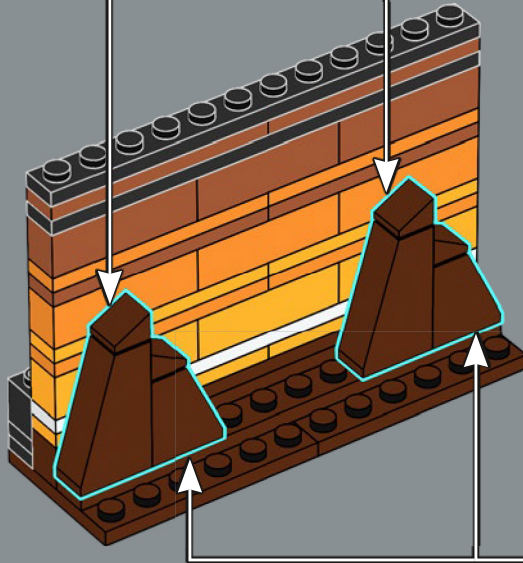

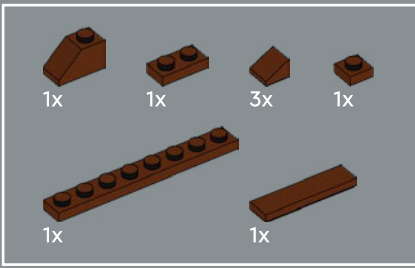

14

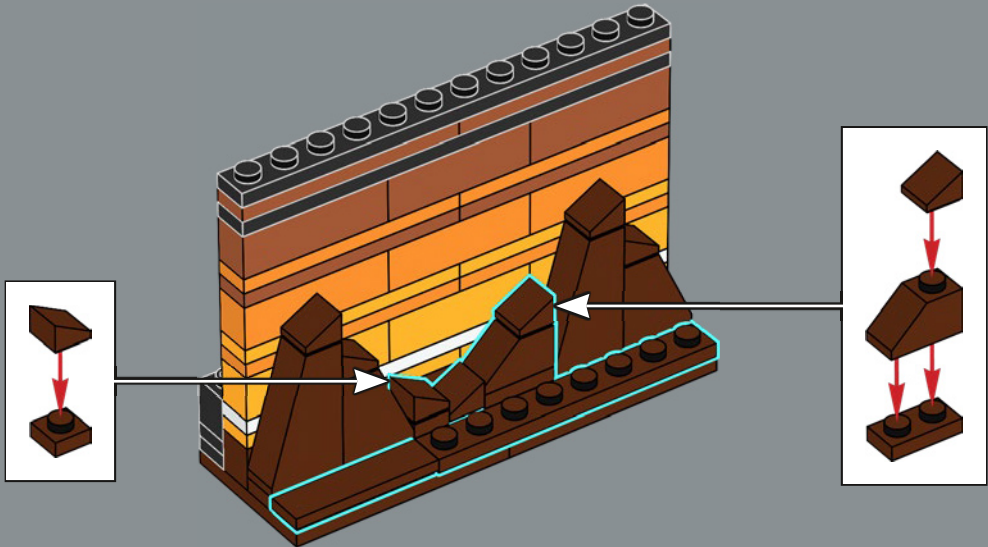

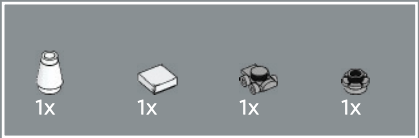

15

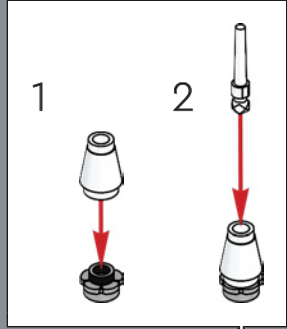
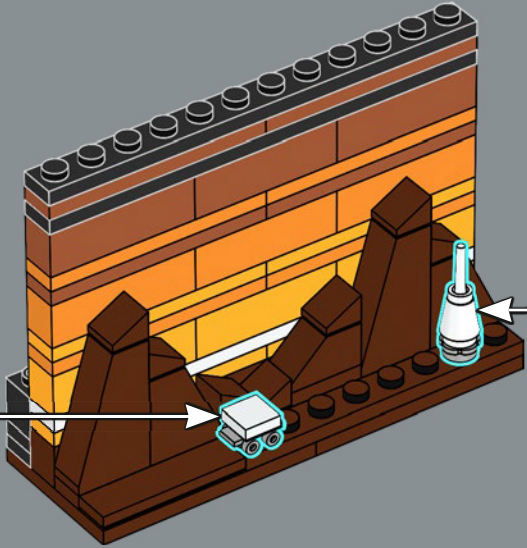
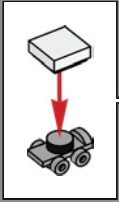



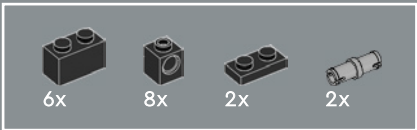

16

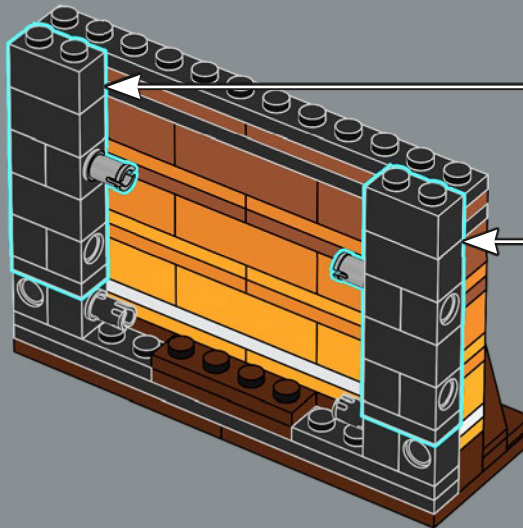
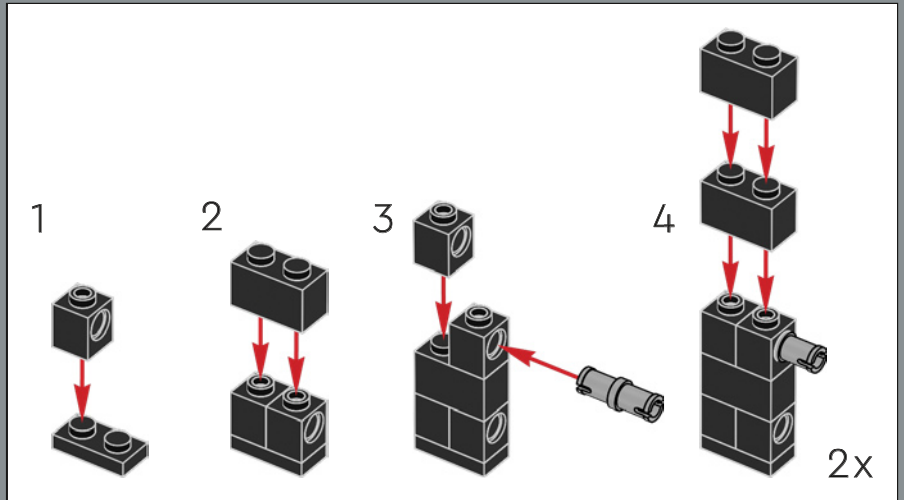





2x



4x

18

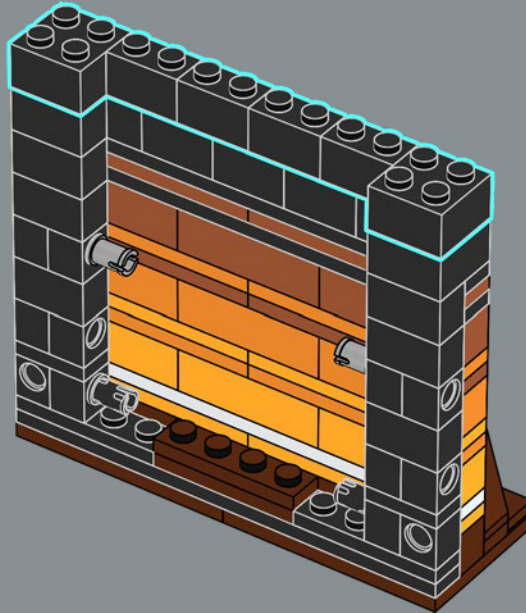

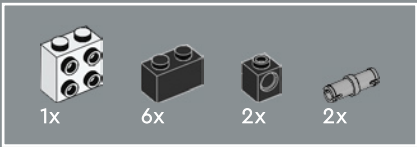

19

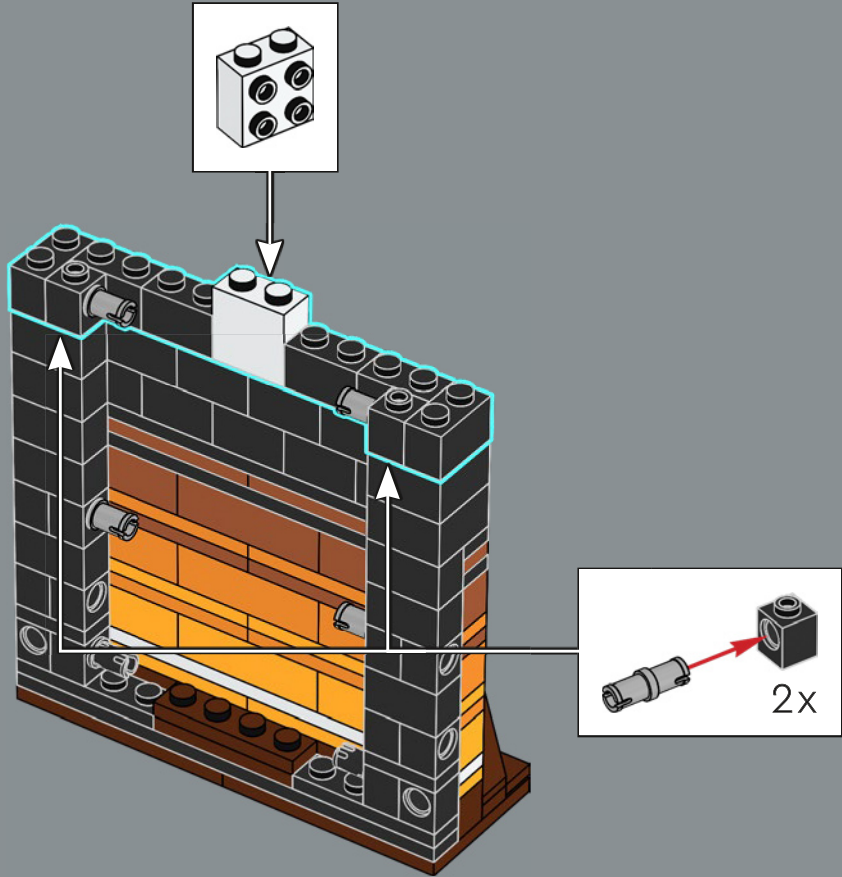

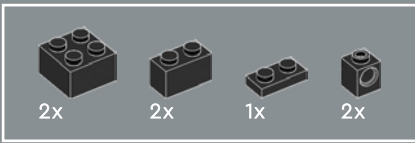

20

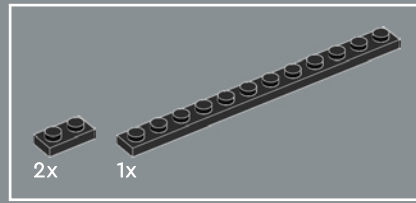
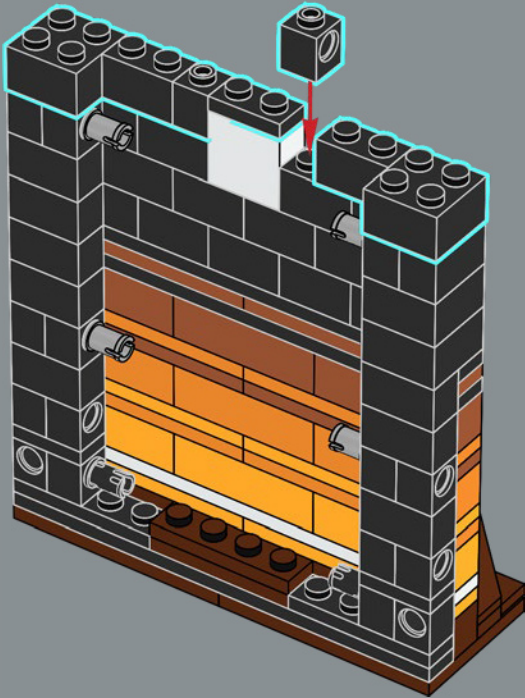

21

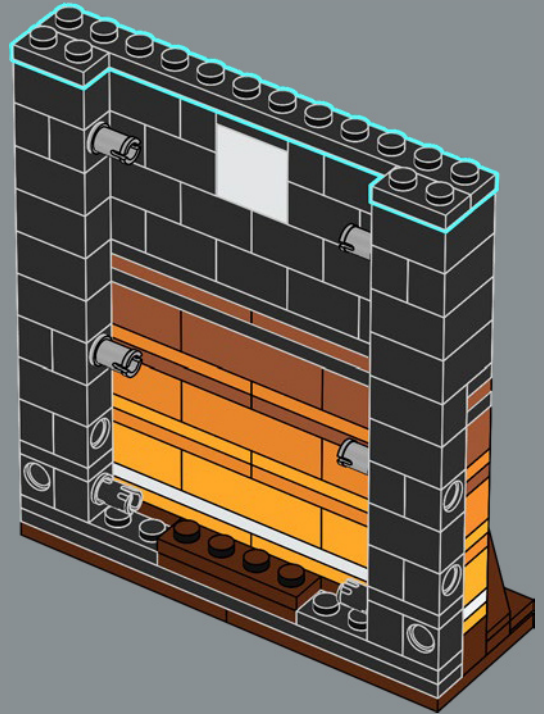

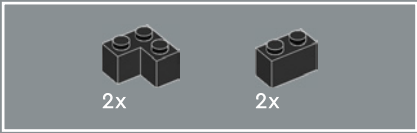

22

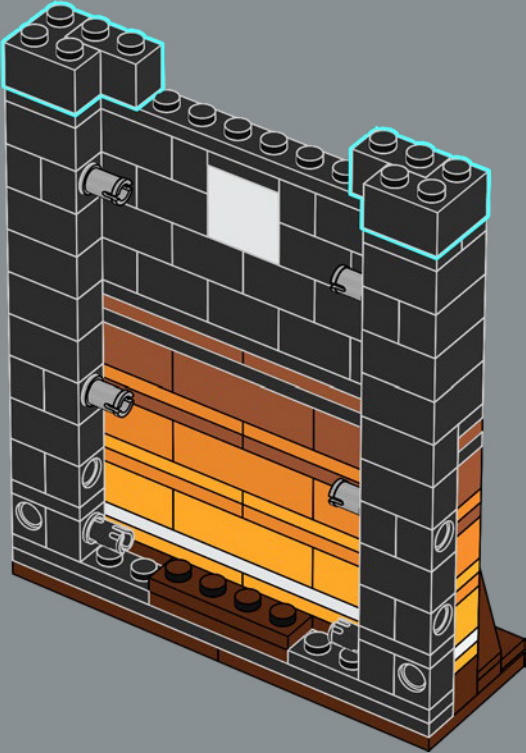

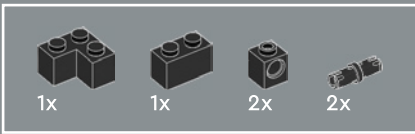

23

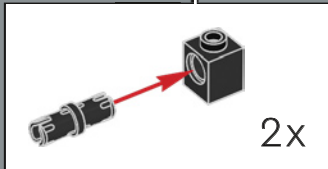
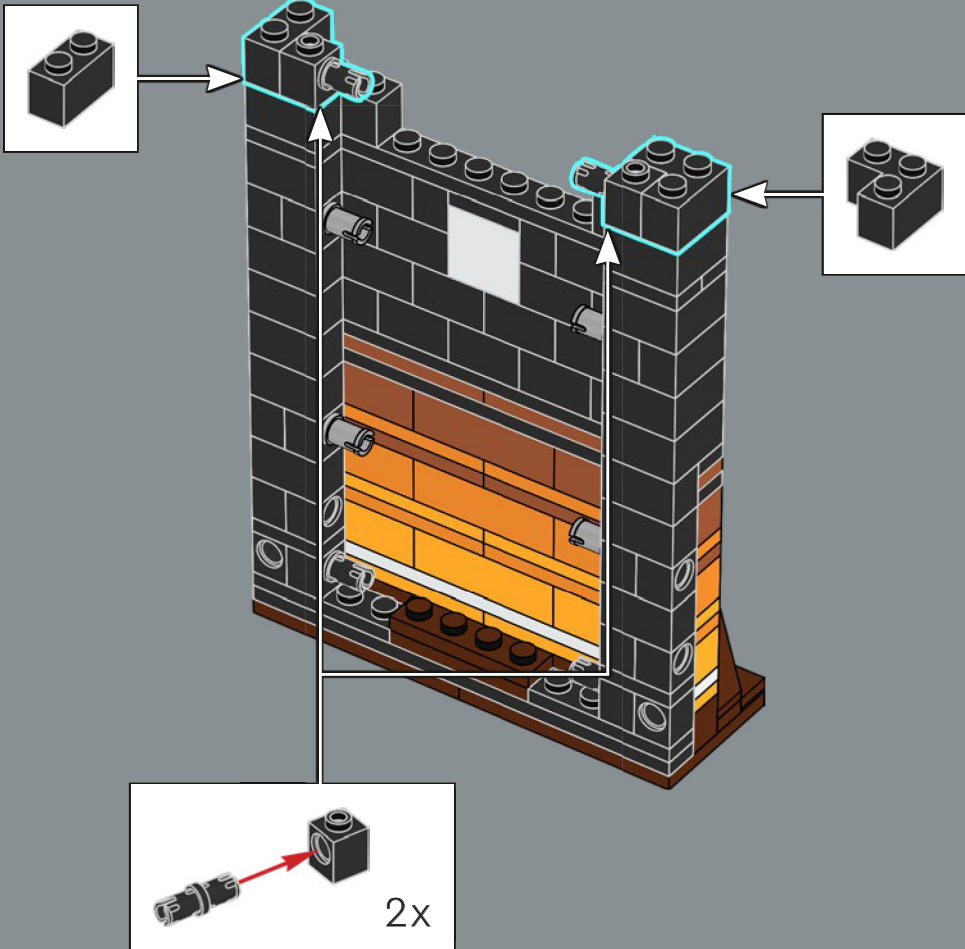

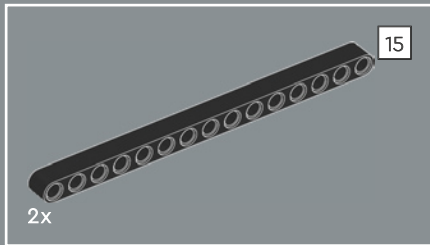

24

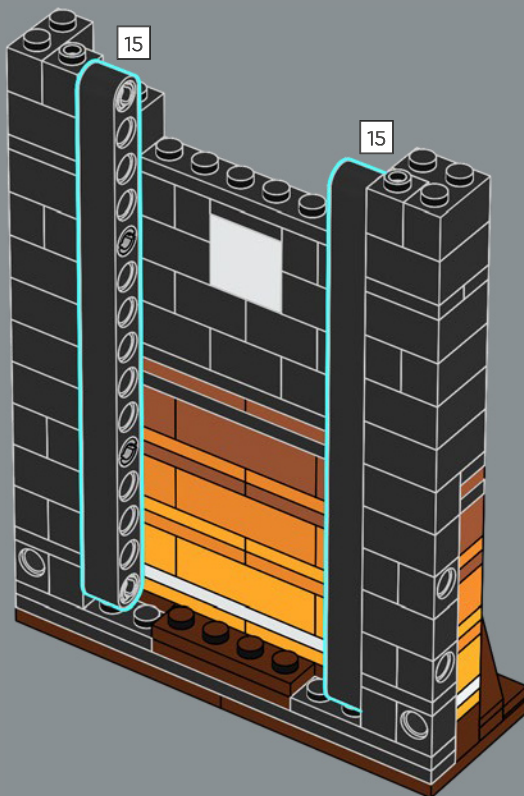



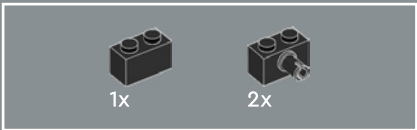

25

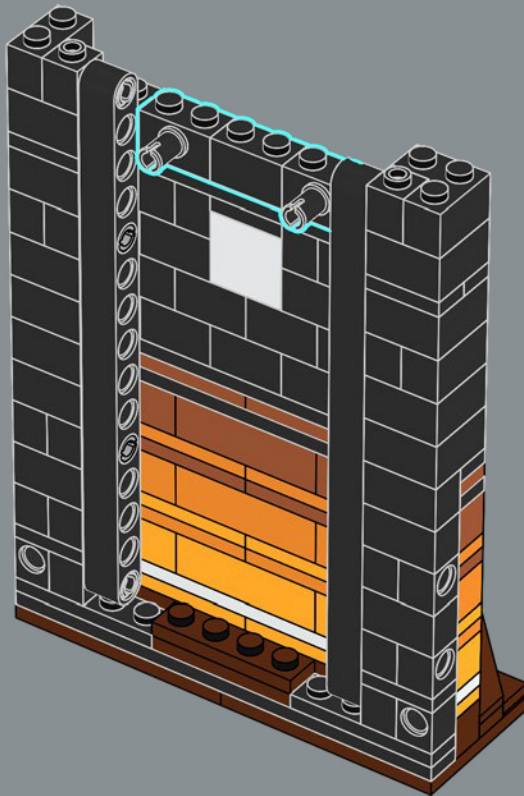



26

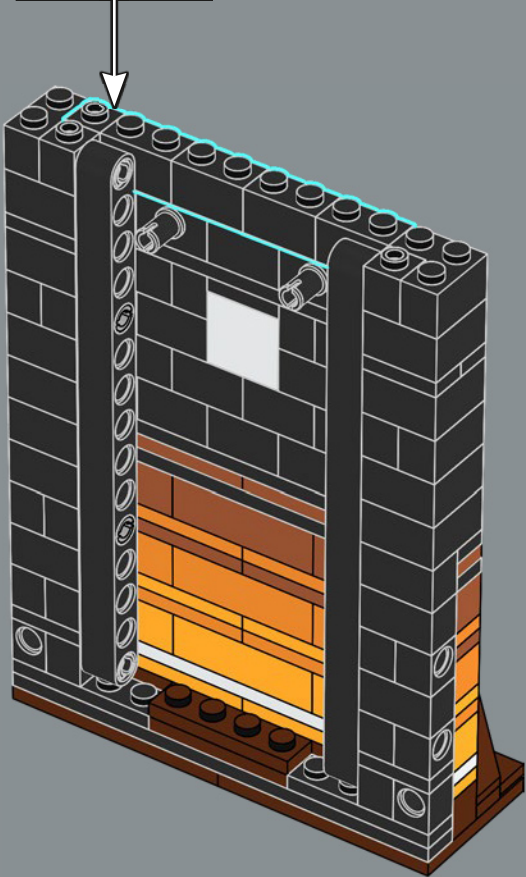
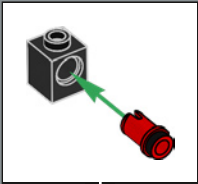

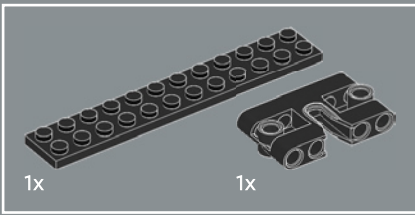

27

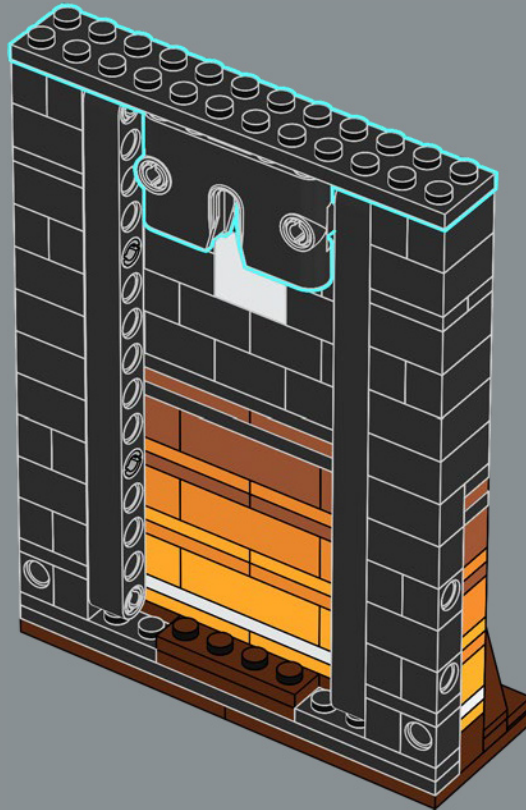

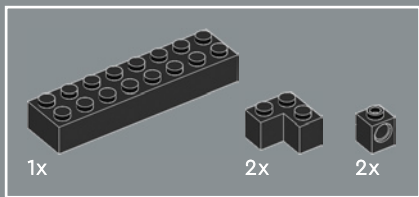

28

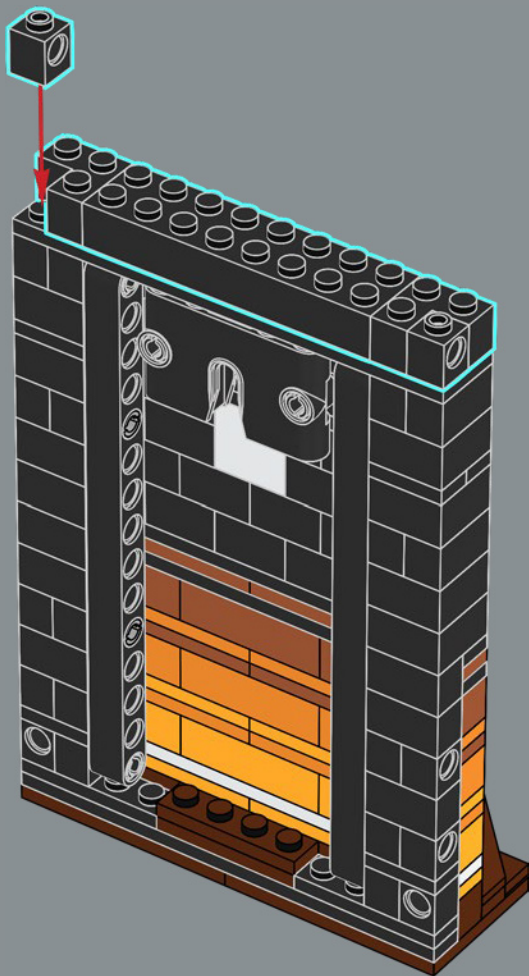

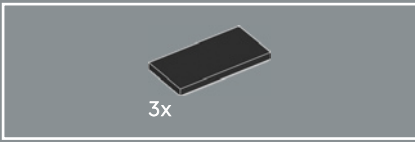

29

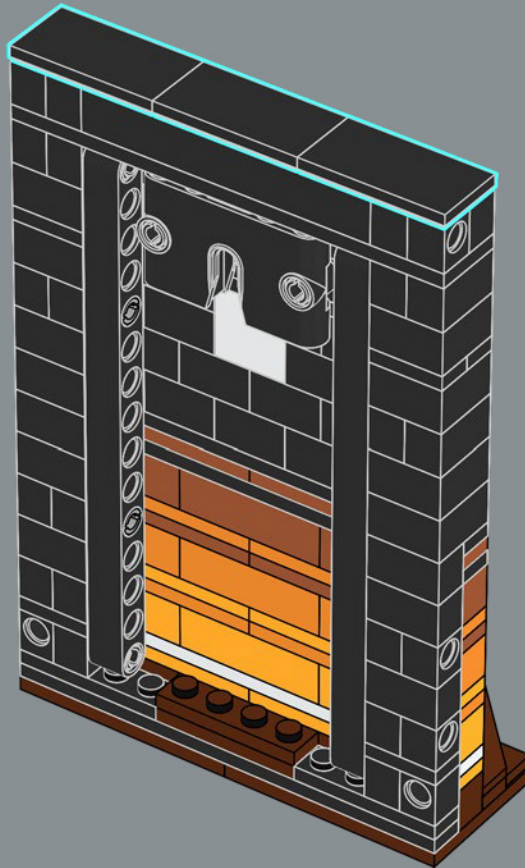

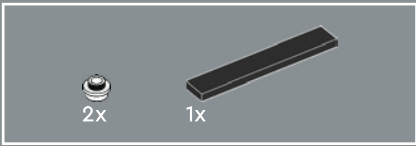

30

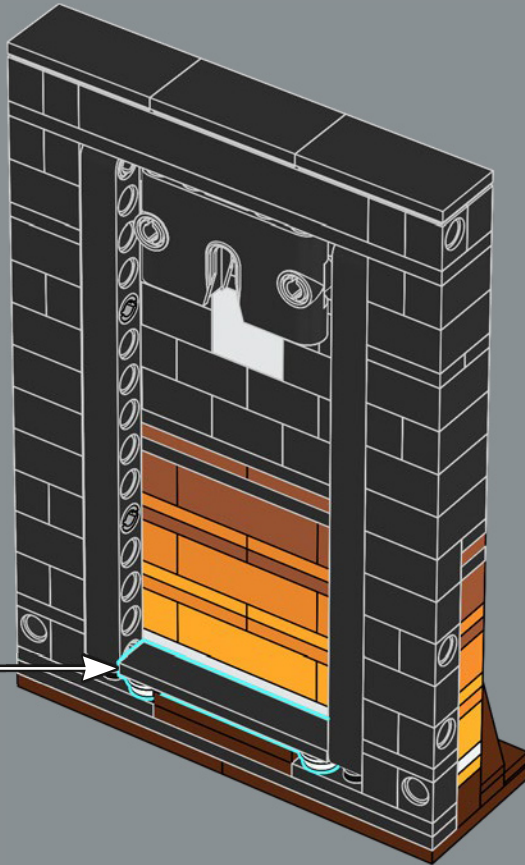
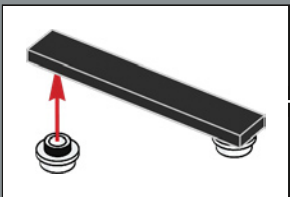

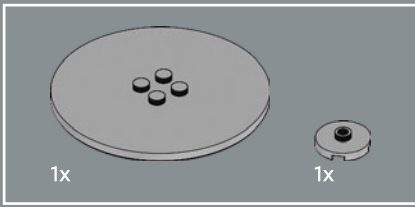

31

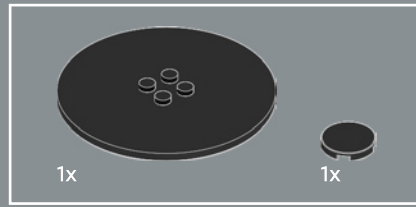

32



