



# MINECRAFT DUNGEONS

21163



2

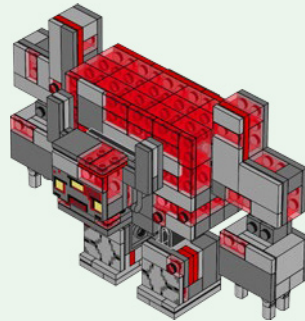
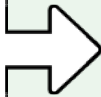
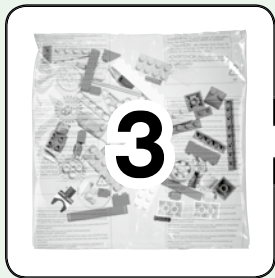
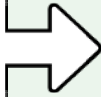
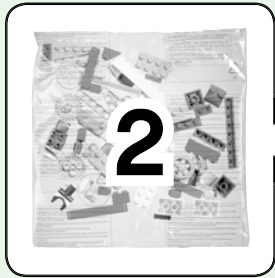

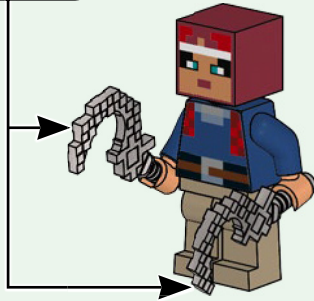
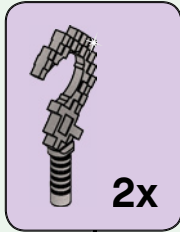
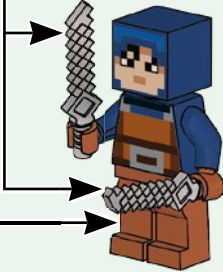
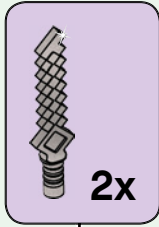
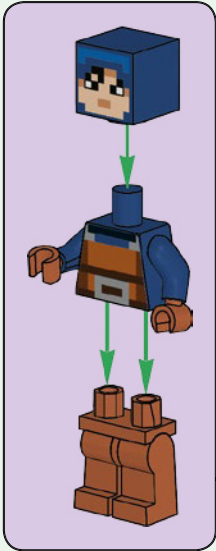
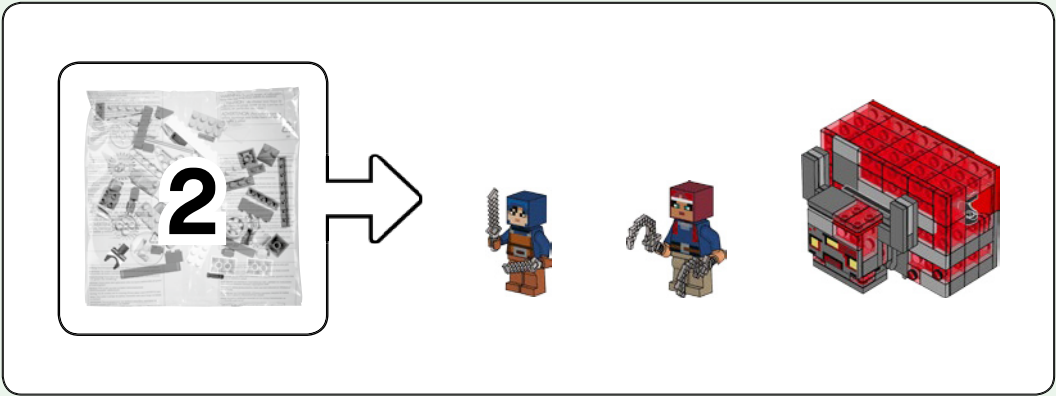

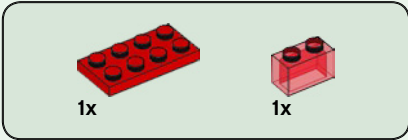
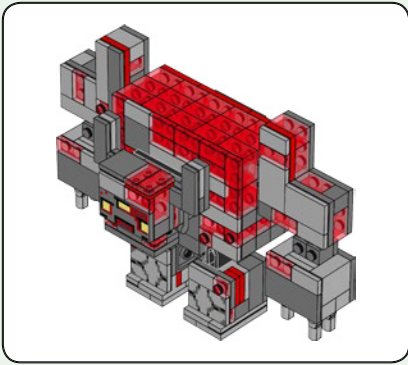

1

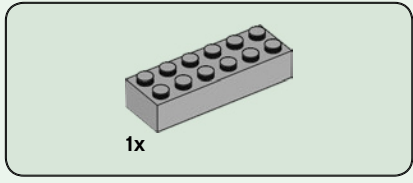
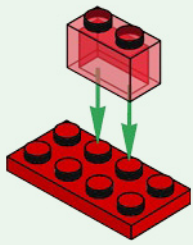

2

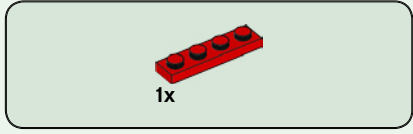
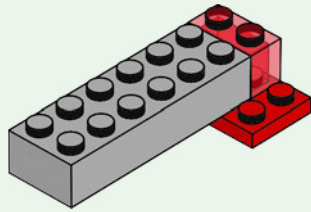

3

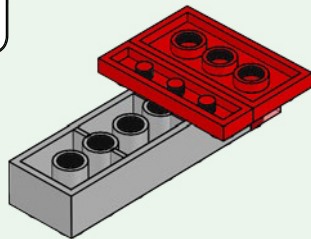

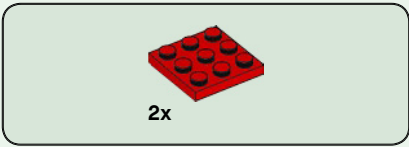

4

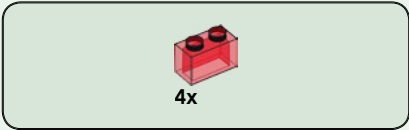
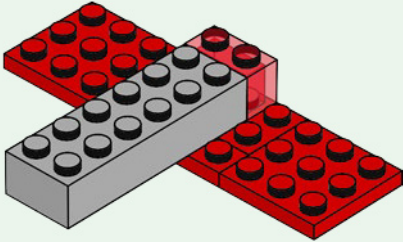

5

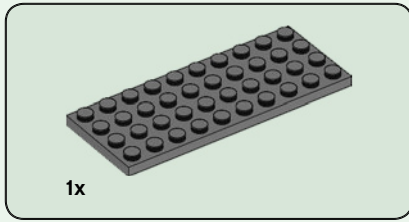
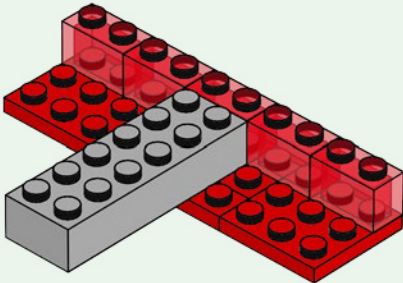

6

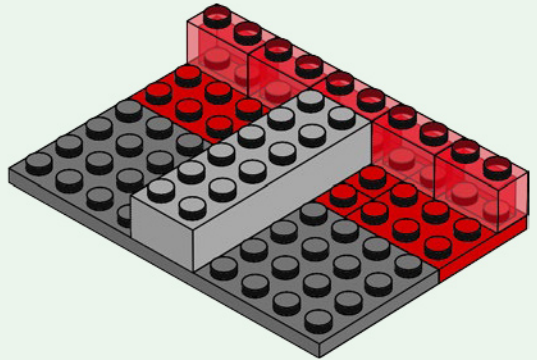

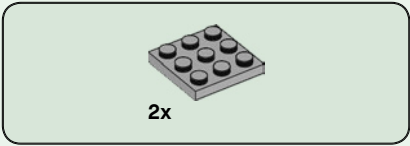

7

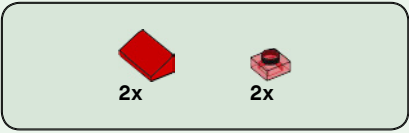
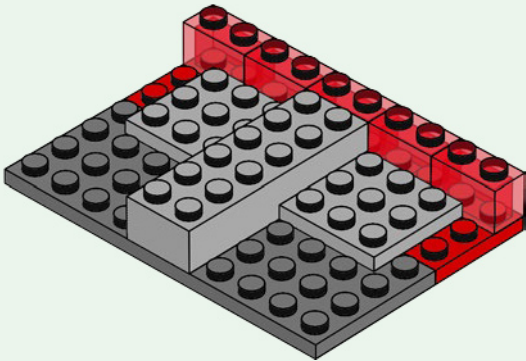

8

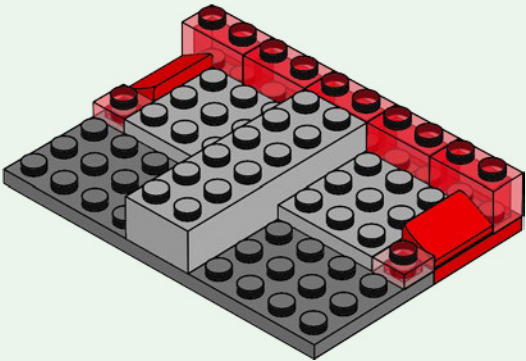



2x



4x

9

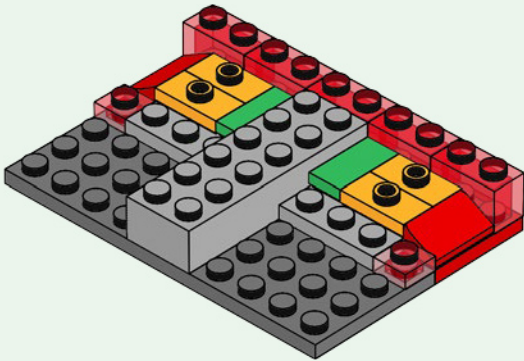

8x

10

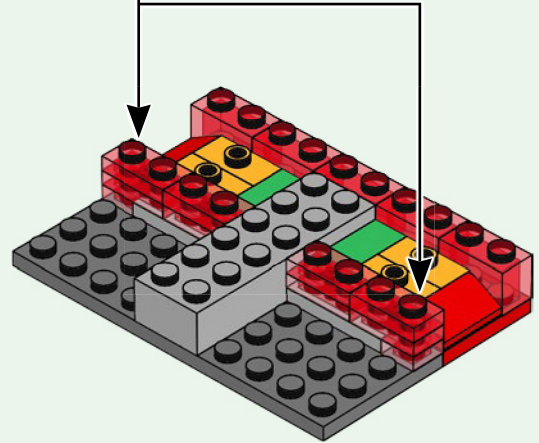
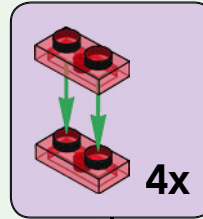

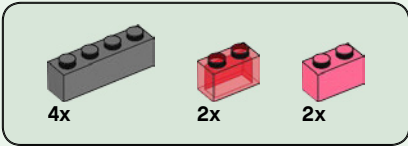

11

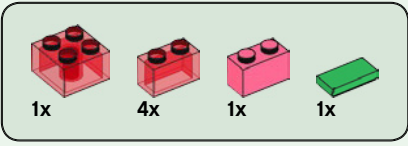
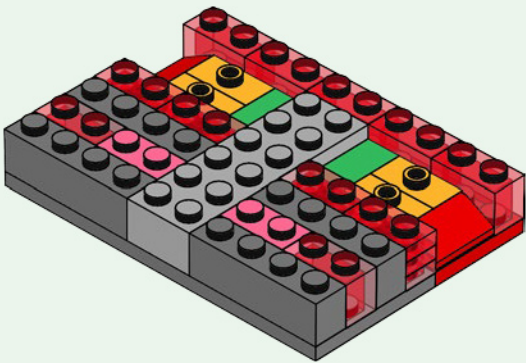

12

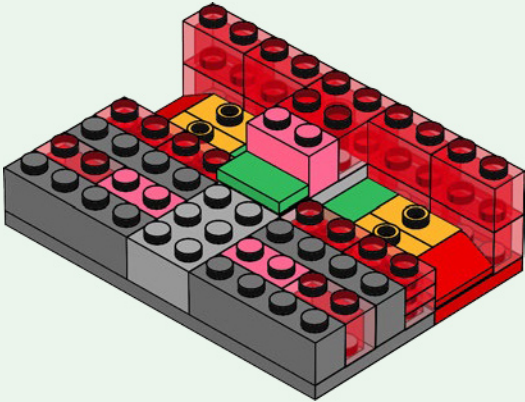



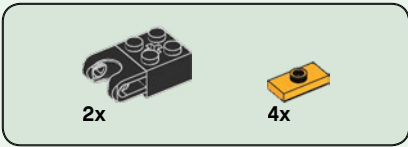

13

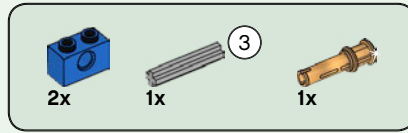
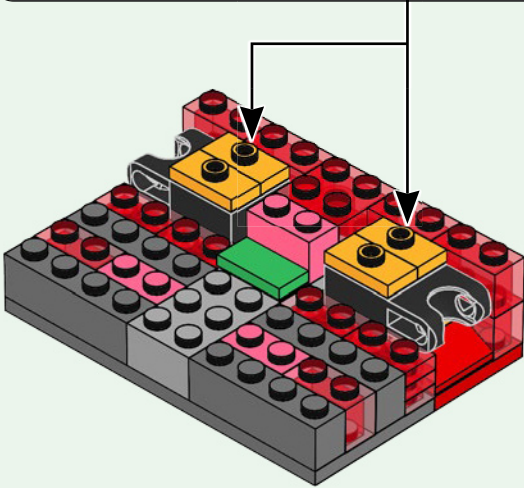
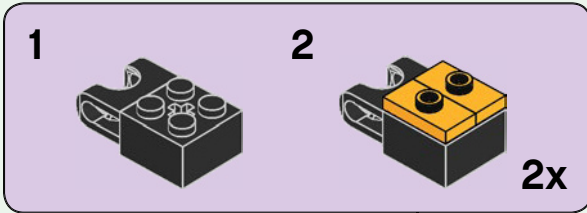

14

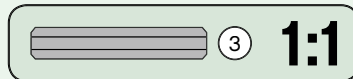
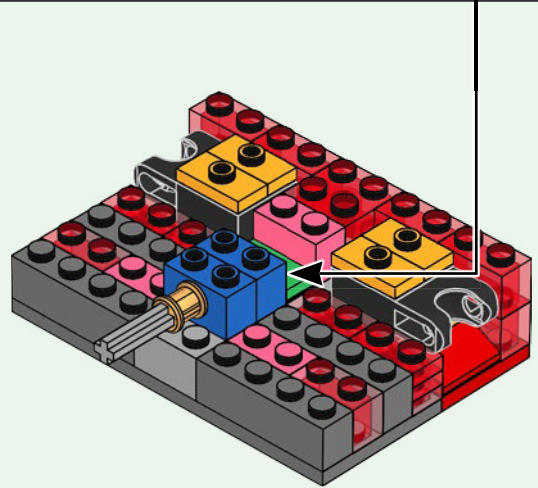
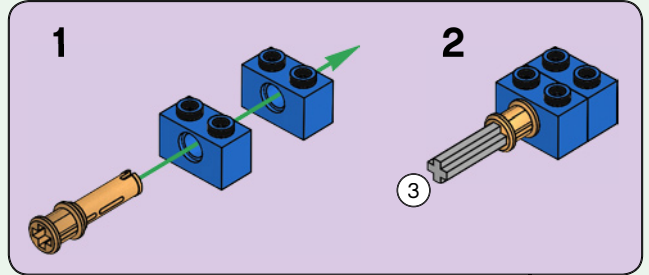

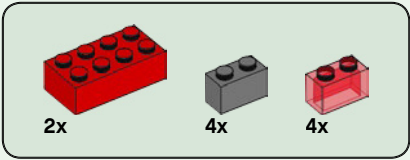

15

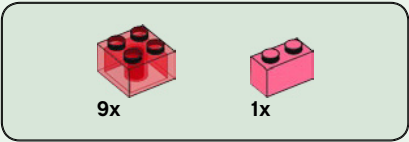
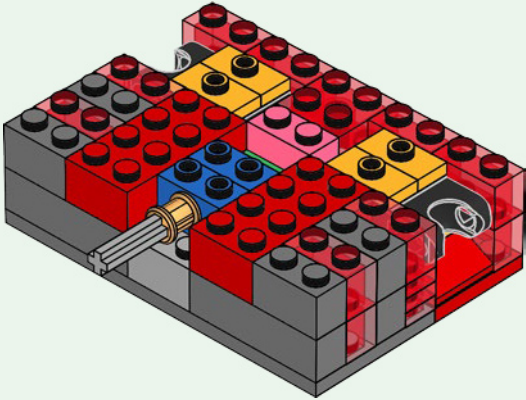

16

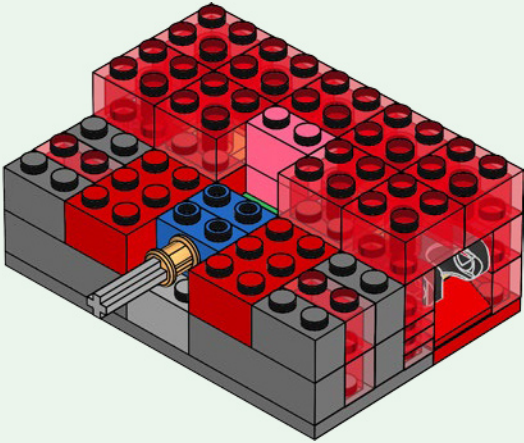

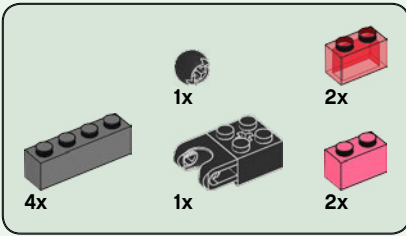

17

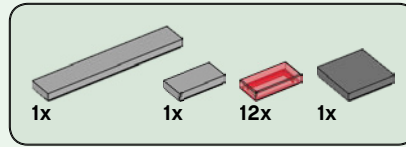
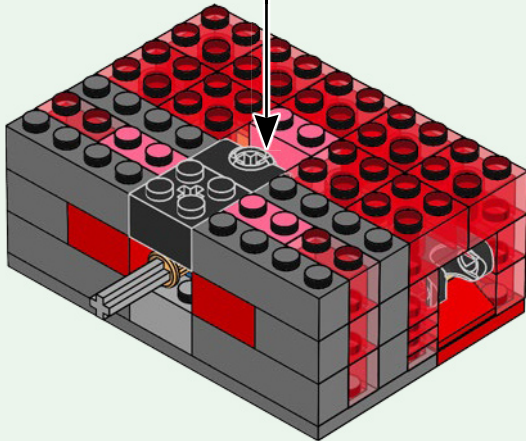
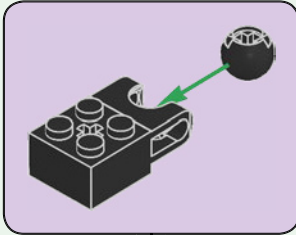

18

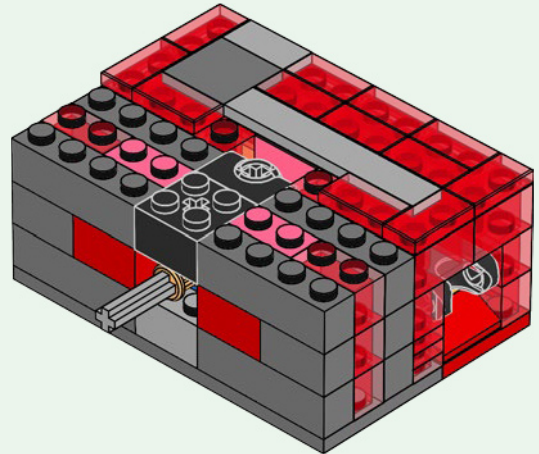

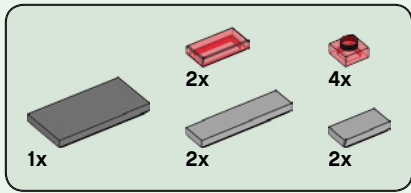

19

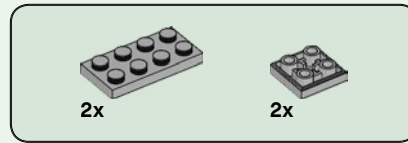
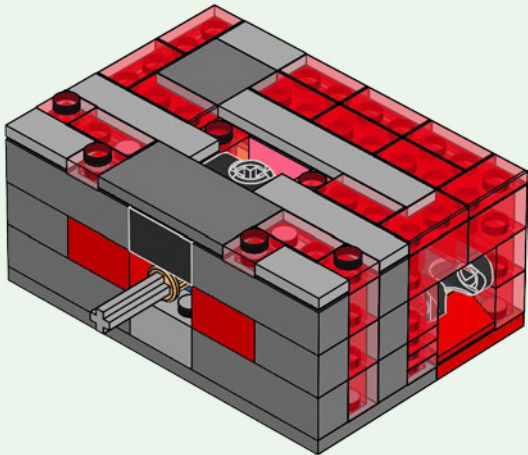

20

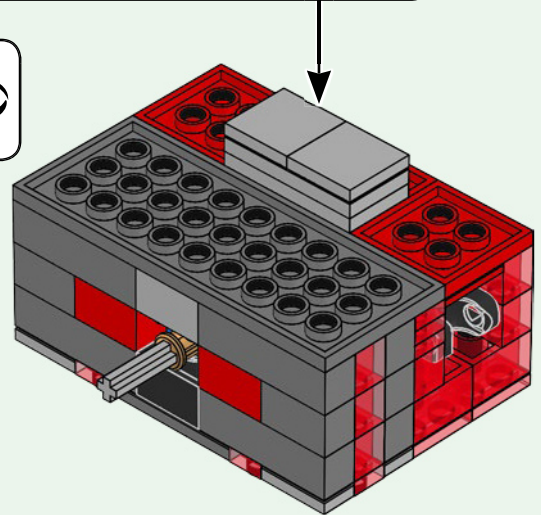
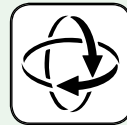
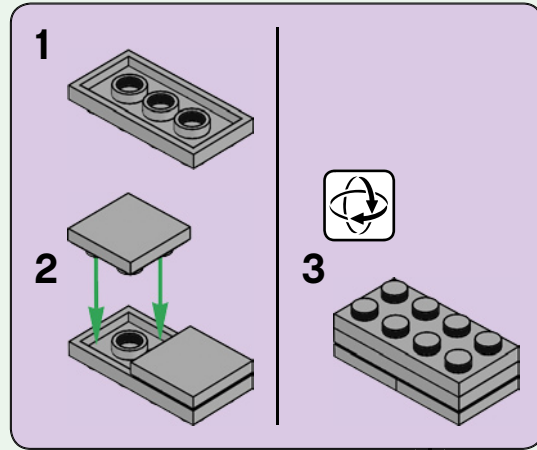

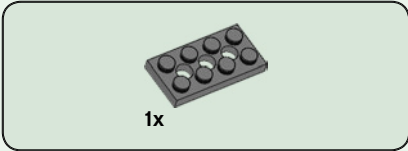
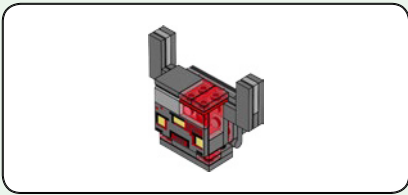

1x

# 21

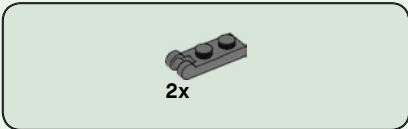
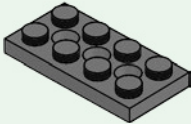

2x

# 22

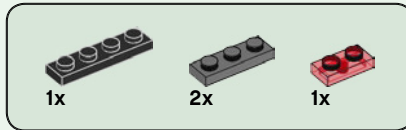
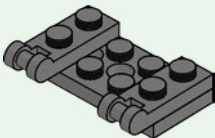

# 23

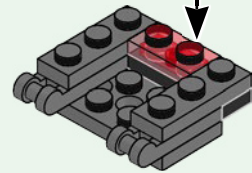
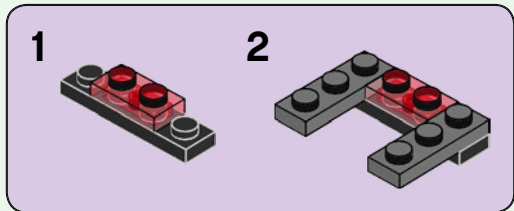



1x

24

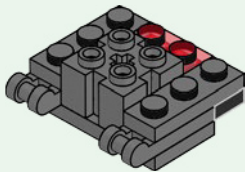

2x

25

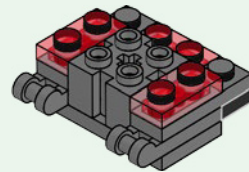

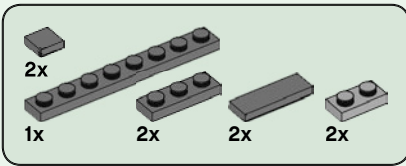

26

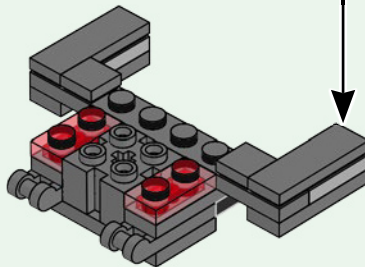
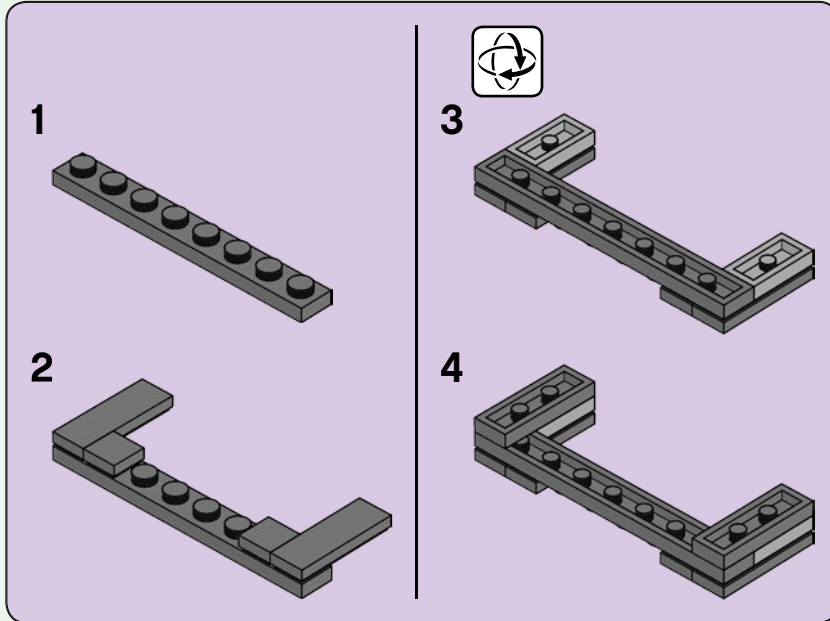

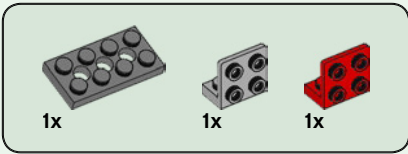

27

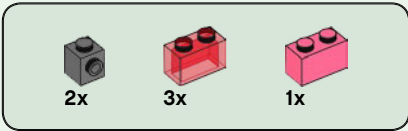
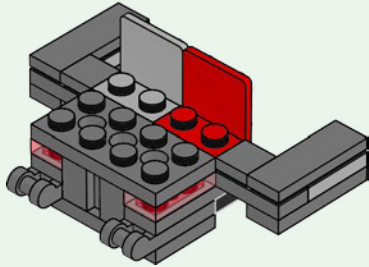

28

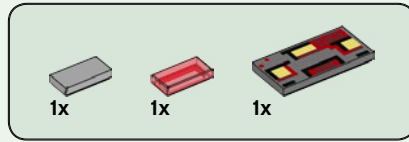
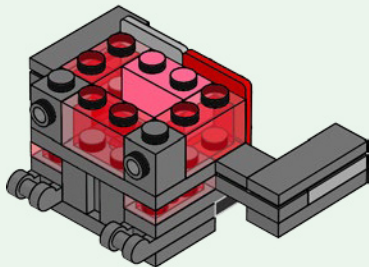

29

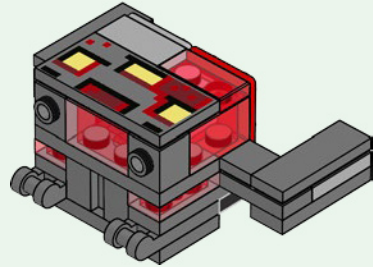

30

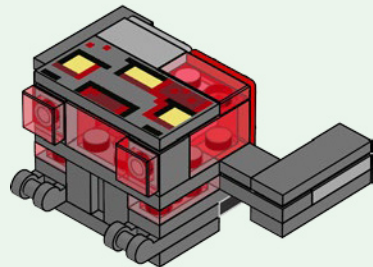



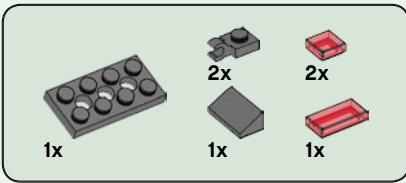

31

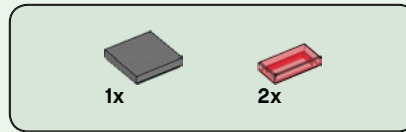
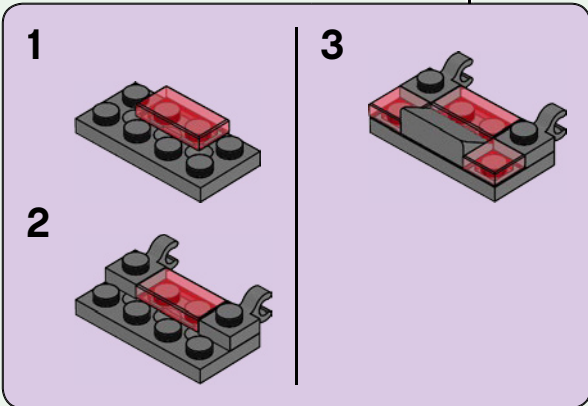
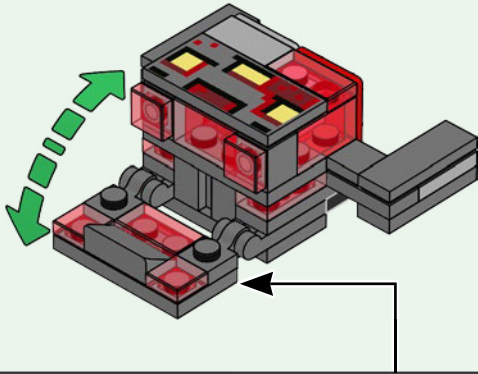

32

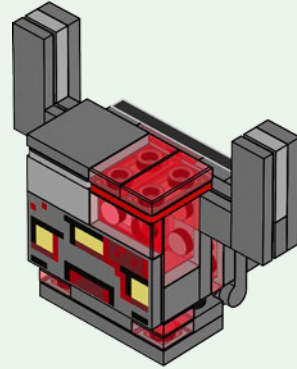
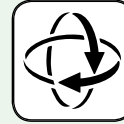

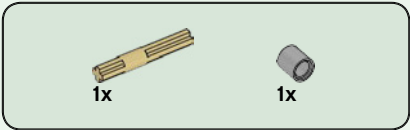

33

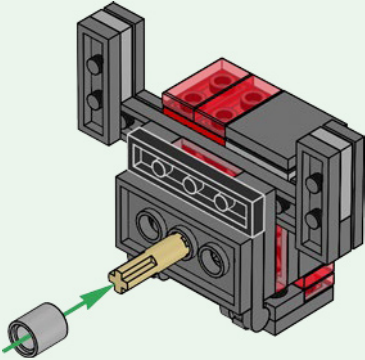

34

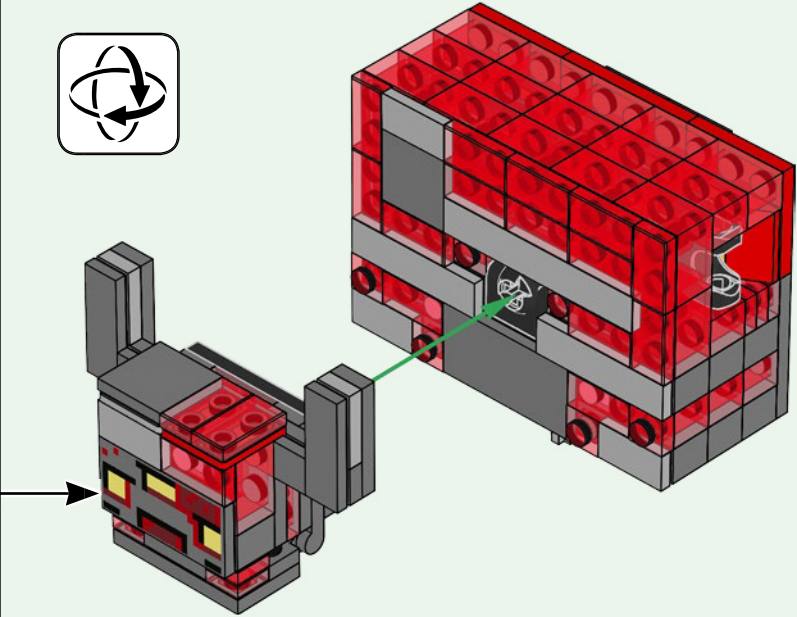

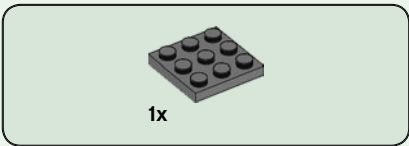
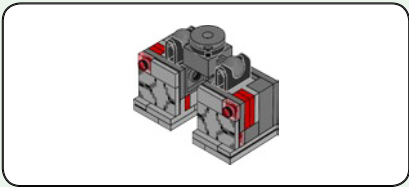
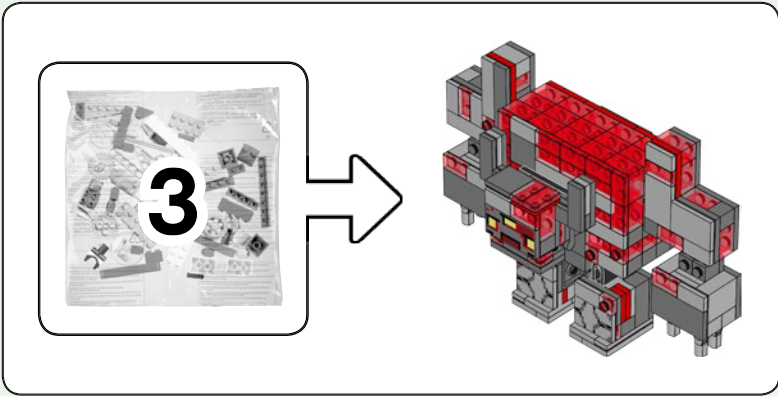

**35**

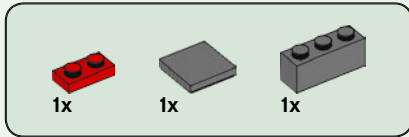
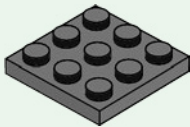

**36**

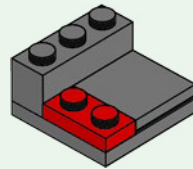



1x

# 37

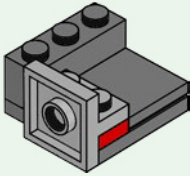

1x



1x

# 38

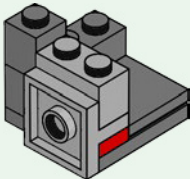

1x



1x



1x

# 39

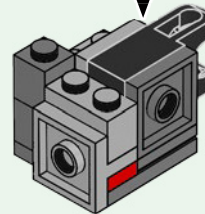
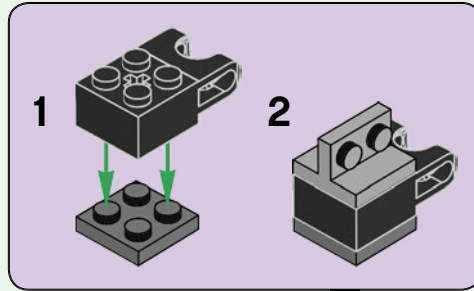



40

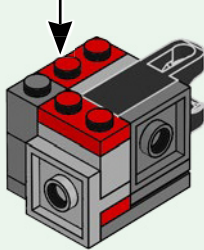
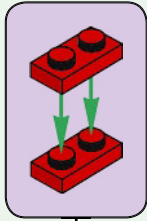

41



42

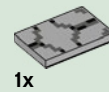
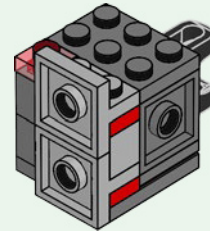

43

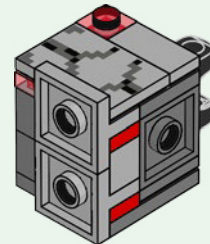

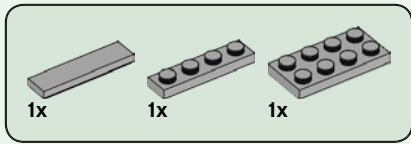

44

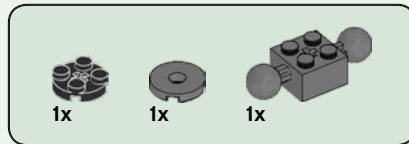
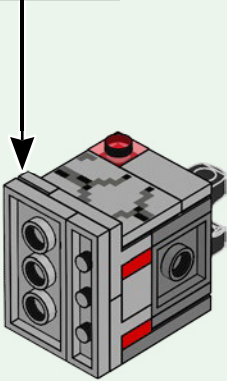
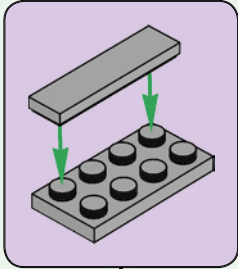

45

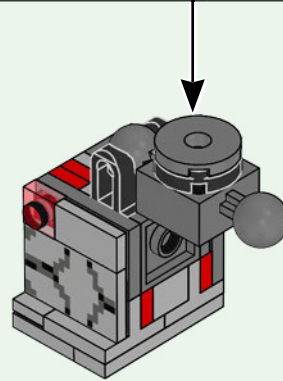
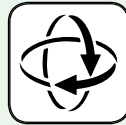
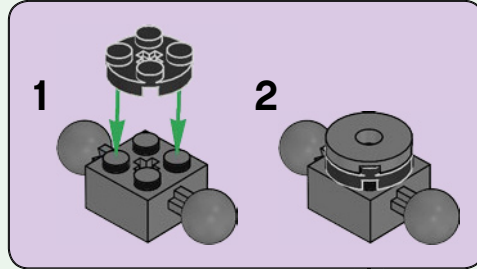



46

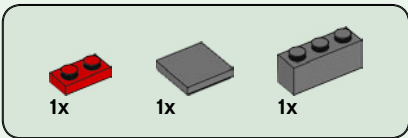
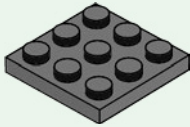

47

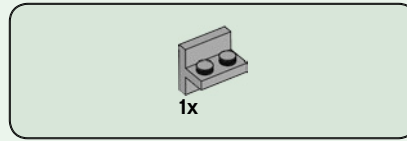
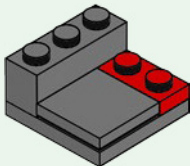

48

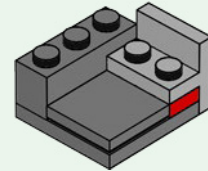

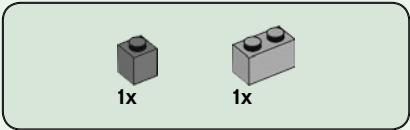

49

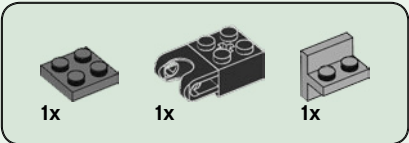
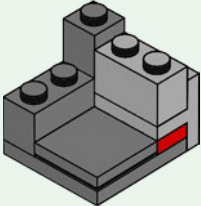

50

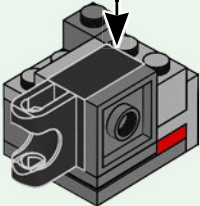
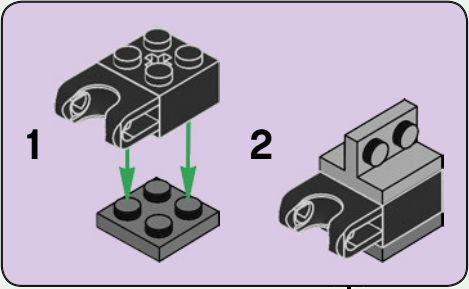





51

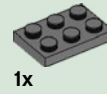
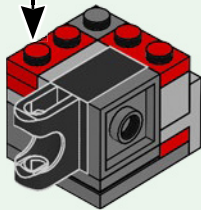
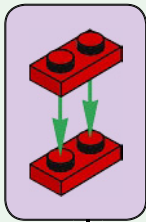

52

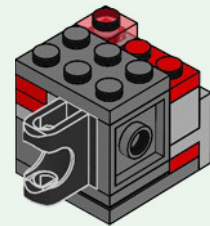

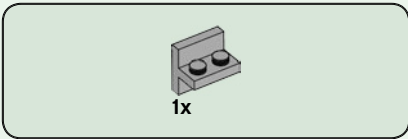

53

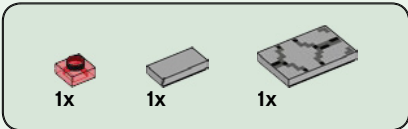

54

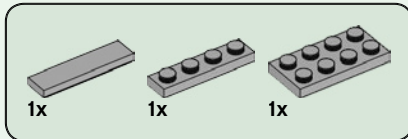

55

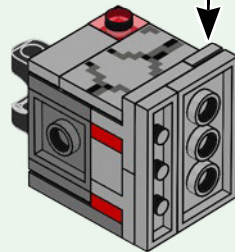
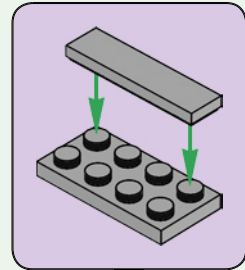

56

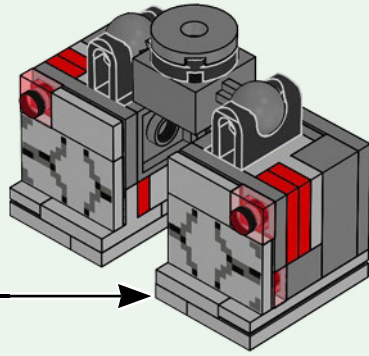

57

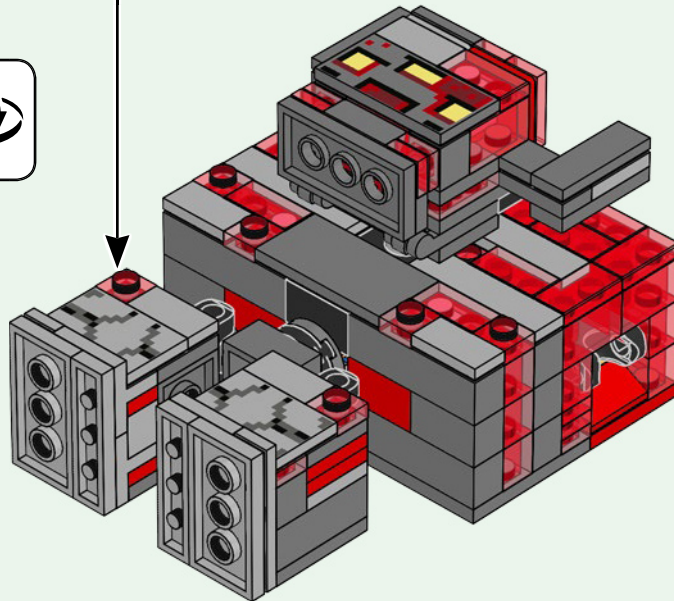

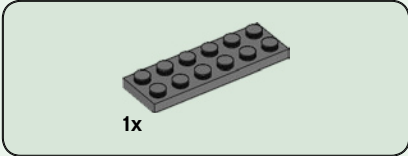
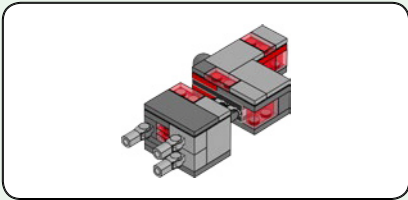

1x

58

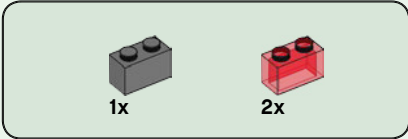
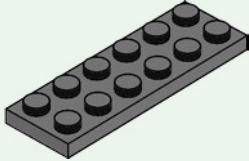

1x

2x

59

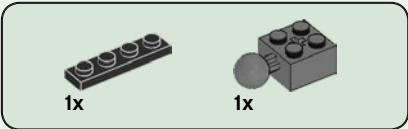
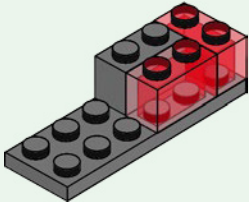

1x

1x

60

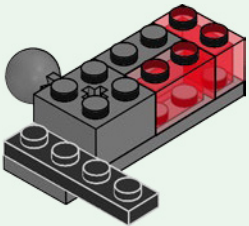

1x

61

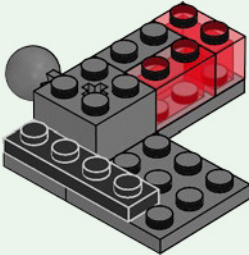

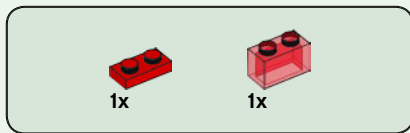

62

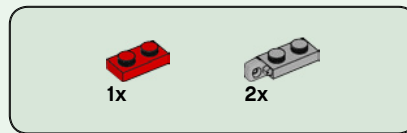
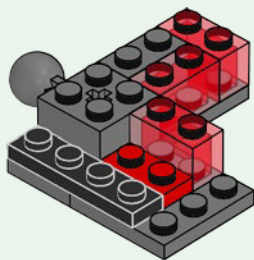

63

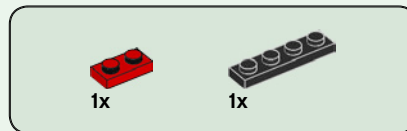
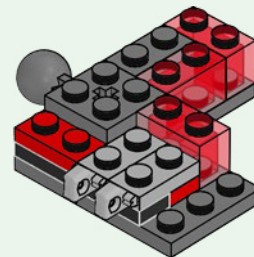

64

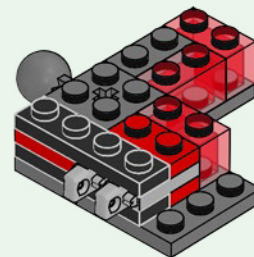

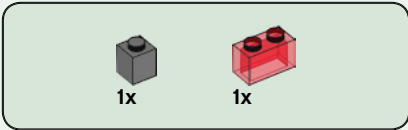

65

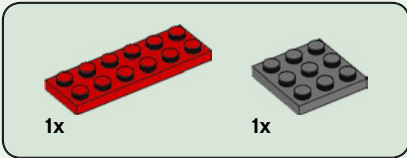
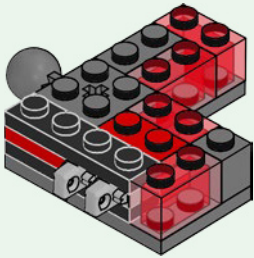

66

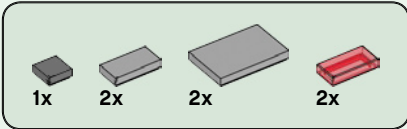
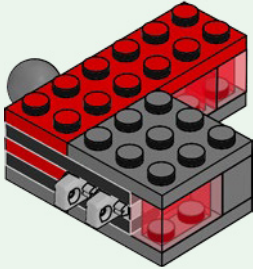

67

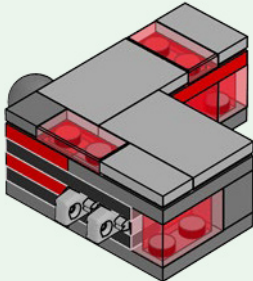

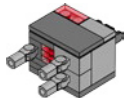

1x

68

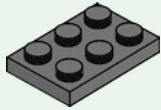

1x



2x

69

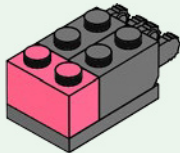

2x

70

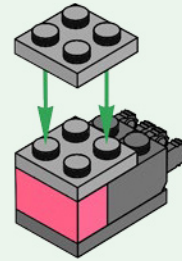

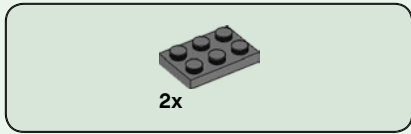

71

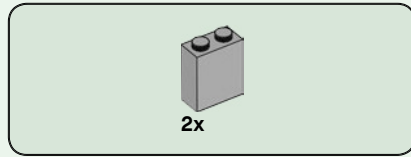

72

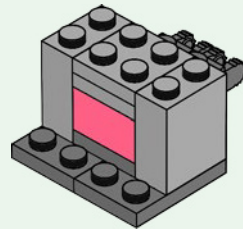
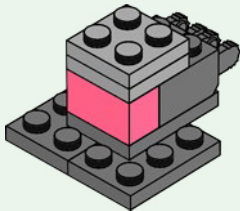





2x

# 73

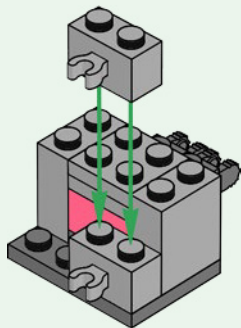

1x



3x



3x

# 74

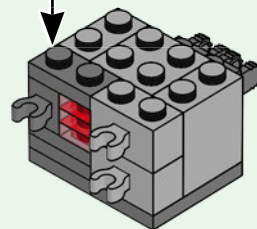
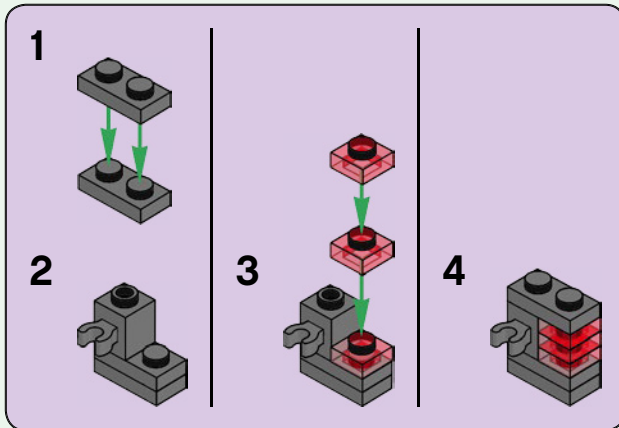

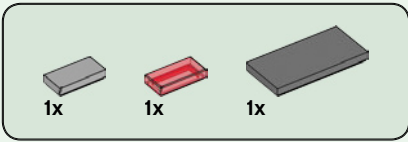

75

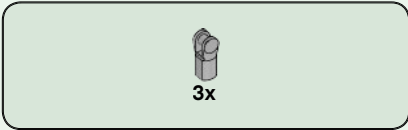
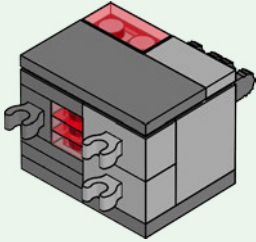

76

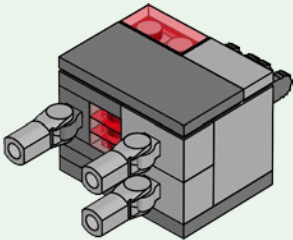

77

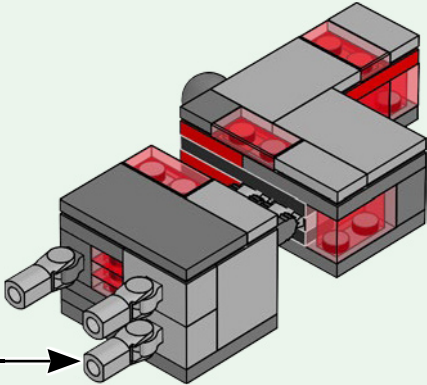

78

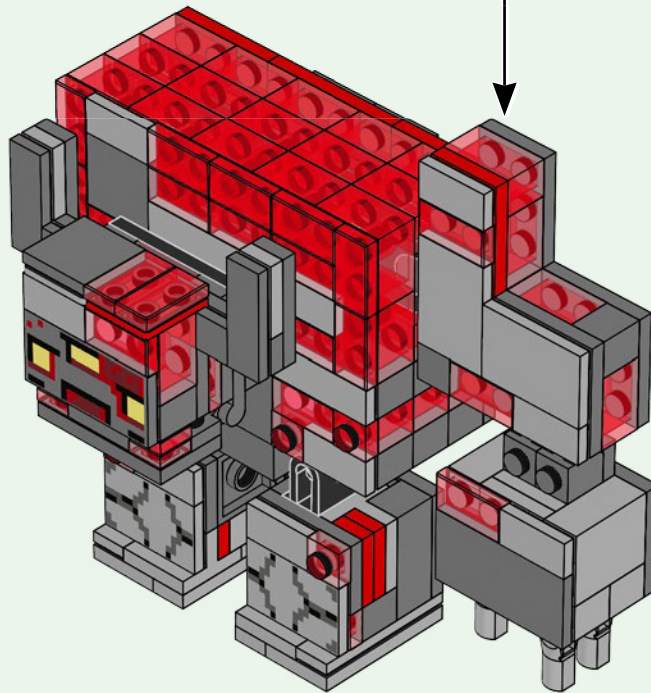

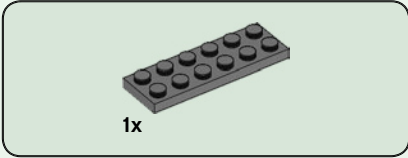
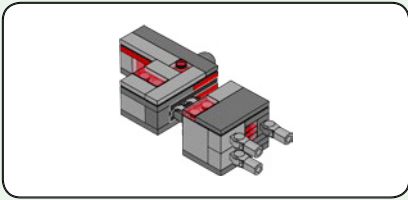

79

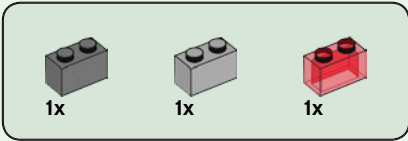
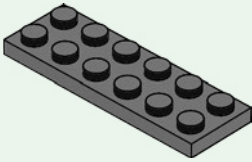

80

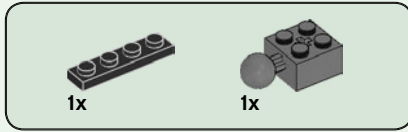
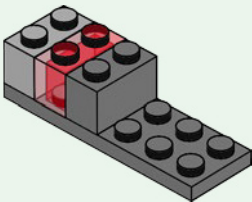

81

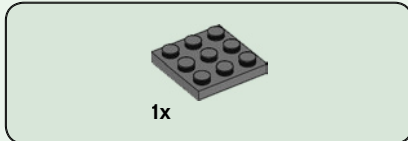
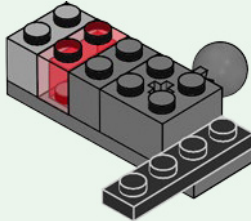

82

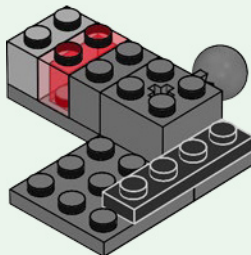

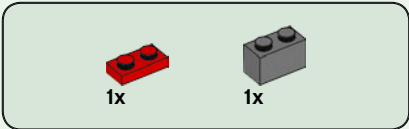

83

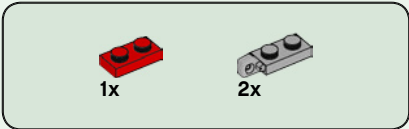
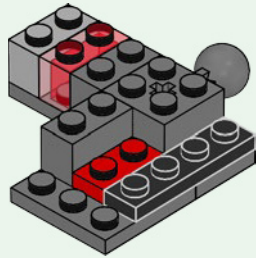

84

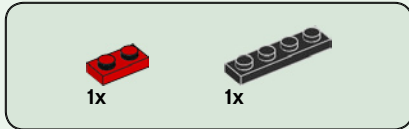
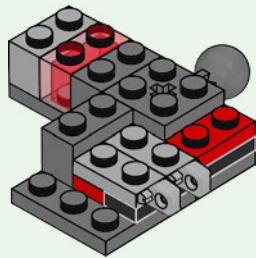

85

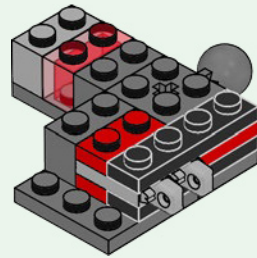

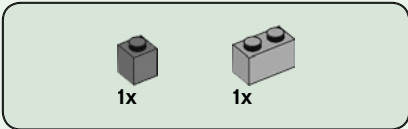

86

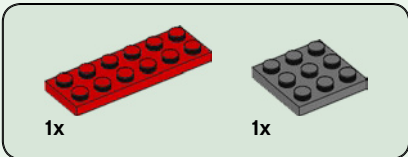
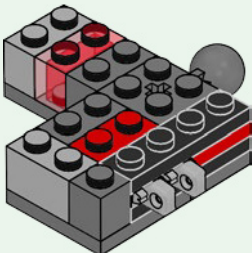

87

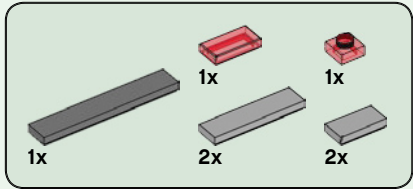
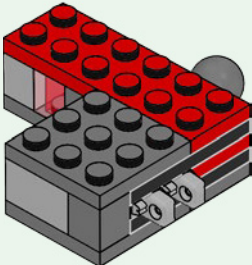

88

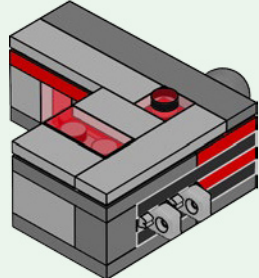

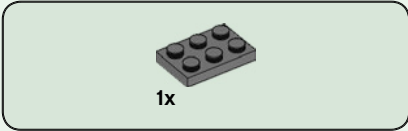
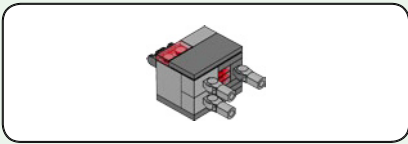

89

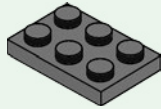

90

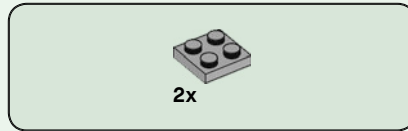
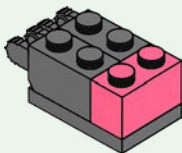

91

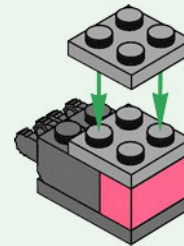



2x

92

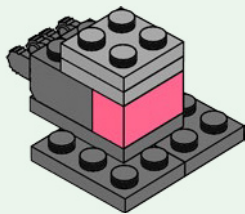

2x

93

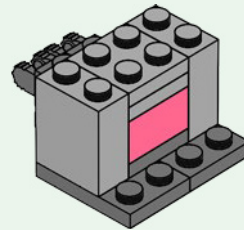



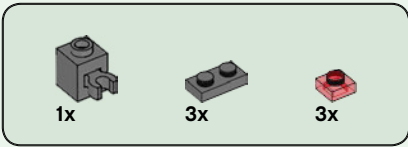

94

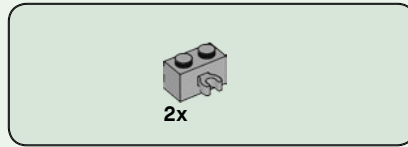
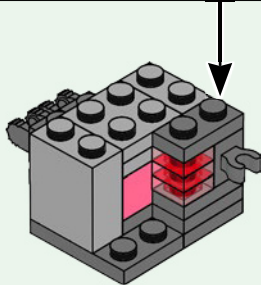
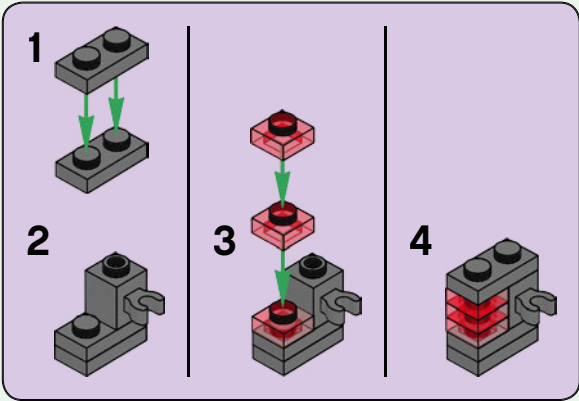

95

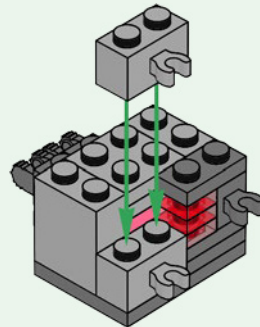

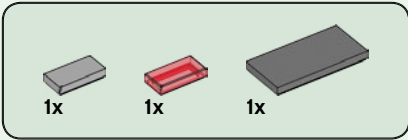

96

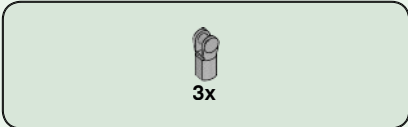
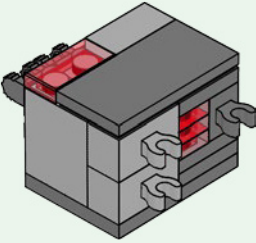

97

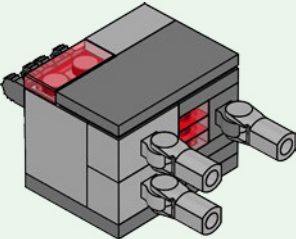

98

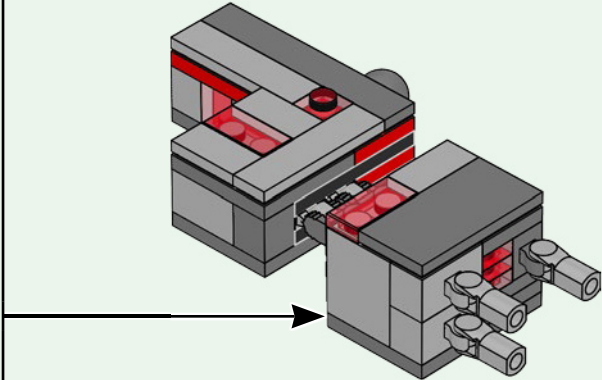

99

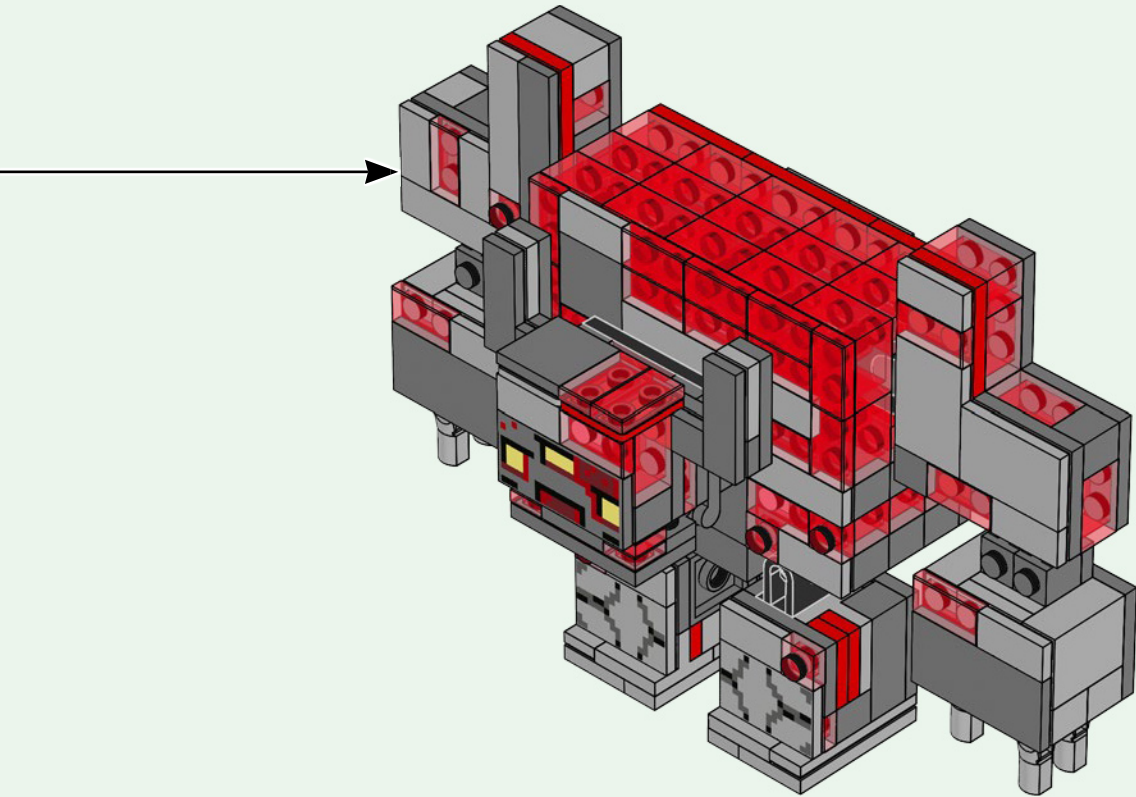

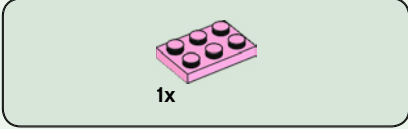
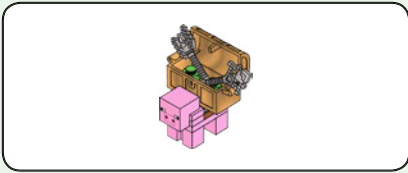

1

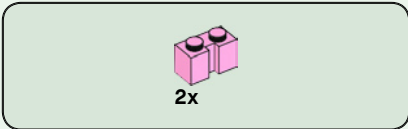

2

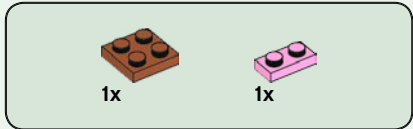
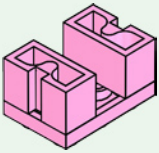

3

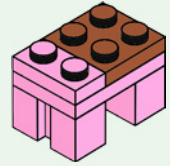

4

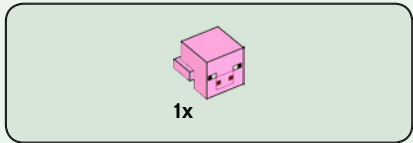
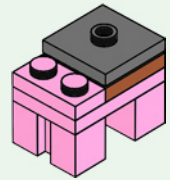

5

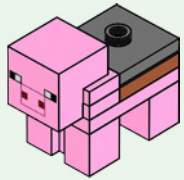

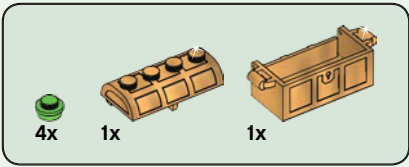

6

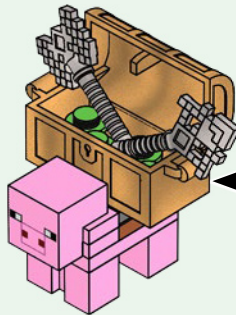
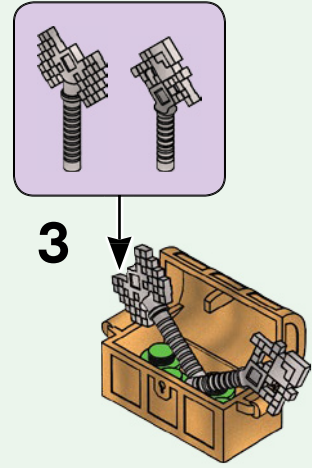
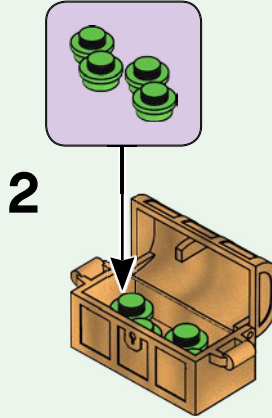
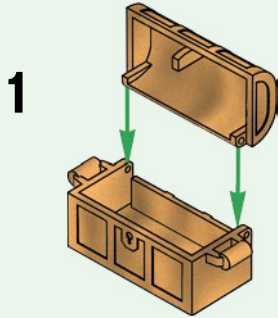



1x  
6046979



1x  
6307936



1x  
6308063



1x  
654121



2x  
4651524



14x  
302321



1x  
6001806



1x  
371021



2x  
6217123



1x  
302021



2x  
300121



2x  
379521

46



1x  
74040



3x  
306928



4x  
6109808



1x  
4286267



1x  
4184169



3x  
403226



2x  
6248496



3x  
6250020



1x  
4565323



1x  
302226



5x  
371026



5x  
4619763



1x  
302026



2x  
370023



1x  
371023



1x  
6172566



1x  
4615606



1x  
6308051



1x  
6186867



14x  
6208450



1x  
6276023



6x  
6254248



17x  
6252042



25x  
6244905



20x  
6240212



30x  
6251290



10x  
6239416



1x  
4666999



2x  
6294227



1x  
6252045



1x  
6305155



1x  
6310915



1x  
4524098



1x  
6192746



1x  
6305157



1x  
6305224



5x  
4216581



1x  
6305152



1x  
6307917



2x  
6288630



2x  
4173805



1x  
6252040



8x  
6122504



6x  
6152107



1x  
6183784



10x  
4211399



2x  
6248078



3x  
6043656



4x  
4211388



8x  
4211398



12x  
4211414



4x  
4211564



1x  
4654580



6x  
6258820



10x  
6266231



2x  
6132886



4x  
4211397



1x  
4211815



4x  
6043639



2x  
6063611



4x  
6320297



4x  
6305230



1x  
6305233



7x  
6171894



6x  
4211356



1x  
4211394



2x  
4211445

3



2x  
6015347



9x  
4211395

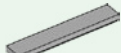

1x  
4211549



2x  
4211438



1x  
4211795

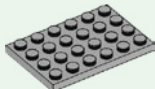

1x  
4211404



10x  
4210633



4x  
4211098



3x  
4210848



2x  
4558955



3x  
6225494



2x  
4579354



1x  
6055313



1x  
4567887



7x  
4211088



5x  
4211052



9x  
4211063



4x  
6123814



1x  
6126083



2x  
4211094



4x  
4211055



1x  
6236949



4x  
6267141



2x  
4521187



4x  
4211104



11x  
4211133



2x  
4568734



2x  
6321350



21x  
4211043



2x  
4497253



8x  
4211103



6x  
6039176



3x  
4560184



1x  
6305237



3x  
4227398



1x  
6065816



1x  
4211122



1x  
421114



1x  
4210651



2x  
4211002



1x  
4210998



2x  
4654128



2x  
6291009



1x  
6290525



1x  
6102999



1x  
6285441



1x  
6278473



1x  
6278470



1x  
4538950



4x  
6057986



2x  
6097024



1x  
6097003



1x  
6218145



1x  
6300577



9x  
6258572



Customer Service

Kundenservice

Service Consommateurs

Servicio Al Consumidor

LEGO.com/service or dial

: 00800 5346 5555

: 1-800-422-5346

# WIN

GO TO [WWW.LEGO.COM/PRODUCTFEEDBACK](http://WWW.LEGO.COM/PRODUCTFEEDBACK) AND  
GIVE US YOUR SHORT **FEEDBACK** ABOUT THIS  
LEGO® SET FOR A CHANCE TO WIN  
A COOL LEGO PRIZE.

Terms & Conditions apply



## [LEGO.com/productfeedback](http://LEGO.com/productfeedback)

### GEWINNE

Erzähle uns auf  
[www.LEGO.com/productfeedback](http://www.LEGO.com/productfeedback)

etwas über die Erfahrungen, die du mit  
diesem LEGO® Set gemacht hast, und  
sichere dir die Chance auf einen coolen  
LEGO Preis!

Es gelten die Teilnahmebedingungen

### GAGNE

Rends-toi sur  
[www.LEGO.com/productfeedback](http://www.LEGO.com/productfeedback)

et donne-nous quelques commentaires  
sur ce produit LEGO® pour avoir une  
chance de gagner un prix LEGO !

Voir Conditions Générales

### GANAN

Visita  
[www.LEGO.com/productfeedback](http://www.LEGO.com/productfeedback)

y envíanos tu opinión acerca de este set  
LEGO®. ¡Participarás en el sorteo de un  
premio LEGO!

Términos y Condiciones aplicables

### 获取奖品

登录  
[www.LEGO.com/productfeedback](http://www.LEGO.com/productfeedback)

给出关于此乐高®套装的简短反馈，  
就有机会获得炫酷乐高奖品

《条款及条件》适用