

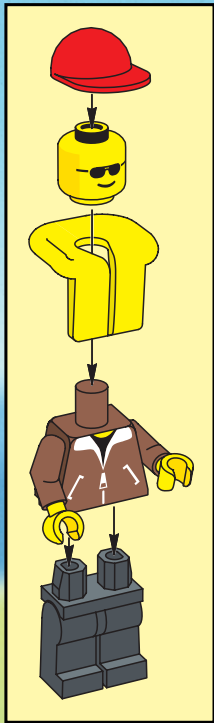

SYSTEMTM

1817





1

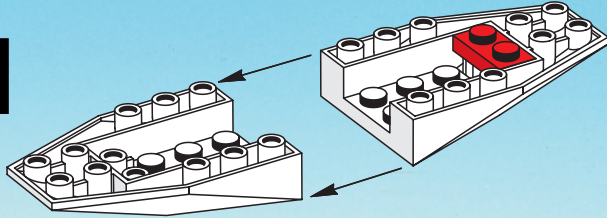

2

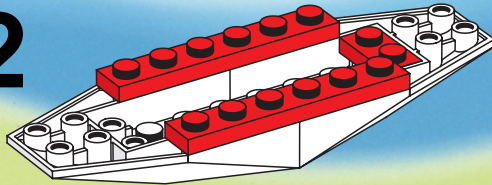

3

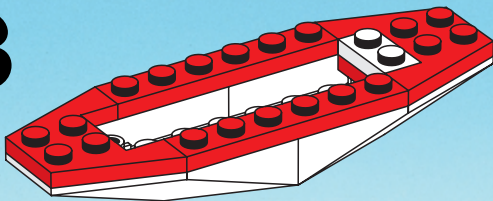

4

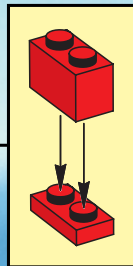
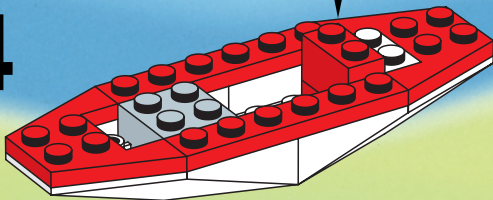

5

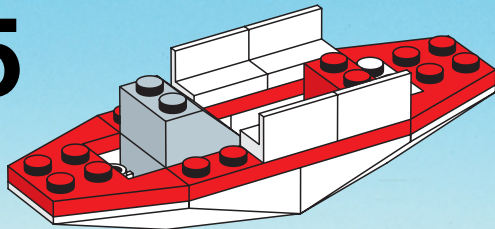

6

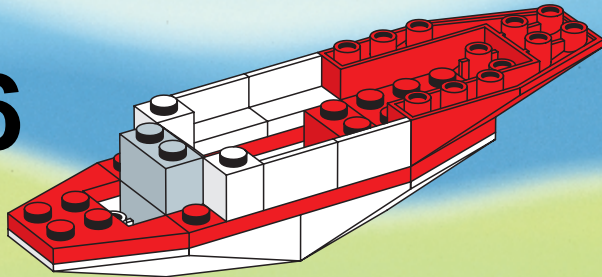

7

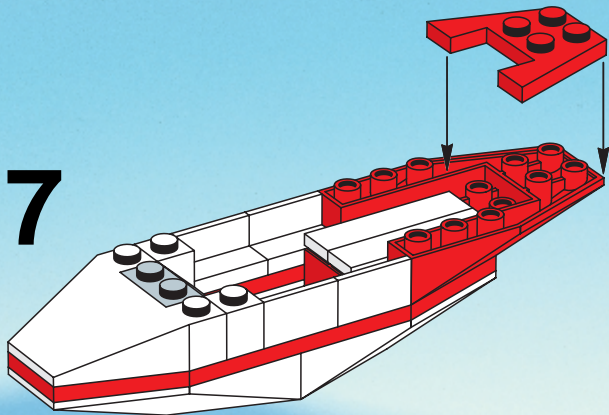

8

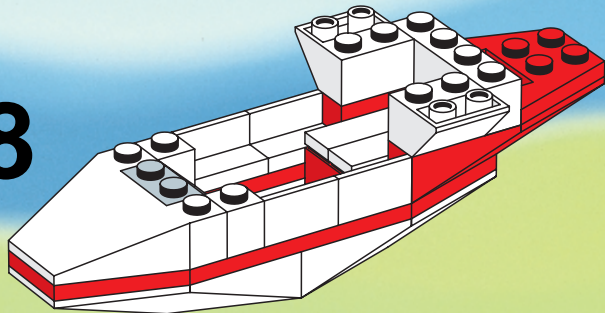

1

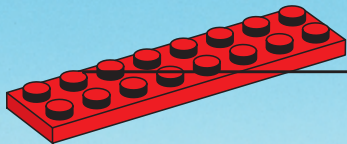

2

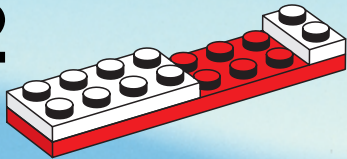

3

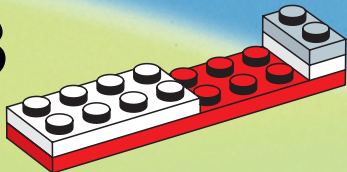

4

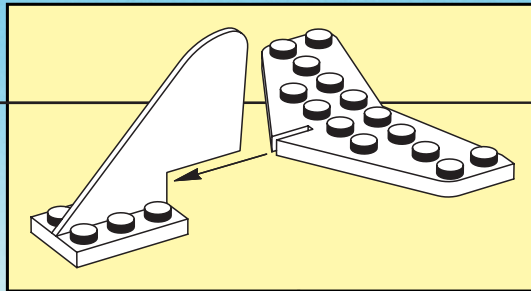
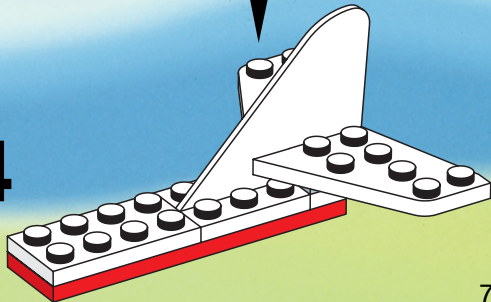

9

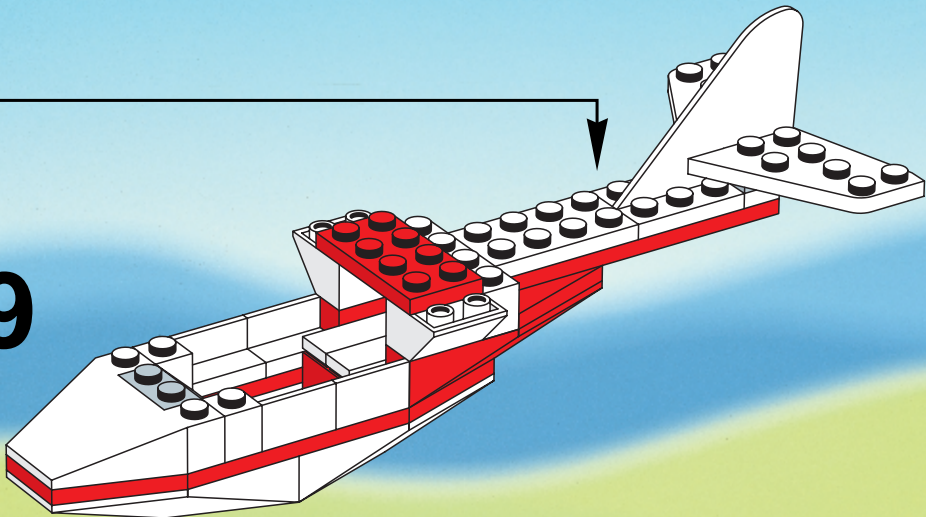

10

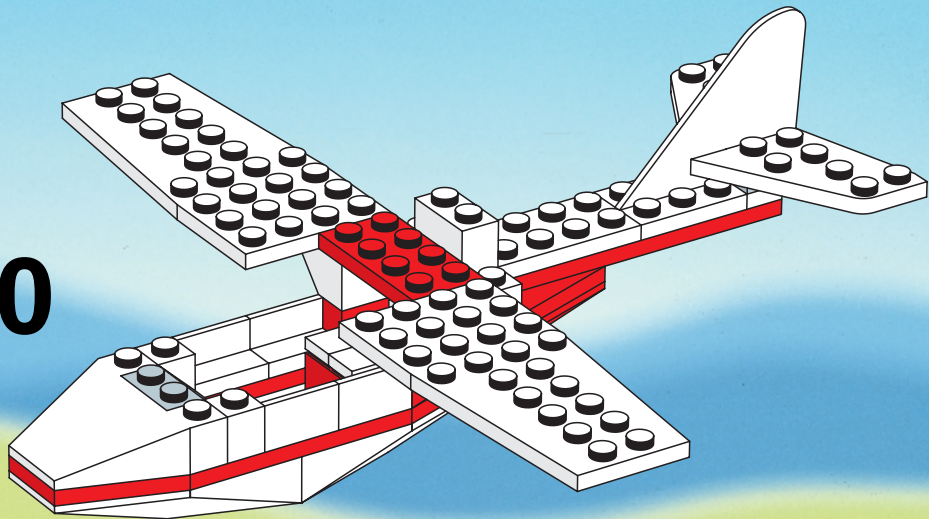

11

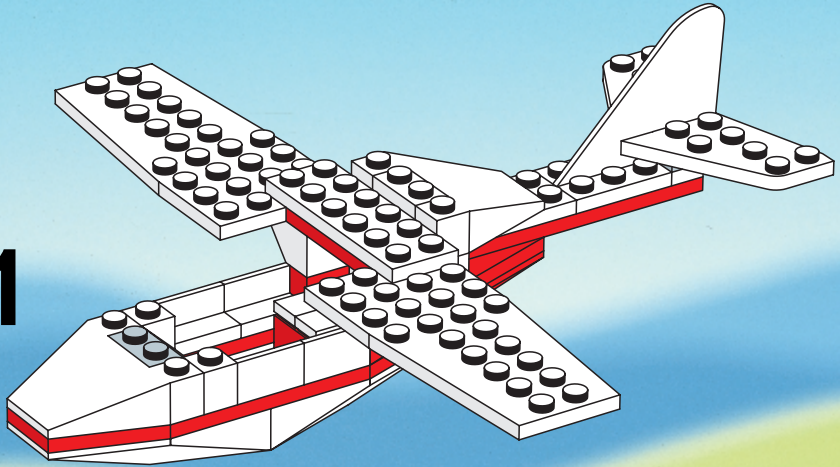

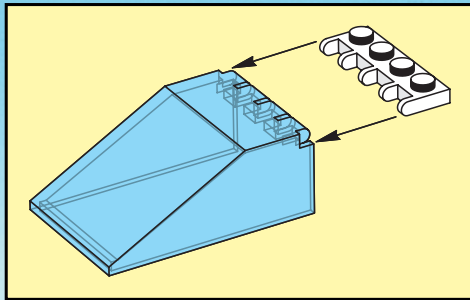

12

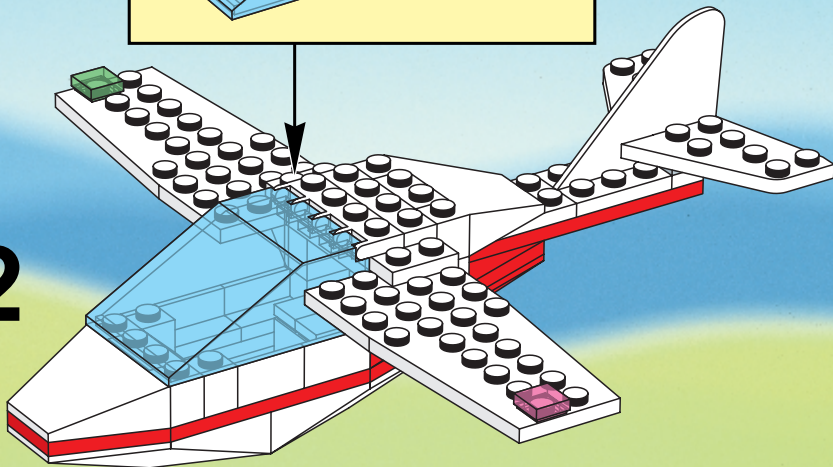

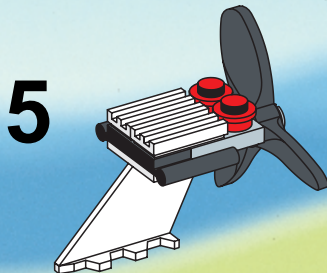
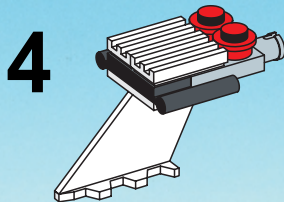
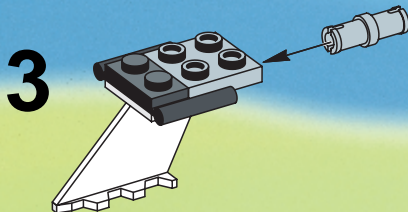
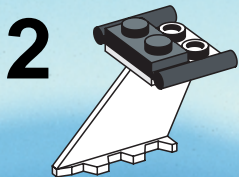
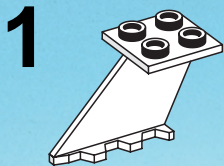

13

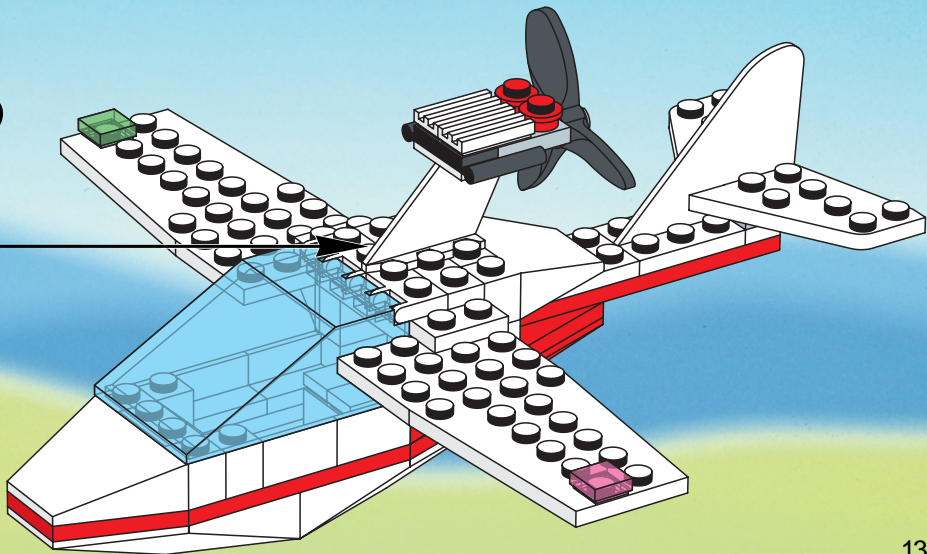

1

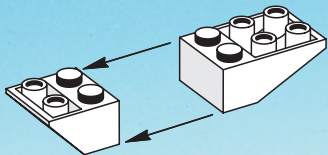

3

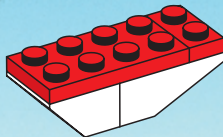

2



4

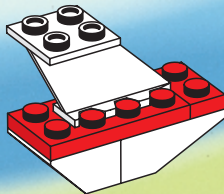

2x

14

