

1

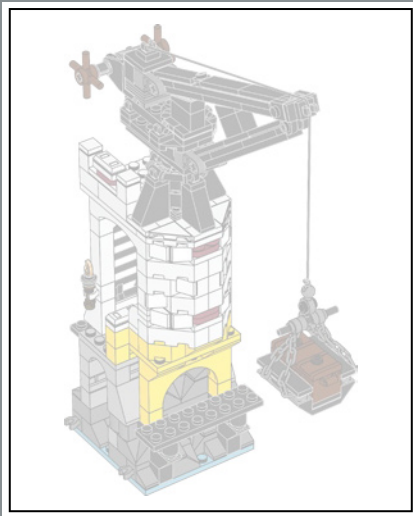

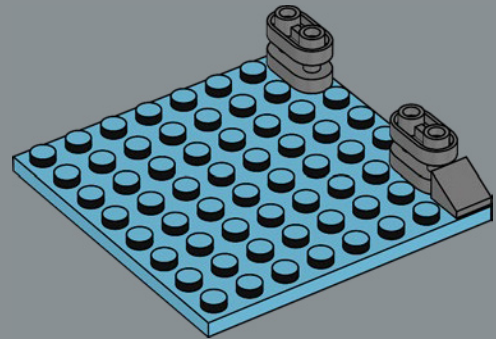

2

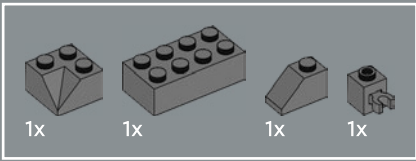
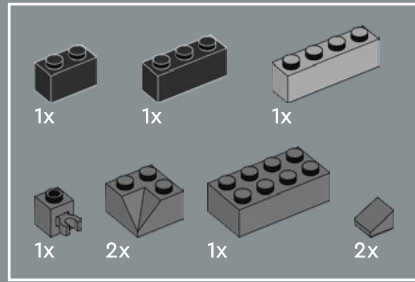
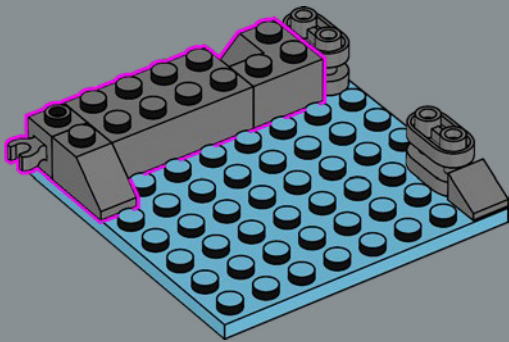

3

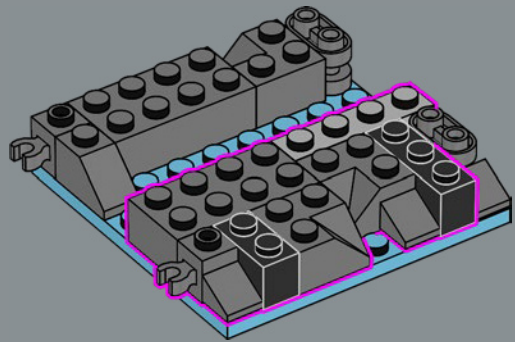



4

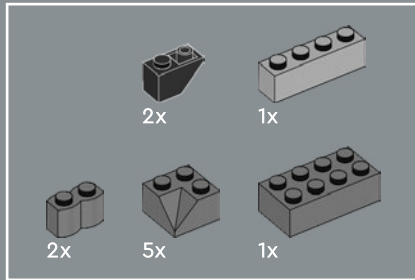
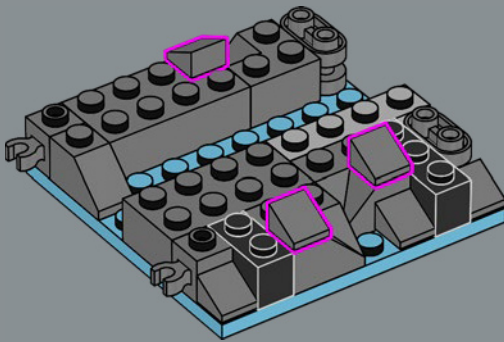

5

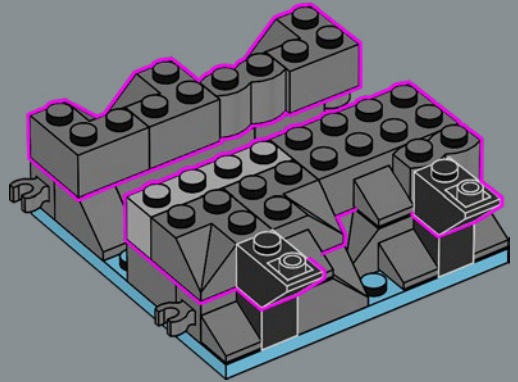



6

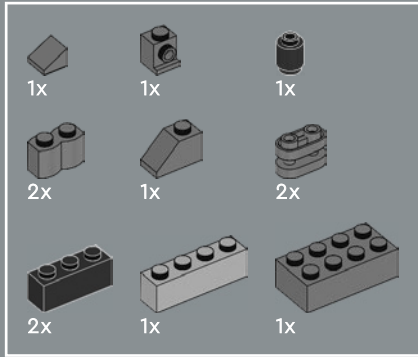
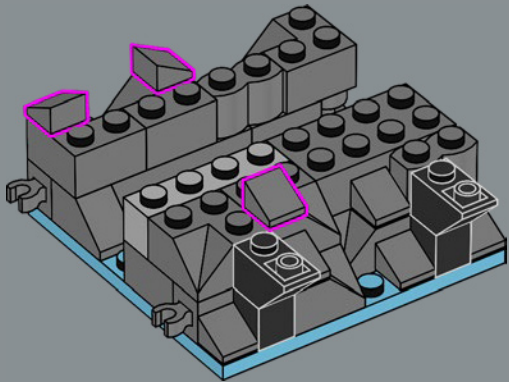

7

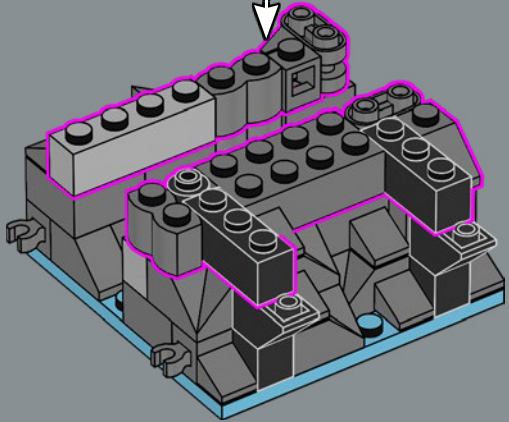
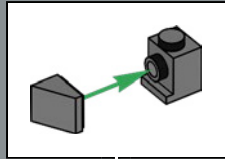

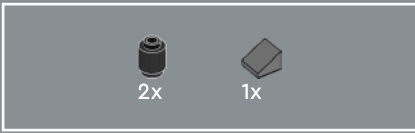

8

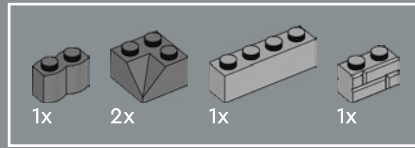
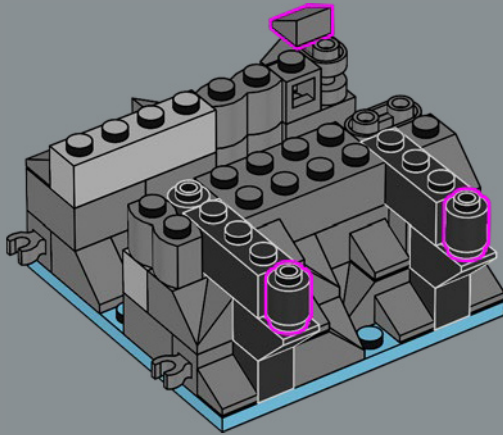

9

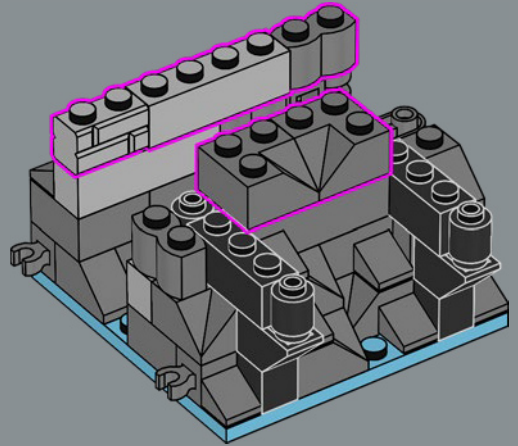

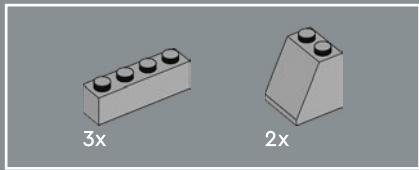

10

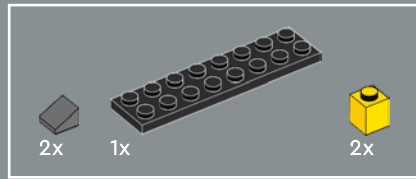
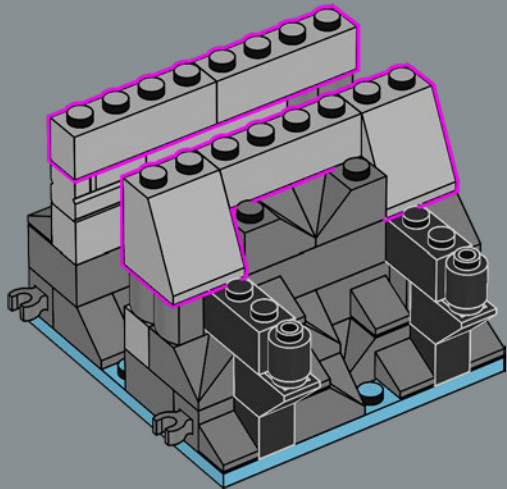

11

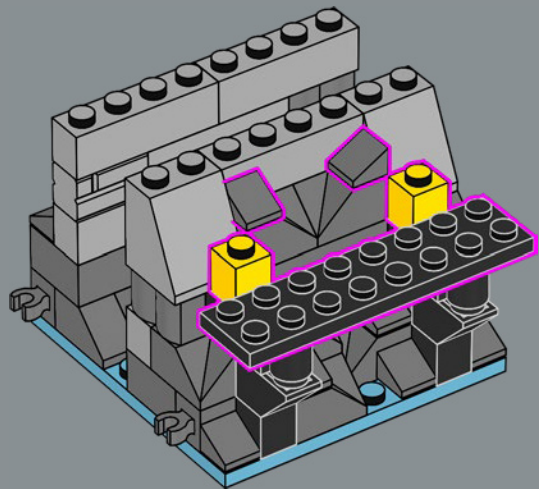

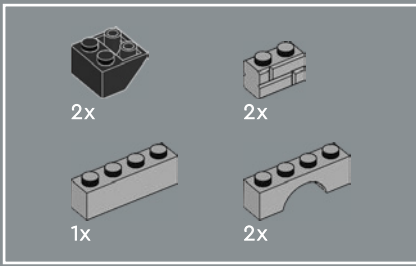

12

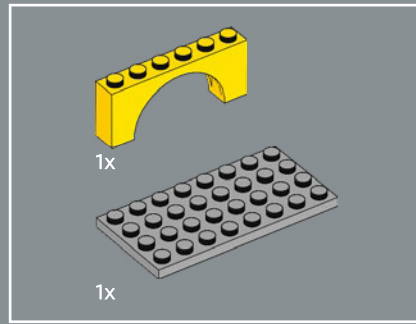
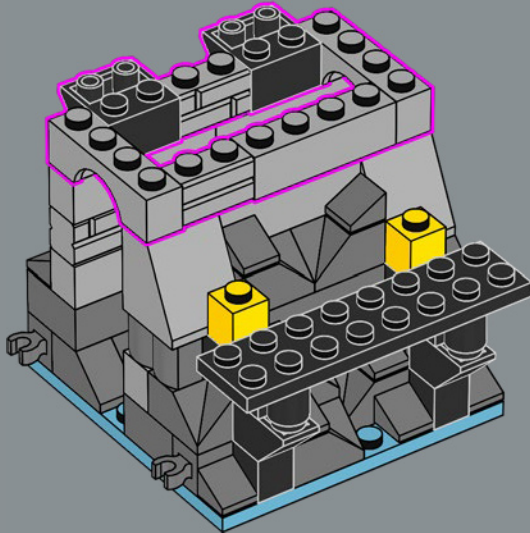

13

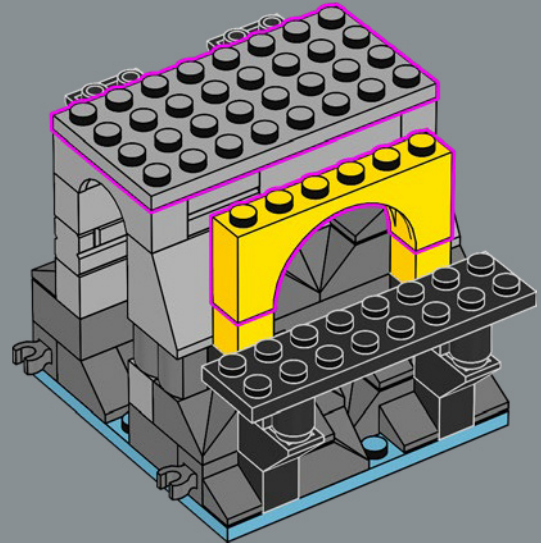

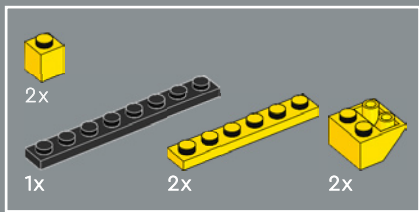

14

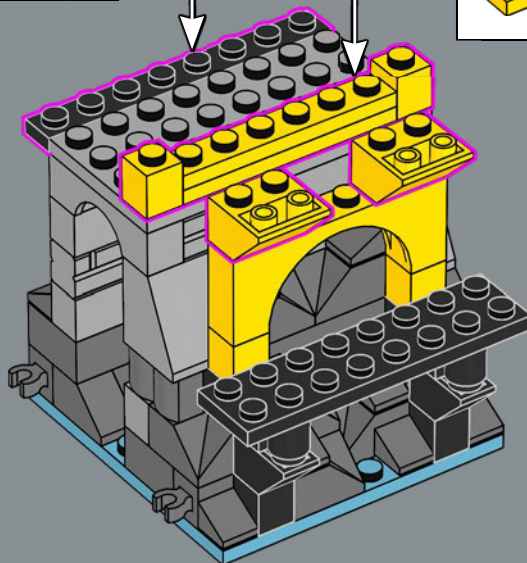
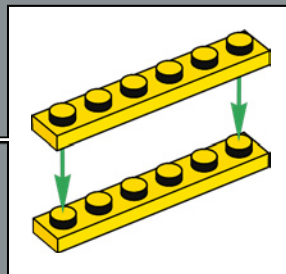
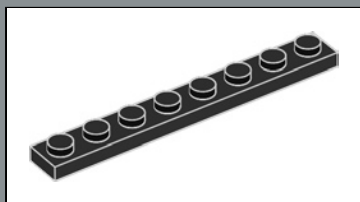

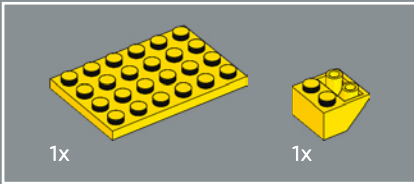
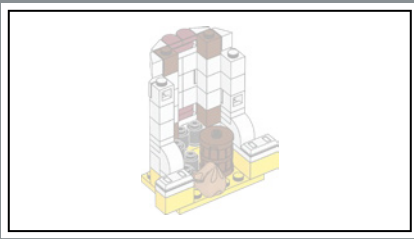

1x

1x

15

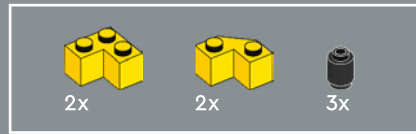
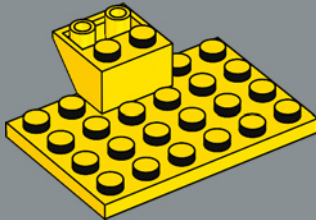

2x

2x

3x

16

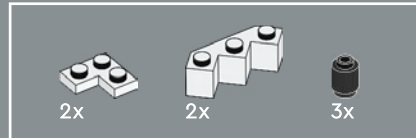
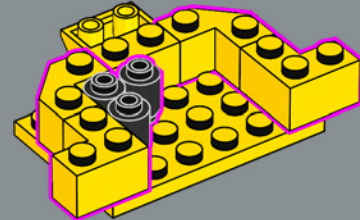

2x

2x

3x

17

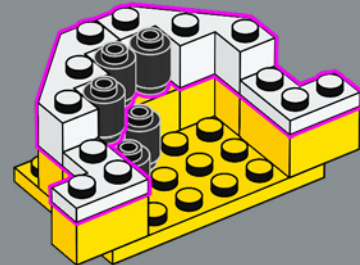

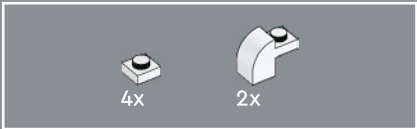

18

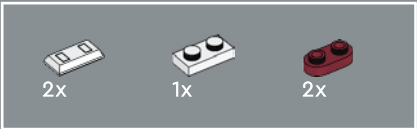
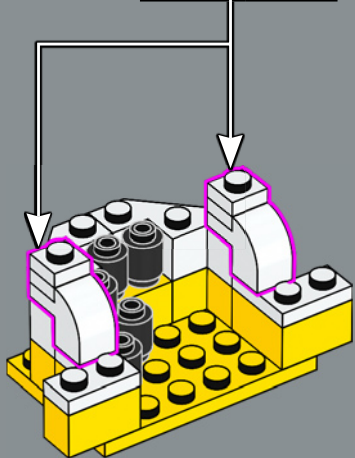
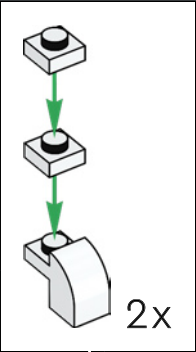

19

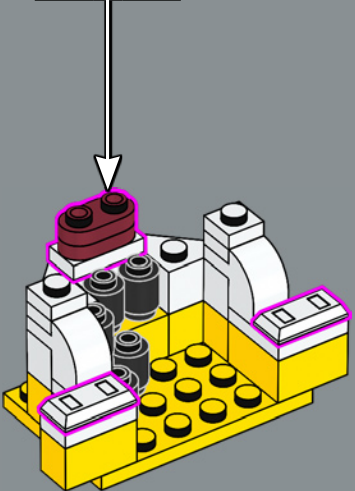
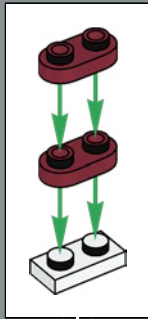

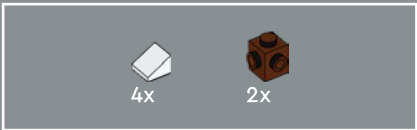

20

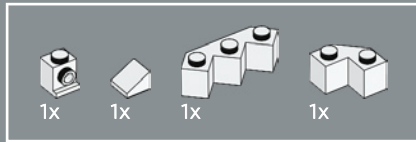
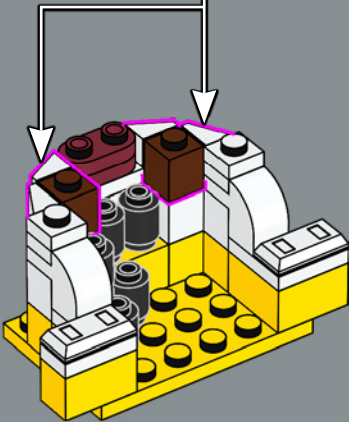
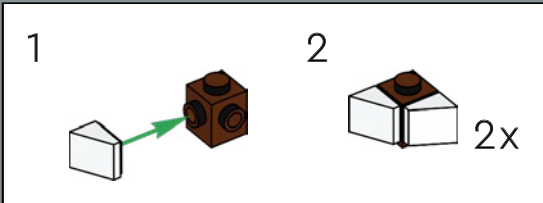

21

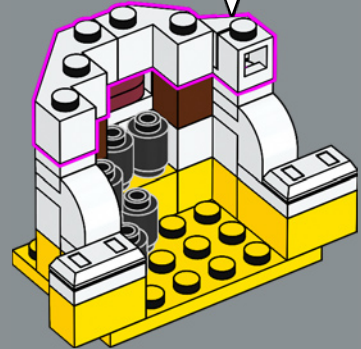
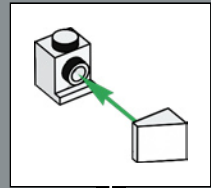

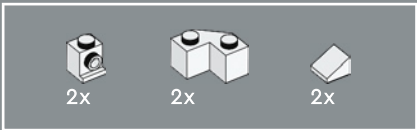

22

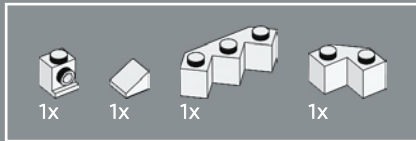
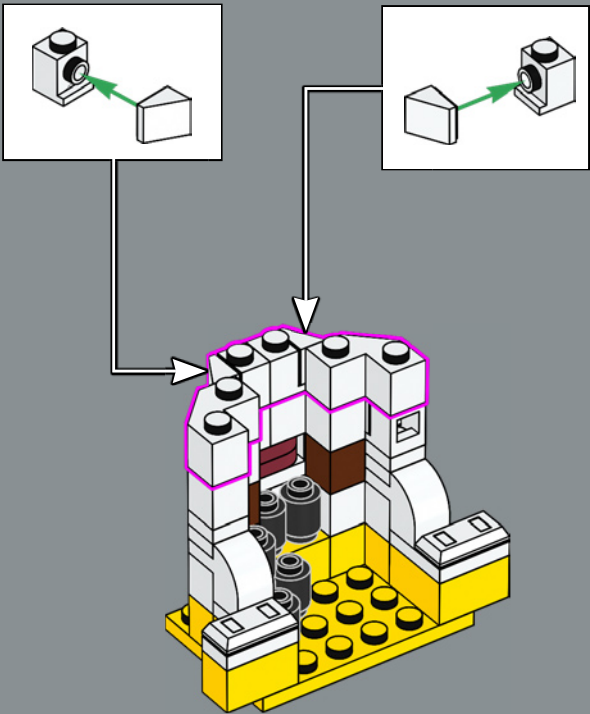

23

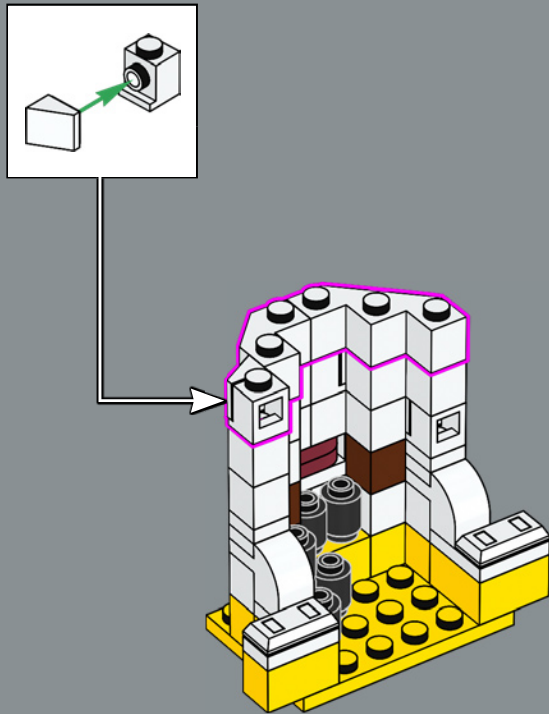



24

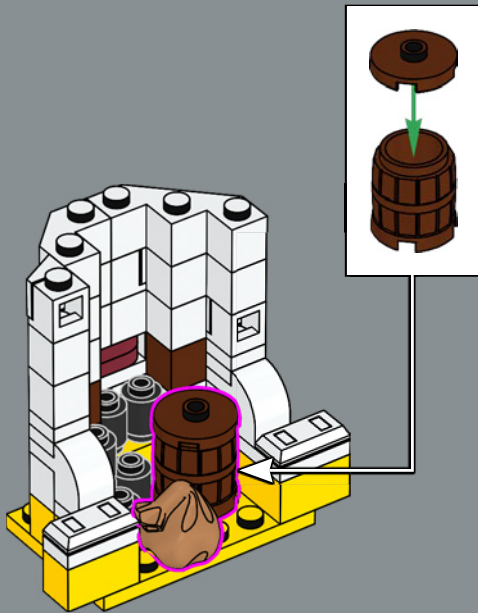

25

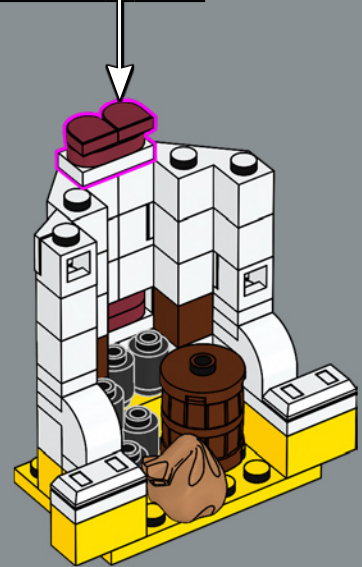
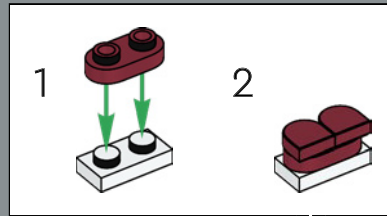

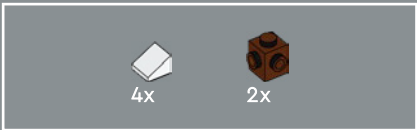

26

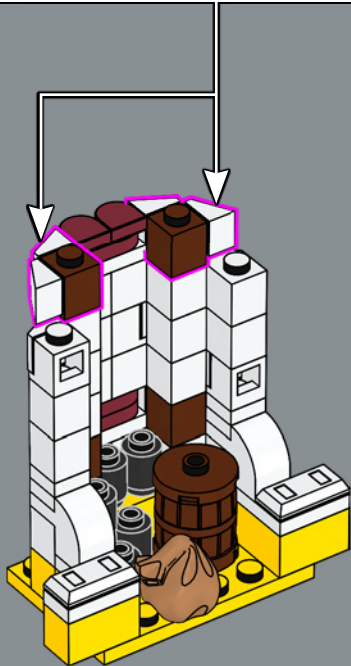
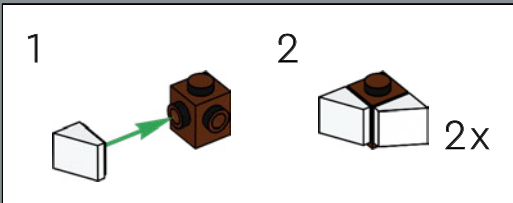

27

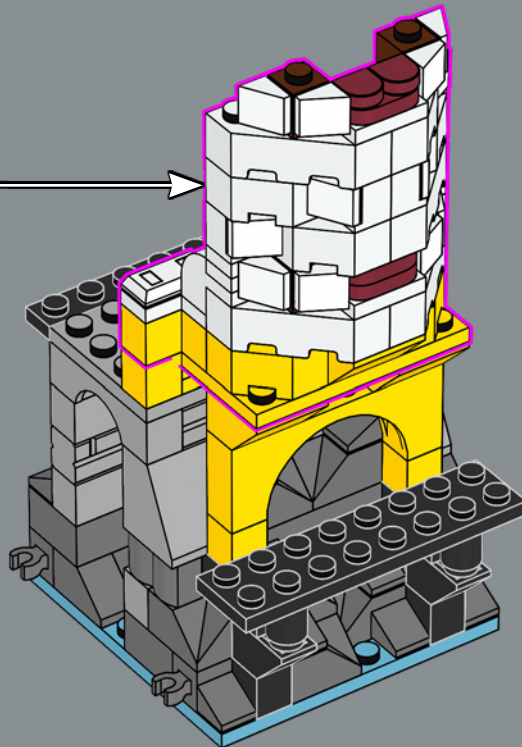

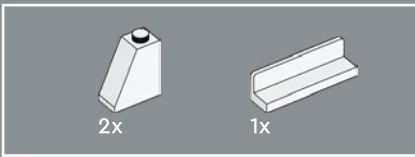

28

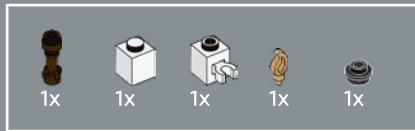
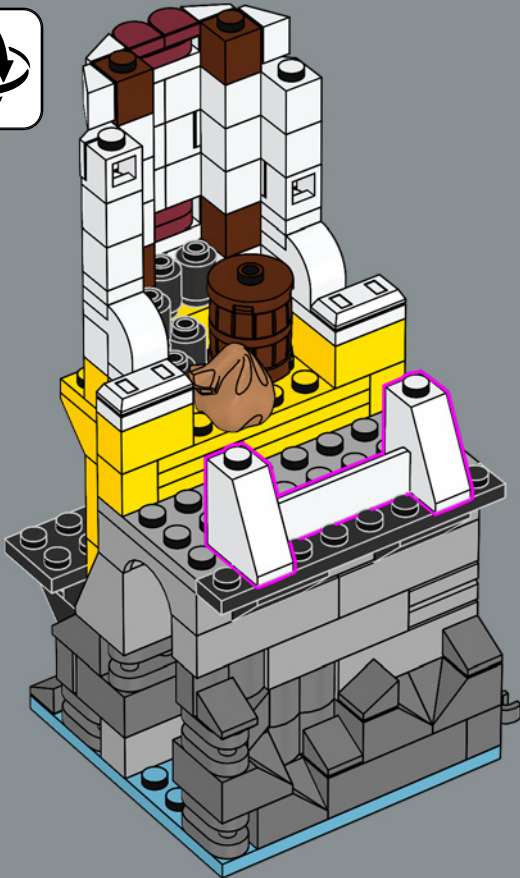

29

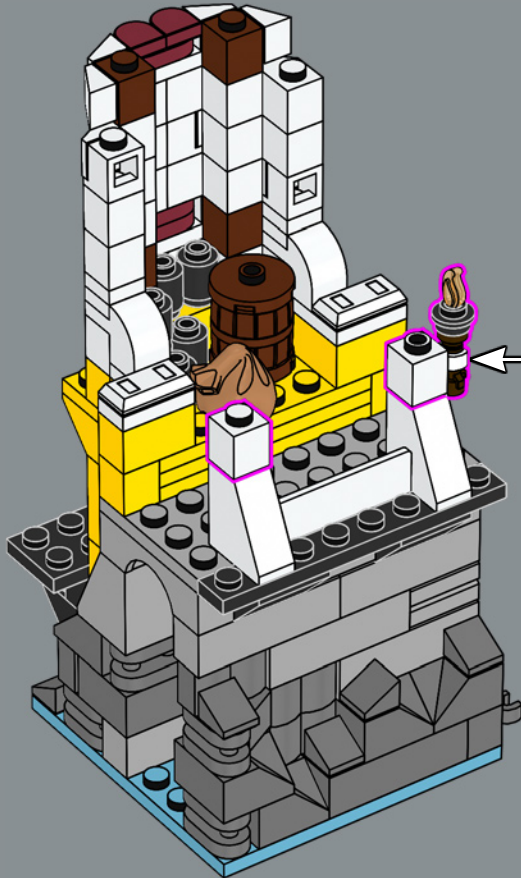



2x

30

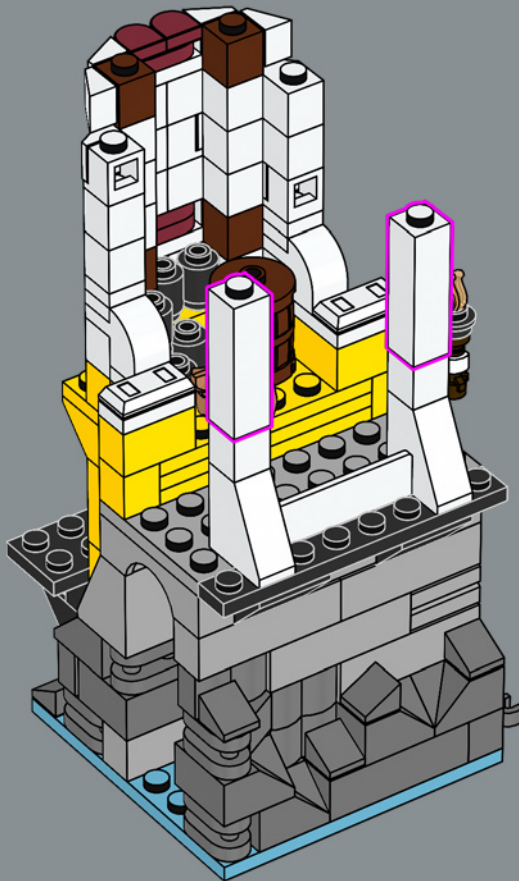

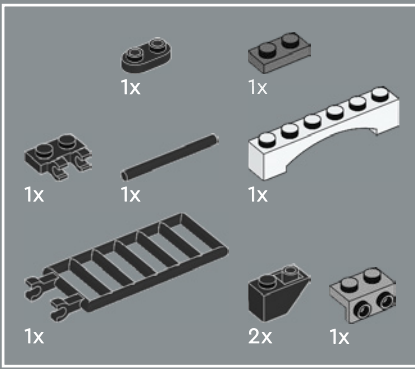

31

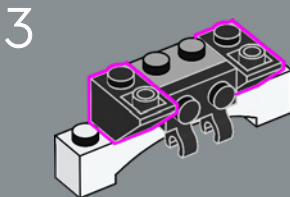
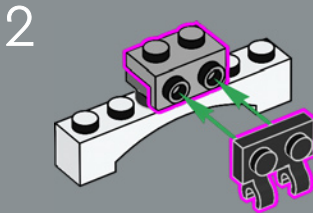
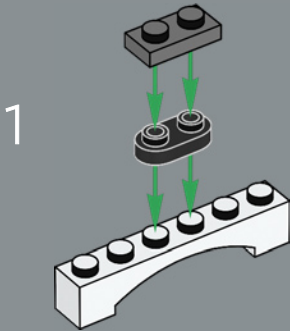

4

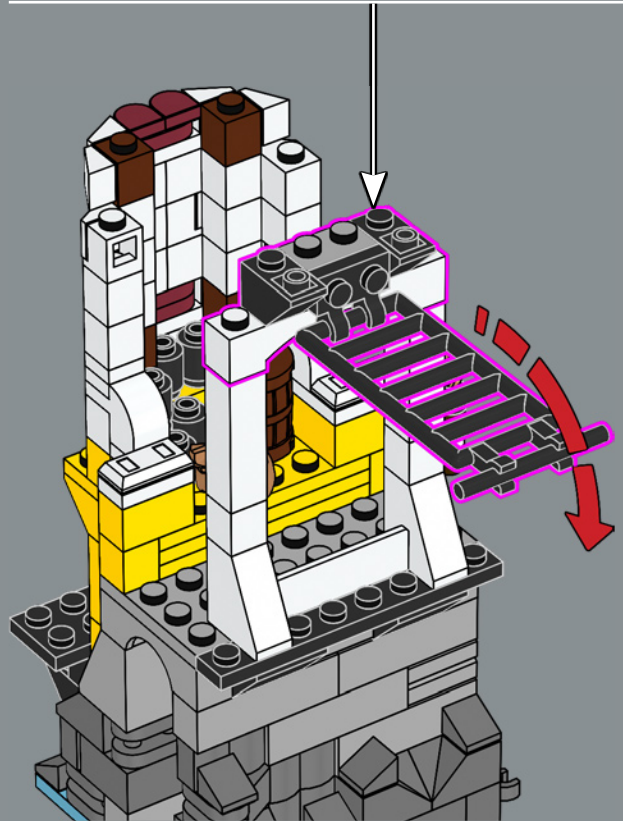
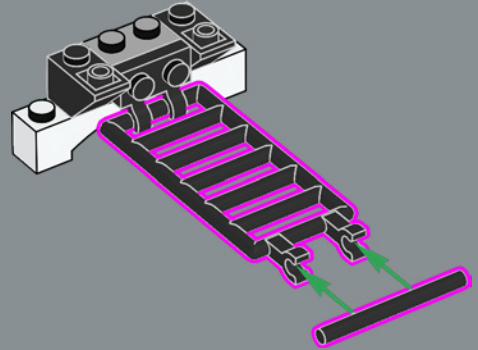

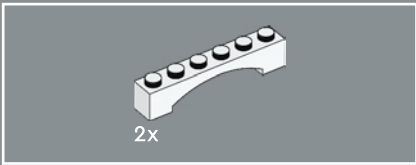

32

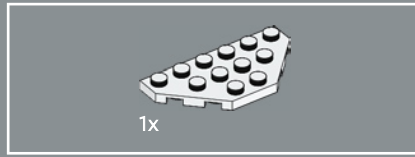
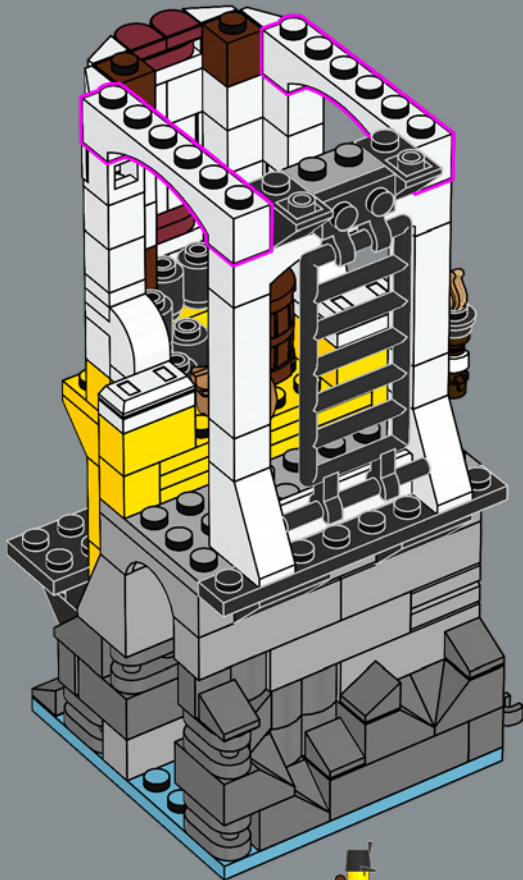

33

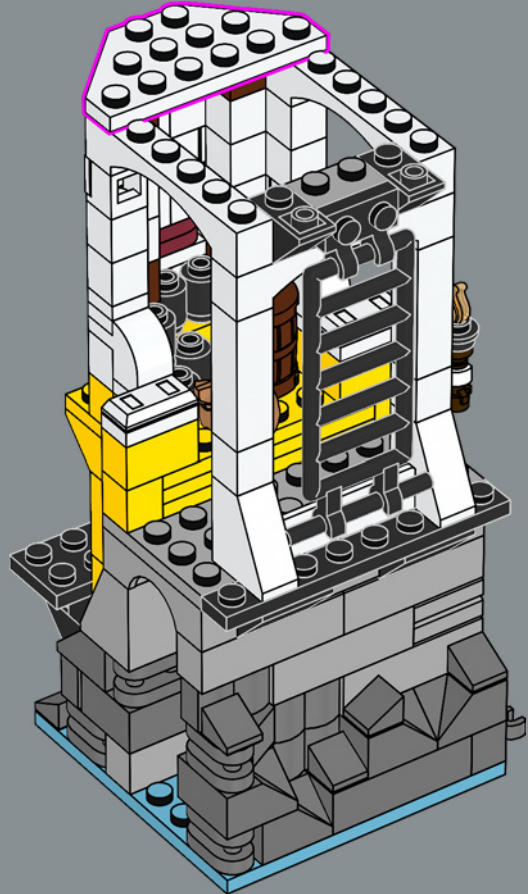

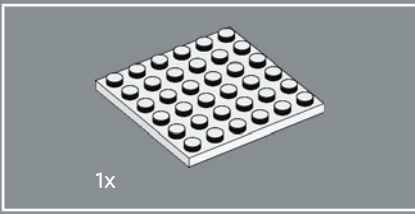

34

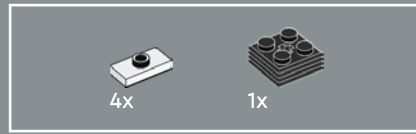
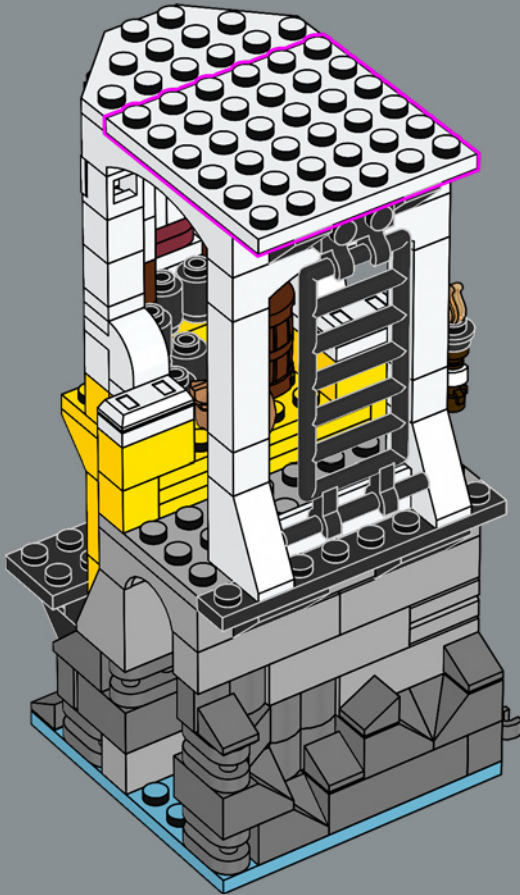

35

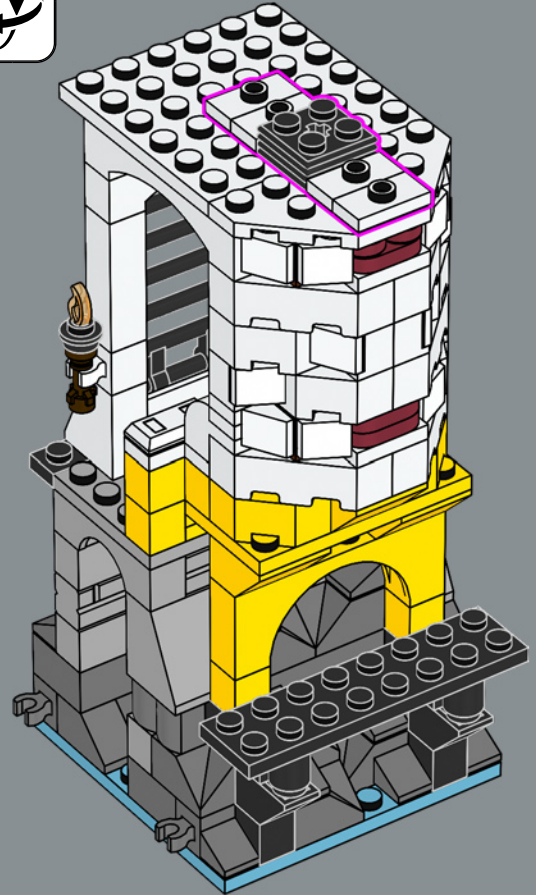

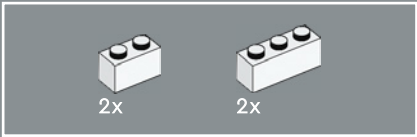

36

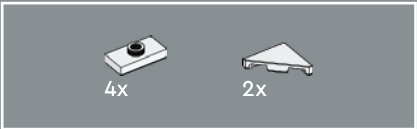
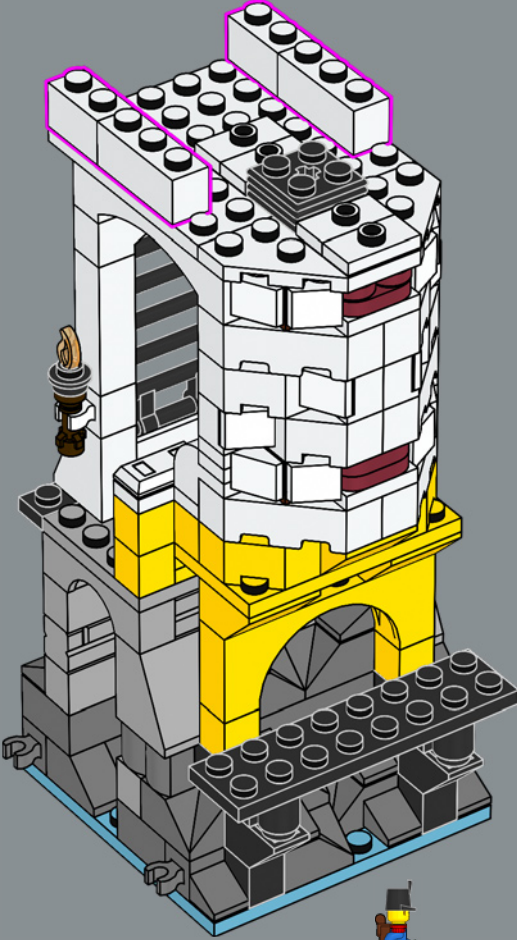

37

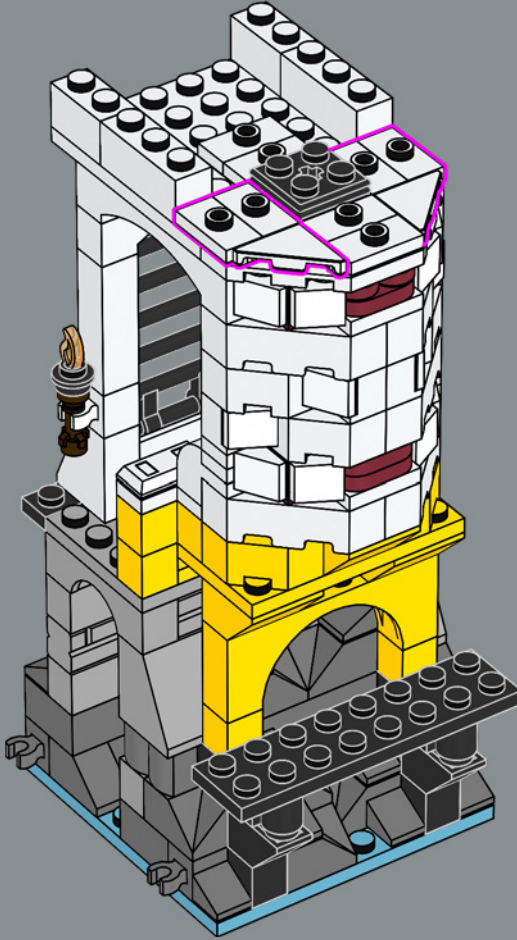

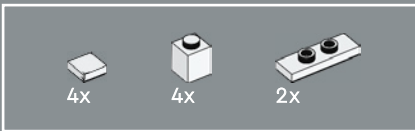

38

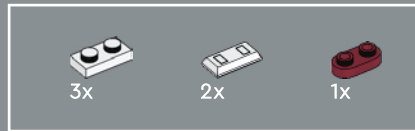
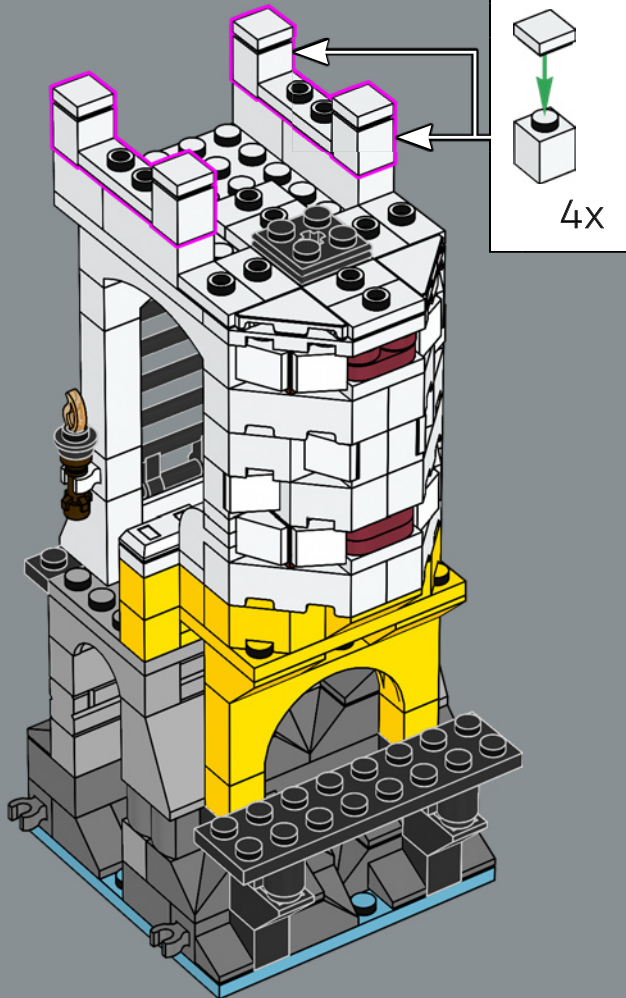

39

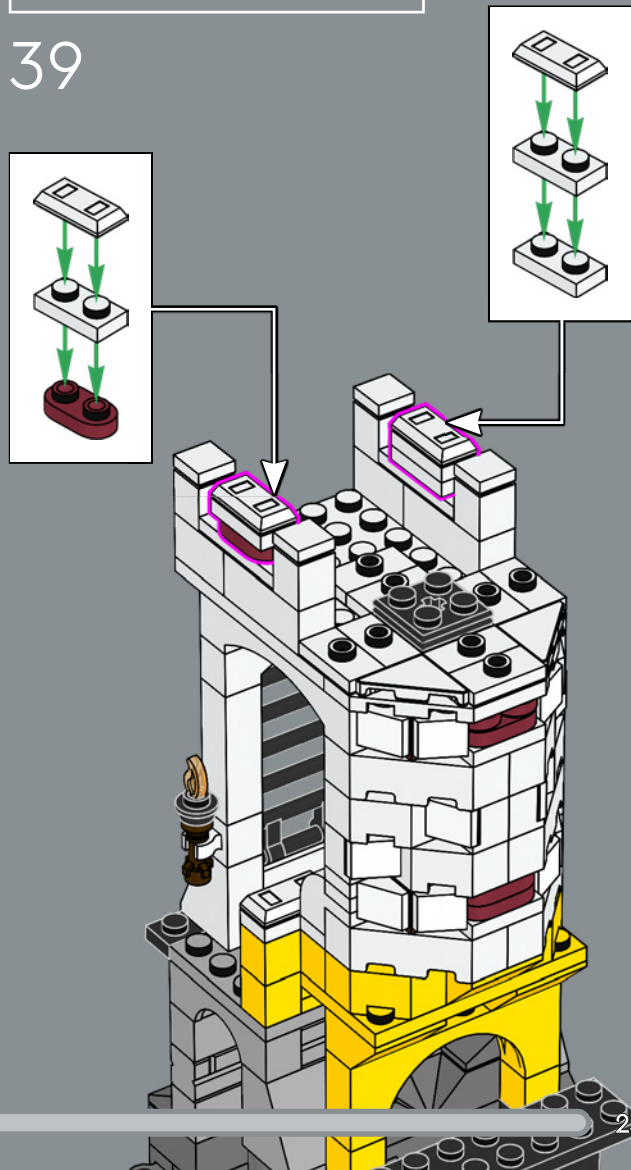

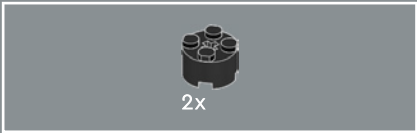

40

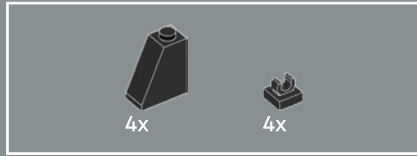
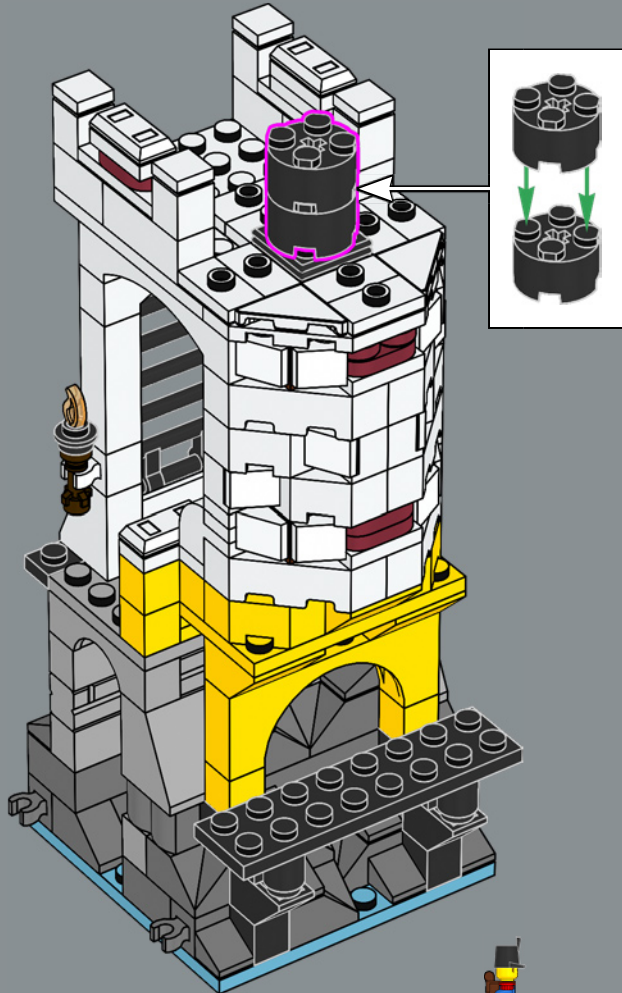

41

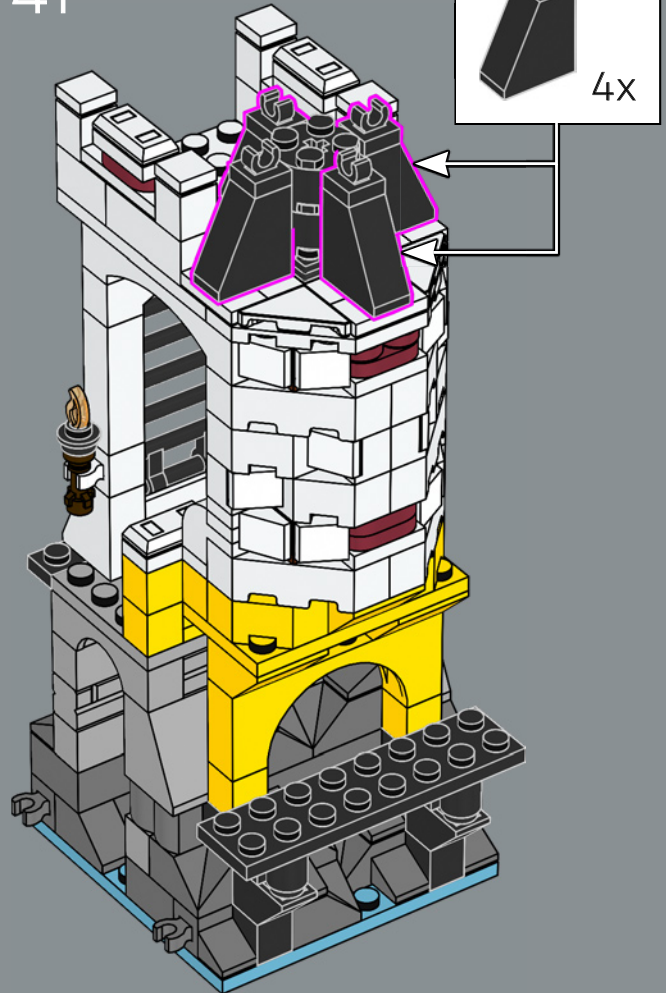



42

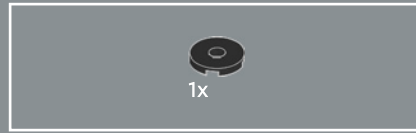
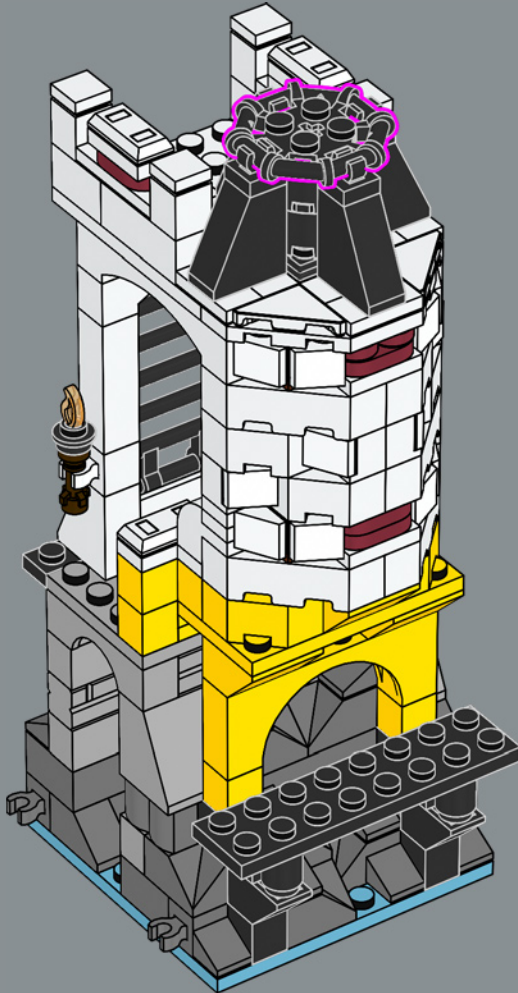

43

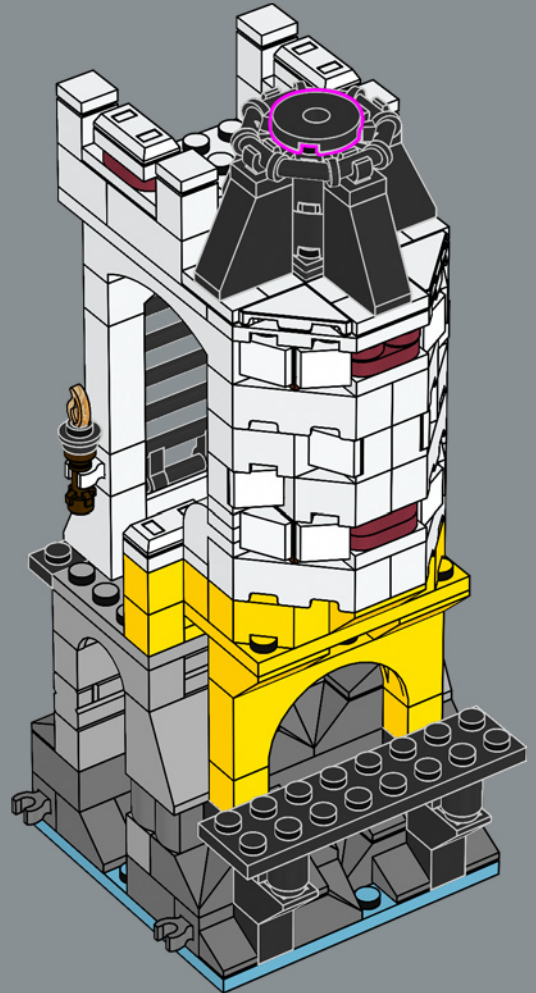

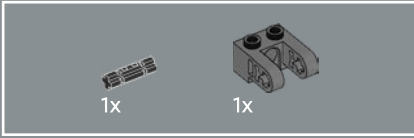
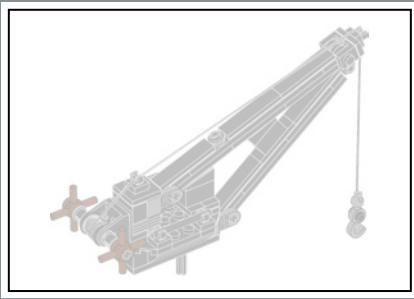

44

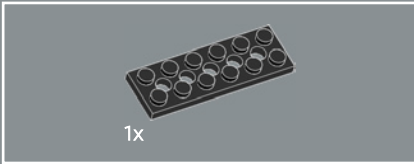
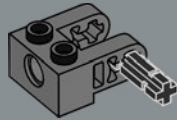

45

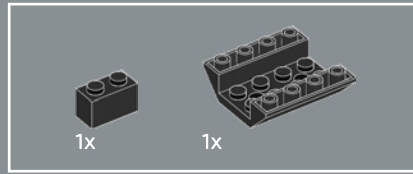
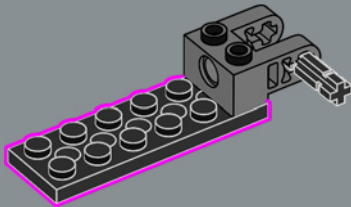

46

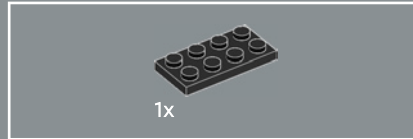
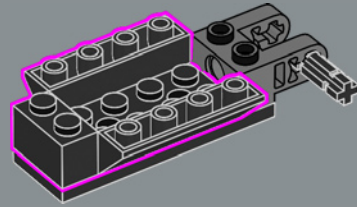

47

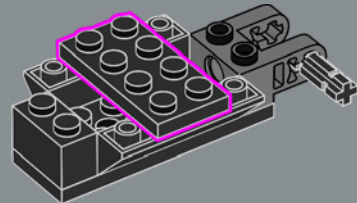

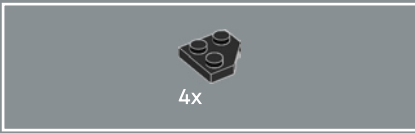

48

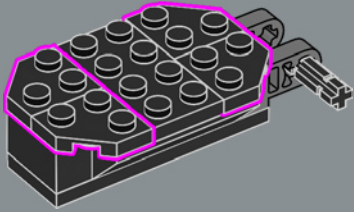

50

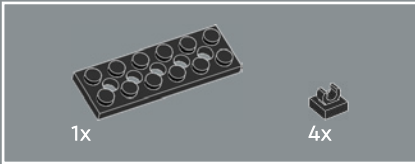
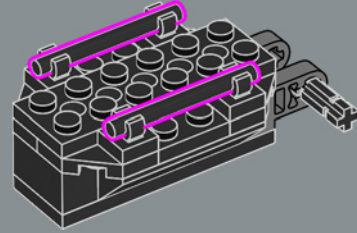

49

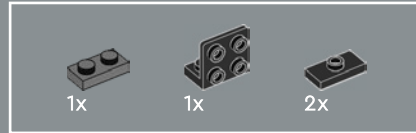
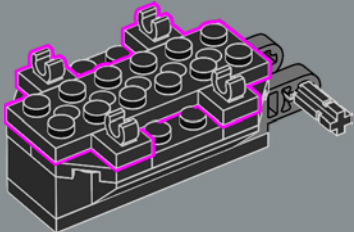

51

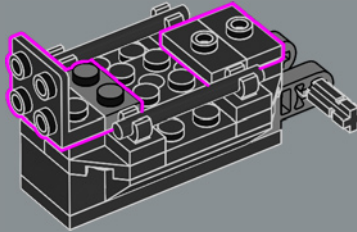

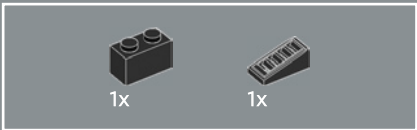

52

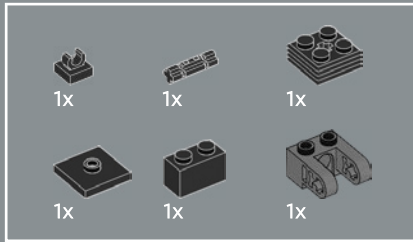
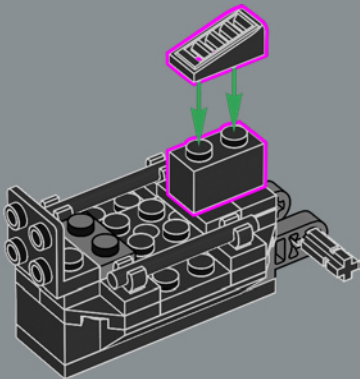

53

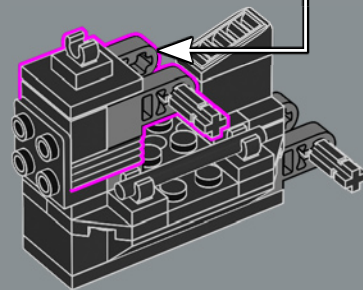
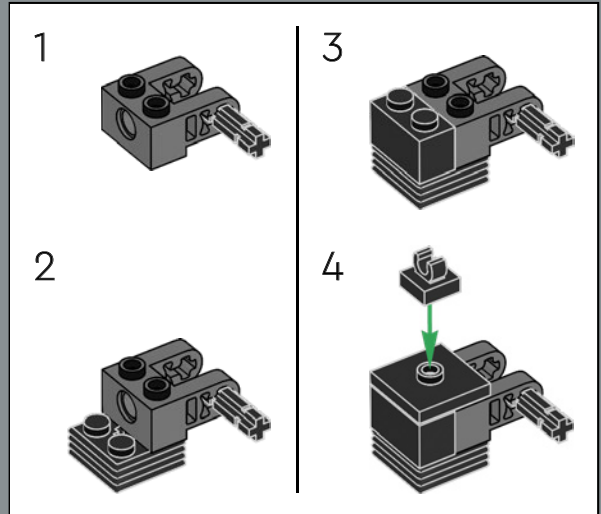

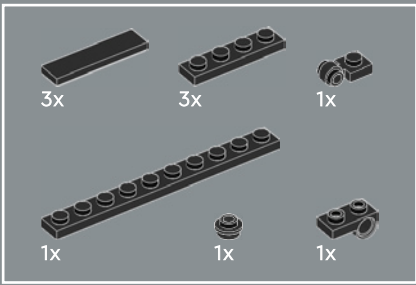

55

1

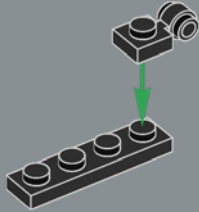

2

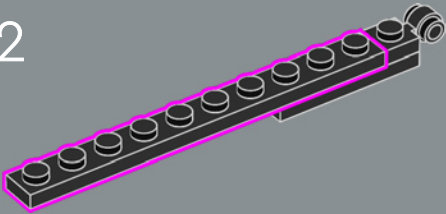

3

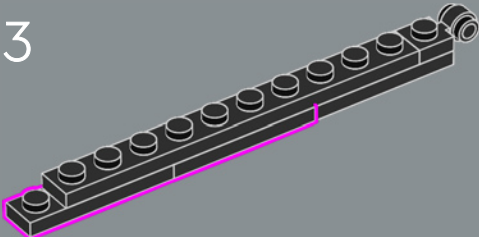

4

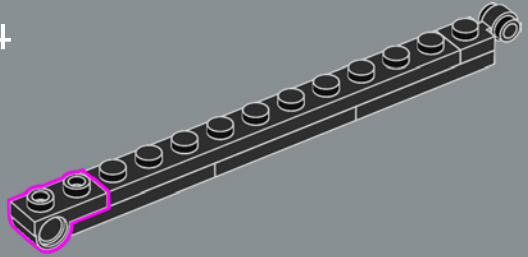

5

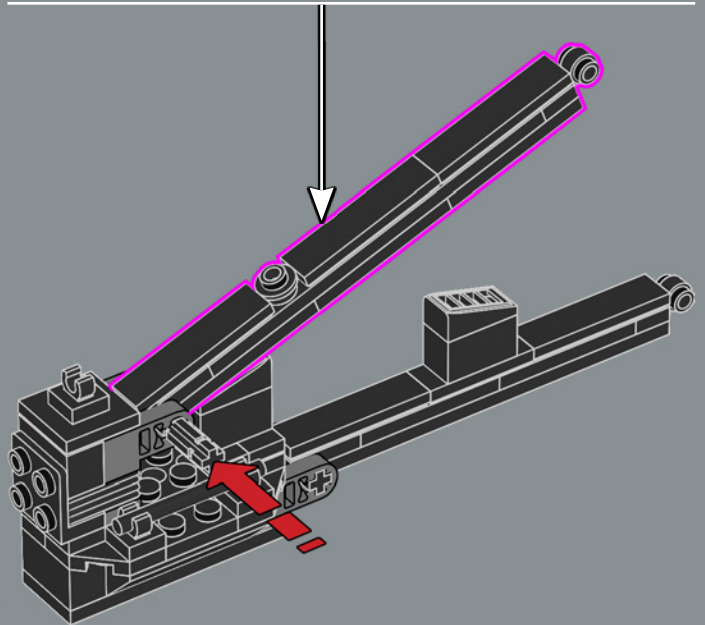
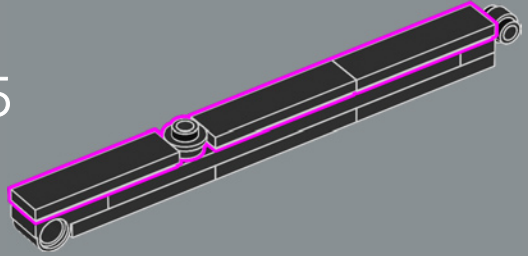



56

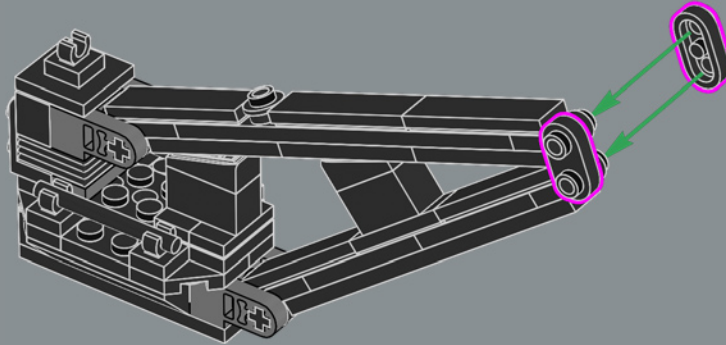

57

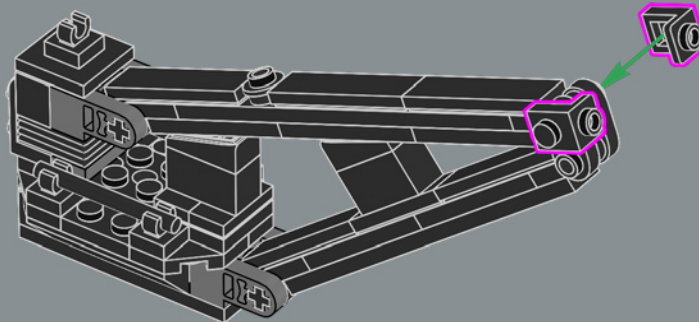

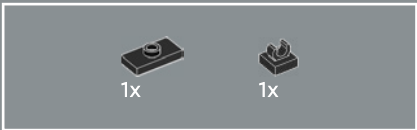

58

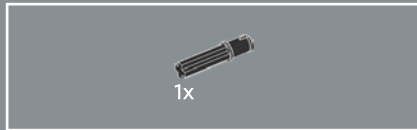
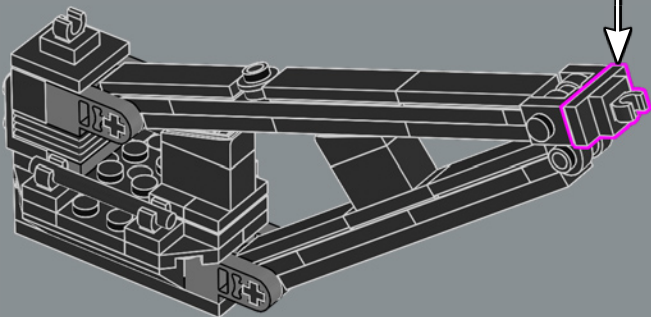
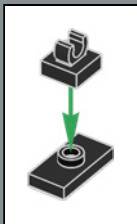

59

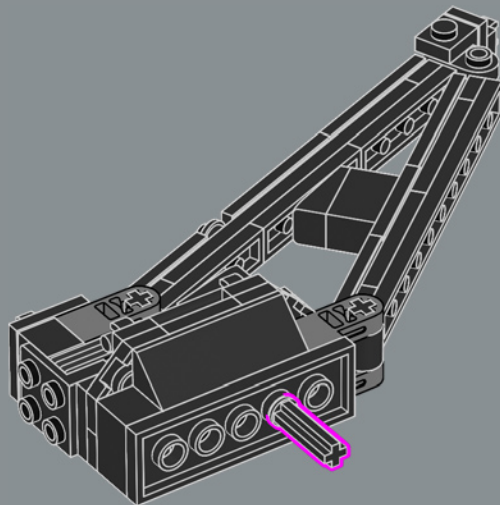

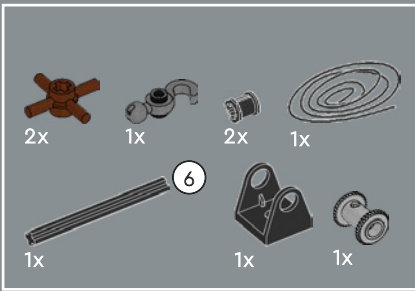

60

1

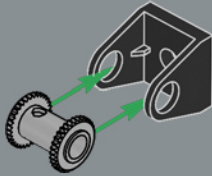

2

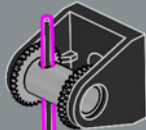

3

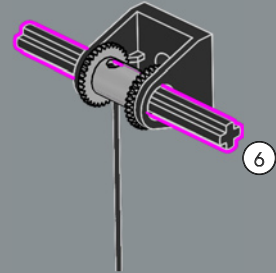

4

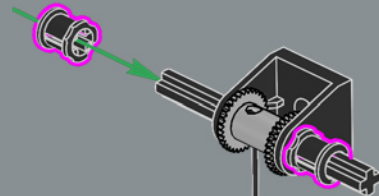

5

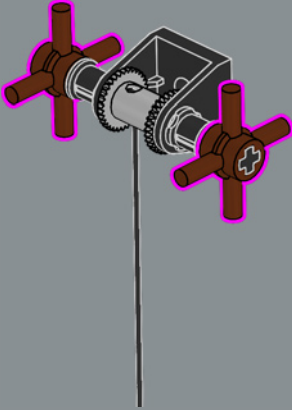

6

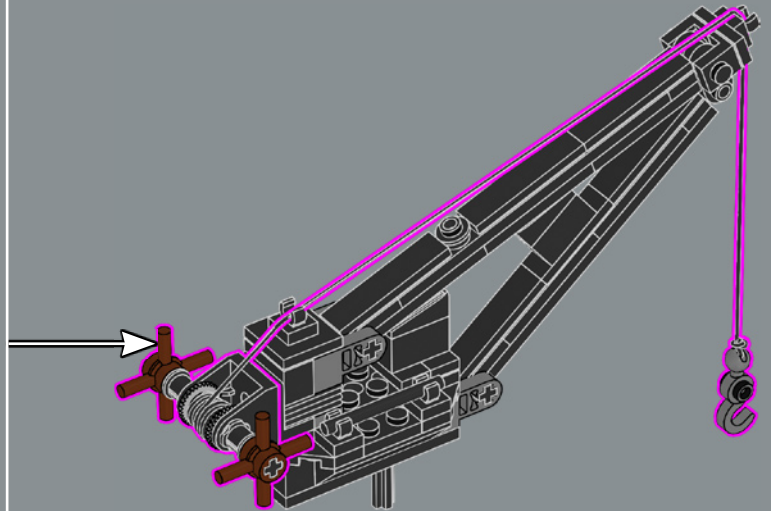
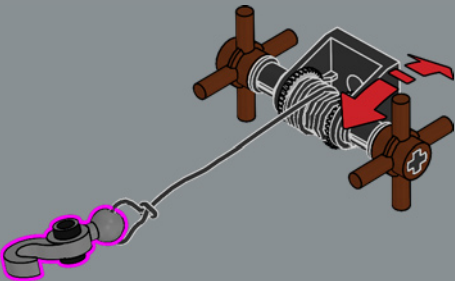



61

Grazie alla gru più grande, il Governatore e i suoi soldati possono movimentare carichi ancora più pesanti.

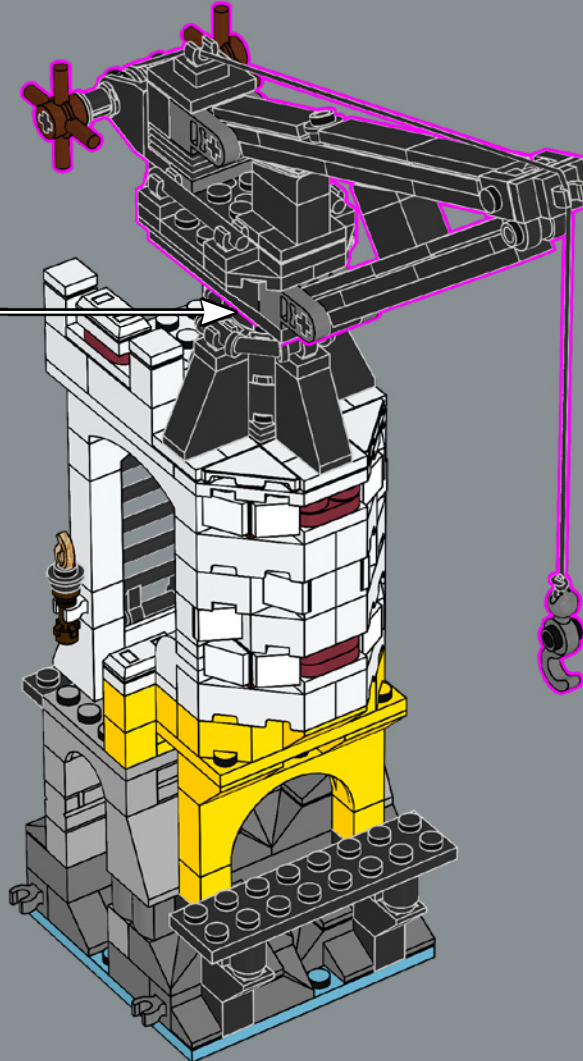

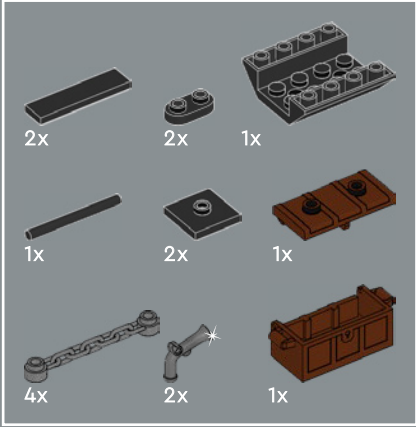
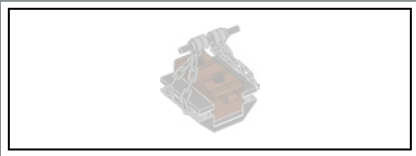

62

1

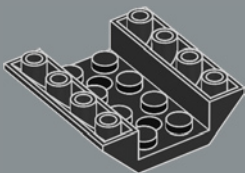

2

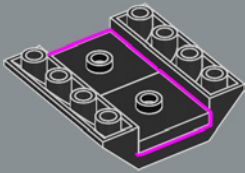

3

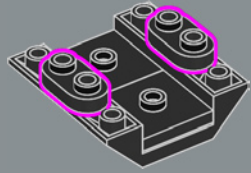

4

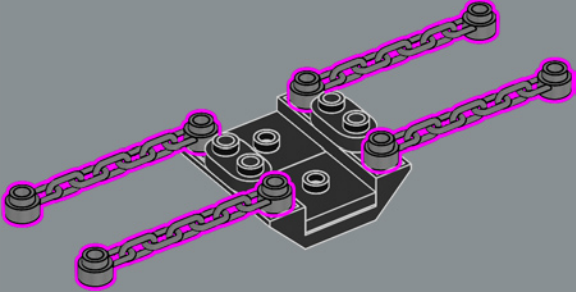

5

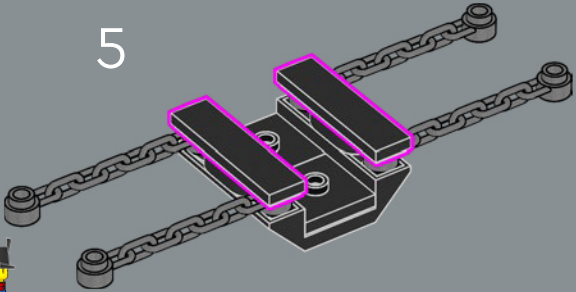

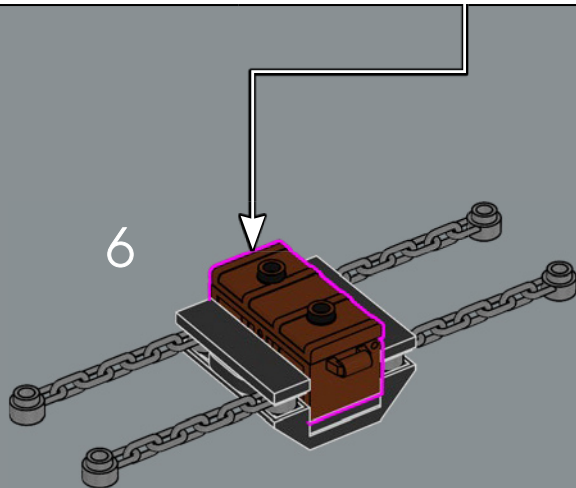
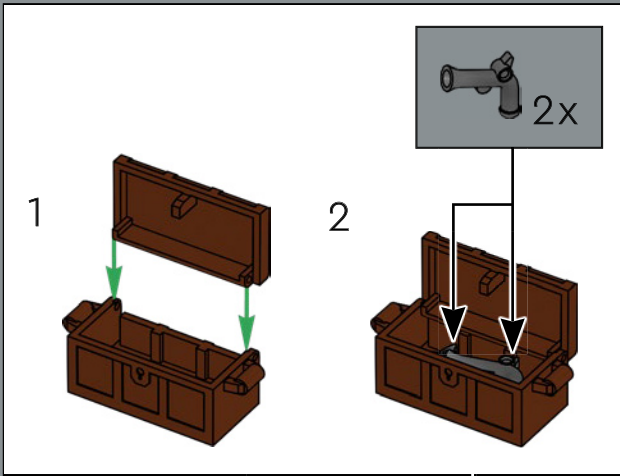

7

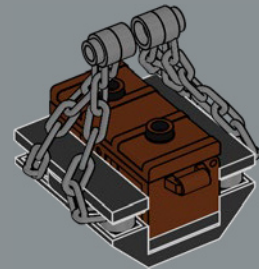

8

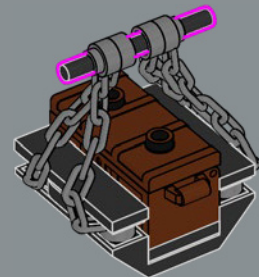

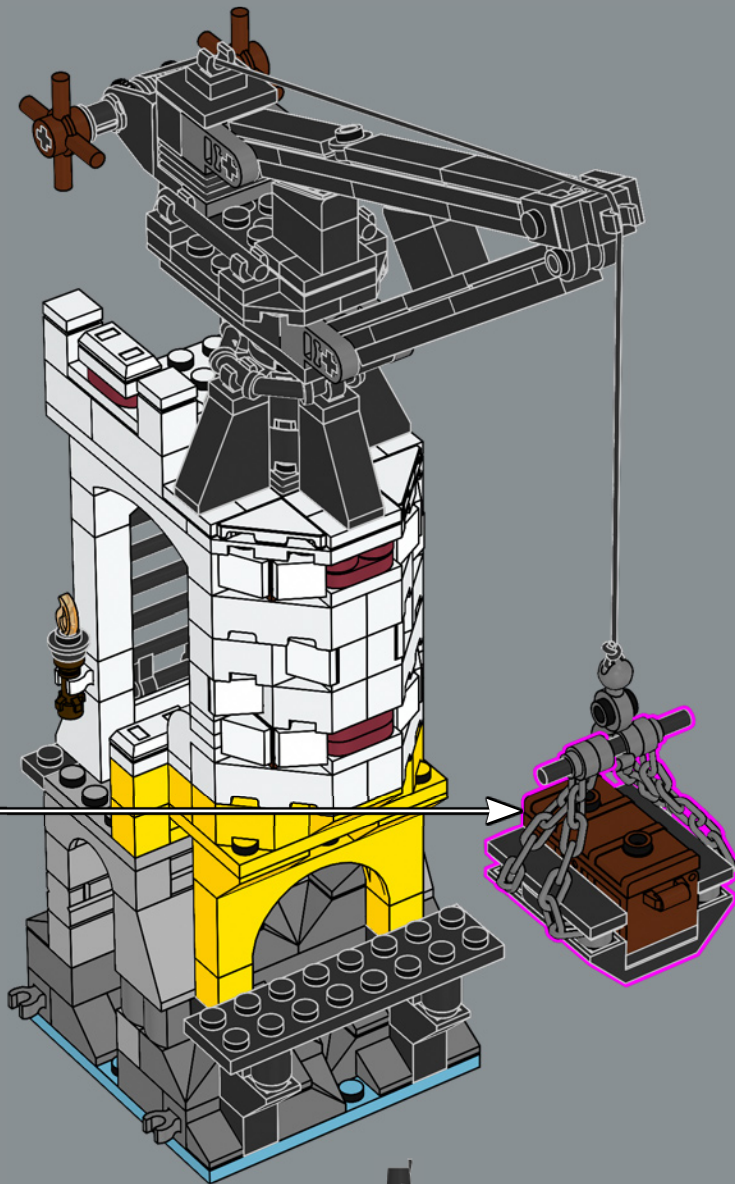

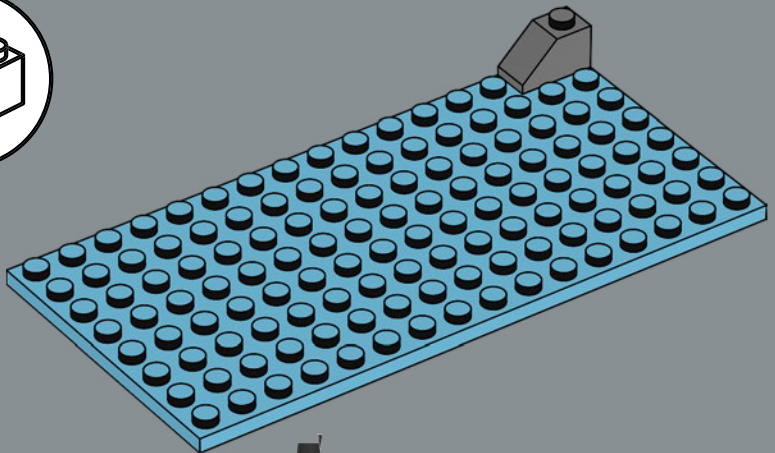
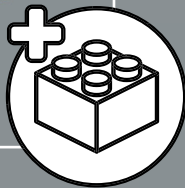
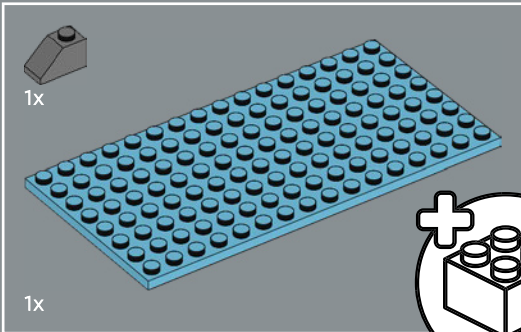
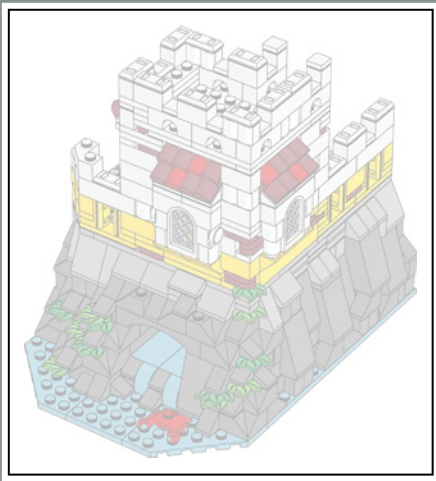

1



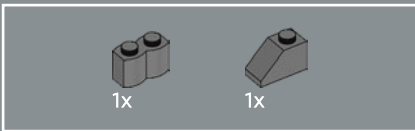

2

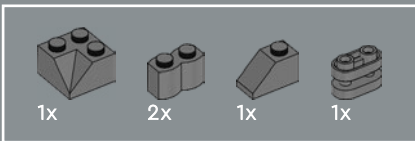
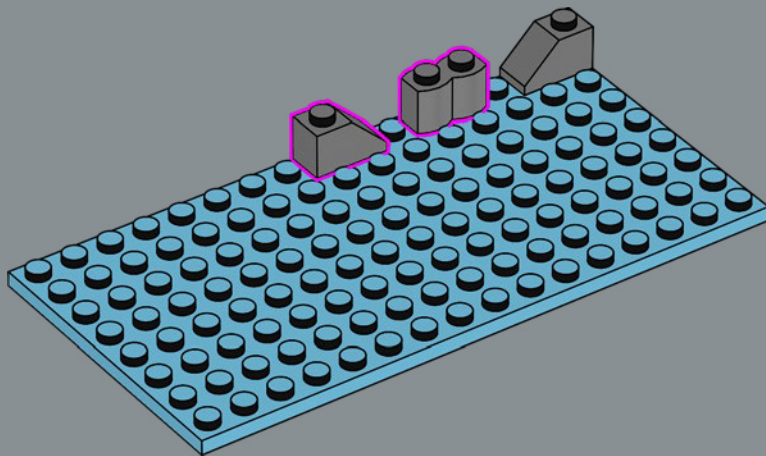

3

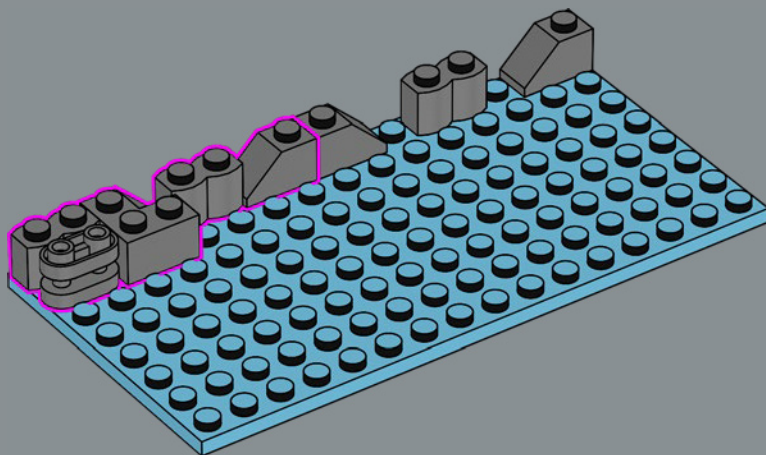

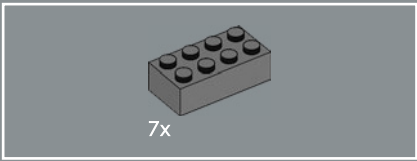

4

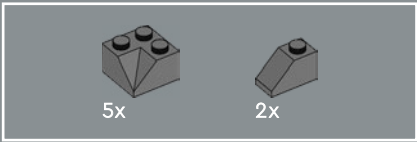
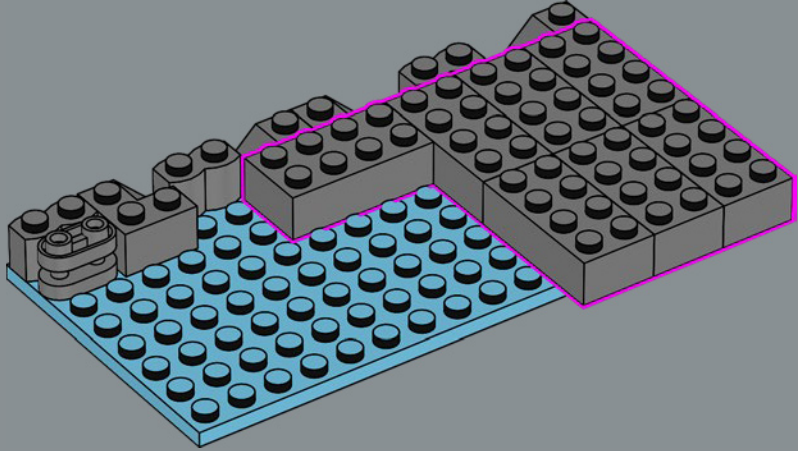

5

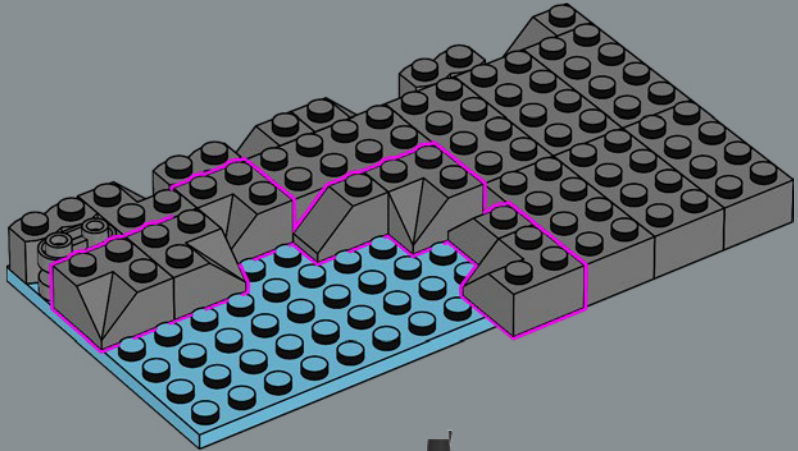

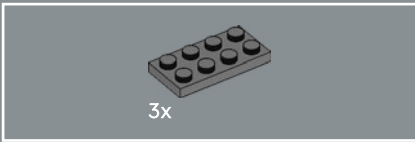

6

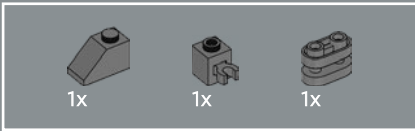
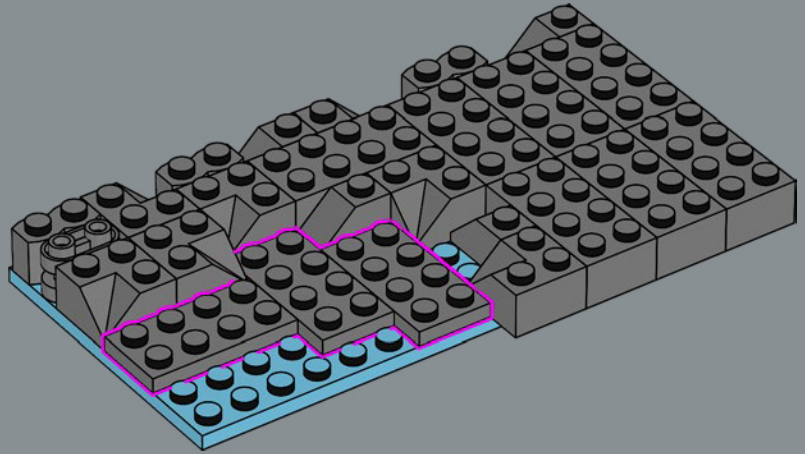

7

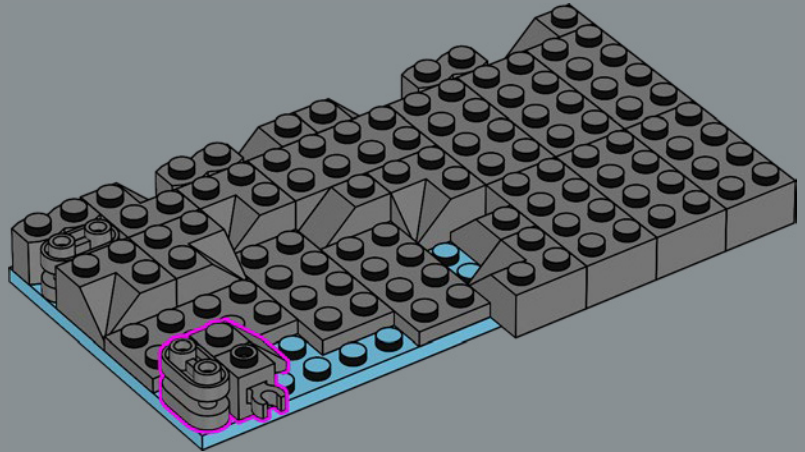

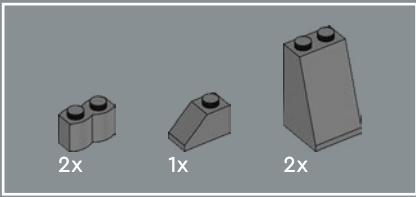

8

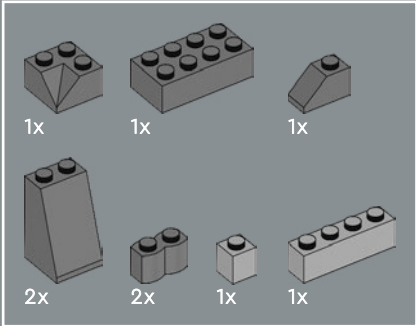
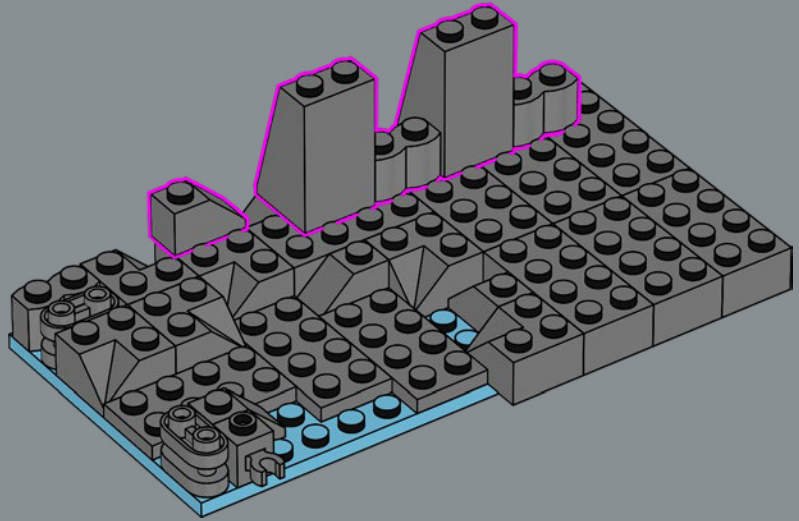

9

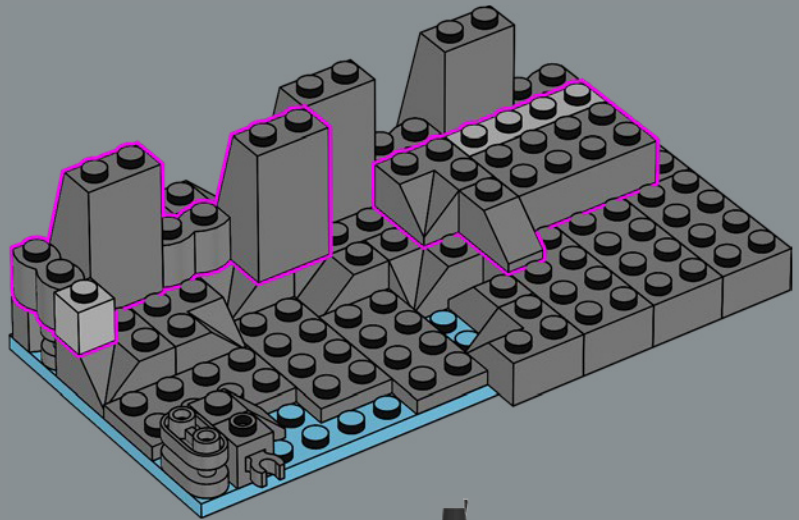

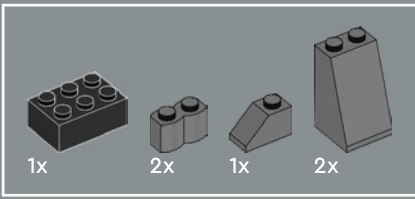

10

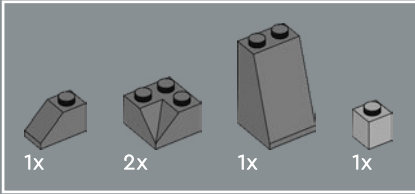
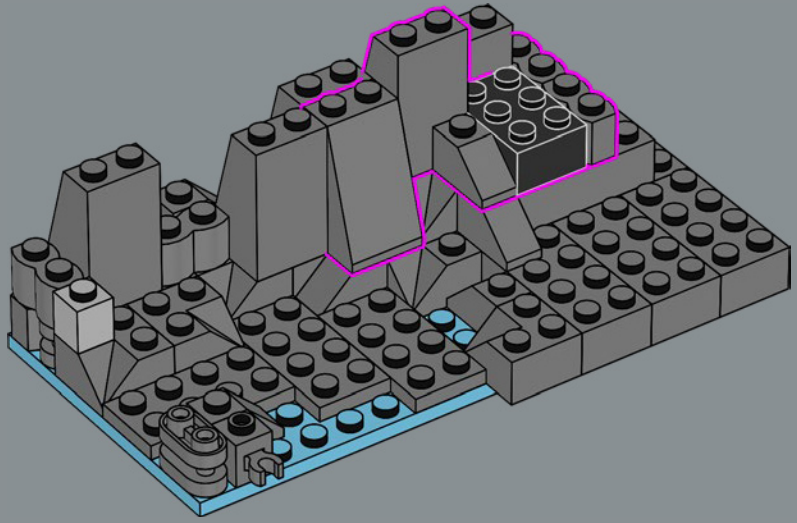

11

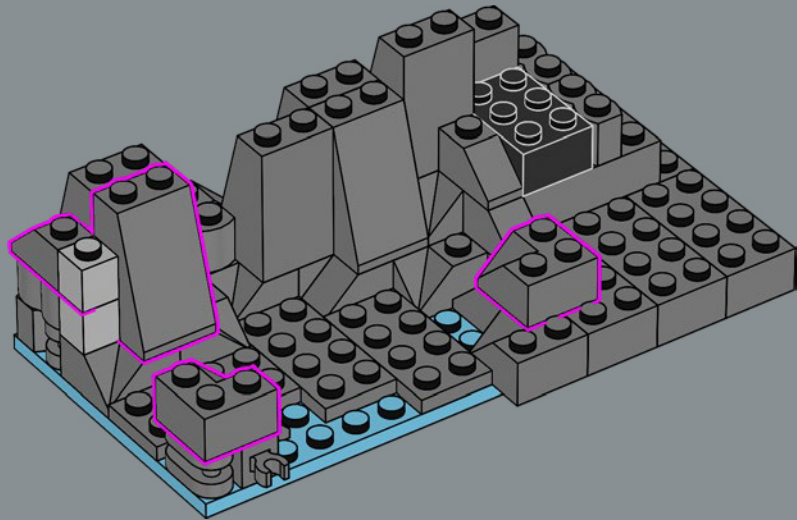

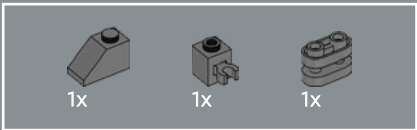

12

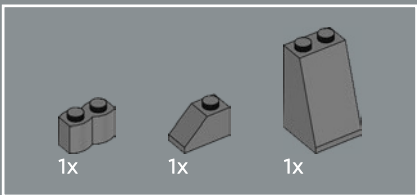
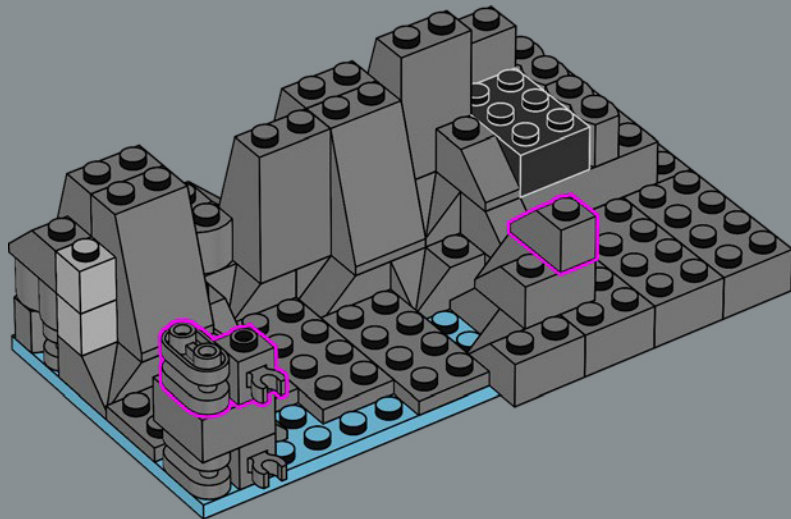

13

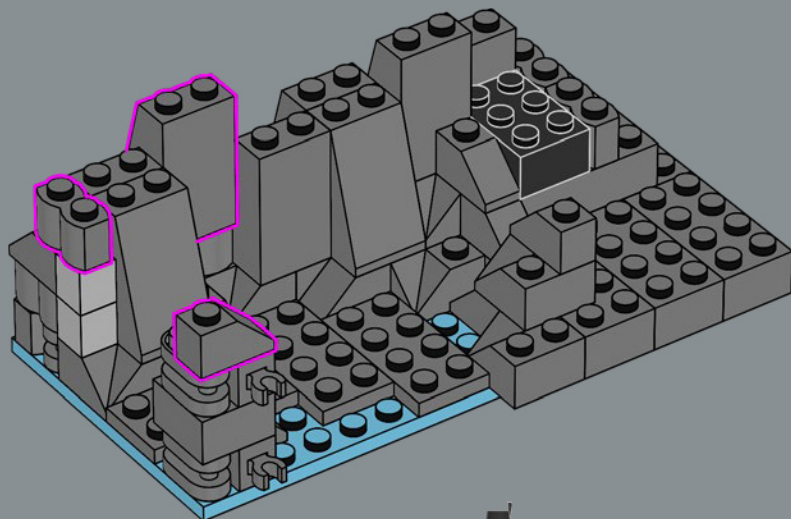

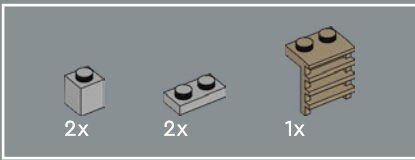

14

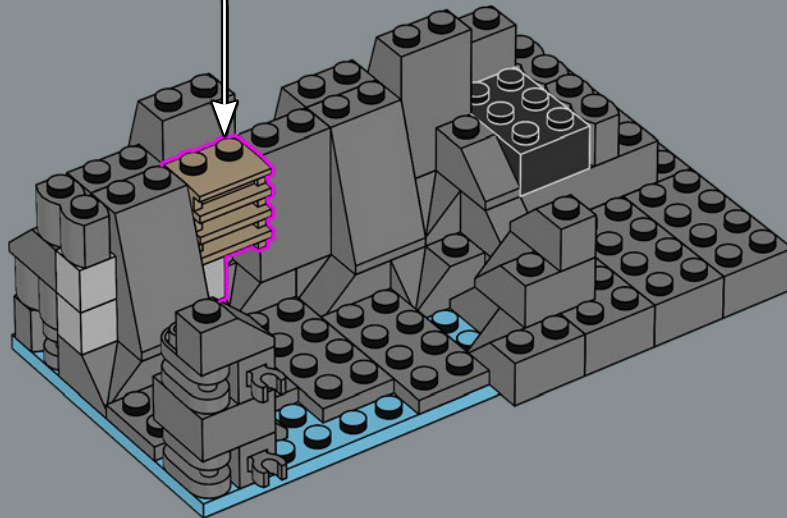
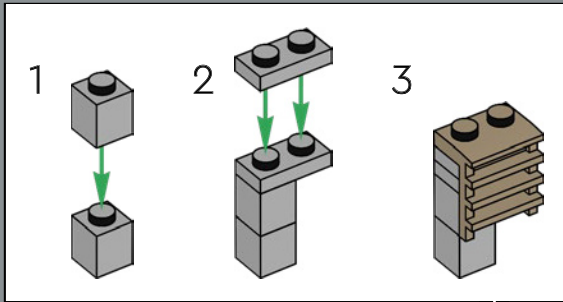

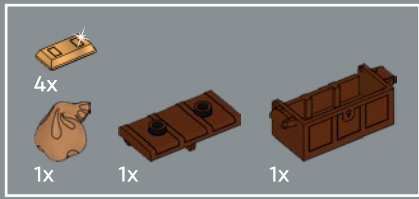

15

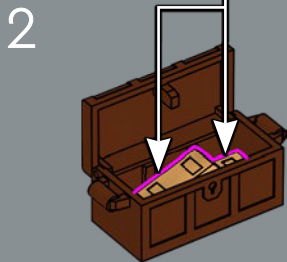
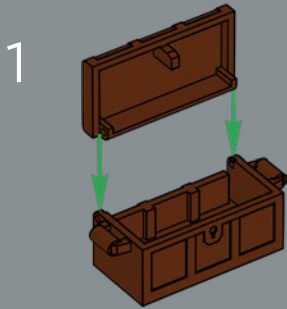

3

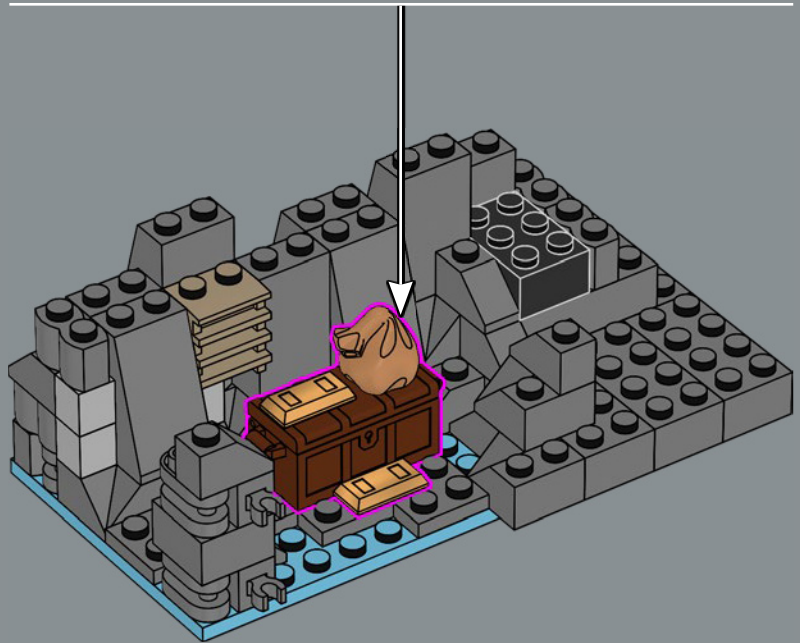

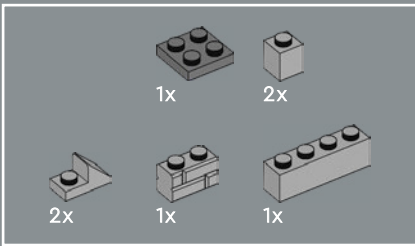

16

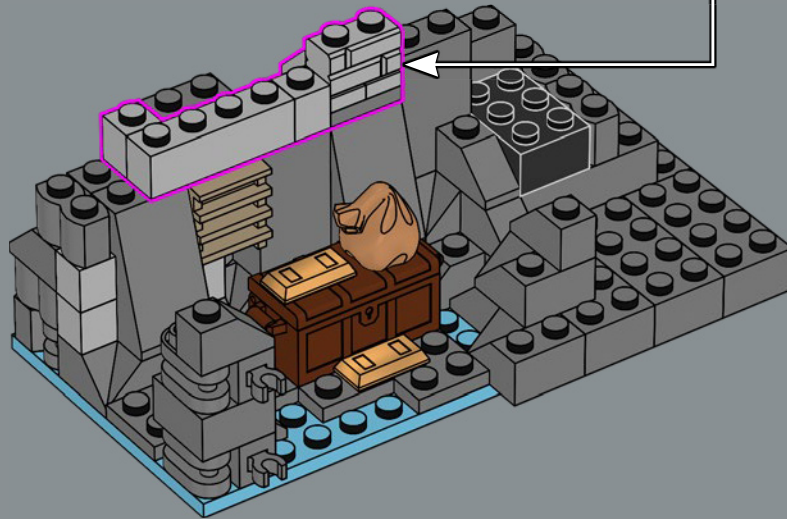
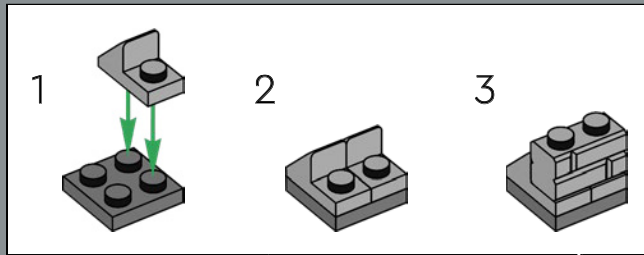

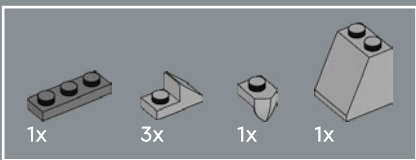

17

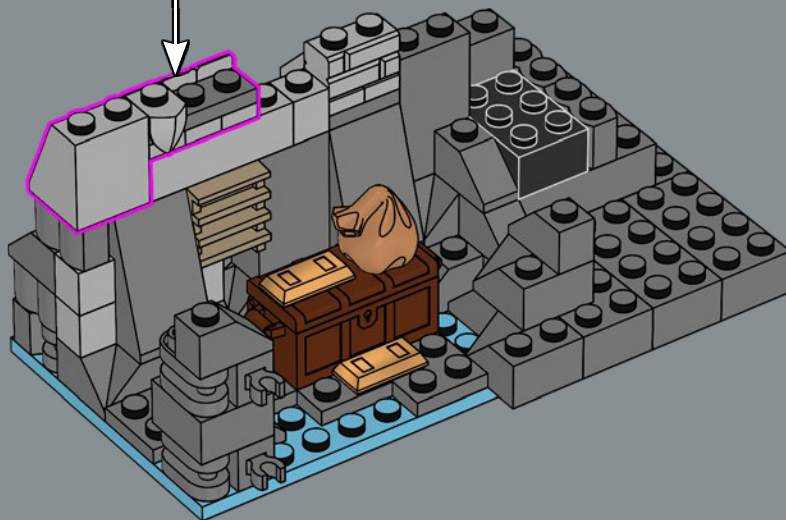
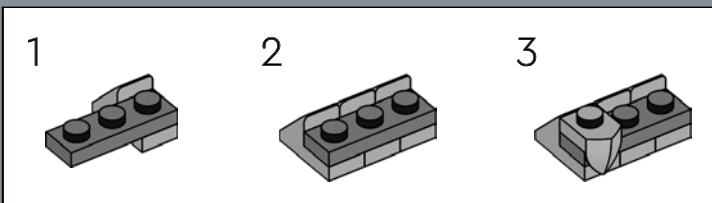

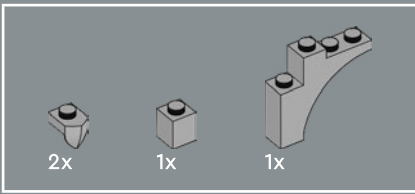

18

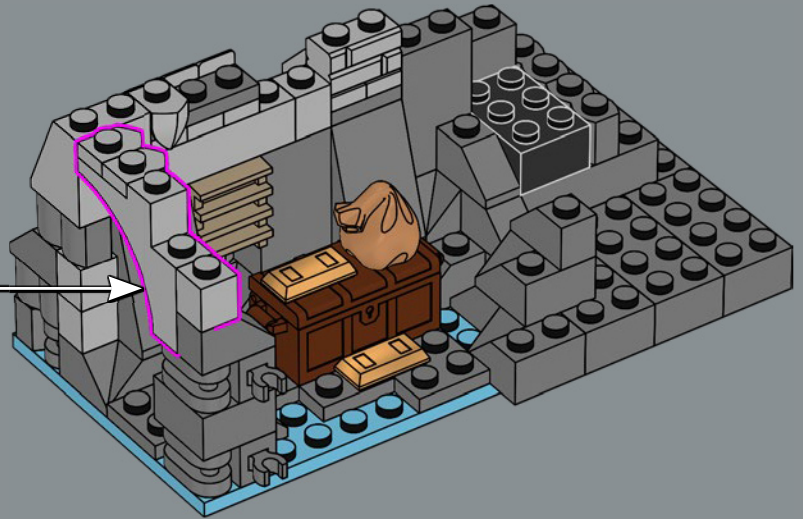
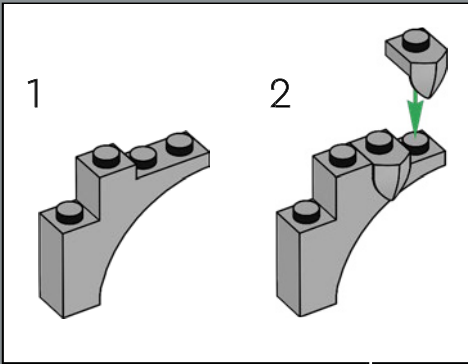

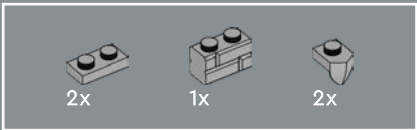

19

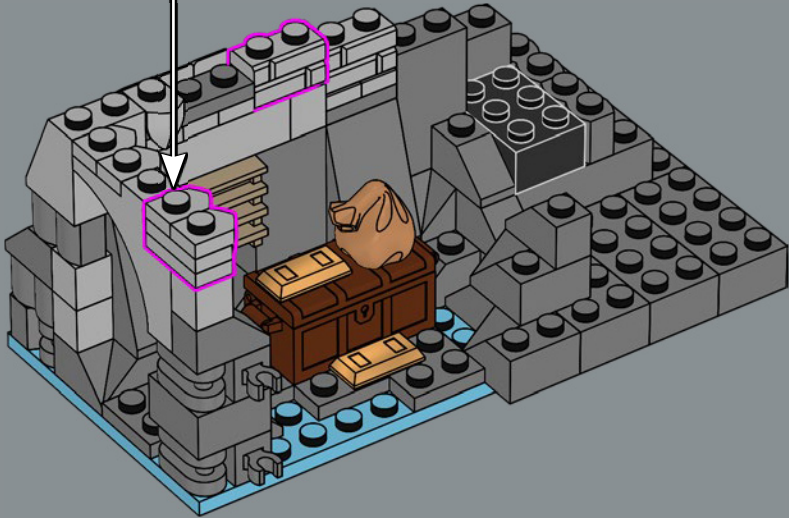
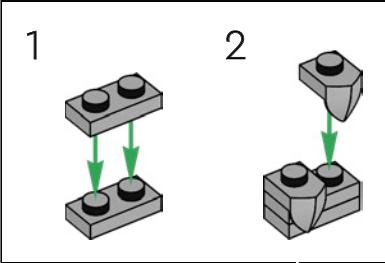

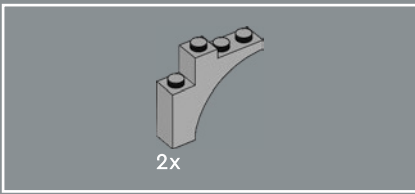

20

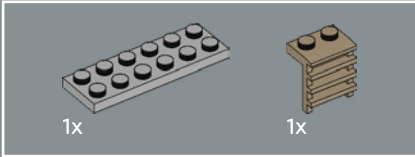
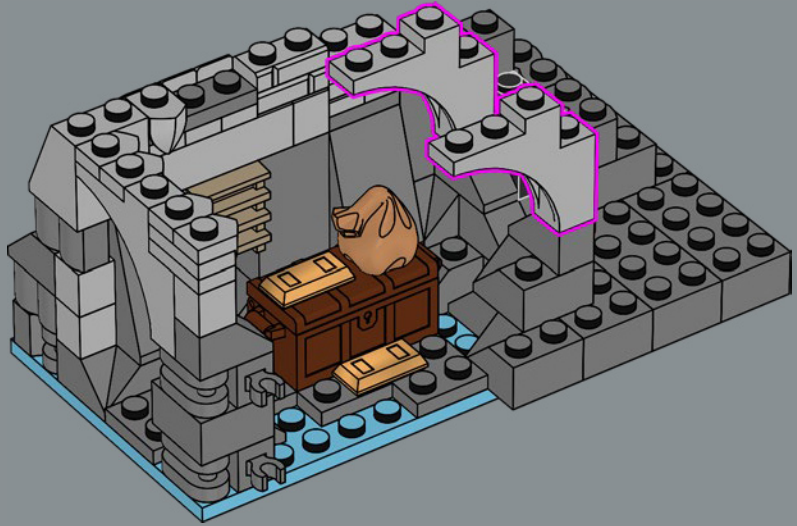

21

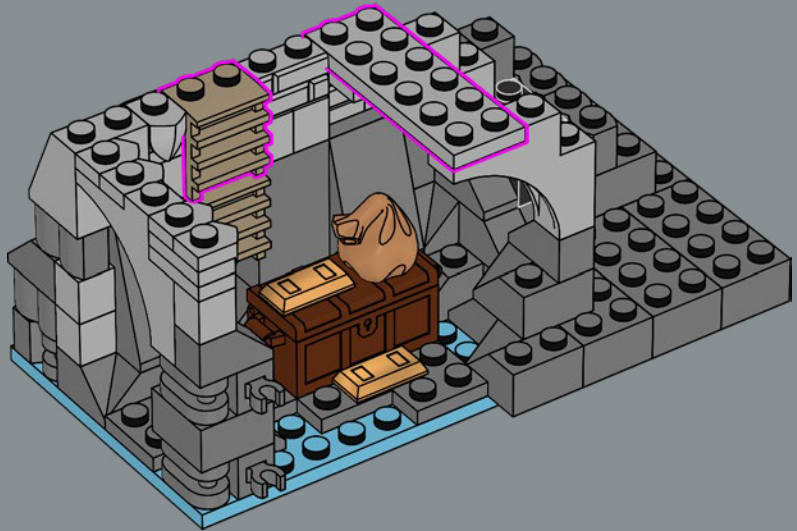

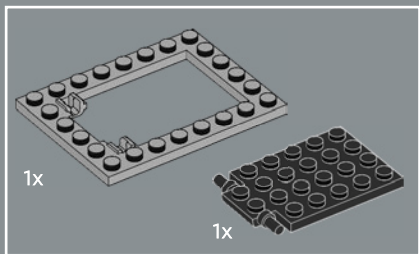

22

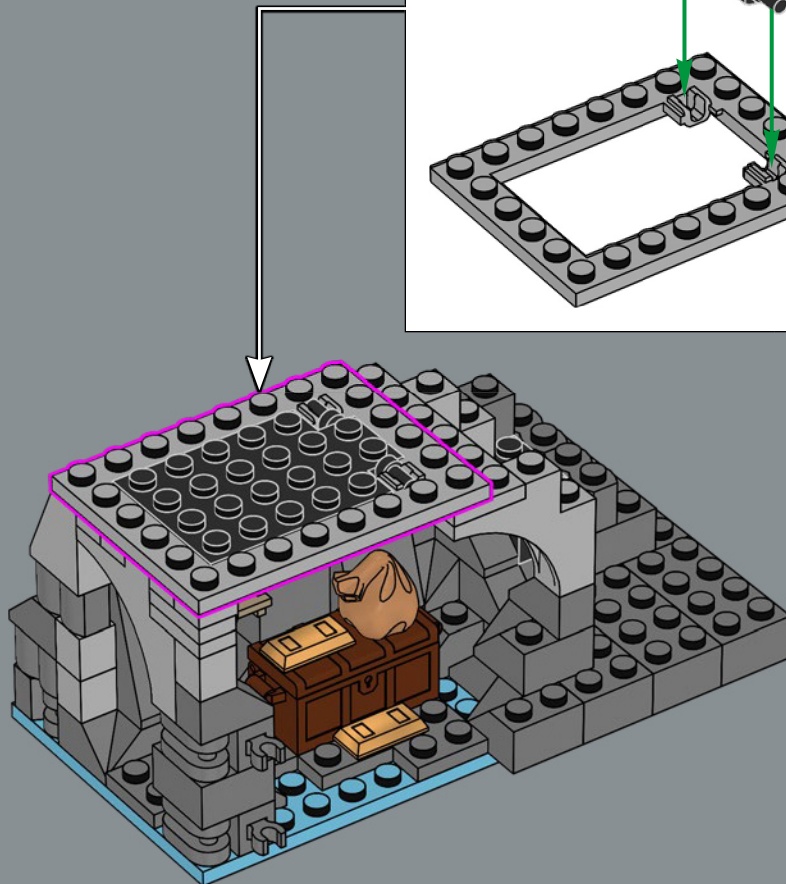
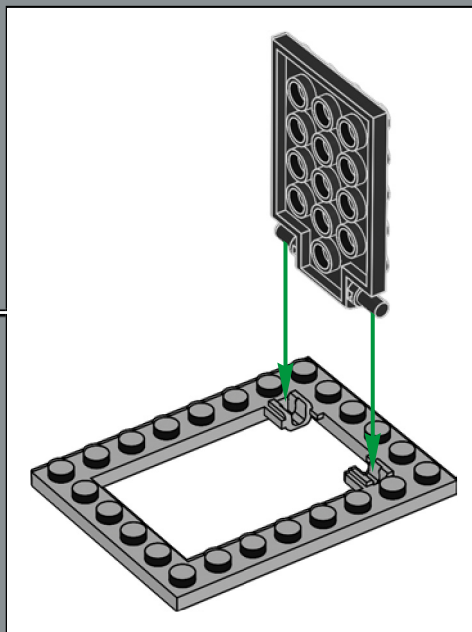

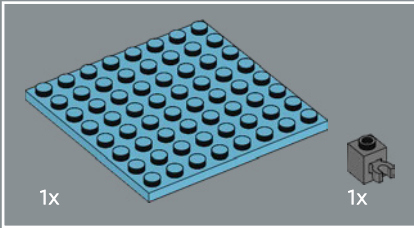
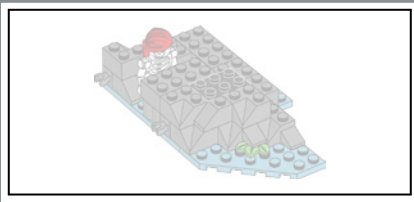

23

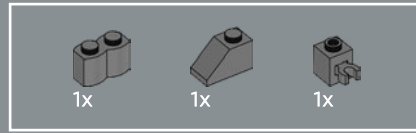
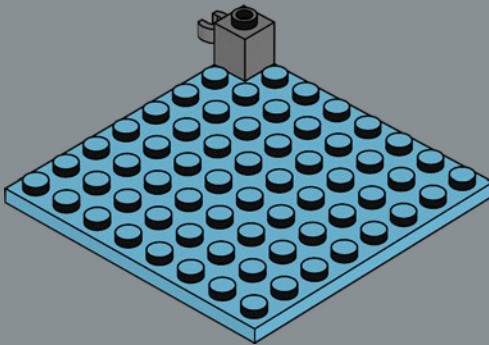

24

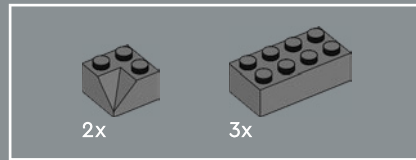
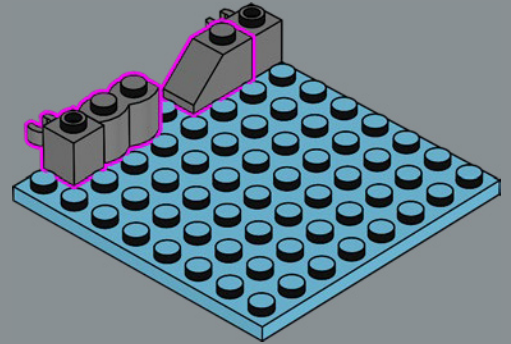

25

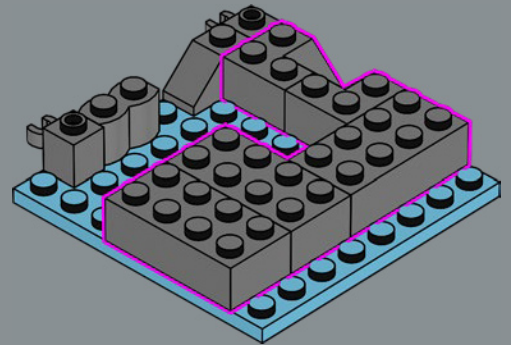

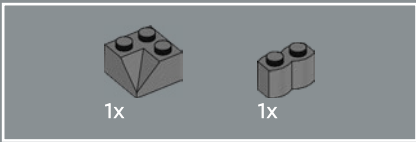

26



Non si sa cosa sia successo a questo povero scheletro. Forse stava cercando di fuggire? O magari è andato alla ricerca della lettera segreta?

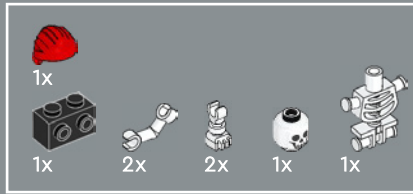

27

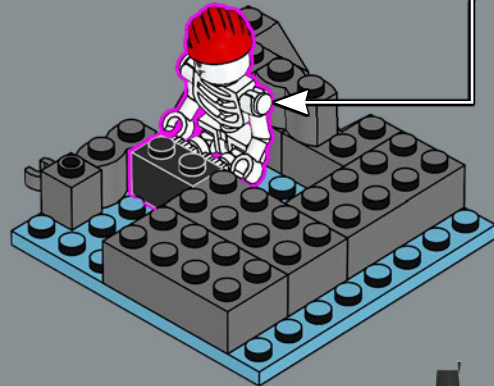
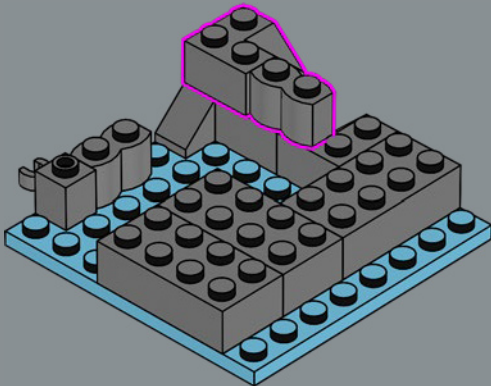
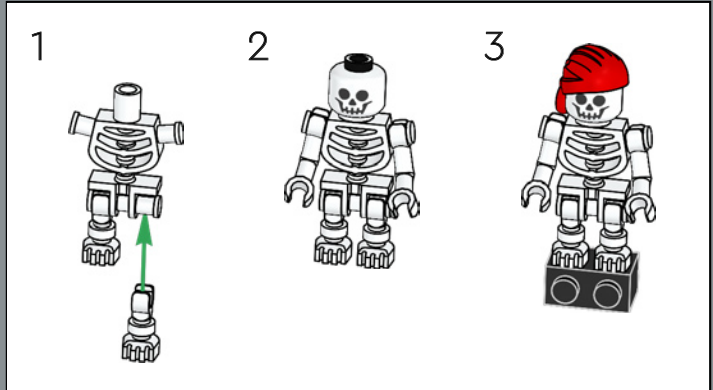

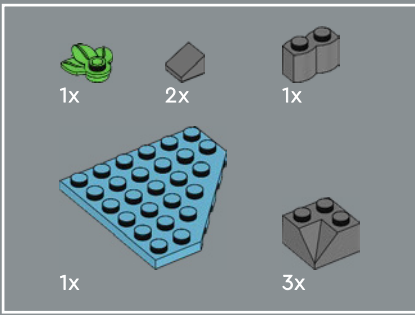

28

1

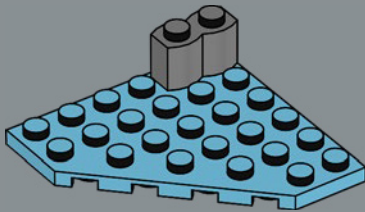

2

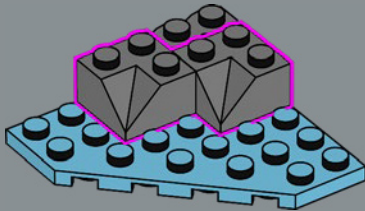

3

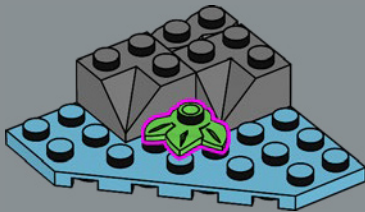

4

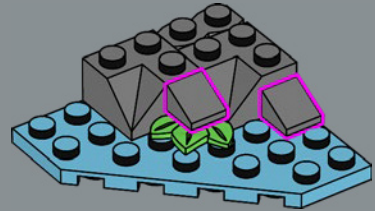

5

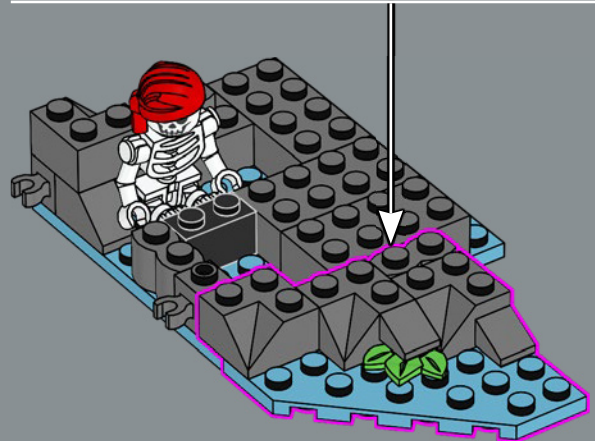
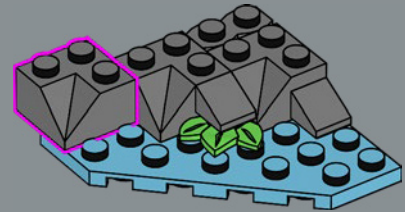

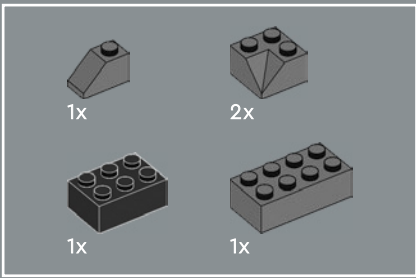

29

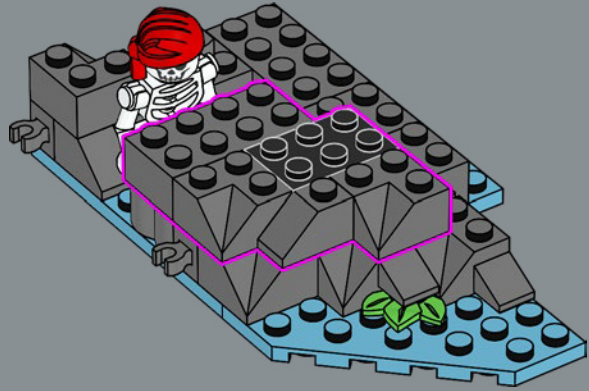

30

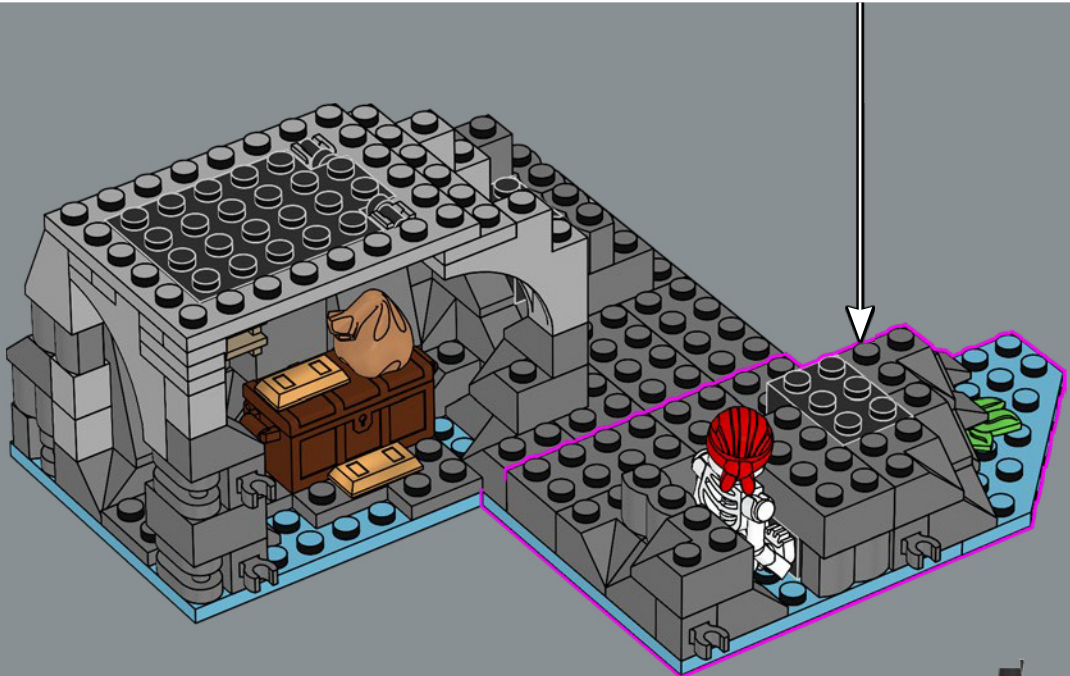

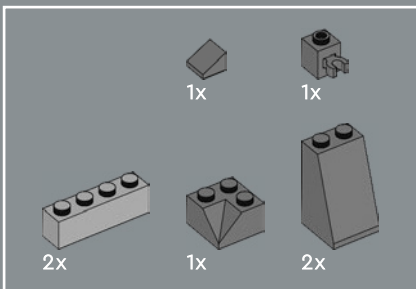

31

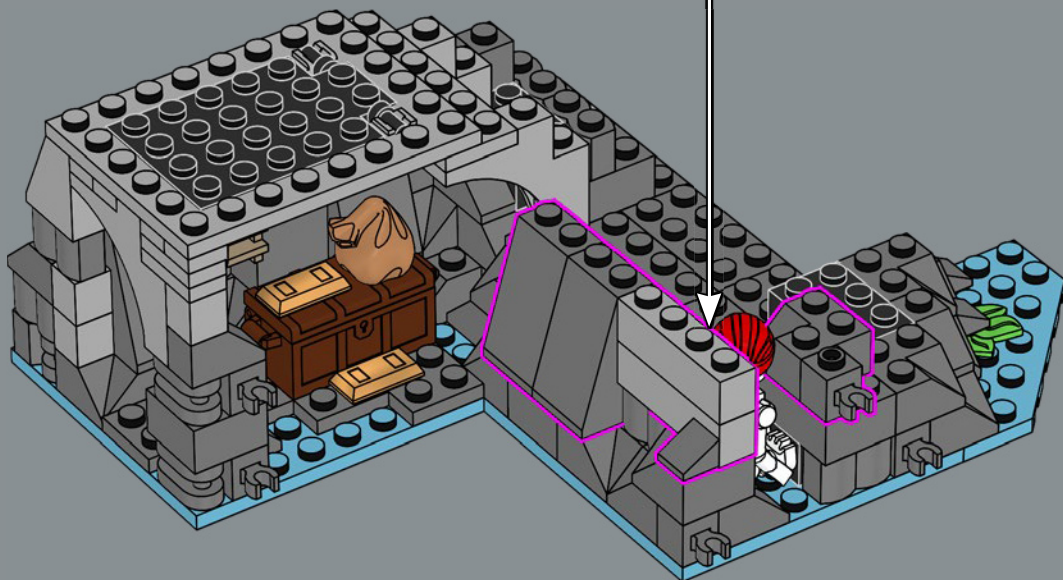
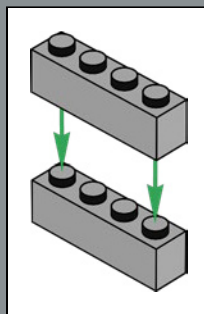

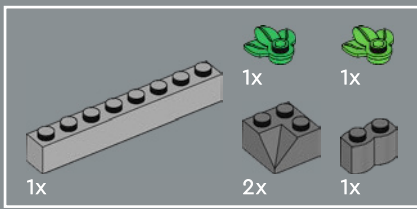

32

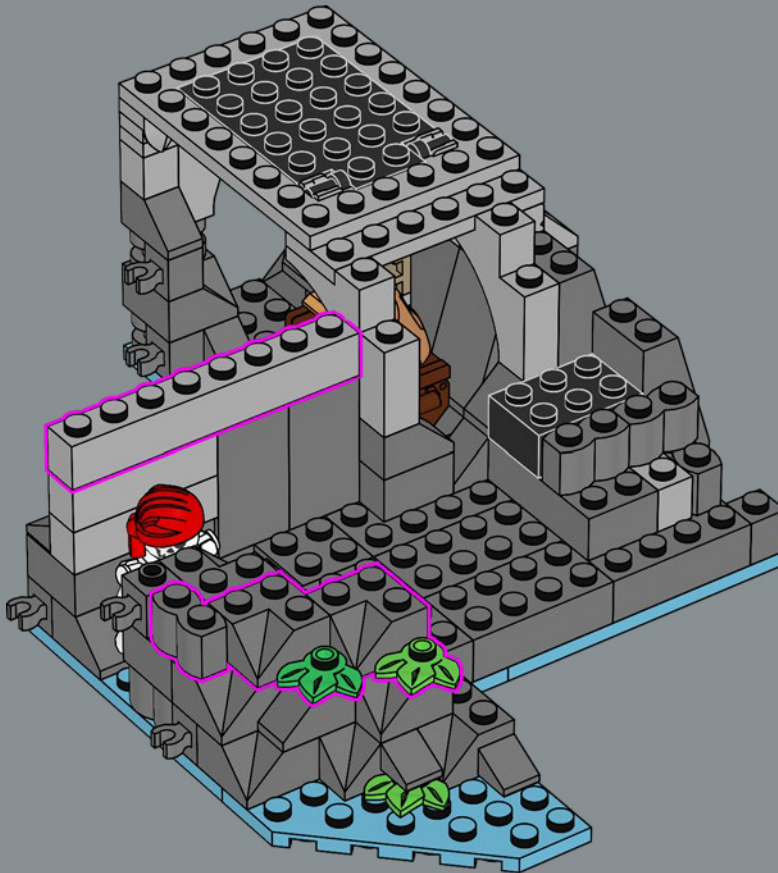

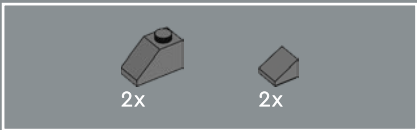

33

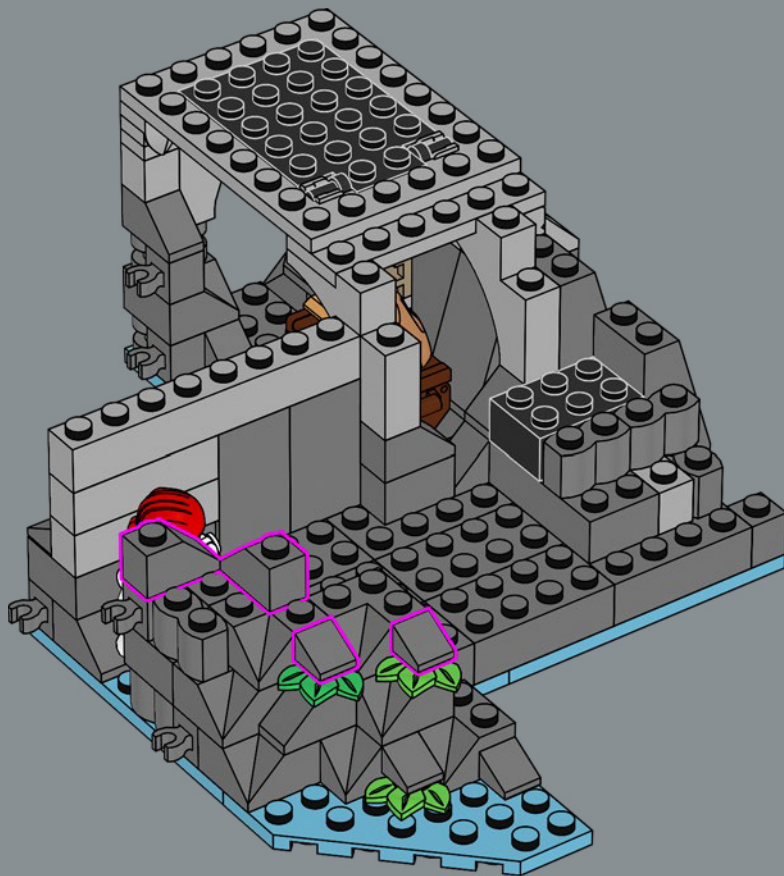

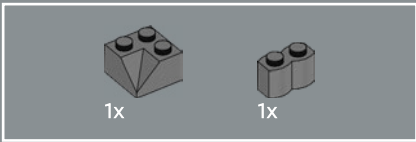

34

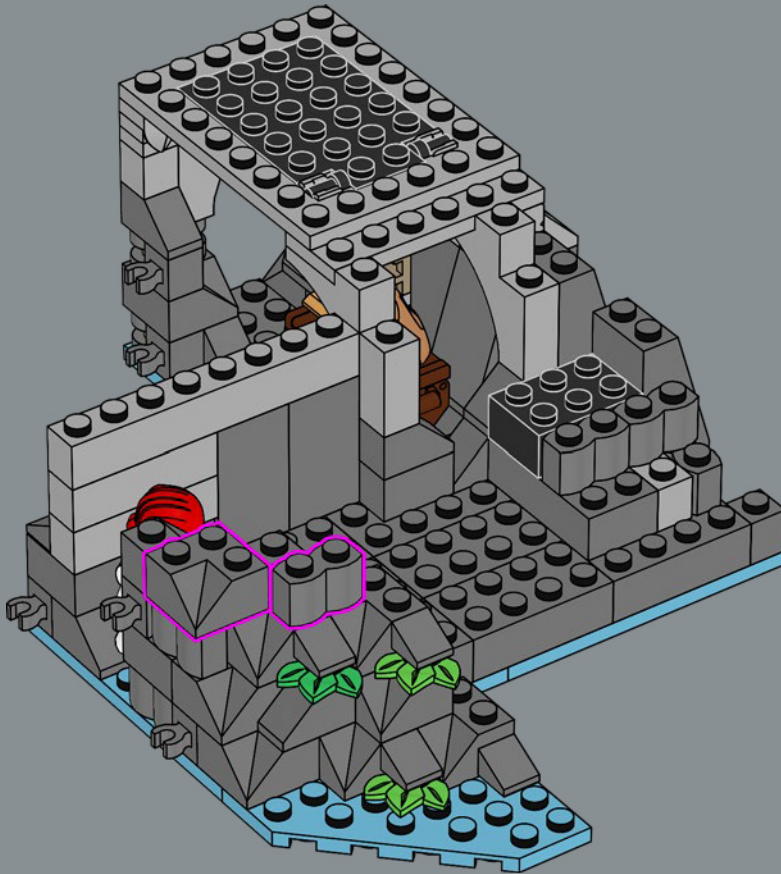

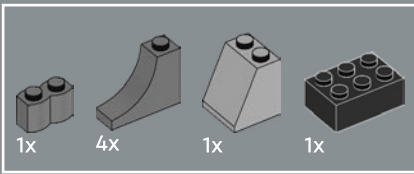

35

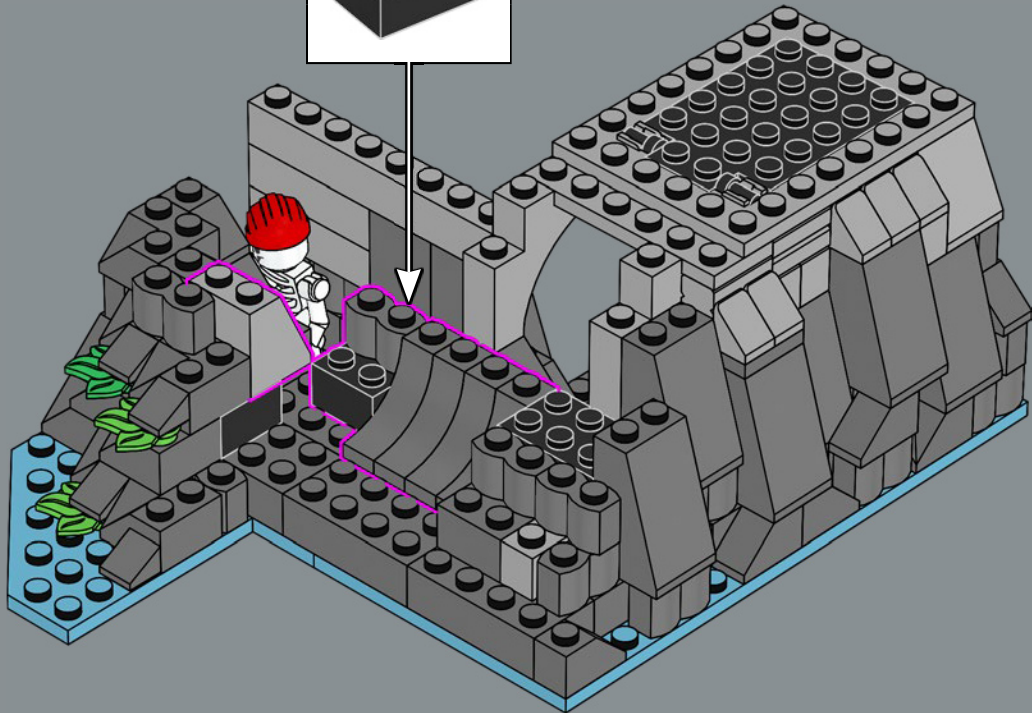
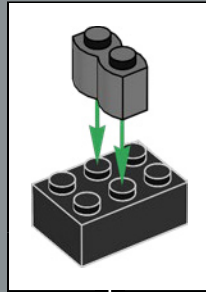

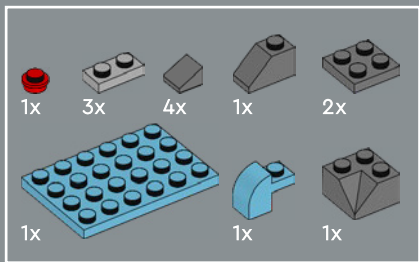

36

1

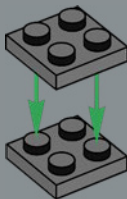

2

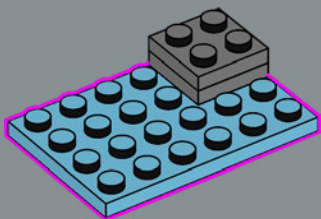

3

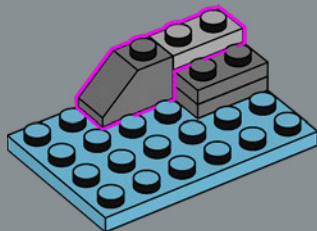

4

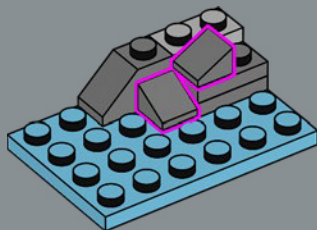

5

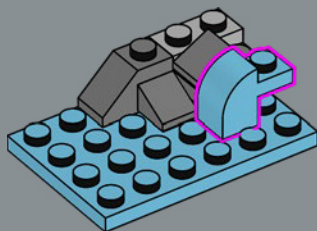

6

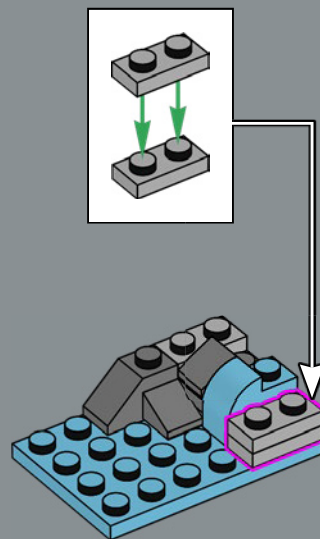

7

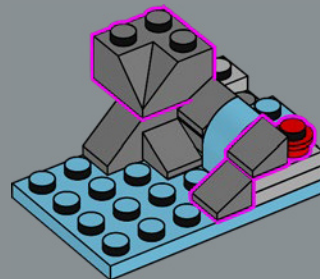

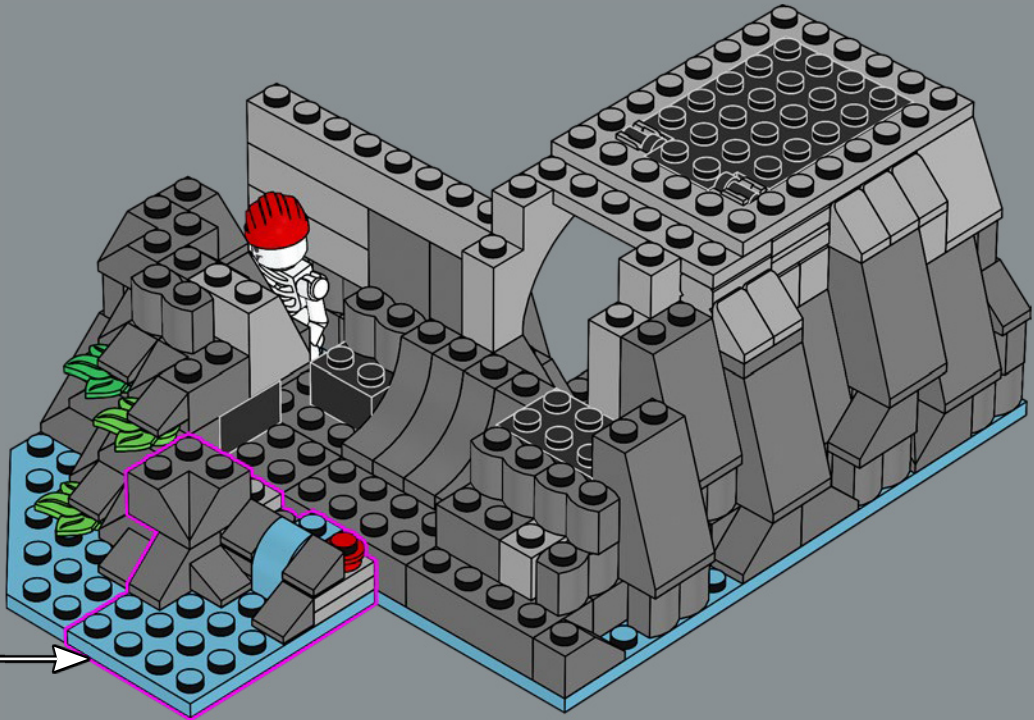

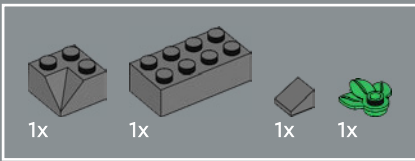

38

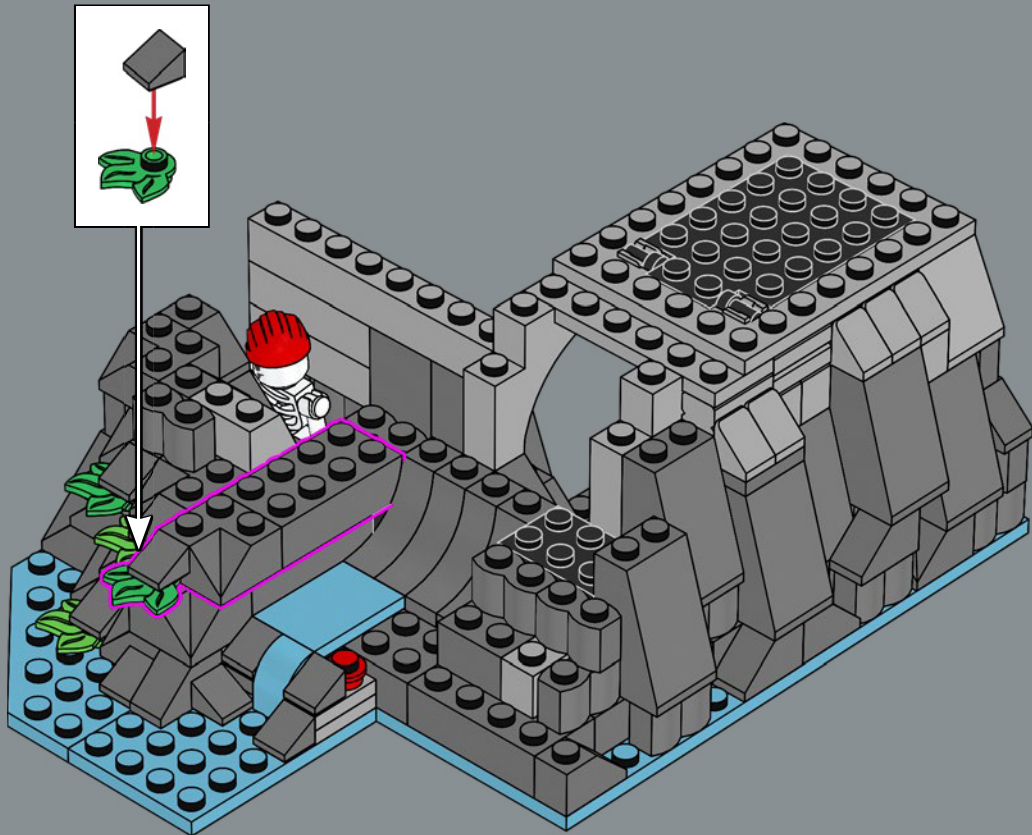

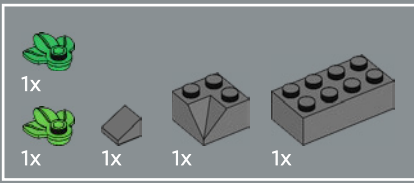

39

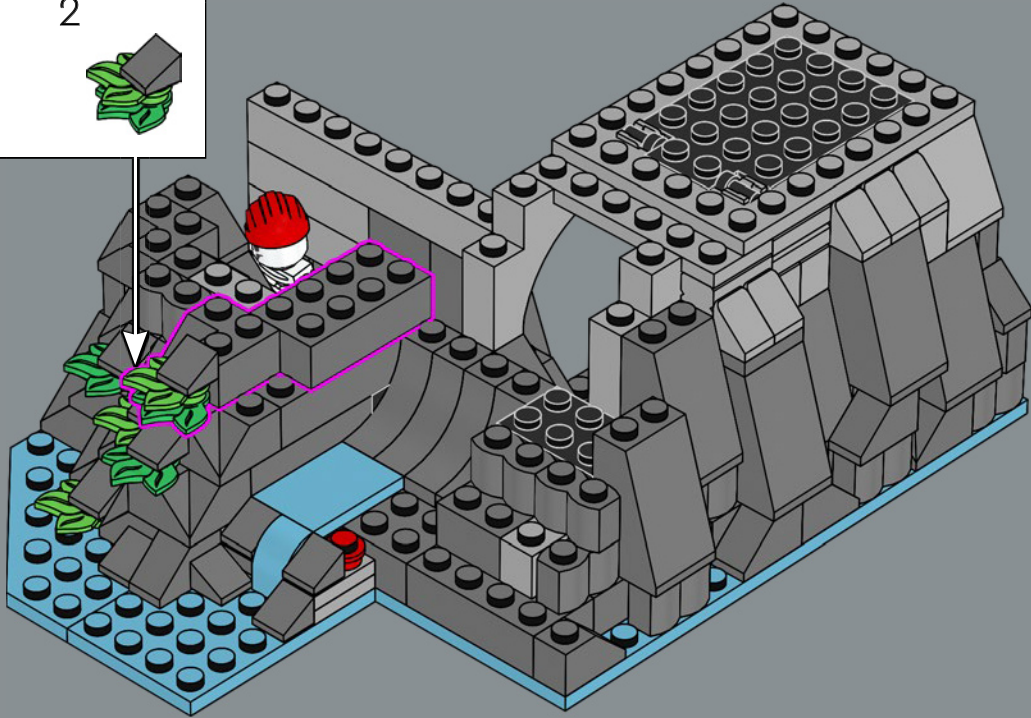
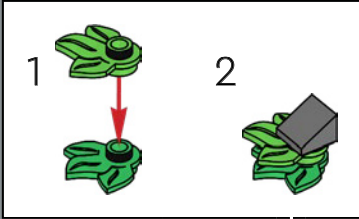

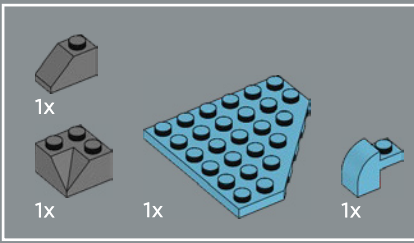

40

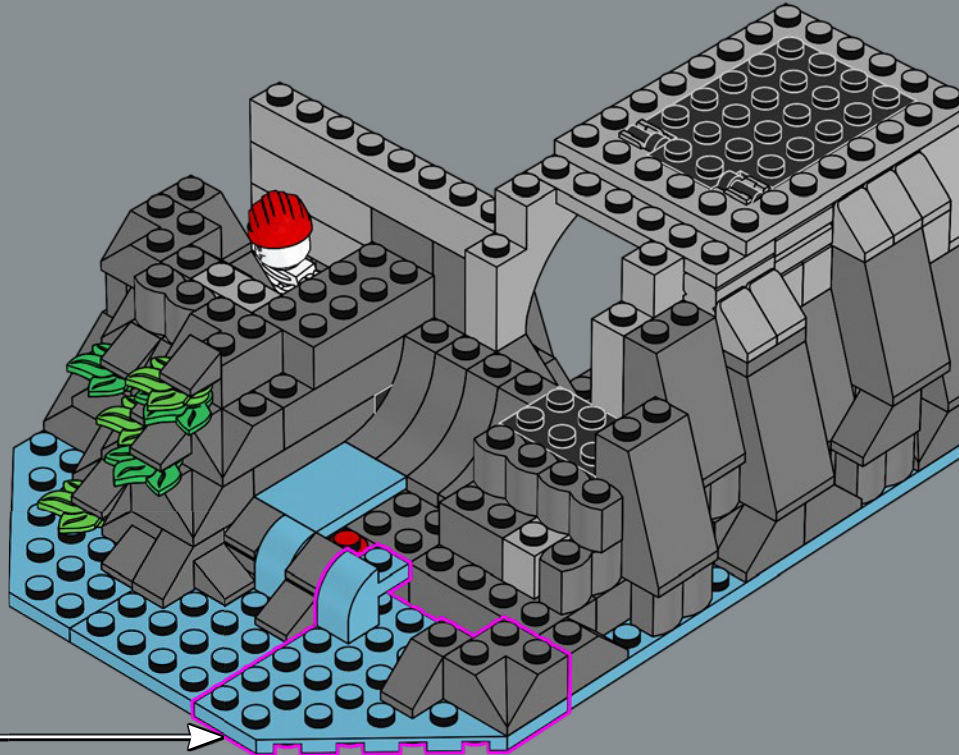
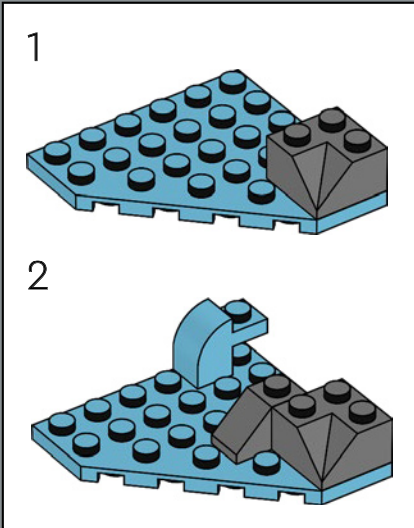

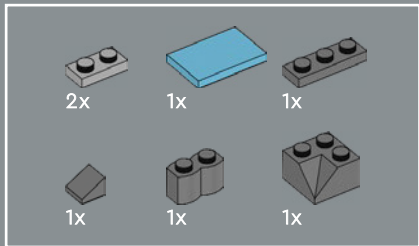

41

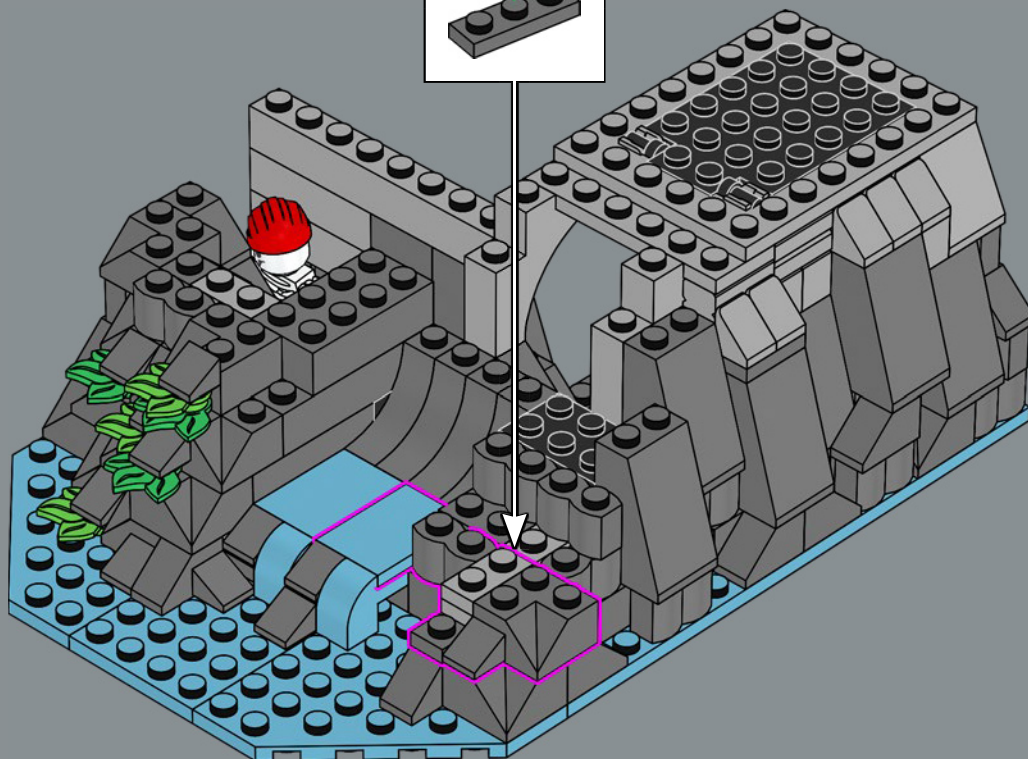
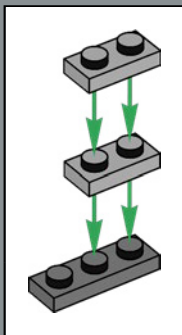

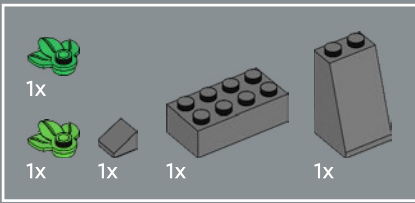

42

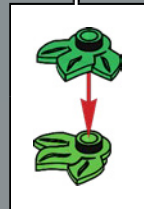
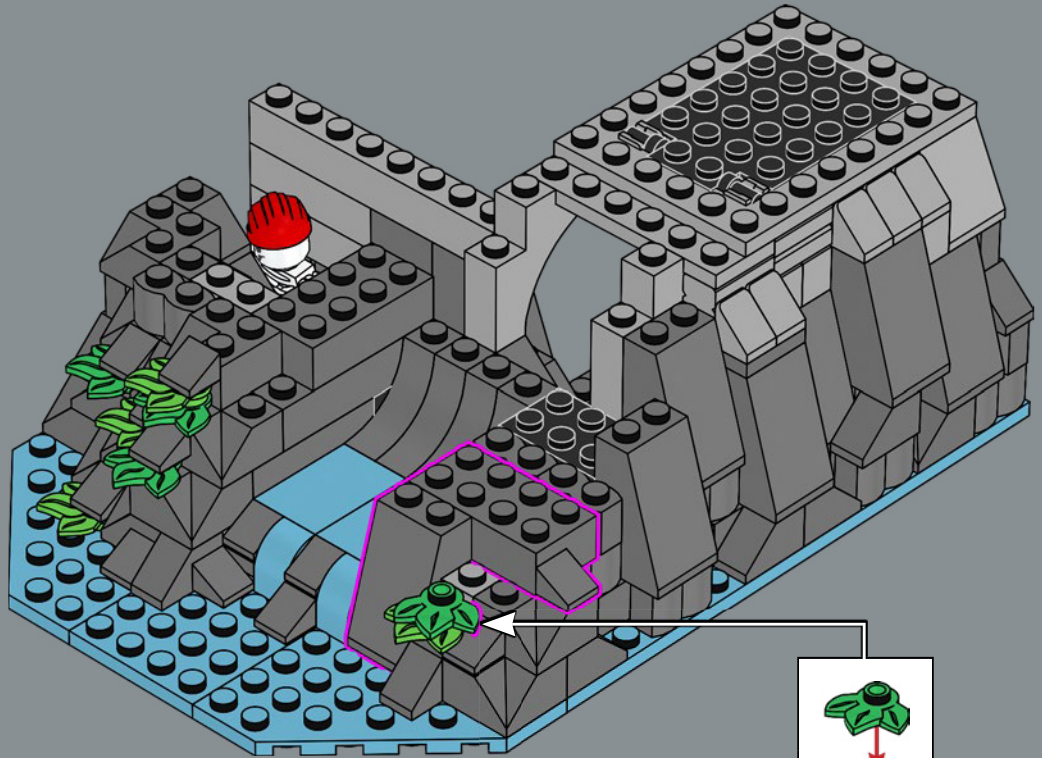

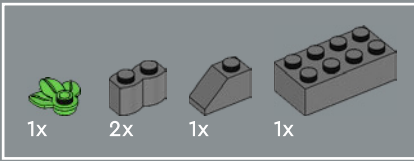

43

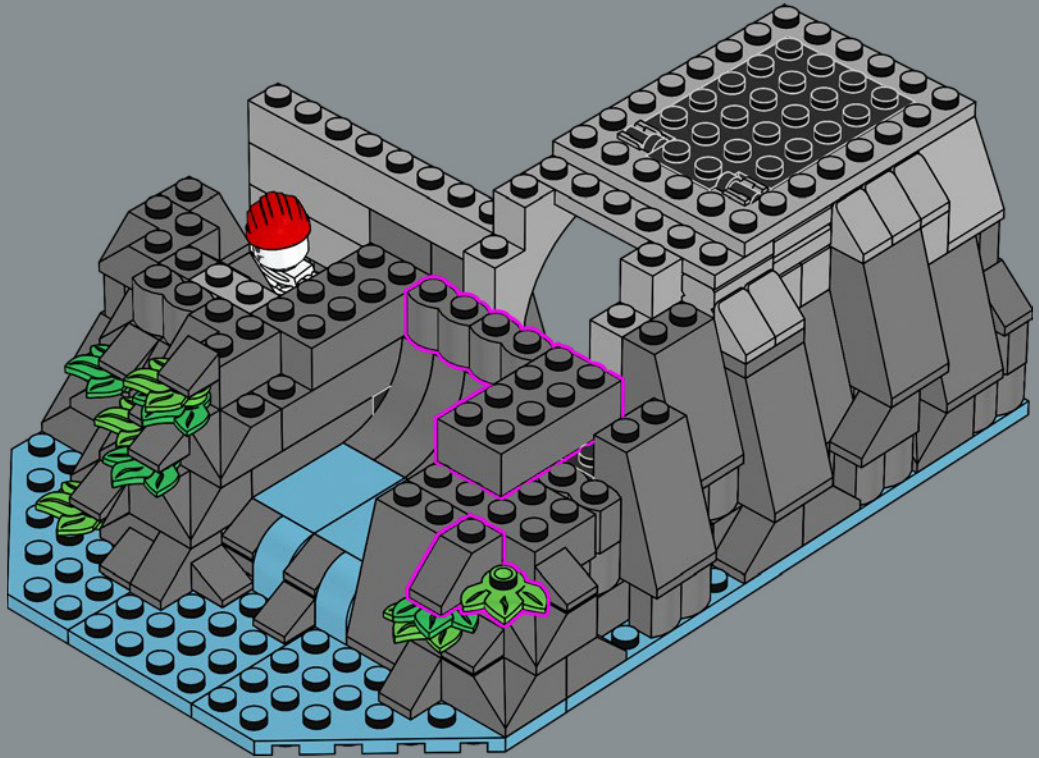

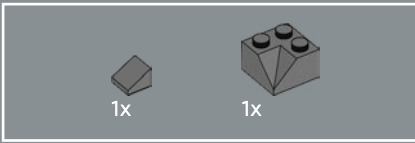

44

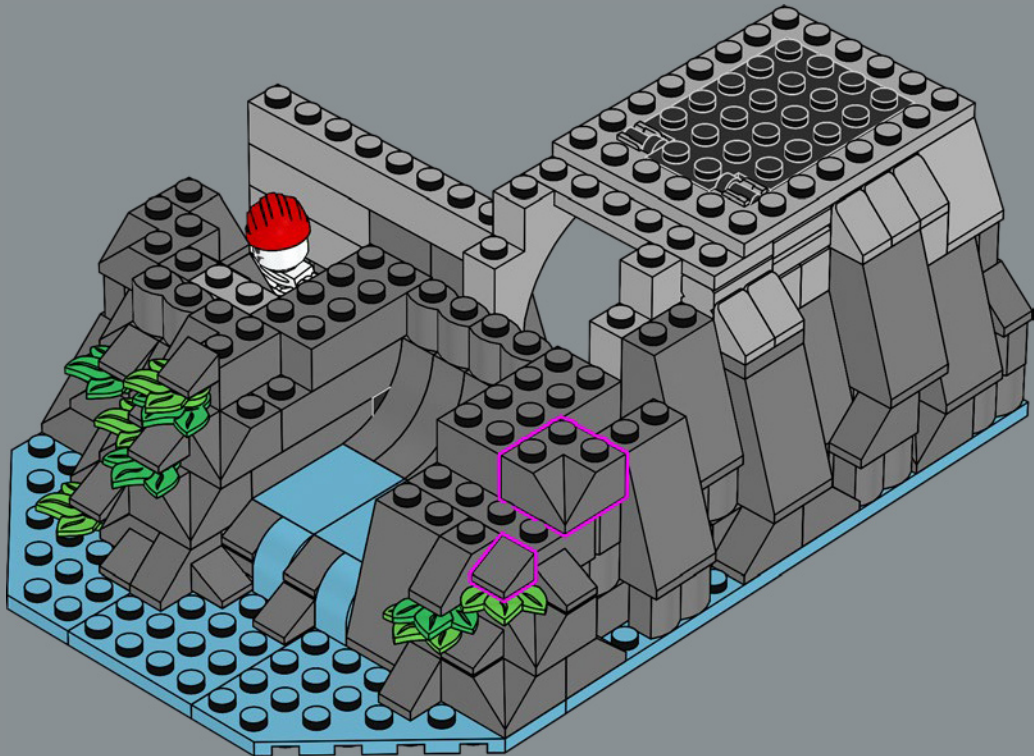

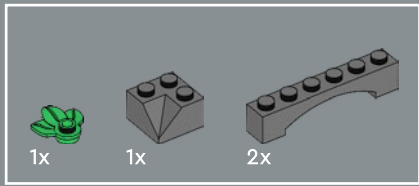

45

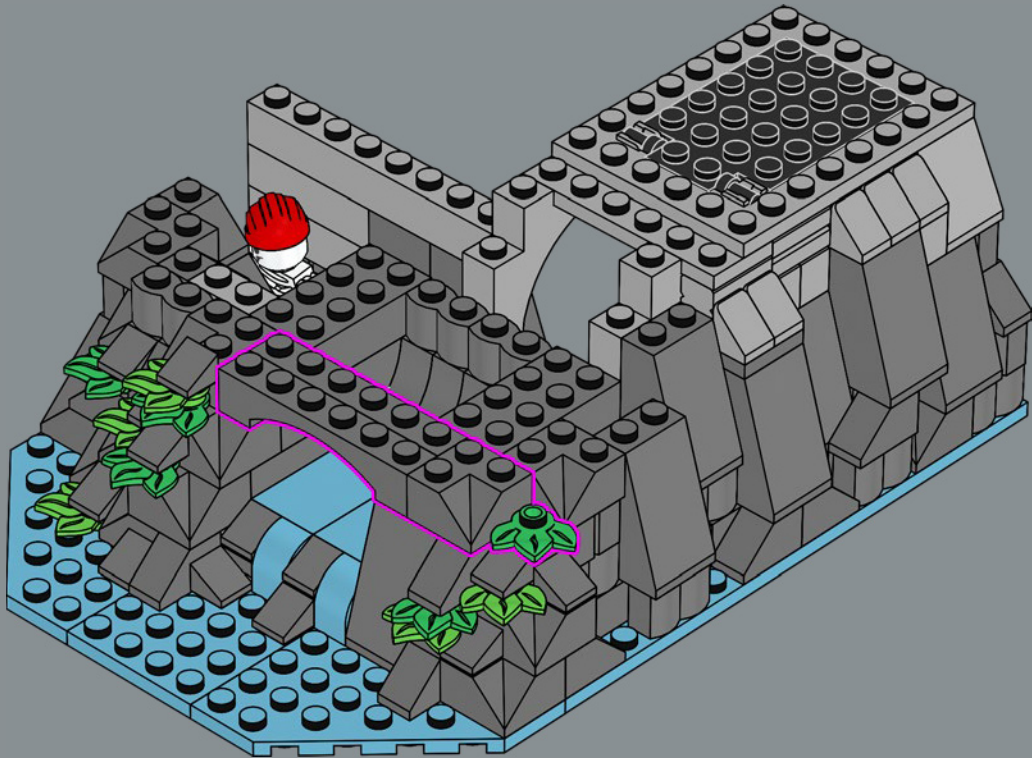

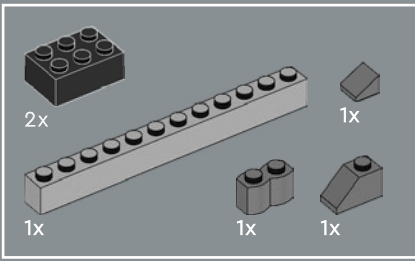

46

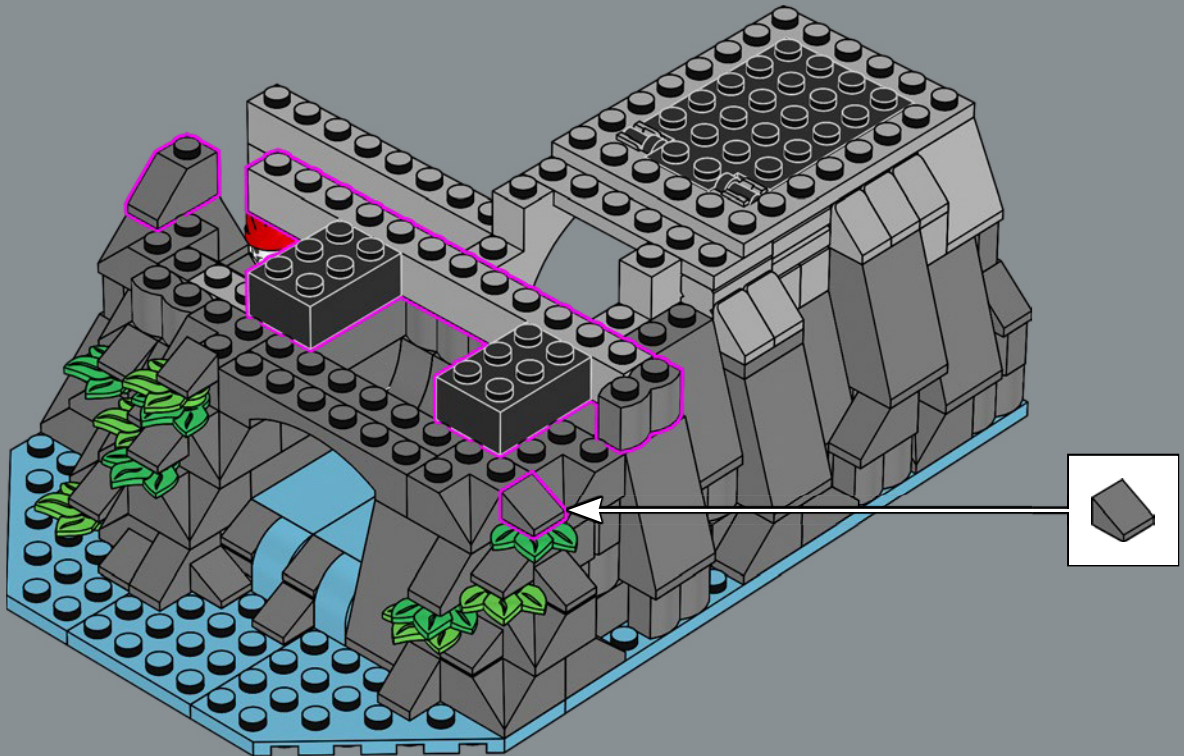

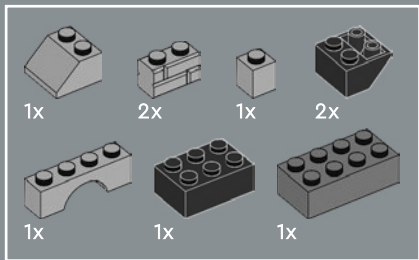

47

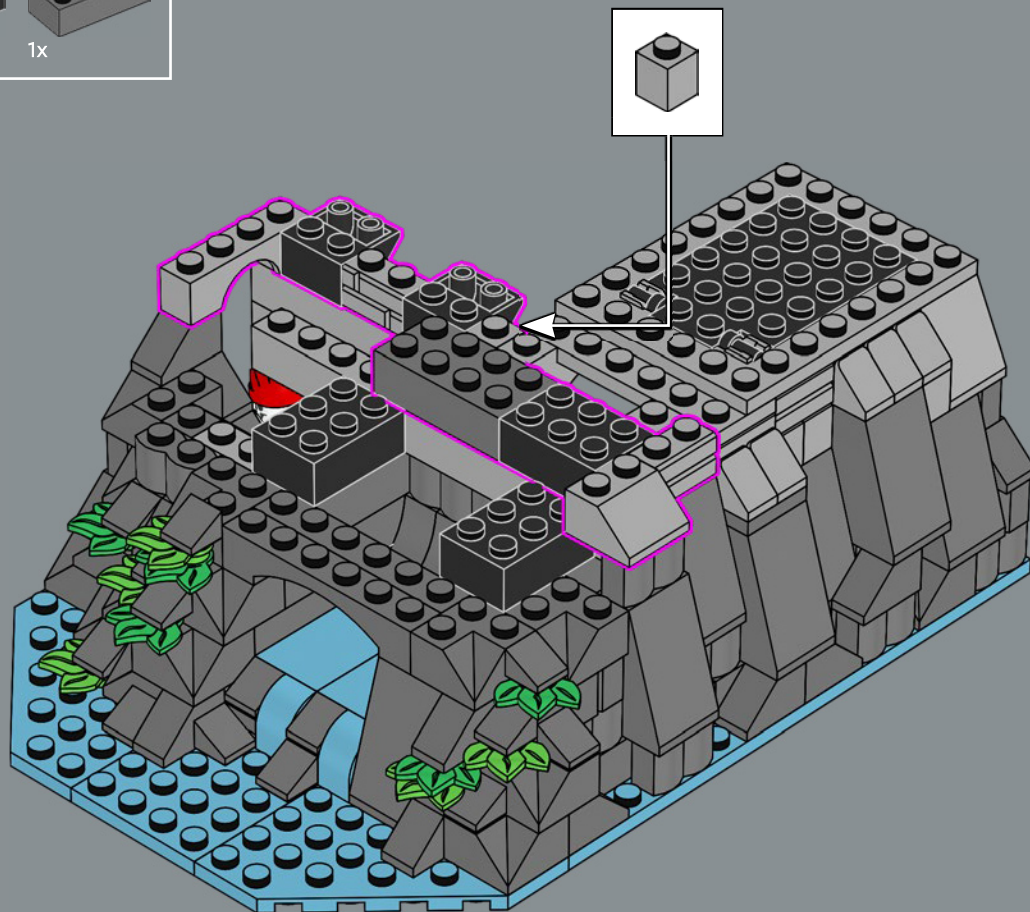

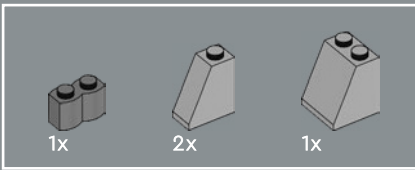

48

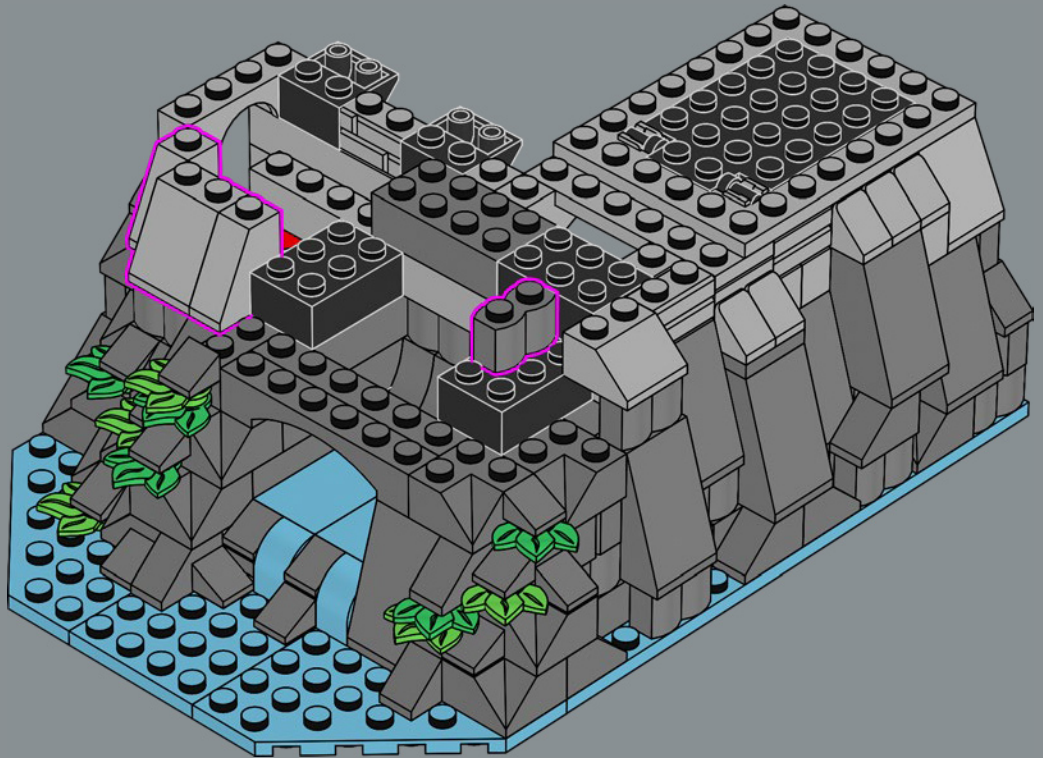

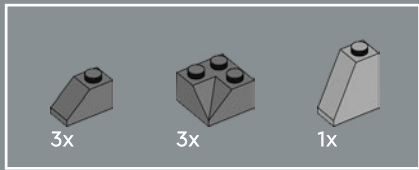

49

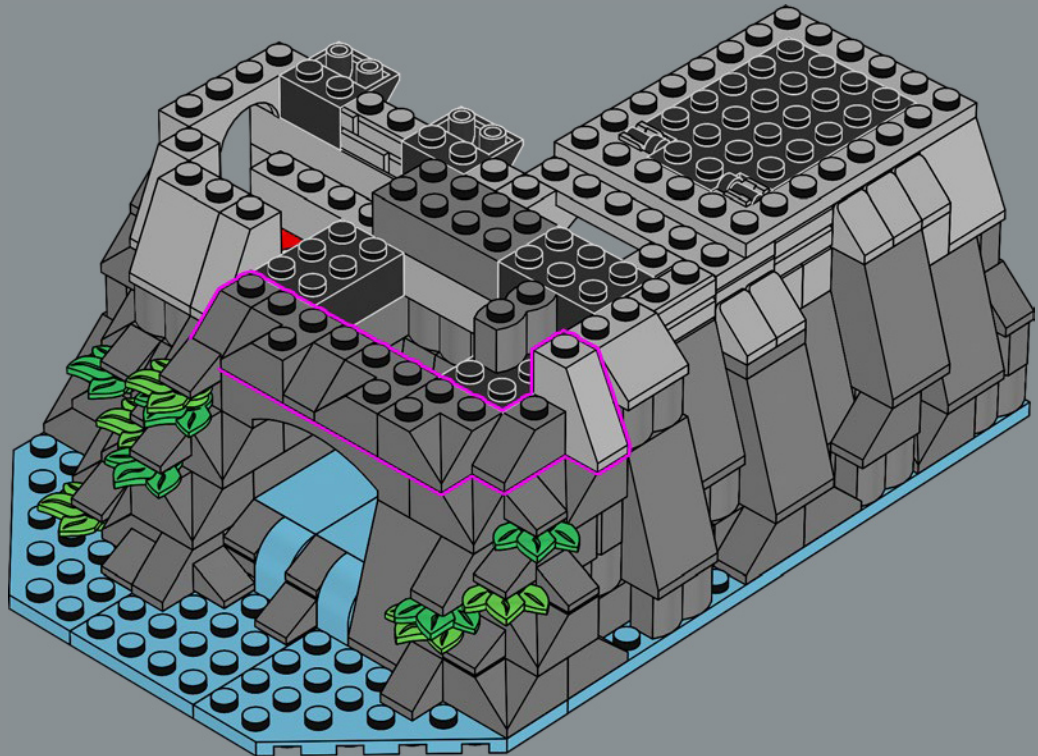

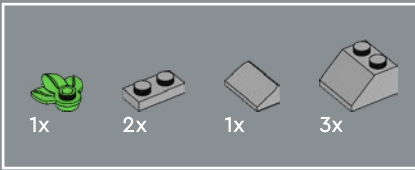

50

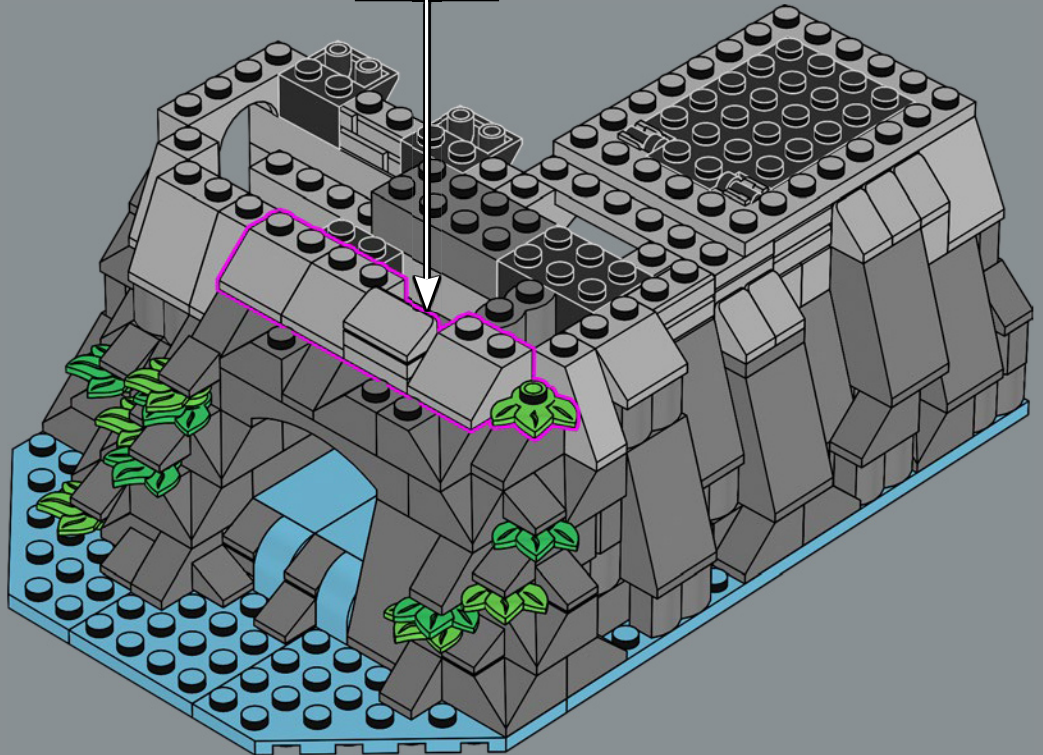
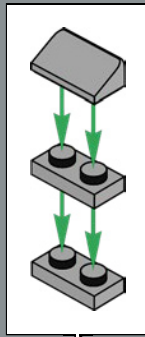

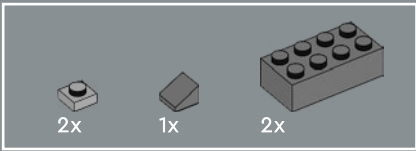

51

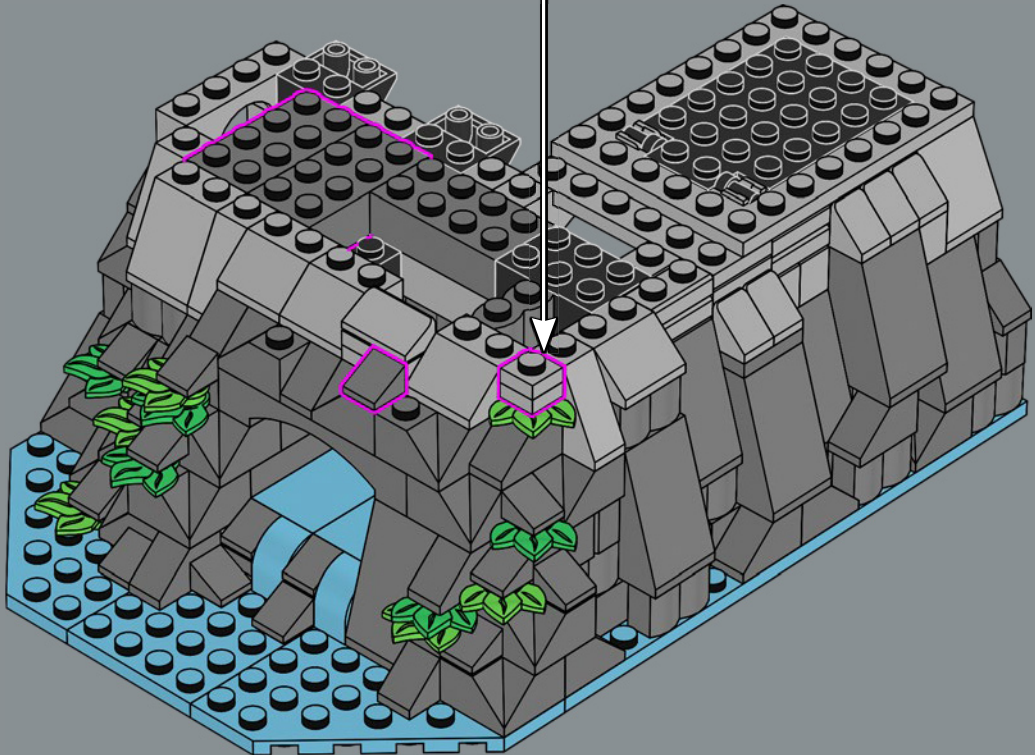
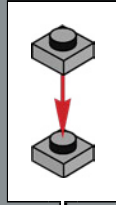

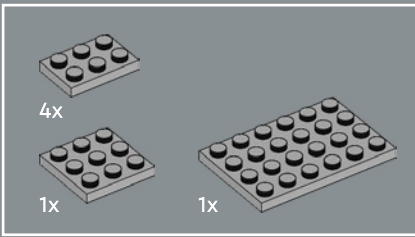

52

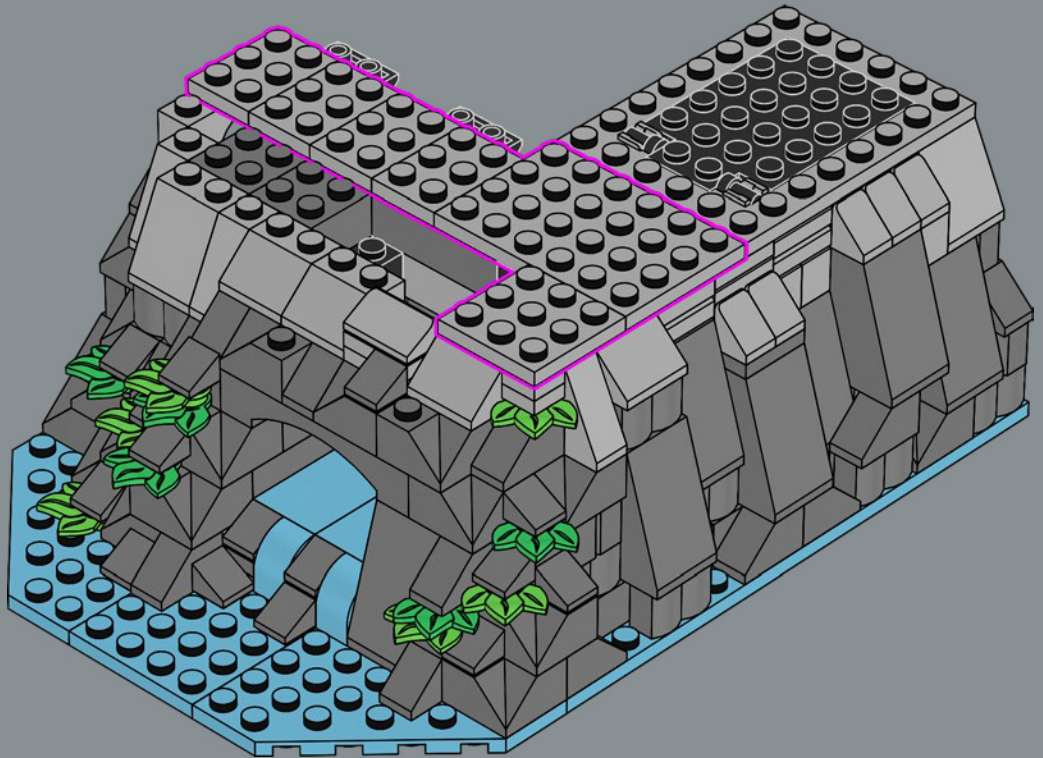

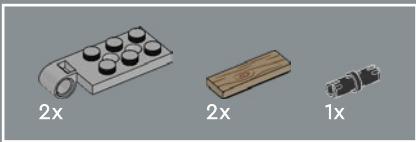

Una botola abilmente nascosta permette ai pirati catturati di fuggire sulla spiaggia, dove i loro compagni bucanieri li stanno attendendo.

53

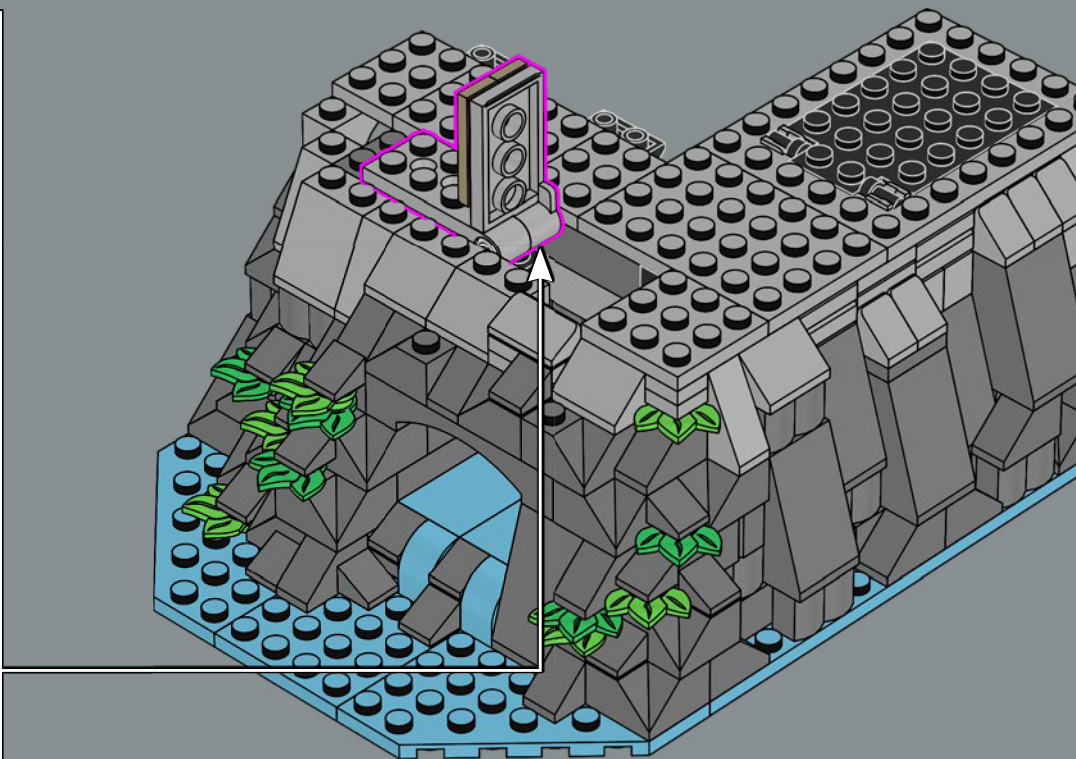
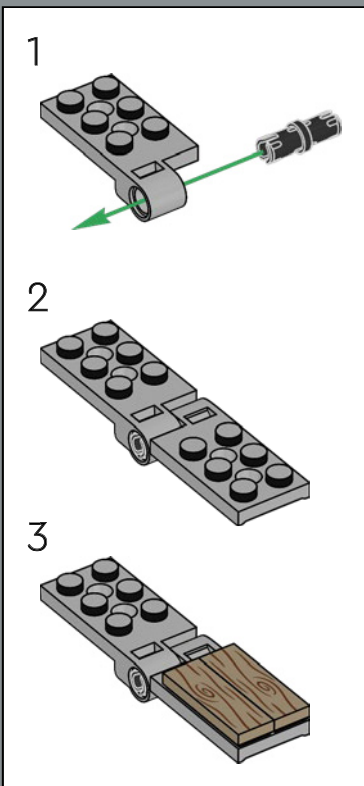

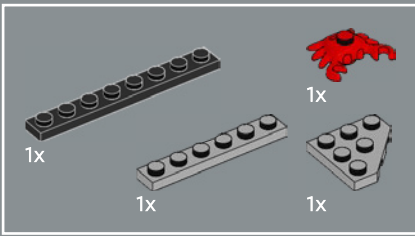

54

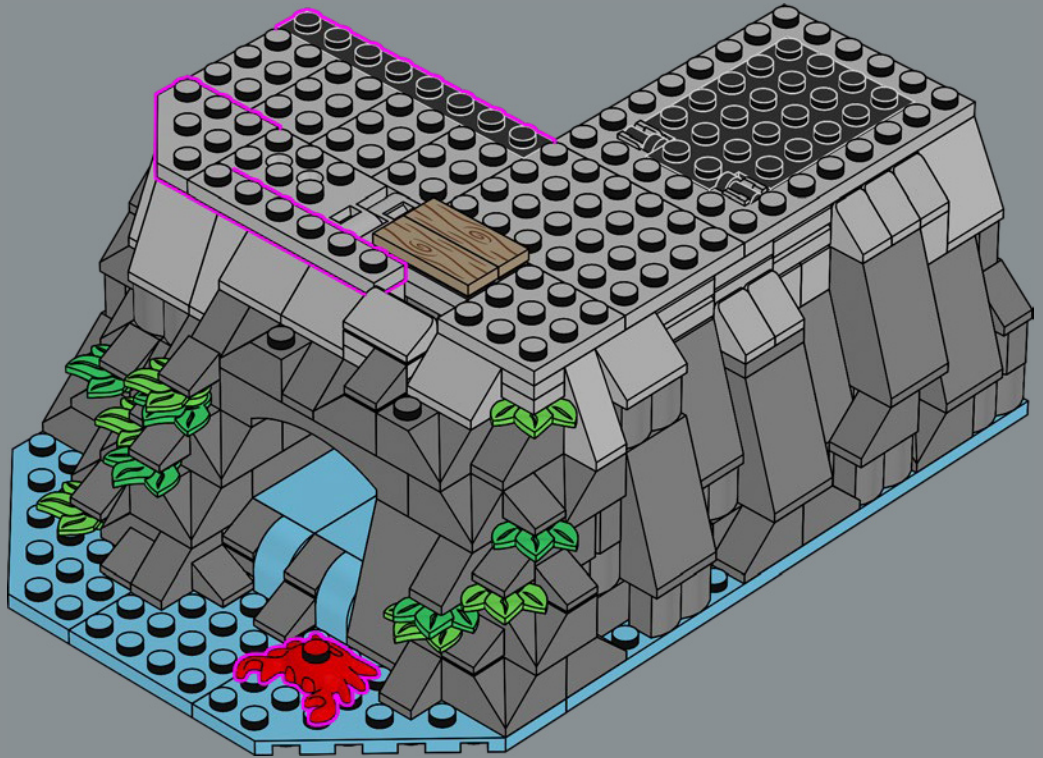



1

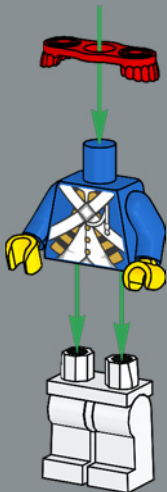

2



3



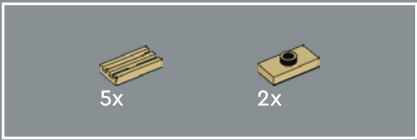

55

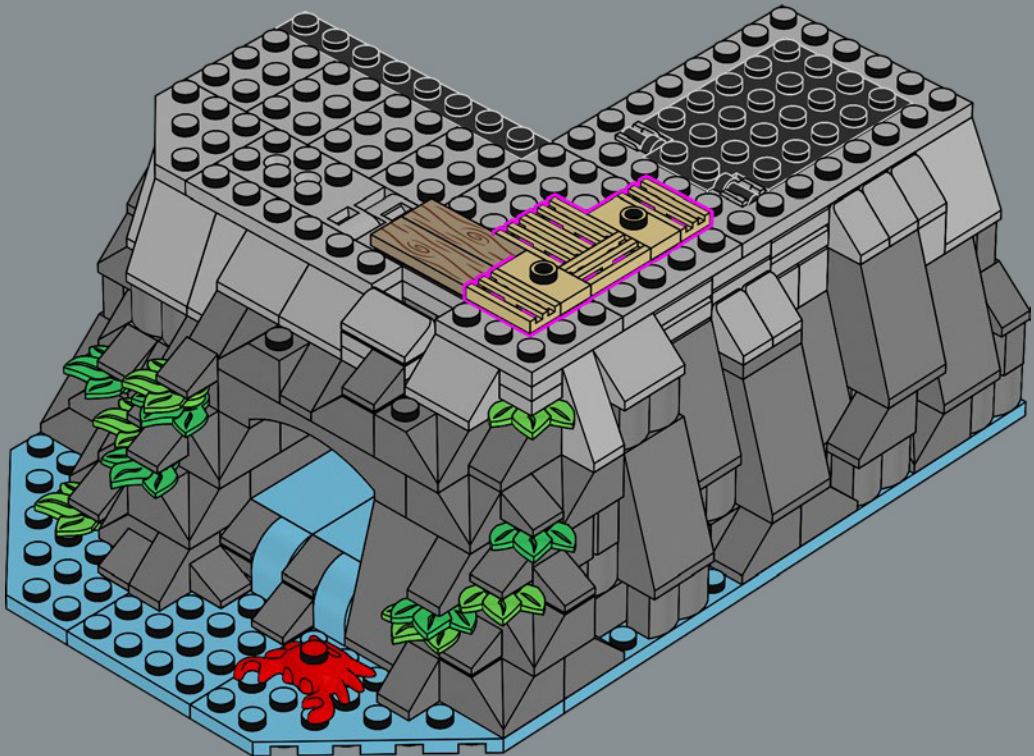

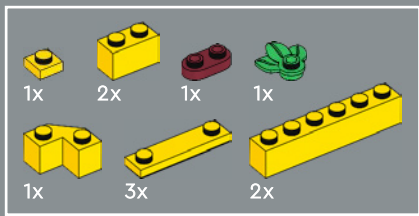

56

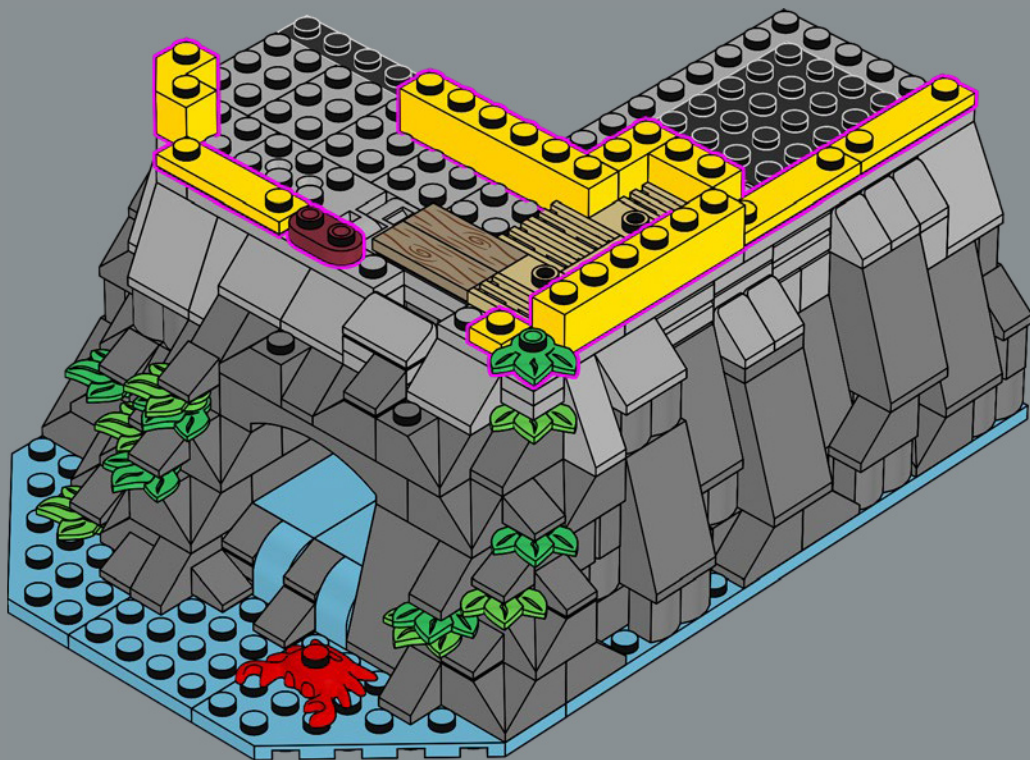



57

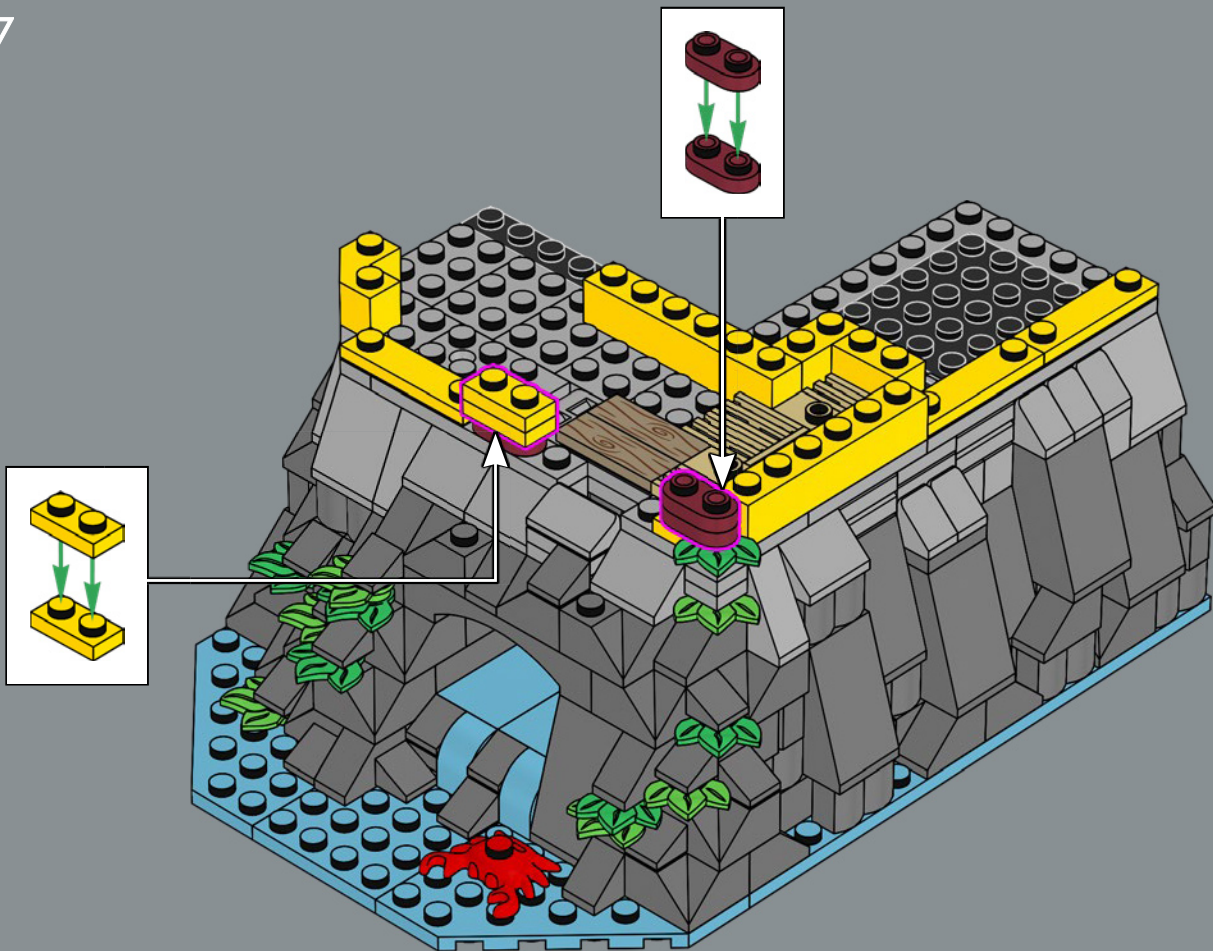

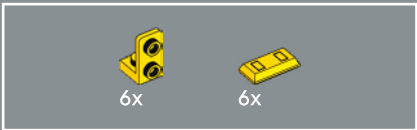

58

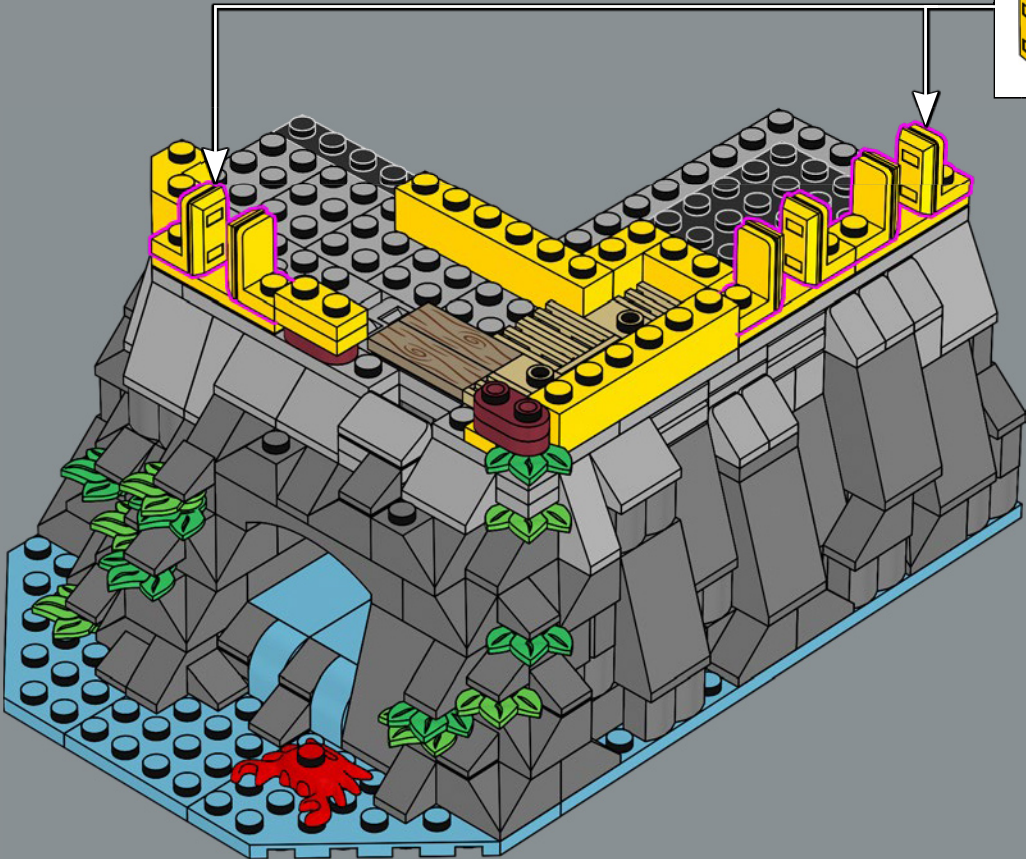
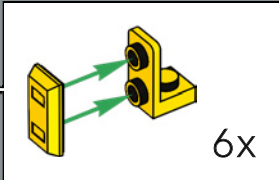



4x



1x

59

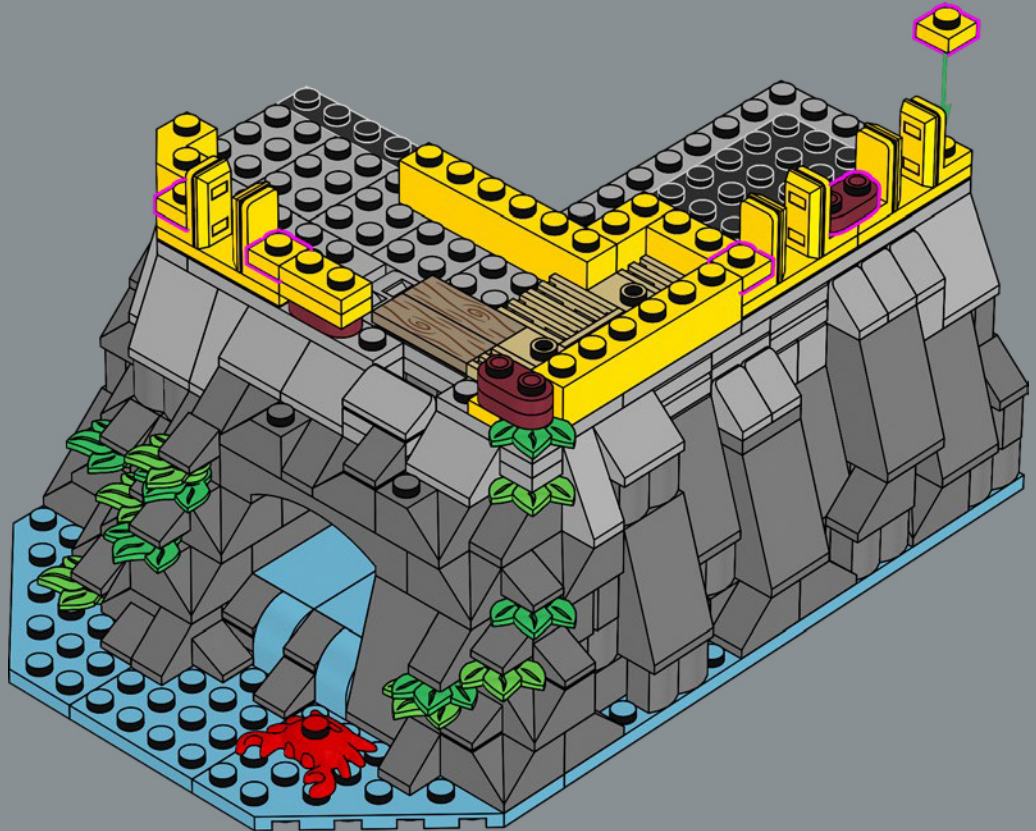



Le cose sono migliorate anche per i pirati prigionieri! Ora possono riposare comodamente su un materasso di fieno.



60

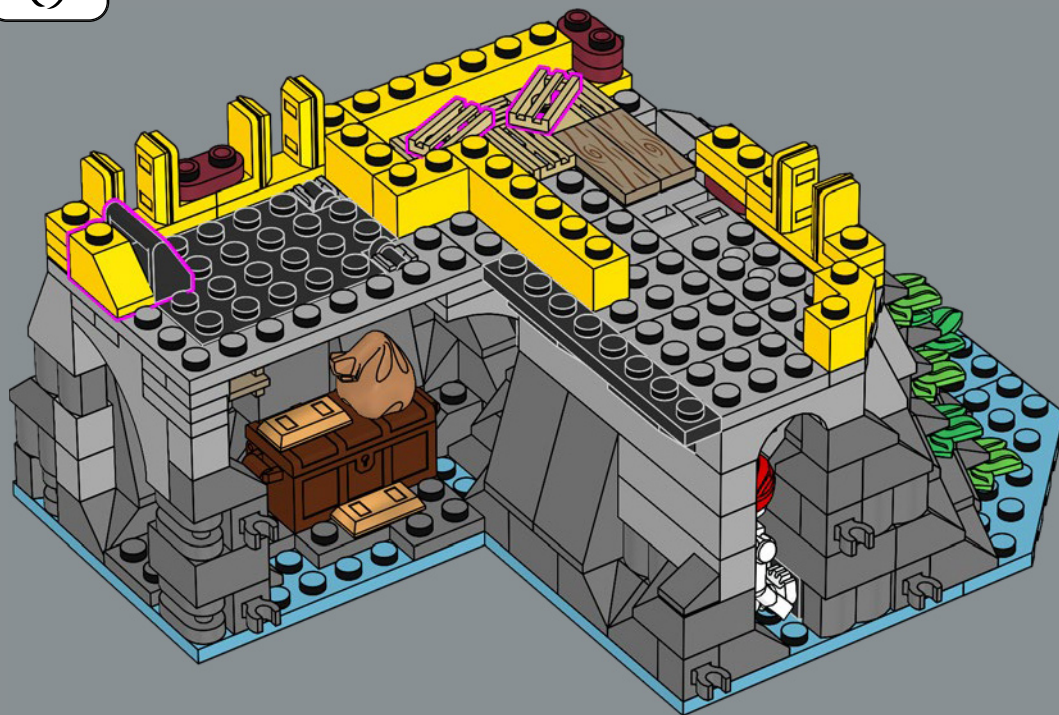



2x



2x



2x

61

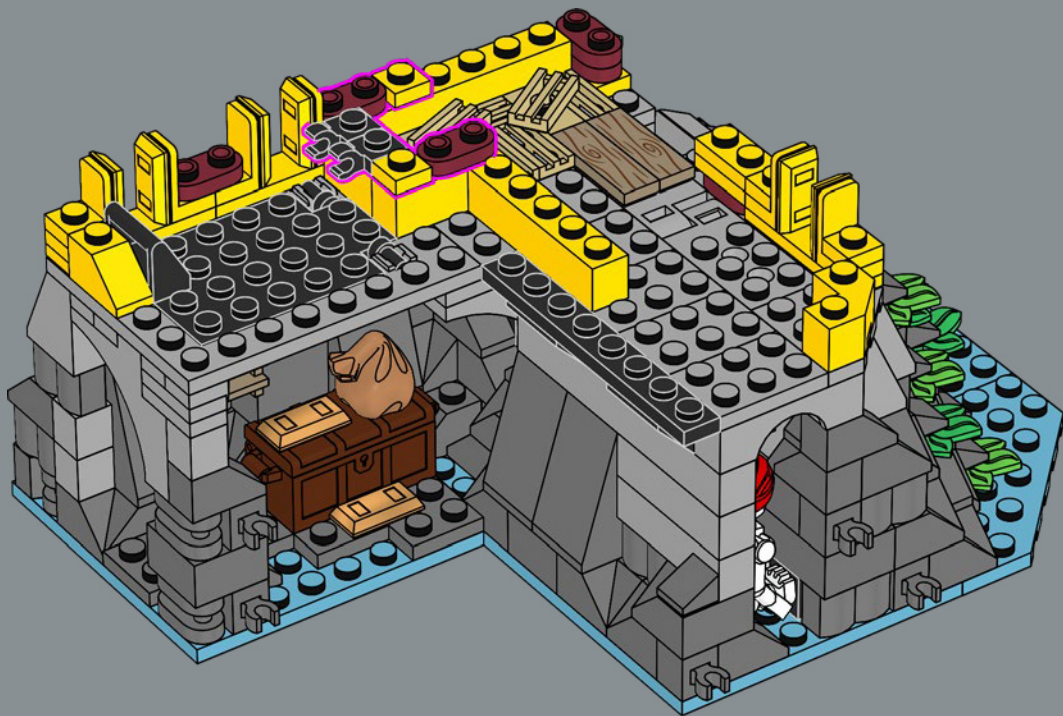



62

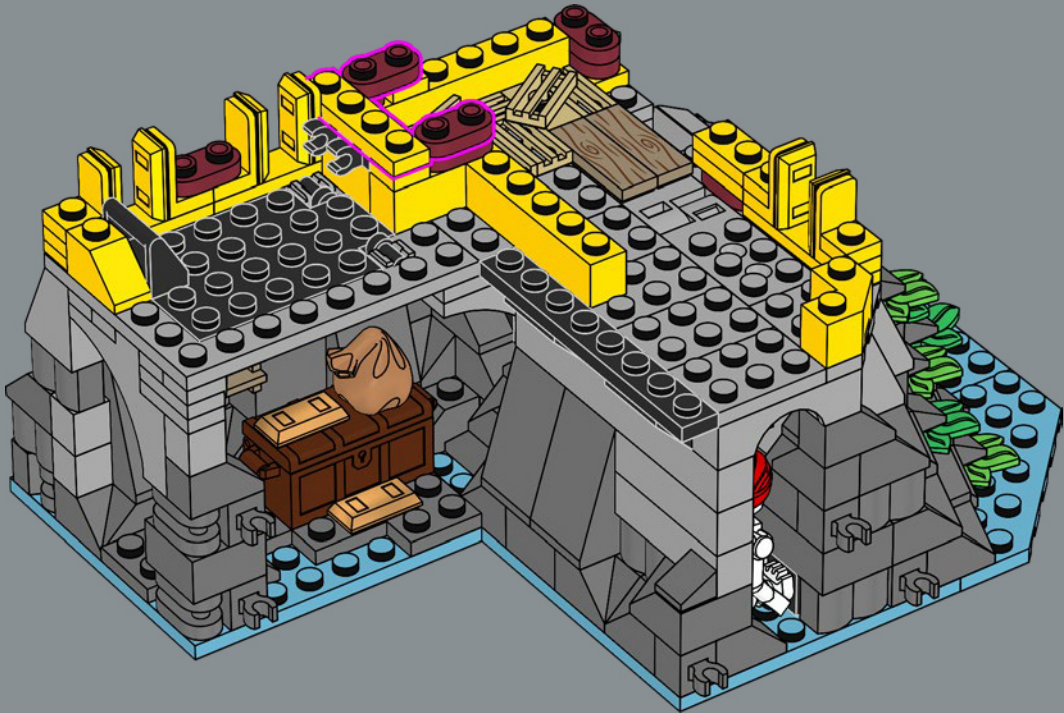

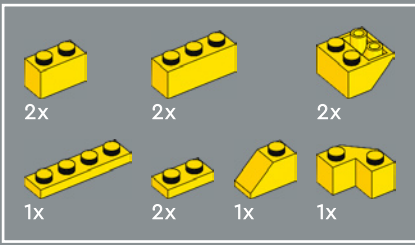

63

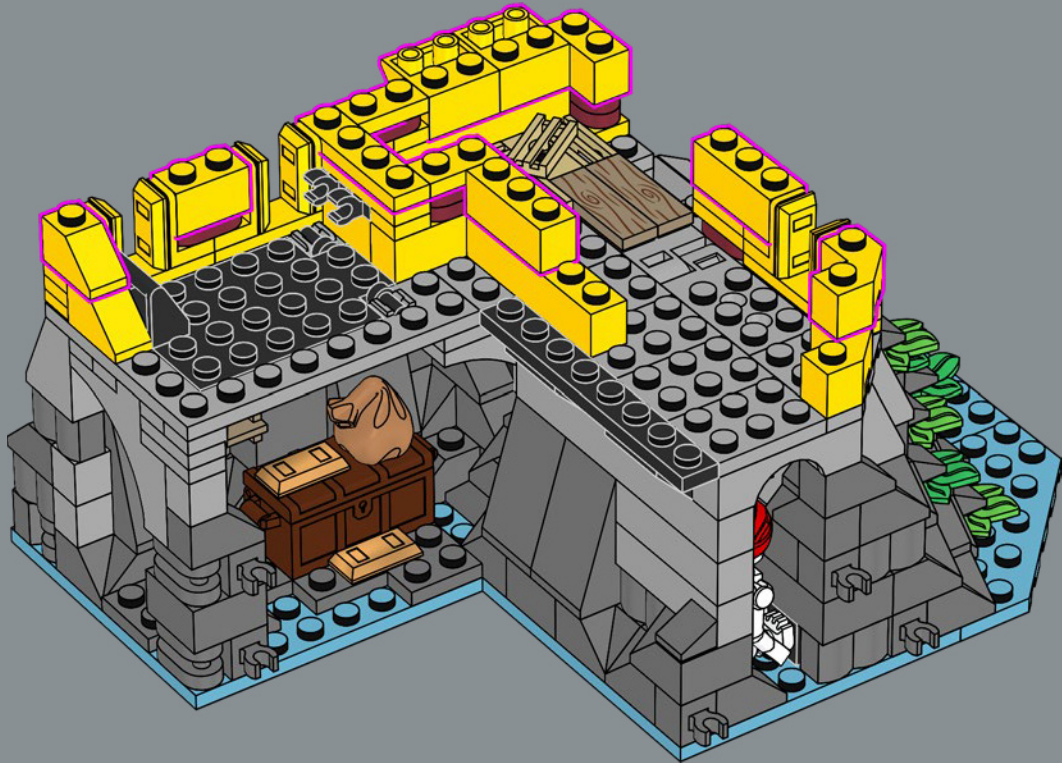



64

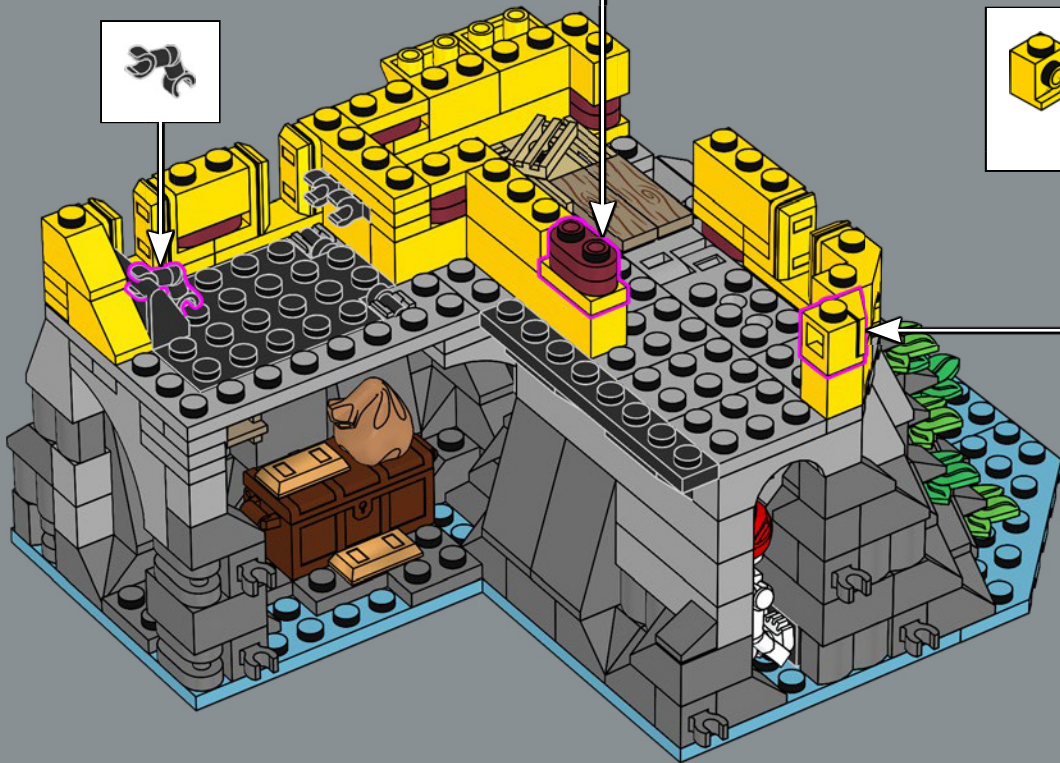
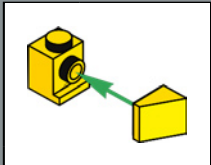
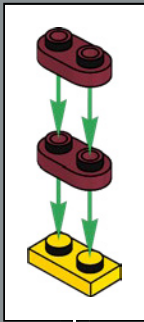

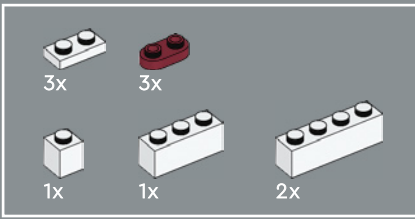

65

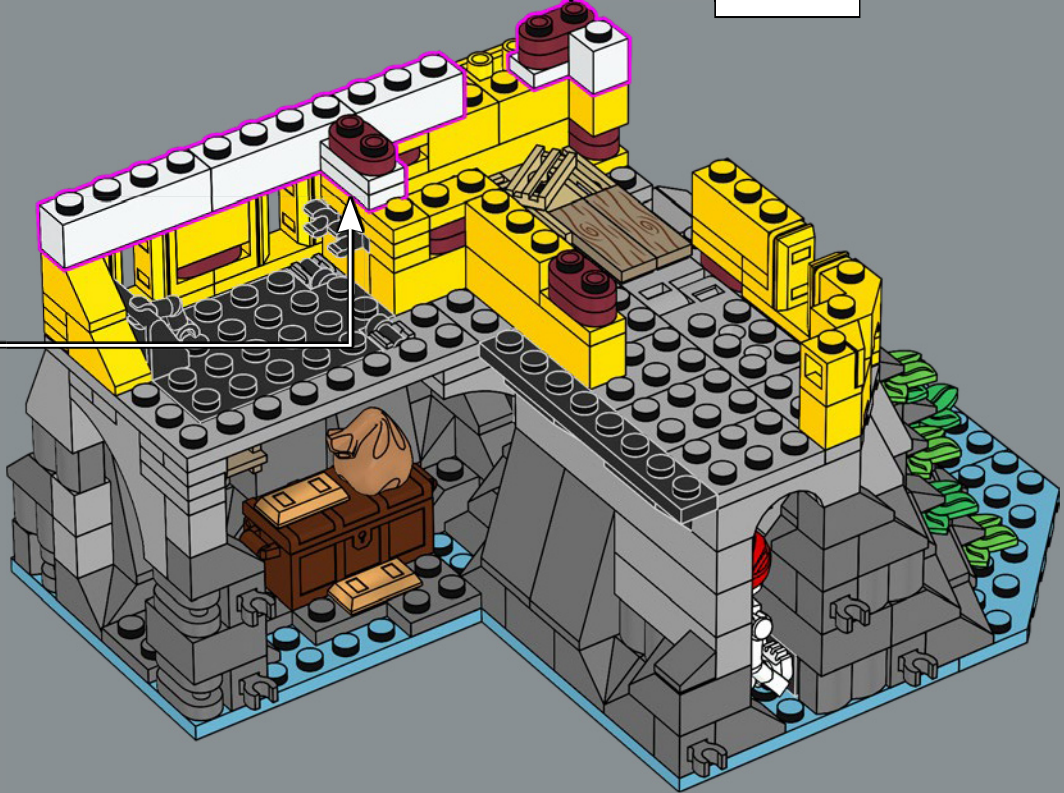
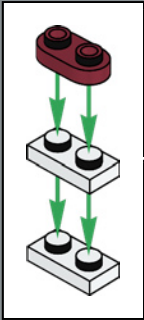
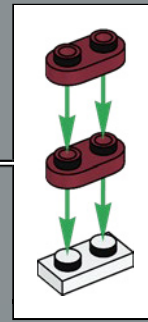

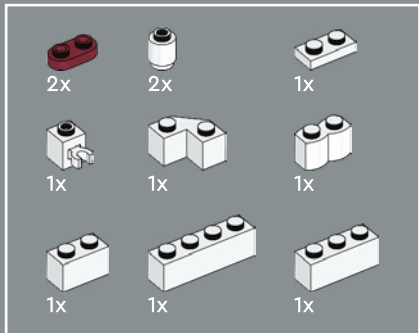

66

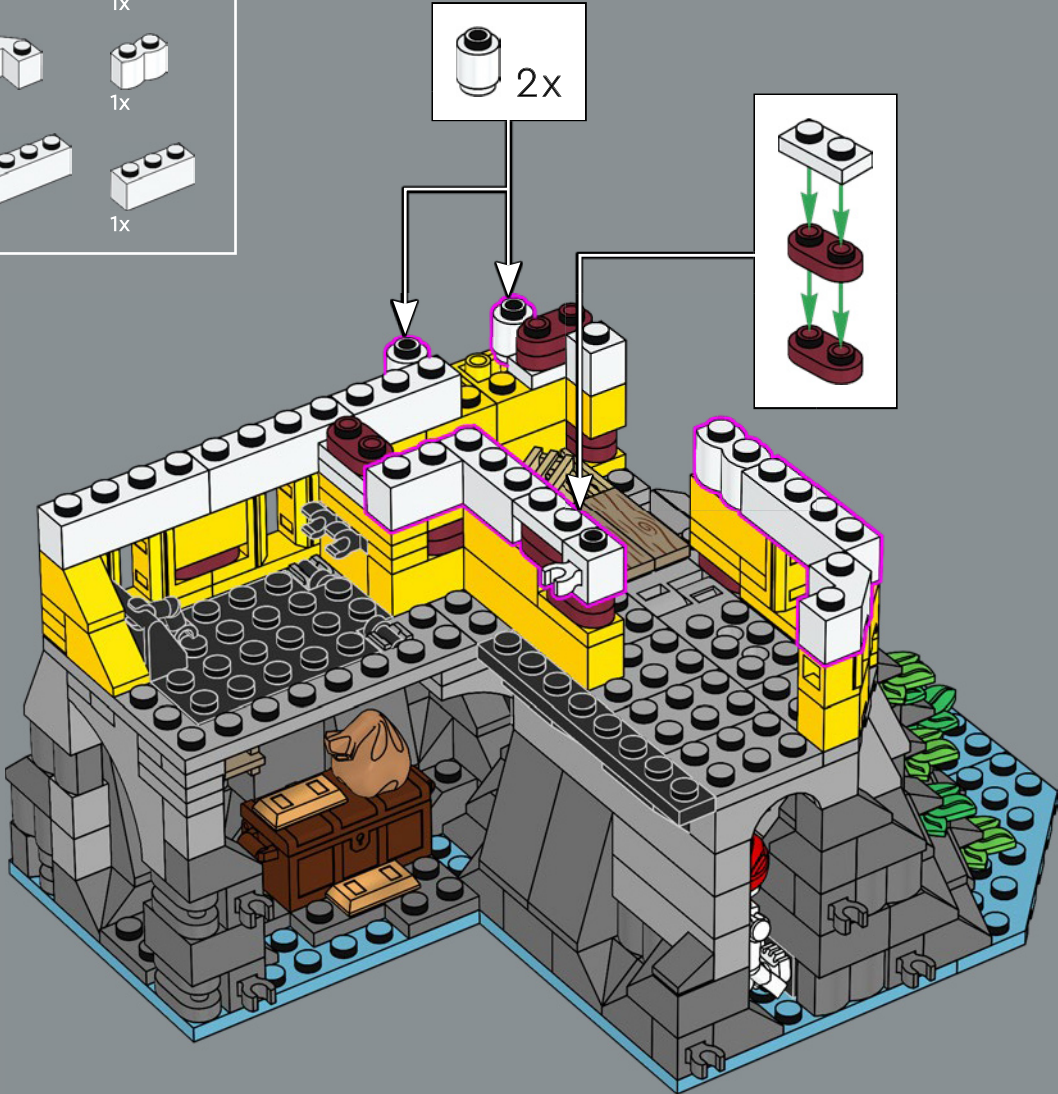
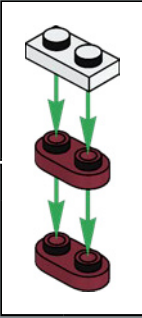
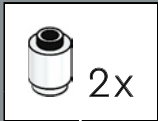

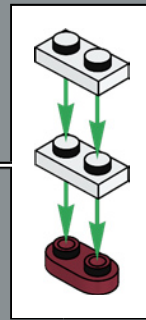
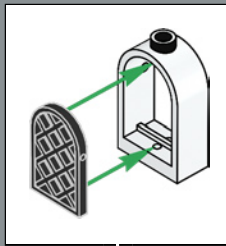
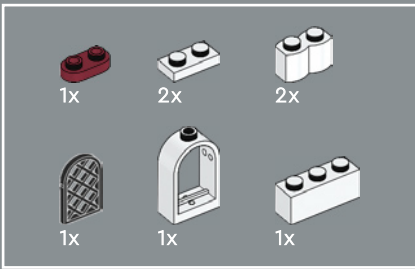

67

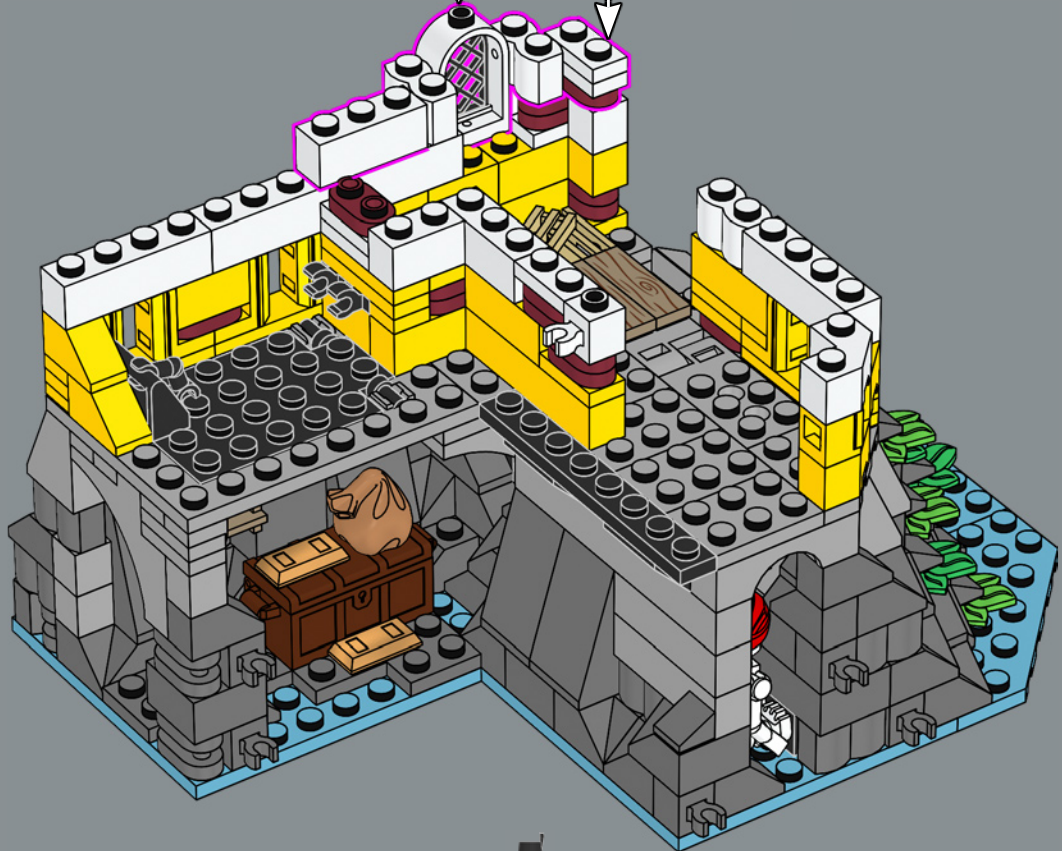

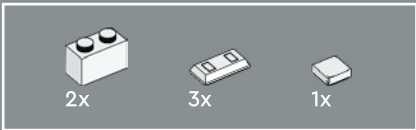

68

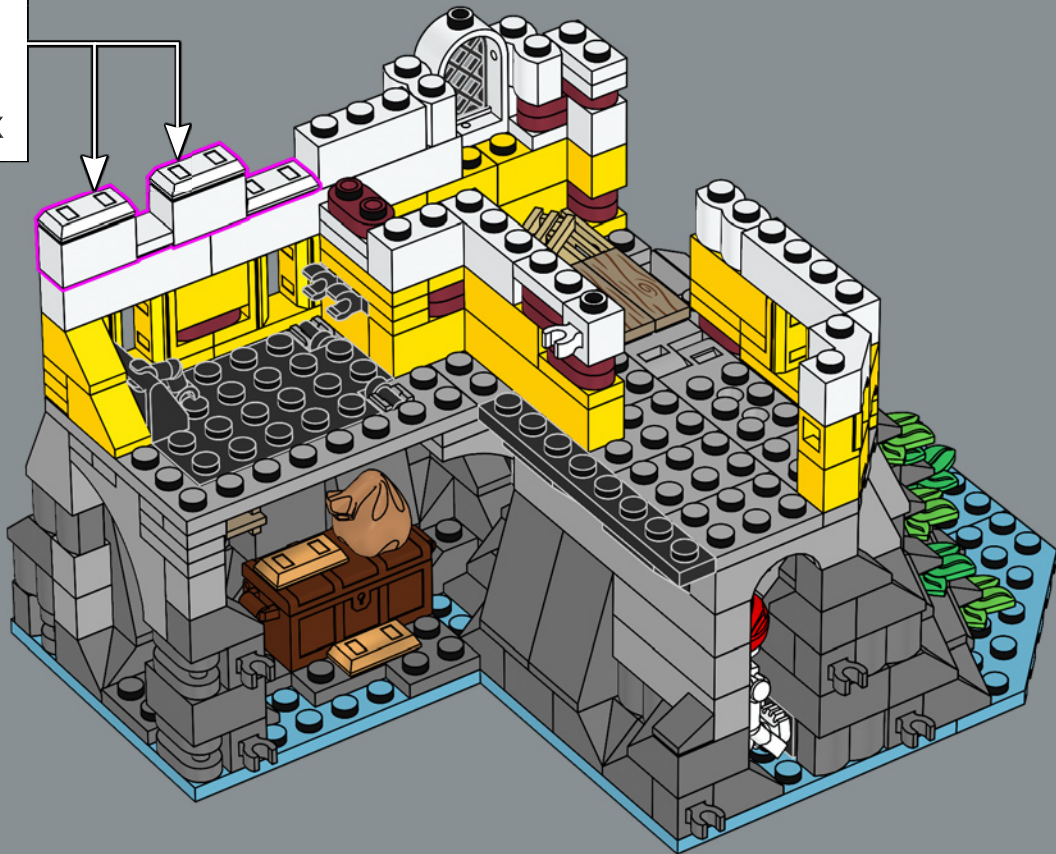
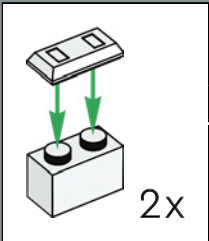

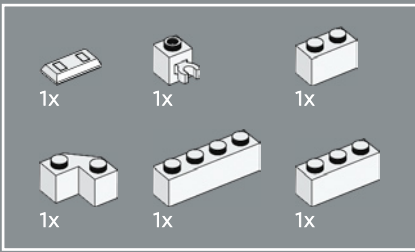

69

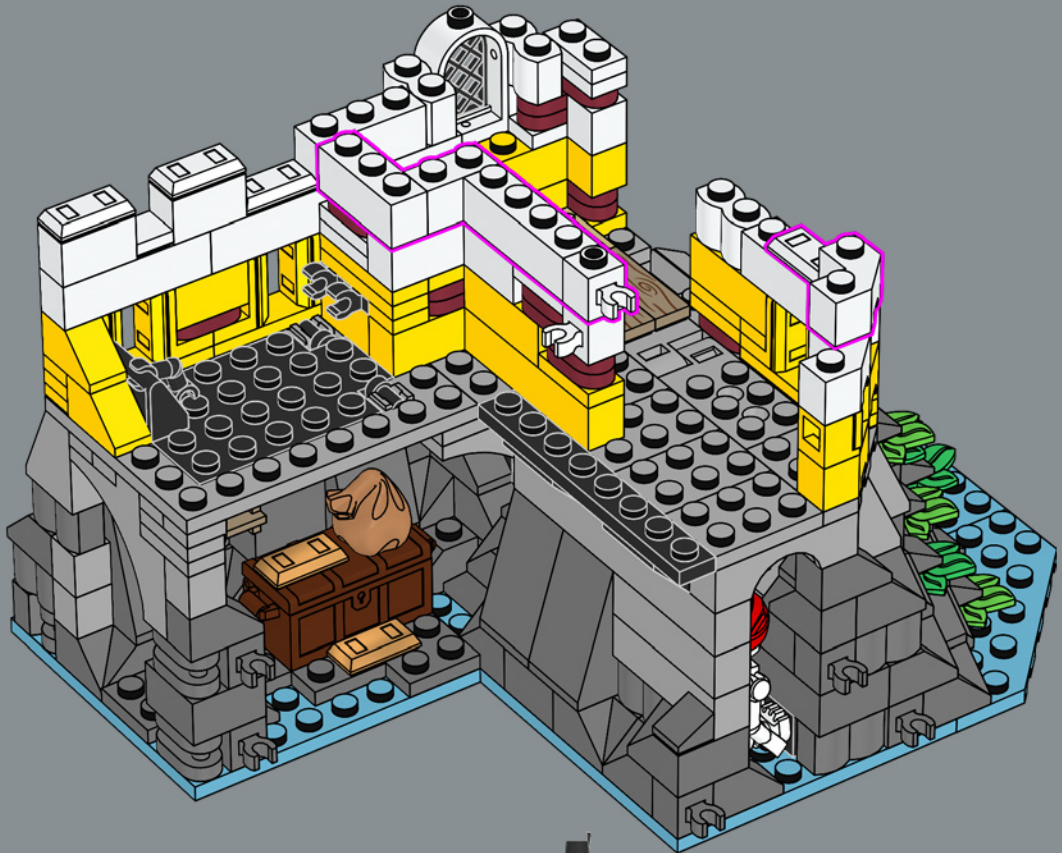

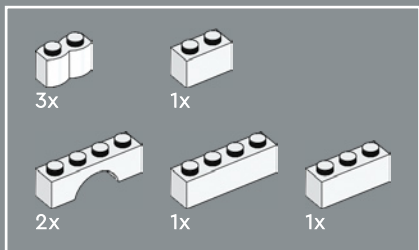

70



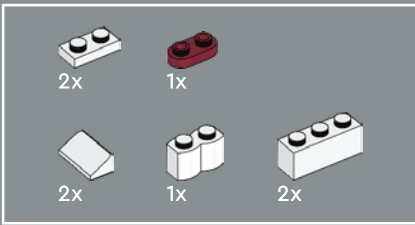

71

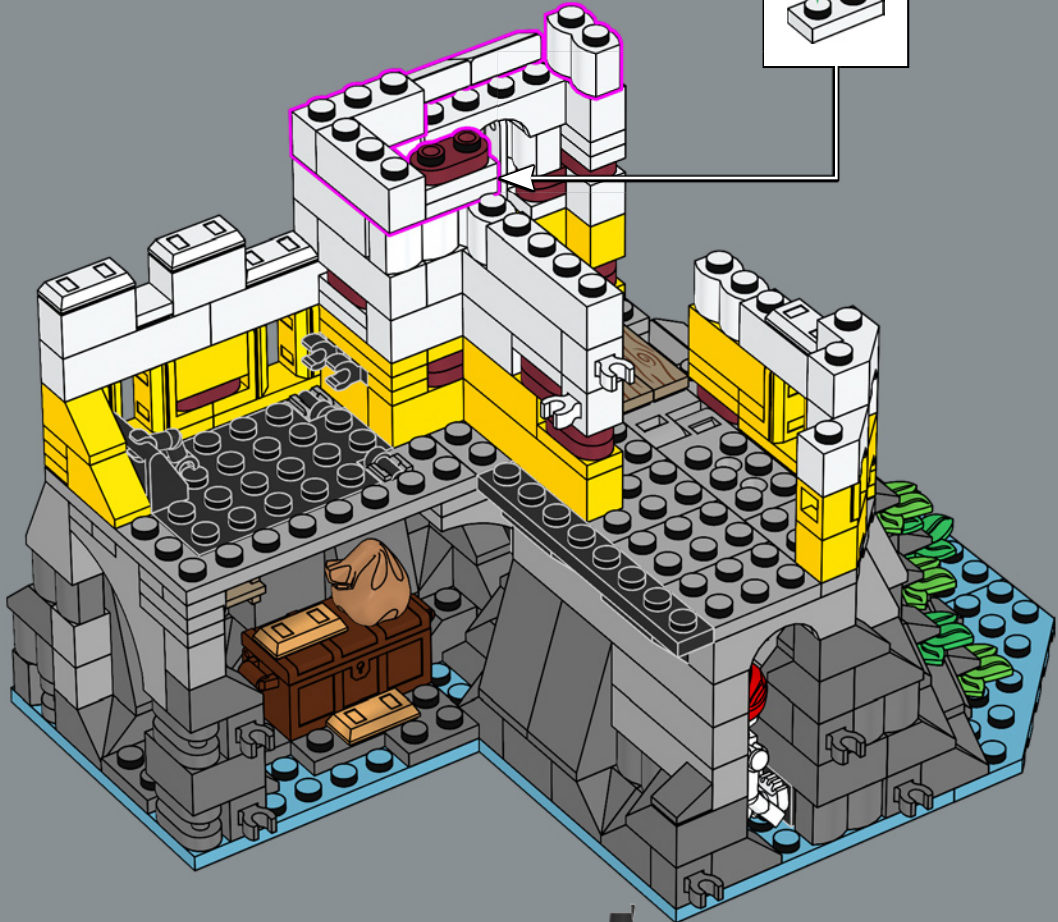
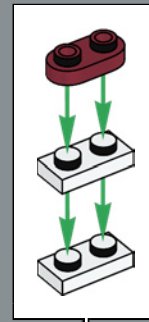

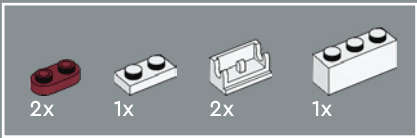

72



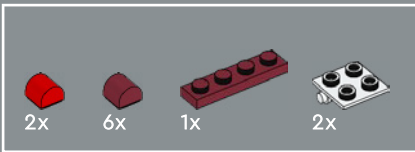

73

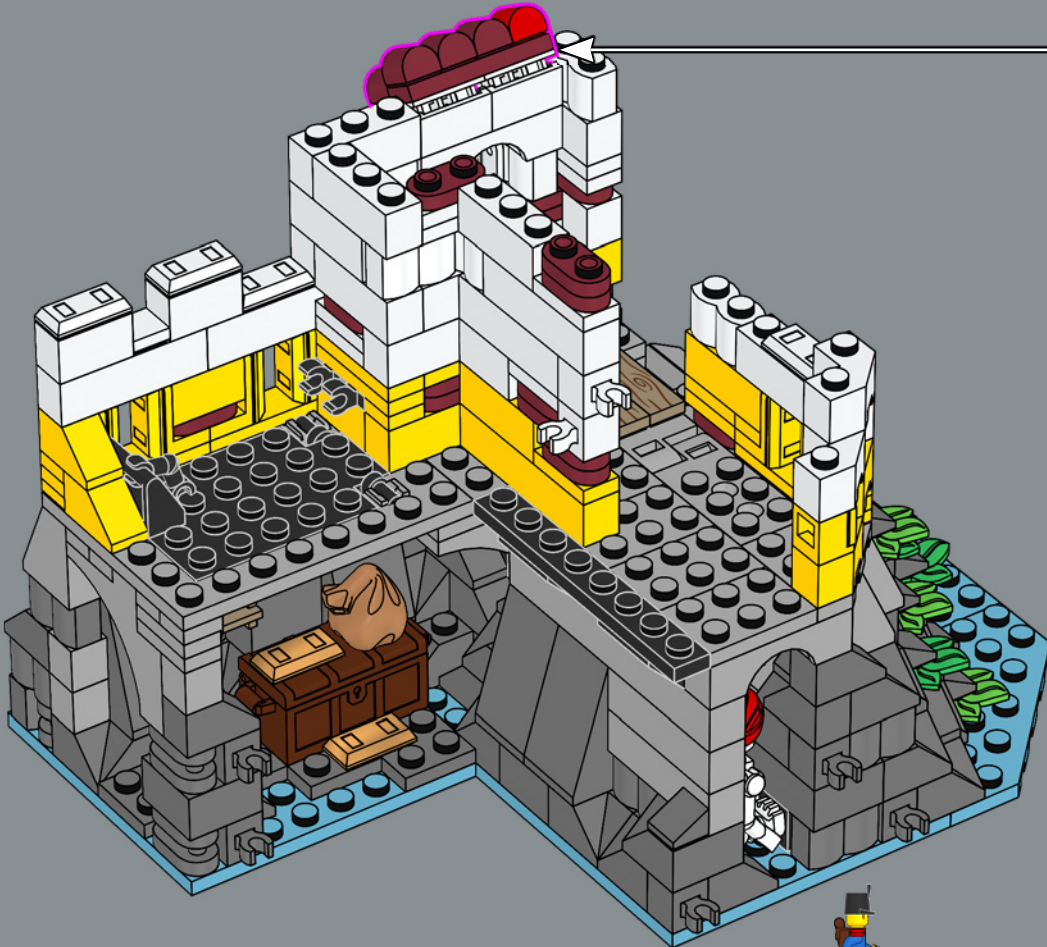
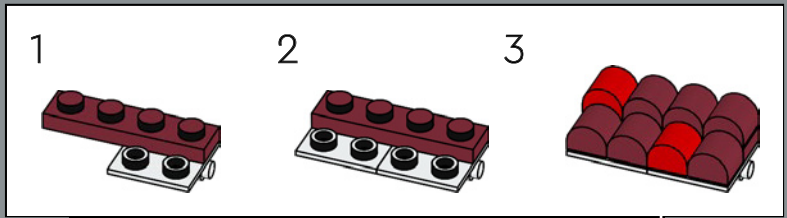

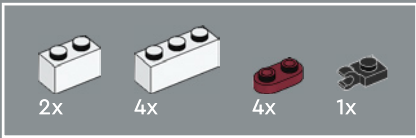

74

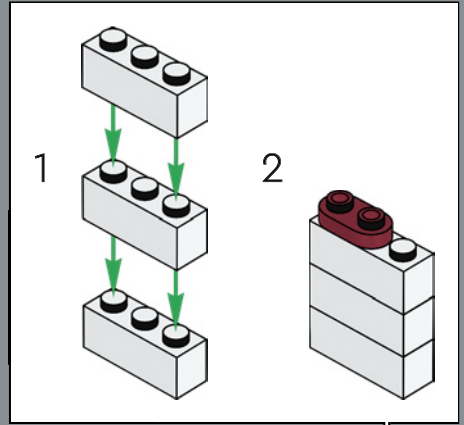
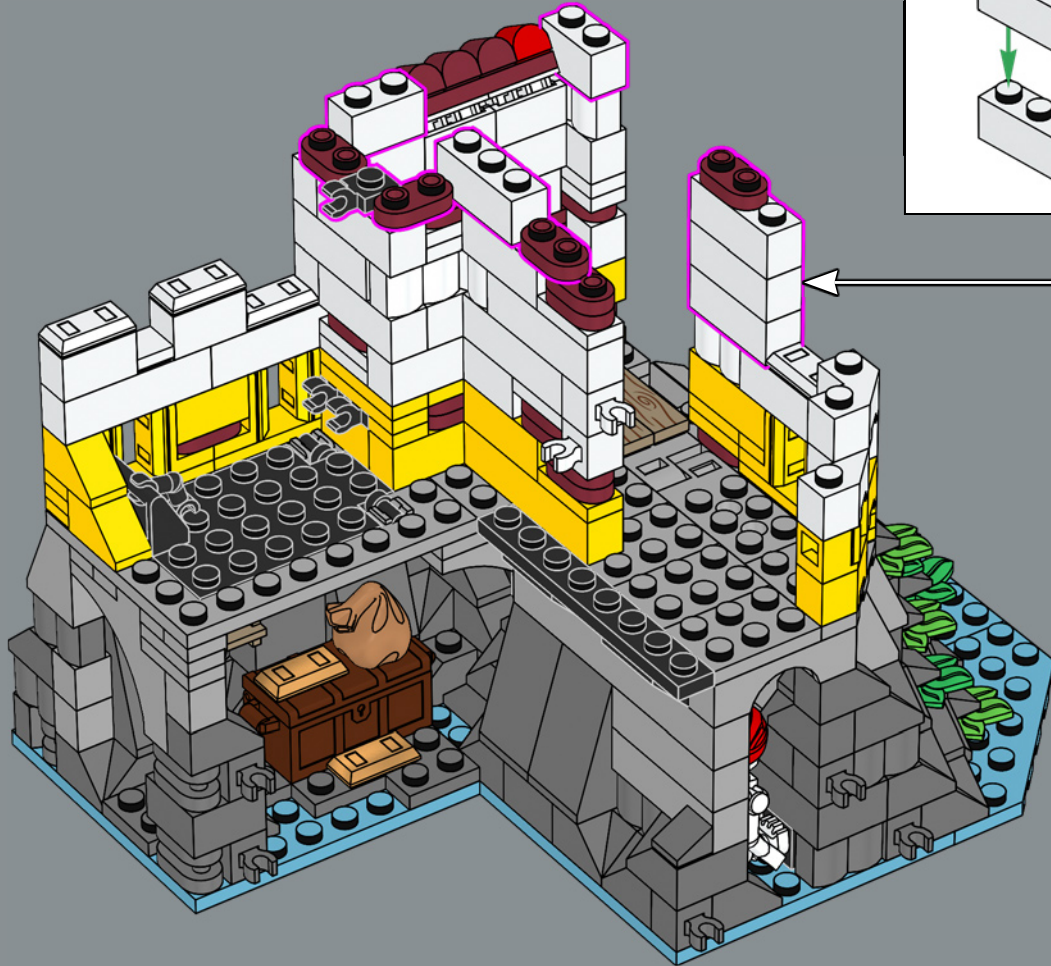

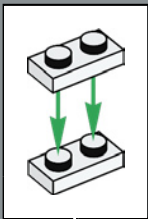
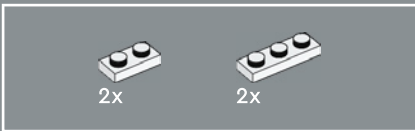

75

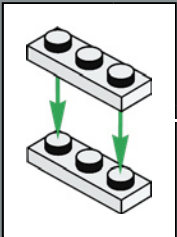

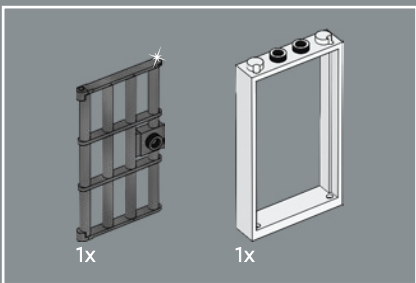

76

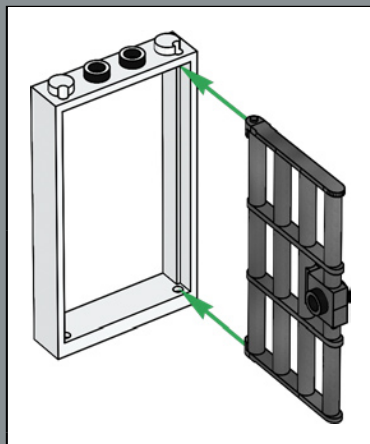

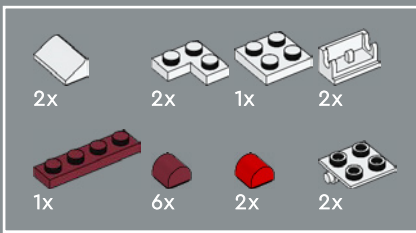

77

1



2

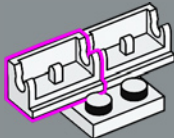

3

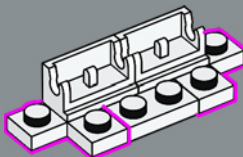

4

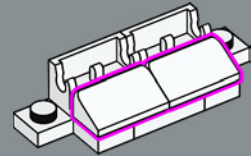

5

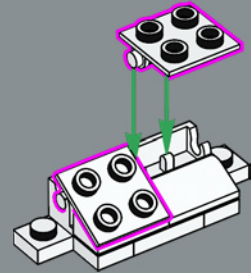

6

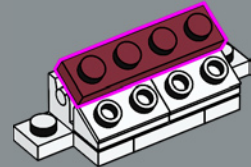

7

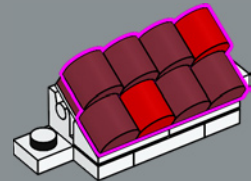

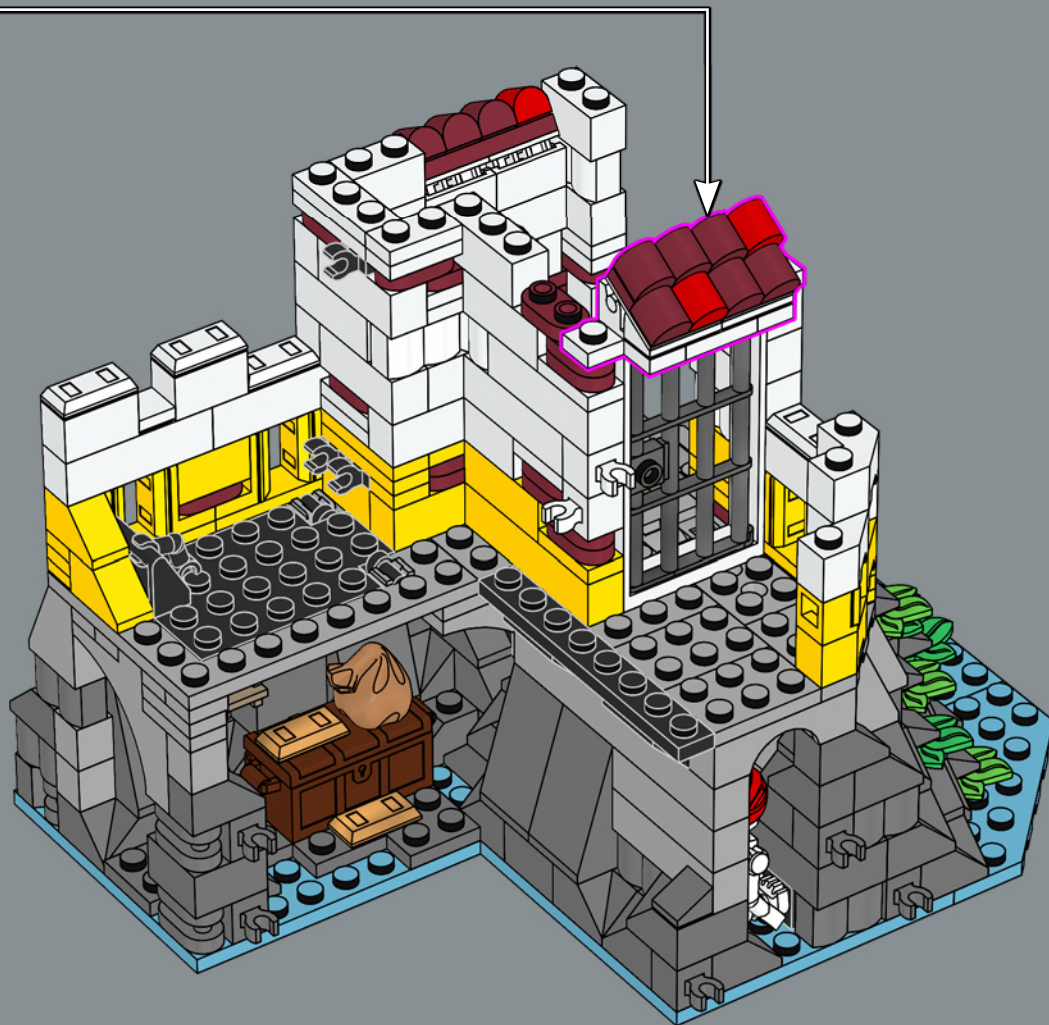



78

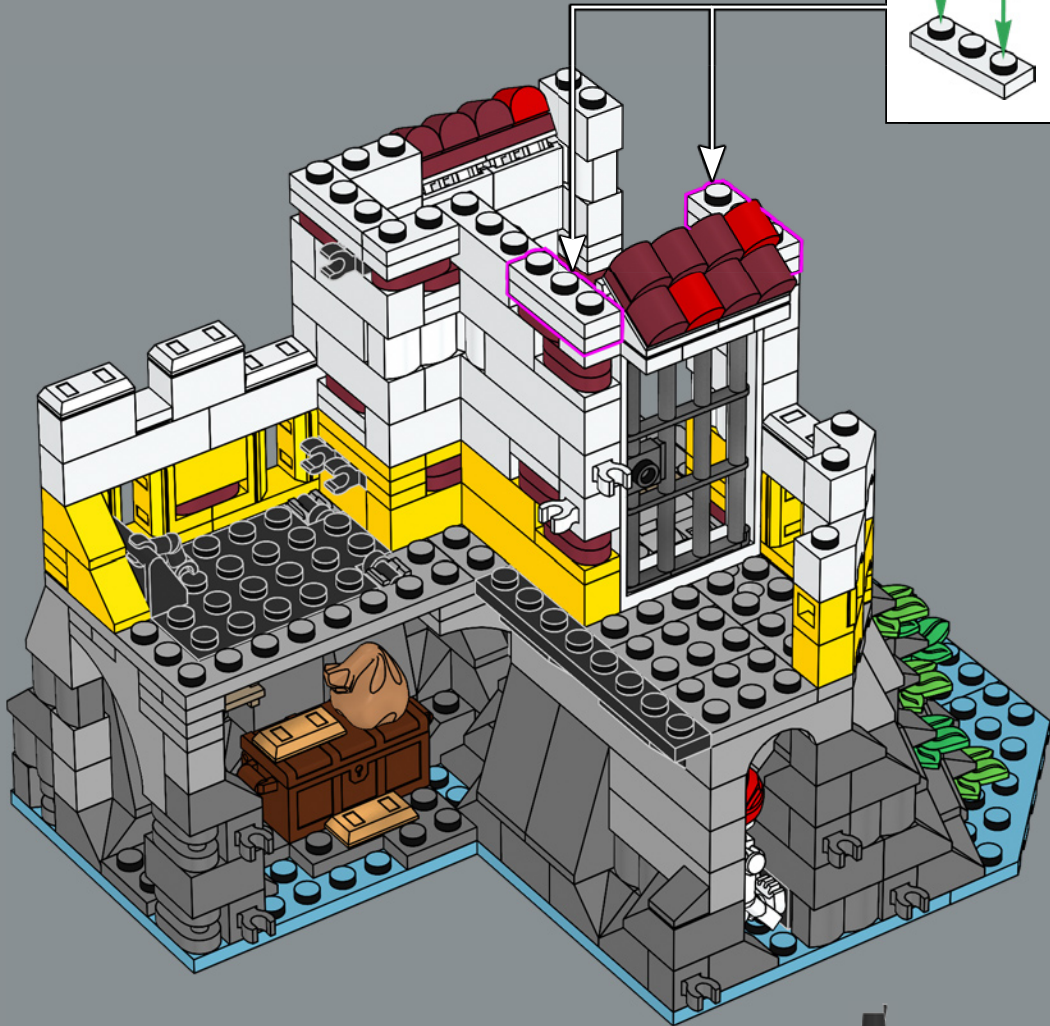
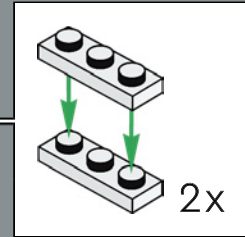

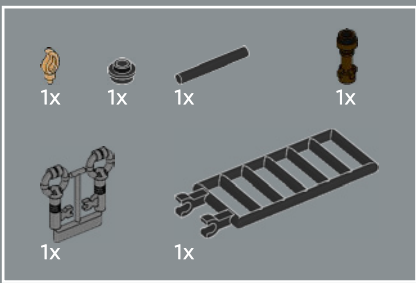

79

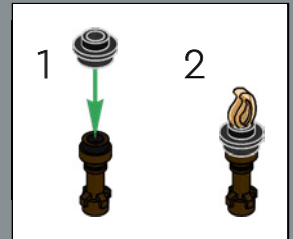
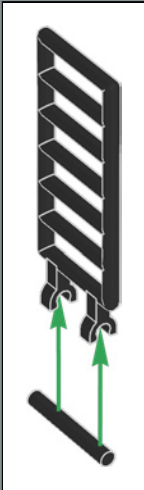

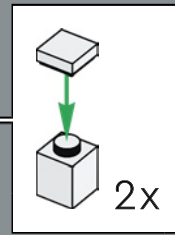
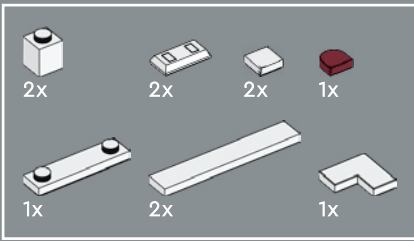

80

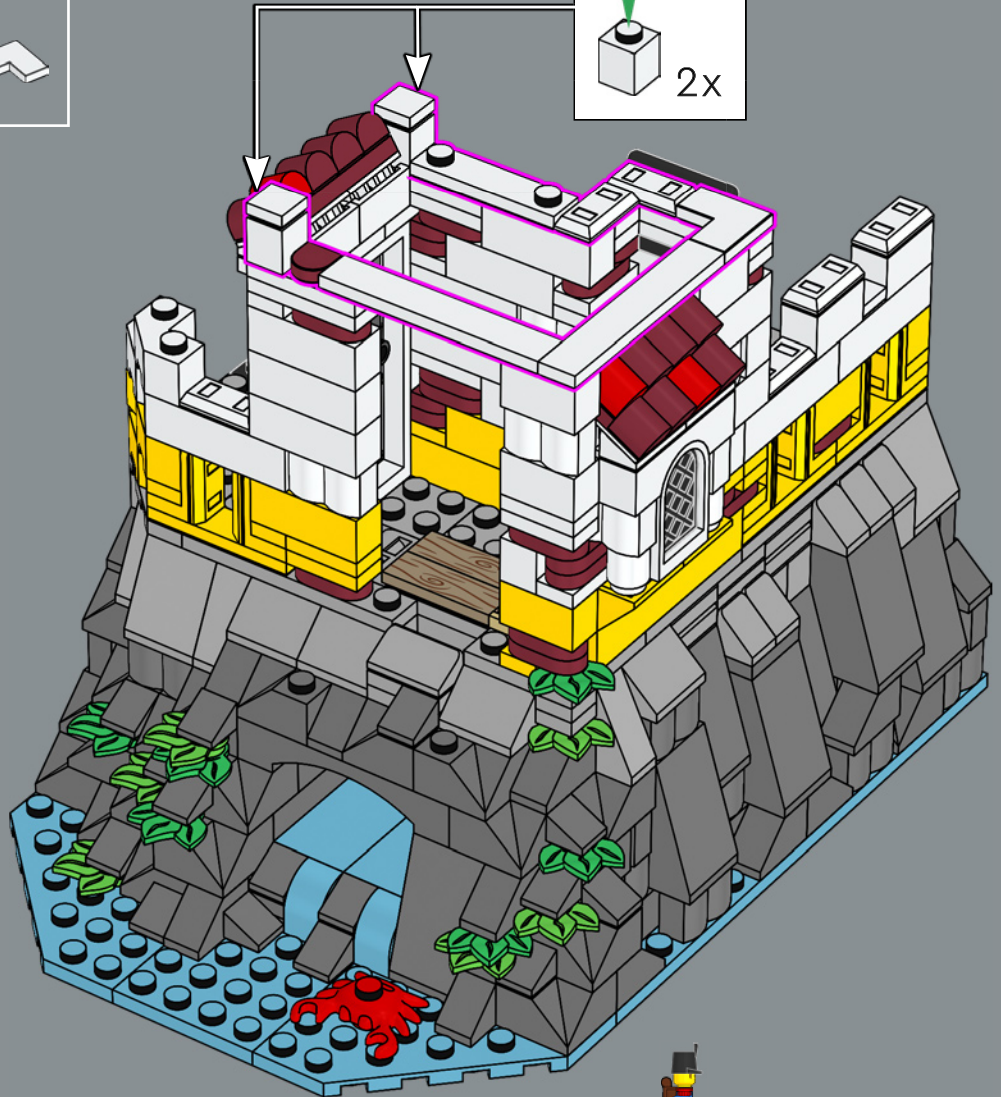

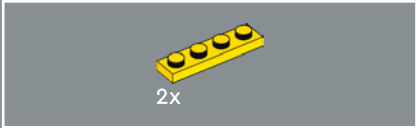
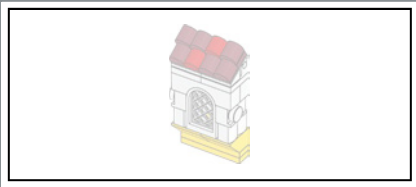

2x

81

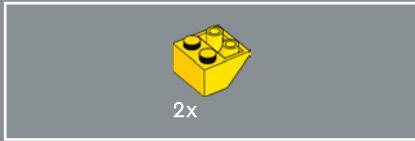
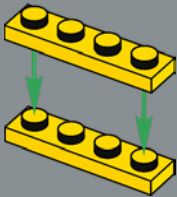

2x

82

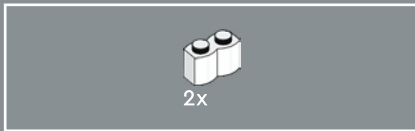
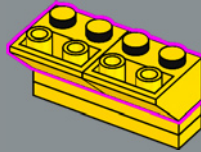

2x

83

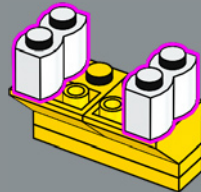



84

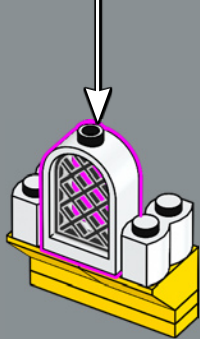
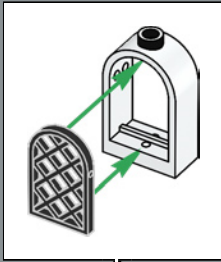

85

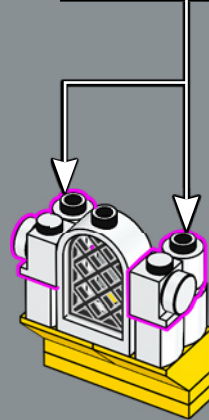
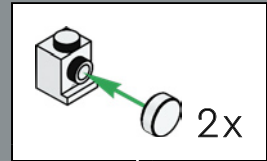

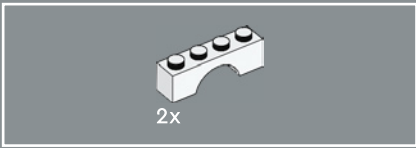

86

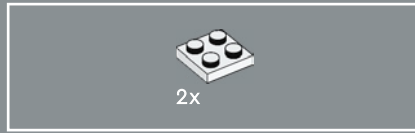
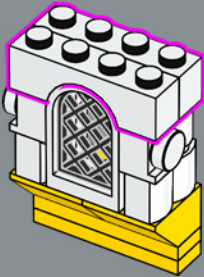

87

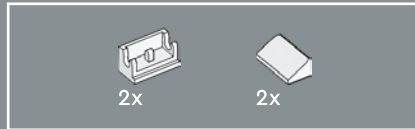
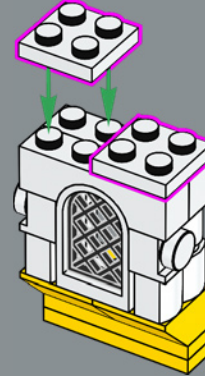

88

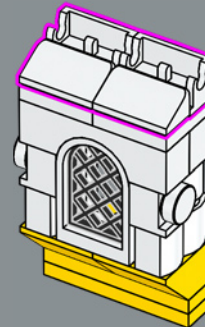



89

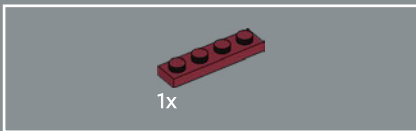
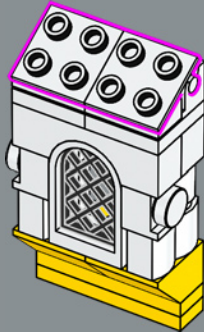

90



91





Il tetto e alcune finestre possono essere rimossi per accedere alle stanze interne.

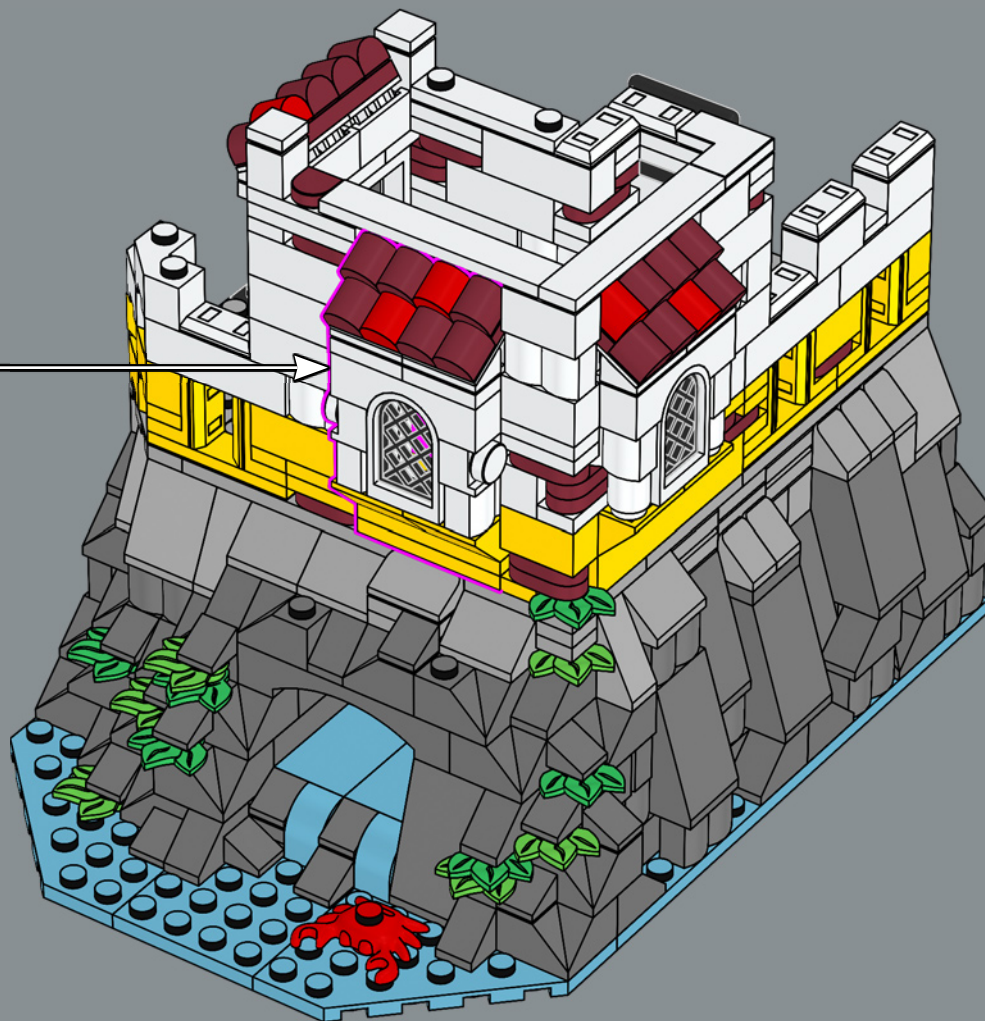

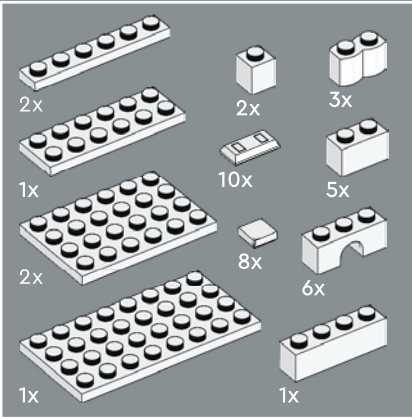
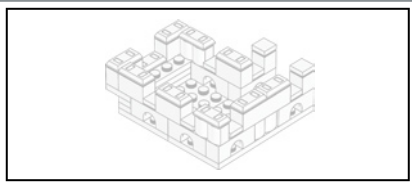

93

1

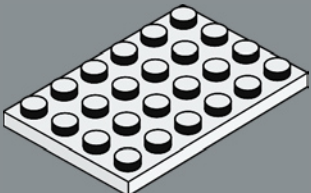

2

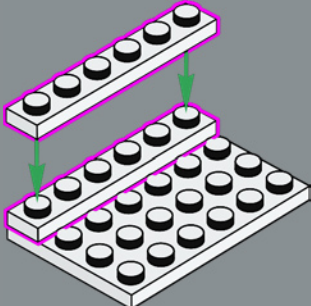

3

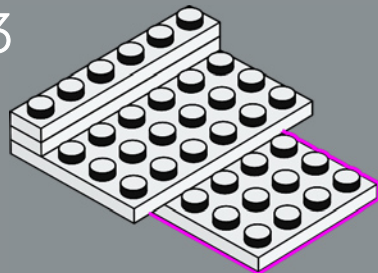

4

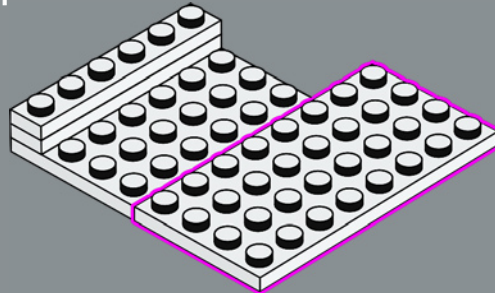

5

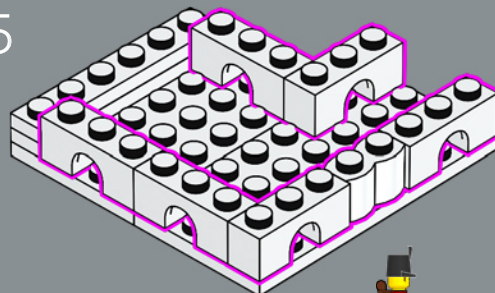

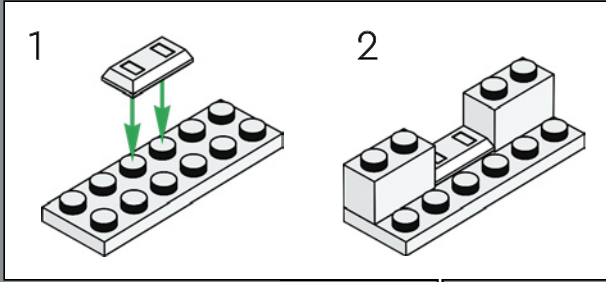

6

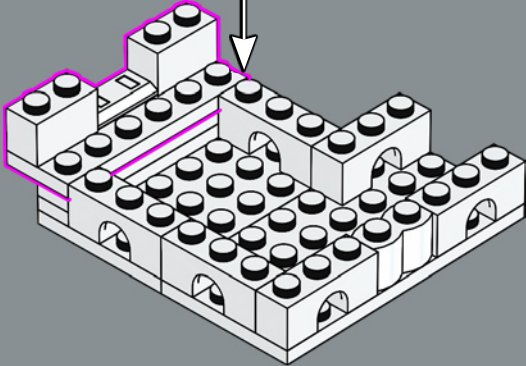

7

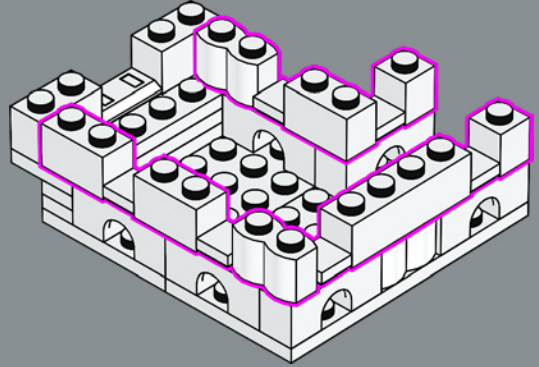

8

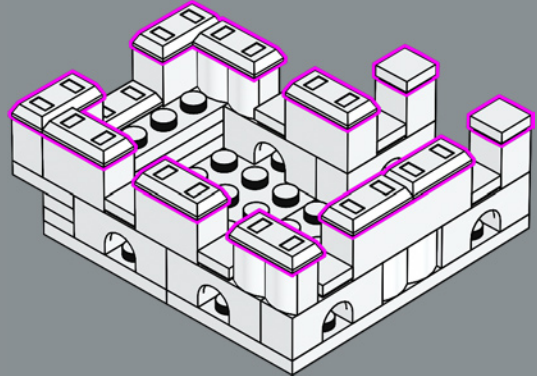

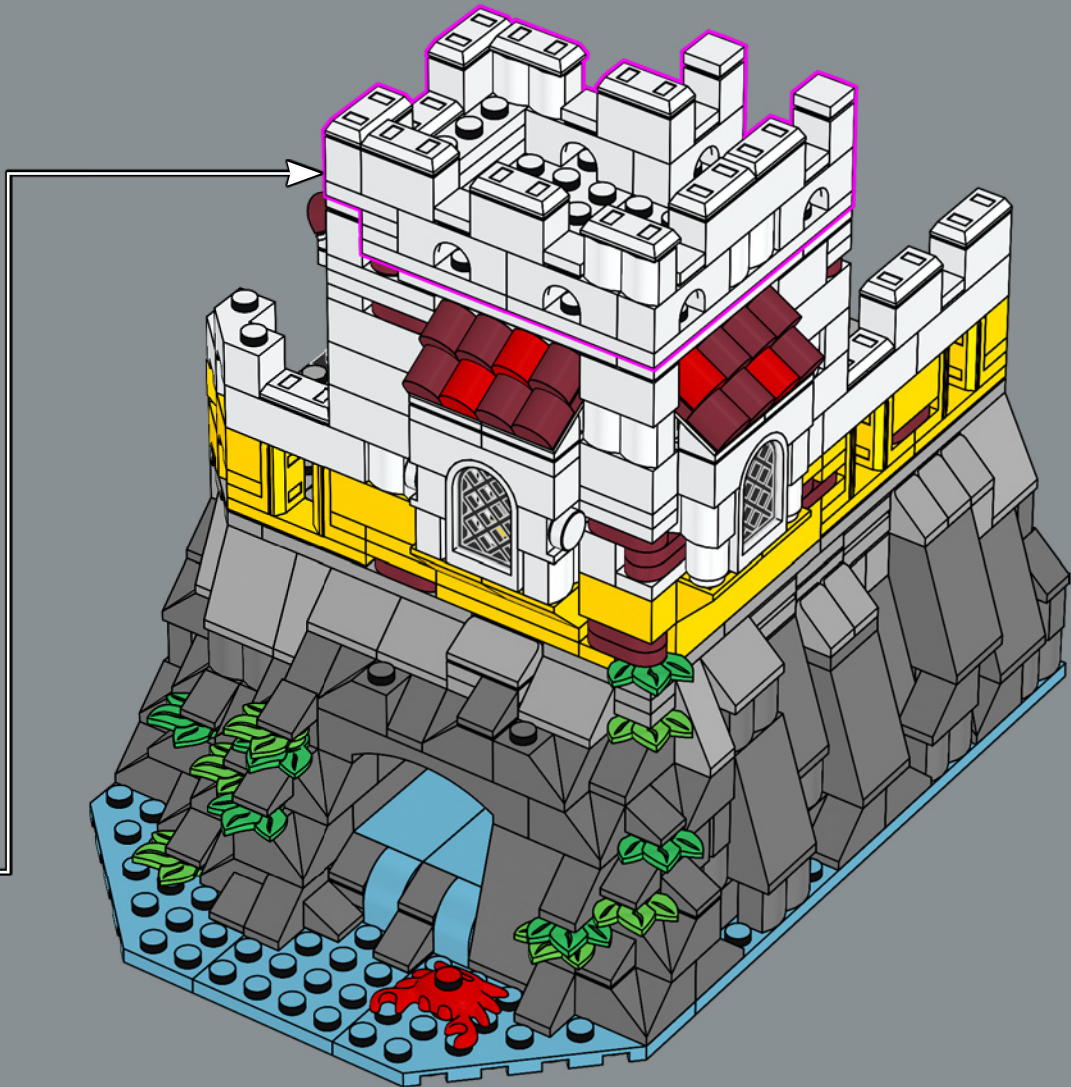



Il modello può essere aperto per mostrare in modo più dettagliato le prove e le tribolazioni, ma anche la galezza, della ciurma (e dei loro prigionieri).

94



1

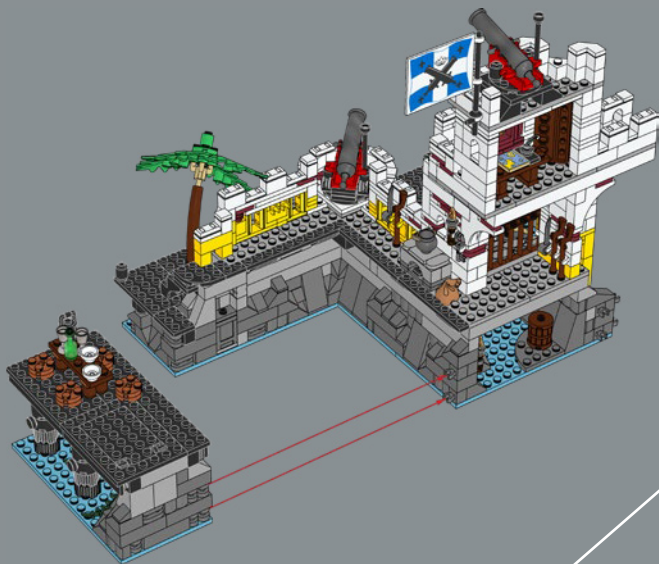

2

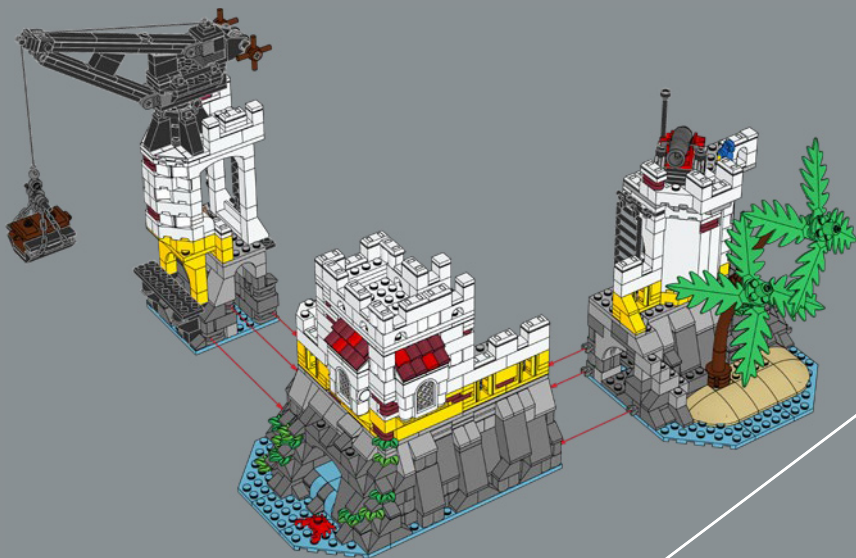

3

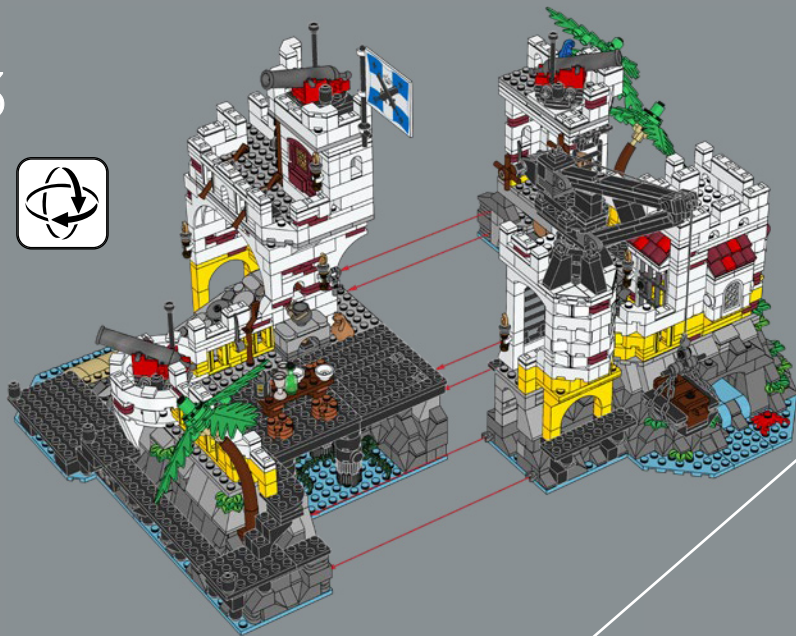



LEGO and the LEGO logo are trademarks of the LEGO Group.
©2023 The LEGO Group.