

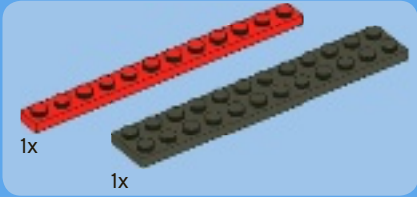

10220

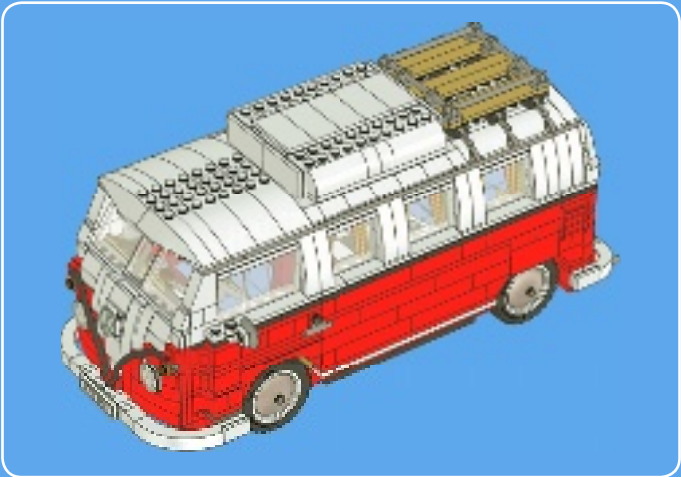



1

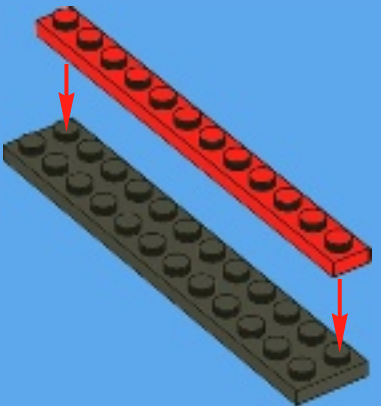

2

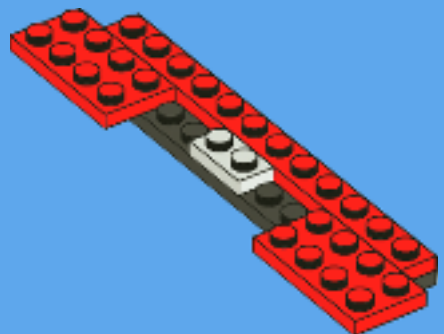

3

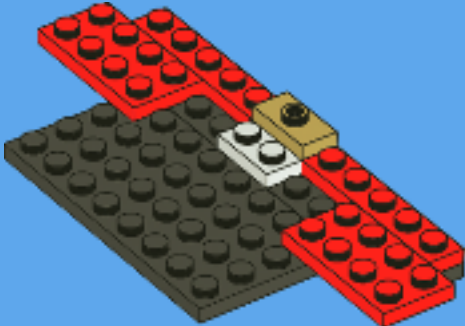

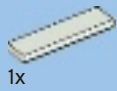

1x



2x



2x



1x

4

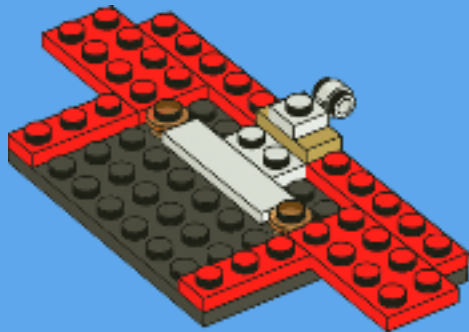

2x



1x



2x

5

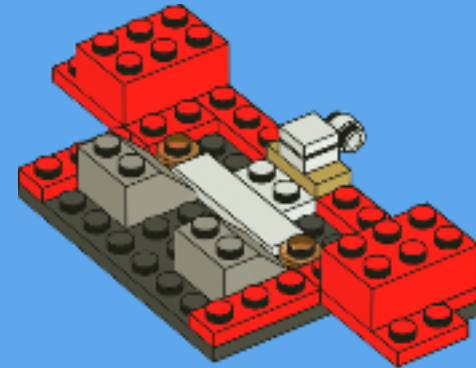

1x



4x

6

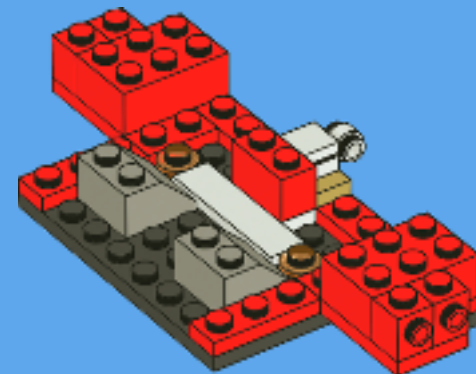

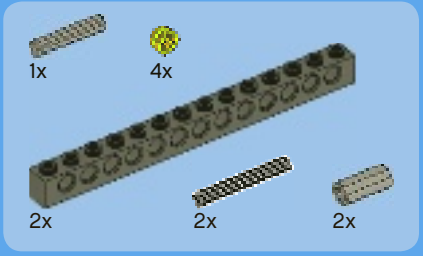

7

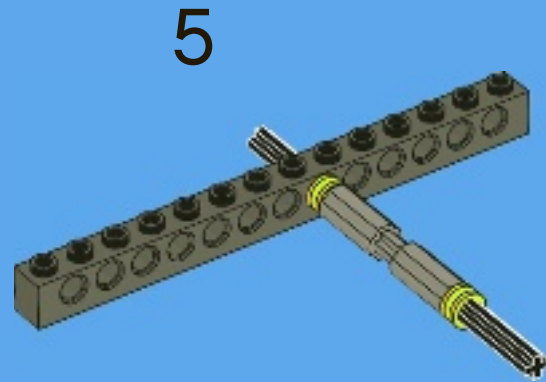
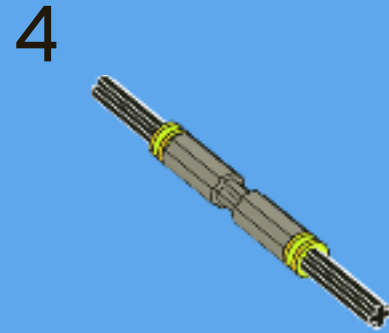
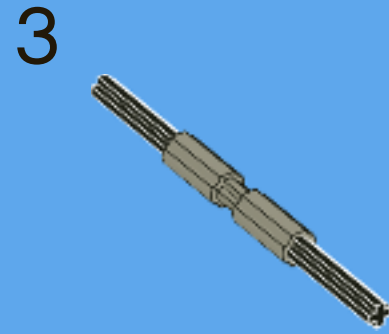
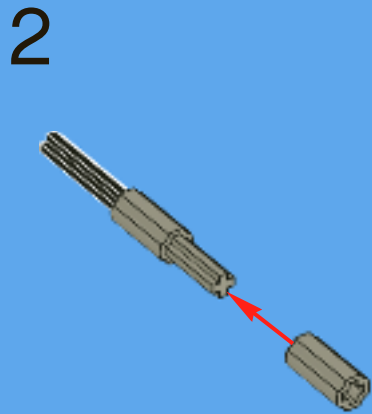
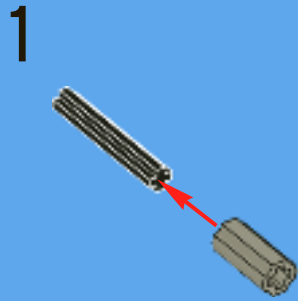

6

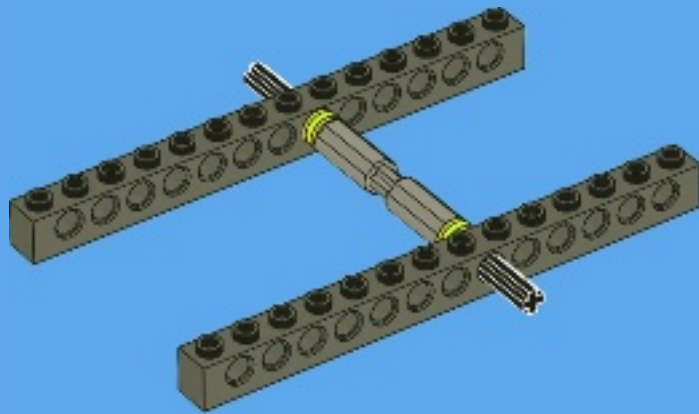

7

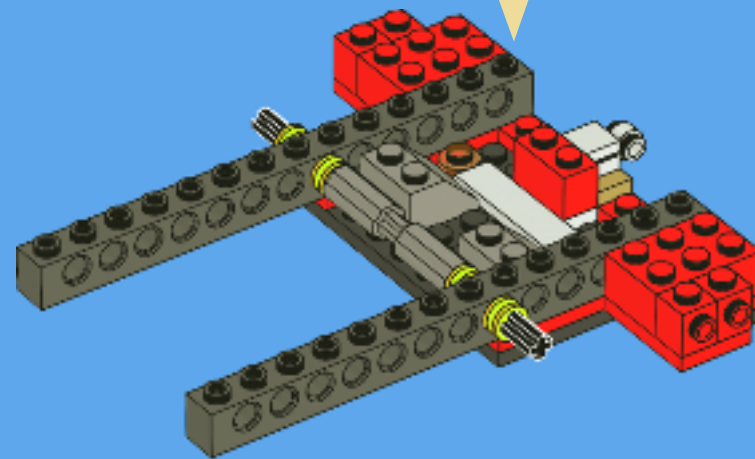
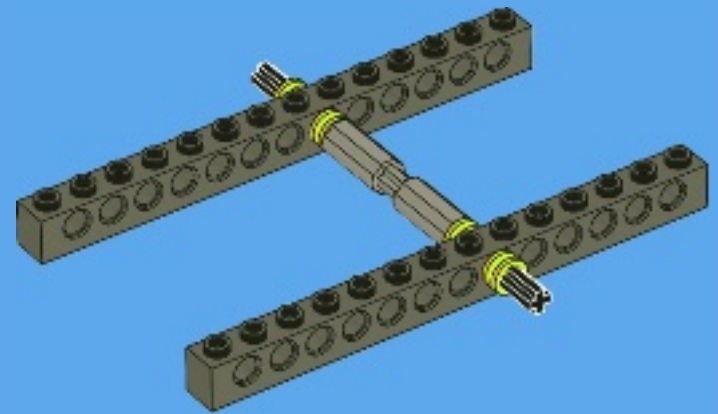



1x



2x

8

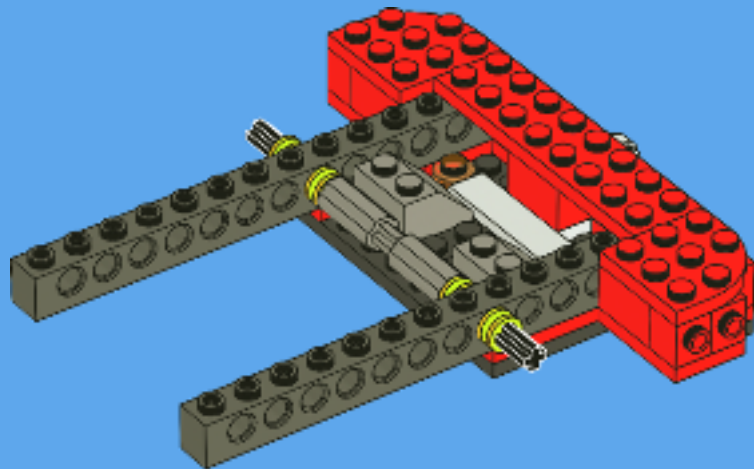

2x



2x



4x

9

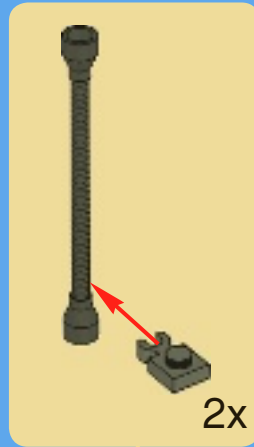

2x

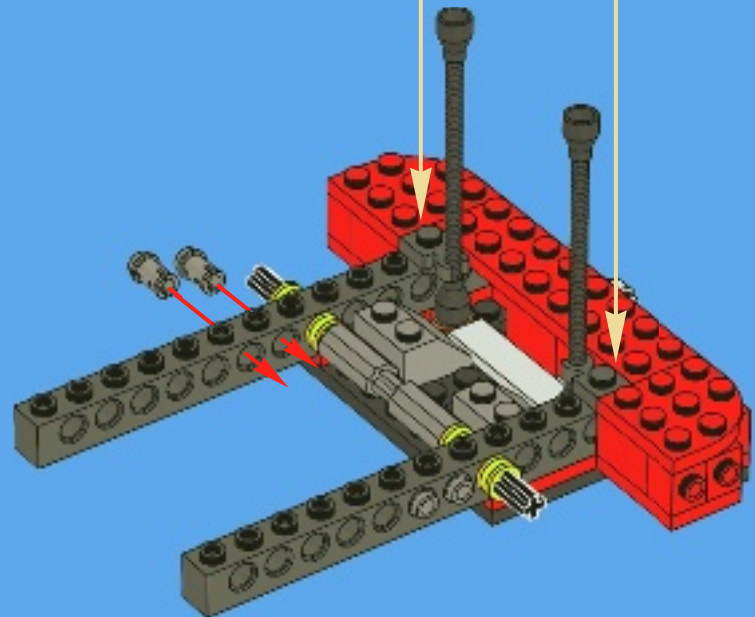



1

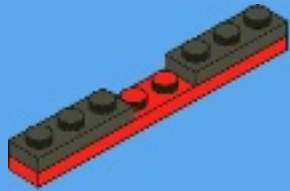

2

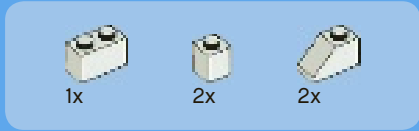
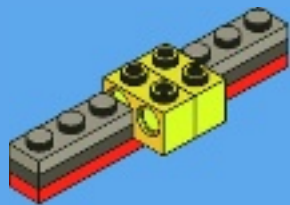

3

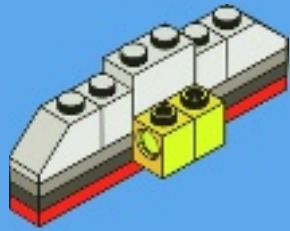

4

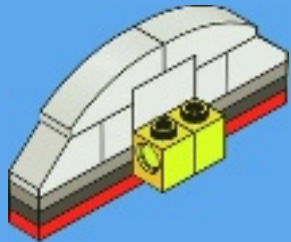



2x

5

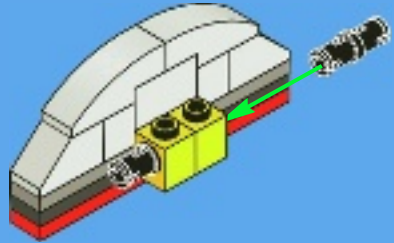

2x



2x

6

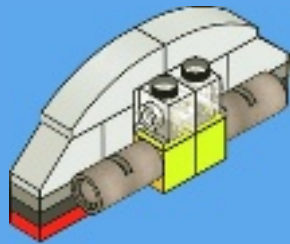

10

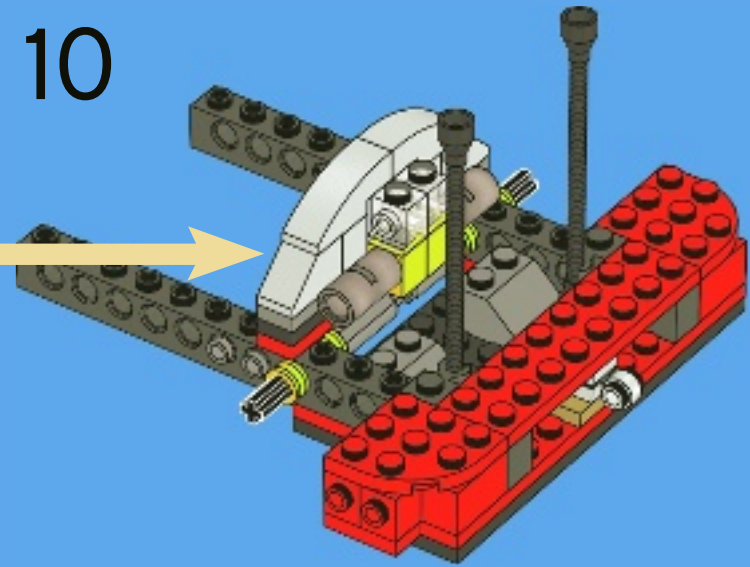

11

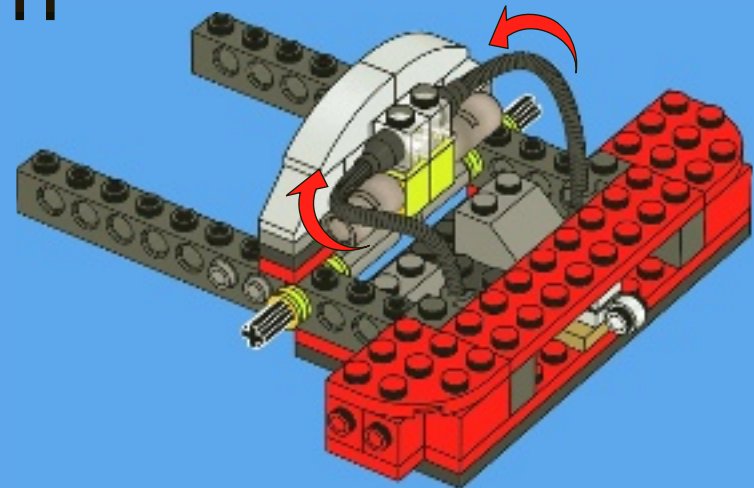



1x



1x

1

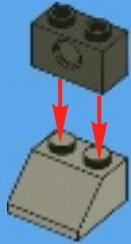

1x



1x



1x

2

1



2



1x



1x

3



1x



1x



1x



1x



2x

4

1



2

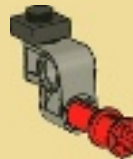

3

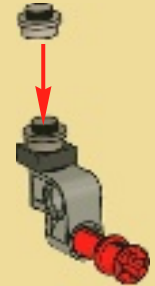



1x



1x

5

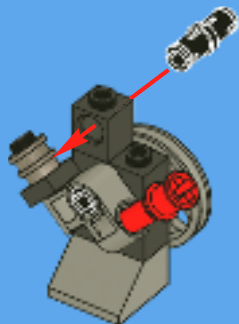

1x



2x

6



1x



1x

7

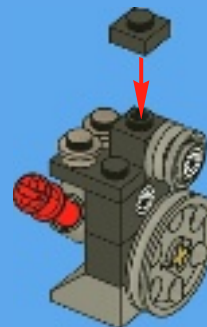

1x

8



12

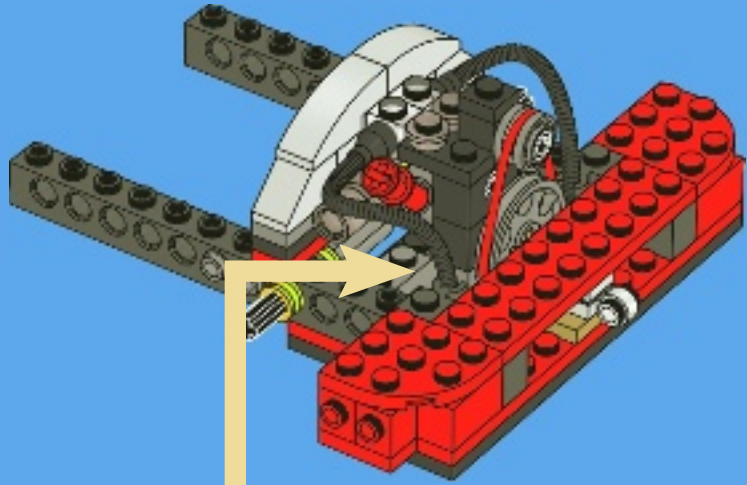

13

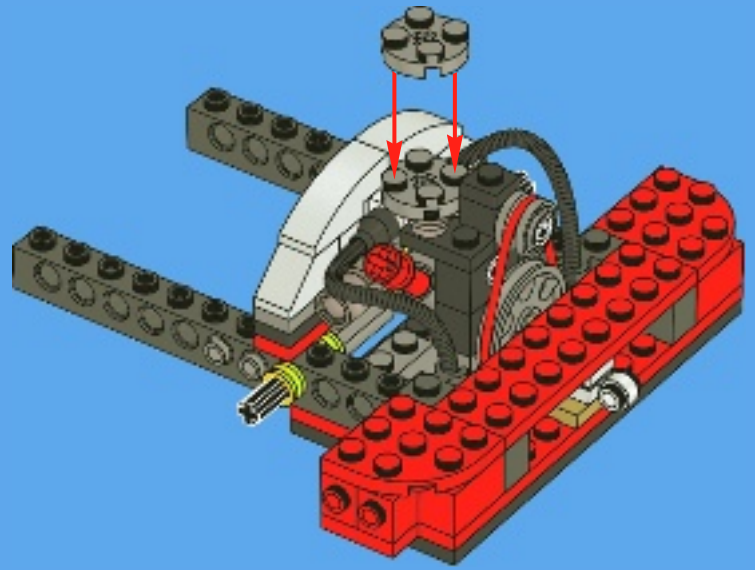

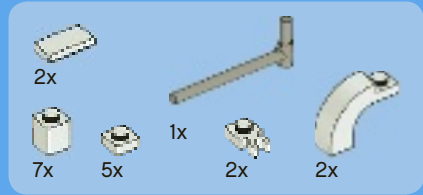

14

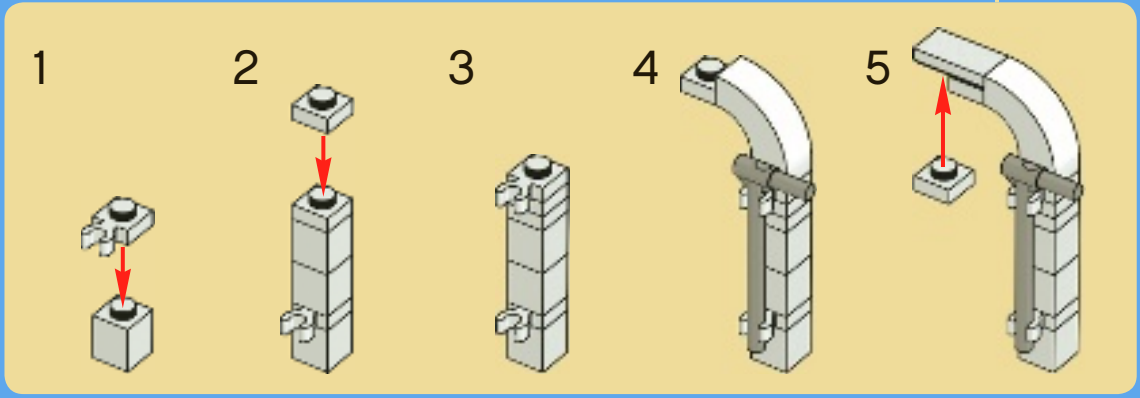
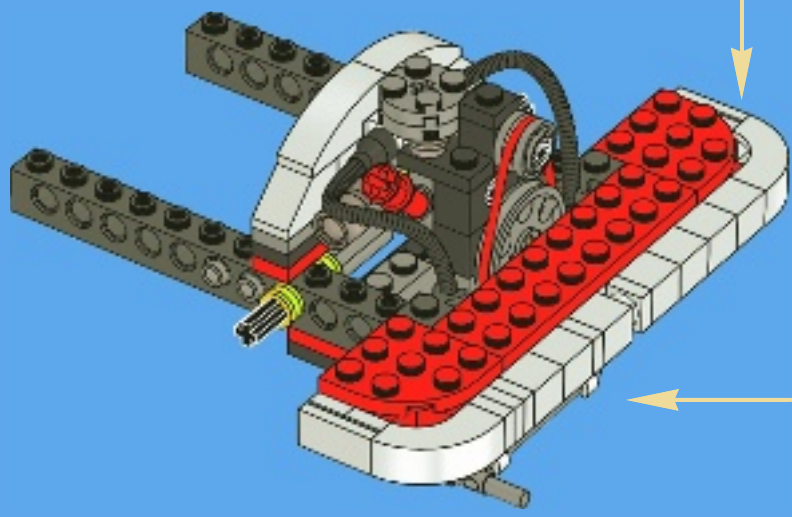
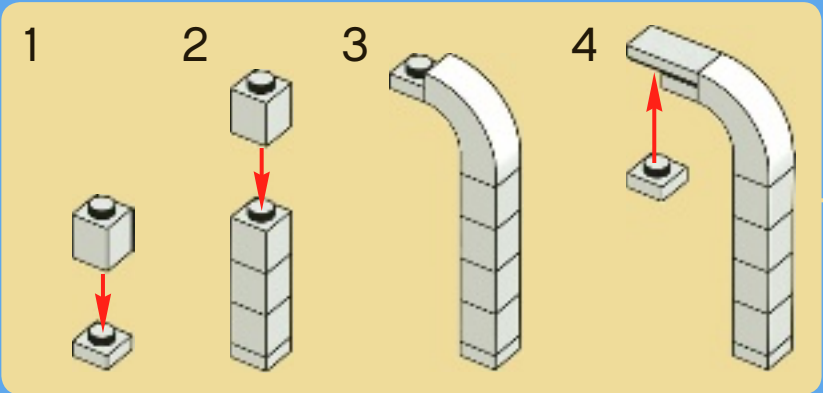

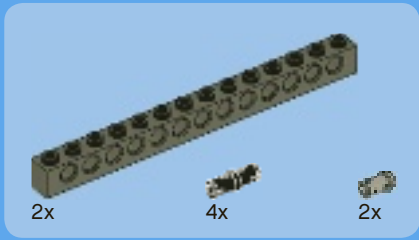

15

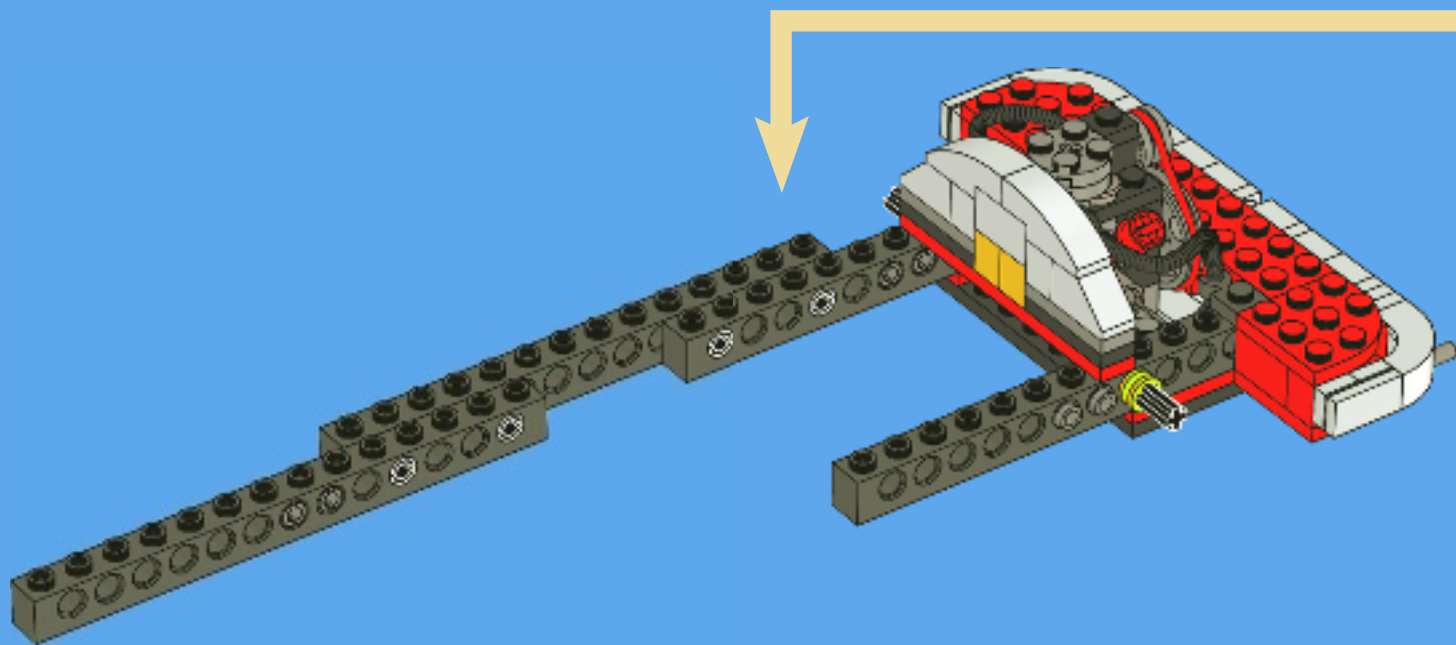
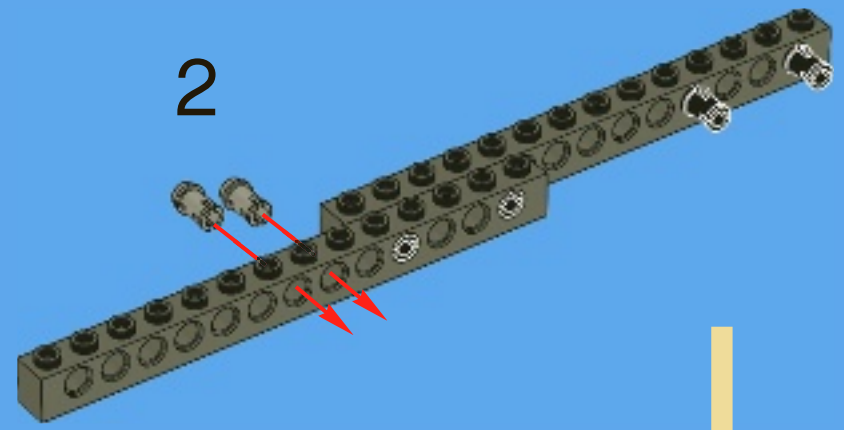



16

1

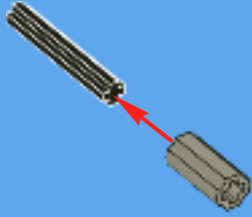

2

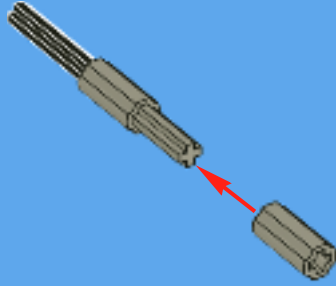

3

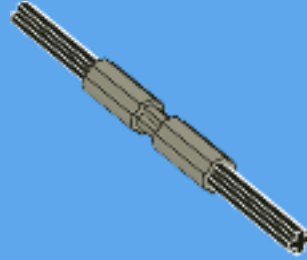

4

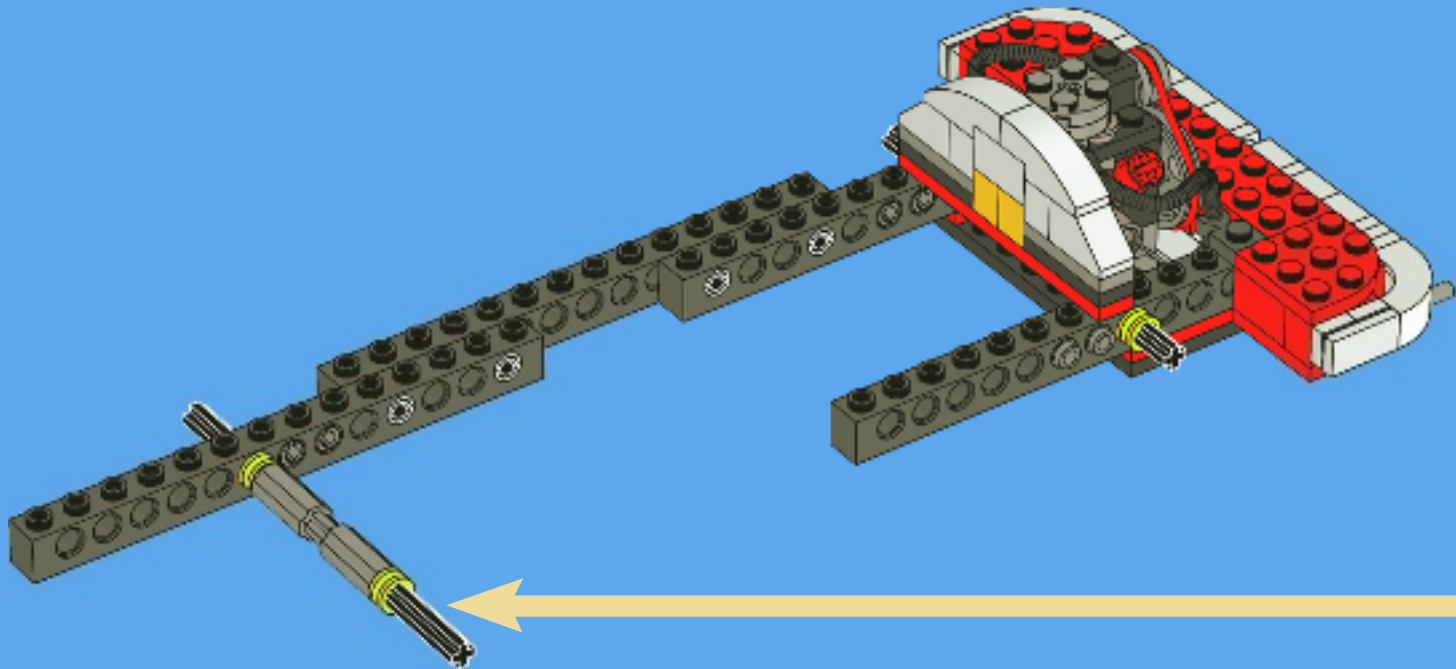
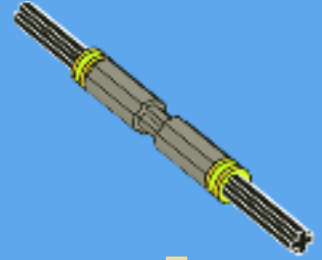

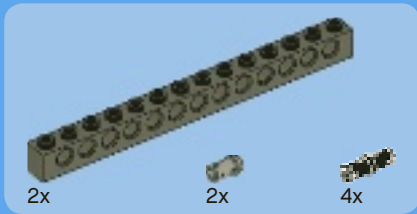

17

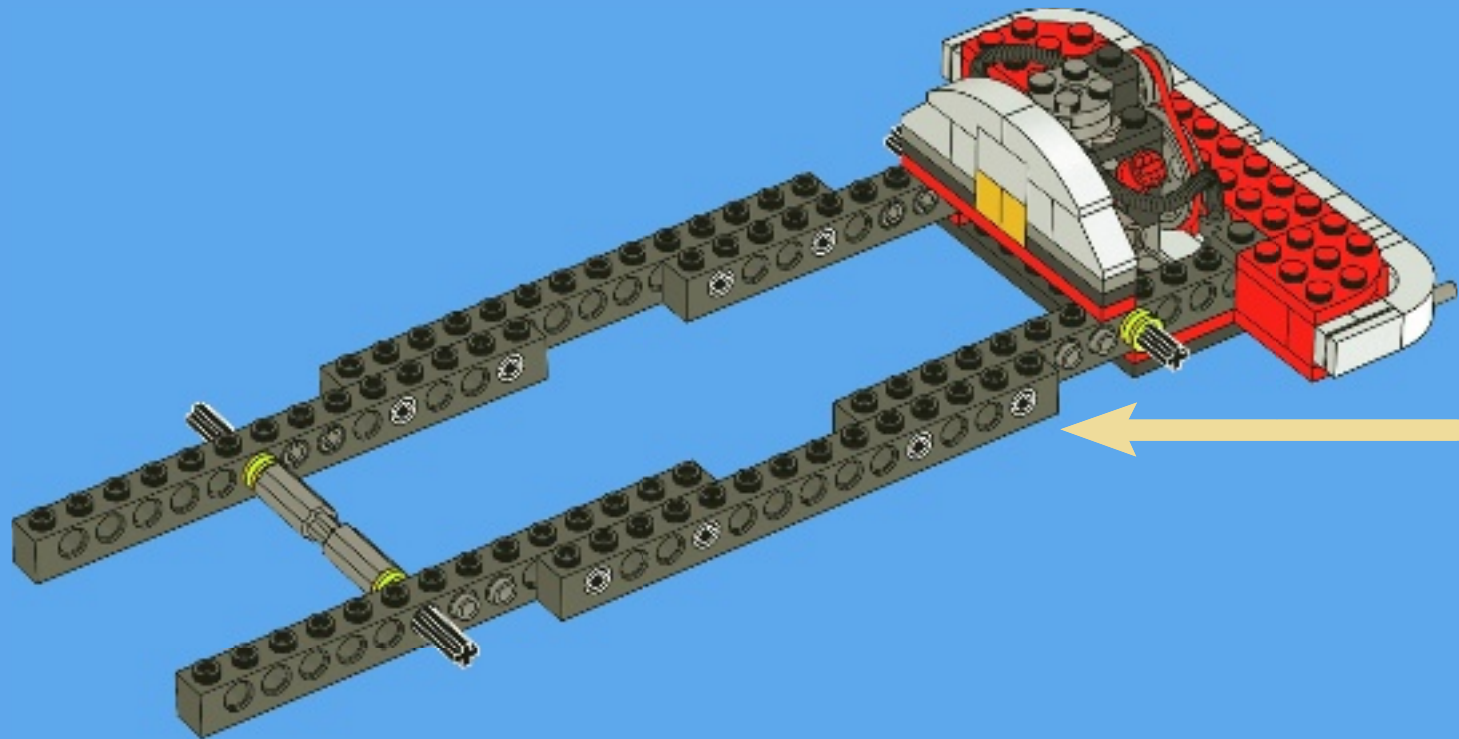
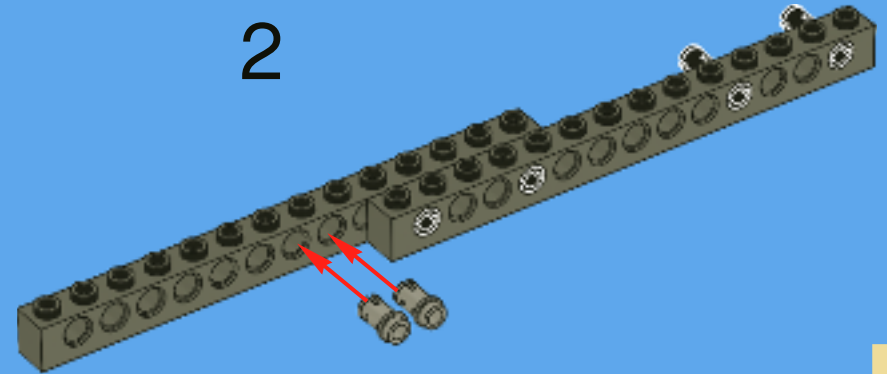
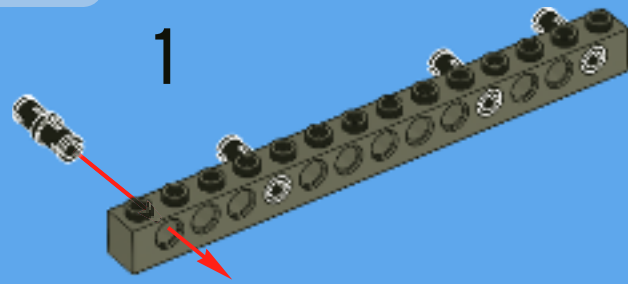



2x

18

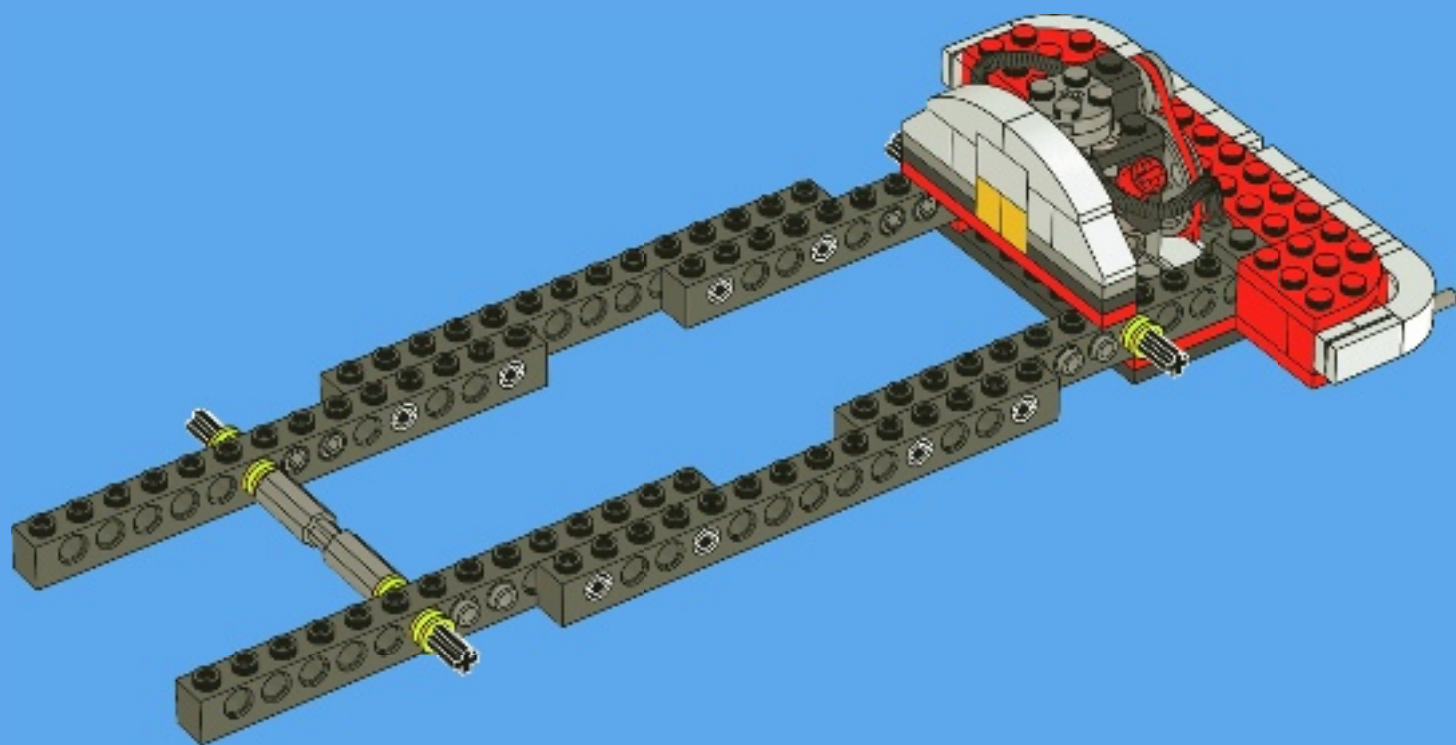

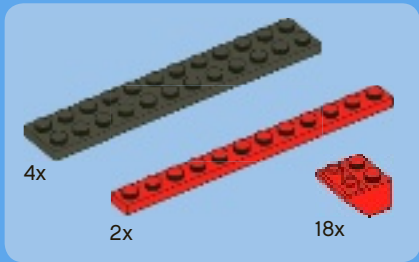

19

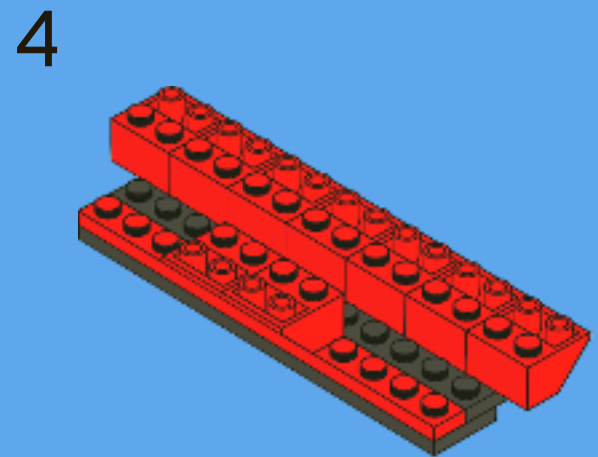
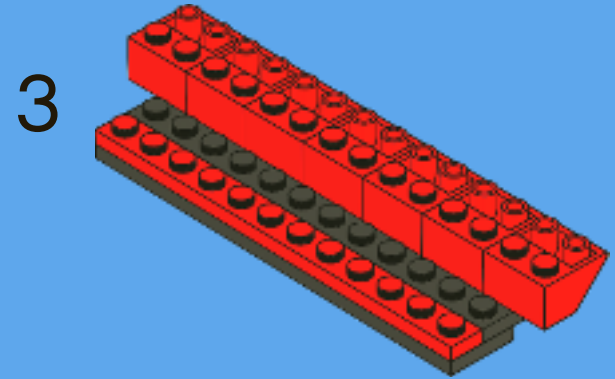
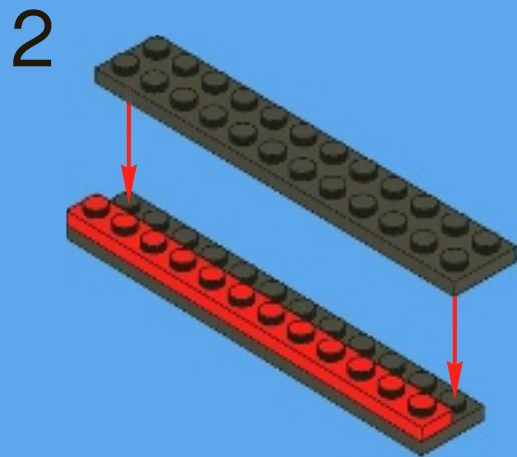
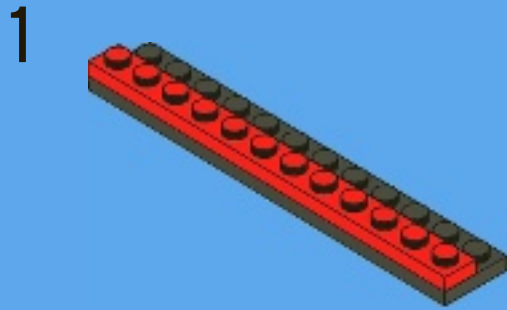

2x

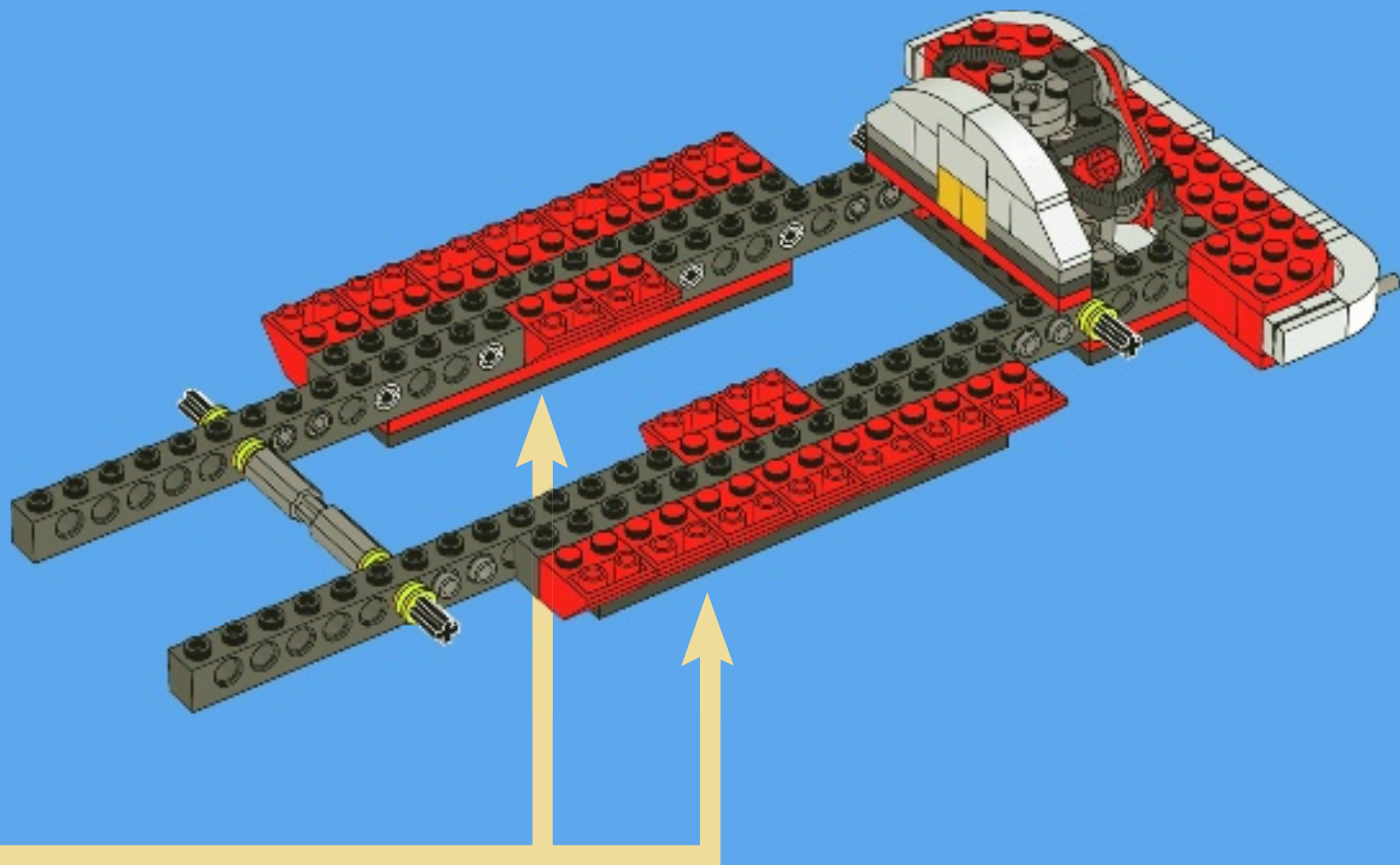



3x

20

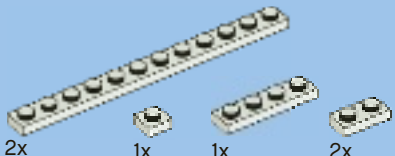
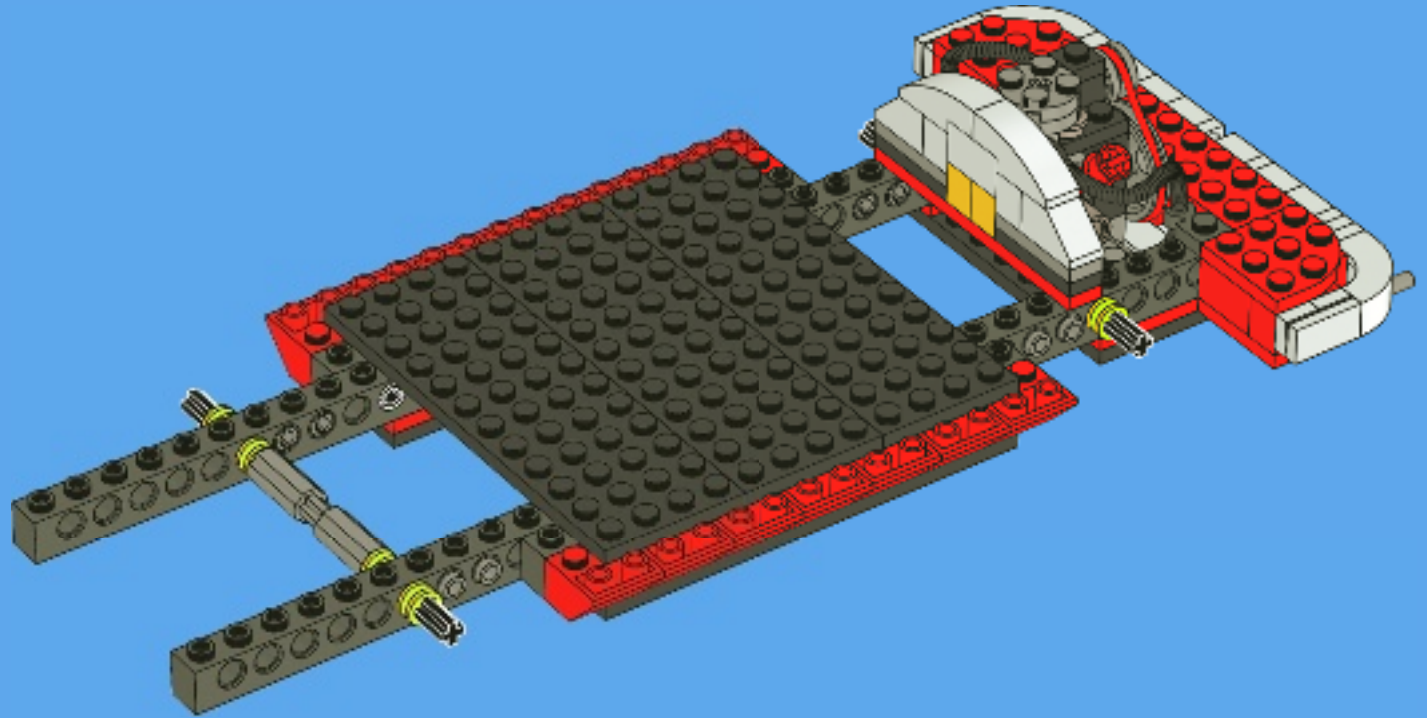

2x

1x

1x

2x

21

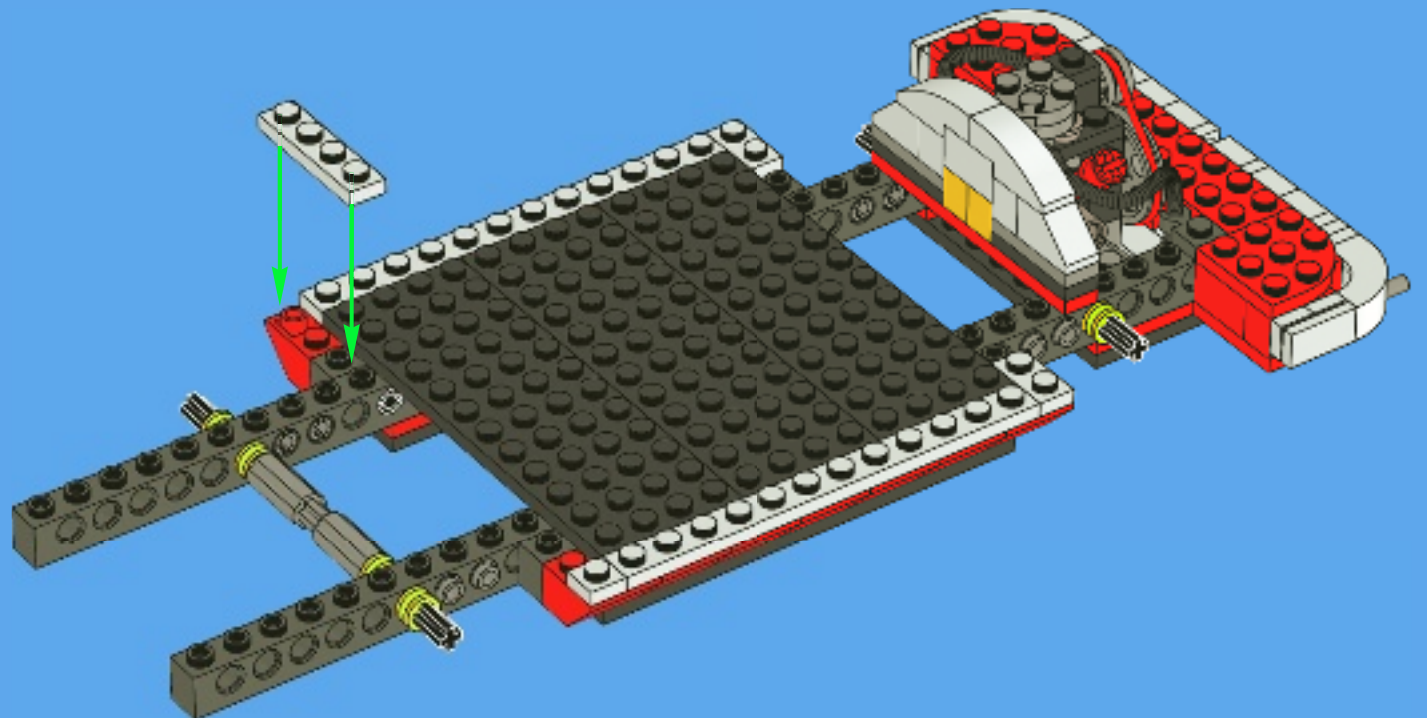

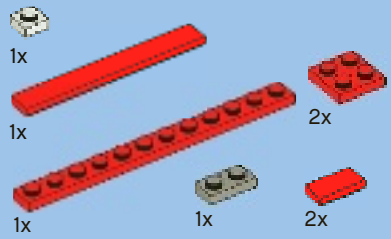

22

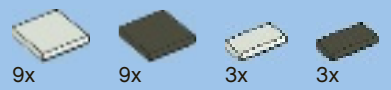
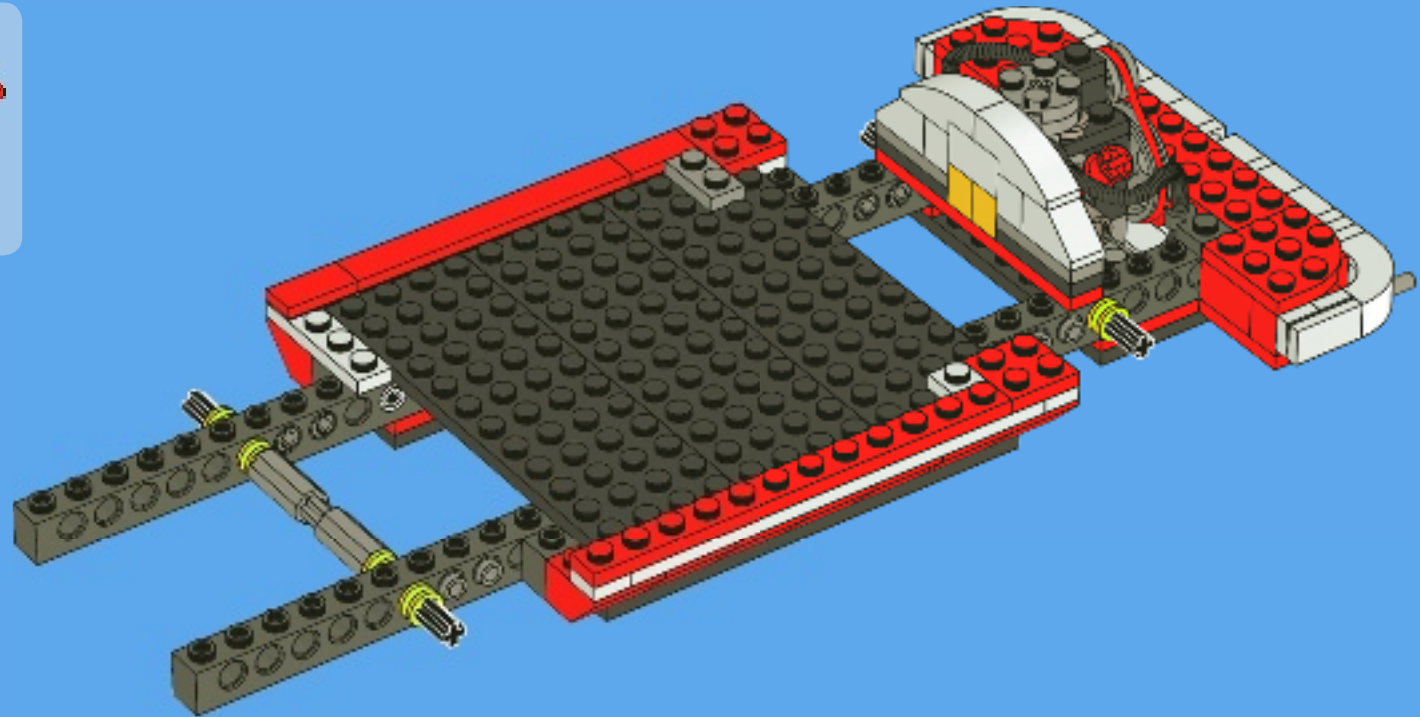

23

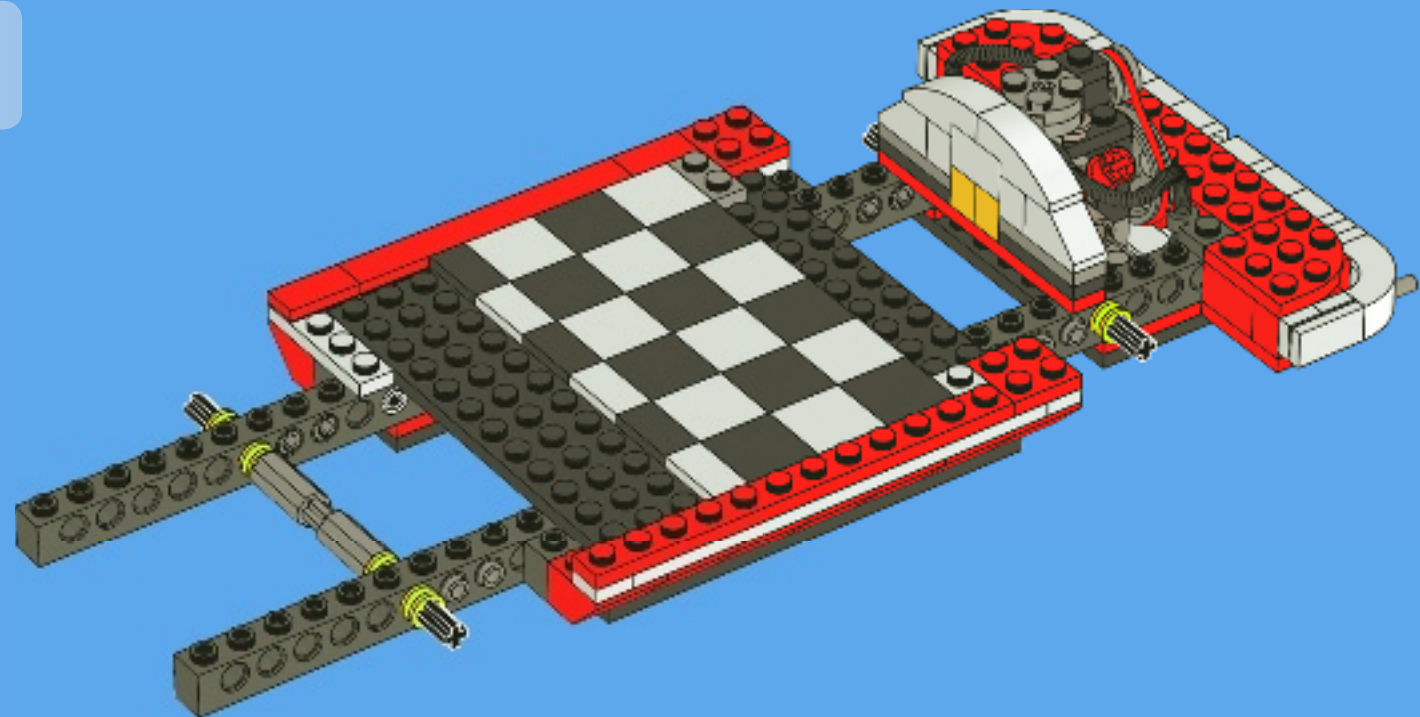

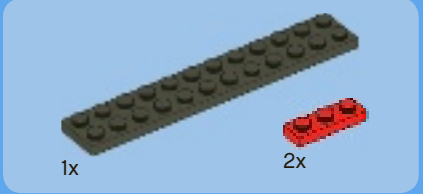

1

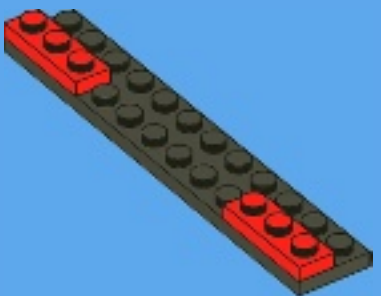

2

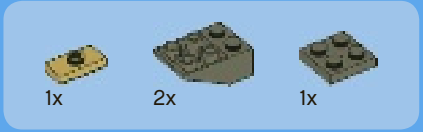
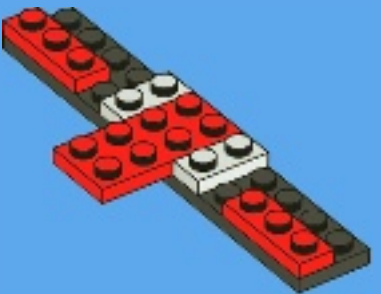

3

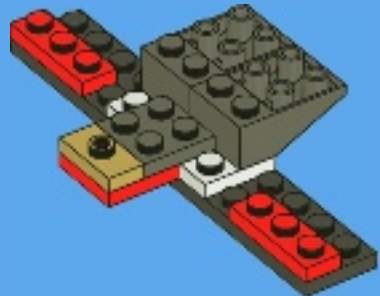

4

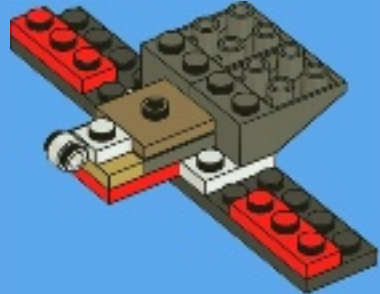



2x



4x

5

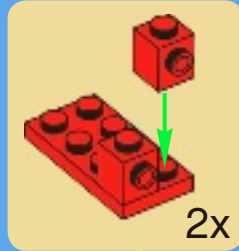

2x

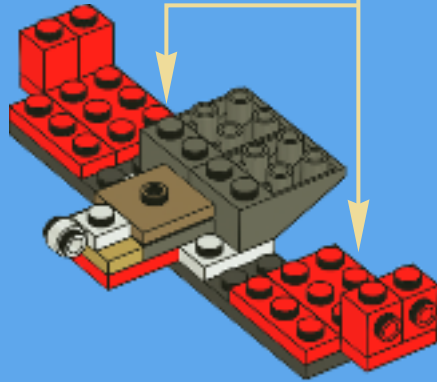

4x



1x

6

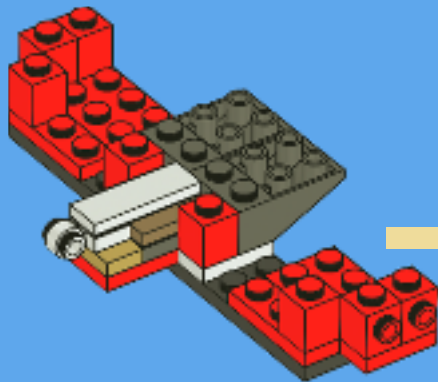

24

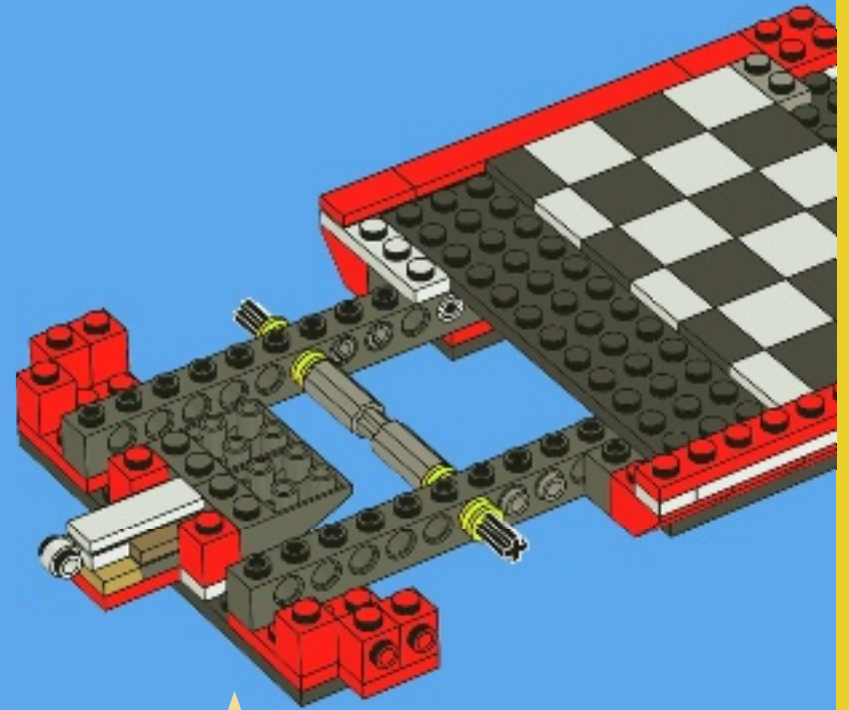

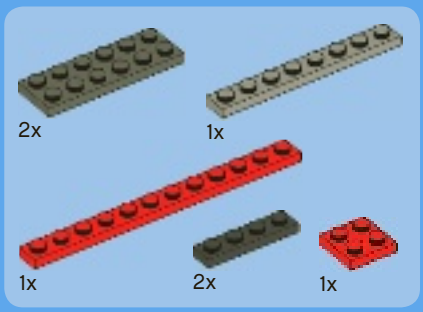

25

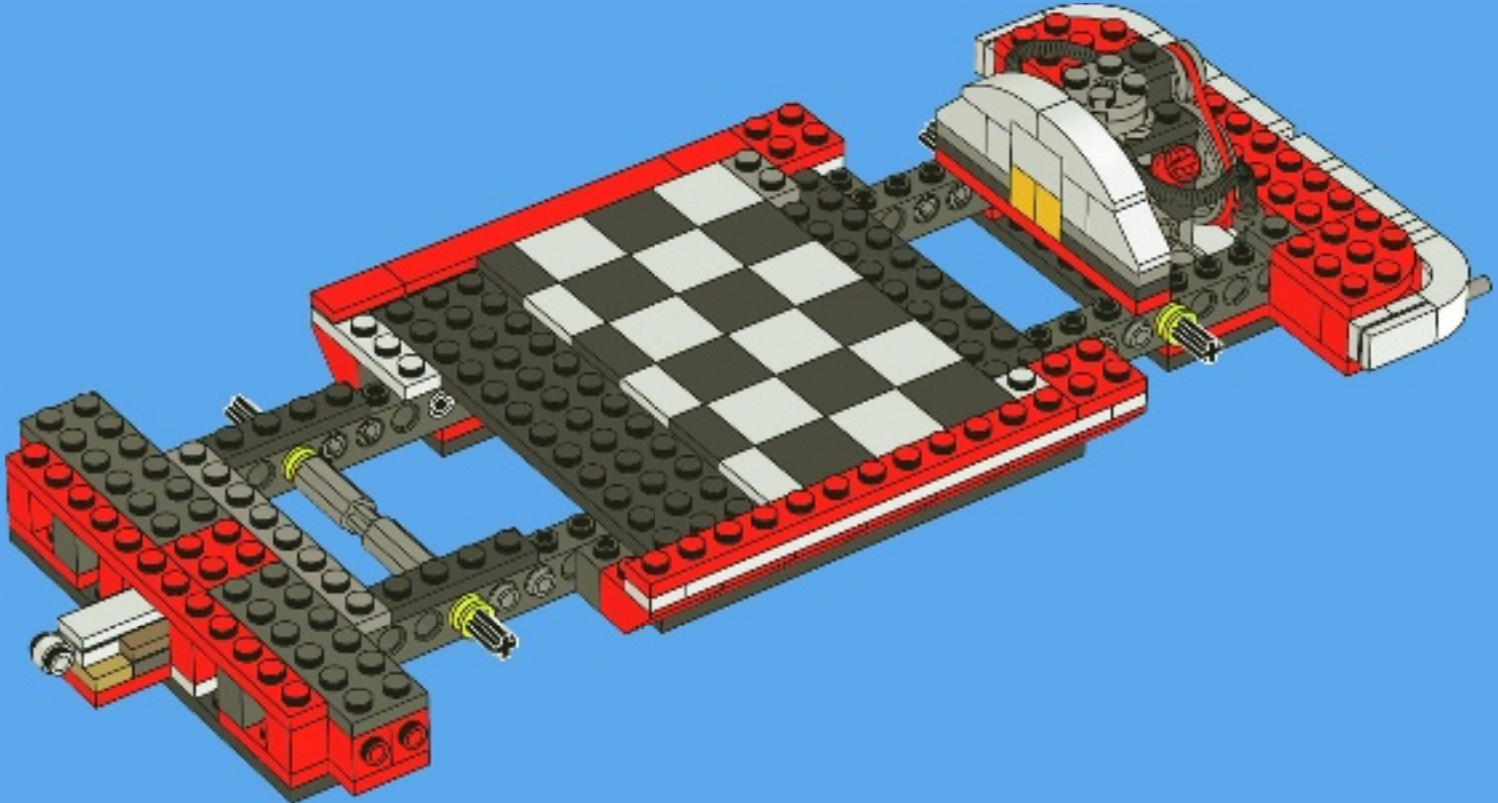

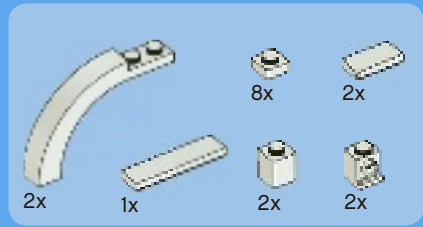

26

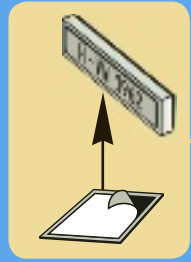
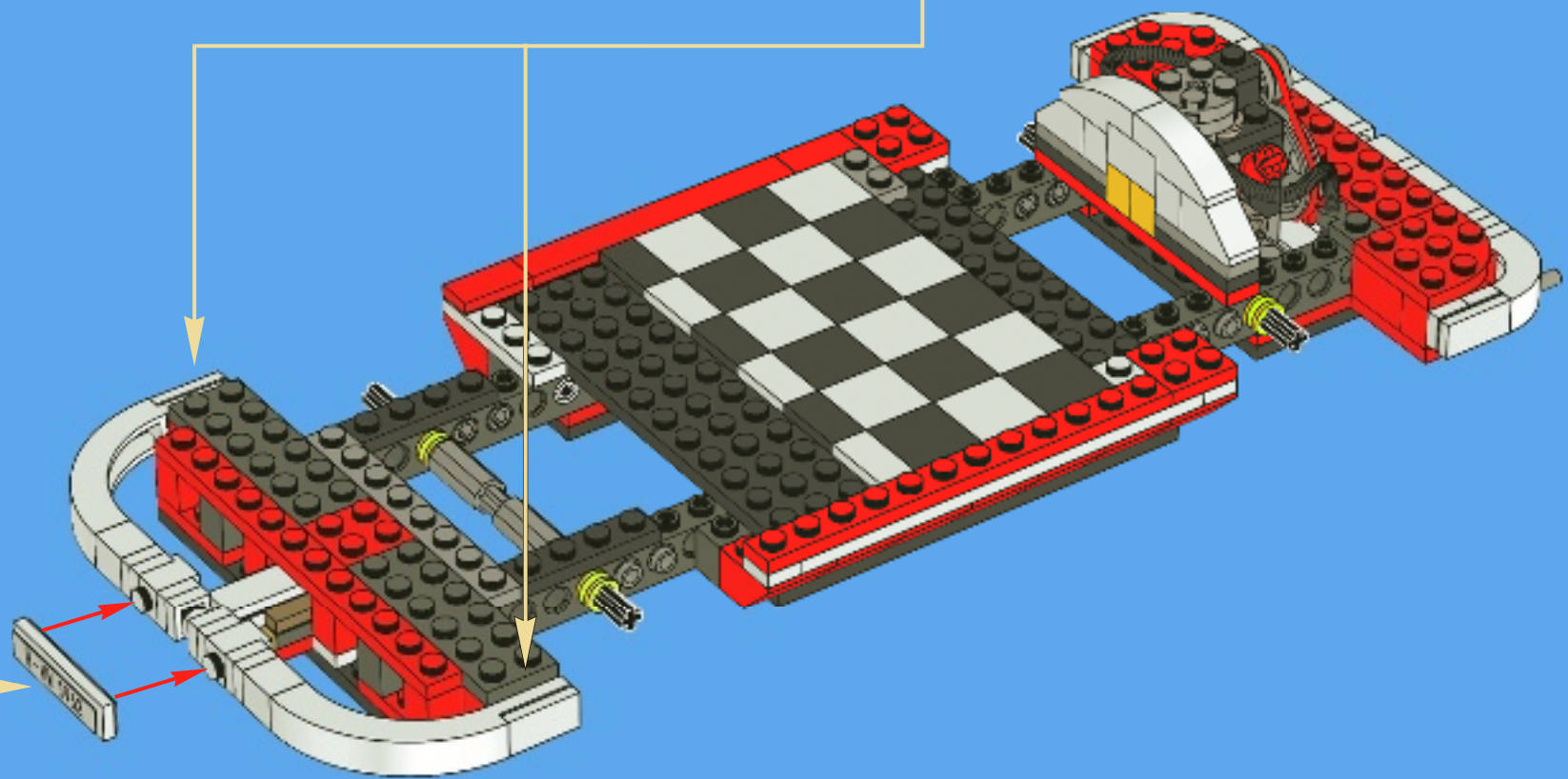
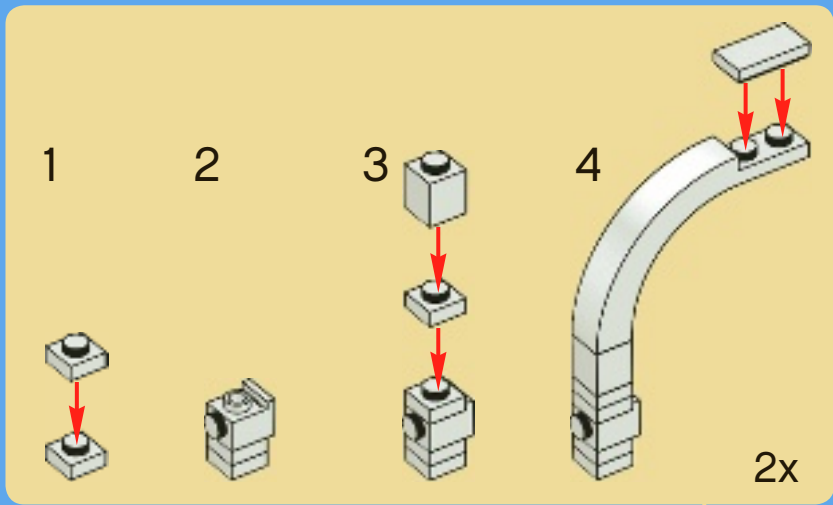

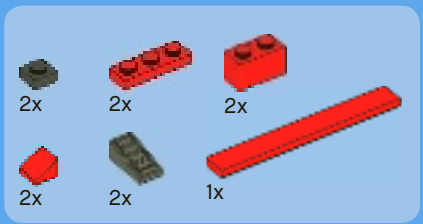

27

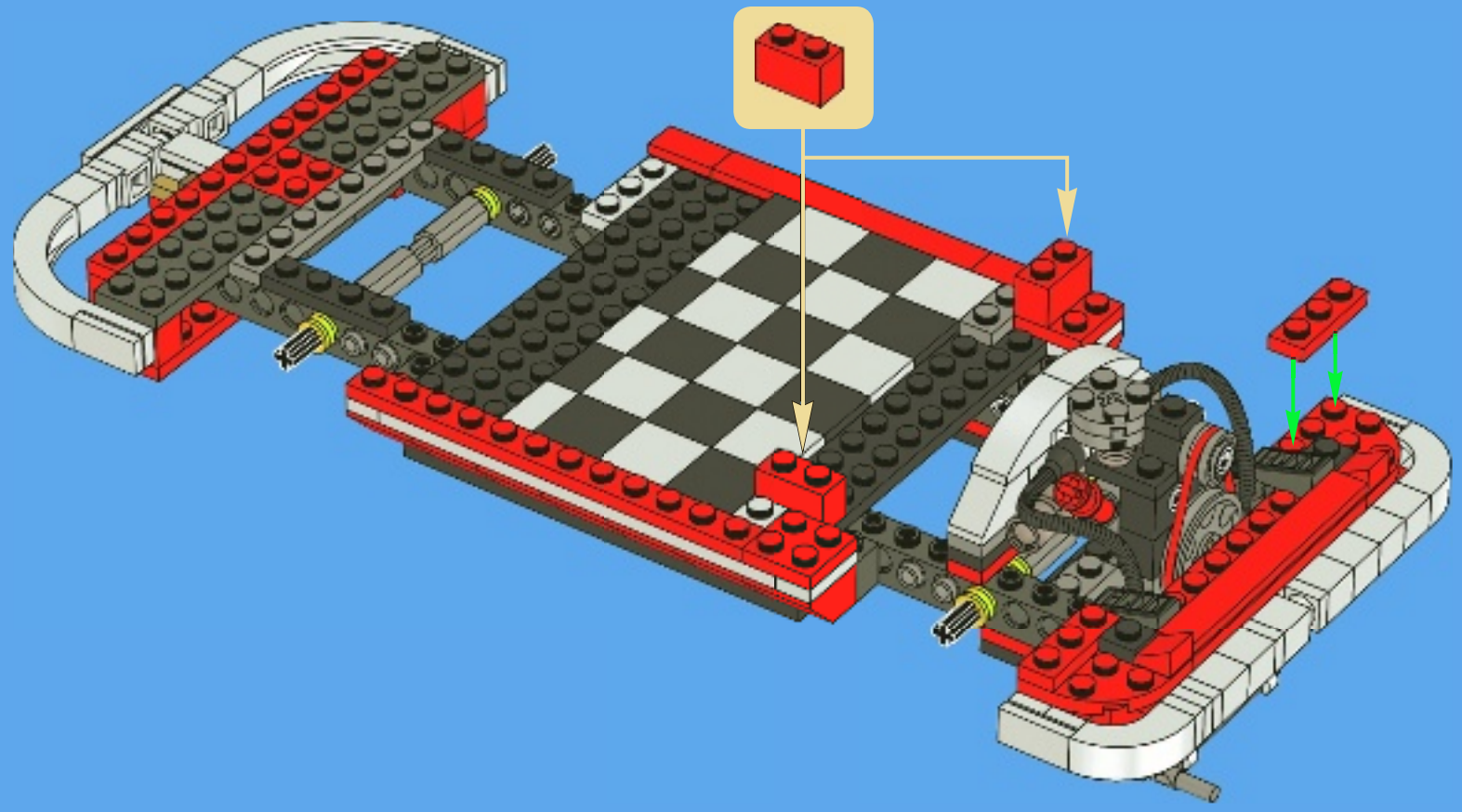

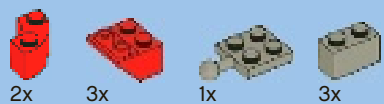

28

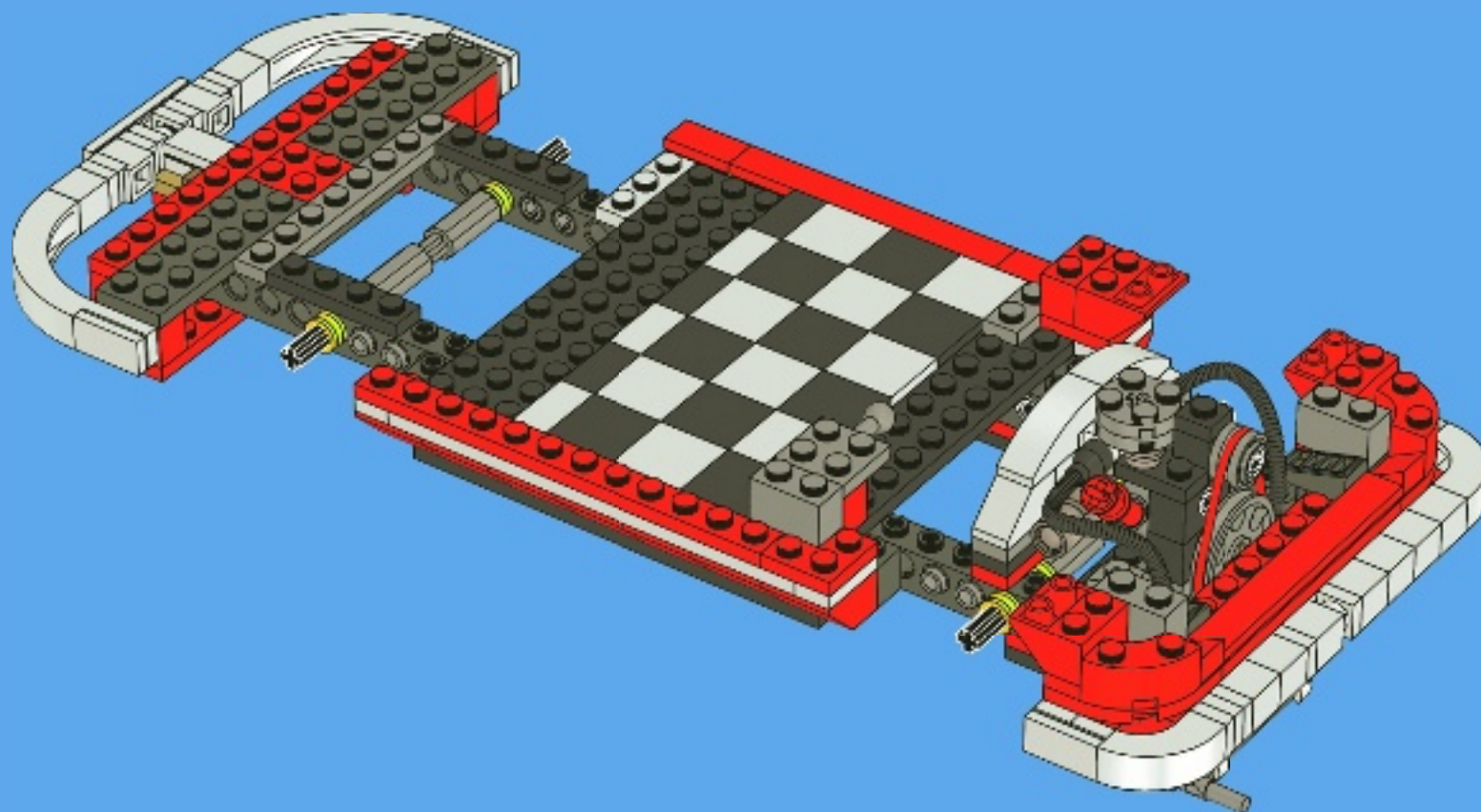

- 1x
- 2x
- 1x
- 1x
- 2x
- 2x

29

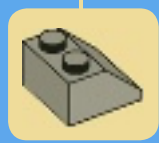
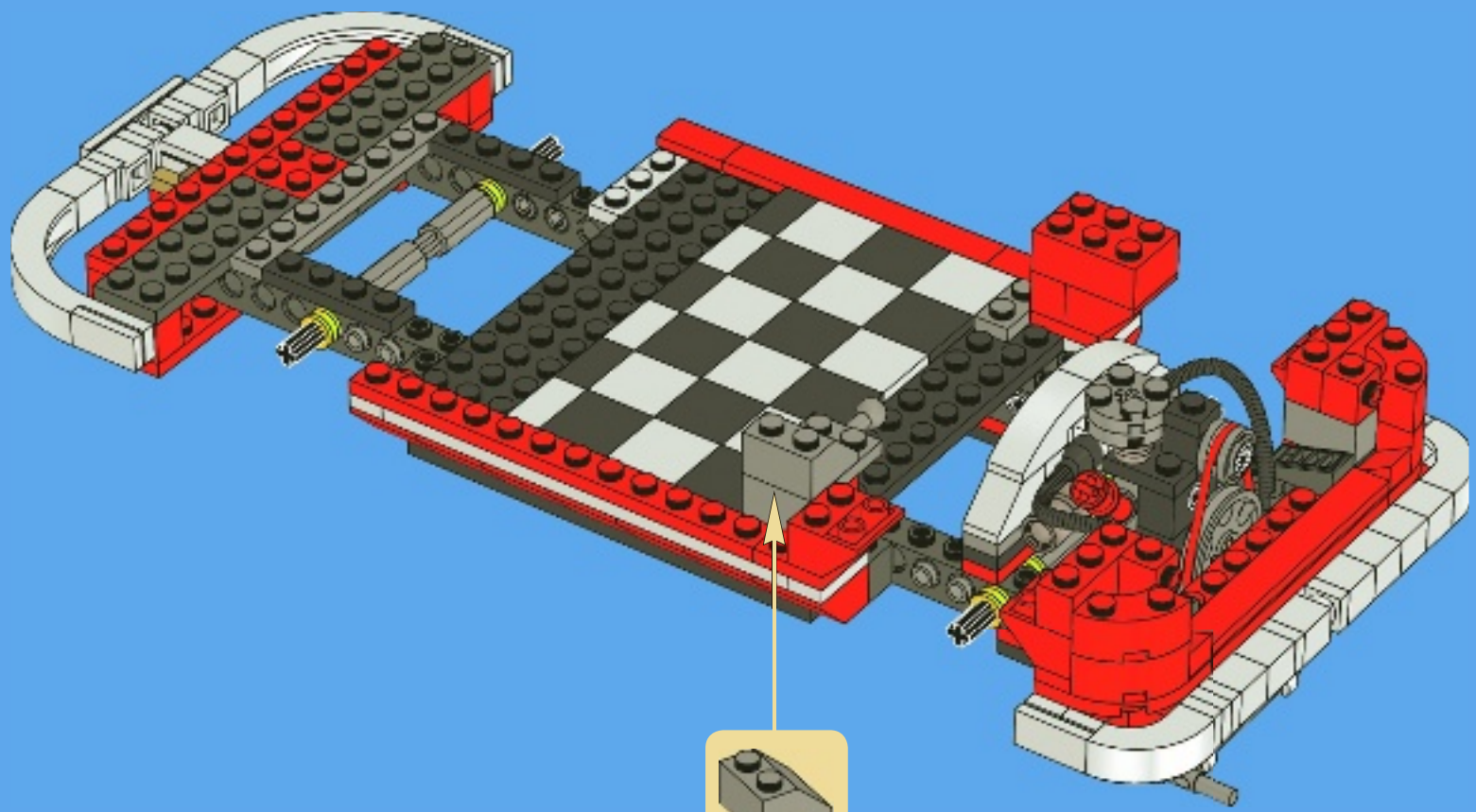



2x



2x



3x



2x

30

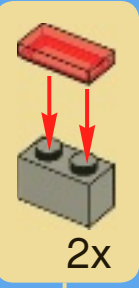
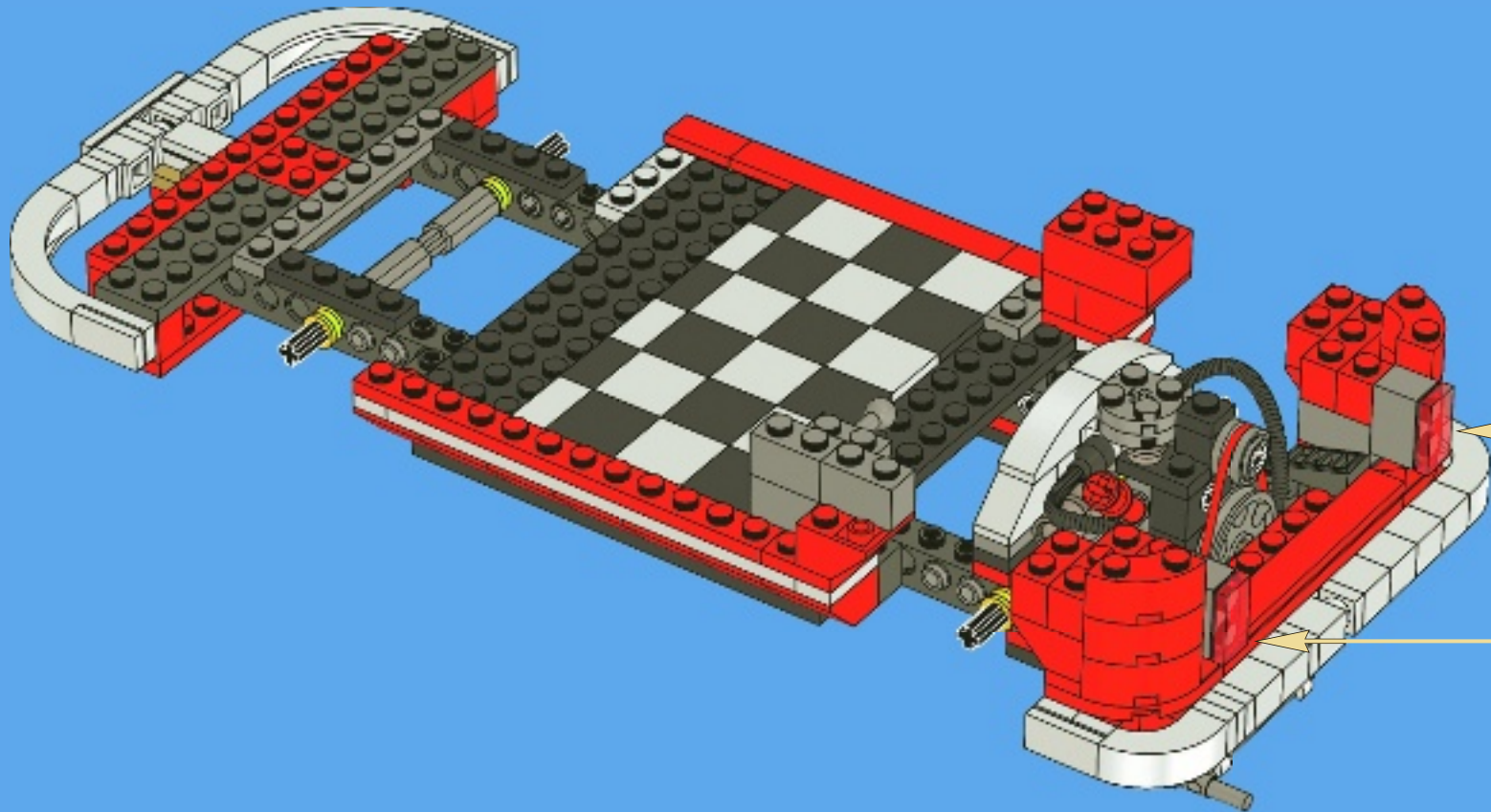

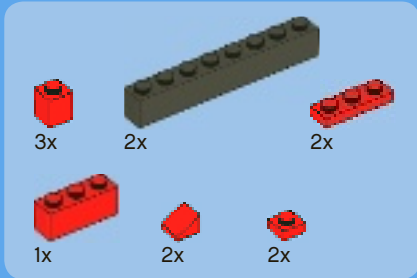

31

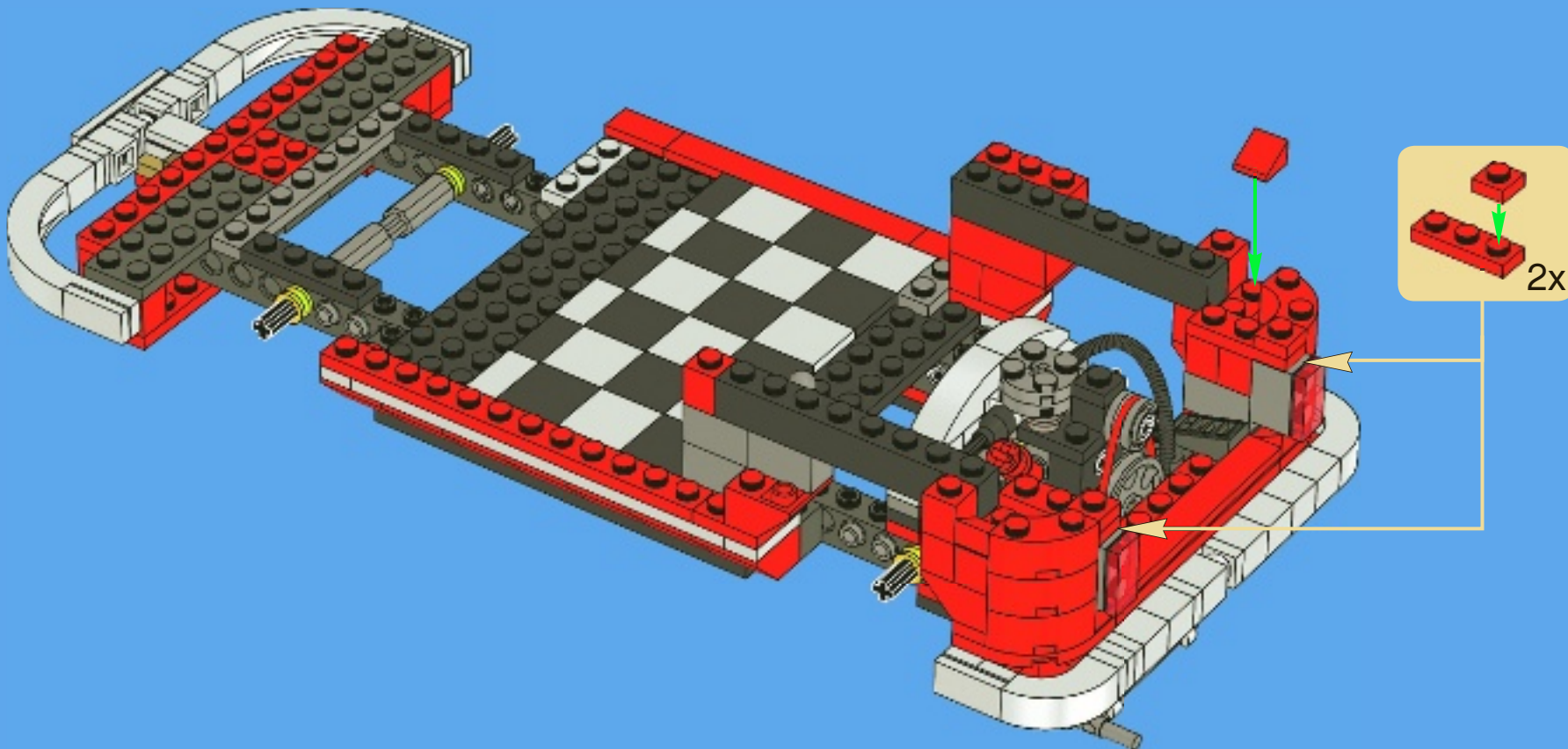

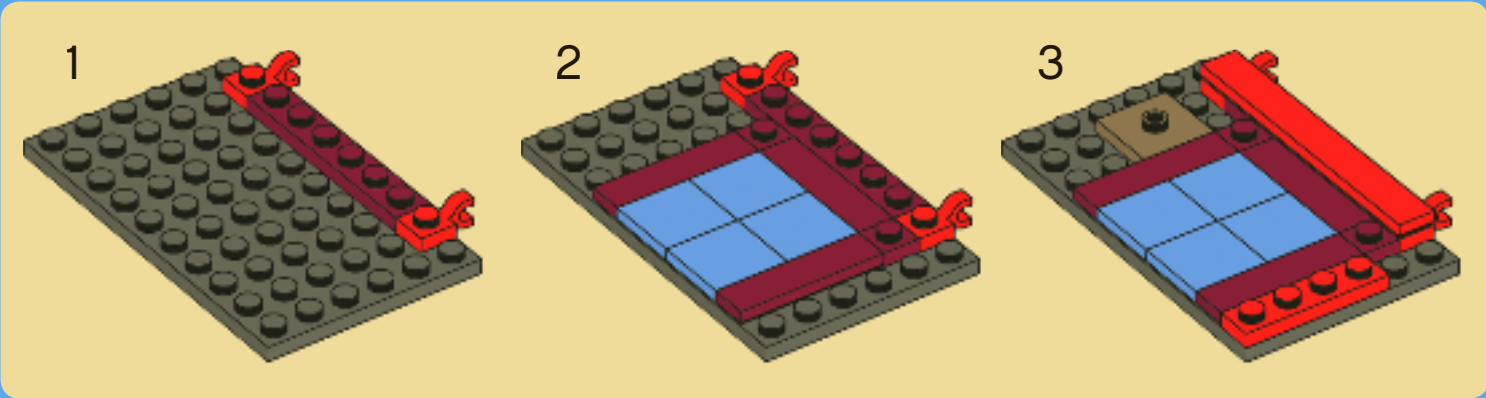
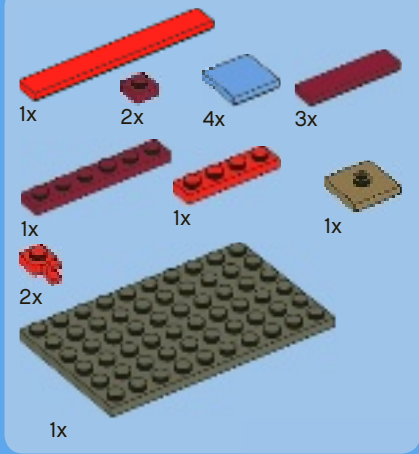

32

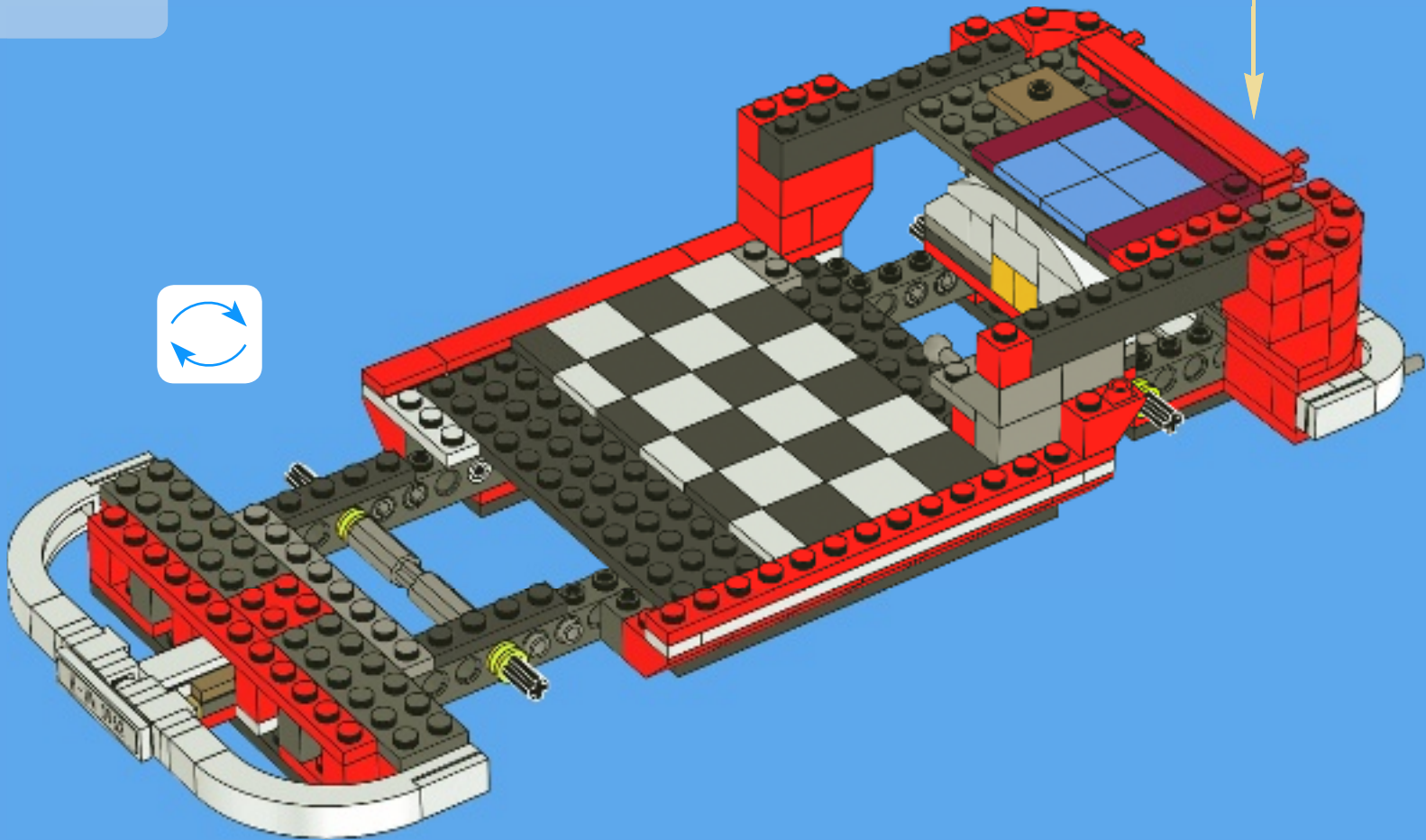

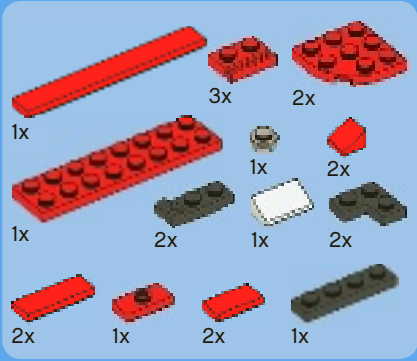

33

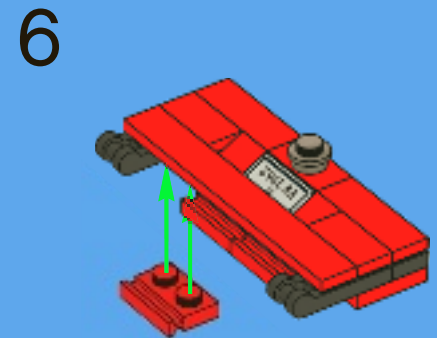
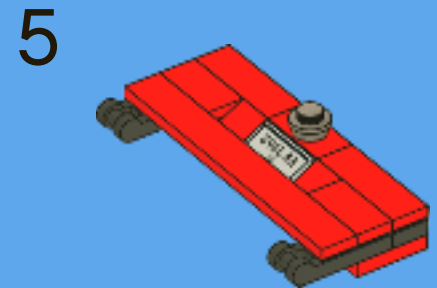
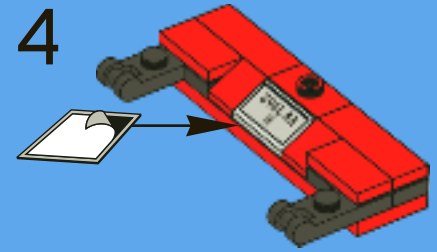
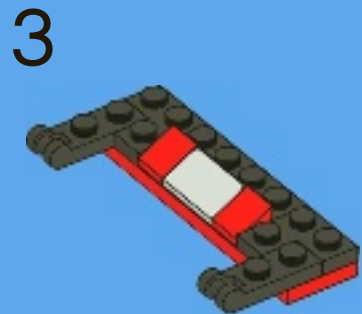
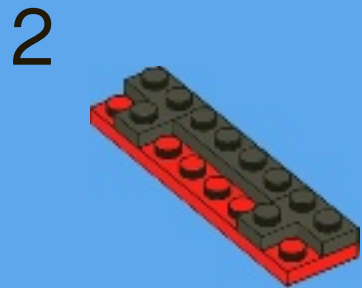

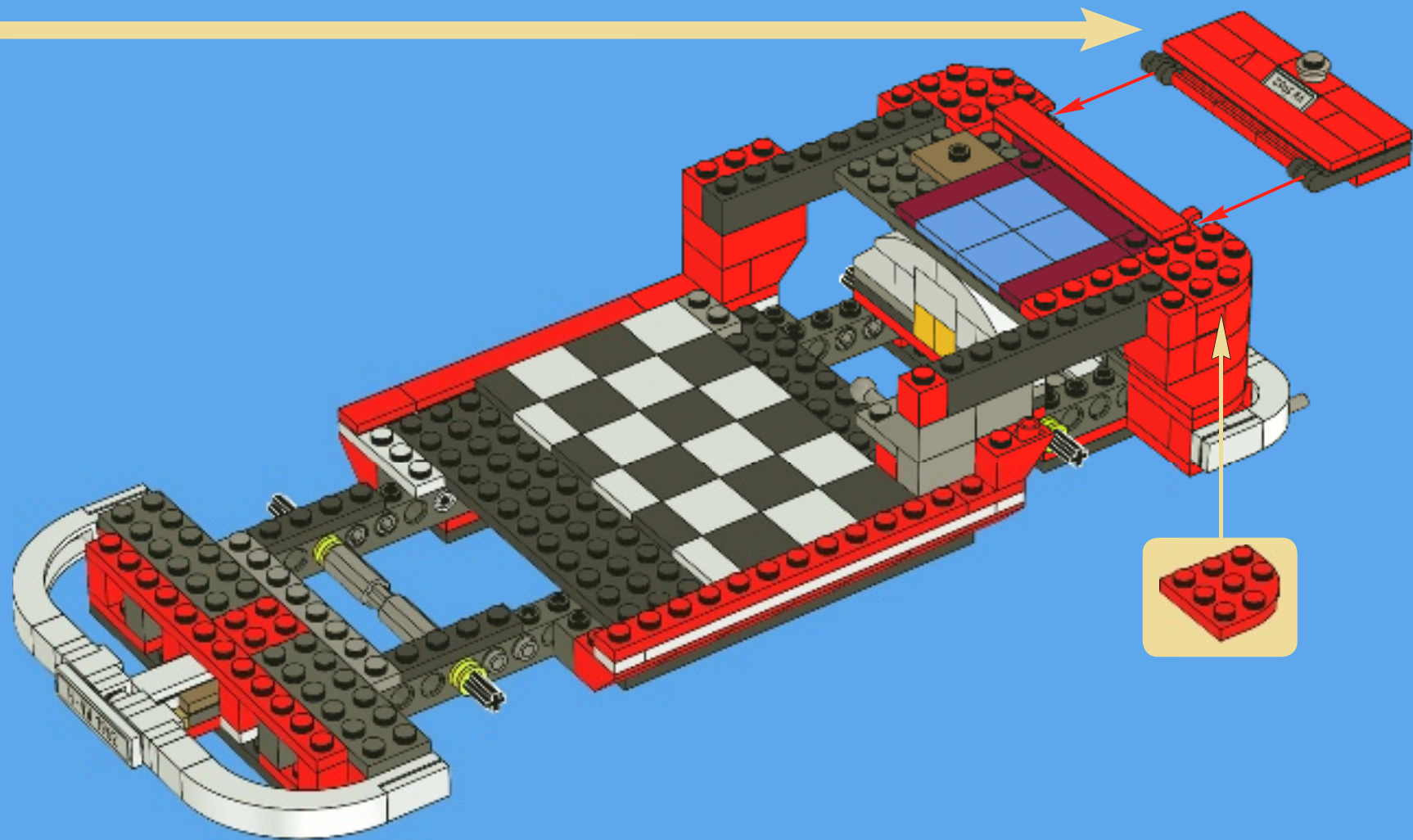



34

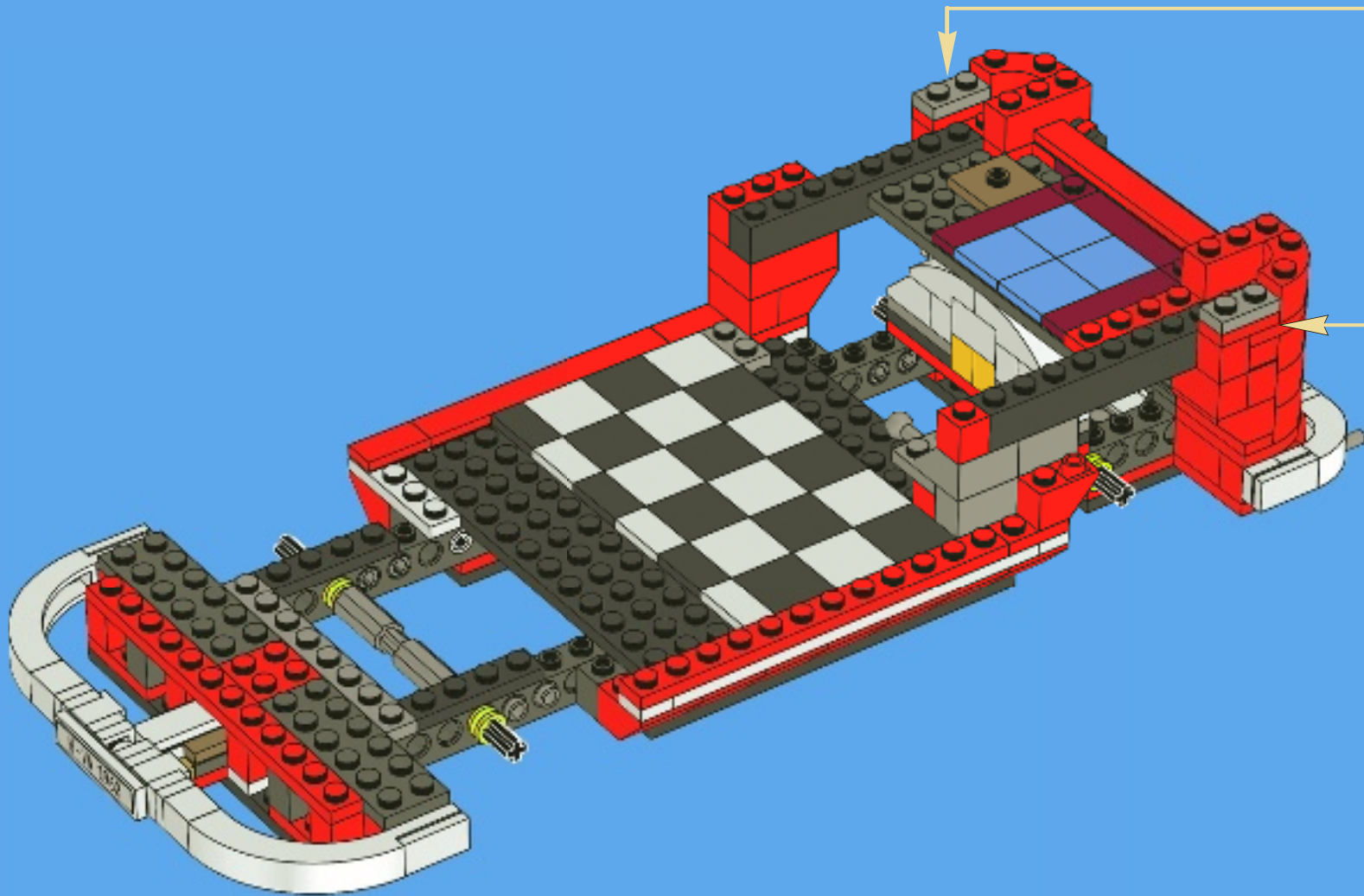
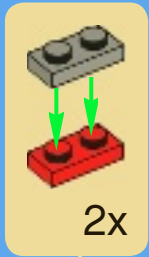

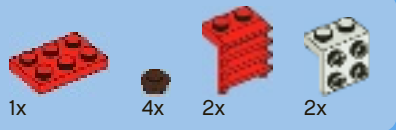

35

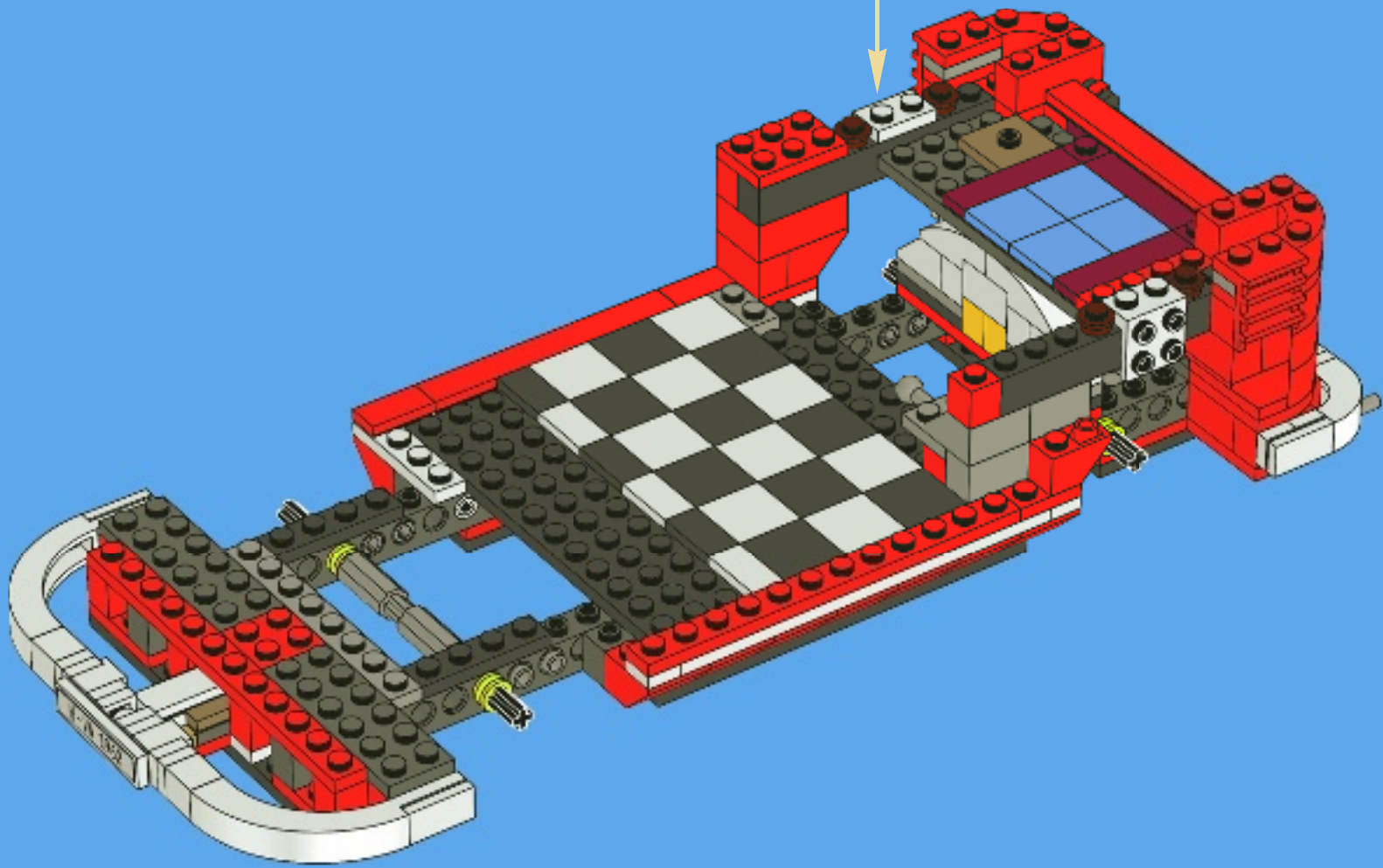



36

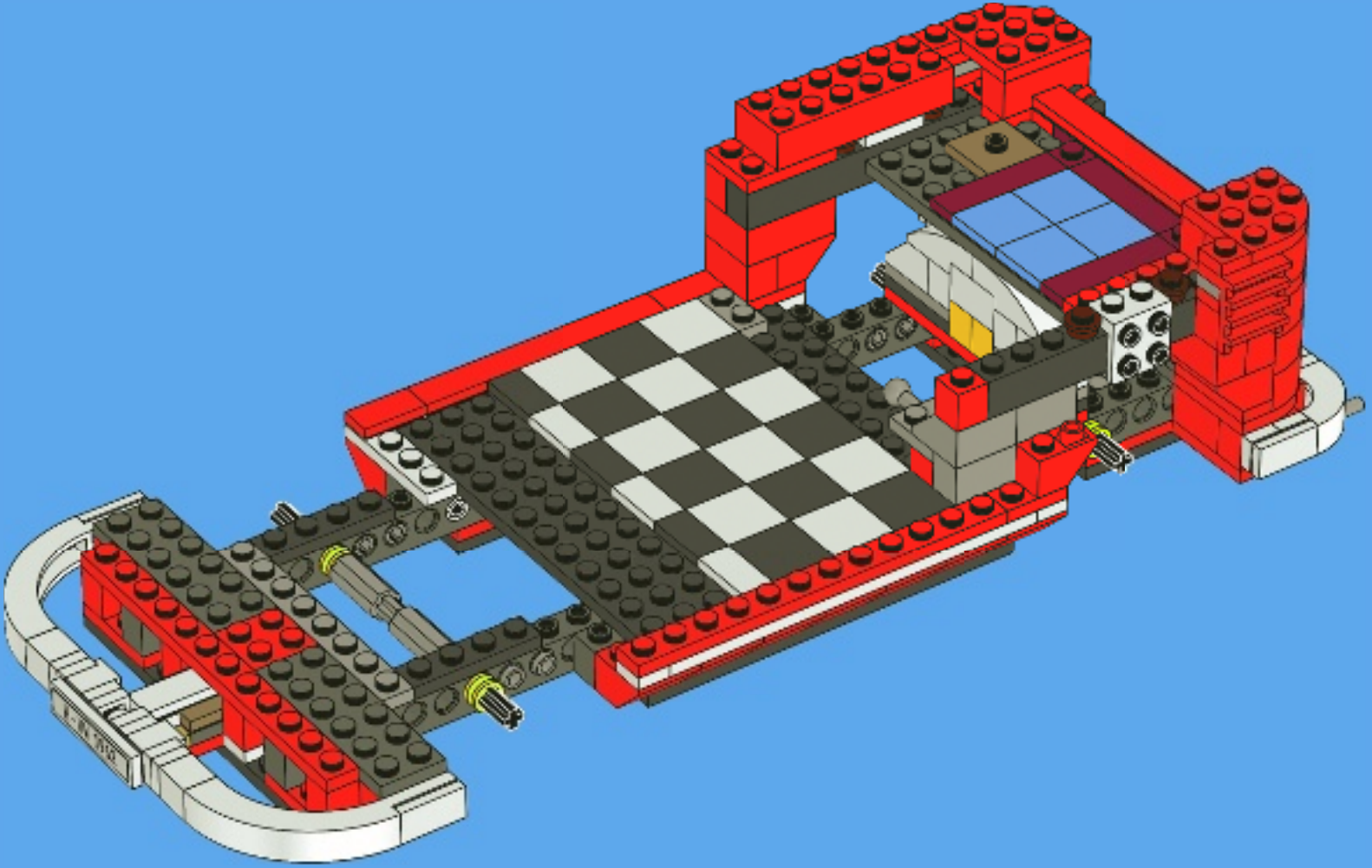

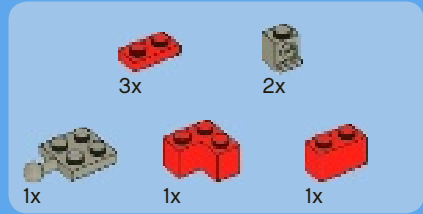

37

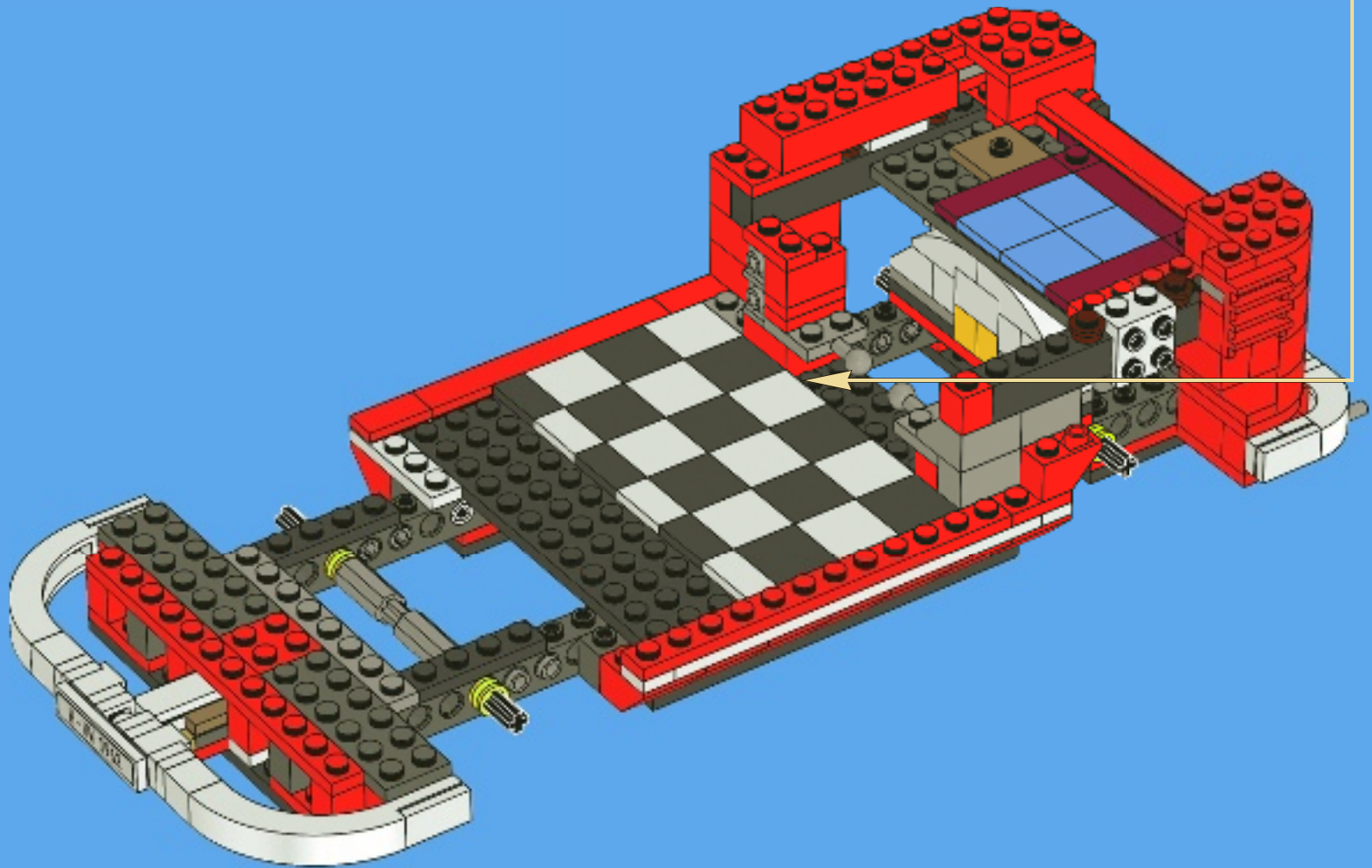
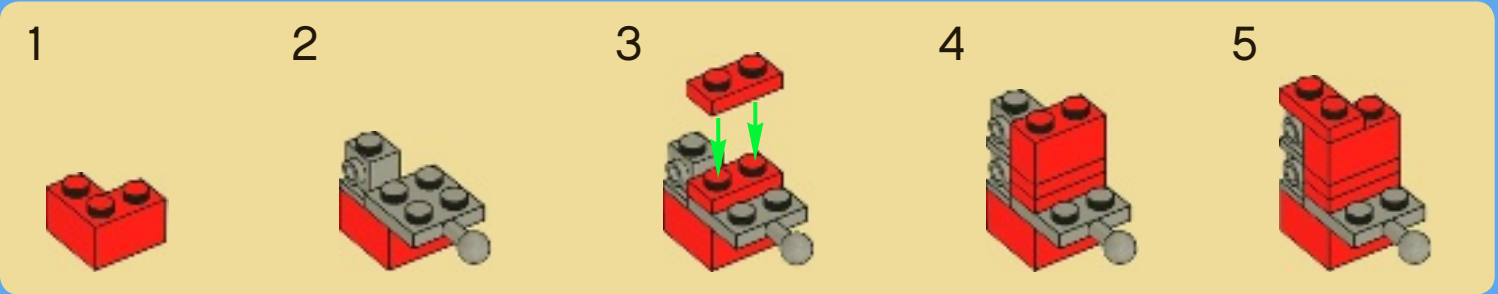



1

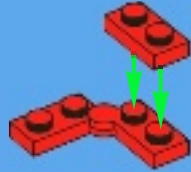

2

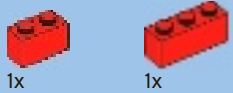

3

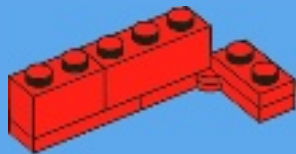

4

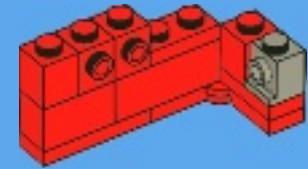

5

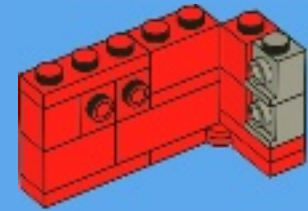

6

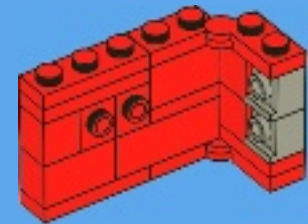

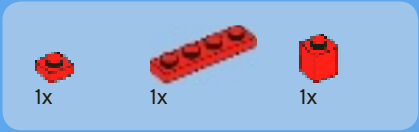

7

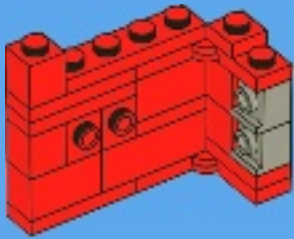

8

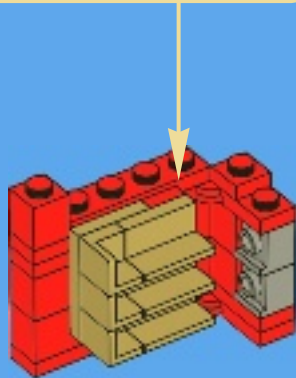
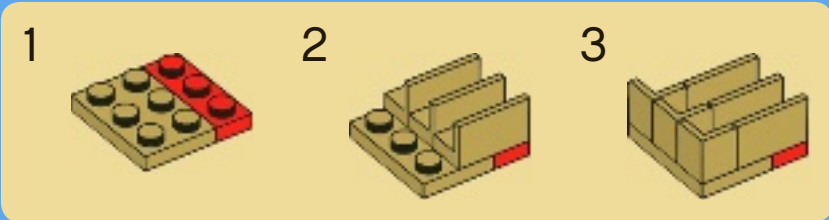

38

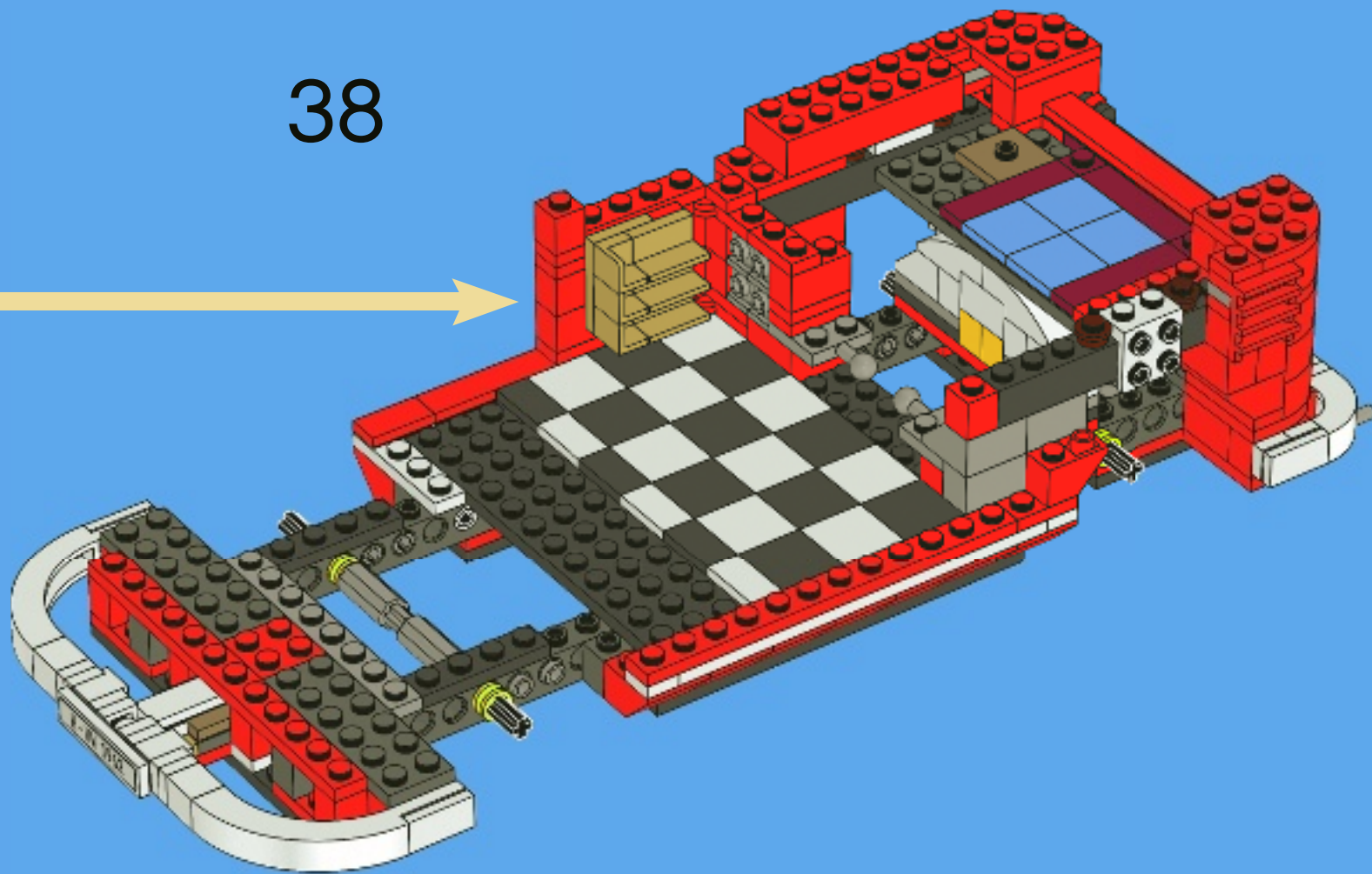



1x



2x



2x



1x

39

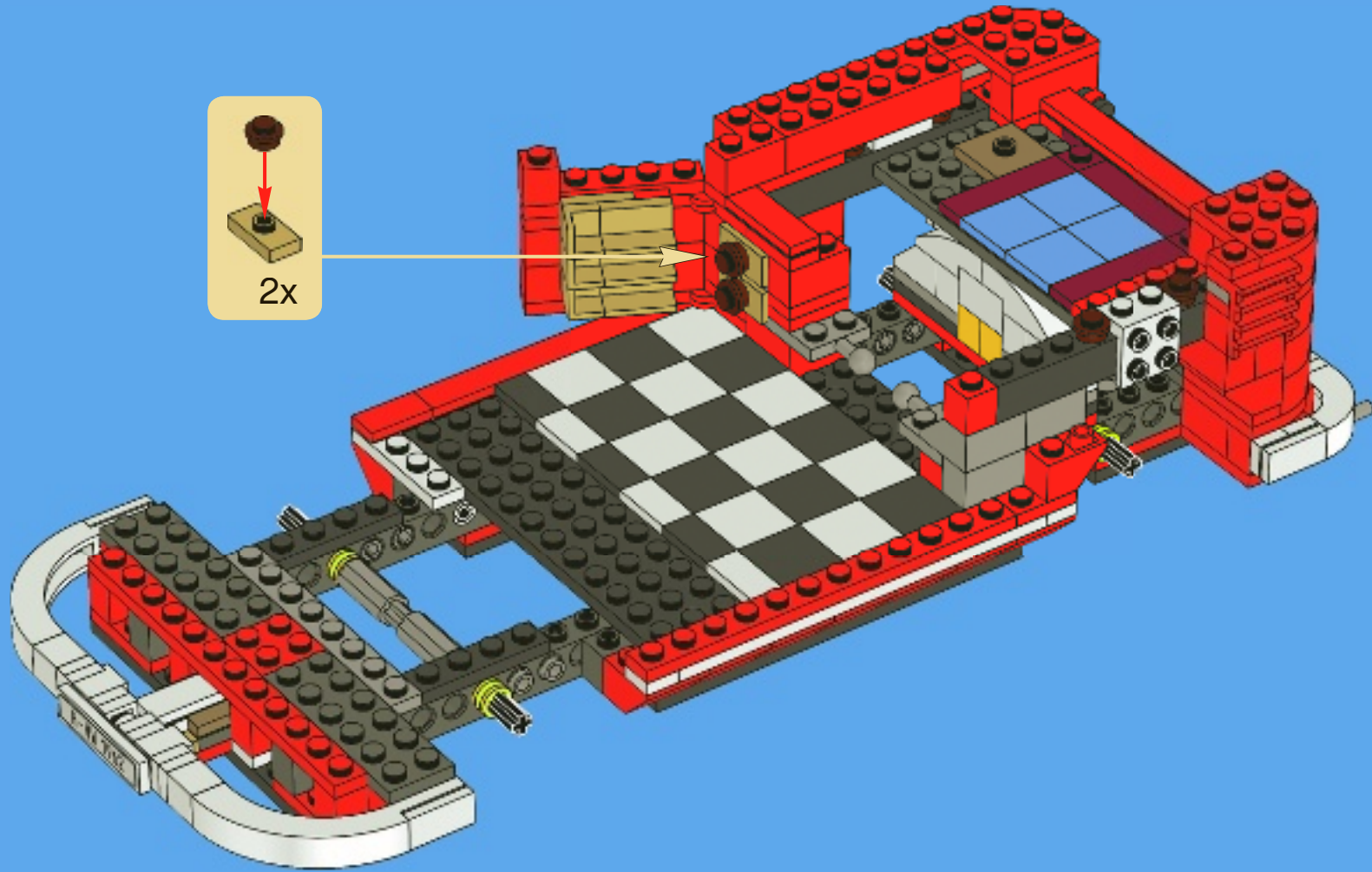
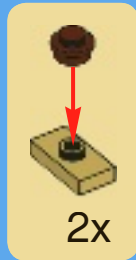



2x



1x



2x

40

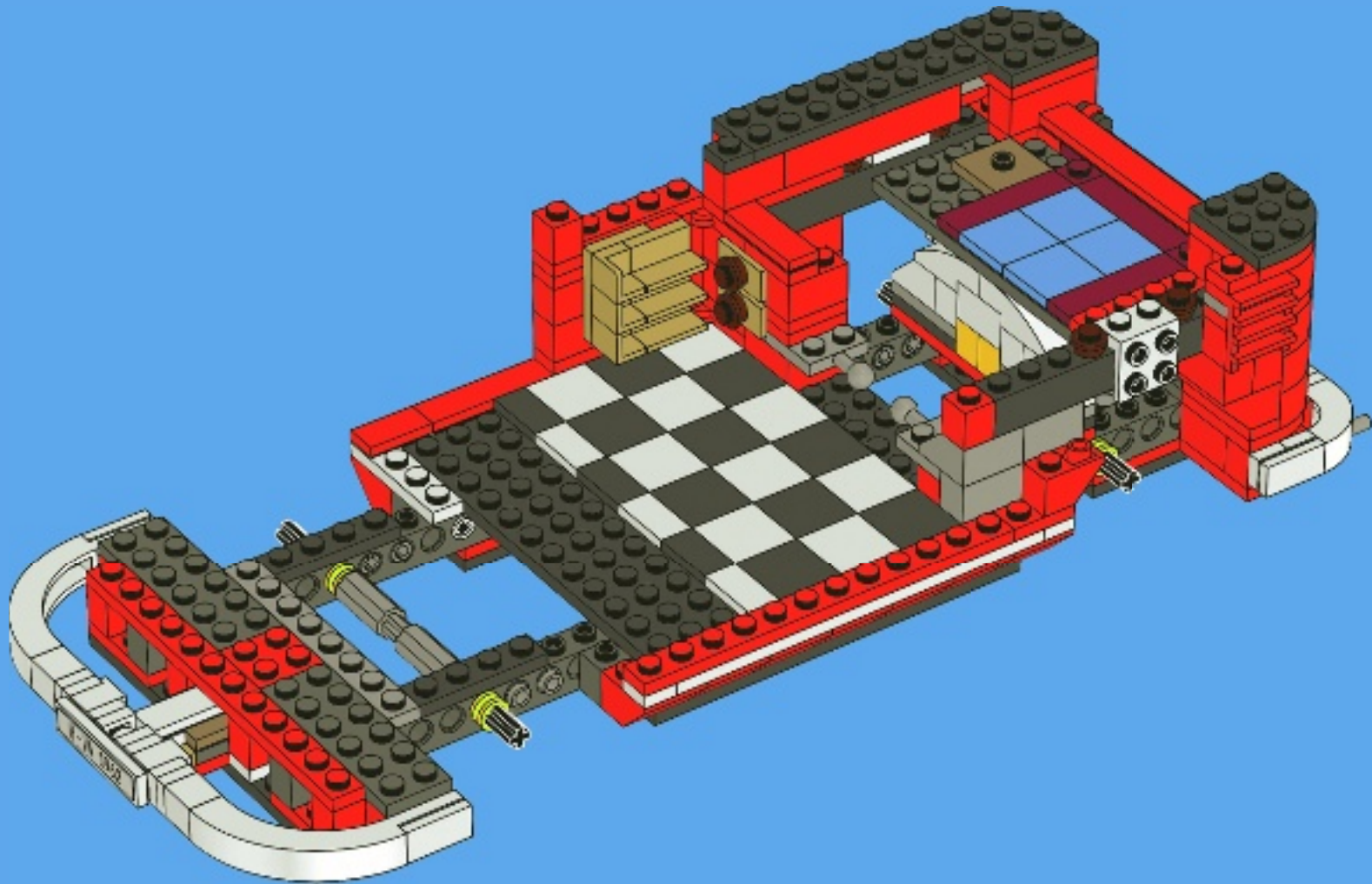



1

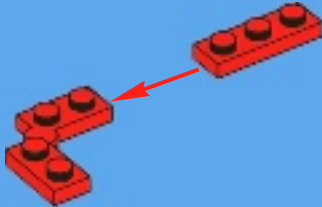

2

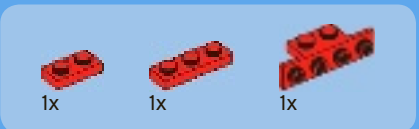
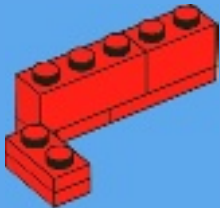

3

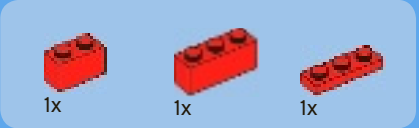
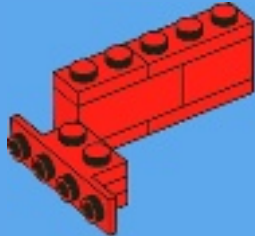

4

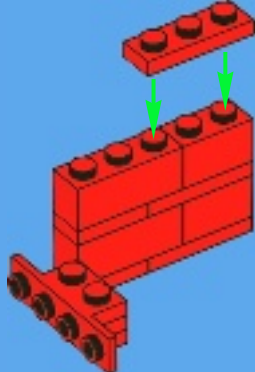



1x

5

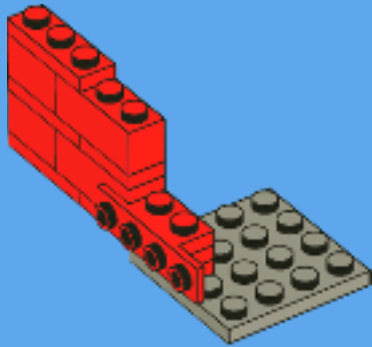

1x



1x



1x

6

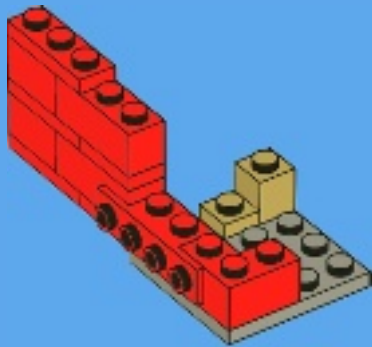

2x

7

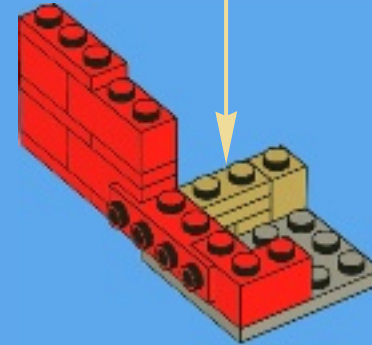
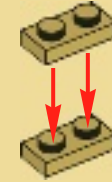

1x



1x



1x



1x



1x



1x

8

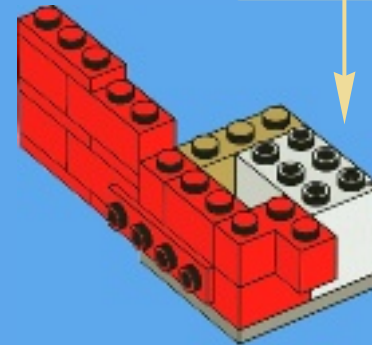
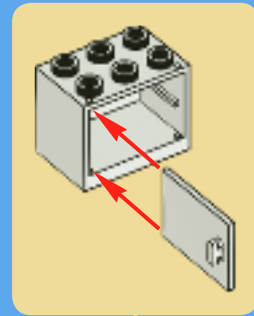

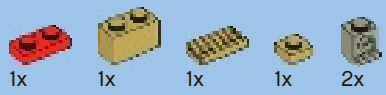

9

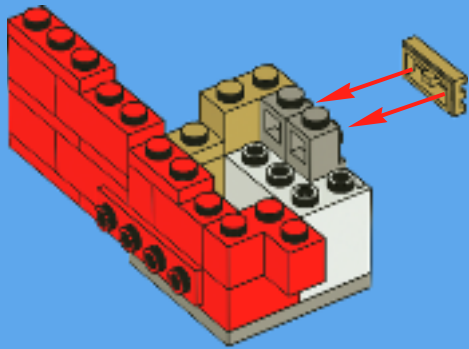

10

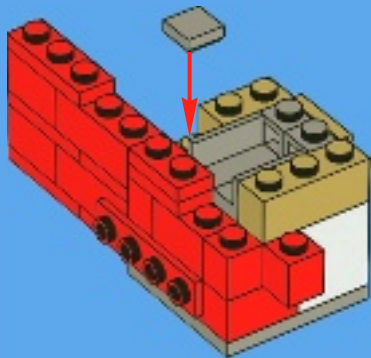

11

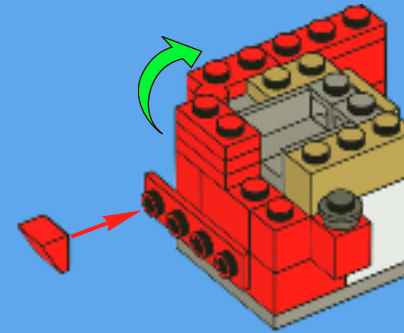

12

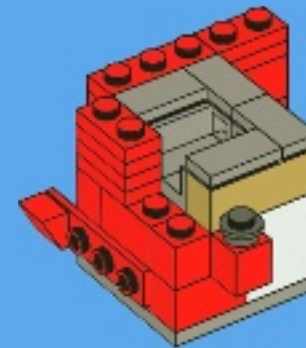

41

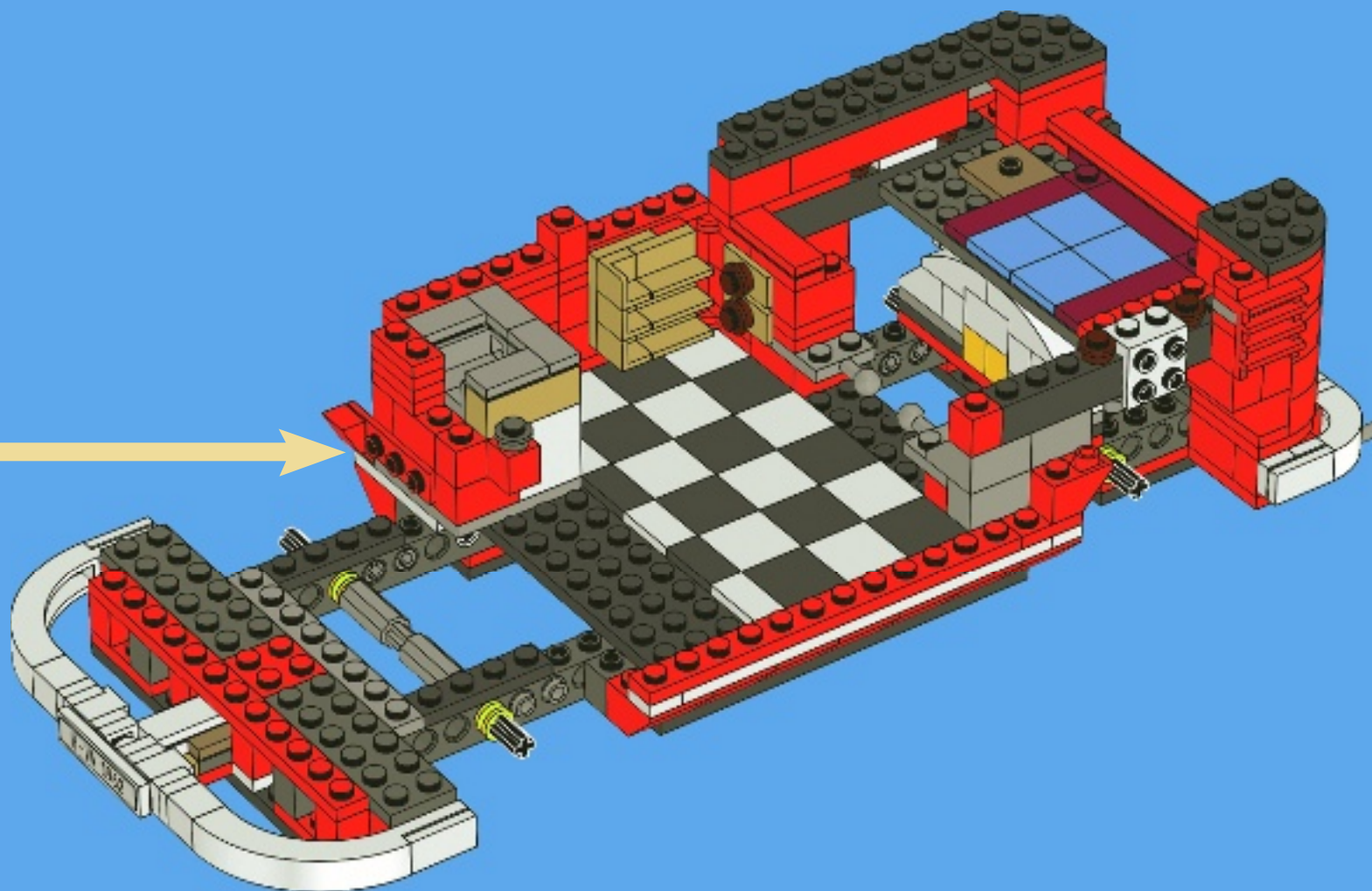



42

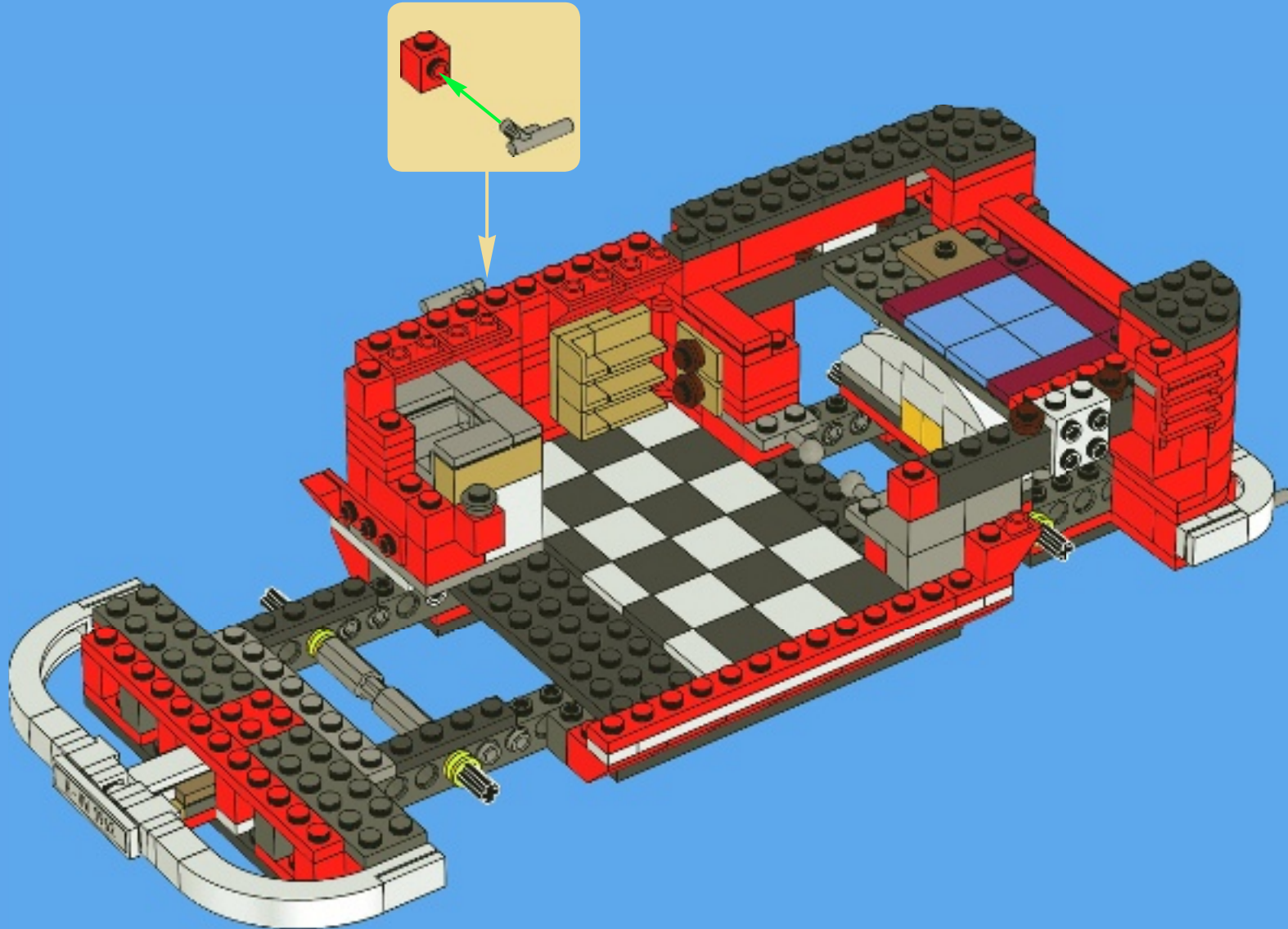



2x



1x



2x

43

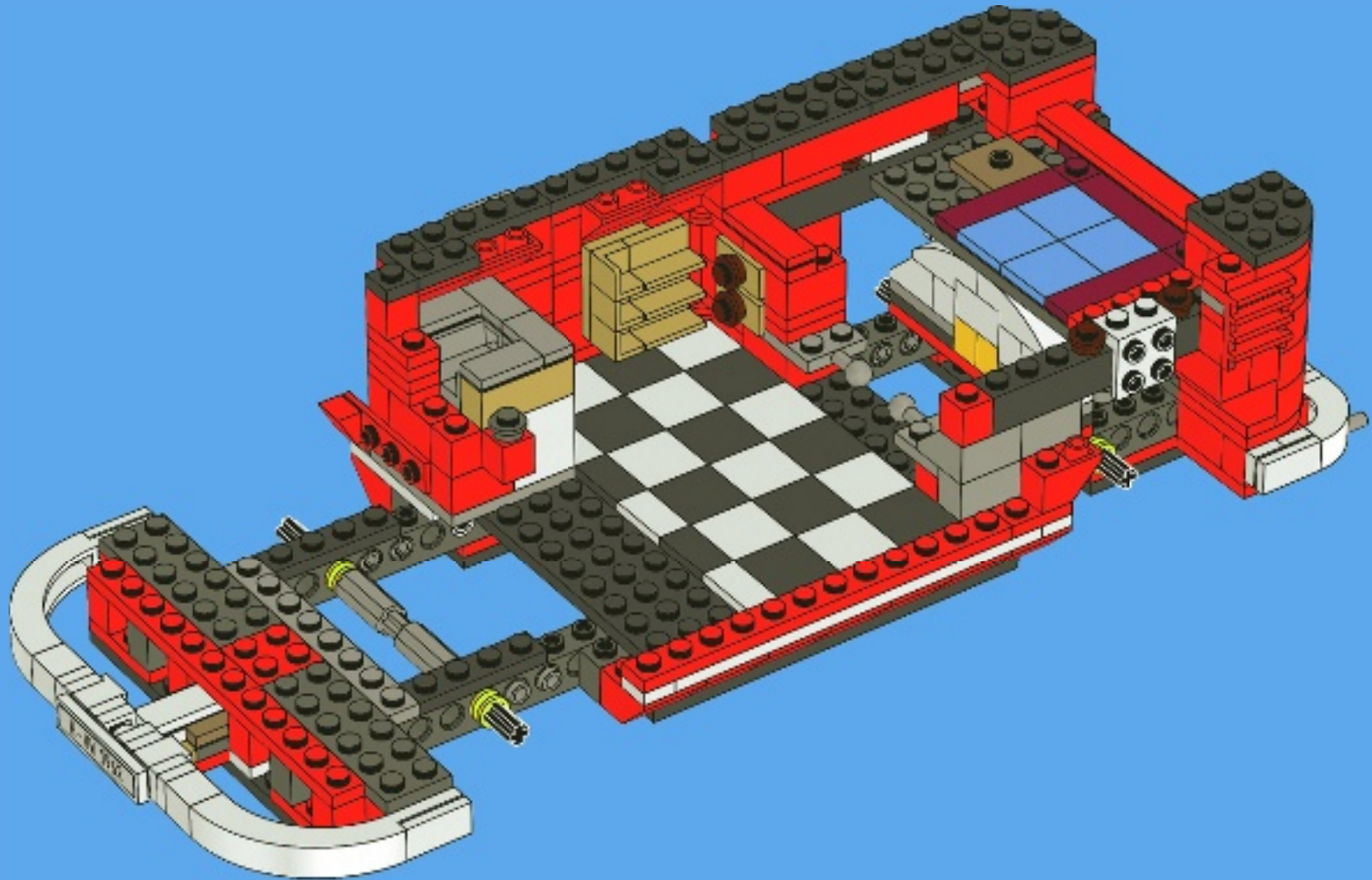

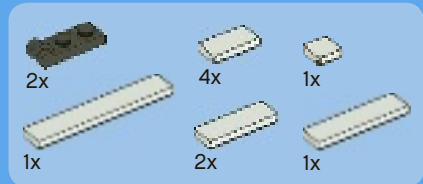

44

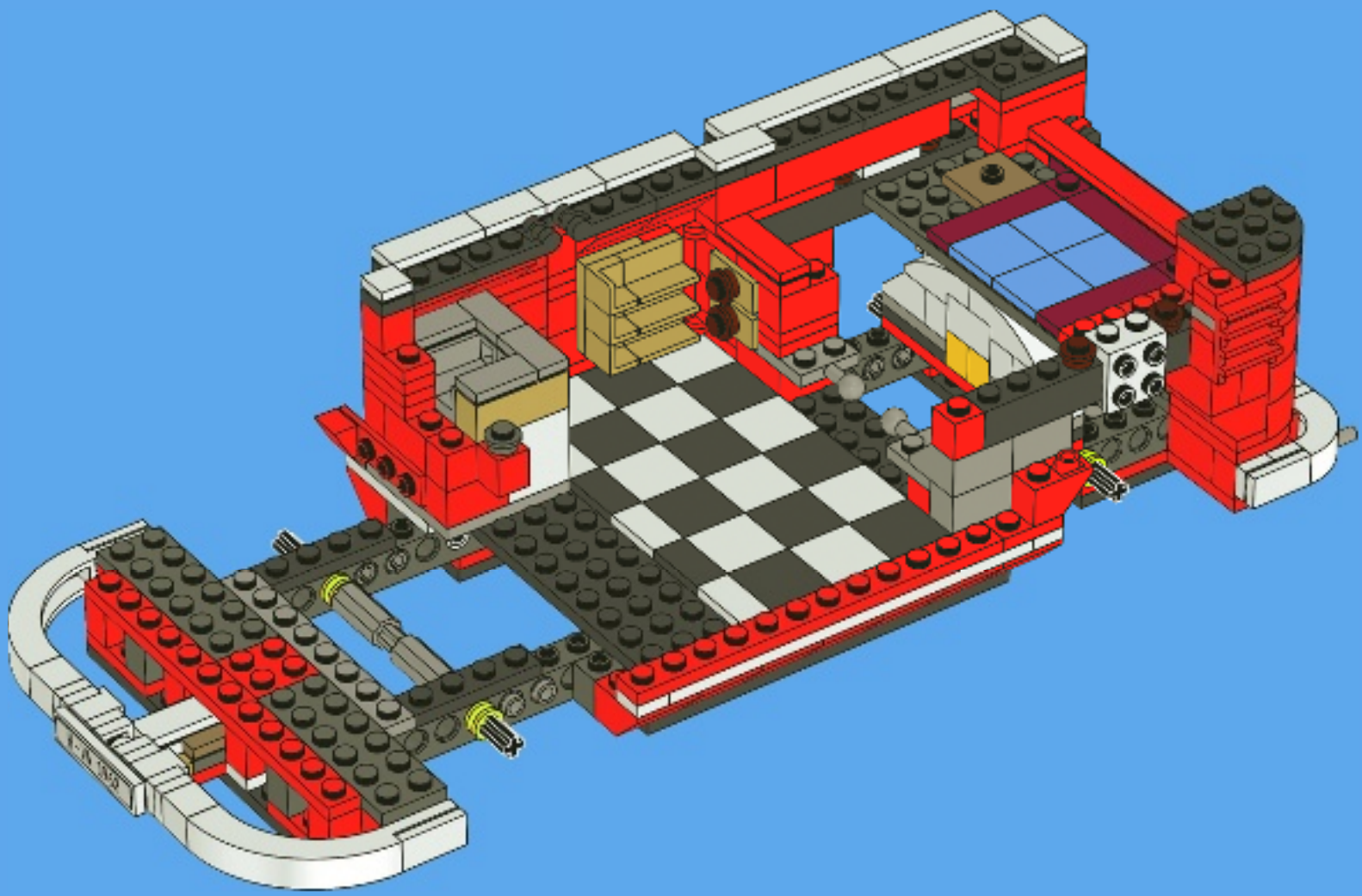

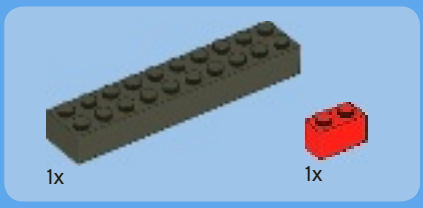

45

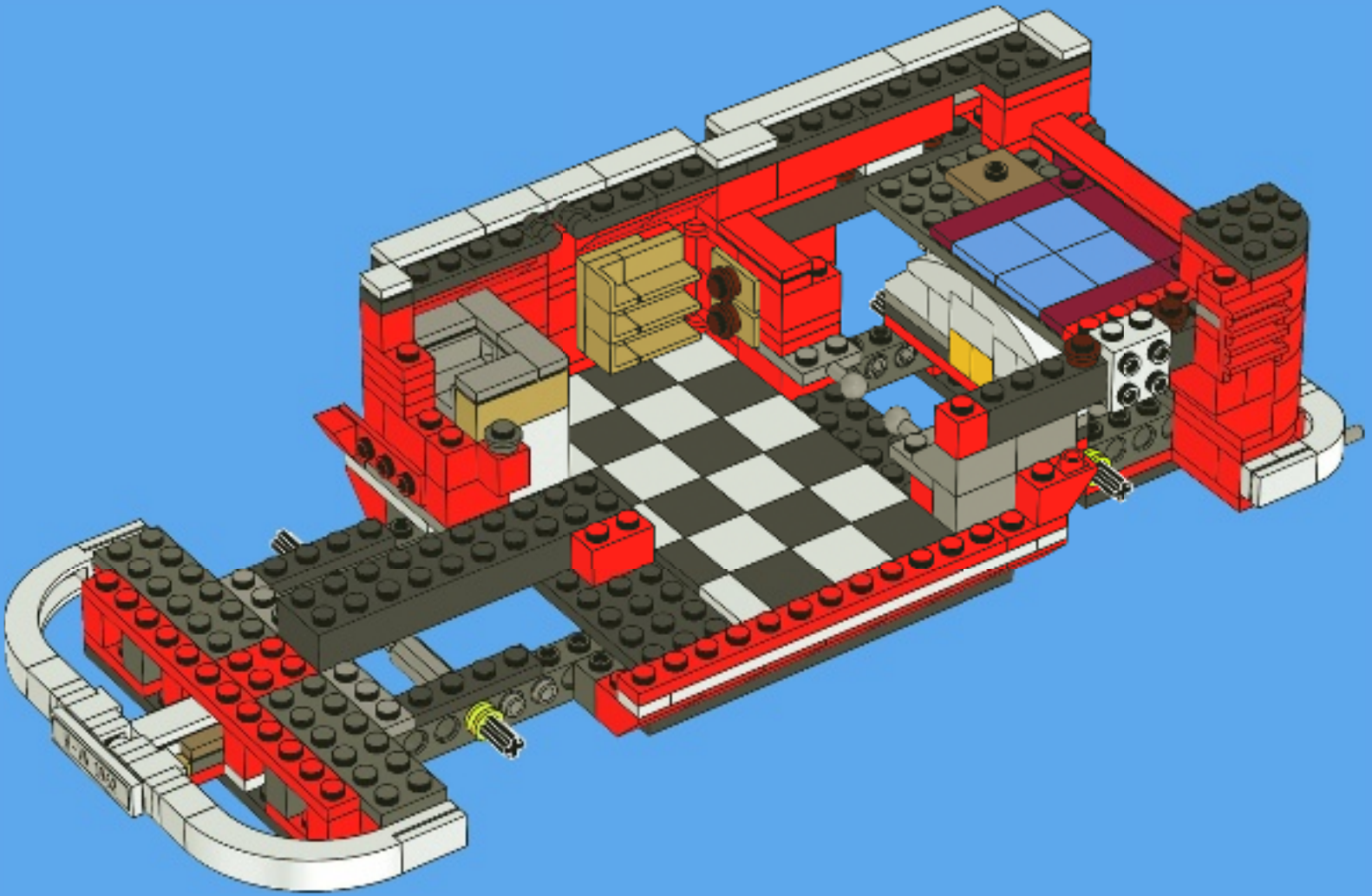



3x



1x

46

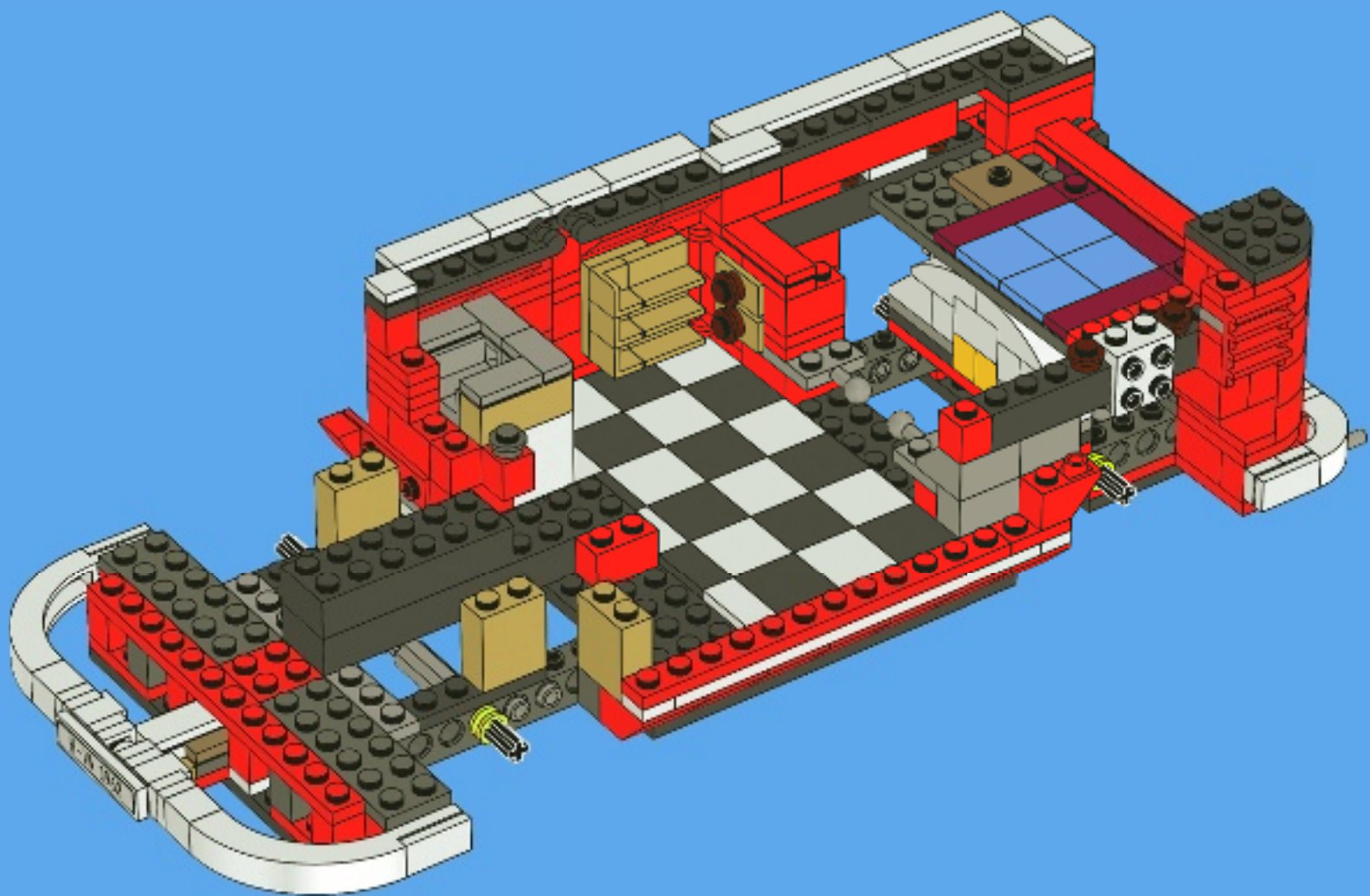



1x



1x

47

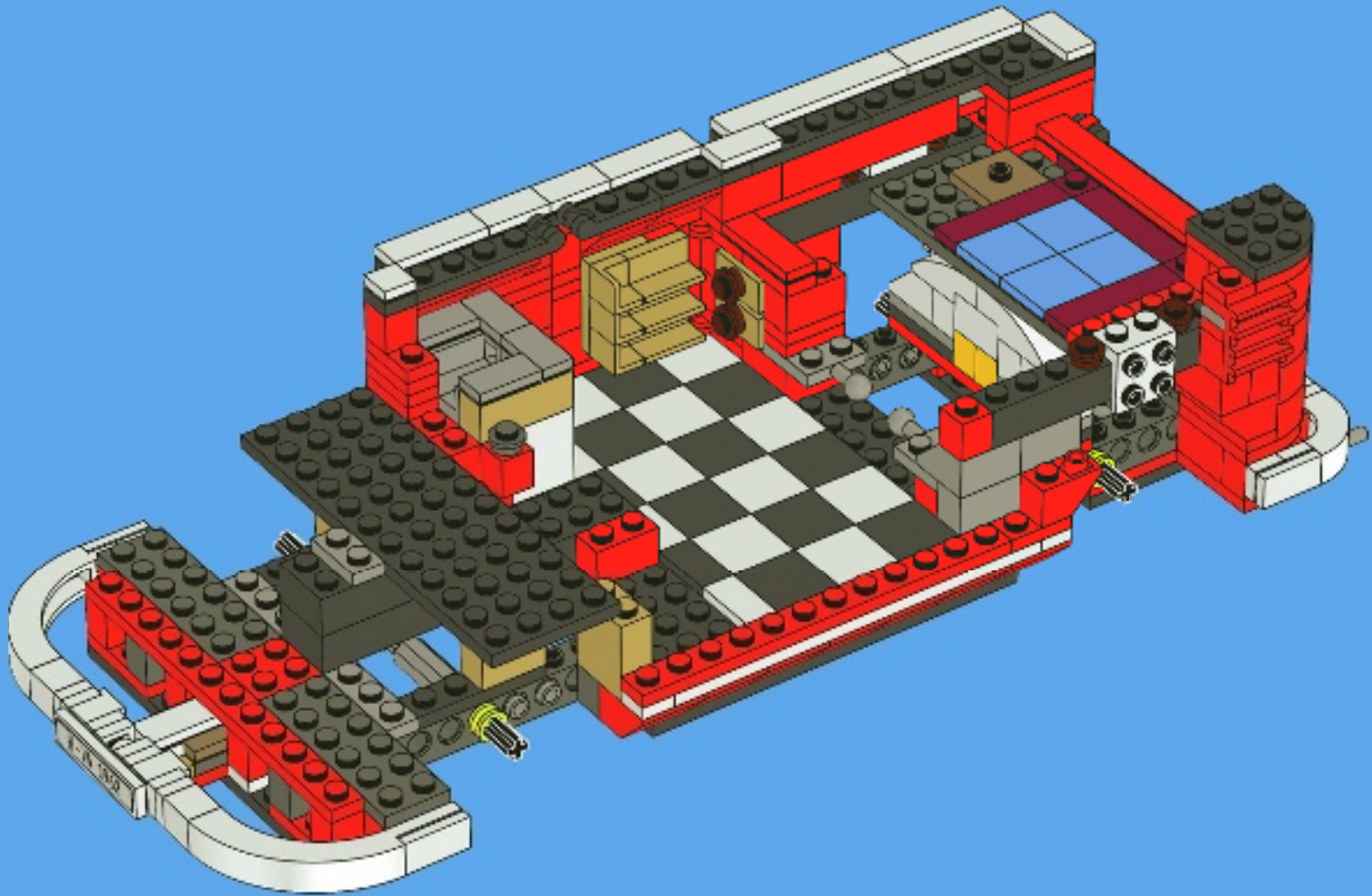



2x



2x



1x



4x

48

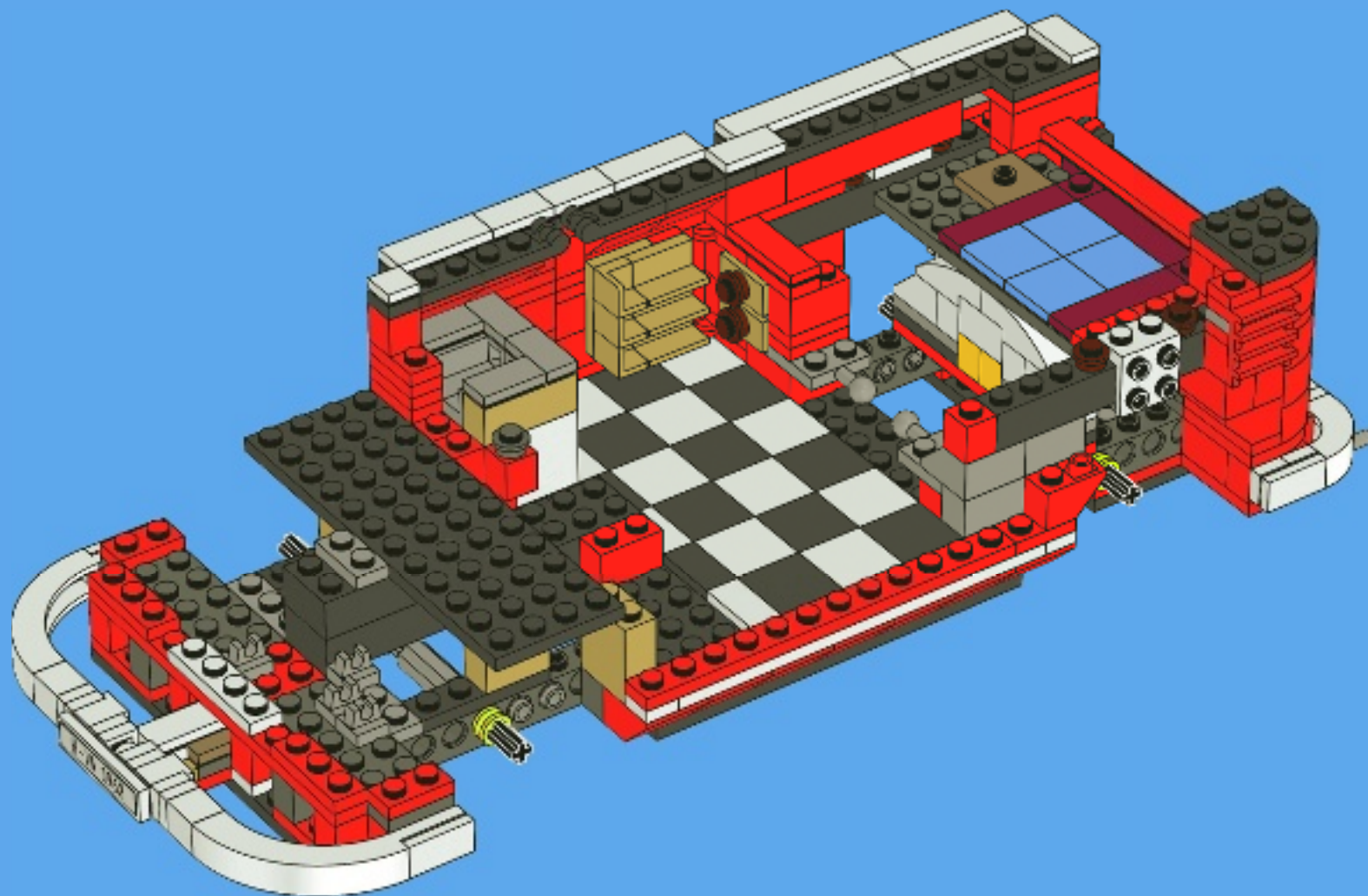

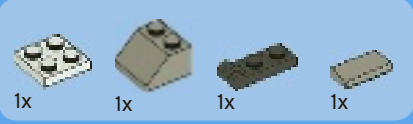

49

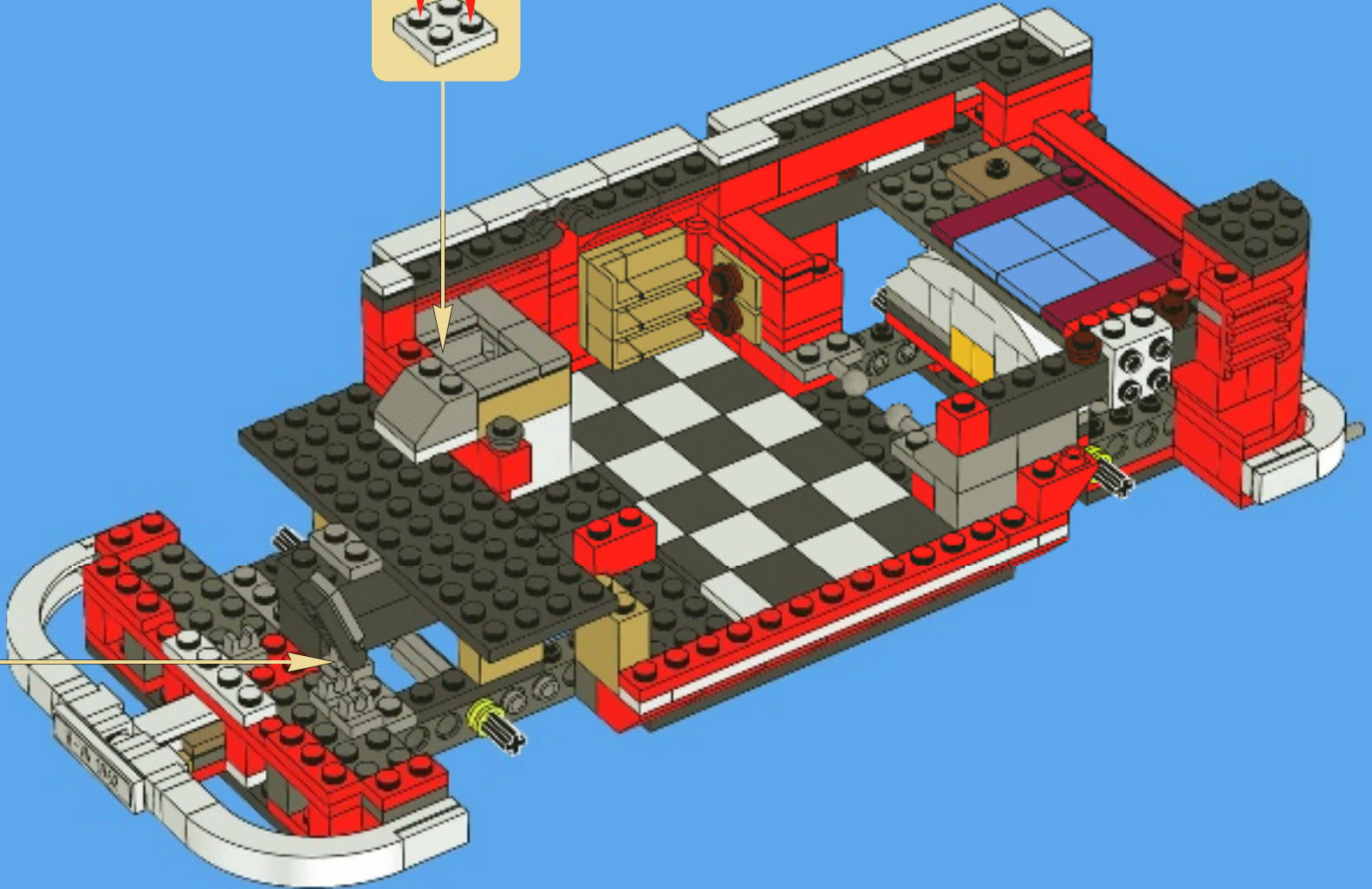
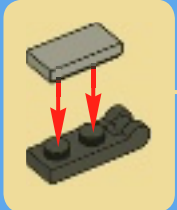
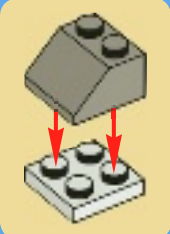

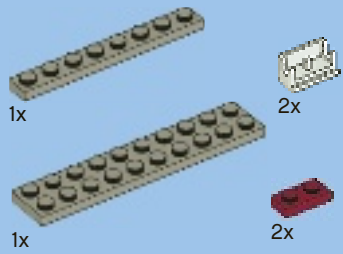

50

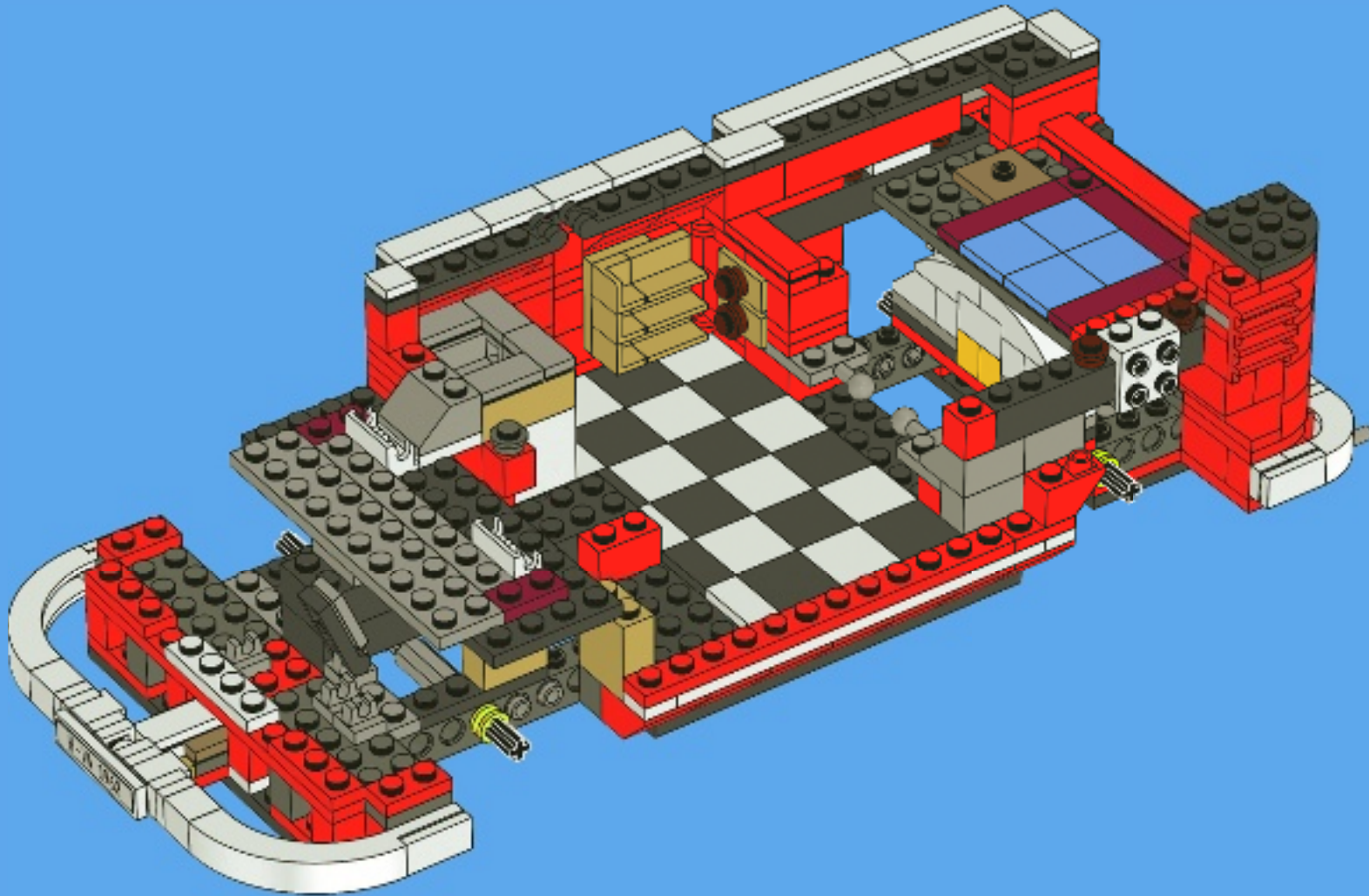

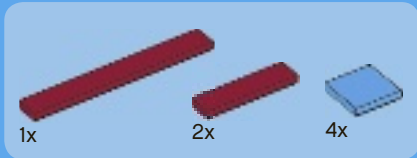

51

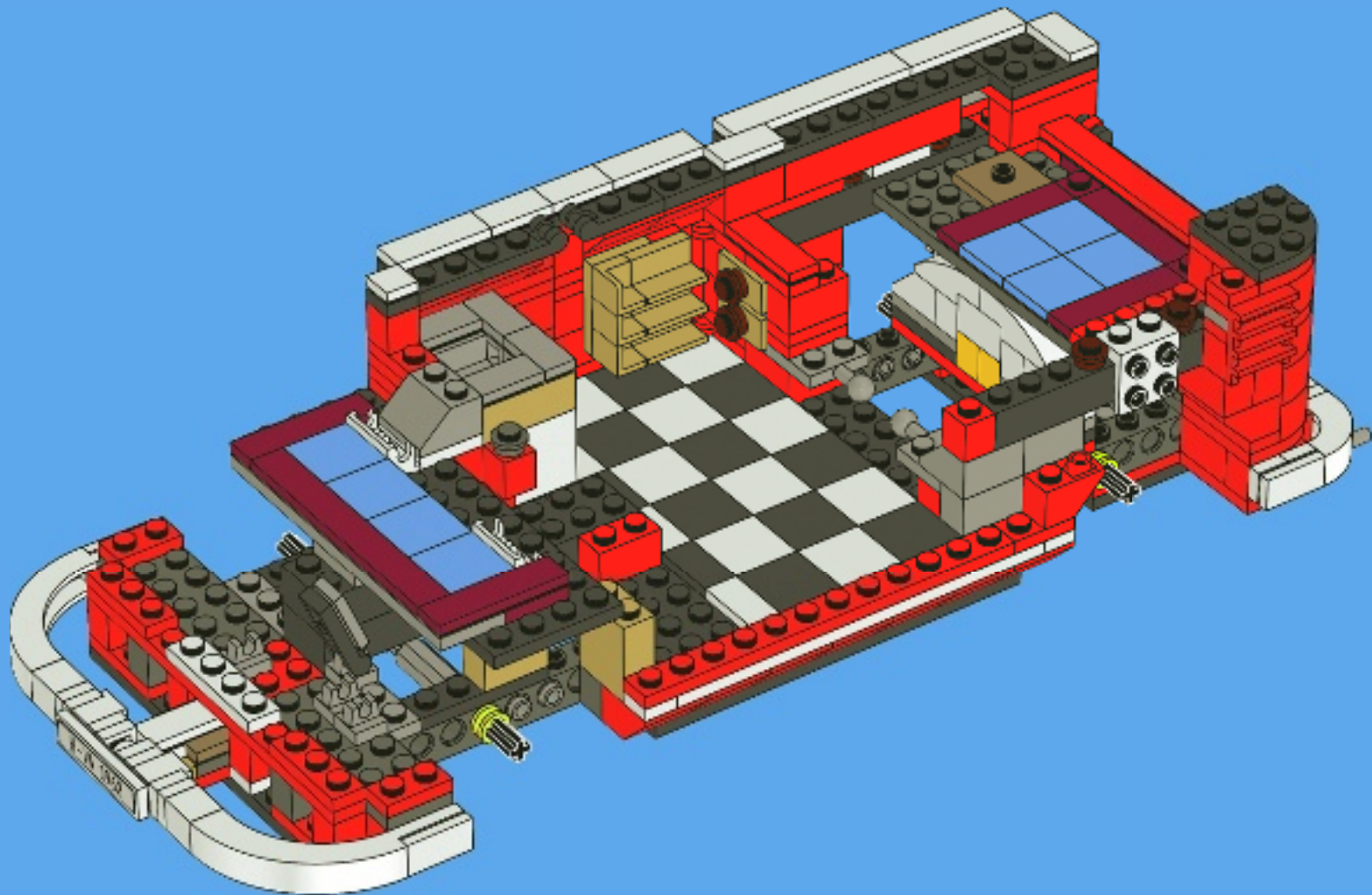



1x



1x



2x



1x

52

1



2

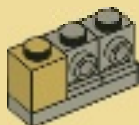

3

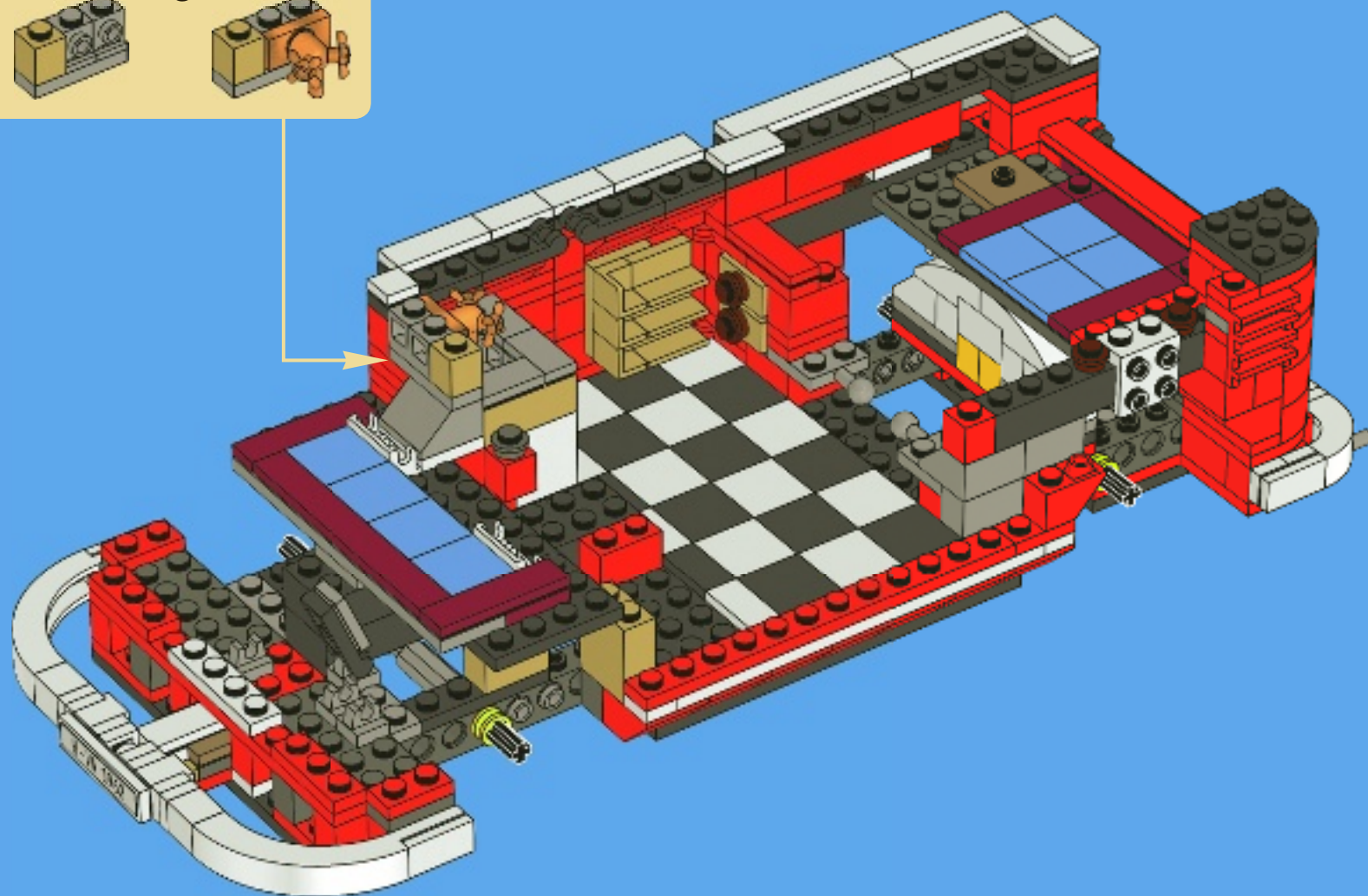



53

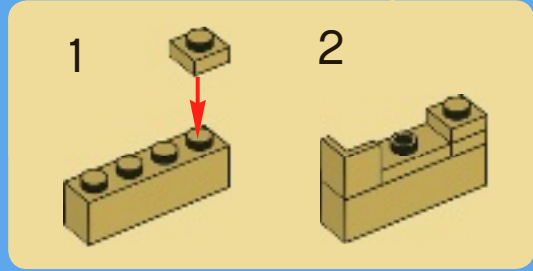
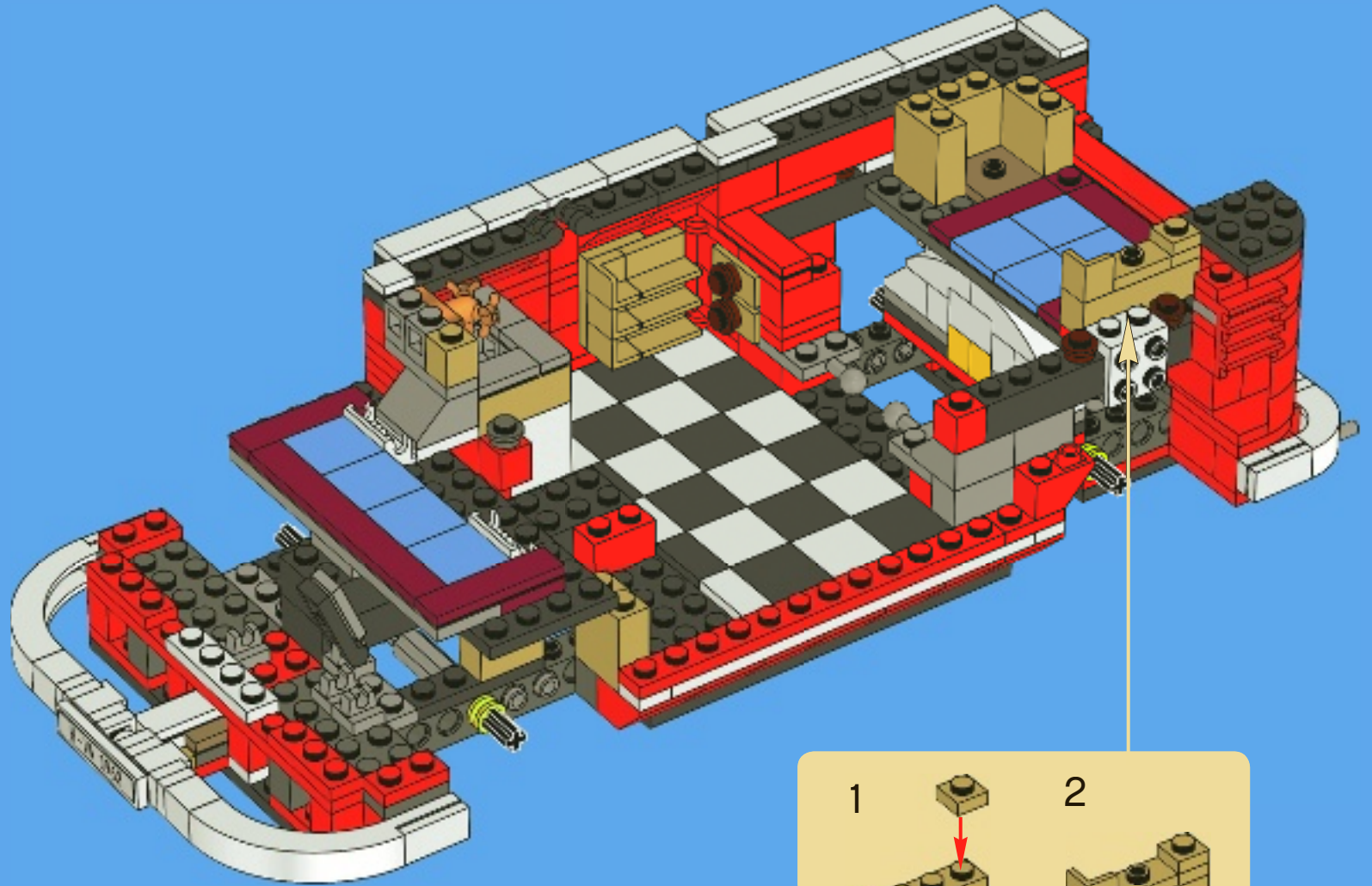

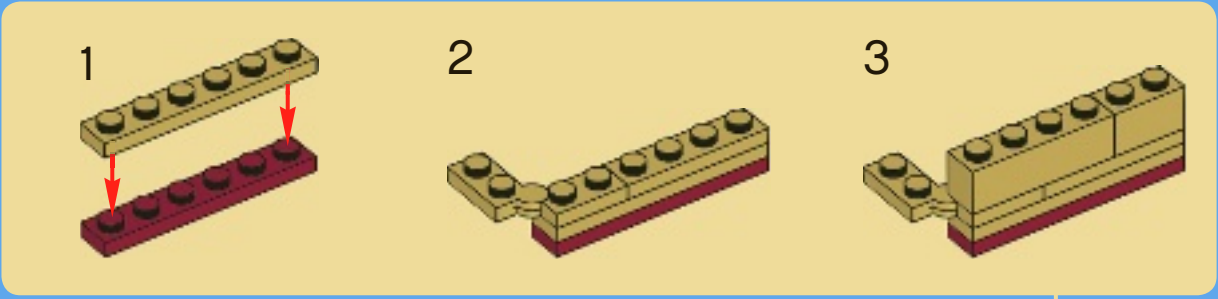
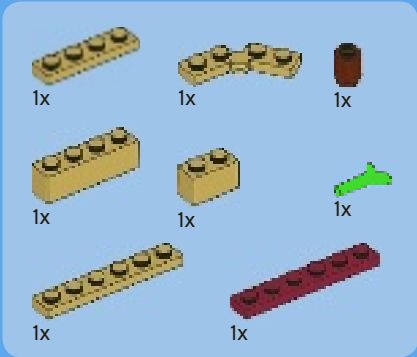

54

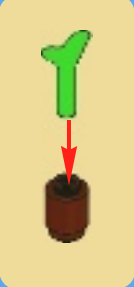
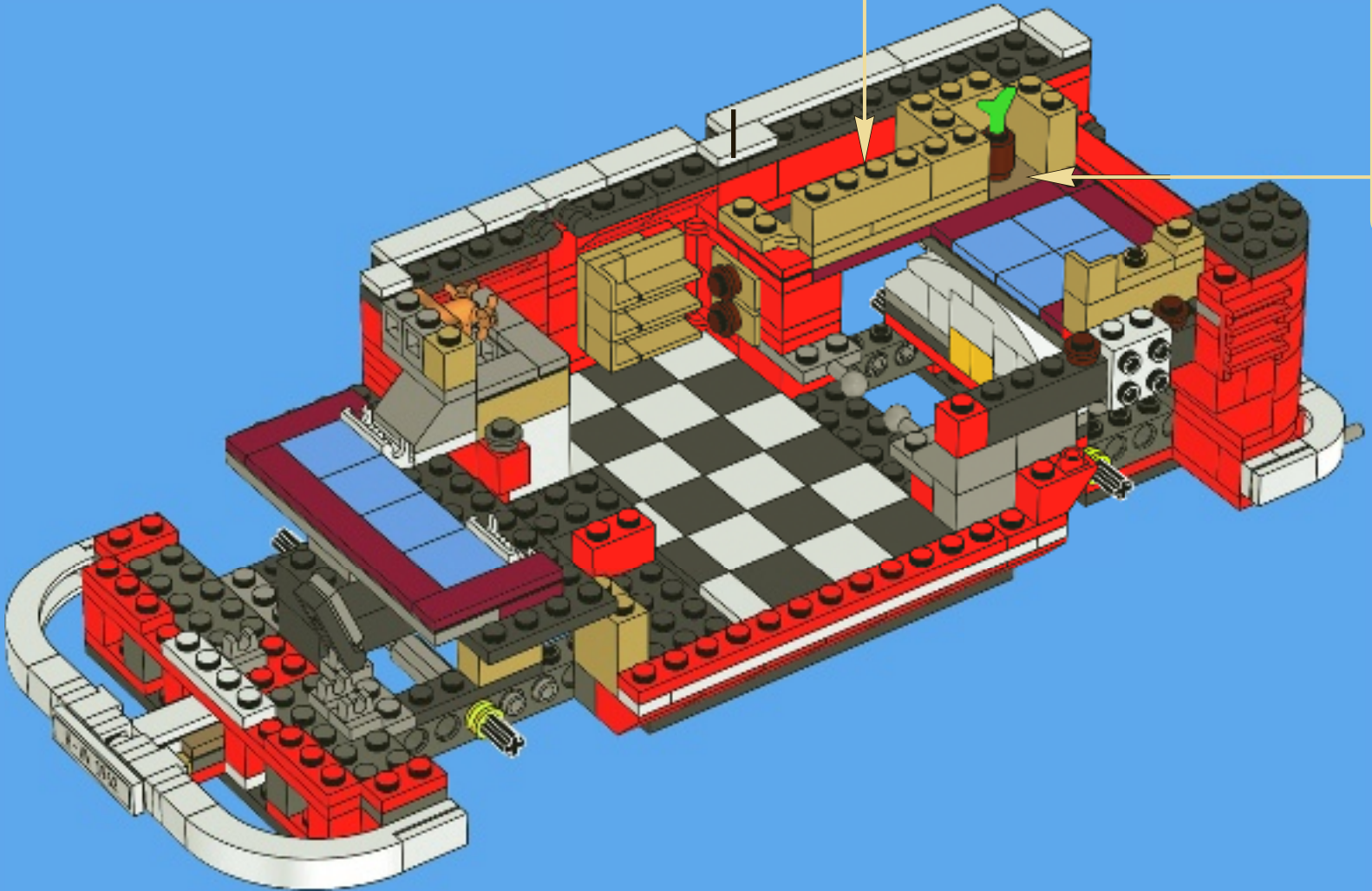



55

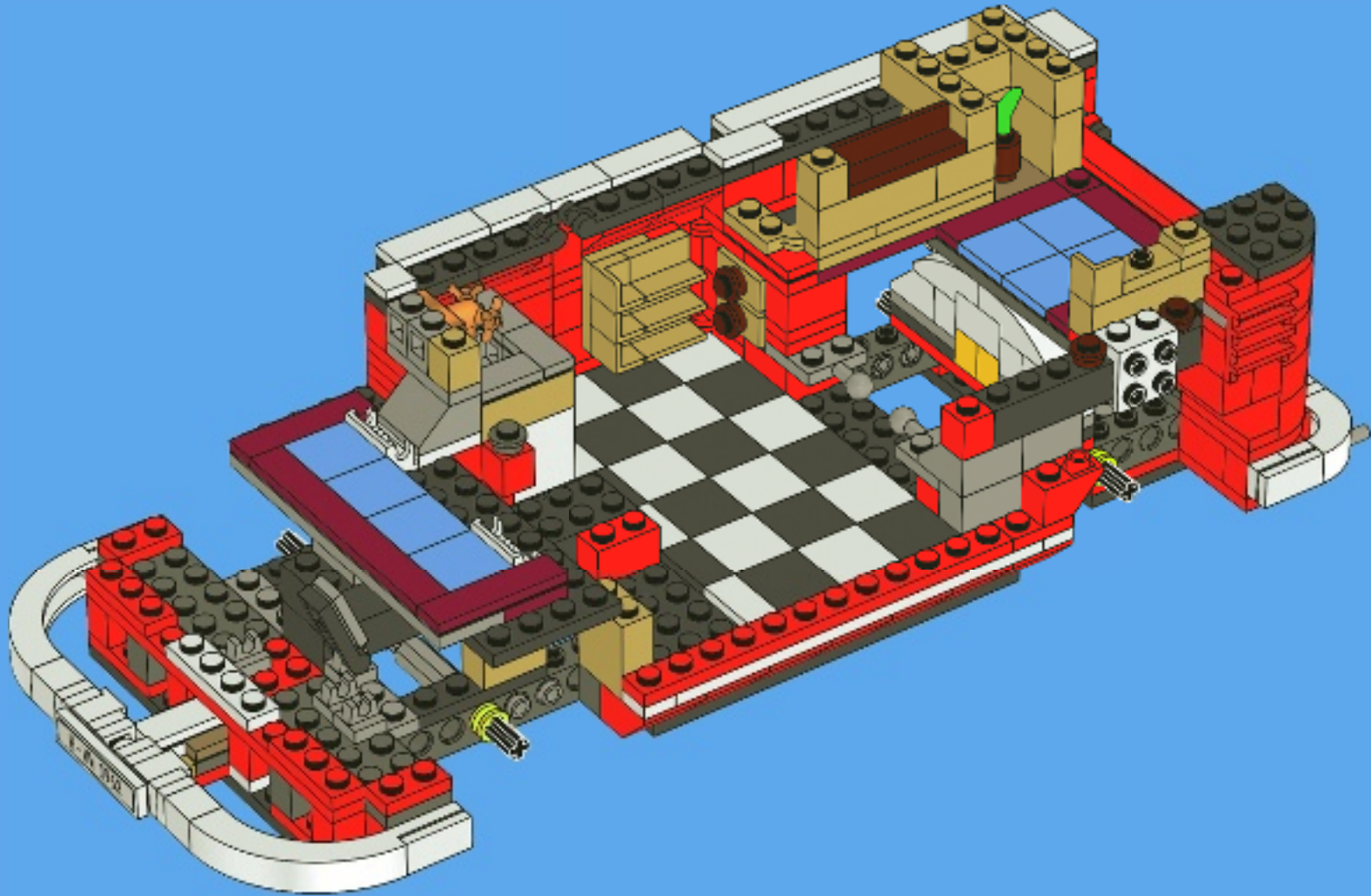

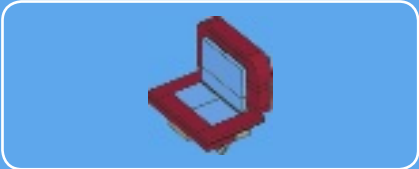

1

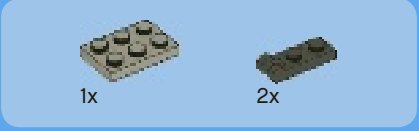

2

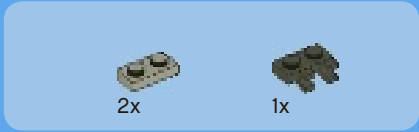

3



4

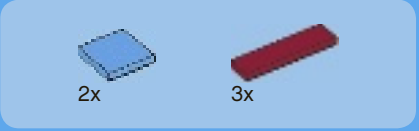

5



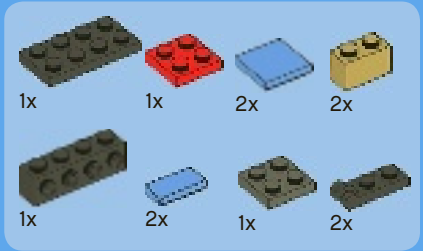

6

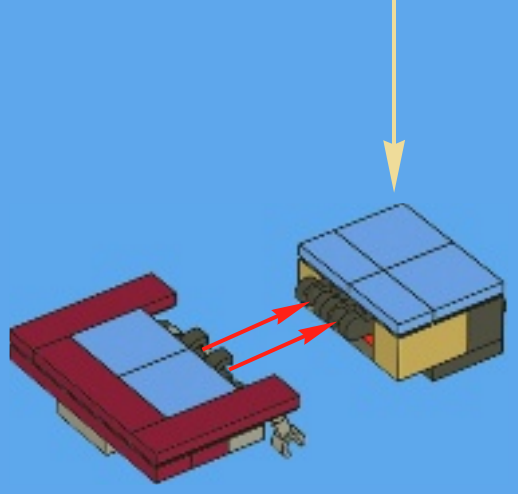
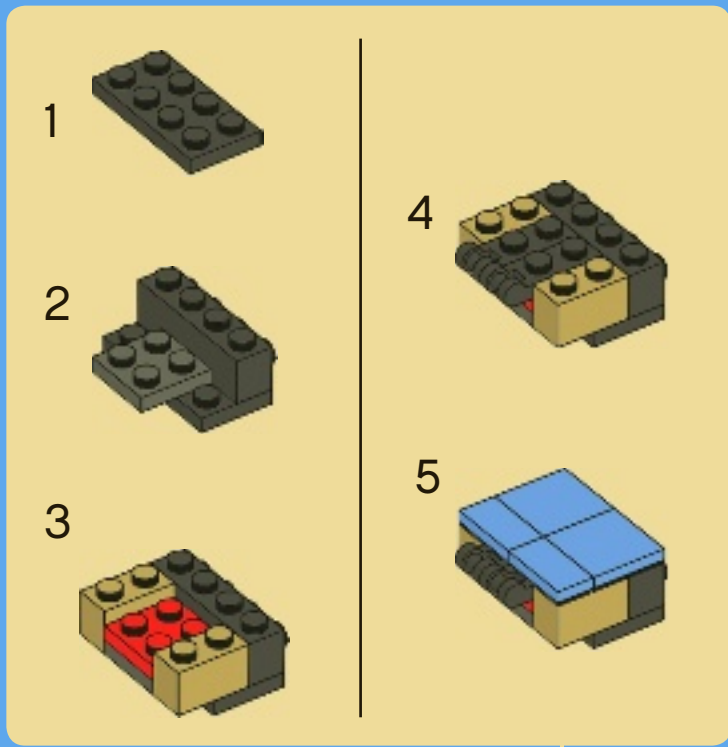

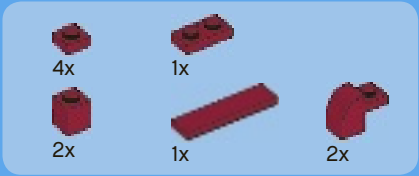

7

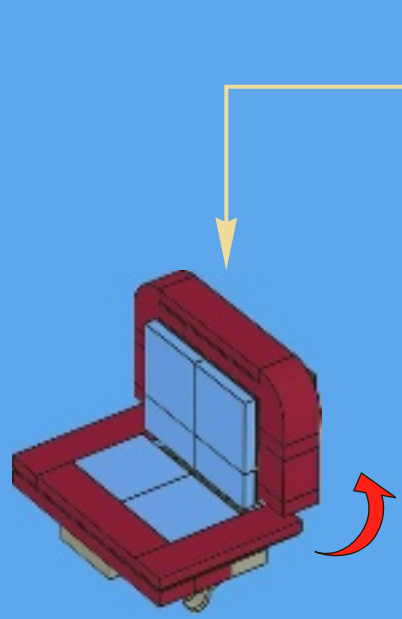
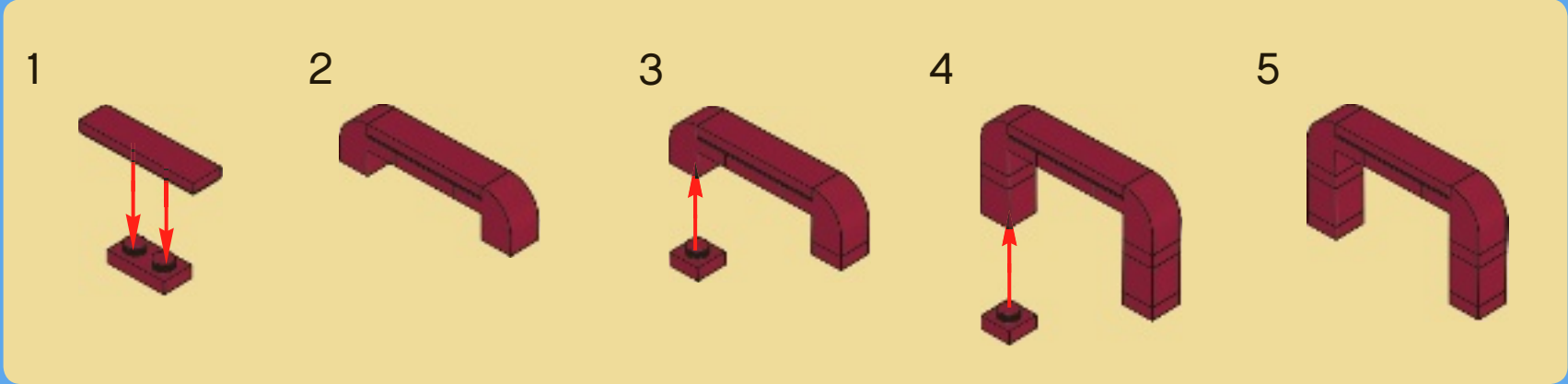

56



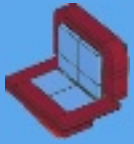

1x

1



1x



1x

2



2x



1x

3



2x

4

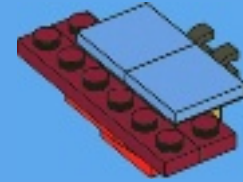

3x

5

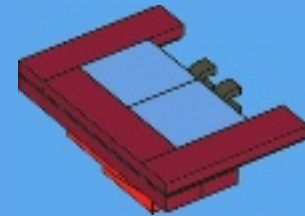

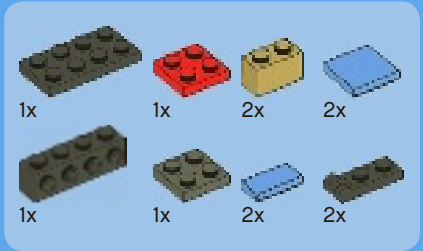

6

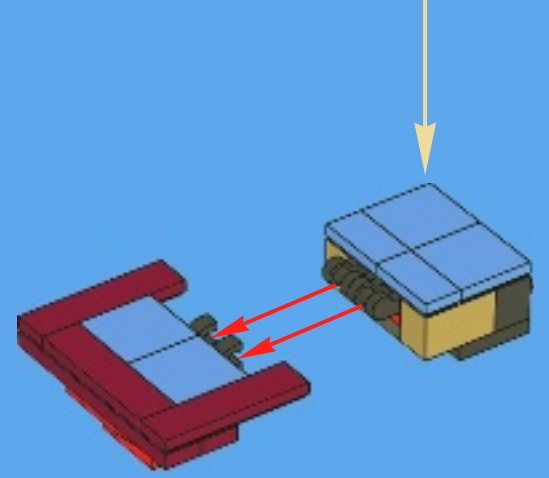
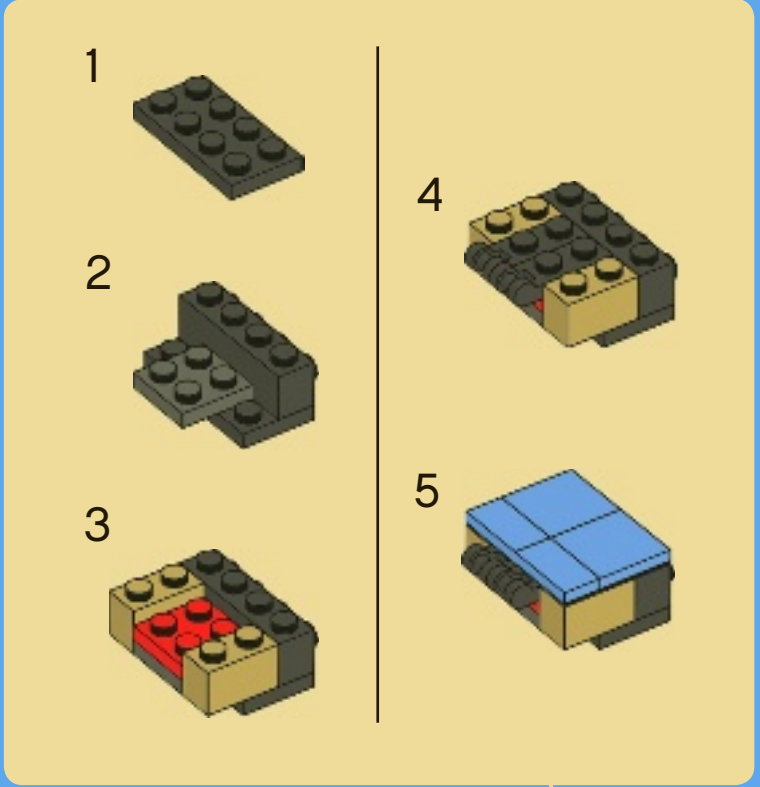

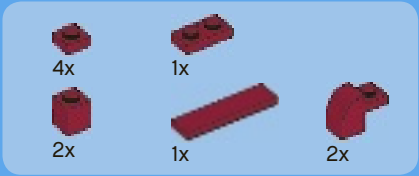

7

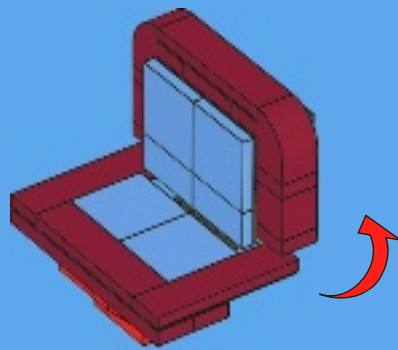
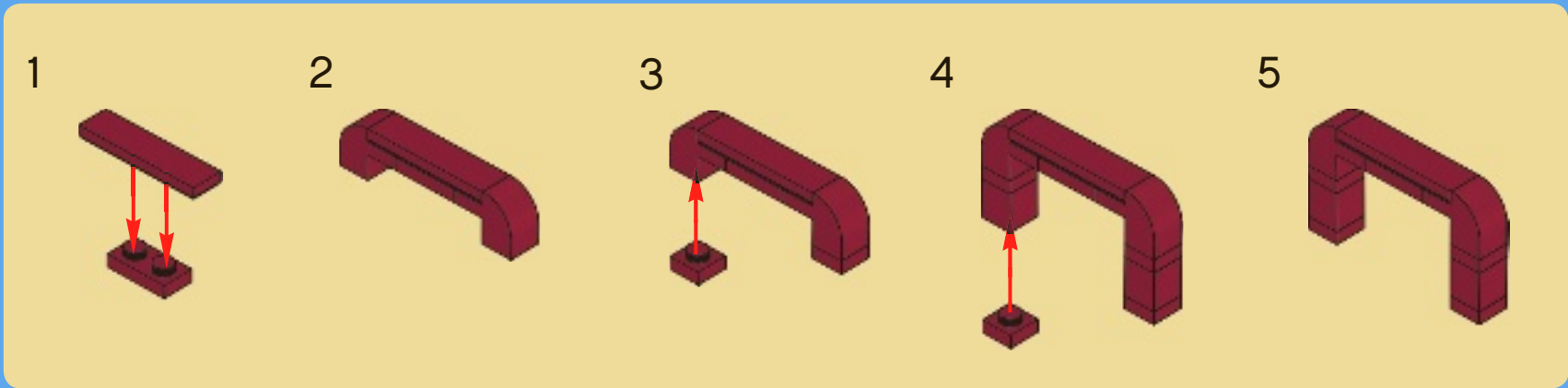

57

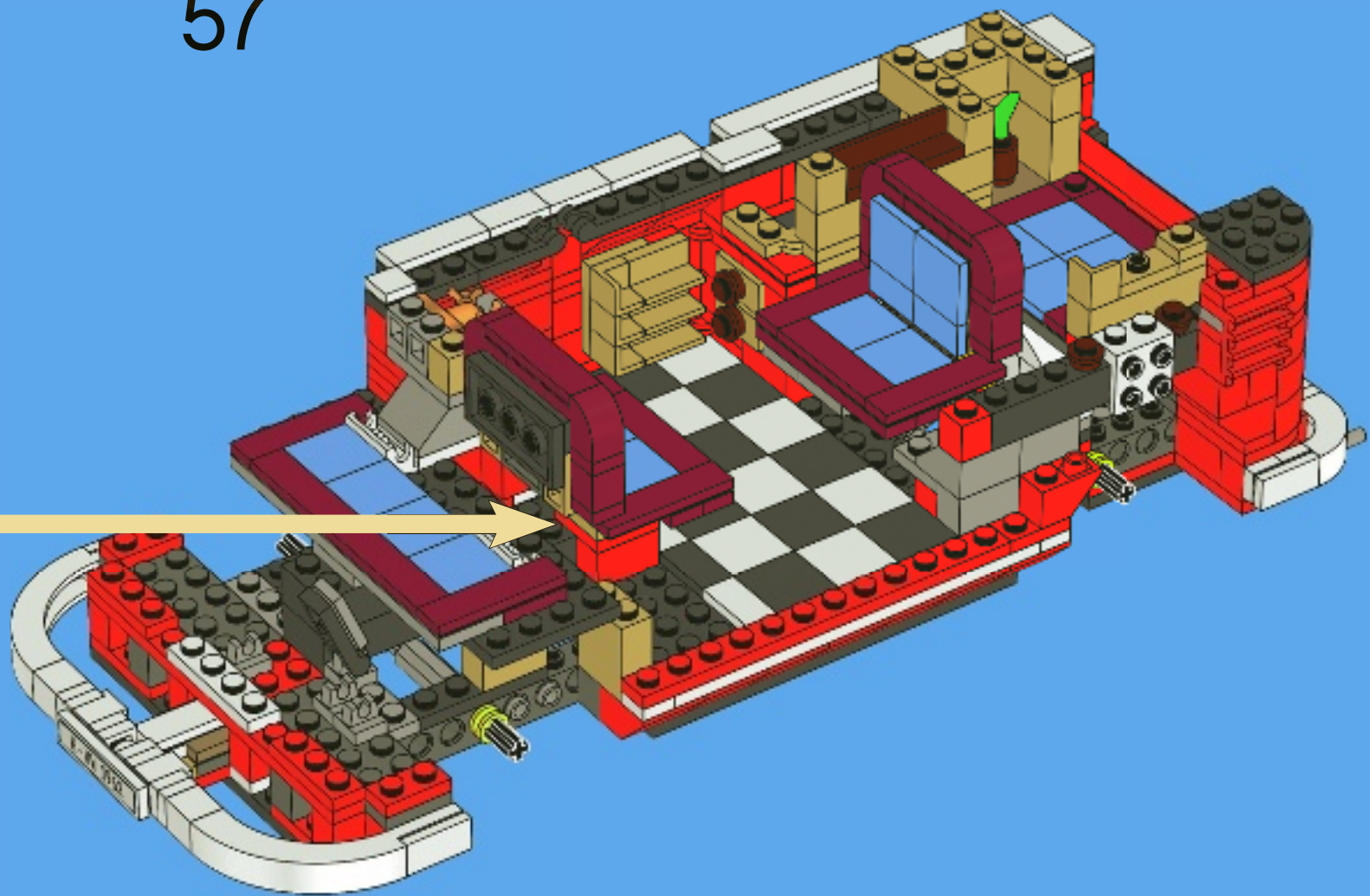



2x



1x



1x

58

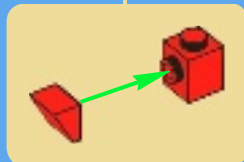
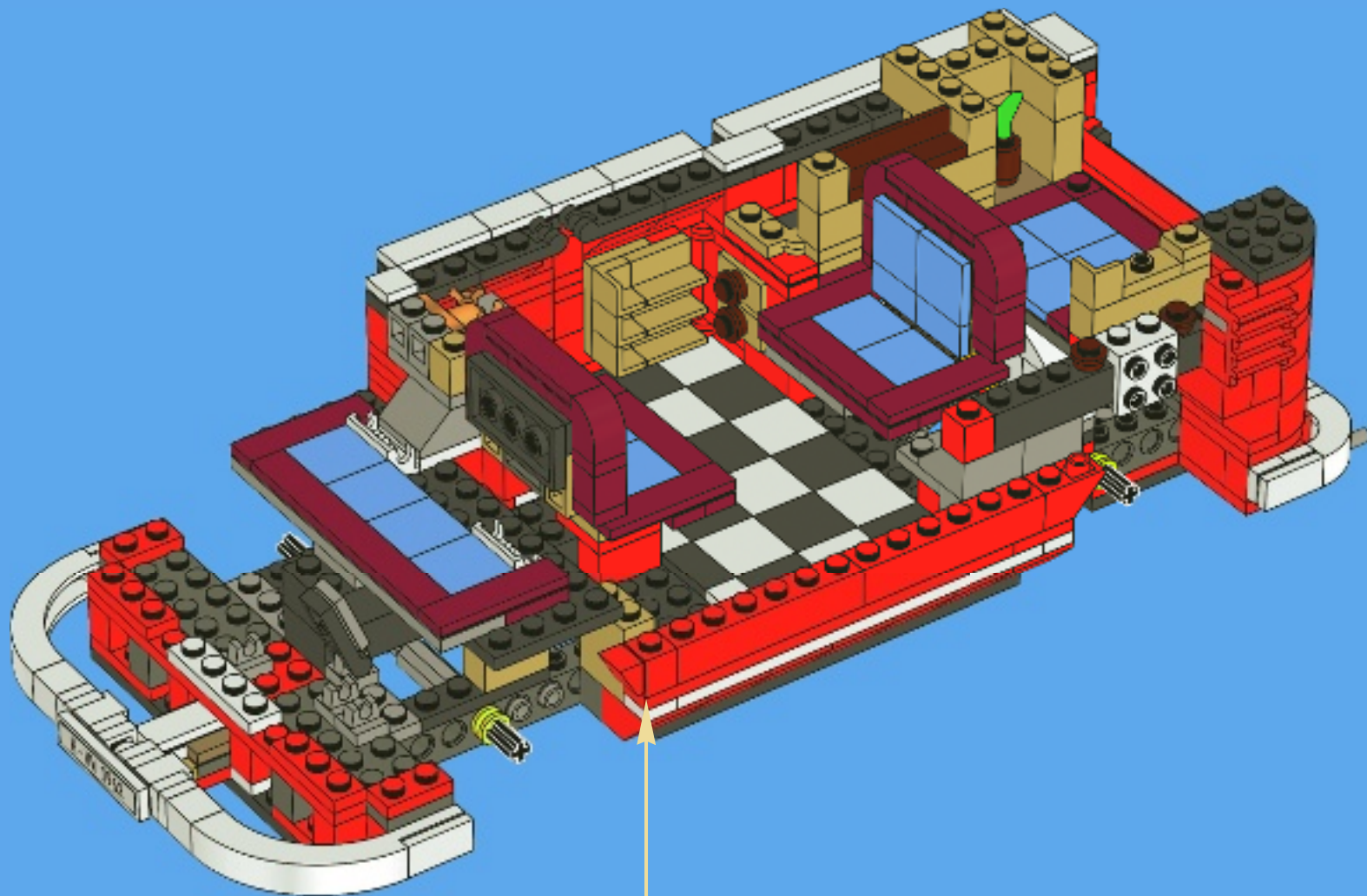



2x



1x



1x

59

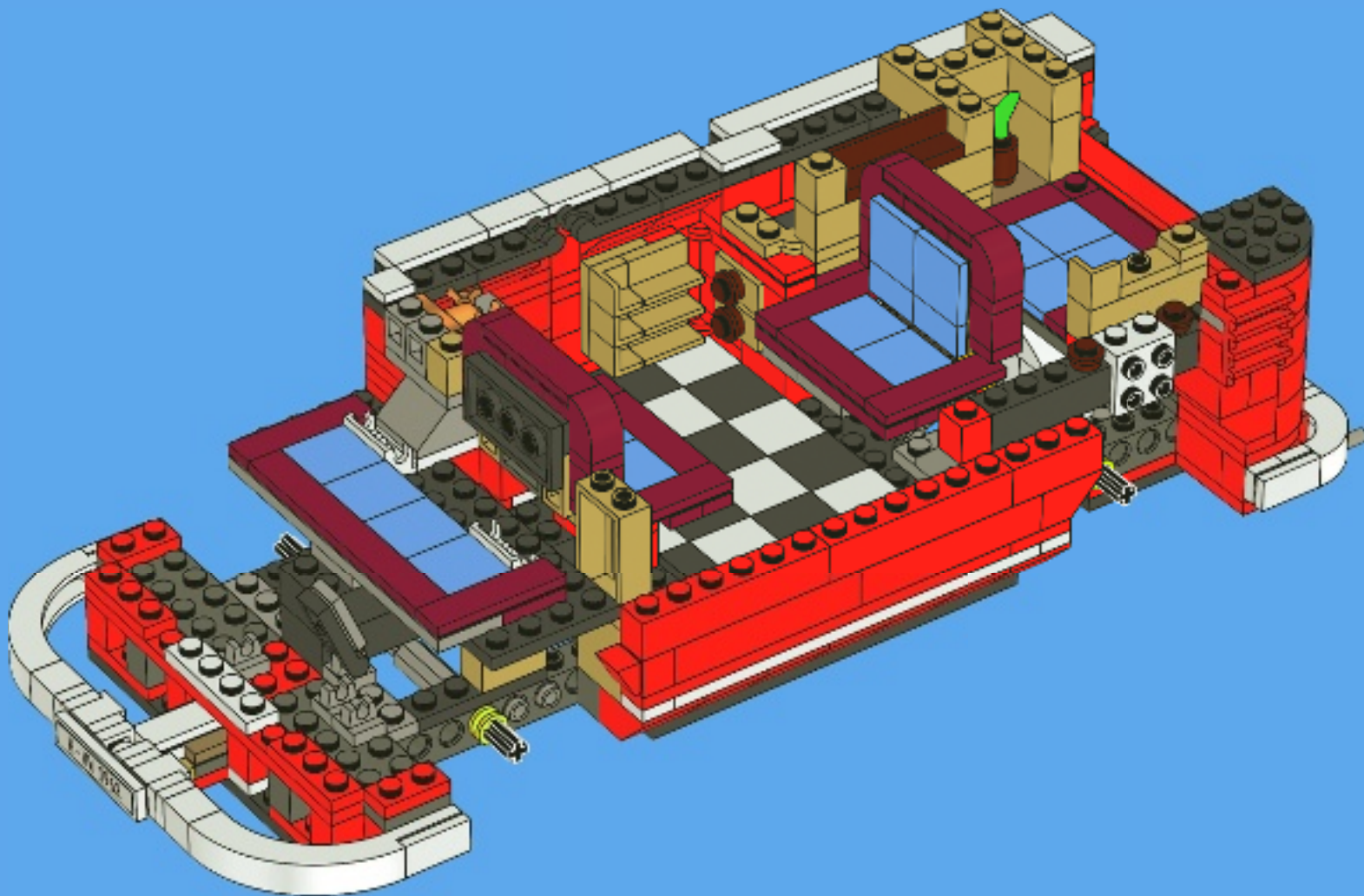



2x



1x

60

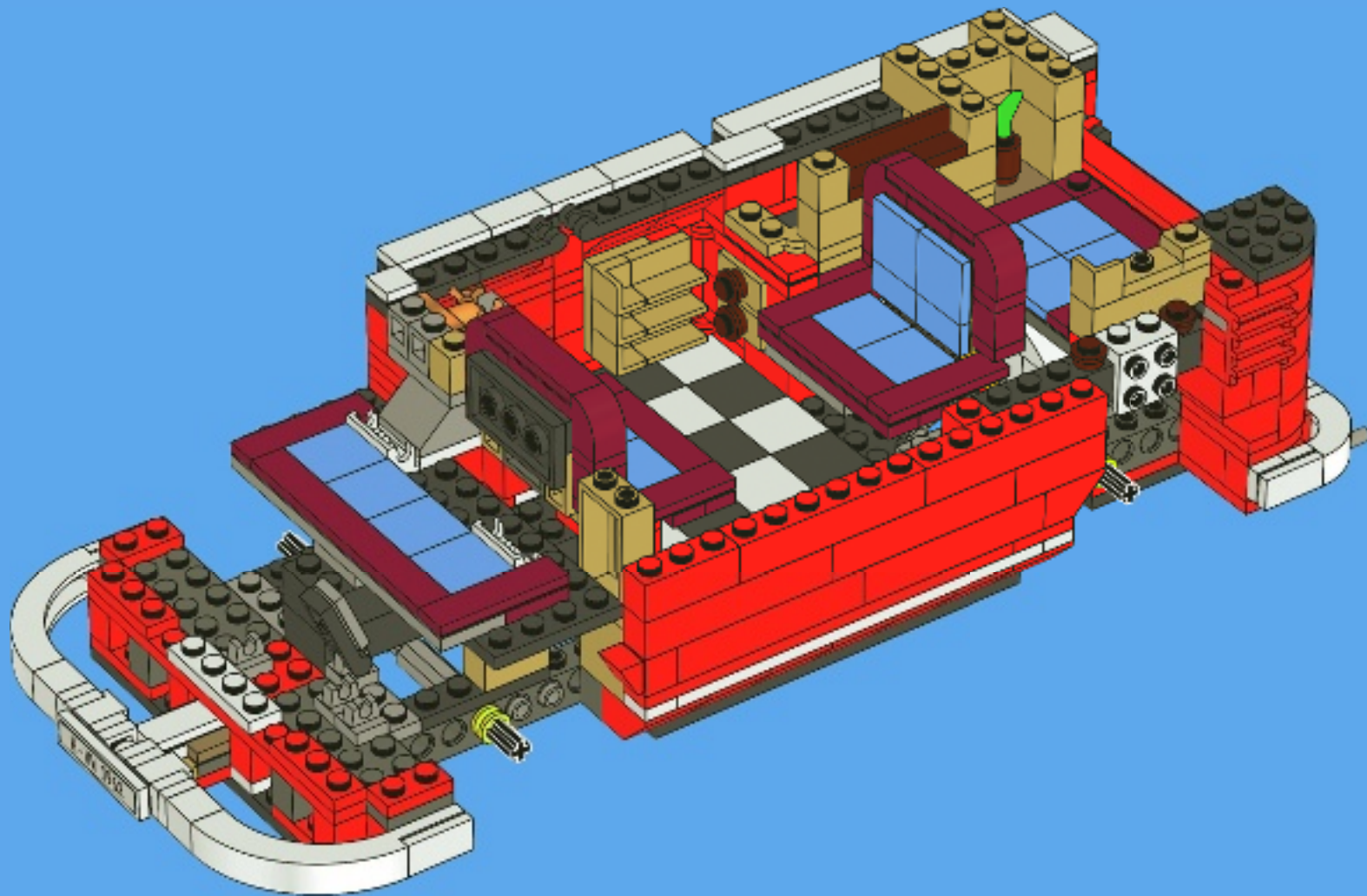

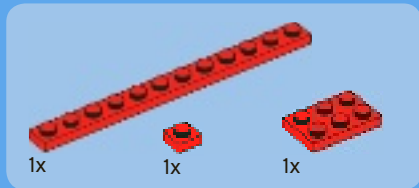

61

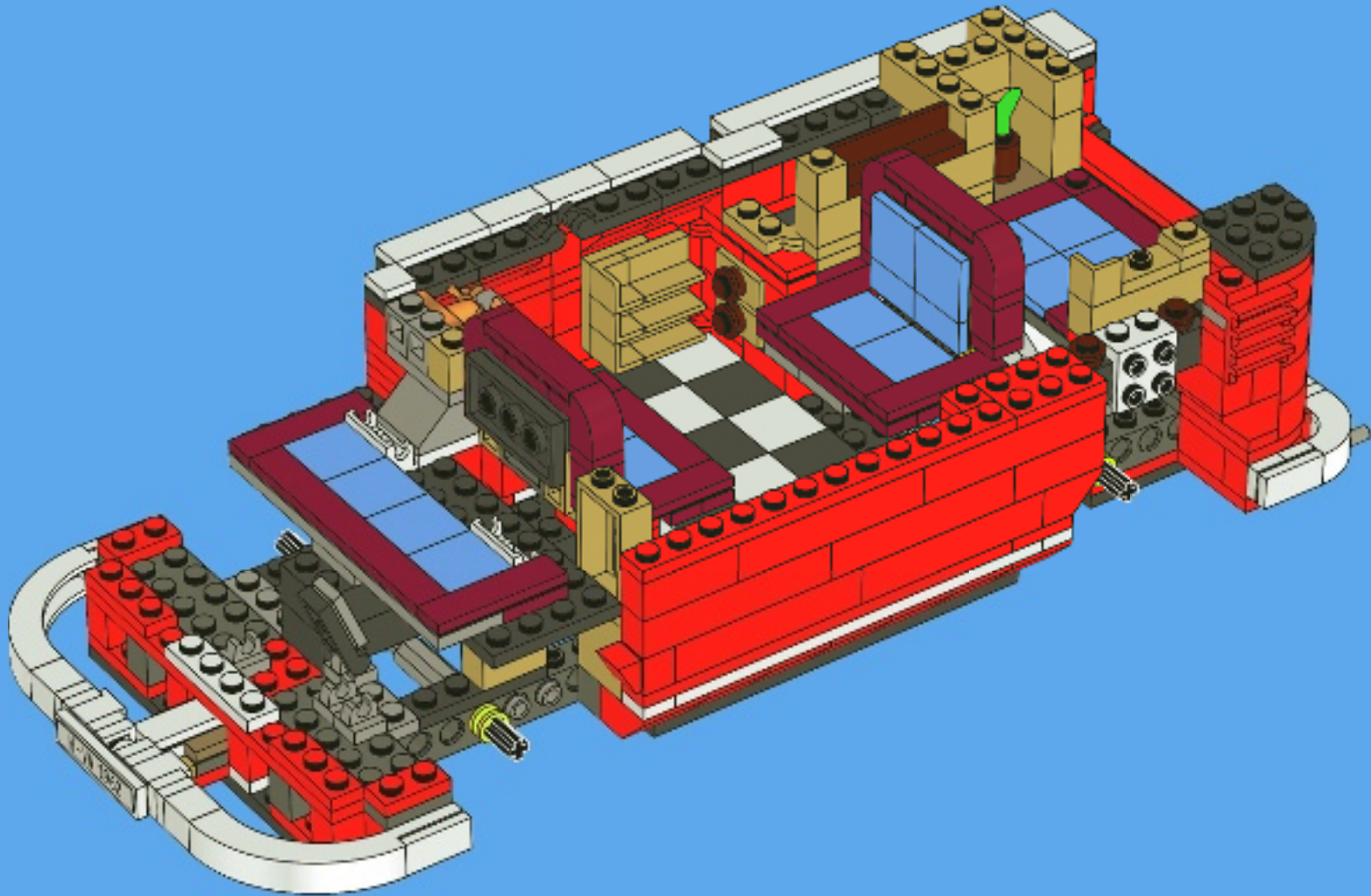



1x



1x



1x



2x



1x

62

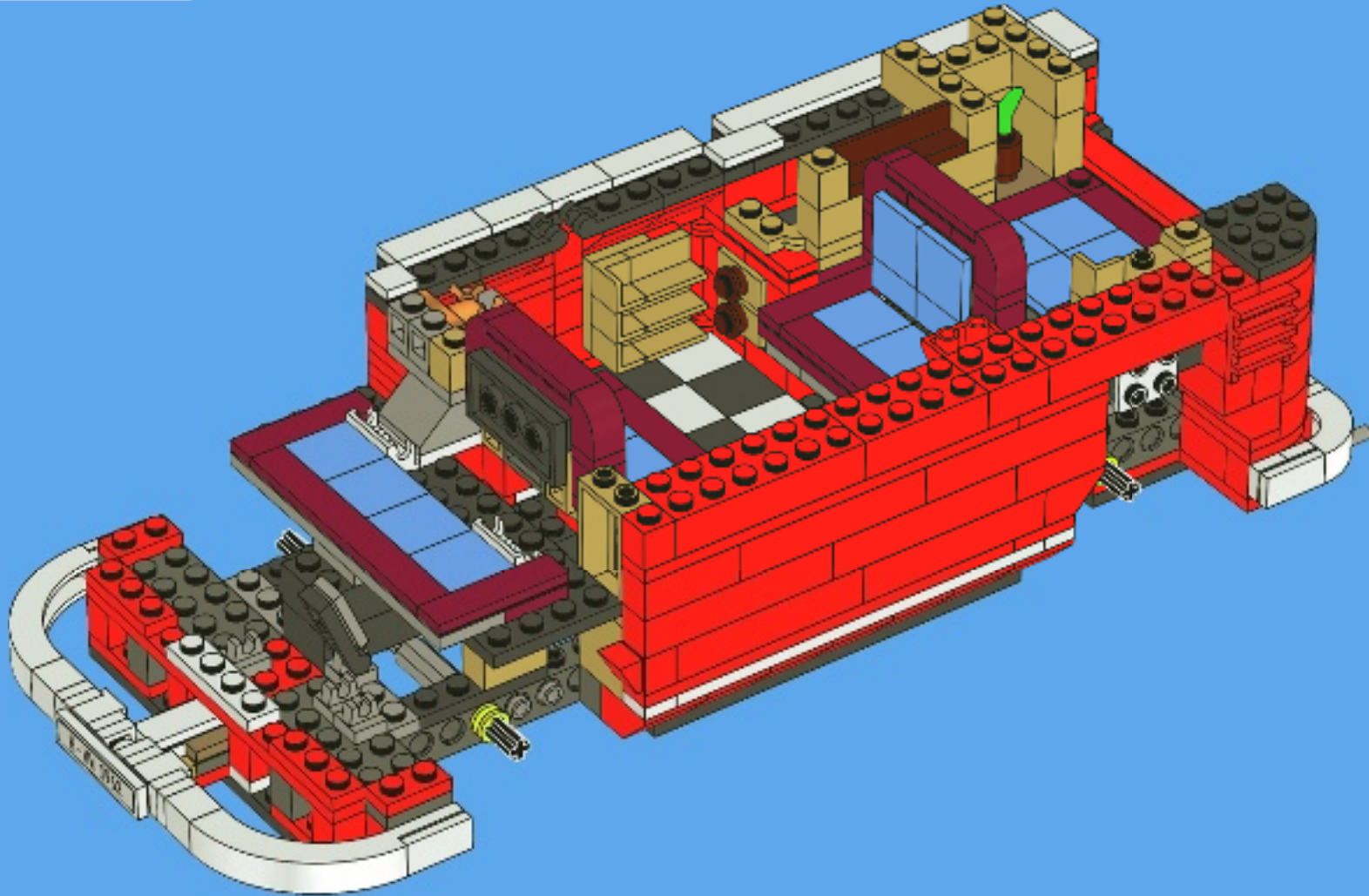



63

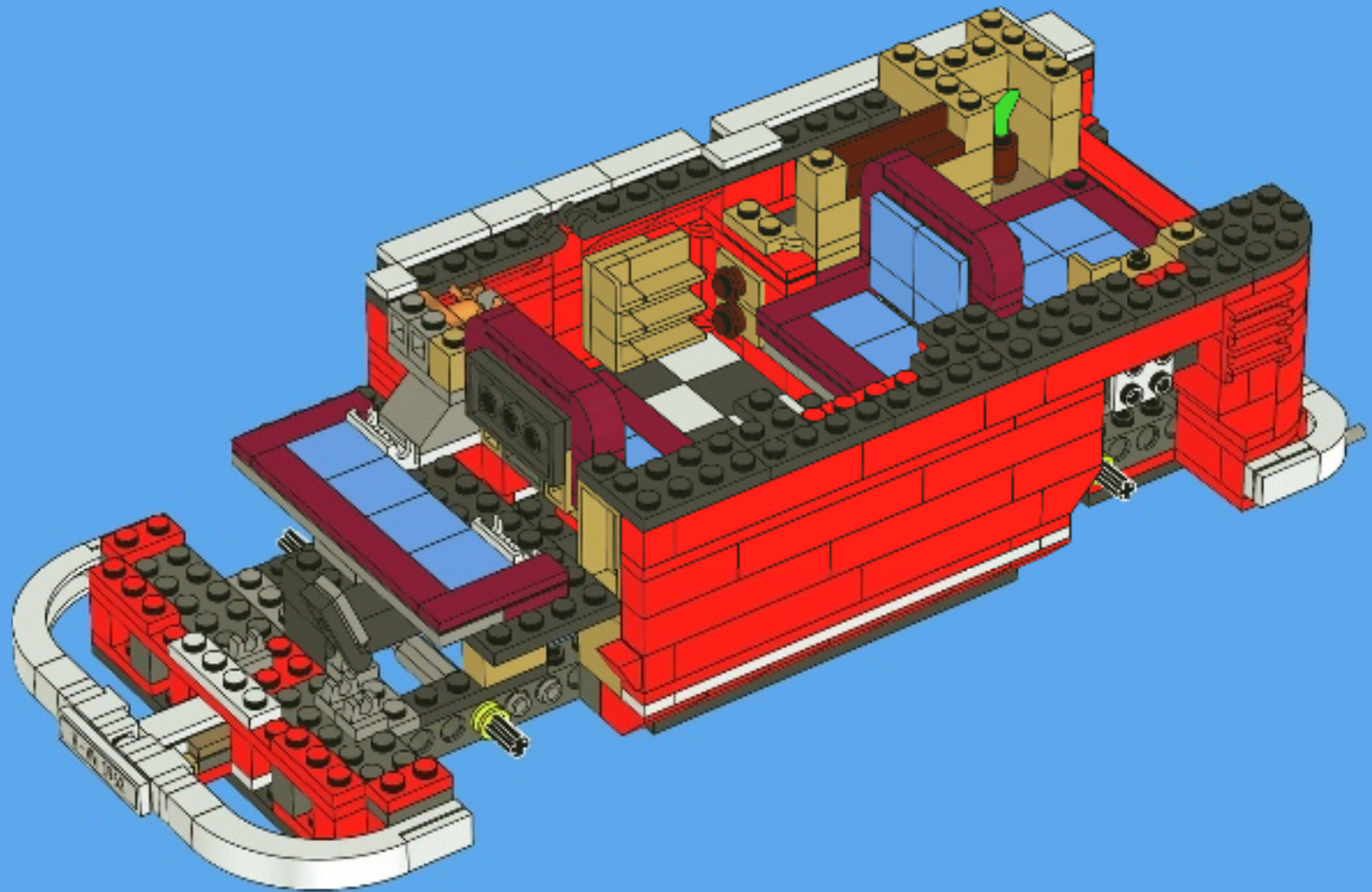

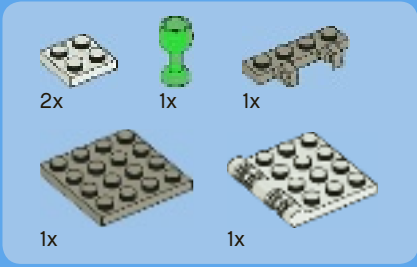

64

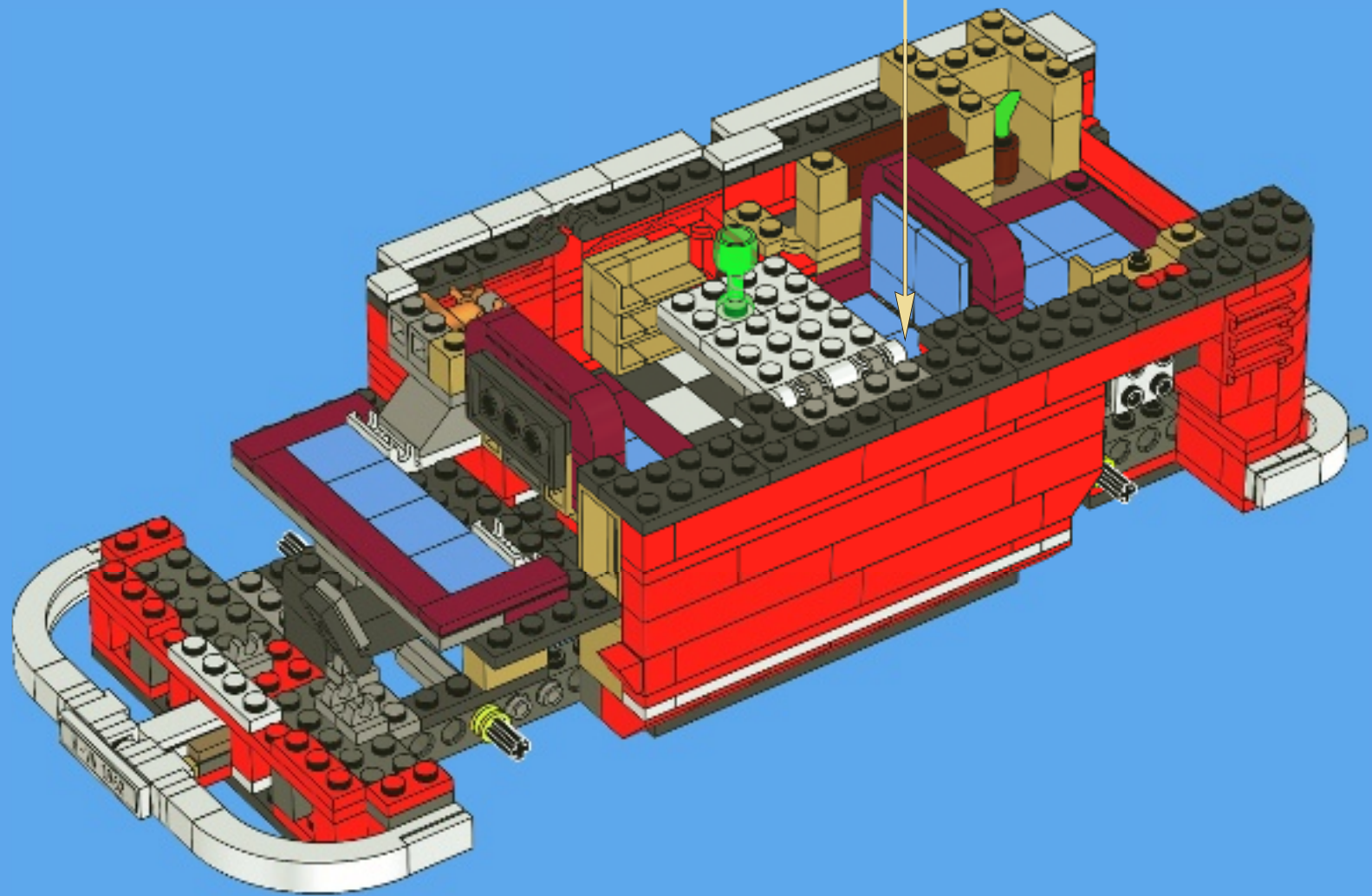

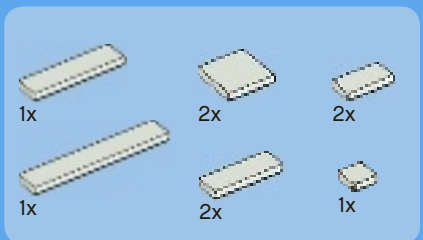

65

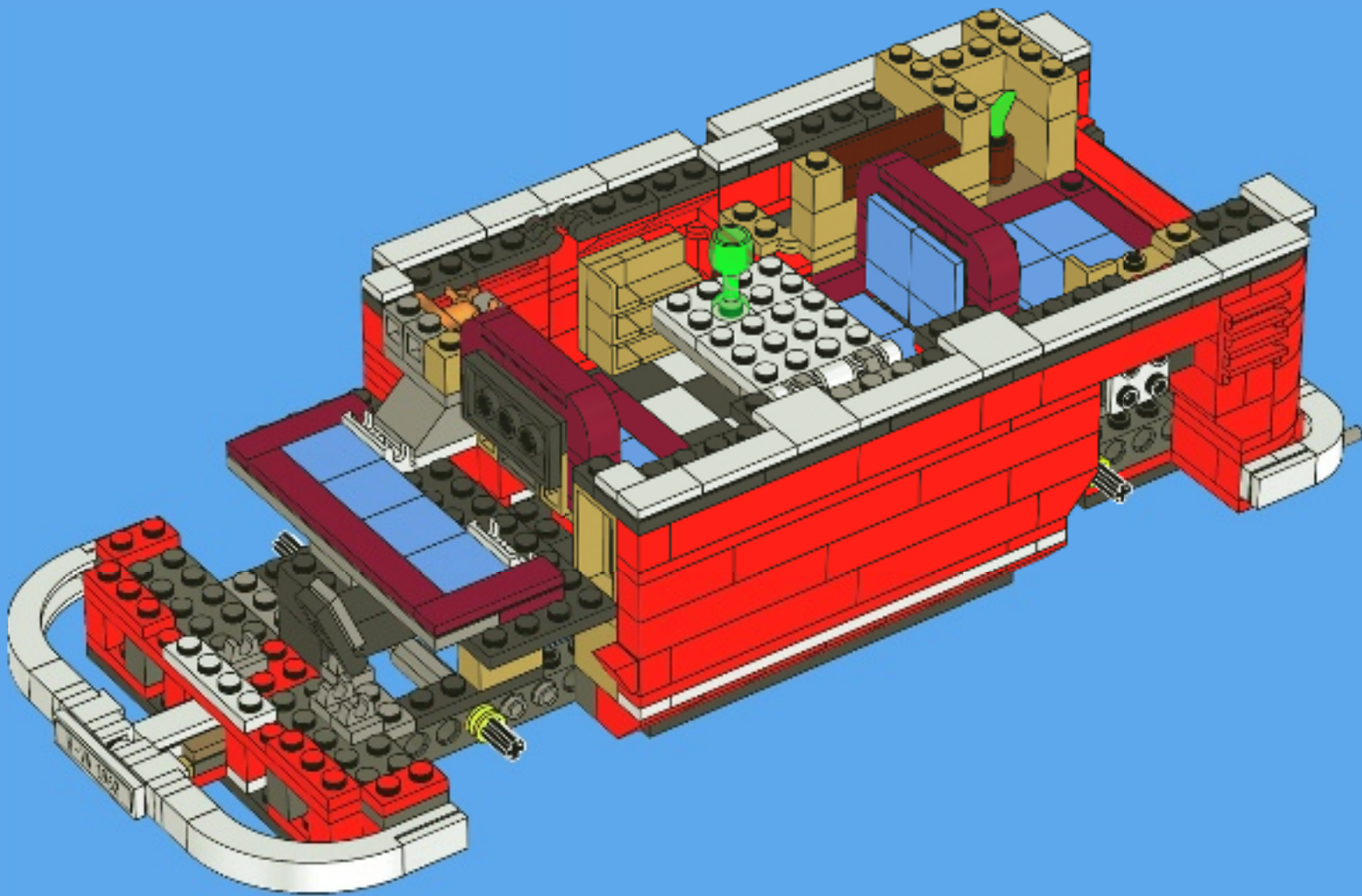



66

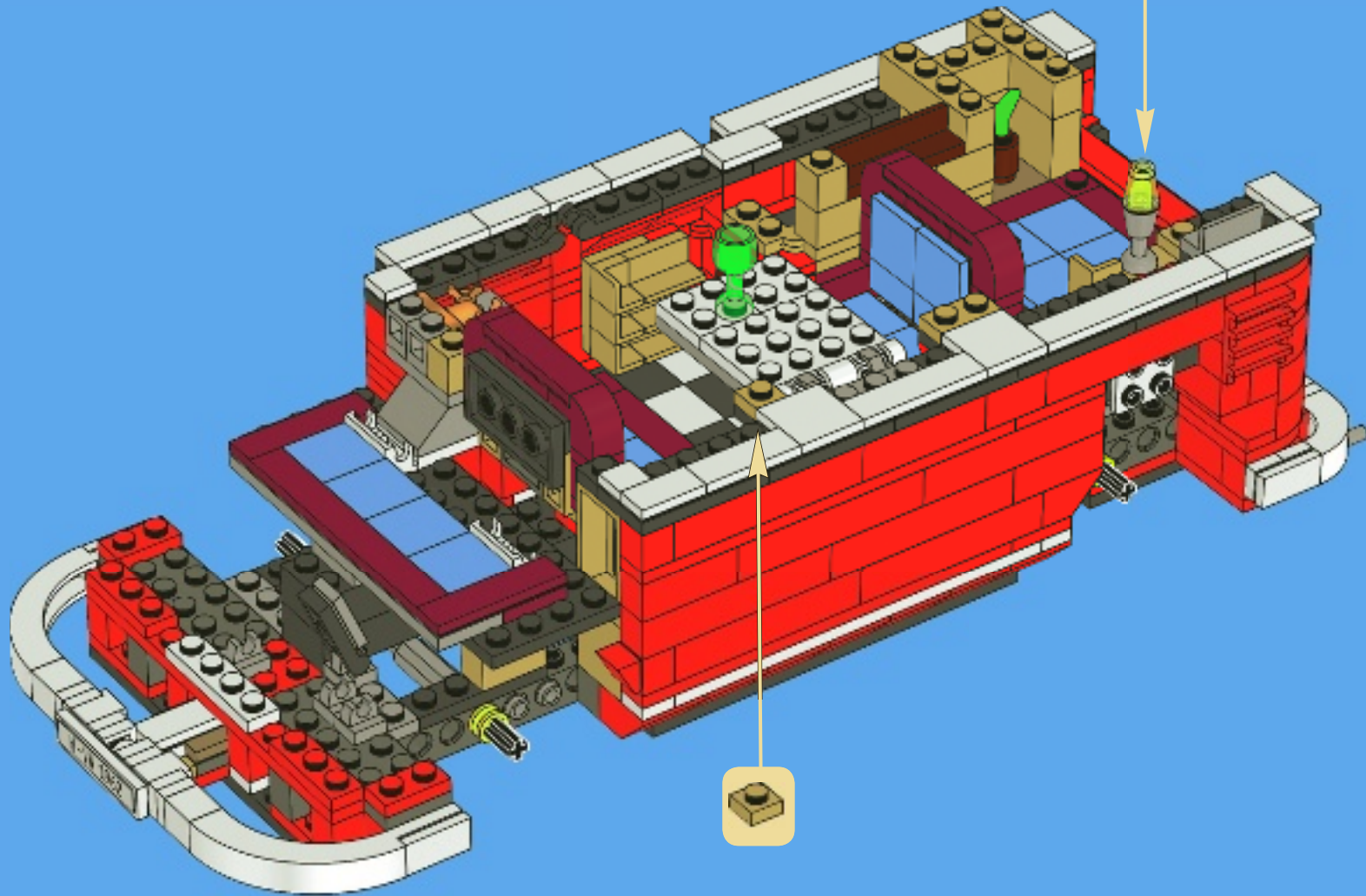

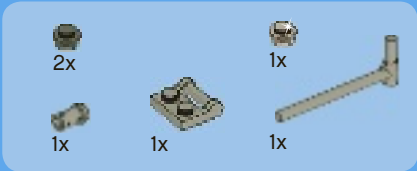

67

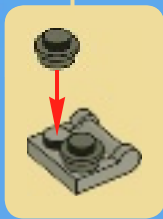
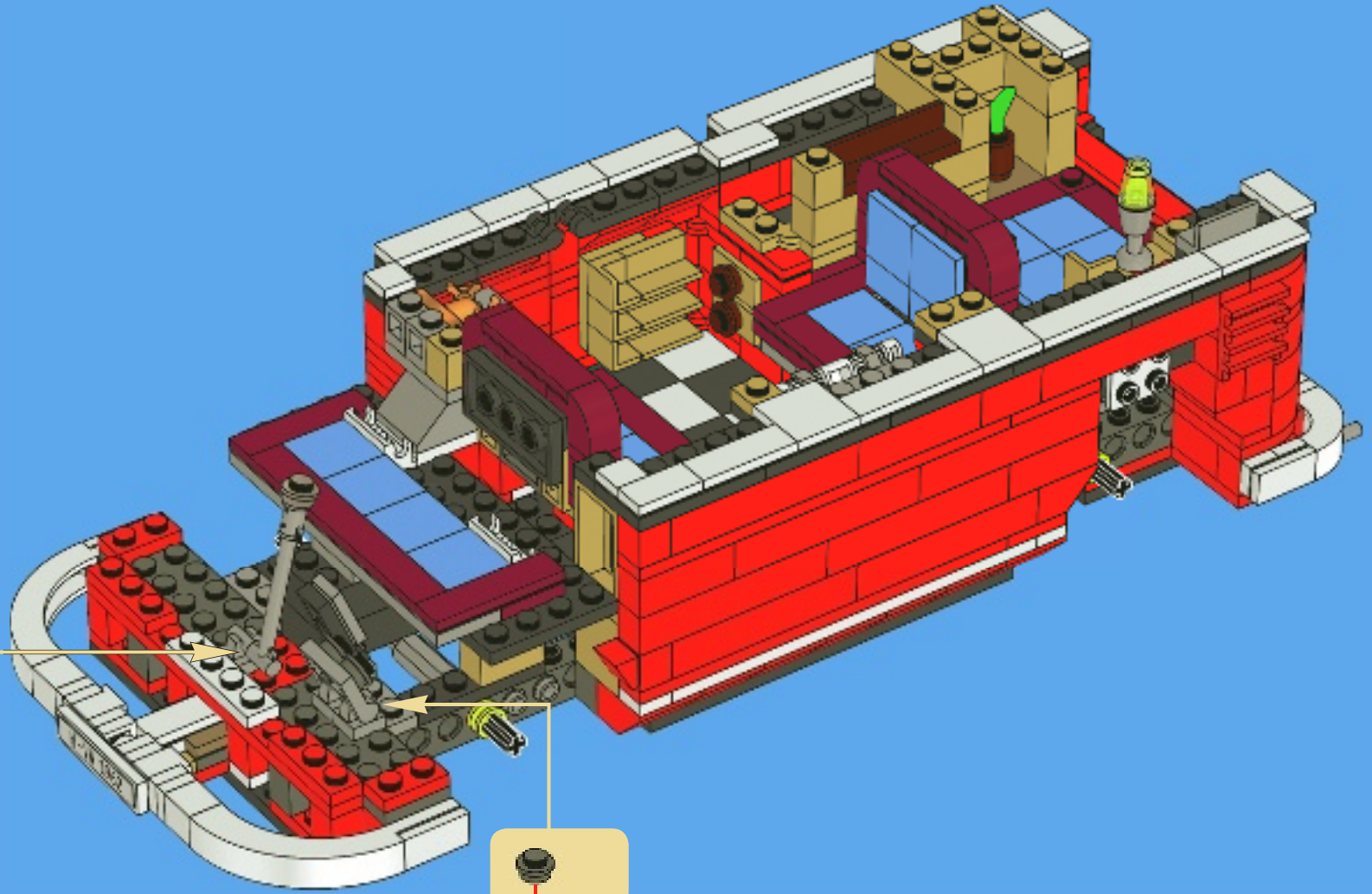
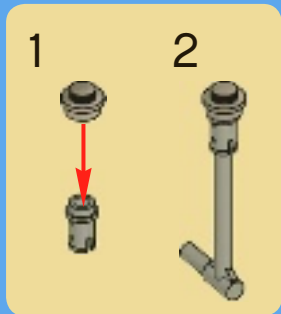



68

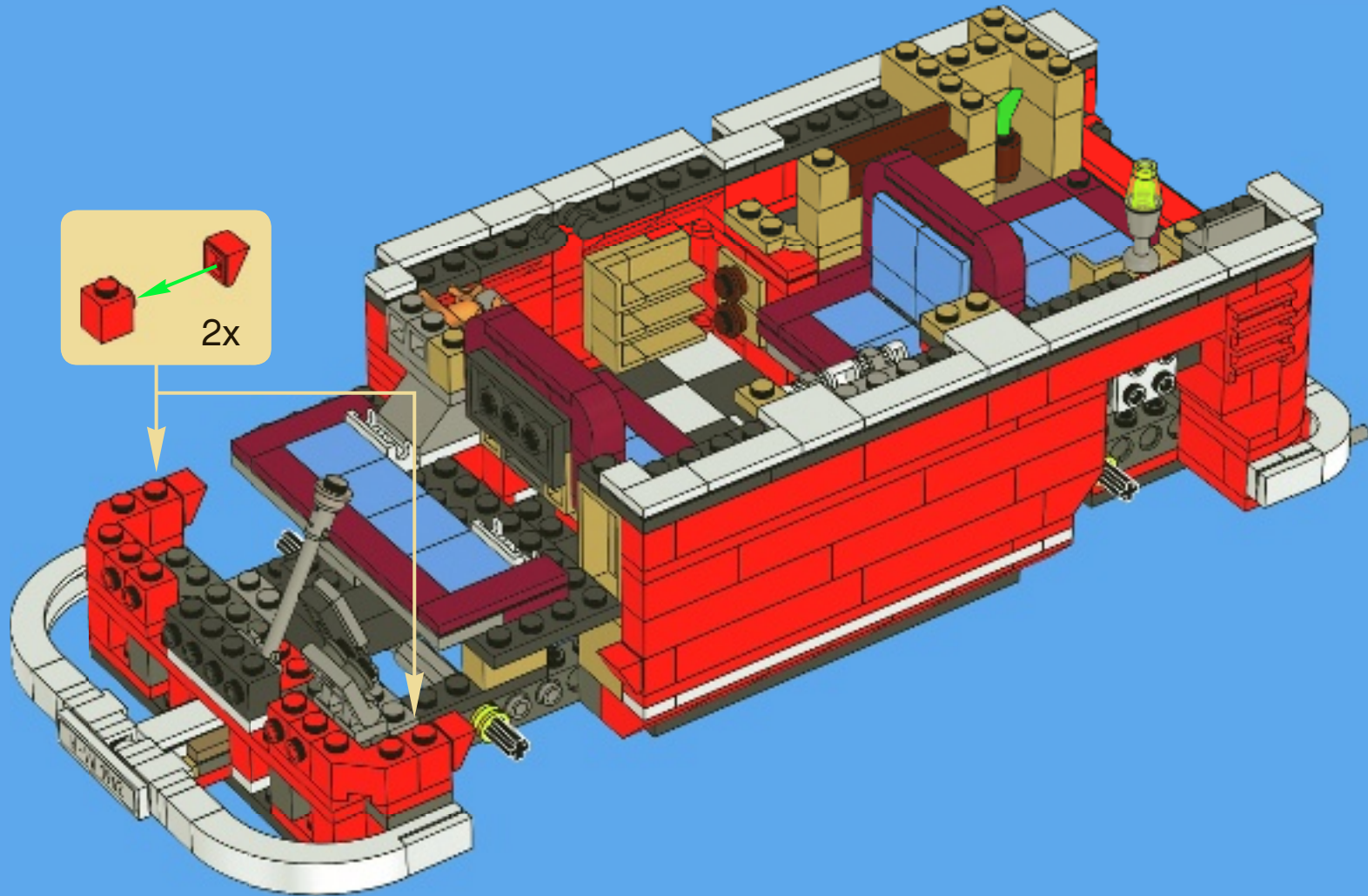



69

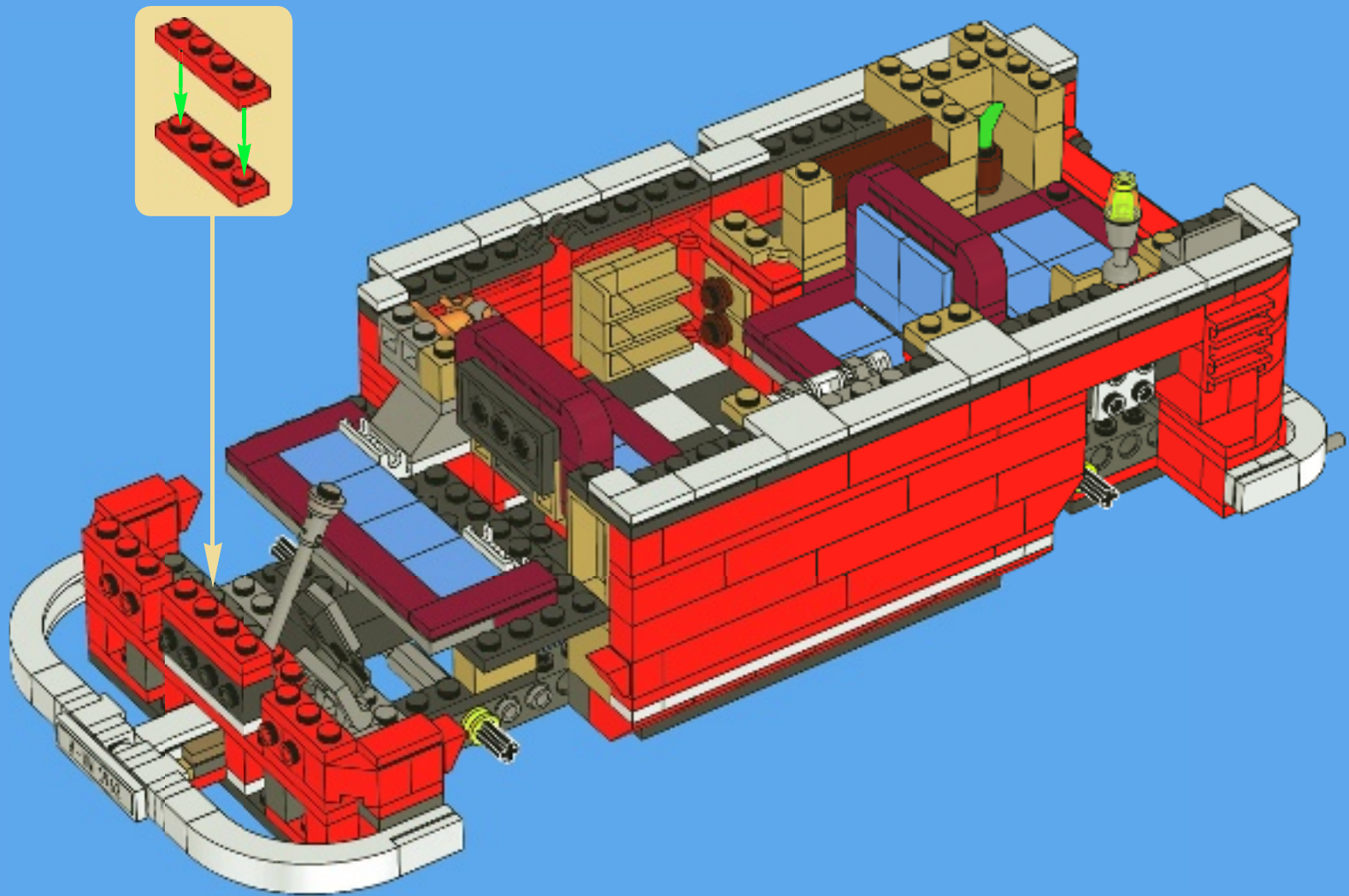



2x



1x

70

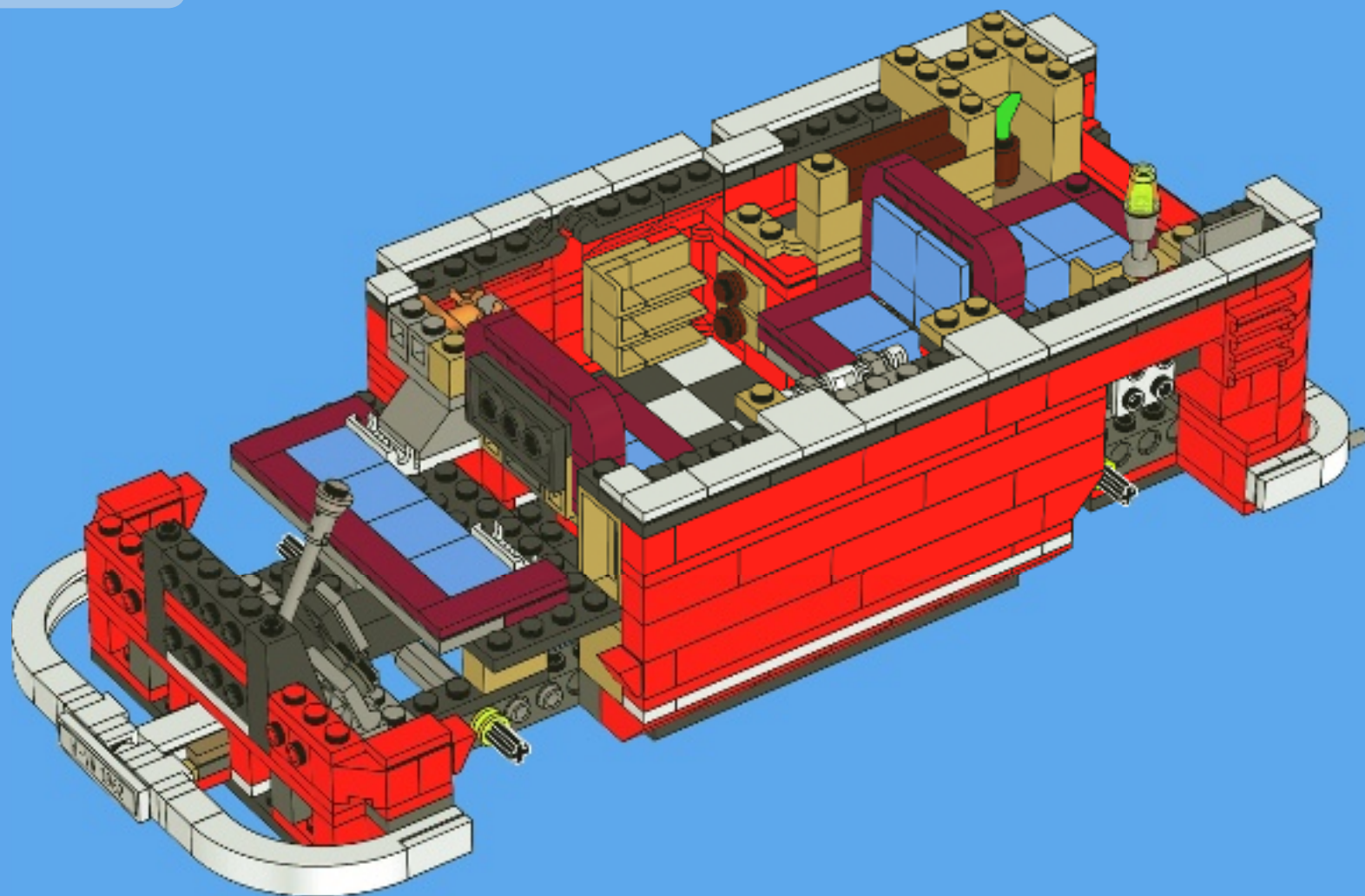

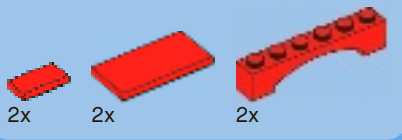

71

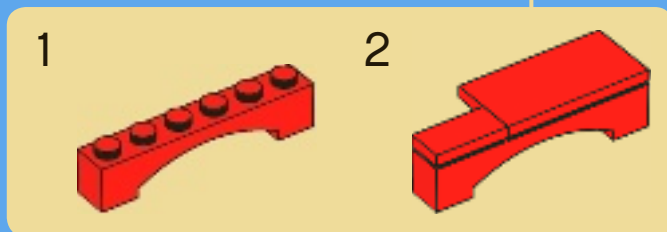
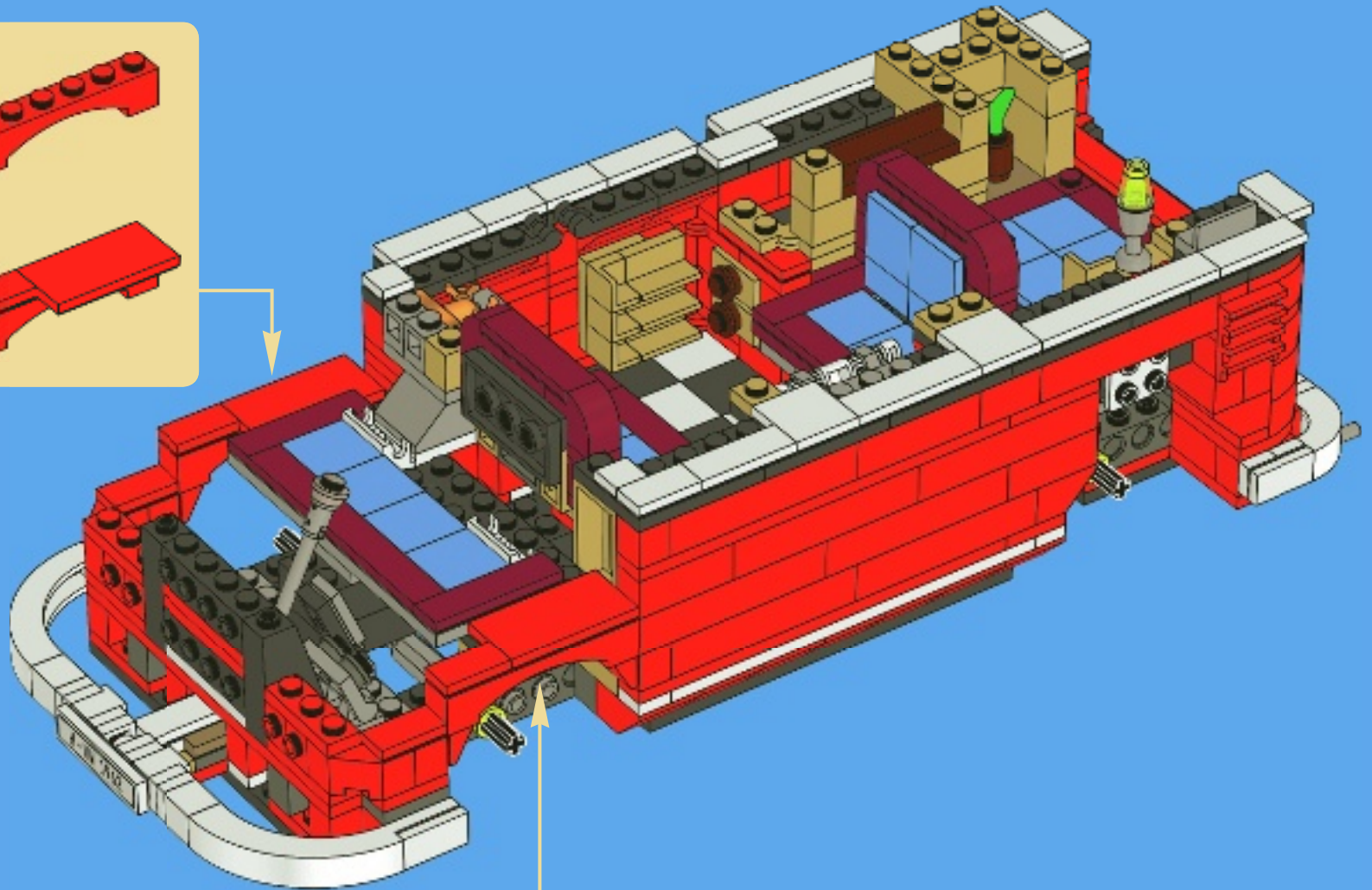
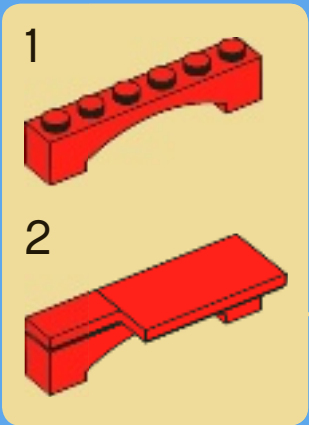



2x



2x



2x

72

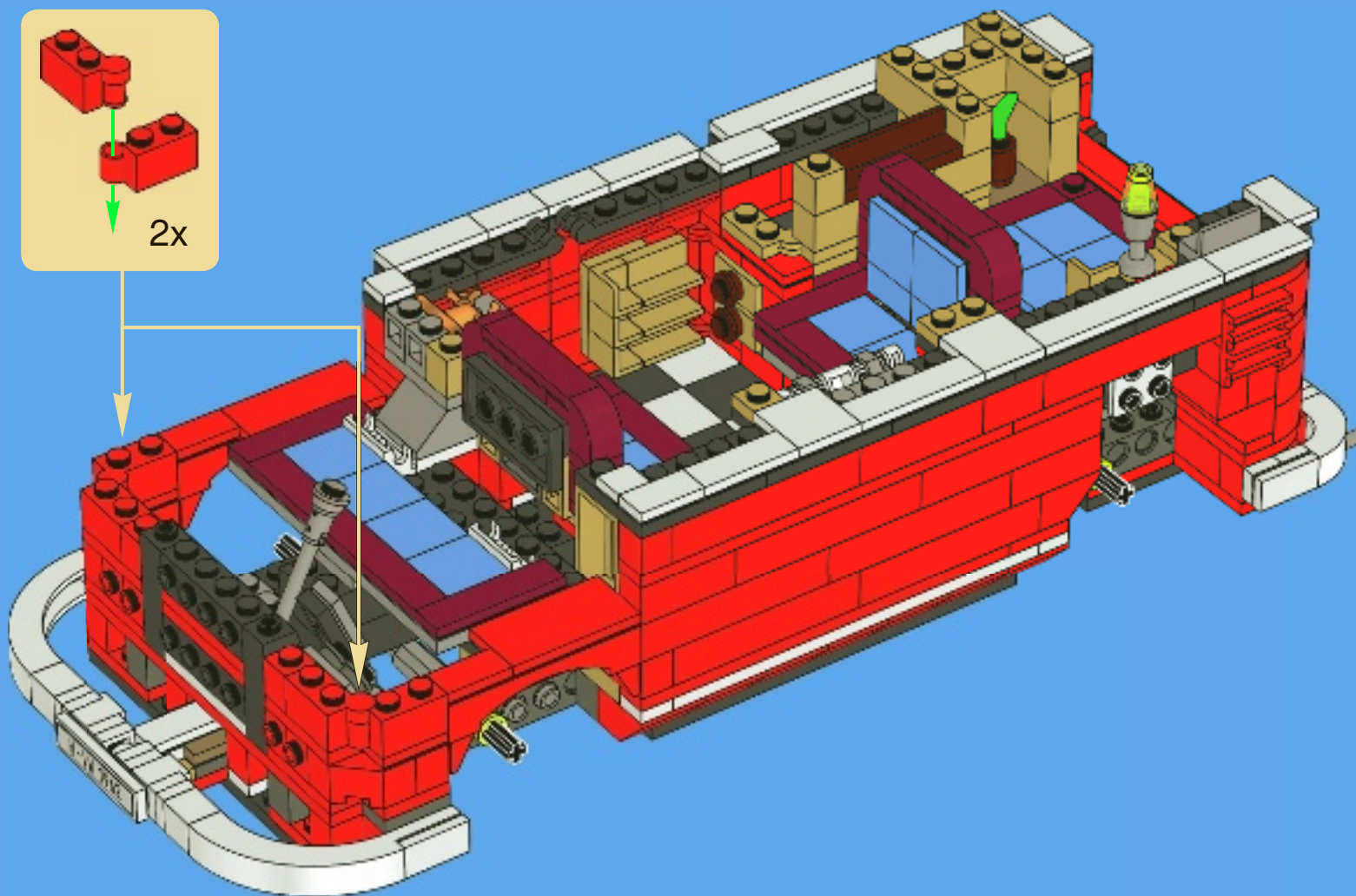
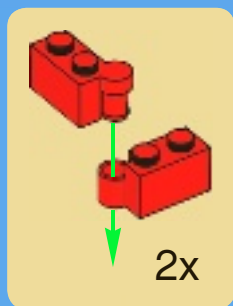

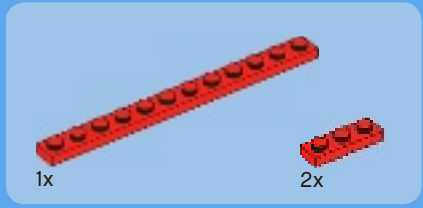

73

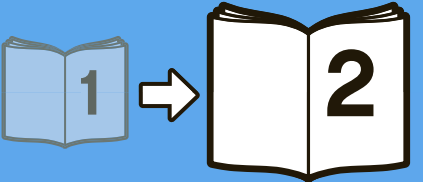
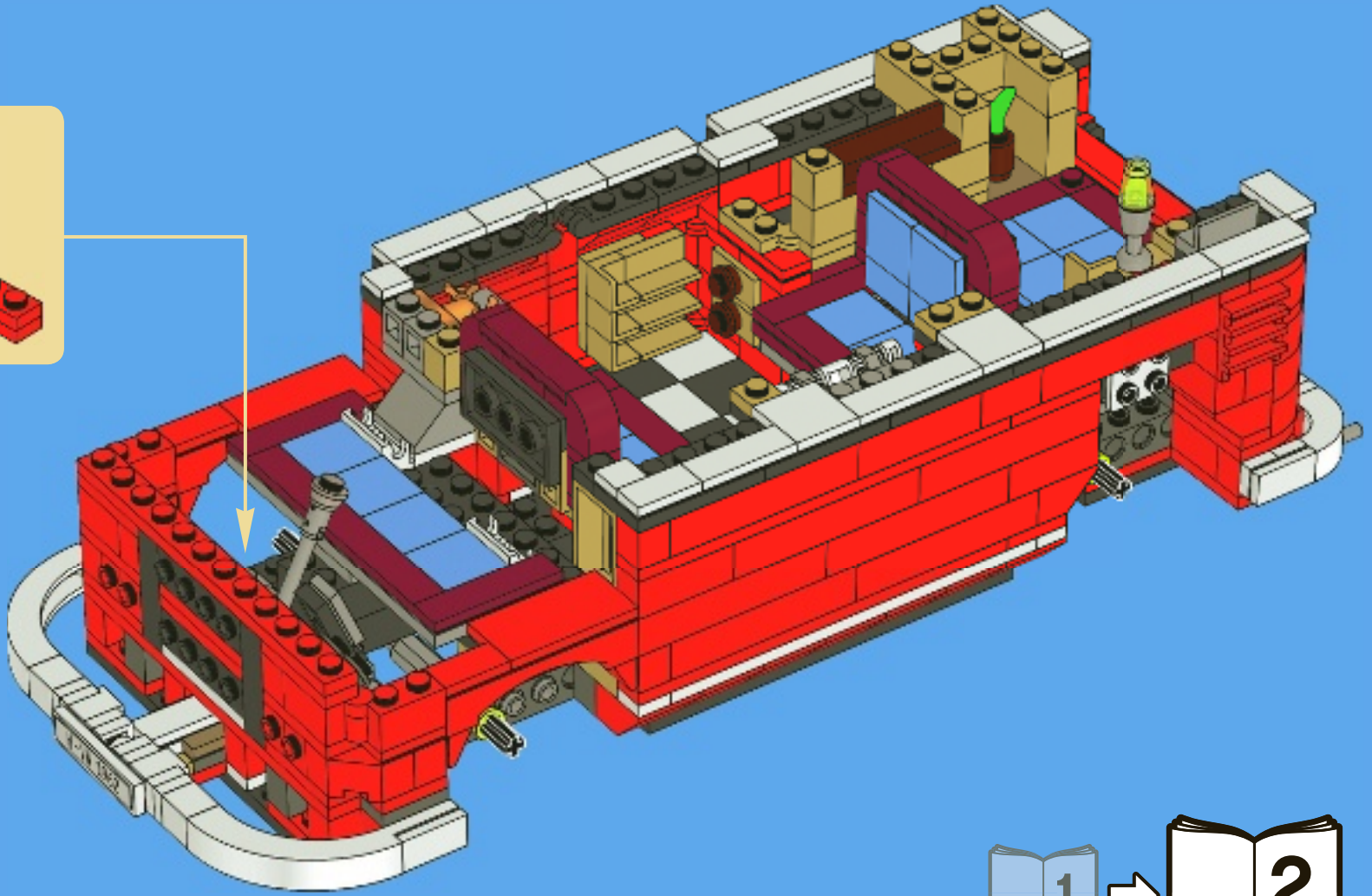
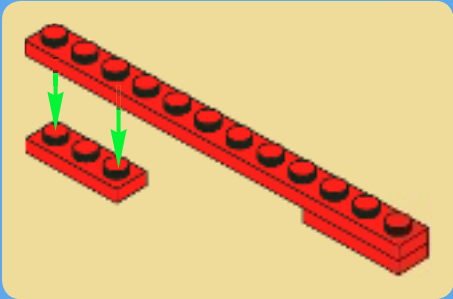

10197

10218

10211

