



GENERAL CATALOG
CUM PRICE LIST
2024-25

TM
MOXCARE
LABWARES

Moxcare

MOXCARE PRODUCTS INC.

We Moxcare Products Inc., a leading manufacturer and supplier of high-quality laboratory plasticware and benchtop equipment. Our diverse range of products, crafted both by us and our global partners, is available at competitive prices.

Our commitment is encapsulated in our motto: "WE CARE FOR YOUR RESEARCH NEEDS." Our goal is to provide the latest and highest quality products at fair prices. We continuously seek new opportunities for product improvement, guided by technical support from our international partners and valuable feedback from our customers. The quality of our entire product range is certified in accordance with ISO 13485:2003 standards.

Our Catalog features a wide array of laboratory consumables, including General Labware, Cell Culture Products, PCR Products, Cryogenics, Filtration Products, Nytro+ Nitrile Gloves, Lab Accessories and Equipment. Each product is meticulously designed and fabricated to meet international quality standards using high-precision injection molding and premium raw materials.

Moxcare's Products are trusted and appreciated by leading CRO's , Pharmaceutical Industries, Food Industries and Automobile industries worldwide. Additionally, our products are extensively used by Government Research Institutions in India.

We are confident that our products will serve as essential tools for your research, and we wish you great success in your endeavors.

Welcome to Our GENERAL CATALOG!

DEALER:



CONTENTS

Labware

Bottles	
Reagent Bottle Wide mouth	2
Reagent Bottle Narrow mouth	2
Amber Reagent Bottle Wide mouth	3
Amber Reagent Bottle Narrow mouth	3
Reagent Bottle - Glass	4
Amber Reagent Bottle - Glass	4
Solution Bottles	4
Heavy Duty Aspirator	5
Carboys	5
Carboys With Tap	5
Wash Bottles	6

Beakers	6
Measuring Cylinder	7

Desiccators	7
-------------	---

Bottle Top Dispenser	8
----------------------	---

Centrifuge Range

Centrifuge tubes	10
Centrifuge tubes Self Standing	11
Micro Centrifuge Tubes	12
Micro Centrifuge Tubes Amber	13
Pestle	13
Micro Centrifuge Tubes Screw Cap	13

Racks & Boxes

Centrifuge Tube 50ml Rack	11
Rack For 15ml/50ml Centrifuge Tube	14
Multi Use Rack	14
Box For Micro Centrifuge Tubes	15
Reversible Rack	15
Universal Rack	16
Multi-rack	16
Mini Coolers	
Bench top Ice Box	17
-20°C Mini Cooler	17

Cryoware

Cryoware & Storage Vials	
Cryo Workstation	23
Cardboard Cryo Box	23
Cryovials	24
Storage Vials	25
Serum & Sample Cryogenic Vials	25
Cryobox PC	26
Cryobox PP	26
Cover page	27
Stainless Steel Freezer Racks	28

Liquid Handling

Pipette Tips Box	30
Pipette Tips	31
Low Retention Pipette Tips	32
Low Retention Filter Tips	33
I/W Pipette Tips	34
Pipette Stand	34

Automation Pipette Tips	35
Moxpette Single Channel Pipette	36
Moxpette- Multi Channel Pipette	37

Serological Pipettes	38
Pasteur Pipette	39
Reagent Reservoir	39
Moxpette - Levo Pipette Filler	40
Moxpette - Levo M Pipette Filler	40

Petri Dishes

Petri Dish	42
Petri Dish 2/3 Compartment	43
Petri Dish Square	43

Multiwell Plates

Serological Plates	44
Black & White Serological Plates	44
ELISA Plates	45
Deep Multiwell Plates	45

Cell Culture Products

Cell Culture Flasks	46
Cell Culture Plates	47
Cell Culture Dishes	48
Cell Culture Tubes	48
Culture Tube - Glass	50
Culture Tube Amber - Glass	50
Test Tubes	50
Inoculation Loops	49
Inoculation Needle	49
L Spreader	49
T Spreader	49
Cell Lifter	49
Cell Scraper	49
Cell Strainer	49

PCR Products

PCR Tubes	52
PCR Tube Strips	52
PCR Tube Strips Attached Cap	52
PCR Plates	53

Sealing Films	
Air Seal Sealing Films	54
Thermal Seal	54
Aluminum Plate Seal	54
Pierceable Sealing Films	54

PCR Workbench	55
PCR Rack with cover	55
PCR Plate Centrifuge	56

Gloves

Latex Gloves	
Bioskin Latex Examination Gloves	57

Nitrile Gloves

Nytro+ Purple Blue Nitrile Gloves	58
Nytro+7 Purple Nitrile Gloves	59
Nytro+9 Nitrile Gloves	60
Nytro+15 Nitrile Gloves	61

Gloves Dispenser	62
------------------	----

Heat Resistant Gloves

Rhino Heat Resistant Gloves	62
Rhino Heat Resistant Grip	62

Cryo Gloves & Cryo Apron

EMROS Cryo Gloves-Wrist	63
EMROS Cryo Gloves- Mid Arm	63
EMROS Cryo Gloves- Elbow	63
EMROS Cryo Apron	63

Filtration Products

Syringe Filter	64
-----------------------	----

Nexflo Syringe Filters(Non Sterile)	65
Nexflo Syringe Filters(Sterile)	66
Nexflo Syringe filters 4mm	67
Nexflo 50mm Gas Filter	67

Membrane filters

Nexflo Membrane Filters	68
Nexflo Grid Membrane Filters	69
Nexflo Blotting Membrane	69

Filter Paper

Nexflo Filter Paper Qualitative	70
Nexflo Filter Paper Quantitative	71

Vacuum Filtration Apparatus	72
Vacuum Pump	72
Manifolds Vacuum Filtration Apparatus	73
Vacuum Filtration Apparatus- Glass	73
Spin Columns	
Nexflo Spin Columns	74
Nexflo Ultrafiltration Tube	74

Autosampler Vials

9mm Screw Vials	75
11mm Snap Cap Vials	75
11mm Crimp neck Vials	75
HeadSpace vials	75

Lab Accessories

Autoclave Bags	29
-----------------------	----

Sample Bags

Zip Lock Sample Bags	76
----------------------	----

Parafilm

Safety Goggles	76
Sharp Container	77
Lab Utility Tray	77
Beta Radiation Shield	77

Pipette Stand Vertical	78
Pipette Stand Horizontal	78
Retort Stand	78
Burette Clamp	79
Funnel	79
Funnel Holder	79
Separator Funnel	79

Equipment

Centrifuge

Minimax5400 - Mini Centrifuge	18
Minimax10000 - Mini Centrifuge	19
Mini Centrifuge	20
Clinical Centrifuge	21
Mini15000+ High Speed Mini Centrifuge	22
PCR Plate Centrifuge	56

Stirrers

Overhead Stirrer	82
Stirrermag 280 Magnetic Stirrer	92
Stirrermag 350 Magnetic Stirrer	92
Stirrermag Mini	92

Dry Bath

Mini DB- Mini Dry Bath+5-100°C	83
Mini DB- Mini Dry Bath-10-100°C	83
Maxi Dry Bath	84
Maxi Dual Temperature Dry Bath	85
Air Bath	90

Water Bath	90
Water Bath Shaker	91

Vortex Mixer

Vortex Mixer - Mix30Pro	94
Multi Tube Vortex Mixer	95
MicroMix Vortex Mixer	96

Shakers

Virtue Pro Orbital Shaker	80
Virtue Pro Rocking Shaker	80
Virtue Pro 3D Shaker	80
Virtue Pro Orbital Shaker	81
Gel Rocker	96
Tube Rotator	97
Rotating Mixer	98
3D Gyrotory Mixer	99
3D Rotating Shaker Variable	99
Digital Tube Roller	99

Virtue Incubator Shaker	86
Virtue Incubator Shaker Cooling	87
Mini Incubator Shaker	88

Homogenizer

Mini Homogenizer	89
Homogenizer	89

Transilluminators

Hand held UV Transilluminator	100
Blue Light Transilluminator	100

Reagent Bottle (Wide Mouth)

Wide Mouth | Autoclavable | Leak Proof & break-resistant
 Made from High Quality Virgin Polypropylene | Ideal for long-term storage of liquids
 | Resistant to Most Acids & commonly used solvents

Cat. No.	Capacity	Packing	Price/Pack	Price/20 Packs
MCRBW030	30ml	72	1539	30011
MCRBW060	60ml	72	1836	35802
MCRBW125	125ml	72	2670	52065
MCRBW250	250ml	72	4290	83655
MCRBW500	500ml	48	3669	71546
MCRBW1000	1000ml	24	4230	82485

Reagent Bottle Sterile (Wide Mouth)

MCRBW030S	30ml, Sterile	72	1914	37323
MCRBW060S	60ml, Sterile	72	2226	43407
MCRBW125S	125ml, Sterile	72	3102	60489
MCRBW250S	250ml, Sterile	72	4968	96876
MCRBW500S	500ml, Sterile	48	4266	83187
MCRBW1000S	1000ml, Sterile	24	4725	92138

HSN CODE : 3923 3090



Reagent Bottle (Narrow Mouth)

Narrow Mouth | Autoclavable | Leak Proof & break-resistant
 Made from High Quality Virgin Polypropylene | Ideal for long-term storage of liquids
 | Resistant to Most Acids & commonly used solvents

Cat. No.	Capacity	Packing	Price/Pack	Price/20 Packs
MCRBN030	30ml	72	1335	26033
MCRBN060	60ml	72	1587	30947
MCRBN125	125ml	72	2229	43466
MCRBN250	250ml	72	3681	71780
MCRBN500	500ml	48	3195	62303

Reagent Bottle Sterile (Narrow Mouth)

MCRBN030S	30ml, Sterile	72	1701	33170
MCRBN060S	60ml, Sterile	72	1962	38259
MCRBN125S	125ml, Sterile	72	2637	51422
MCRBN250S	250ml, Sterile	72	4320	84240
MCRBN500S	500ml, Sterile	48	3765	73418

HSN CODE : 3923 3090





Amber Reagent Bottle (Wide Mouth)

Wide Mouth | Autoclavable | Leak Proof & break-resistant
 Made from High Quality HDPE Material | Ideal for long-term storage of liquids |
 Resistant to Most Acids & commonly used solvents

Cat. No.	Capacity	Packing	Price/Pack	Price/20 Packs
MCARBW030	30ml	72	1980	38610
MCARBW060	60ml	72	2475	48263
MCARBW125	125ml	72	3492	68094
MCARBW250	250ml	72	5331	103955
MCARBW500	500ml	48	4830	94185

Amber Reagent Bottle Sterile (Wide Mouth)

MCARBW030S	30ml, Sterile	72	2376	46332
MCARBW060S	60ml, Sterile	72	2895	56453
MCARBW125S	125ml, Sterile	72	3966	77337
MCARBW250S	250ml, Sterile	72	6057	118112
MCARBW500S	500ml, Sterile	48	5496	107172

HSN CODE : 3923 3090



Amber Reagent Bottle (Narrow Mouth)

Narrow Mouth | Autoclavable | Leak Proof & break-resistant
 Made from High Quality HDPE Material | Ideal for long-term storage of liquids |
 Resistant to Most Acids & commonly used solvents

Cat. No.	Capacity	Packing	Price/Pack	Price/20 Packs
MCARBN030	30ml	72	1695	33053
MCARBN060	60ml	72	2190	42705
MCARBN125	125ml	72	2970	57915
MCARBN250	250ml	72	4701	91670
MCARBN500	500ml	48	4230	82485

Amber Reagent Bottle Sterile (Narrow Mouth)

MCARBN030S	30ml, Sterile	72	2088	40716
MCARBN060S	60ml, Sterile	72	2607	50837
MCARBN125S	125ml, Sterile	72	3417	66632
MCARBN250S	250ml, Sterile	72	5391	105125
MCARBN500S	500ml, Sterile	48	4860	94770

HSN CODE : 3923 3090



Reagent Bottles (Glass)

Autoclavable | Chemical Resistant | Amber Colour Available | Wide Mouth For Efficient Handling
 Unique Design Ensures High Stability | Made from High Quality Borosilicate Glass

Cat. No.	Description	Packing	Price/Pack
MCRB0100	Reagent Bottle Glass 100ml, Heavy Duty	10	3870
MCRB0250	Reagent Bottle Glass 250ml, Heavy Duty	10	4080
MCRB0500	Reagent Bottle Glass 500ml, Heavy Duty	10	4350
MCRB1000	Reagent Bottle Glass 1000ml, Heavy Duty	6	4488
MCRB2000	Reagent Bottle Glass 2000ml, Heavy Duty	2	2850
MCRB5000	Reagent Bottle Glass 5000ml, Heavy Duty	1	6990
MCARB0100	Amber Reagent Bottle Glass 100ml	10	6000
MCARB0250	Amber Reagent Bottle Glass 250ml	10	6420
MCARB0500	Amber Reagent Bottle Glass 500ml	10	8307
MCARB1000	Amber Reagent Bottle Glass 1000ml	6	7725
MCARB2000	Amber Reagent Bottle Glass 2000ml	2	4950
MCARB5000	Amber Reagent Bottle Glass 5000ml	1	10860

HSN CODE : 7017 9090



Solution Bottles Sterile

Made from High quality PS | Ideal for safe solution storage/Transportation | Chemical resistant | Available Gamma Sterile

Cat. No.	Capacity	Packing	Price / Pack
MCSB10500	500 ml, Sterile	1/Pkg, 4/Pack	2400
MCSB12000	2000 ml, Sterile	1/Pkg, 2/Pack	2400

HSN CODE : 3923 3090



Heavy Duty Aspirators

Heavy Duty & Stable | Autoclavable | Leak Proof Design | Made from High Quality Virgin Polypropylene | Ideal for long-term storage of liquids
Resistant to most acids & commonly used solvents

Cat. No.	Capacity	Packing	Price/Pack	Price/6 Packs
MCHDA05	5 Lts.	1	1410	8249
MCHDA10	10 Lts.	1	2352	13759
MCHDA20	20 Lts.	1	3327	19463

HSN CODE : 3923 3090



Carboys

Heavy Duty & Stable | Autoclavable | Leak Proof Design | Made from High Quality Virgin Polypropylene | Ideal for long-term storage of liquids
Resistant to most acids & commonly used solvents

Cat. No.	Capacity	Packing	Price/Pack	Price/6 Packs
MCCB010	10 Lts.	1	2370	13865
MCCB020	20 Lts.	1	3327	19463

HSN CODE : 3923 3090

Carboys With Tap

Cat. No.	Capacity	Packing	Price/Pack	Price/6 Packs
MCCB010T	10 Lts.	1	3327	19463
MCCB020T	20 Lts.	1	4590	26852

HSN CODE : 3923 3090

Beaker

Sturdy With Stable Base Design | Autoclavable | Leak Proof Design
 Made from High Quality Virgin Polypropylene | Bold & Accurate Moulded Graduations
 | Resistant to most acids & commonly used solvents

Cat. No.	Capacity	Packing	Price/Pack	Price/20 Packs
MCBK0100	100ml	12	246	4797
MCBK0250	250ml	12	444	8658
MCBK0500	500ml	6	348	6786
MCBK1000	1000ml	4	465	9068
MCBK2000	2000ml	4	834	16263
MCBK5000	5000ml	1	1017	19832
MCBKAP1	Assorted Kit	1	378	7371

HSN CODE : 3926 9099

* Assorted Kit Pack Contains following Beakers
 100ml X 2 Pcs., 250ml X 2 Pcs., 500ml X 2 Pcs., 1000ml X 1 Pcs.



Wash Bottles

Narrow Mouth | Stable Design | Autoclavable | Leak Proof Design
 High Quality Virgin Polypropylene | Bold & Accurate Moulded Graduations Resistant
 to most acids & commonly used solvents

Cat. No.	Capacity	Packing	Price/Pack	Price/10 Packs
MCWB0250	250ml	12	681	6640
MCWB0500	500ml	6	480	4680
MCWB1000	1000ml	6	780	7605

Wash Bottles Type II

Cat. No.	Capacity	Packing	Price/Pack	Price/10 Packs
MCWB02502	250ml, Type II	12	1026	10004
MCWB05002	500ml, Type II	6	600	5850

Wash Bottles (Labeled)

Narrow Mouth | Stable Design | Autoclavable | Leak Proof Design
 High Quality Virgin Polypropylene | Bold & Accurate Moulded Graduations Resistant
 to most acids & commonly used solvents

Cat. No.	Capacity	Packing	Price/Pack	Price/10 Packs
MCWBL50AT-12	500ml Assorted	12	2307	22493
MCWBL50AT-24	500ml Assorted	24	4605	44899
MCWBL10AT-12	1000ml Assorted	12	4056	39546
MCWBL10AT-24	1000ml Assorted	24	8109	79063

HSN CODE : 3923 3090



Wash Bottles Labeled

Wash Bottles Type II



Measuring Cylinder

Hexagonal Base gives Stable Design | Autoclavable | High Quality Virgin Polypropylene | Leak Proof Design | Bold & Accurate Moulded Graduations
Resistant to most acids & commonly used solvents

Cat. No.	Capacity	Packing	Price/Pack	Price/10 Packs
MCMC0050B	50ml	24	1917	18691
MCMC0100B	100ml	12	1218	11876
MCMC0250B	250ml	12	2004	19539
MCMC0500B	500ml	12	2550	24863
MCMC1000B	1000ml	6	2235	21791
MCMC2000B	2000ml	6	5226	50954
MCMCAP1B	Assorted Kit	1	1821	17755

HSN CODE : 3926 9099

* Assorted Kit Pack Contains following Cylinders
50ml X 2 Pcs., 100ml X 2 Pcs., 250ml X 2 Pcs., 500ml X 1 Pcs.



Desiccators Vacuum Clear

Cat. No.	Dia mm	Packing	Price/Pack	Price/6 Packs
MCDCV150C	150 mm, Clear	1	2619	15321
MCDCV200C	200 mm, Clear	1	4293	25114
MCDCV250C	250 mm, Clear	1	5385	31502
MCDCV300C	300 mm, Clear	1	8004	46823

HSN CODE : 3926 9099



Adapters allow to fit variety of Bottles

Specifications					
Volume Range	Graduation	A \leq \pm		CV \leq	
		%	ul	%	ul
0.5-5	0.1	0.5	25	0.1	5
1-10	0.2	0.5	50	0.1	10
2.5-25	0.5	0.5	125	0.1	25
5-50	1	0.5	250	0.1	50

A - Accuracy, CV = Coefficient of variation



Bottle Top Dispenser

Fast, convenient & accurate | Chemical Resistant | Variety of adapters to use it with different bottles

Cat. No.	Capacity (ml)	Packing	Price
MCBTD0005	Bottle Top Dispenser 0.5-5 ml	1	20100
MCBTD0010	Bottle Top Dispenser 1.0-10 ml	1	20100
MCBTD0025	Bottle Top Dispenser 2.5-25.0 ml	1	24000
MCBTD0050	Bottle Top Dispenser 5.0-50.0 ml	1	24000

HSN CODE : 8479 8999



Centrifuge Products



Centrifuge Tube

Leak proof Design | High Clarity | 100% Virgin Polypropylene Medical grade | RCF up to 12000g
 Printed White frosted Large writing area | BOLD Black Colour Graduations | Resistant to Wide Range of Chemicals
 Certified Dnase Rnase Free | Available Non Sterile, Gamma Sterile, ETO Sterile | Autoclavable to 121°C, freezable to -80°C.

Cat. No.	Description	Packing	Price/Pack
MCCTB02015	15ml Non Sterile	1000/Pack	9780
MCCTB02050	50ml Non Sterile	500/Pack	6495
MCCTB12015	15ml ETO Sterile	1000/Pack	10356
MCCTB12050	50ml ETO Sterile	500/Pack	7752
MCCTB12715	15ml Gamma Sterile	1000/Pack	10749
MCCTB12750	50ml Gamma Sterile	500/Pack	8142
MCCTB12015I	15ml ETO Sterile, Individual Wrap	1000/Pack	12702
MCCTB12050I	50ml ETO Sterile, Individual Wrap	500/Pack	10014
MCCTB12715I	15ml Gamma Sterile, Individual Wrap	1000/Pack	13161
MCCTB12750I	50ml Gamma Sterile, Individual Wrap	500/Pack	10425

HSN CODE : 3926 9099



Centrifuge Tube Self Standing

Leak proof | Max. RCF upto 6000g | Printed White frosted Large writing area | Bold graduations
 Certified Dnase Rnase Free | Available Gamma Sterile

Cat. No.	Capacity	Packing	Price/Pack
MCCT01050	50ml	500/Pack	7386
MCCT11050	50ml, ETO Sterile	500/Pack	8595
MCCT17050	50ml, Gamma Sterile	500/Pack	9138
MCCT11050I	50ml ETO Sterile, Individual Wrap	500/Pack	10878
MCCT11750I	50ml Gamma Sterile, Individual Wrap	500/Pack	11427

HSN CODE : 3926 9099



Centrifuge Tube 50ml Rack

Cat. No.	Capacity	Packing	Price/Pack
MCCTR050	10 Places, 50ml Tube	8	3630

HSN CODE : 3926 9099



Micro Centrifuge Tube

Made from High Quality PP Material | High Clarity | Consistent Wall thickness | Frosted writing area | Secure Cap & leak Proof Design
Easy One hand operation | Certified Dnase/Rnase Free | Available Gamma Sterile

Cat. No.	Capacity	Packing	Price/Pack
MCMT00005	0.5ml	1000 Pcs/Bag, 10,000 Pcs./ Pack	7560
MCMT00015	1.5ml	500 Pcs/Bag, 10,000 Pcs./ Pack	11550
MCMT00020	2ml	500 Pcs/Bag, 5,000 Pcs./ Pack	6405
MCMT0005L	5ml	200 Pcs./Bag, 1000/Pack	4620
MCMT00010	10ml	200 Pcs./Bag, 400/Pack	3780
MCMT10005	0.5ml, Gamma Sterile	1000 Pcs/Bag, 10,000 Pcs./ Pack	8472
MCMT10015	1.5ml, Gamma Sterile	500 Pcs/Bag, 10,000 Pcs./ Pack	12834
MCMT10020	2ml, Gamma Sterile	500 Pcs/Bag, 5,000 Pcs./ Pack	7800
MCMT1005L	5ml, Gamma Sterile	200 Pcs./Bag, 1000/Pack	6750
MCMT10010	10ml, Gamma Sterile	200 Pcs./Bag, 400/Pack	4764

Micro Centrifuge Tube (Premium)

Made from High Quality PP Material | Low Retention Surface | High Clarity | Consistent Wall thickness | Frosted writing area
Secure Cap & leak Proof Design | Easy One hand operation | Certified Dnase/Rnase Free | Gamma Irradiation Sterile

Cat. No.	Capacity	Packing	Price/Pack
MCMTTP1005	0.5ml, Gamma Sterile	1000Pcs./ Pack, 5000Pcs./Pack	12000
MCMTTP1015	1.5ml, Gamma Sterile	500Pcs./Pack, 5000pcs./Pack	11400
MCMTTP1019	1.9ml, Gamma Sterile	500Pcs./Pack, 5000Pcs./Pack	12705

HSN CODE : 3926 9099



Amber Micro Centrifuge Tube

Made from High Quality PP Material | Amber Colour | Consistent Wall thickness | Frosted writing area
 Secure Cap & leak Proof Design | Easy One hand operation
 Certified Dnase/Rnase Free | Available Gamma Sterile

Cat. No.	Capacity	Packing	Price/Pack
MCMTA015	1.5ml	500 Pcs/Bag, 2000 Pcs./ Pack	3180
MCMTA115	1.5ml, Gamma Sterile	500 Pcs/Bag, 2000 Pcs./ Pack	4050

HSN CODE : 3926 9099



Pestle

Cat. No.	Description	Packing	Price/Pack
MCMTTP01	Pestle	10	693

HSN CODE : 3926 9099



Micro Centrifuge Tube (Screw Cap)

Made from High Quality PP Material | Leak Proof Design | Silicon Ring for complete seal | Withstand Autoclaving & Freezing
 Proved Excellent for handling & processing Small Volume Samples | Certified Dnase/Rnase Free | Available Gamma Sterile

Cat. No.	Capacity	Packing	Price/Pack
MCMTAC015	Centrifuge tube 1.5ml with Attached Screw Cap	500 Pcs/Bag, 5000 Pcs./ Pack	31500
MCMTAC115	Centrifuge tube 1.5ml with Attached Screw Cap, Sterile	500 Pcs/Bag, 5000 Pcs./ Pack	34125
MCMTSC015	Centrifuge tube 1.5ml, Screw Cap	500 Pcs/Bag, 5000 Pcs./ Pack	35700
MCMTSC115	Centrifuge tube 1.5ml, Screw Cap , Sterile	500 Pcs/Bag, 5000 Pcs./ Pack	38325

HSN CODE : 3926 9099



Rack For 15ml/50ml Centrifuge Tube

Suitable For Conical Centrifuge Tubes | Alphanumeric inscription | Easily assembling/disassembling | Withstands Autoclaving & Freezing

Cat. No.	Description	Packing	Price/Pack
MCRK01550	15/50ml, Type Small (Fits 18 X 15ml tubes , 10 X 50ml tubes)	8	3528
MCRK01552	15/50ml, Type Big (Fits 30 X 15ml tubes , 20 X 50ml tubes)	4	3048

HSN CODE : 3926 9099



Multi Use Rack

Cat. No.	Description	Packing	Price/Pack
MCMTR01	T1, For 15ml Tubes (Fits 44 X 15ml tubes)	4	2250
MCMTR02	T2, For 50ml Tubes (Fits 21 X 50ml tubes)	4	2250

HSN CODE : 3926 9099



Box For Micro Centrifuge Tubes

Made from High Quality PP | Ideal for micro tubes storage | Tight fit cover ensures sample won't fall
Withstands Autoclaving and Freezing

Cat. No.	Capacity	Packing	Price/Pack
MCBX00005	For 0.5ml Tubes (Fits 72 tubes)	8	1890
MCBX01520	For 1.5 / 2ml Tubes (Fits 72 tubes)	8	2124
MCBX00050	For 5ml Tubes (Fits 32 tubes)	6	1950

HSN CODE : 3923 1090



Reversible Rack

Ideal for storage and bench top work | Easy Identification of Samples with Alphanumeric Inscriptions
Withstands Autoclaving and Freezing | For 0.5ml on One Side, For 1.5/2ml on other side.

Cat. No.	Capacity	Packing	Price/Pack
MCRR00080	0.5ml, 1.5ml/2ml 80 Places	10	3000
MCRR00096	0.5ml, 1.5ml/2ml 96 Places	10	4800

HSN CODE : 3926 9099



Universal Rack

4 x 50 ml conical tubes, 2 x 15 ml conical tubes, 32 x 1.5/2.0 ml MCT, 32 x 0.5 ml MCT Withstands Autoclaving and Freezing.

Cat. No.	Capacity	Packing	Price/Pack	Price/10 Packs
MCUR00001	Universal Rack	10	3600	35100

HSN CODE : 3926 9099



Multi-rack

Cat. No.	Capacity	Packing	Price/Pack
MCMTR	50 Places (upto 18mm Tube)	8	6000

HSN CODE : 3926 9099



Benchtop Mini Coolers

Benchtop Mini Coolers maintains freezer temperature during frost-free cycles, power failures and accidental door openings. These Coolers Protect enzymes, cells, reagents and solutions by maintaining freezer temperatures.

Mini Cooler Ice Box Usage Instructions : Remove the Tube Tray and fill the bottom box with Crushed Ice.
 -20°C Mini Cooler Usage Instructions : Freeze Mini Cooler at -20°C to -25°C for 24hrs before use.

Cat. No.	Description	Packing	Price/Pack
MCIB001	Mini Cooler, Ice Box 12 X 0.2ml, 12 X 0.5ml/2ml, 30 X 1.5ml/2ml tubes	4	2235
MCIB002	-20°C Mini Cooler (Gel Based) 1.5ml/10ml	1	3600

HSN CODE : 3923 1090

Specifications	
Speed	5400 RPM
Maximum RCF	2000g
Running Mode	Continuous
Rotor Capacity	0.2/0.5/1.5/2.0ml x 6 & 0.2ml x 2 PCR 8 strips
Noise Range	≤50
Voltage	AC 220V, 50/60Hz
Dimensions	6.9" x 5.5"
Net Weight	1.85kg

- Fixed Speed 5400 RPM
- Low Noise ≤ 50dB
- Enclosed Design Reduces risk of liquid splashing into equipment
- Click-On Design allows rotor changing very Easy
- Equipped with 2 interchangeable rotors 1.5/2ml x 6 and PCR 8x2



Minimax 5400 - Mini Centrifuge

Cat No.	Description	Price
MINIMAX5400	Mini Centrifuge, Fixed Speed	12000

* Cat No. MINIMAX5400 Price Includes all Rotors

HSN CODE : 8421 1910



18



Specifications	Minimax 10000
Speed Range	3000-10000 RPM (1000rpm/grade)
Maximum RCF	5460xg
Running Mode	Timing/Continuous
Timer	1s ~ 99min
Rotors Capacity	8x0.5ml/1.5ml/2ml centrifuge tube or 2 x 0.2ml Strip of 8
Noise Range	<50dB
Voltage	AC 220V, 50/60Hz
Dimensions	195(L) x 170(W) x 135(H)
Net Weight	0.8kg



Minimax 10000 - Mini Centrifuge

Cat No.	Description	Price
MINIMAX10000	MiniMax 10000, Mini Centrifuge, Variable Speed	24000

* Cat No. MINIMAX10000 Price Includes all Rotors

HSN CODE : 8421 1910



Specifications	
Speed Range	3000RPM - 10000 RPM (Increment 1000RPM)
Maximum RCF	5300g
Running Mode	Timing/Continuous
Timer	1s - 999min
Rotor Capacity	8x1.5ml/2ml + 8x0.5ml + 2x0.2ml Strip of 8
Noise Range	≤55dB
Voltage	AC 220V, 50/60Hz
Dimensions	156 x 176 x 121mm
Net Weight	1.5kg

- Ideal For Quick Spin-downs
- New Clip-On Designed Rotor
- Noise Free Operation
- Bright LED Display
- Sturdy Compact Design with Maintenance Free Motor
- Large Rotor (helps achieving better Centrifugal force)



Mini Centrifuge		
Cat No.	Description	Price
MINI10KC+	Mini Centrifuge, Variable Speed	26700

* Cat No. Mini10KC Price Includes all Rotors

HSN CODE : 8421 1910

Specifications	
Speed Range	300-4500 RPM
Max. RCF	Rotor 1 = 2558xg, Rotor 2 = 2200xg
Speed Accuracy	± 20 RPM
Running Mode	Continuos/ Short Time run/ Timing
Timer	10s-99min
Motor	Brushless DC Motor
Rotor Capacity	12x15ml or 24x10ml
Safety Devices	Over Speed Detector, Door Interlock, Automatic Internal diagnosis
Noise Range	<65DB
Dimensions	450x340x230mm
Net Weight	10kg

- Easy Programming with 3 - Operations Mode
- Bright LCD Display
- Time & Speed Display Simultaneously
- RPM and RCF Both Can be displayed
- Noise Free Operation
- Sturdy & Compact Design
- Maintenance Free Brushless DC Motor
- Automatic Self diagnosis & Electric Lock for Better safety
- Stainless Steel Large Rotor for better Safety& Centrifugal force



Clinical Centrifuge

Cat No.	Description	Price
MCCLCG01	Clinical Centrifuge (Price Includes Any One Rotor)	60000
MCCLCGRT1	Rotor 12x15ml Tube	8100
MCCLCGRT2	Rotor 24x10ml Tube	8100
RBA12	23mm/43mm Rubber Adapter 12 Pcs./Pack	900

* Cat No. MCCLCG01 Price Includes any one rotor 12x15ml or 24x10ml.

HSN CODE : 8421 1910



12 x 15ml Rotor



24 x 10ml Rotor



23mm Rubber Adapter



43mm Rubber Adapter

Specifications	
Display	LCD Display
Speed Range	500 - 15000RPM
Maximum RCF	15100g
Increment	100RPM / 100 RCF
Speed accuracy [rpm]	±20
Rotor capacity	0.2ml/0.5ml/1.5ml/2ml x 12
Timer	30sec-99min
Mode	Timer / Continuous
Noise level [db]	≤56
Acceleration/Braking time [Sec]	30sec / 10sec
Safety devices	Over-Speed detection, Over-Temperature detection Door interlock & Auto Internal Diagnosis
Additional features	Speed RCF Switch, Short-Time Run Function, Sound-Alert function
Voltage	AC 220V 50/Hz/60Hz
Dimensions	256 x 225 x 155mm
Net Weight	6kg



Mini15000+ High Speed Mini Centrifuge

Cat No.	Description	Price
MINI15000+	High Speed Mini Centrifuge	96000

* Cat No. MINI15000+ & MINI15000+Pro Price Includes Rotor 1.5ml and Rotor Adapter kits

HSN CODE : 8421 1910



Brushless DC Motor | Large and Bright LED Display | Powerful centrifugal force 15100 x g and Max. Speed 15000 RPM | PULSE to offer Quick Spins Explosion Proof Inner Steel Build Design | Heavy Base Eliminates Vibration & Movement when operating at High Speeds | Fast Acceleration & Braking Digital Wheel to adjust Speed and Time | Motor Driven Lid-Lock System for Safety & reliability | Programmable - Can store upto 10 Programs

Automatic Lid Open upon running completion | *Timer Starts when machine reach the set speed



Cryo Workstation

Rigid & Sturdy | Made from High Quality PP | Cold-resitant, withstands freezing
40 x 2ml/5ml Cryotubes | Can Fit Most of the Branded Cryovials

Cat. No.	Capacity	Packing	Price/Pack	Price/10 Packs
MCRKCR01	Cryo Workstation (Fits 40 Vials)	4	2337	22786

HSN CODE : 3926 9099



Cardboard Cryo Box

Sturdy Material | Most versatile & economical Option for storage of Cryovials / Microtubes | Can withstand long time freezing

Cat. No.	Capacity	Packing	Price/Pack	Price/12 Packs
MCCRCB081	Cardboard Box for 1.8ml Tubes	24	4542	53141
MCCRCB281	Cardboard Box II for 1.8ml tubes	24	6216	72727

HSN CODE : 4819 1010



Cryovials

Made from High Quality PP | Certified for Safe Use upto -196°C | Leak Proof | Self Standing | Available Internal/External Thread
 New HP Silicon Ring for complete seal | Certified Dnase Rnase Free | Certified Non Pyrogenic | Available Gamma Sterile
 Manufactured According to International Standards Ensures Quality & Performance

Warning: Recommend Only For Storage in Gas phase, Do not use Cryo vials for storage in the liquid phase of liquid nitrogen.

Cat. No.	Capacity	Packing	Price/Pack
MCCRVI02	Cryovial 2ml Internal thread	1000	12012
MCCRVI12	Cryovial 2ml Internal thread, Gamma sterile	1000	12534
MCCRVE02	Cryovial 2ml External thread	1000	12012
MCCRVE12	Cryovial 2ml External thread , Gamma Sterile	1000	12534
MCCRVI05	Cryovial 5ml Internal thread	500	9150
MCCRVI15	Cryovial 5ml Internal thread, Gamma Sterile	500	10500
MCCRVE05	Cryovial 5ml External thread	500	9150
MCCRVE15	Cryovial 5ml External thread, Gamma Sterile	500	10500
MCCRCP1	Cryo Coders	1000	1860

*For Cap inserts/ Cryo Coders Add Suffix R for Red, Y for Yellow, B for Blue, G for Green, W for white

Cryovials HSN CODE : 3923 3090

Cryo Coder HSN CODE : 3926 9099



Storage Vials

Leak Proof | Clear Printed Graduations | Silicon Ring Cap Design | Withstands autoclaving and freezing

Cat. No.	Capacity	Packing	Price/Pack
MCSV00018	1.8ml	2000	8322
MCSV10018	1.8ml Gamma Sterile	2000	9285
MCSV00018	1.8ml without Graduation	2000	8322
MCSV10018	1.8ml without Graduation Gamma Sterile	2000	9285
MCSV00005	5ml	1000	6339
MCSV10005	5ml Gamma Sterile	1000	7296

HSN CODE : 3923 3090



Serum & Sample Cryogenic Vials

Leak Proof | Self Standing | Silicon Ring for complete seal | Excellent quality PP Body and PE Cap
Proved Excellent for handling & processing Small Volume Samples | Withstand Autoclaving & Freezing

Cat. No.	Capacity	Packing	Price/Pack
MCSST005	0.5ml	500/Bag, 1000/Pack	7800
MCSST105	0.5ml Gamma Sterile	500/Bag, 1000/Pack	8100
MCSST010	1.0ml	500/Bag, 1000/Pack	7800
MCSST110	1.0ml Gamma Sterile	500/Bag, 1000/Pack	8100
MCSST015	1.5ml	500/Bag, 1000/Pack	7800
MCSST115	1.5ml Gamma Sterile	500/Bag, 1000/Pack	8100

HSN CODE : 3923 3090



Cryo Box (PC)

Made of High Quality Polycarbonate | Sturdy and rigid | Printed transparent lid Ensures - Easy Sample Identification | Can withstand Ultra Low Temperatures.

Cat. No.	Capacity	Packing	Price/Pack	Price/12 Packs
MCPCCB025	2ml / 25 Places	8	1731	20253
MCPCCB100	2ml / 100 Places	8	4950	57915

HSN CODE : 3923 1090



Cryo Box (PP)

Made of High Quality Polypropylene | Sturdy and rigid | Printed Alphanumeric Base & Engraved Lid Ensures - Easy Sample Identification | Withstand Autoclaving & Freezing

Cat. No.	Capacity	Packing	Price/Pack	Price/12 Packs
MCP PCB100	2ml / 100 Places	8	3120	36504

HSN CODE : 3923 1090

- Made from Corrosion-resistant stainless steel
- Easy to track samples by improving organization in your freezers
- Eliminate dead space
- Compatible For use with mainly all standard upright and chest freezers
- Customize Size Available



Vertical type



Upright Frame type



Upright Drawer type

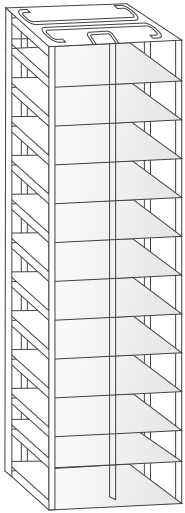

Stainless Steel Freezer Racks (Vertical Type)

Cat No.	Type	Description	Packing	Price
MCFRVT4	Vertical type for Cryo Box 2 Inch	1x4	1	3402
MCFRVT5	Vertical type for Cryo Box 2 Inch	1x5	1	4176
MCFRVT7	Vertical type for Cryo Box 2 Inch	1x7	1	5802
MCFRVT9	Vertical type for Cryo Box 2 Inch	1x9	1	7503
MCFRVT10	Vertical type for Cryo Box 2 Inch	1x10	1	8352
MCFRVT12	Vertical type for Cryo Box 2 Inch	1x12	1	9900
MCFRVT25	Vertical type for Multiwell Plates	25 places	1	6960
MCFRVT35	Vertical type for Multiwell Plates	35 places	1	8538
MCFRVT40	Vertical type for Multiwell Plates	40 places	1	9702
MCFRVT45	Vertical type for Multiwell Plates	45 places	1	10551

HSN CODE : 7326 9090

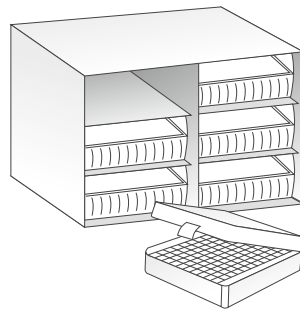

Stainless Steel Freezer Racks (Upright Frame Type)

Cat No.	Type	Description	Packing	Price
MCFRFT33	Upright Frame type for Cryo Box 2 Inch	3x3	1	7656
MCFRFT34	Upright Frame type for Cryo Box 2 Inch	3x4	1	10056
MCFRFT35	Upright Frame type for Cryo Box 2 Inch	3x5	1	12762
MCFRFT43	Upright Frame type for Cryo Box 2 Inch	4x3	1	10053
MCFRFT44	Upright Frame type for Cryo Box 2 Inch	4x4	1	13545
MCFRFT45	Upright Frame type for Cryo Box 2 Inch	4x5	1	15084
MCFRFT80	Upright Frame type for Multiwell Plates	80 places	1	13185
MCFRFT96	Upright Frame type for Multiwell Plates	96 places	1	14700

HSN CODE : 7326 9090

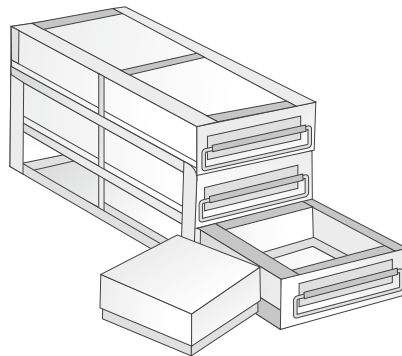

Stainless Steel Freezer Racks (Upright Drawer Type)

Cat No.	Type	Description	Packing	Price
MCFRSD33	Upright Drawer Type for Cryo Box 2 Inch	3x3	1	10674
MCFRSD34	Upright Drawer Type for Cryo Box 2 Inch	3x4	1	13764
MCFRSD35	Upright Drawer Type for Cryo Box 2 Inch	3x5	1	15468
MCFRSD43	Upright Drawer Type for Cryo Box 2 Inch	4x3	1	13764
MCFRSD44	Upright Drawer Type for Cryo Box 2 Inch	4x4	1	18561
MCFRSD45	Upright Drawer Type for Cryo Box 2 Inch	4x5	1	22410

HSN CODE : 7326 9090

These bags are mainly used for Disposal of Biohazard waste and can be used for autoclaving objects in a safe and efficient way. Ideal for autoclaving animal cages, petri dishes, membrane filters, culture plates, pipettes, etc.



Autoclave Bags

Cat. No.	Description	Packing	Price/Pack	Price/10 Packs
MCAB000S	Autoclave Bag Small 12"x16"	200	3534	34457
MCAB000M	Autoclave Bag Medium 16"x20"	200	4923	47999
MCAB000L	Autoclave Bag Large 20"x26"	200	9723	94799
MCAB00XL	Autoclave Bag XL 24"x30"	200	13431	130952
MCAB0XXL	Autoclave Bag XXL 26"x40"	200	18081	176290

HSN CODE : 3923 2100



* These bags are almost 4 times Thick & Strong then our discontinued Cat No. MCAB05056 & MCAB07080
 * Actual Product May Differ from Image shown above.





Pipette Tips Box

Material : PP | Stackable & Sturdy | Clear Lid | Lid lock design | Withstand Autoclaving and Freezing
 Compatible with Moxcare Standard & Premium Range of Pipette Tips

Cat. No.	Capacity	Packing	Price/Pack
MCTBXP010	Pipette Tips box 10ul	10	1770
MCTBXP010L	Pipette Tips box 10ul long	10	1770
MCTBXP200	Pipette Tips box 200ul	10	1770
MCTBXP000	Pipette Tips box 1000ul	10	2301
MCTBXP000L	Pipette Tips box 1250ul	10	3039
MCTBX5000	Pipette Tips box 5000ul	10	5820

HSN CODE : 3923 1090



Pipette Tips

Graduated | High Clarity | Certified Dnase Rnase Free | Available Gamma Sterile | Autoclavable
 Universal fit, Compatible with mainly all branded Pipettors.

Cat. No.	Description	Packing	Price/Pack	Price/10 Packs
MCPTS0010	10ul Clear, Bulk Packing	1000/Bag, 10Bag/Pack	6000	58500
MCPTS1010	10ul Clear, Bulk Packing Sterile	1000/Bag, 10Bag/Pack	6720	65520
MCPTS1010-R	10ul Clear, Racked Sterile	10 Rack/Pack	2526	24629
MCPTS0010L	10ul long Clear, Bulk Packing	1000/Bag, 10Bag/Pack	6000	58500
MCPTS1010L	10ul long Clear, Bulk Packing Sterile	1000/Bag, 10Bag/Pack	6720	65520
MCPTS1010L-R	10ul long Clear, Racked Sterile	10 Rack/Pack	2526	24629
MCPTS0200	200ul Clear, Bulk Packing	1000/Bag, 10Bag/Pack	4686	45689
MCPTS1200	200ul Clear, Bulk Packing Sterile	1000/Bag, 10Bag/Pack	5622	54815
MCPTS1200-R	200ul Clear, Racked Sterile	10 Rack/Pack	2526	24629
MCPTS0000	1000ul Clear, Bulk Packing	500/Bag, 10 Bag/Pack	4065	39634
MCPTS1000	1000ul Clear, Bulk Packing Sterile	500/Bag, 10 Bag/Pack	5388	52533
MCPTS1000-R	1000ul Clear, Racked Sterile	10 Rack/Pack	3426	33404
MCPTS05000	5000ul Clear, Bulk Packing	250/Box, 5 Box/Pack	6360	62010
MCPTS15000	5000ul Clear, Bulk Packing Sterile	250/Box, 5 Box/Pack	7638	74471
MCPTS15000-R	5000ul Clear, Racked Sterile	10 Rack/Pack	7971	77717
MCPTS05000L	5000ul Long Clear, Bulk Packing	250/Box, 5 Box/Pack	7395	72101
MCPTS15000L	5000ul Long Clear, Bulk Packing Sterile	250/Box, 5 Box/Pack	8673	84562
MCPTS15000L-R	5000ul Long Clear, Racked Sterile	10 Rack/Pack	8925	87019

*The Pipette Tips mentioned on this page are also termed "Moxcare Standard Quality Pipette Tips".

HSN CODE : 8479 9090

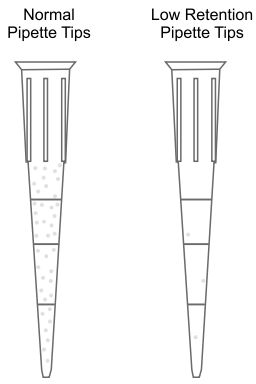
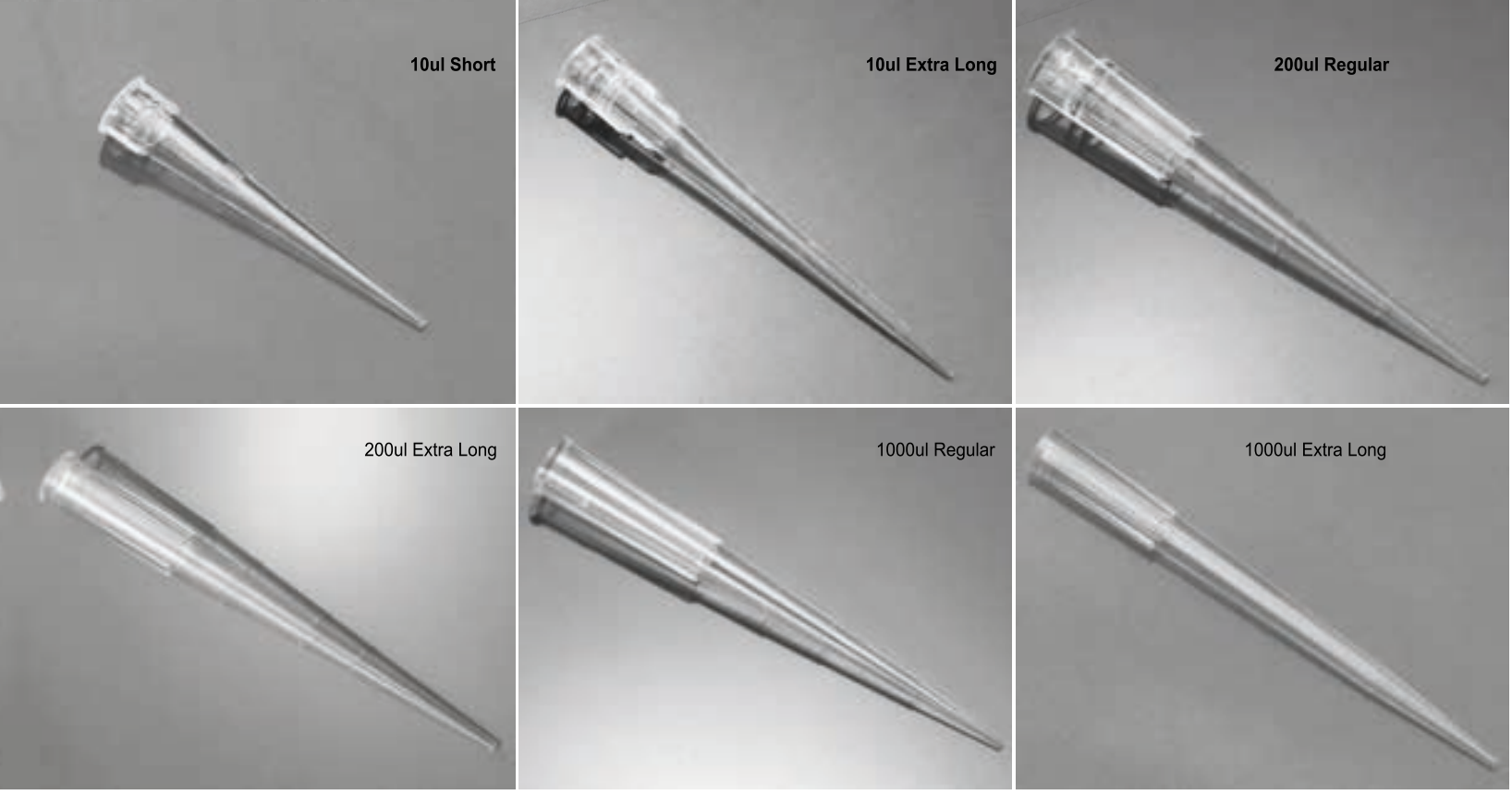

Low Retention Surface | Extended Length | Unique Thin Wall Design
 US FDA Approved Raw Material | Certified Dnase Rnase Free | Certified Non Pyrogenic
 Gamma Irradiation Sterile | Universal Fit Compatible to all Pipettors

Low Retention Pipette Tips

Cat. No.	Description	Packing	Price/Each	Price/Pack
MCPTP12010	10ul Short Low Retention Pipette Tips, Bulk Packing, Sterile	1000/Box, 10 Box/Pack	1104	11040
MCPTP12010-R	10ul Short Low Retention Pipette Tips, Racked, Sterile	96/Rack, 10/Pack	330	3300
MCPTP12010L	10ul Long Low Retention Pipette Tips, Bulk Packing, Sterile	1000/Box, 10 Box/Pack	1194	11940
MCPTP12010L-R	10ul Long Low Retention Pipette Tips, Racked, Sterile	96/Rack, 10/Pack	330	3300
MCPTP12200	200ul Low Retention Pipette Tips, Bulk Packing, Sterile	1000/Box, 10 Box/Pack	1104	11040
MCPTP12200-R	200ul Low Retention Pipette Tips, Racked, Sterile	96/Rack, 10/Pack	330	3300
MCPTP12000	1000ul Low Retention Pipette Tips, Bulk Packing, Sterile	1000/Box, 10 Box/Pack	1428	14280
MCPTP12000-R	1000ul Low Retention Pipette Tips, Racked, Sterile	96/Rack, 10/Pack	420	4200
MCPTP12000L	1000ul Long Low Retention Pipette Tips, Bulk Packing, Sterile	1000/Box, 10 Box/Pack	2184	21840
MCPTP12000L-R	1000ul Long Low Retention Pipette Tips, Racked, Sterile	96/Rack, 10/Pack	555	5550

*In Bulk Packing Price Each means Price for 1 Box, (1000Pcs./Box)
 *In Rack Packing Price Each means Price for 1 Rack

HSN CODE : 8479 9090

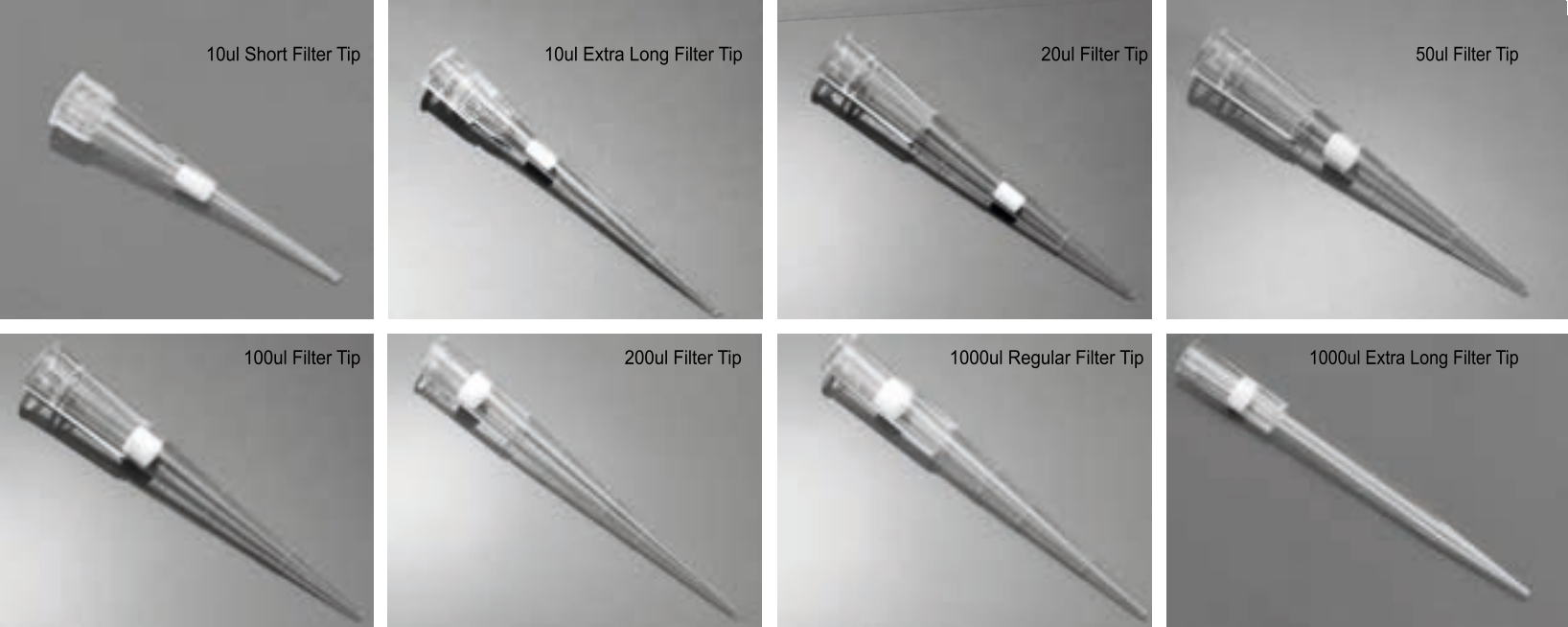

Low Retention Surface | High Quality Hydrophobic Filter | Extended Length | Unique Thin Wall Design
 US FDA Approved Raw Material | Certified Dnase Rnase Free | Certified Non Pyrogenic
 Gamma Sterile Available | Universal Fit Compatible to all Pipettors

Pipette Filter Tips

Cat. No.	Description	Packing	Price/Pack
MCFT12010	10ul Short Pipette Filter Tips, Bulk Packing, Sterile	1000/Bag	2850
MCFT12010L	10ul Long Pipette Filter Tips, Bulk Packing, Sterile	1000/Bag	2850
MCFT12020	20ul Pipette Filter Tips, Bulk Packing, Sterile	1000/Bag	2850
MCFT12100	100ul Pipette Filter Tips, Bulk Packing, Sterile	1000/Bag	2850
MCFT12200	200ul Pipette Filter Tips, Bulk Packing, Sterile	1000/Bag	2850
MCFT121000	1000ul Pipette Filter Tips, Bulk Packing, Sterile	1000/Bag	3660
MCFT121000L	1000ul Long Pipette Filter Tips, Bulk Packing, Sterile	1000/Bag	4560
MCFT12010-R	10ul Short Pipette Filter Tips, Racked, Sterile	96/Rack, 10 Rack/Pack	4560
MCFT12010L-R	10ul Long Pipette Filter Tips, Racked, Sterile	96/Rack, 10 Rack/Pack	4560
MCFT12020-R	20ul Pipette Filter Tips, Racked, Sterile	96/Rack, 10 Rack/Pack	4560
MCFT12100-R	100ul Pipette Filter Tips, Racked, Sterile	96/Rack, 10 Rack/Pack	4560
MCFT12200-R	200ul Pipette Filter Tips, Racked, Sterile	96/Rack, 10 Rack/Pack	4560
MCFT121000-R	1000ul Pipette Filter Tips, Racked, Sterile	96/Rack, 10 Rack/Pack	5280
MCFT121000L-R	1000ul Long Pipette Filter Tips, Racked, Sterile	96/Rack, 10 Rack/Pack	7170

Low Retention Pipette Filter Tips

Cat. No.	Description	Packing	Price/Pack
MCFTPLR12010	10ul Short Low Retention Pipette Filter Tips, Bulk Packing, Sterile	1000/Bag	3210
MCFTPLR12010L	10ul Long Low Retention Pipette Filter Tips, Bulk Packing, Sterile	1000/Bag	3210
MCFTPLR12020	20ul Low Retention Pipette Filter Tips, Bulk Packing, Sterile	1000/Bag	3210
MCFTPLR12100	100ul Low Retention Pipette Filter Tips, Bulk Packing, Sterile	1000/Bag	3210
MCFTPLR12200	200ul Low Retention Pipette Filter Tips, Bulk Packing, Sterile	1000/Bag	3210
MCFTPLR121000	1000ul Low Retention Pipette Filter Tips, Bulk Packing, Sterile	1000/Bag	3975
MCFTPLR121000L	1000ul Long Low Retention Pipette Filter Tips, Bulk Packing, Sterile	1000/Bag	4884
MCFTPLR12010-R	10ul Short Low Retention Pipette Filter Tips, Racked, Sterile	96/Rack, 10 Rack/Pack	5100
MCFTPLR12010L-R	10ul Long Low Retention Pipette Filter Tips, Racked, Sterile	96/Rack, 10 Rack/Pack	5100
MCFTPLR12020-R	20ul Low Retention Pipette Filter Tips, Racked, Sterile	96/Rack, 10 Rack/Pack	5100
MCFTPLR12100-R	100ul Low Retention Pipette Filter Tips, Racked, Sterile	96/Rack, 10 Rack/Pack	5100
MCFTPLR12200-R	200ul Low Retention Pipette Filter Tips, Racked, Sterile	96/Rack, 10 Rack/Pack	5100
MCFTPLR121000-R	1000ul Low Retention Pipette Filter Tips, Racked, Sterile	96/Rack, 10 Rack/Pack	5910
MCFTPLR121000L-R	1000ul Long Low Retention Pipette Filter Tips, Racked, Sterile	96/Rack, 10 Rack/Pack	7989



Individual Wrap Pipette Tips

Cat. No.	Description	Packing	Price/Pack
MCPTS0010IW	Pipette Tips Individual Pack 10ul, Sterile	1000	3390
MCPTS0200IW	Pipette Tips Individual Pack 200ul, Sterile	1000	3390
MCPTS1000IW	Pipette Tips Individual Pack 1000ul, Sterile	1000	3696
MCPTP12010IW	Pipette Tips Low retention Individual Pack 10ul, Sterile	1000	3930
MCPTP12200IW	Pipette Tips Low retention Individual Pack 200ul, Sterile	1000	3930
MCPTP12000IW	Pipette Tips Low retention Individual Pack 1000ul, Sterile	1000	4470
MCFTP12010IW	Pipette Filter Tips Individual Pack 10ul, Sterile	1000	6000
MCFTP12020IW	Pipette Filter Tips Individual Pack 20ul, Sterile	1000	6000
MCFTP12100IW	Pipette Filter Tips Individual Pack 100ul, Sterile	1000	6000
MCFTP12200IW	Pipette Filter Tips Individual Pack 200ul, Sterile	1000	6000
MCFTP121000IW	Pipette Filter Tips Individual Pack 1000ul, Sterile	1000	7134
MCFTPLR12010IW	Pipette Filter Tips, Low retention Individual Pack 10ul, Sterile	1000	6486
MCFTPLR12020IW	Pipette Filter Tips, Low retention Individual Pack 20ul, Sterile	1000	6486
MCFTPLR12100IW	Pipette Filter Tips, Low retention Individual Pack 100ul, Sterile	1000	6486
MCFTPLR12200IW	Pipette Filter Tips, Low retention Individual Pack 200ul, Sterile	1000	6486
MCFTPLR121000IW	Pipette Filter Tips, Low retention Individual Pack 1000ul, Sterile	1000	7710

HSN CODE : 8479 9090

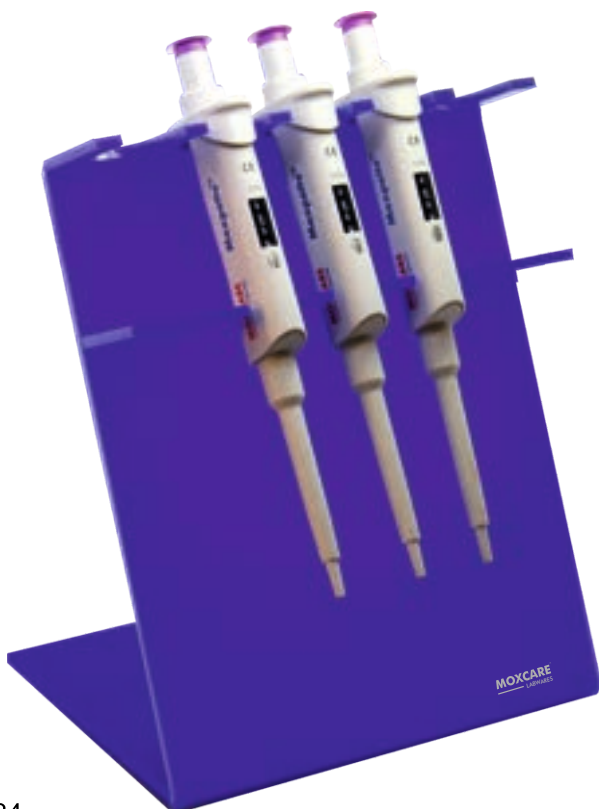

Pipette Stand

Cat. No.	Description	Packing	Price/Pack
MCPPTS	Pipette Stand	1	2220

HSN CODE : 3926 9099



Automation Tips

Made from Medical-grade conductive PP Raw Material | Low Retention Surface | Excellent traceability | High Strength Package
 Certified Dnase Rnase Free | Certified Non Pyrogenic | Pre Sterilized

Cat. No.	Description	Packing	Price/Pack
MCAP150BT	50ul Automation Conductive Tips Black for T Brand, Sterile	96 Tips/Rack, 2304/Case	POR
MCAP1200BT	200ul Automation Conductive Tips Black for T Brand, Sterile	96 Tips/Rack, 2304/Case	POR
MCAP1000BT	1000ul Automation Conductive Tips Black for T Brand, Sterile	96 Tips/Rack, 2304/Case	POR
MCAF150BT	50ul Automation Conductive Filter Tips Black for T Brand, Sterile	96 Tips/Rack, 2304/Case	POR
MCAF1200BT	200ul Automation Conductive Filter Tips Black for T Brand, Sterile	96 Tips/Rack, 2304/Case	POR
MCAF1000BT	1000ul Automation Conductive Filter Tips Black for T Brand, Sterile	96 Tips/Rack, 2304/Case	POR
MCAP150CT	50ul Automation Conductive Tips Clear for T Brand, Sterile	96 Tips/Rack, 2304/Case	POR
MCAP1200CT	200ul Automation Conductive Tips Clear for T Brand, Sterile	96 Tips/Rack, 2304/Case	POR
MCAP1000CT	1000ul Automation Conductive Tips Clear for T Brand, Sterile	96 Tips/Rack, 2304/Case	POR
MCAF150CT	50ul Automation Conductive Filter Tips Clear for T Brand, Sterile	96 Tips/Rack, 2304/Case	POR
MCAF1200CT	200ul Automation Conductive Filter Tips Clear for T Brand, Sterile	96 Tips/Rack, 2304/Case	POR
MCAF1000CT	1000ul Automation Conductive Filter Tips Clear for T Brand, Sterile	96 Tips/Rack, 2304/Case	POR

For Brand Compatibility details and more information. Please visit our website www.moxcare.in

HSN CODE : 8479 9090



121°C

Fully Autoclavable

Fully Autoclavable
 Light Weight
 Easy to Calibrate
 Clear , Large, Easy to Read, Digital Display
 Ergonomic Design for effortless pipetting
 Design avoid repetitive strain injuries

Comfortable Finger Support

Simply turn the plunger for volume selection

Smooth Tip Ejector allows convenient one hand operation

Fully Autoclavable Pipette Body

Chemical Resistant Tip Cone



Volume Range	Increment	Test Volume (ul)	Inaccuracy		Imprecision	
0.5-10ul	101%	0.1	0.8%	0.08		
	0.1ul	5	1.5%	0.075	1.5%	0.075
	1 2.5%	0.025	1.5%	0.015		
2-20ul	200.9%	0.18	0.4%	0.08		
	0.5ul	10	1.2%	0.12	1%	0.1
	2 3%	0.06	2%	0.04		
10-100ul	100	0.8%	0.8	0.15%	0.15	
	1ul	50	1%	0.5	0.40%	0.2
	103%	0.3	1.5%	0.15		
20-200ul	200	0.6%	1.2	0.15%	0.3	
	1ul	100	0.8%	0.8	0.3%	0.3
	203%	0.6	1%	0.2		
100-1000ul	1000	0.6%	6	0.20%	2	
	5ul	500	0.7%	3.5	0.25%	1.25
	100	2	0.70%	0.7		
1000-5000ul	5000	0.5%	25	0.15%	7.5	
	50ul	2500	0.6%	15	0.30%	7.5
	1000	0.7%	7	0.30%	3	

Moxpette Single Channel Pipette

Cat. No.	Description	Packing	Price/Pack
MCSCP10	Moxpette Pipette 0.5-10ul	1	6450
MCSCP20	Moxpette Pipette 2-20ul	1	6450
MCSCP100	Moxpette Pipette 10-100ul	1	6450
MCSCP200	Moxpette Pipette 20-200ul	1	6450
MCSCP1000	Moxpette Pipette 100-1000ul	1	6450
MCSCP5000	Moxpette Pipette 1000-5000ul	1	7530

HSN CODE : 8479 8999

121°C
Fully Autoclavable

Fully Autoclavable
Ergonomic Design ensures light pipetting forces
Clear , Large, Easy to Read Digital Display
Easy to Calibrate
Dispensing head rotates for effortless pipetting
Design avoid repetitive strain injuries

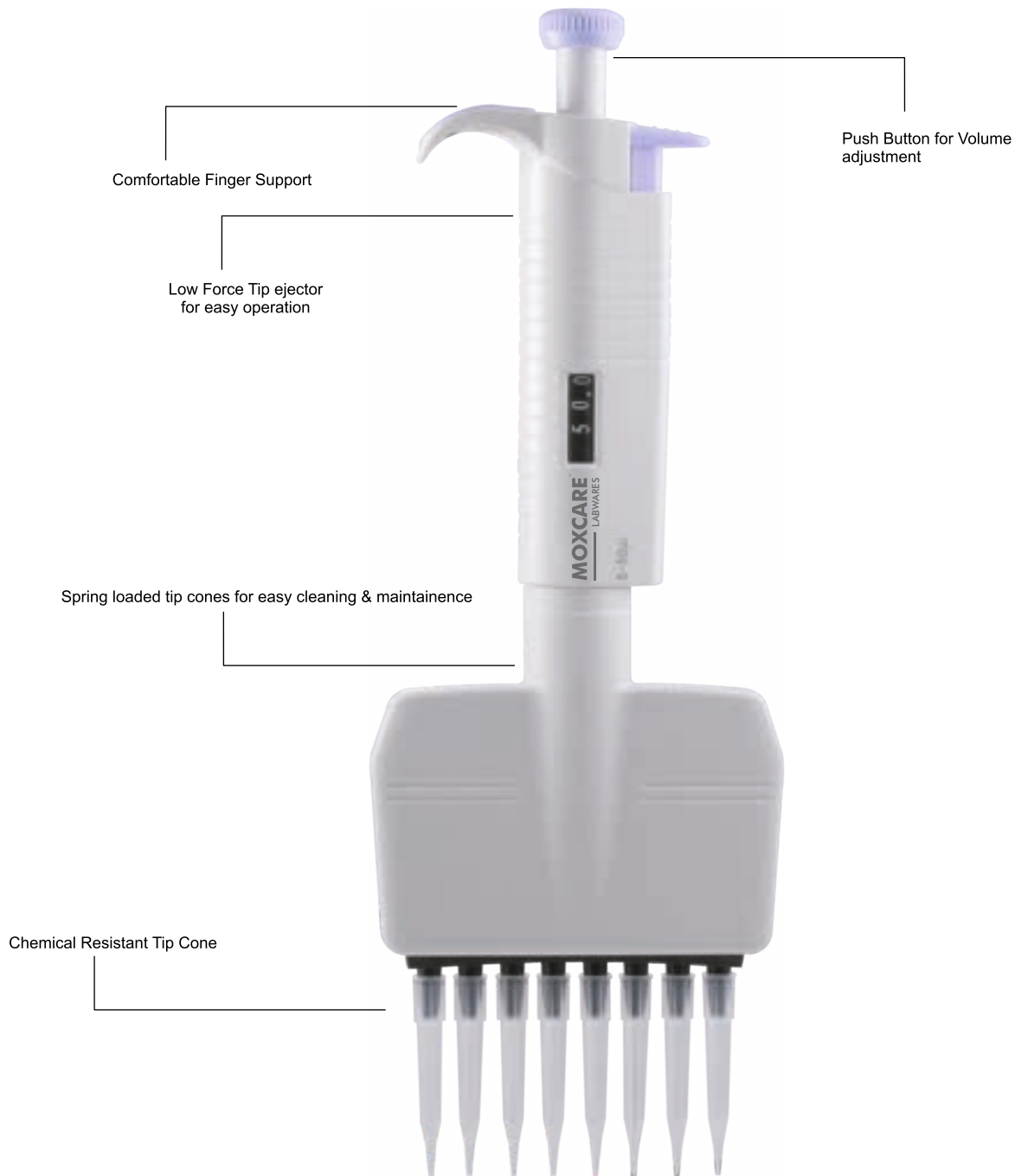

Moxpette- Multi Channel Pipette

Cat. No.	Description	Packing	Price/Pack
MCMCP8-10	Multichannel plus 0.5-10 ul	1	26850
MCMCP8-50	Multichannel plus 5-50 ul	1	26850
MCMCP8-300	Multichannel plus 50-300 ul	1	26850

HSN CODE : 8479 8999



Serological Pipettes

Made from Special High-Grade Polystyrene (GPPS) | Excellent Clarity | Individually Wrapped
 Accurate and Bold graduations | Color-coded ring for easy identification |
 Certified Non Pyrogenic | Certified Dnase Rnase Free | Gamma Irradiation Sterilized

Cat. No.	Description	Packing	Price/Pack	Price/10Packs
MCSP10001	Serological Pipette 1ml, Sterile	1000	12550	122363
MCSP10005	Serological Pipette 5ml, Sterile	200	4050	39488
MCSP10010	Serological Pipette 10ml, Sterile	200	4587	44723
MCSP10025	Serological Pipette 25ml, Sterile	200	8682	84650
MCSP10050	Serological Pipette 50ml, Sterile	100	10500	102375

HSN CODE : 3926 9099

Serological Pipettes Bulk Packaging

Cat. No.	Description	Packing	Price/Pack	Price/10Packs
MCSP10001-B	Serological Pipette 1ml, Bulk Pack Sterile	25Pcs./Bag, 1000 /Case	10950	106763
MCSP10005-B	Serological Pipette 5ml, Bulk Pack Sterile	25Pcs./Bag, 200 /Case	3510	34223
MCSP10010-B	Serological Pipette 10ml, Bulk Pack Sterile	25Pcs./Bag, 200 /Case	3900	38025
MCSP10025-B	Serological Pipette 25ml, Bulk Pack Sterile	20Pcs./Bag, 200 /Case	7800	76050
MCSP10050-B	Serological Pipette 50ml, Bulk Pack Sterile	20Pcs./Bag, 100 /Case	9420	91845

HSN CODE : 3926 9099





Pasteur Pipettes

Made of PE-LD | Uniform drop size | Quick and Safe | Available Sterile

Cat. No.	Capacity	Packing	Price/Pack
MCPP00001	1ml, Non Sterile	500/Box, 10Box/Pack	8289
MCPP10001	1ml, Bulk ETO Sterile	500/Box, 10 Box/Pack	9644
MCPP17001	1ml, Bulk Gamma Sterile	500/Box, 10Box/Pack	11374
MCPP00003	3ml, Non Sterile	500/Box, 10Box/Pack	8289
MCPP10003	3ml, Bulk ETO Sterile	500/Box, 10 Box/Pack	9644
MCPP17003	3ml, Bulk Gamma Sterile	500/Box, 10Box/Pack	11374
MCPP10001I	1ml, I/W, ETO Sterile	Individual, 2000/Pack	8444
MCPP17001I	1ml, I/W Gamma Sterile	Individual, 2000/Pack	9930
MCPP10003I	3ml, I/W, ETO Sterile	Individual, 2000/Pack	8444
MCPP17003I	3ml, I/W Gamma Sterile	Individual, 2000/Pack	9930

I/W : Individual Wrapped

HSN CODE : 3926 9099



Reagent Reservoir

Light weight | Capacity 50ml | Chemical Resistant | Sterile Available

Cat. No.	Capacity	Packing	Price/Pack
MCRRV0050	Reagent Reservoir 50ml	50	3091
MCRRV1050	Reagent Reservoir Gamma Sterile 50ml, 5/pkg	50	3884
MCRRV0100	Reagent Reservoir 100ml	50	3990
MCRRV1100	Reagent Reservoir Gamma Sterile 100ml, 5/pkg	50	4884

HSN CODE : 3926 9099



- Easy to use
- Ergonomic Design & Light weight
- Replaceable Filter
- Compatible with both Glass and Plastic Pipettes
- Less charging time 2-3 hrs for full charge
- 8 hrs of usage time
- Single handed operation with Minimum Effort
- Less fatigue even after long term use

Specifications	
Aspirate Speeds	25ml<7s
Dispense Mode	Motor/Gravity
Battery Life	More than 8 Hrs
Charging Time	2-3 Hrs
Pipette Compatibility	Glass/Plastic
Filter	0.45um Hydrophobic
Weight	200g



Levo M Pipette Controller

Cat. No.	Capacity (ml)	Price
MCPCD01	Levo M Pipette Controller	17700

HSN CODE : 8479 8999



Moxpette - Levo Pipette Controller

Light Weight | Extremely Comfortable & simple to use | Easy to maintain & clean
 Precise one-hand operation | Fits all range of serological & volumetric pipettes
 3um filter prevents cross-contamination and protects against over aspiration.

Cat. No.	Capacity (ml)	Price
MCPC0001	Levo Pipette Controller 1-100ml	3690

HSN CODE : 8479 8999



Petri Dishes



Petri Dish

High Clarity | Different Growth area Available | Uniform Wall & Bottom thickness | Different Packing Formats Available
 Manufactured from high quality Polystyrene | Available Non Sterile, Ethylene Oxide Sterile, Gamma Irradiation Sterile
 Certified Dnase Rnase Free | Non Pyrogenic

Cat. No.	Description	Packing	Price/Pack	Price/10 packs
MCPD17060	Petri Dish 60mm Individual Wrap, Gamma Sterile	250	2310	22523
MCPD00090	Petri Dish 90mm Individual Wrap, Aseptic	500	4569	44548
MCPD00090-1	Petri Dish 90mm 10/Sleeve, Aseptic	540	4380	42705
MCPD17090	Petri Dish 90mm Individual Wrap, Gamma Sterile	500	5145	50164
MCPD17090-1	Petri Dish 90mm 10/Sleeve, Gamma Sterile	540	5010	48848

HSN CODE : 3923 3090





Petri Dish (2/3 Compartment)

Cat. No.	Description	Packing	Price/Pack	Price/10 Packs
MCPD21790	Petri Dish 90mm, 2 Compartment, Individual Wrap, Gamma Sterile	300	6105	59524
MCPD31790	Petri Dish 90mm, 3 Compartment, Individual Wrap, Gamma Sterile	300	6105	59524

HSN CODE : 3923 3090



Petri Dish Square

High Clarity | Uniform Wall & Bottom thickness | Available Ethylene Oxide Sterile or Gamma Irradiation Sterile
 Size : 100 X 100 X 15mm | Certified Dnase Rnase Free, Non Pyrogenic

Cat. No.	Description	Packing	Price/Pack	Price / 6 Packs
MCPDSQ1	Petri Dish Square 100mm, Individual Wrap, Gamma Sterile	150	9171	53650
MCPDSQ2	Petri Dish Square 125mm, Individual Wrap, Gamma Sterile	150	10500	61425

HSN CODE : 3923 3090

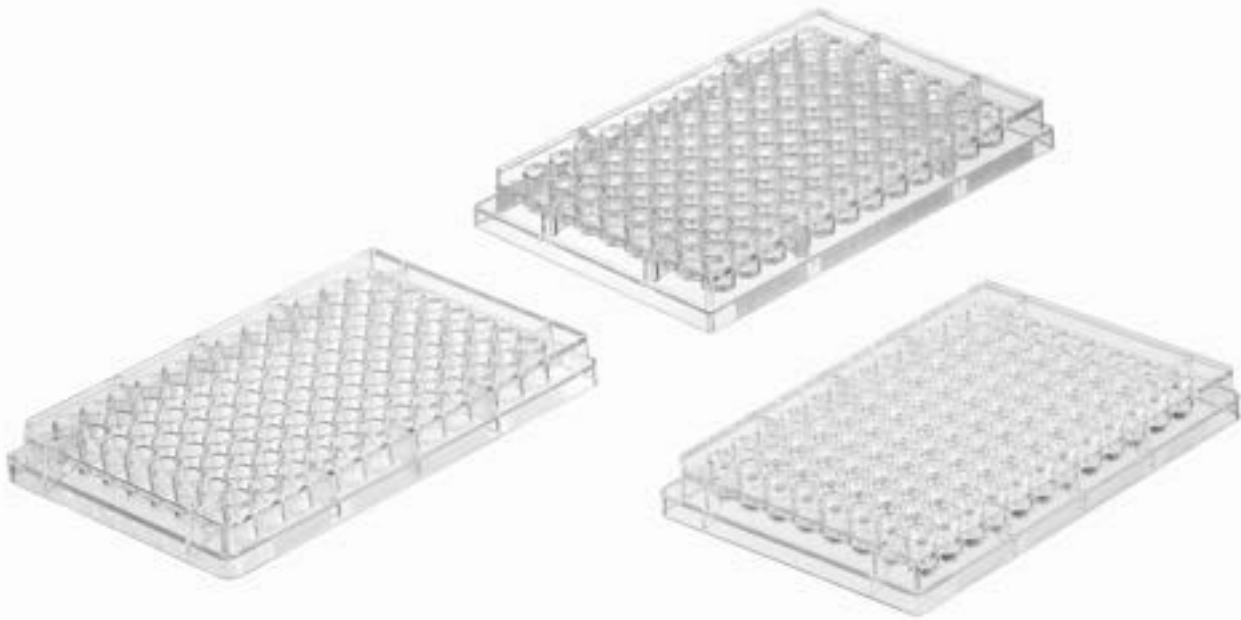

Serological Plates

Ideal for Serological dilution & Basic analysis | Made from High Quality Polystyrene | Alphanumeric well Coding
 Available in Fixed Flat Bottom, U Bottom & V bottom | Excellent optical Clarity | Uniform and smooth Well surface
 Available Gamma Sterile

Cat. No.	Description	Packing	Price/Pack
MCSP10096	96 Well, Flat Bottom, Gamma Sterile	100	8616
MCSP1096U	96 Well, U Bottom, Gamma Sterile	100	10083
MCSP1096V	96 Well, V Bottom, Gamma Sterile	100	10083
MCSPL1006	6 Well, Flat Bottom, Gamma Sterile with Lid	50	6000
MCSPL1012	12 Well, Flat Bottom, Gamma Sterile with Lid	50	6000
MCSPL1024	24 Well, Flat Bottom, Gamma Sterile with Lid	50	6000
MCSPL1048	48 Well, Flat Bottom, Gamma Sterile with Lid	50	6420
MCSPL1096	96 Well, Flat Bottom, Gamma Sterile with Lid	100	9816

HSN CODE : 3926 9099

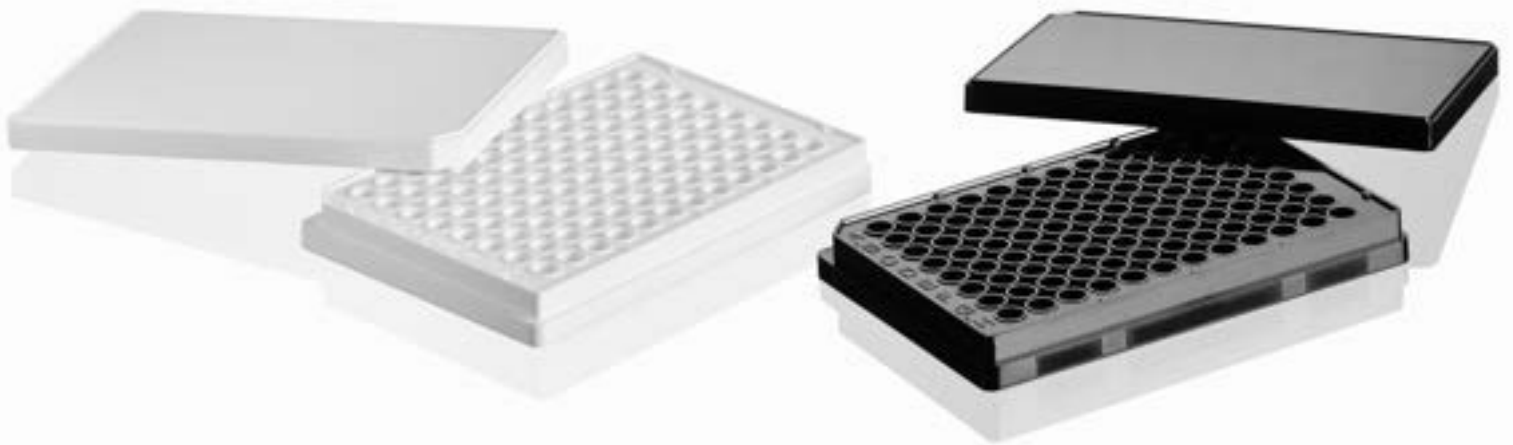

Black & White Serological Plates

Alphanumeric Well Coding | Fixed Flat Bottom | Available in Black or White Colour | Uniform and smooth Well surface
 Available Gamma Sterile

Cat. No.	Description	Packing	Price/Pack
MCSPW1096	96 Well White, Flat Bottom, Gamma Sterile	50	8970
MCSPB1096	96 Well Black, Flat Bottom, Gamma Sterile	50	8970

HSN CODE : 3926 9099



Elisa Plates

Made from High Quality Polystyrene | Excellent Optical Clarity ensures CV transmittance is less than 5.00%
 Alphanumeric well Coding | Free from inclusions Ensure Optimal results | Uniform and smooth Well surface
 Available Gamma Sterile

Cat. No.	Description	Packing	Price/Pack
MCEPD196M	ELISA Plate Flat Bottom, Detachable 8x12, Gamma Sterile	100	11172

HSN CODE : 3926 9099



Deep MultiWell Plates

Made from High-Quality Virgin Polypropylene Complaint to USP Class VI | Alpha Numeric Well Coding | Certified Dnase Rnase Free
 Gamma Irradiation Sterilized | Chemical resistant to wide variety of chemicals | Compatible with Most Automated Systems.

Cat. No.	Description	Packing	Price/Pack
MCDP101U	1ml U Bottom, Bulk Pack	96	32250
MCDP101UI	1ml U Bottom Sterile, Individual Pack	96	33300
MCDP122U	2.2ml U Bottom, Bulk Pack	96	32250
MCDP122UI	2.2ml U Bottom Sterile, Individual Pack	96	33300
MCDP122V	2.2ml V Bottom. Bulk Pack	96	32250
MCDP122VI	2.2ml V Bottom Sterile, Individual Pack	96	33300
MCDPCB08	8 Strip Magnetic tip Comb	96	POR
MCDPCB96	96 Well Magnetic tip Comb	96	POR
MCDPSM01	Sealing Mat	48	14190

HSN CODE : 3926 9099



Cell Culture Flasks

High transparency | Plug Seal Cap & Vent Cap Available | Different Growth area Available | Uniform TC Treatment Ensures Uniform growth
 Precise Bold & Accurate Engraved Graduations | Certified Dnase Rnase Free, Non Pyrogenic | Available Gamma Sterile

Cat. No.	Description	Packing	Price/Pack	Price/10 Packs
MCCF17025	25cm ² Cell Culture Flask, Plug Seal Cap, TC Treated, Sterile	200	12237	119311
MCCF17075	75cm ² Cell Culture Flask, Plug Seal Cap, TC Treated, Sterile	100	12237	119311
MCCF17175	175cm ² Cell Culture Flask, Plug Seal Cap, TC Treated, Sterile	40	10590	103253
MCCF17025-F	25cm ² Cell Culture Flask, Vent Cap, TC Treated, Sterile	200	12831	125102
MCCF17075-F	75cm ² Cell Culture Flask, Vent Cap, TC Treated, Sterile	100	12831	125102
MCCF17175-F	175cm ² Cell Culture Flask, Vent Cap, TC Treated, Sterile	40	11055	107786

HSN CODE : 3923 3090



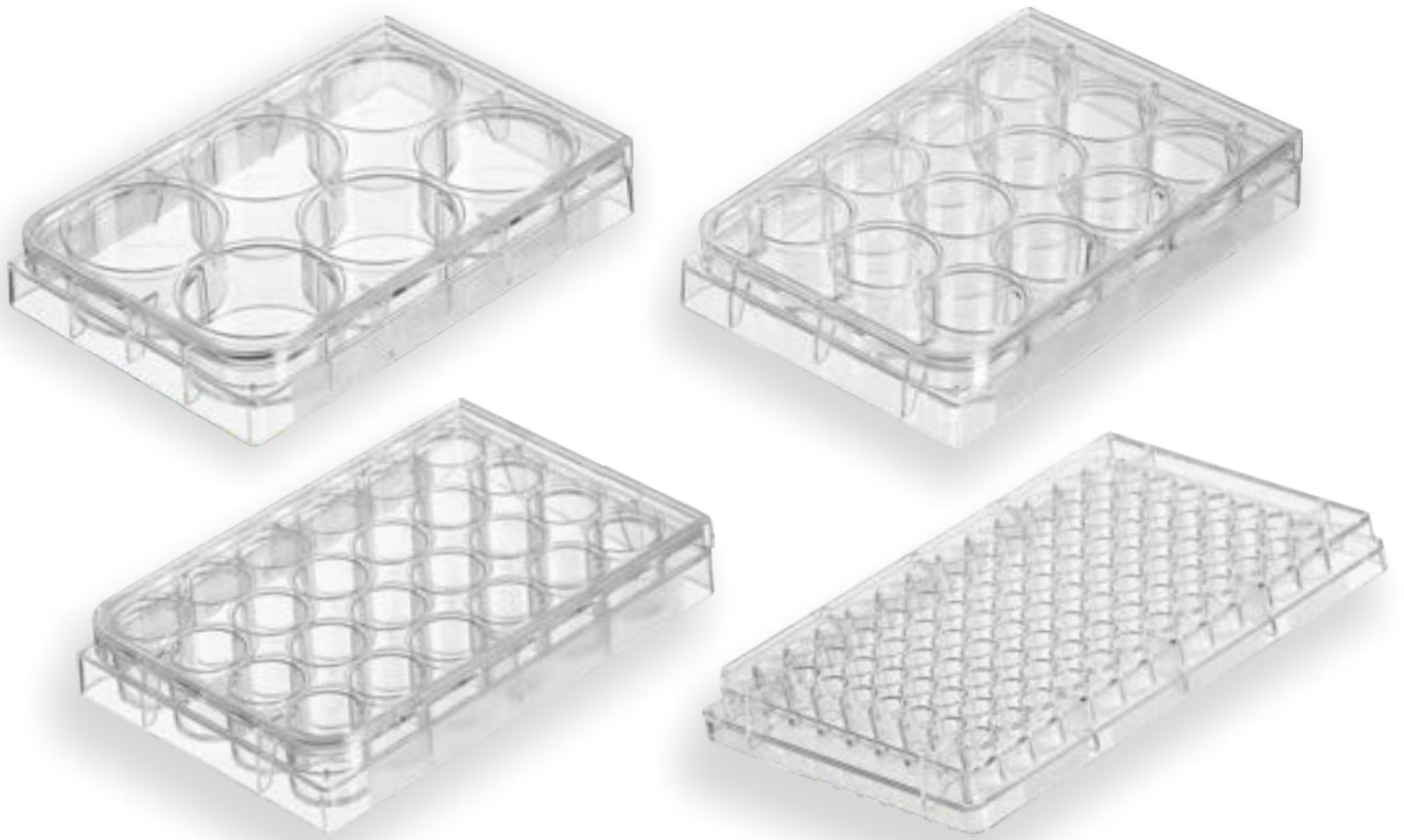

Cell Culture Plates

High transparency | Different Growth area Available | Uniform TC Treatment Ensures Uniform Growth | Alphanumeric Well coding
 Lid enables optimal gas exchange with lowest possible evaporation | Certified Dnase Rnase Free, Non Pyrogenic | Gamma Irradiation Sterile

Cat. No.	Description	Packing	Price/Pack	Price/10 Packs
MCCP17006	6 Well Cell Culture Plate, TC Treated, Sterile	50	7008	68328
MCCP17012	12 Well Cell Culture Plate, TC Treated, Sterile	50	7449	72628
MCCP17024	24 Well Cell Culture Plate, TC Treated, Sterile	50	7449	72628
MCCP17048	48 Well Cell Culture Plate, TC Treated, Sterile	50	8025	78244
MCCP17096	96 Well Cell Culture Plate, Flat Bottom, TC Treated, Sterile	100	13599	132590

HSN CODE : 3926 9099

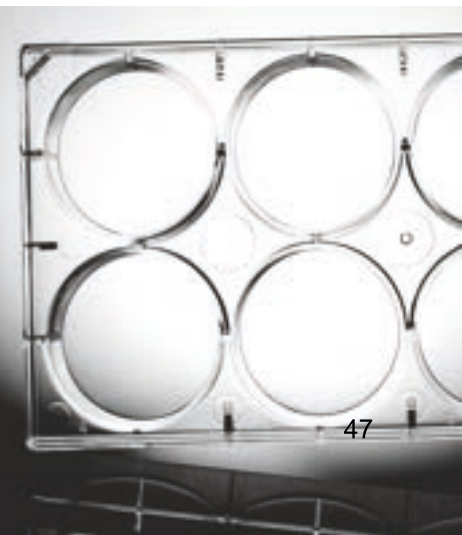
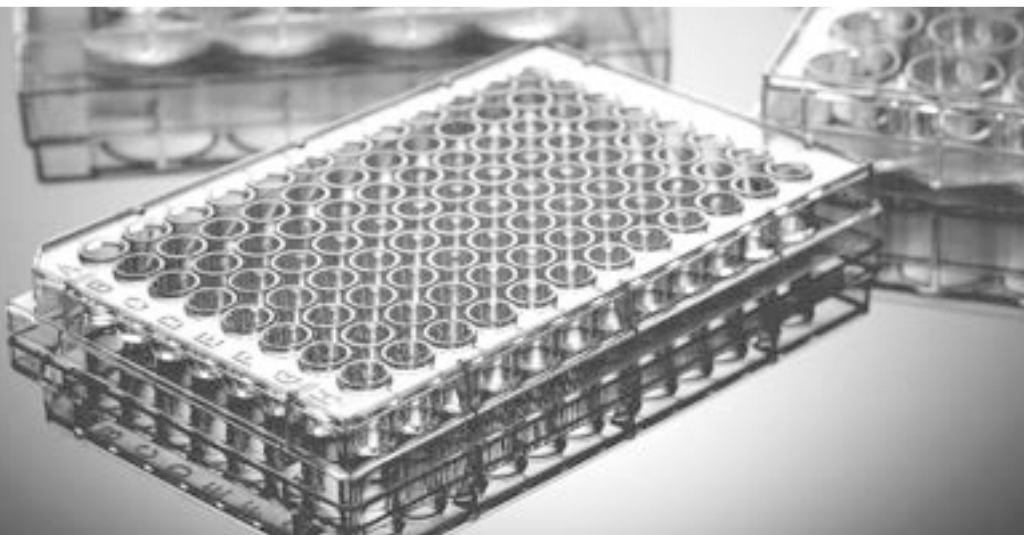



Culture Dish

Excellent Clarity | Uniform Surface treatment | Uniform growth surface | Different growth Areas available Available TC Treated / Non Treated
 Certified Dnase Rnase Free, Non Pyrogenic | Gamma Irradiation Sterile

Cat. No.	Description	Packing	Price/Pack	Price /10Pack
MCCD17035	35mm Cell Culture Dish, 20Pcs./Pkg, TC Treated, Sterile	500	9648	94068
MCCD17060	60mm Cell Culture Dish, 20Pcs./Pkg, TC Treated, Sterile	500	11175	108956
MCCD10090	90mm Cell Culture Dish, 10Pcs./Pkg, Non Treated, Sterile	500	12534	122207
MCCD17100	100mm/90mm Cell Culture Dish, 5Pcs./Pkg, TC Treated, Sterile	300	11235	109541
MCCD17150	150mm Cell Culture Dish, 5Pcs./Pkg, TC Treated, Sterile	100	13254	129227

HSN CODE : 3926 9099



Culture Tube Dual Position Snap Cap

Cat. No.	Description	Packing	Price/Pack	Price/10Pack
MCCT004	4ml Cell Culture Tube Dual Position Snap Cap Non Treated, Gamma Sterile	500	7152	69732
MCCT0012	12ml Cell Culture Tube Dual Position Snap Cap Non Treated, Gamma Sterile	500	11199	109190

HSN CODE : 3926 9099

Culture Tube Plug Cap

Cat. No.	Description	Packing	Price/Pack
MCCT1012100	Culture Tube 12x100mm Plug Cap, Non Treated, Sterile	2500	10815
MCCT1016100	Culture Tube 16x100mm Plug Cap, Non Treated, Sterile	2500	19038

HSN CODE : 3926 9099



High flexibility | Pre Sterilized | Assure uniform sample quantity | Provide Easy Access to Samples/Growth Surface
Gamma Irradiation Sterile | Certified Dnase Rnase Free, Non Pyrogenic

Inoculation Loops			
Cat. No.	Description	Packing	Price/Pack
MCILN01	Inoculation loop Needle	100	585
MCIL10110	Inoculation loops 1ul + 10ul, 10/pkg	100	585
MCIL10001-1	Inoculation loops 1ul, 1/pkg	100	585
MCIL10110-1	Inoculation loops 1ul + 10ul, 1/pkg	100	699
Spreaders			
MCLS10000	L spreaders 10/pkg	100	1266
MCTS10000	T spreaders 10/pkg	100	2028
Cell Lifters			
MCCL1001	Cell Lifter	50	1359
Cell Scrapers			
MCCS10180	Cell Scraper 180mm Individual Pack	200	9429
MCCS10250	Cell Scraper 250mm Individual Pack	200	14580
Cell Strainers			
MCCS40B	Cell Strainer 40um, PP/Nylon, Sterile	50	9600
MCCS70N	Cell Strainer 70um, PP/Nylon, Sterile	50	9600
MCCS100Y	Cell Strainer 100um, PP/Nylon, Sterile	50	9600

HSN CODE : 3926 9099



cell Stariner



L Spreader



Cell Lifter



Cell Scraper

Culture Tubes - Glass

Cat. No.	Capacity	Packing	Price/Pack
MCCTG05	5ml, Clear Glass, U Bottom with Cap	500	18480
MCCTG10	10ml, Clear Glass, U Bottom with Cap	500	24000
MCCTG30	30ml, Clear Glass, U Bottom with Cap	500	30000
MCCTG60	60ml, Clear Glass, U Bottom with Cap	500	39000
MCCTG05A	5ml, Amber, U Bottom with Cap	500	36960
MCCTG10A	10ml, Amber, U Bottom with Cap	500	57500
MCCTG30A	30ml, Amber, U Bottom with Cap	500	75500
MCCTG60A	60ml, Amber, U Bottom with Cap	500	87825

HSN CODE : 7017 9090



Test Tubes - Glass

Cat. No.	Capacity	Packing	Price/Pack
MCTT1275	12x75mm, Clear Glass, U Bottom	500	4000
MCTT12100	12x100mm, Clear Glass, U Bottom	500	5500
MCTT15125	15x125mm, Clear Glass, U Bottom	500	6500
MCTT15150	15x150mm, Clear Glass, U Bottom	500	7750
MCTT18150	18x150mm, Clear Glass, U Bottom	500	8250
MCTT25100	25x100mm, Clear Glass, U Bottom	500	10500
MCTT25150	25x150mm, Clear Glass, U Bottom	500	13000
MCTT25200	25x200mm, Clear Glass, U Bottom	500	17100
MCTT32200	32x200mm, Clear Glass, U Bottom	500	28000
MCTT38200	38x200mm, Clear Glass, U Bottom	500	33000

HSN CODE : 7017 9090

The above mentioned Cat. No.'s are for tubes without RIM, For Tubes with RIM add Suffix "R" Example MCTT1275R. Price for Tubes with RIM and Without RIM are same.





PCR PRODUCTS



PCR Tube

Optical Clear | Ultra Thin Wall Ensures to Provide Optimal and Rapid Heat Transfer | Consistent wall Thickness
 Choose Between Flat/Domed Caps, Optical Clear Flat Cap/frosted Flat Cap | Compatible to fit with Most of Branded PCR Machine
 Certified Dnase Rnase Free | Certified Non Pyrogenic

Cat. No.	Description	Packing	Price/Pack	Price/10 Packs
650701	PCR tube 0.2ml, Optical Clear with Optical Flat Cap	1000	2652	25857
650702	PCR tube 0.2ml, Optical Clear with Frosted Flat Cap	1000	2202	21470
650703	PCR tube 0.2ml, Optical Clear with Domed Cap	1000	2652	25857
650704	PCR tube 0.5ml, Optical Clear with Flat Cap	1000	4305	41974

HSN CODE : 3926 9099



PCR Tube Strips

Optical Clear | Ultra Thin Wall Ensures to Provide Optimal and Rapid Heat Transfer | Consistent wall Thickness
 Choose Between Flat/Domed Caps, Optical Clear Flat Cap/frosted Flat Cap | Compatible to fit with Most of Branded PCR Machine
 Certified Dnase Rnase Free | Certified Non Pyrogenic

Cat. No.	Description	Packing	Price/Pack	Price/10 Packs
650706	0.2ml PCR Tube Strips of 8 clear with Optical flat cap	125	4785	46654
650707	0.2ml PCR Tube Strips of 8 clear with Domed cap	125	4785	46654
650708	0.2ml PCR Tube Strips of 8 clear with Optical Attached flat cap	125	5409	52738
650710	0.1ml, 8 Strip PCR tubes with Optical flat caps, Clear	125	4785	46654
650711	0.1ml, 8 Strip PCR tubes with Optical flat caps, White	125	5700	55575
650712	0.2ml, 8 Strip PCR tubes with Optical flat caps, Clear	125	4785	46654
650713	0.2ml, 8 Strip PCR tubes with Optical flat caps, White	125	5700	55575

HSN CODE : 3926 9099



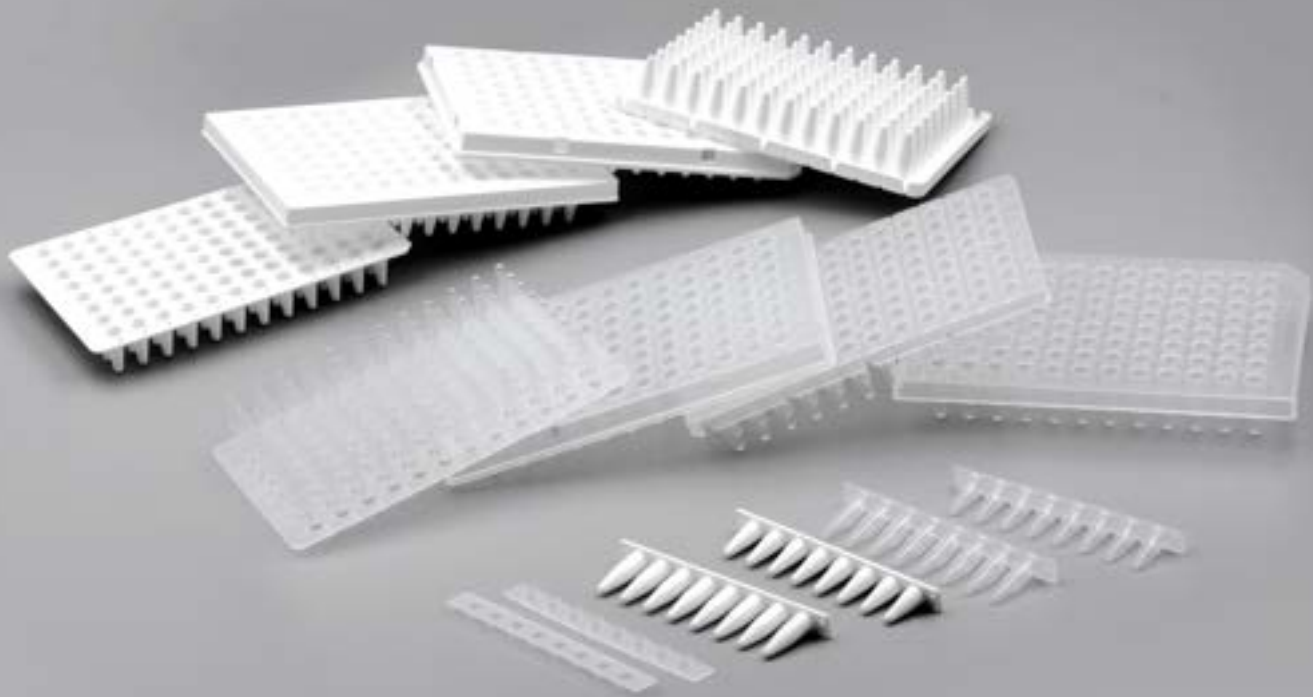

PCR Plates

Clear well bottom for sample visibility | Ultra Thin Wall Ensures Optimal and Rapid Heat Transfer | Consistent wall Thickness
 Raised Well design | Cut Away Marks | Alphanumeric Grid | Sealable with Adhesive films and heat seals
 Compatible to fit with Most of Branded PCR Machine | Certified Dnase Rnase Free | Certified Non Pyrogenic

Cat. No.	Description	Packing	Price/Pack	Price/10 Packs
650901	PCR plate 96well, 0.1ml Non skirted, clear	20	5310	51773
650902	PCR plate 96well, 0.1ml Non skirted, White	20	5631	54902
650903	PCR plate 96well, 0.1ml, semi skirted, clear	20	5310	51773
650904	PCR plate 96well, 0.1ml, semi skirted, white	20	5631	54902
650905	PCR plate 96well, 0.2ml, non skirted, clear	20	5310	51773
650906	PCR plate 96well, 0.2ml, non skirted, white	20	5631	54902
650907	PCR plate 96well, 0.2ml, semi skirted, clear	20	5310	51773
650908	PCR plate 96well, 0.2ml, semi skirted, white	20	5631	54902
650909	PCR plate 96well, 0.1ml Raised-rim, Semi Skirted, clear	20	5631	54902
650910	PCR plate 96well, 0.2ml Raised-rim, Semi Skirted, clear	20	5631	54902

HSN CODE : 3926 9099



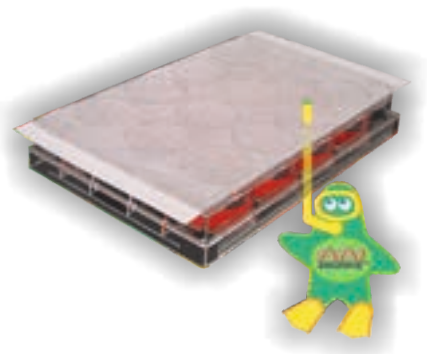

Air Seal (For Cell Culture Plates)

Air Seal is hydrophobic porous film with medical-grade adhesive suitable for Culture plates. Also known as Breathable Sealing Films and is most suitable where gas exchange is necessary for cell and bacterial growth.

Cat. No.	Description	Packing	Price/Pack
MCAS1000	Air Seal Sterile	50Pcs./Pack	4125

HSN CODE : 3919 9090

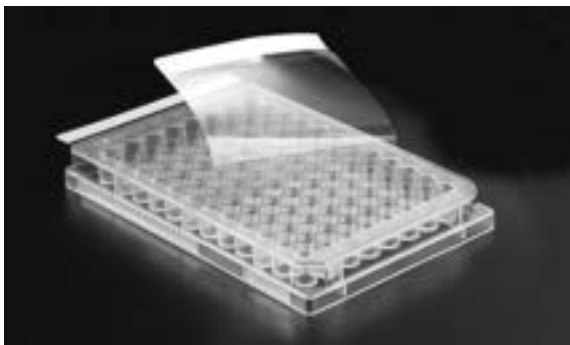

Thermal Seal (For PCR)

Thermal seal films are optimized for thermal cycling. High optical clarity provides superior performance for PCR and qPCR applications.

Cat. No.	Description	Packing	Price/Pack
MCTS1000	Thermal Seal Sterile	100Pcs./Pack	8850
MCTS2100	Thermal Seal Sterile	100Pcs./Pack	14562

HSN CODE : 3919 9090

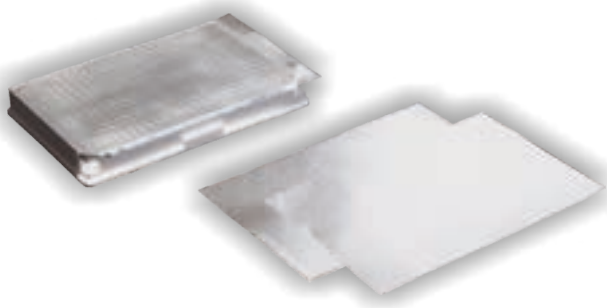

Aluminium Plate Seal

These Seals are Made up of soft non-permeable aluminum with strong medical-grade adhesive to eliminate the need for heat-sealing devices. These films protects samples from evaporation during thermal cycling & is best option for cold storage down to -80°C.

Cat. No.	Description	Packing	Price/Pack
MCAS96100	Aluminium Plate Seal 96 Sterile	100Pcs./Pack	12870

HSN CODE : 3919 9090

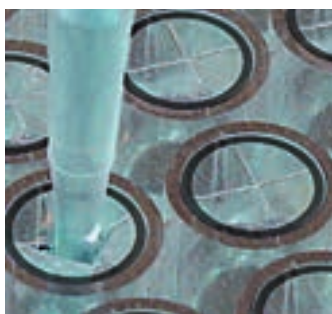

Zone-Free

Pierceable Sealing Films (For General Applications)

Zone-Free™ films feature adhesive-free top layer with a inert white polypropylene/adhesive sublayer. The easy-piercing top layer allows direct sample recovery with pipette tips without adhesive fouling and minimizes adhesive contact with samples.

X-Pierce™ films are designed for temporary protection of samples in multiwell plates. Precut "X" over each well creates four flaps that easily bend downward when pushed by pipette tip allowing sample access without adhesive fouling. The flaps return to their original position after sampling for continued protection.

Cat. No.	Description	Packing	Price/Pack
MCXZF1000	Zone Free Films Sterile	50Pcs./Pack	11235
MCXPF1000	X-pierce Films Sterile	100Pcs./Pack	10165

HSN CODE : 3919 9090



PCR Workbench

Best Workbench | Stackable | Compatible with PCR Tubes, Strips and all types of plates

Cat. No.	Description	Packing	Price/Pack	Price/10 Packs
MPCRRK02	PCR Workbench	5	1860	18135
HSN CODE : 3926 9099				



PCR Rack With Cover

Ideal PCR workstation | Suitable for PCR tubes, strips and Plate

Cat. No.	Description	Packing	Price/Pack	Price/10 Packs
MPCRRK01	PCR Rack With Cover	8	2575	25106
HSN CODE : 3926 9099				

Specifications	
Speed	2800rpm
Max. RCF	627g
Rotor Capacity	2 x 96 well PCR Plates
Rotor	Fixed vertically
Timer	1s 99 or touch operation
Voltage	AC 220V 50/60Hz, 40W
Dimensions	190x219x186mm
Net Weight	2.7kg



Mini Plate Centrifuge			
Cat. No.	Description	Packing	Price/Pack
MiniPC2800	PCR Plate Centrifuge	1	72000
HSN CODE : 8421 1910			



BIOSKIN™



Natural Rubber ~ Biodegradable | Slightly Powdered | Better Sensitivity & Better Elasticity than Nitrile gloves
 Balance of Comfort & Protection | Meets Standards for Medical Exam Use | Mfg according to Malaysian Standards
 Complies CE, ISO 9001, ISO 13485, ASTM Intl. Standards

Cat. No.	Description	Packing	Price/Pack
607098	Bioskin Latex Gloves, Small	100 Pcs./Box, 10 Box/Pack	6750
607099	Bioskin Latex Gloves, Medium	100 Pcs./Box, 10 Box/Pack	6750
607100	Bioskin Latex Gloves, Large	100 Pcs./Box, 10 Box/Pack	6750

HSN CODE : 4015 1200



ISO 9001:2008 ISO 13485:2003 HACCP



CAUTION: Components used in making gloves may cause allergic reaction in some individuals. If you Experience a reaction to this product, discontinue use and seek immediate medical advice.

* Actual Product Colour May Vary

NyTRO+™

PURPLE BLUE



100% Synthetic Super soft Nitrile | Latex Protein Free, Powder Free | Better sensitivity & Better Elasticity

Balance of Comfort & Protection | Light Weight Ensures Long term Use with less fatigue | Textured finger tips for excellent Grip Chemical Resistance

wide range of chemicals | Provides Precise Grip in both dry & Wet conditions

3 times puncture resistant to natural rubber gloves.

Complies CE, ISO 9001, ISO13485, HACCP, EN and ASTM Intl. Standards

Cat. No.	Description	Packing	Price/Pack
607201	NyTRO+ Purple Blue Nitrile Gloves, Small	100 Pcs./Box, 10 Box/Pack	9960
607202	NyTRO+ Purple Blue Nitrile Gloves, Medium	100 Pcs./Box, 10 Box/Pack	9960
607203	NyTRO+ Purple Blue Nitrile Gloves, Large	100 Pcs./Box, 10 Box/Pack	9960
607101-S	NyTRO+ Purple Blue Sterile Nitrile Gloves, Small	50 Pairs/Pack	2400
607102-S	NyTRO+ Purple Blue Sterile Nitrile Gloves, Medium	50 Pairs/Pack	2400
607103-S	NyTRO+ Purple Blue Sterile Nitrile Gloves, Large	50 Pairs/Pack	2400

HSN CODE : 4015 1200



CAUTION: Components used in making gloves may cause allergic reaction in some individuals. If you Experience a reaction to this product, discontinue use and seek immediate medical advice.

* Actual Product Colour May Vary

Tested for use with Chemotherapy Drugs. Gloves used for protection against Chemotherapy drugs exposure must be selected specifically for the type of Chemotherapy agent used. Users are recommended to review material safety data sheets for Chemotherapy Drugs being used to determine the required level of protection.

Nytro+7TM

PURPLE



100% Synthetic Super soft Nitrile | Latex Protein Free, Powder Free | Better sensitivity & Better Elasticity
 Balance of Comfort & Protection | Textured finger tips for excellent Grip Chemical Resistance wide range of chemicals | Provides Precise Grip in
 both dry & Wet conditions | 3 times puncture resistant to natural rubber gloves.
 Complies CE, ISO 9001, ISO13485, HACCP and ASTM Intl. Standards

Cat. No.	Description	Packing	Price/Pack
607198	Nyro+7 Nitrile Gloves, Small	100 Pcs./Box, 10 Box/Pack	10500
607199	Nyro+7 Nitrile Gloves, Medium	100 Pcs./Box, 10 Box/Pack	10500
607200	Nyro+7 Nitrile Gloves, Large	100 Pcs./Box, 10 Box/Pack	10500
Nyro+7S-S	Nyro+7 Sterile Nitrile Gloves, Small	50 Pairs/Pack	2940
Nyro+7M-S	Nyro+7 Sterile Nitrile Gloves, Medium	50 Pairs/Pack	2940
Nyro+7L-S	Nyro+7 Sterile Nitrile Gloves, Large	50 Pairs/Pack	2940

HSN CODE : 4015 1200

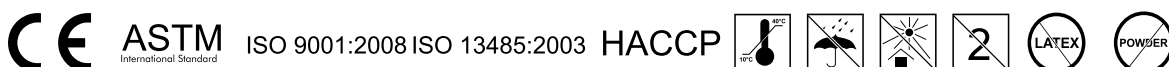

CAUTION: Components used in making gloves may cause allergic reaction in some individuals. If you Experience a reaction to this product, discontinue use and seek immediate medical advice.

* Actual Product Colour May Vary



Diamond Grip
nitrile gloves

NyTRO +9TM

ORANGE



100% Synthetic Super soft Nitrile | Latex Protein Free, Powder Free | Better sensitivity & Better Elasticity

Balance of Comfort & Protection | Diamond Pattern for Excellent grip | Chemical Resistance wide range of chemicals Provides Precise

Grip in both dry & Wet conditions | 3 times puncture resistant to natural rubber gloves.

Complies CE, ISO 9001, ISO13485, HACCP, EN and ASTM Intl. Standards

Cat. No.	Description	Packing	Price/Pack
607104	NyTRO+9 Orange Nitrile Gloves, Medium	100 Pcs./ Box, 10 Box/Pack	16800
607105	NyTRO+9 Orange Nitrile Gloves, Large	100 Pcs./ Box, 10 Box/Pack	16800
607106	NyTRO+9 Orange Nitrile Gloves, XL	100 Pcs./ Box, 10 Box/Pack	16800
607107	NyTRO+9 Orange Nitrile Gloves, XXL	100 Pcs./ Box, 10 Box/Pack	16800

HSN CODE : 4015 1200



ASTM
International Standard

ISO 9001:2015 ISO 13485:2016

EN455



HACCP



CAUTION: Components used in making gloves may cause allergic reaction in some individuals. If you Experience a reaction to this product, discontinue use and seek immediate medical advice.

* Actual Product Colour May Vary

Tested for use with Chemotherapy Drugs. Gloves used for protection against Chemotherapy drugs exposure must be selected specifically for the type of Chemotherapy agent used. Users are recommended to review material safety data sheets for Chemotherapy Drugs being used to determine the required level of protection.

nitrile gloves

Latex Free
Powder Free

Nytro+15™

Green Flocklined Glove



Thickness - 15mils Length - 13 Inch

Chemical Resistant | High Abrasion & Cut Resistant | Flocklined- Comfort from Inside | Excellent Sensitivity
Provides Excellent grip in both dry & Wet conditions

Cat. No.	Description	Packing	Price/Pair	Price/Pack
601532	Nytro+15 Flocklined Nitrile Gloves Medium	6Pair/Pack	200	1230
601533	Nytro+15 Flocklined Nitrile Gloves Large	6Pair/Pack	200	1230
601534	Nytro+15 Flocklined Nitrile Gloves Xtra large	6Pair/Pack	200	1230

HSN CODE : 4015 9030



ASTM
International Standard

ISO 9001:2008 ISO 13485:2003 HACCP



CAUTION: Components used in making gloves may cause allergic reaction in some individuals. If you Experience a reaction to this product, discontinue use and seek immediate medical advice.

* Actual Product Colour May Vary



Gloves Dispenser

Wall Hanging Design | Made from High Quality Acrylic
Available in 1 Place/2 Place/ 3 Place Format

Cat. No.	Description	Packing	Price/Pack
MCGD001	Glove Dispenser 1 Place	1	1407
MCGD002	Glove Dispenser 2 Place	1	2040
MCGD003	Glove Dispenser 3 Place	1	2715

HSN CODE : 3926 9099



Heat Resistant Grip and Gloves

Rhino Gloves are formulated from special grade silicone rubber which provides superior protection when handling hot or cold objects like flasks, beakers etc. These Gloves are available in two formats Grips & Gloves.

Non-Slip grip | Free Size. Fits All! | Flexible & Durable | Chemical Resistant
Temperatures Range -57°C to +250°C

Cat. No.	Description	Packing	Price/Pack	Price/6 Packs
MCSHP-Grip	Rhino Hand Grip	4 Pcs./Pack	2448	14321
MCSHP-Glove	Rhino Hand Glove	1Pairs/Pack	2127	12443

HSN CODE : 4015 9030

Cryo Gloves

Cryo Gloves Protect your hands when working with liquid nitrogen and other cryogenic hazards. These Gloves have multi layer insulation designed to provide protection to the hands and arms from the hazards encountered when working with ultra cold. They are light weight, flexible, durable, clean are very comfortable to wear for extended periods, and are extremely warm.

Cat. No.	Description	Packing	Price/Pack	Price/6 Packs
MCCG032M	EMROS Cryo Gloves, Wrist, Medium	1	14820	86697
MCCG032L	EMROS Cryo Gloves, Wrist, Large	1	14820	86697
MCCG038M	EMROS Cryo Gloves, Mid Arm, Medium	1	16935	99070
MCCG038L	EMROS Cryo Gloves, Mid Arm, Large	1	16935	99070
MCCG0048	EMROS Cryo Gloves, Elbow	1	20400	119340

HSN CODE : 6216 0090



Cryo Apron

Cat. No.	Description	Packing	Price/Pack	Price/6 Packs
MCCA0042	EMROS Cryo Apron, 42"	1	20940	122499
MCCA0048	EMROS Cryo Apron, 48"	1	22398	131028

HSN CODE : 6216 0090



* Note: These gloves are not intended for immersion in liquid nitrogen.

EMROS
Cryogenic Handling Products

> nexflo

Syringe filters

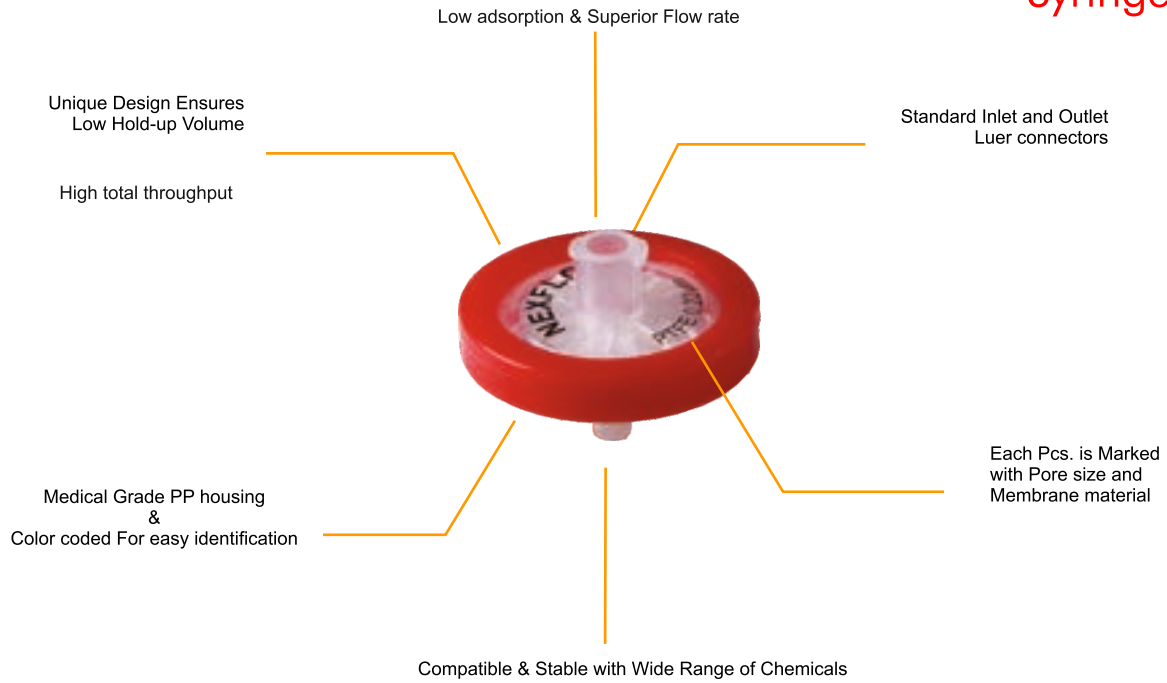

33mm Dia Syringe filters is Equipped with PP Prefilter

Membrane	NYLON
Dia	13mm, 25mm, 33mm
Pore Size	0.22um & 0.45um
Nature	Hydrophilic
Features	Strong tenacity & Absorbability
Applications	Aqueous solutions, Electronic Industry Cell & Tissue culture Media Filtration Beverage Industry & Other Liquid Filtration High-purity chemicals & Chemical Industry

Membrane	PES
Dia	13mm, 25mm, 33mm
Pore Size	0.22um & 0.45um
Nature	Hydrophilic
Features	High flow rate, Lowest protein binding.
Applications	Pharma Companies Test Equipments, Pharma Equipments, Sterile Filtration & Biochemistry Equipments

Membrane	PVDF
Dia	13mm, 25mm, 33mm
Pore Size	0.22um & 0.45um
Nature	Hydrophilic & Hydrophobic
Features	Good heat endurance & Chemical Stability
Applications	Gas & Vapor filtration High-temperature Liquid Filtration
Hydrophobic	Aseptic Filtration of Reagents Cell & Tissue culture Media Raw Chemical filtration High-temperature Liquid filtration
Hydrophilic	

Membrane	PTFE
Dia	13mm, 25mm, 33mm
Pore Size	0.22um & 0.45um
Nature	Hydrophilic & Hydrophobic
Features	Hydrophobic : Compatible & Stable with Wide Range of Chemicals Hydrophilic : Low Protein binding , HPLC certified for low levels of UV-absorbing extractable; High flow rates with minimal aqueous extractable
Applications	Filtration of Organic solvents specially for the Strong solvent which other membranes cannot do.





Nexflo Syringe Filters

Cat. No.	Membrane	Dia	Pore Size	Packing	Price /Pack	Price/20Pack
NXSFN1322	NYLON	13mm	0.22um	100	2226	43407
NXSFN1345			0.45um	100	2226	43407
NXSFN2522		25mm	0.22um	100	2859	55751
NXSFN2545			0.45um	100	2859	55751
NXSFN3322		33mm	0.22um	100	4890	95355
NXSFN3345			0.45um	100	4890	95355
NXSFPVDF1322	PVDF Hydrophobic	13mm	0.22um	100	2859	55751
NXSFPVDF1345			0.45um	100	2859	55751
NXSFPVDF2522		25mm	0.22um	100	3621	70610
NXSFPVDF2545			0.45um	100	3621	70610
NXSFPVDF3322		33mm	0.22um	100	5400	105300
NXSFPVDF3345			0.45um	100	5400	105300
NXSFPTE1322	PTFE Hydrophobic	13mm	0.22um	100	2859	55751
NXSFPTE1345			0.45um	100	2859	55751
NXSFPTE2522		25mm	0.22um	100	3621	70610
NXSFPTE2545			0.45um	100	3621	70610
NXSFPTE3322		33mm	0.22um	100	5400	105300
NXSFPTE3345			0.45um	100	5400	105300
NXSFPES1322	PES	13mm	0.22um	100	2859	55751
NXSFPES1345			0.45um	100	2859	55751
NXSFPES2522		25mm	0.22um	100	3621	70610
NXSFPES2545			0.45um	100	3621	70610
NXSFPES3322		33mm	0.22um	100	5400	105300
NXSFPES3345			0.45um	100	5400	105300
NXSFPVDF1322L	PVDF Hydrophilic	13mm	0.22um	100	6291	122675
NXSFPVDF1345L			0.45um	100	6291	122675
NXSFPVDF2522L		25mm	0.22um	100	7749	151106
NXSFPVDF2545L			0.45um	100	7749	151106
NXSFPTE1322L	PTFE Hydrophilic	13mm	0.22um	100	6291	122675
NXSFPTE1345L			0.45um	100	6291	122675
NXSFPTE2522L		25mm	0.22um	100	7749	151106
NXSFPTE2545L			0.45um	100	7749	151106

HSN CODE : 8421 2900



Nexflo Syringe Filters Sterile

Cat. No.	Membrane	Dia	Pore Size	Packing	Price /Pack	Price/20Pack
NXSFN1322-1	NYLON	13mm	0.22um	100	4245	82778
NXSFN1345-1			0.45um	100	4245	82778
NXSFN2522-1		25mm	0.22um	100	4851	94595
NXSFN2545-1			0.45um	100	4851	94595
NXSFN3322-1		33mm	0.22um	100	6669	130046
NXSFN3345-1			0.45um	100	6669	130046
NXSFVDF1322-1	PVDF Hydrophobic	13mm	0.22um	100	4851	94595
NXSFVDF1345-1			0.45um	100	4851	94595
NXSFVDF2522-1		25mm	0.22um	100	5457	106412
NXSFVDF2545-1			0.45um	100	5457	106412
NXSFVDF3322-1		33mm	0.22um	100	7275	141863
NXSFVDF3345-1			0.45um	100	7275	141863
NXSFPTFE1322-1	PTFE Hydrophobic	13mm	0.22um	100	4851	94595
NXSFPTFE1345-1			0.45um	100	4851	94595
NXSFPTFE2522-1		25mm	0.22um	100	5457	106412
NXSFPTFE2545-1			0.45um	100	5457	106412
NXSFPTFE3322-1		33mm	0.22um	100	7275	141863
NXSFPTFE3345-1			0.45um	100	7275	147713
NXSFPEPES1322-1	PES	13mm	0.22um	100	4851	94595
NXSFPEPES1345-1			0.45um	100	4851	94595
NXSFPEPES2522-1		25mm	0.22um	100	5457	106412
NXSFPEPES2545-1			0.45um	100	5457	106412
NXSFPEPES3322-1		33mm	0.22um	100	7275	141863
NXSFPEPES3345-1			0.45um	100	7275	141863

HSN CODE : 8421 2900



Nexflo+ Premium 4mm Syringe Filters

Cat. No.	Membrane	Dia	Pore Size	Packing	Price /Pack
NXSFN422	NYLON	4mm	0.22um	200	POR
NXSFN445			0.45um	200	POR
NXSFPVDF422	PVDF Hydrophobic	4mm	0.22um	200	POR
NXSFPVDF445			0.45um	200	POR
NXSFPTE422	PTFE Hydrophobic	4mm	0.22um	200	POR
NXSFPTE445			0.45um	200	POR
NXSFPES422	PES	4mm	0.22um	200	POR
NXSFPES445			0.45um	200	POR
NXSFPVDF422L	PVDF Hydrophillic	4mm	0.22um	200	POR
NXSFPVDF445L			0.45um	200	POR
NXSFPTE422L	PTFE Hydrophillic	4mm	0.22um	200	POR
NXSFPTE445L			0.45um	200	POR

HSN CODE : 8421 2900



Nexflo 50mm Gas Filter

Inlet/ Outlet : Stepped Hose Barb | PTFE Membrane & Polypropylene housing have broad chemical resistance | Autoclavable
 Large Filter Area ensures high flow rate | Ideal for Sterilizing Gases -venting sterile bottles, Sterilizing Organic Solutions,
 In-line sterilization & particulate removal from air and gases

Cat. No.	Membrane	Dia	Pore Size	Sterile	Packing	Price/Pack
NXGFPTFE5022	PTFE	50mm	0.22um	N	20	19185
NXGFPTFE5045			0.45um	N	20	19185
NXGFPTFE5022-1	PTFE	50mm	0.22um	S	20	21597
NXGFPTFE5045-1			0.45um	S	20	21597

HSN CODE : 8421 2900



Nexflo Membrane Filters

Cat. No.	Membrane	Dia	Pore Size	Sterile	Packing	Price/Pack
NXMFMCE4745	MCE	47mm	0.45um	N	200	4446
NXMFMCE4722			0.22um	N	200	4446
NXMFCA4745	CA	47mm	0.45um	N	200	7623
NXMFCA4722			0.22um	N	200	7623
NXMFN4745	Nylon	47mm	0.45um	N	200	4446
NXMFN4722			0.22um	N	200	4446
NXMFPE4745	PES	47mm	0.45um	N	200	7623
NXMFPE4722			0.22um	N	200	7623
NXMFPTFE4745	PTFE Hydrophobic	47mm	0.45um	N	200	7623
NXMFPTFE4722			0.22um	N	200	7623
NXMFVDF4745	PVDF Hydrophobic	47mm	0.45um	N	200	7623
NXMFVDF4722			0.22um	N	200	7623
NXMFPTFE4745L	PTFE Hydrophilic	47mm	0.45um	N	200	18420
NXMFPTFE4722L			0.22um	N	200	18420
NXMFVDF4745L	PVDF Hydrophilic	47mm	0.45um	N	200	18420
NXMFVDF4722L			0.22um	N	200	18420
NXMFN9045	Nylon	90mm	0.45um	N	50	9600
NXMFN9022			0.22um	N	50	9600
NXMFPE9045	PES	90mm	0.45um	N	50	15000
NXMFPE9022			0.22um	N	50	15000
NXMFPTFE9045	PTFE Hydrophobic	90mm	0.45um	N	50	15000
NXMFPTFE9022			0.22um	N	50	15000
NXMFVDF9045	PVDF Hydrophobic	90mm	0.45um	N	50	15000
NXMFVDF9022			0.22um	N	50	15000



Nexflo MCE Gridded Membrane Filters

Mixed Cellulose Ester is Composition of Cellulose Acetate and Cellulose Nitrate | Non Toxic Ink to Print Grid lines
Grid Lines Spaced at 3.1mm Intervals | Clear contrast for easier detection

Applications: Colony counting | General Microscopy | Particulate counting and analysis

Industries: Bottled Water | Food & Beverage (Beer, Wine, carbonated drinks, etc.) | Environmental | Cosmetics | Pharmaceutical

Cat. No.	Membrane	Dia	Pore Size	Sterile	Packing	Price/Pack	Price/20Pack
NXMFGMCE4745	45 Grid Hydrophilic	47mm	0.45um	S	100	2424	47268
NXMFGMCE4722			0.22um	S	100	2424	47268

HSN CODE : 8421 2900

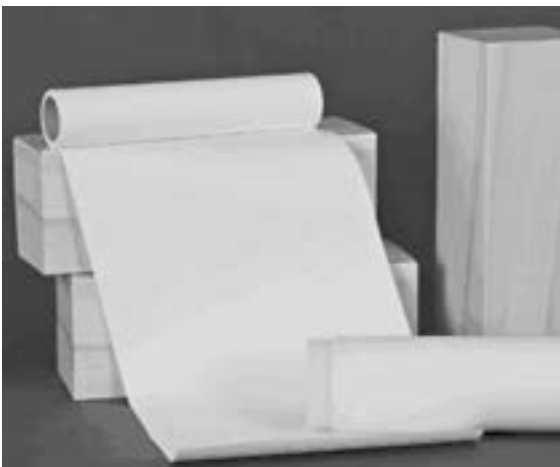

Nexflo Blotting Membranes

Cat. No.	Description	Packing	Price/Pack
NXBM30NC022	Nitro Cellulose 0.22um 30cmx300cm	1	30900
NXBM30NC045	Nitro Cellulose 0.45um 30cmx300cm	1	30900
NXBM30PVDF022	PVDF 0.22um 30cmx300cm	1	34620
NXBM30PVDF045	PVDF 0.45um 30cmx300cm	1	34620

HSN CODE : 8421 2900



Technical Details (Qualitative Filter Paper)

Grade	Basic Weight (g/m ²)	Filter Speed (s)	Wet Bursting Strength (≥ mm H ₂ O)	Ash Content (<%)	Pore Size (μ m)
Grade 4 Fast	80 ± 4	≤ 35	120	0.15	20 ~ 25
Grade 1 Medium		≤ 70	140		15 ~ 20
Grade 5 Slow		≤ 140	180		10 ~ 15

Nexflo Filter Papers (Qualitative)

Cat. No.	Size (mm)	Packing	Price Box	Price /Pack	Price/ 10 Case
QUALITATIVE Fast Grade 4					
NXFPQLG490	90	100 Pcs/Box, 5Box/Case	423.00	2115	20621
NXFPQLG4110	110	100 Pcs/Box, 5Box/Case	592.20	2961	28870
NXFPQLG4125	125	100 Pcs/Box, 5Box/Case	712.80	3564	34749
NXFPQLG4150	150	100 Pcs/Box, 5Box/Case	917.40	4587	44723
QUALITATIVE Medium Grade 1					
NXFPQLG190	90	100 Pcs/Box, 5Box/Case	423.00	2115	20621
NXFPQLG1110	110	100 Pcs/Box, 5Box/Case	592.20	2961	28870
NXFPQLG1125	125	100 Pcs/Box, 5Box/Case	712.80	3564	34749
NXFPQLG1150	150	100 Pcs/Box, 5Box/Case	917.40	4587	44723
QUALITATIVE Slow Grade 5					
NXFPQLG590	90	100 Pcs/Box, 5Box/Case	423.00	2115	20621
NXFPQLG5110	110	100 Pcs/Box, 5Box/Case	592.20	2961	28870
NXFPQLG5125	125	100 Pcs/Box, 5Box/Case	712.80	3564	34749
NXFPQLG5150	150	100 Pcs/Box, 5Box/Case	917.40	4587	44723

HSN CODE : 4823 2000



Technical Details (Quantitative Filter Paper)

Grade	Basic Weight (g/m ²)	Filter Speed (s)	Wet Bursting Strength (≥ mm H ₂ O)	Ash Content (<%)	Pore Size (μ m)
Grade 41 Fast	80 ± 4	≤ 35	120	0.01	20 ~ 25
Grade 40 Medium		≤ 70	200		15 ~ 20
Grade 42 Slow		≤ 140	280		10 ~ 15

Nexflo Filter Papers (Quantitative)

Cat. No.	Size (mm)	Packing	Price Box	Price Pack	Price/ 10 Case
QUANTITATIVE Fast Grade 41					
NXFPQTG4190	90	100 Pcs/Box, 5Box/Case	1264.80	6324	61659
NXFPQTG41110	110	100 Pcs/Box, 5Box/Case	1771.20	8856	86346
NXFPQTG41125	125	100 Pcs/Box, 5Box/Case	2214.00	11070	107933
NXFPQTG41150	150	100 Pcs/Box, 5Box/Case	2776.20	13881	135340
QUANTITATIVE Medium Grade 40					
NXFPQTG4090	90	100 Pcs/Box, 5Box/Case	1264.80	6324	61659
NXFPQTG40110	110	100 Pcs/Box, 5Box/Case	1771.80	8856	86346
NXFPQTG40125	125	100 Pcs/Box, 5Box/Case	2214.00	11070	107933
NXFPQTG40150	150	100 Pcs/Box, 5Box/Case	2776.20	13881	135340
QUANTITATIVE Slow Grade 42					
NXFPQTG4290	90	100 Pcs/Box, 5Box/Case	1264.80	6324	61659
NXFPQTG42110	110	100 Pcs/Box, 5Box/Case	1771.20	8856	86346
NXFPQTG42125	125	100 Pcs/Box, 5Box/Case	2214.00	11070	107933
NXFPQTG42150	150	100 Pcs/Box, 5Box/Case	2776.20	13881	135340

HSN CODE : 4823 2000



Easy to use
Individual Packing
Both upper and lower cups have engraved graduations
2 Membrane material available PVDF & NYLON

Vacuum Filtration Apparatus

MOXCARE Vacuum filtration apparatus are useful to purify large volume samples efficiently in easy and fast manner. The filters are ultrasonically weld in the upper cup of apparatus and bottle has a wide mouth for efficient handling. Both Upper and lower cups have graduations.

Cat. No.	Membrane	Pore Size	Capacity (ml)	Packing	Price/Pack
MCVFA145150-3	Nylon	0.45um	150	1	POR

HSN CODE : 8421 2900



Hand Vacuum Pump

Light weight | Ideal for fast filtration | Very Easy to Use | Attain vacuum of 25"

Cat. No.	Description	Packing	Price/Pack
MCHVP0001	Hand Operated Vacuum Pump	1	11550

HSN CODE : 8414 1000



Vacuum Pump

Cat. No.	Description	Packing	Price/Pack
MCDVP10	Diaphragm Oilless Vacuum Pump (10L/Min Vacuum 200mbar)	1	35100
MCDVP40	Diaphragm Oilless Vacuum Pump (40L/Min Vacuum 500mbar)	1	56400
MCOLVP25	Piston Oilless Vacuum Pump (25L/Min Vacuum 200mbar)	1	47400
MCOLVP40	Piston Oilless Vacuum Pump (40L/Min Vacuum 500mbar)	1	70200

HSN CODE : 8414 1000



Manifolds Vacuum Filtration Apparatus

Cat. No.	Description	Packing	Price/Pack
MCMVFA03G	Manifolds Vacuum Filtration Glass - 3 Unit	1	POR
MCMVFA06G	Manifolds Vacuum Filtration Glass - 6 Unit	1	POR
MCMVFA03SS	Manifolds Vacuum Filtration Stainless Steel 316L - 3 Unit	1	POR
MCMVFA06SS	Manifolds Vacuum Filtration Stainless Steel 316L - 6 Unit	1	POR

Glass HSN CODE : 8421 2900

S.S. HSN CODE : 8421 2900



Vacuum Filtration Apparatus- Glass

Easy to use | Autoclavable | Made from High Quality Borosilicate Glass

Cat. No.	Description	Packing	Price/Pack
MCMFH471000	47mm Holder Assembly 300ml Funnel, 1000ml Flask	1	9000
MCMFH472000	47mm Holder Assembly 300ml Funnel, 2000ml Flask	1	15000

HSN CODE : 8421 2900

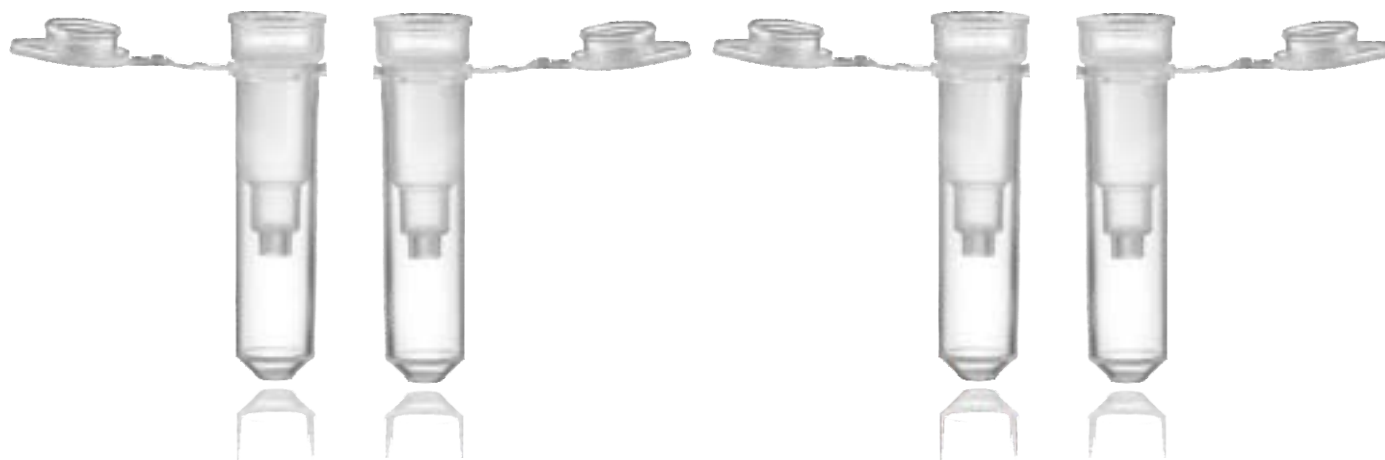

Nexflo Spin Columns

Cat. No.	Description	Packing	Price/Pack
NXSCGF0703	3 Layers of Glass Fiber Membrane 0.7um	100	3900
NXSCGF0704	4 Layers of Glass Fiber Membrane 0.7um	100	4680
NXSCGF0705	5 Layers of Glass Fiber Membrane 0.7um	100	5382

HSN CODE : 8421 2900



Nexflo Centrifuge Ultrafiltration Tube

Cat. No.	Description	Packing	Price/Pack
NXUFTPES315	Centrifugal Filter Unit, 3Kda PES 15ml	24	POR
NXUFTPES515	Centrifugal Filter Unit, 5Kda PES 15ml	24	POR
NXUFTPES1015	Centrifugal Filter Unit, 10Kda PES 15ml	24	POR
NXUFTPES3015	Centrifugal Filter Unit, 30Kda PES 15ml	24	POR
NXUFTPES5015	Centrifugal Filter Unit, 50Kda PES 15ml	24	POR
NXUFTPES10015	Centrifugal Filter Unit, 100Kda PES 15ml	24	POR
NXUFTPES50015	Centrifugal Filter Unit, 500Kda PES 15ml	24	POR
NXUFTRC315	Centrifugal Filter Unit, 3Kda RC 15ml	24	POR
NXUFTRC515	Centrifugal Filter Unit, 5Kda RC 15ml	24	POR
NXUFTRC1015	Centrifugal Filter Unit, 15Kda RC 15ml	24	POR
NXUFTRC3015	Centrifugal Filter Unit, 30Kda RC 15ml	24	POR
NXUFTRC5015	Centrifugal Filter Unit, 50Kda RC 15ml	24	POR
NXUFTRC10015	Centrifugal Filter Unit, 100Kda RC 15ml	24	POR
NXUFTRC50015	Centrifugal Filter Unit, 500Kda RC 15ml	24	POR

RC - Regenerated Cellulose Membrane

HSN CODE : 8421 2900



Autosampler Vials

9mm Screw Vials

Cat. No.	Capacity	Size	Description	Packing	Price/Pack
11632	2ml	12x32mm	9mm Clear Glass Screw Vial	100	POR
11633	2ml	12x32mm	9mm Clear Glass Screw Vial, With Printed Write on Area	100	POR
11634	2ml	12x32mm	9mm Amber Glass Screw Vial	100	POR
11635	2ml	12x32mm	9mm Amber Glass Screw Vial, With Printed Write on Area	100	POR

Compatible Caps

11636	9mm, Blue PP Screw Cap White PTFE/ Red Silicon Septa			100	POR
11637	9mm, Blue PP Screw Cap Pre-Slit PTFE Red /White Silicon Septa			100	POR

11mm Snap Cap Vials

Cat. No.	Capacity	Size	Description	Packing	Price/Pack
11638	2ml	12x32mm	11mm Clear Glass Snap Vial	100	POR
11639	2ml	12x32mm	11mm Clear Glass Snap Vial, With Printed Write on Area	100	POR
11640	2ml	12x32mm	11mm Amber Glass Snap Vial	100	POR
11641	2ml	12x32mm	11mm Amber Glass Snap Vial, With Printed Write on Area	100	POR

Compatible Caps

11642	11mm, Natural PP Snap Cap White PTFE/ Red Silicon Septa			100	POR
-------	---	--	--	-----	-----

11mm Crimp Neck Vials

Cat. No.	Capacity	Size	Description	Packing	Price/Pack
11643	2ml	12x32mm	11mm Clear glass Crimp Vial	100	POR
11644	2ml	12x32mm	11mm Amber glass Crimp Vial	100	POR

Compatible Caps

11645	11mm Aluminum Crimp Cap White PTFE/ Red Silicon Septa			100	POR
-------	---	--	--	-----	-----

HSN CODE : 7017 9090

Headspace vials

Cat. No.	Description	Packing	Price/Pack
11646	10ml Clear Glass Crimp-top Headspace Vial, Flat Bottom	100	POR
11647	10ml Clear Glass Crimp-top Headspace Vial, Round Bottom	100	POR
11648	20ml Clear Glass Crimp-top Headspace Vial, Flat Bottom	100	POR
11649	20ml Clear Glass Crimp-top Headspace Vial, Round Bottom	100	POR
11650	20mm Aluminium Snap Cap White PTFE/ Red Silicon Septa	100	POR

HSN CODE : 7017 9090





Parafilm Dispenser

Parafilm			
Cat. No.	Description	Packing	Price/Pack
MCPF02250	Parafilm 2"x250'	1	3174
MCPF04125	Parafilm 4"x125'	1	2985
MCPFD001	Parafilm Dispenser Acrylic	1	3192

Parafilm HSN CODE : 3920 9919 Parafilm Dispenser HSN CODE : 3926 9099

Sample Bags

Moxcare Sample Zip lock bags are made from low density polyethylene material. These high strength bags can be used for Storage and transportation of samples. These bags are ideal choice for small lab samples, food or botanical samples etc.



Cat. No.	Description	Packing	Price/Pack
MCZLB01	Size 6"x8"	100	621
MCZLB02	Size 8.5"x12.5"	100	1020
MCZLB03	Size 10.5"x14"	100	1638
MCZLB01	Size 6"x8" Sterile	100	807
MCZLB02	Size 8.5"x12.5" Sterile	100	1329
MCZLB03	Size 10.5"x14" Sterile	100	2130

HSN CODE : 3923 2100



Safety Goggles

Lightweight | Ultra Clear Lens | Polycarbonate lens | 99.9% UV protection

Cat. No.	Description	Packing	Price/Pack
MCSGX01	Safety Goggles	2	744
MCSGB01	Safety Goggles Box	1	1053

Safety Goggles HSN CODE : 9004 9090

Safety Goggle Box HSN CODE : 3926 9099



Sharps Container

Cat. No.	Capacity (L)	Packing	Price/Pack
MCSC0001	Sharps Container 1L Benchtop Model	6	960
MCSC0005	Sharps Container 5L	24	8640
MCSC015	Sharps Container 10L	24	15312

HSN CODE : 3923 1090



Lab Utility Tray

Cat. No.	Description	Packing	Price/Pack
MCUT01	Utility Tray 350x275x75 (mm)	6	2217
MCUT02	Utility Tray 360x310x125 (mm)	6	4398

HSN CODE : 3926 9099



Beta Radiation Shield

Moxcare Beta shield is made of thick acrylic having thickness 10mm. BRS is designed to handle β -emitting isotopes. Sturdy Angled Design with High transparency allows clear view of the Samples located behind the shield.

Cat. No.	Description	Packing	Price/Pack
MCBS0045	Beta Radiation Shield 45x30x30cm	1	8130

HSN CODE : 3926 9099

Pipette Stand Vertical

Material : PP

Cat. No.	Description	Packing	Price/Pack
MCSPSV	28 Place	2	1359

HSN CODE : 3926 9099



Pipette Stand Horizontal

Material : PP

Cat. No.	Description	Packing	Price/Pack
MCSPSH	12 Place	6	1167

HSN CODE : 3926 9099



Retort Stand

Cat. No.	Description	Packing	Price/Pack
MCRT2215	Size 22x15cm	1	663
MCRT3020	Size 30x20cm	1	1107

HSN CODE : 3926 9099





Burette & Burette Clamp

Material : PP

Cat. No.	Description	Packing	Price/Pack
MCBT25	Burette 25ml	10	4434
MCBT50	Burette 50ml	10	5175
MCBCS1	Single	6	513
MCBCD2	Double	6	1035

HSN CODE : 3926 9099



Funnel

Cat. No.	Description	Packing	Price/Pack	Price/20 Packs
MCFNL62	62mm	36	612	11934
MCFNL75	75mm	36	639	12461
MCFNL100	100mm	18	585	11408

Funnel Holder

Cat. No.	Description	Packing	Price/Pack
MCFHS	Funnel Holder Single	6	576
MCFHD	Funnel Holder Double	6	1167

HSN CODE : 3926 9099



Separator Funnel

Cat. No.	Description	Packing	Price/Pack
MCSPF250	Separator Funnel 250ml	2	813
MCSPF500	Separator Funnel 500ml	2	1020
MCSPFH	Separator Funnel Holder	6	696

HSN CODE : 3926 9099

Specifications	MCVSO02	MCVSR10	MCBS3D5
Motion	Orbital	Rocking	3-D
Orbit Dia/Tilt Angle	22mm	9° (7°-12°)	9° (7°-12°)
Max. Load	2.5kg	10kg	5kg
Speed Range	40-350 RPM	10-80 RPM	10-80 RPM
Motor	DC Motor		
Time	1min-19h 59min	1min-19h 59min	1min-19h 59min
Speed Display	LCD	LCD	LCD
Timer Display	LCD	LCD	LCD
Power	20W	40W	40W
Dimension of Platform	315x315mm	280x320mm	280x320mm
Dimensions	420x360x125mm	420x355x180mm	420x355x180mm
Weight	7kg	11.5kg	12kg
Permissible ambient temp. & Humidity	5-40°C, 80%		

- Bright Backlit LCD Display
- 3 Options Available - Orbital/Rocking/3D
- Sturdy & Compact Design
- Maintenance Free Brushless DC Motor
- Dual LCD for Display of Speed and Time



Virtue Pro Shakers

Cat No.	Description	Price
MCVSO02	Virtue Pro Orbital Shaker (Includes Flat Platform)	48000
MCVSR10	Virtue Pro Rocking Shaker (Includes Flat Platform)	58500
MCVS3D5	Virtue Pro 3D Shaker (Includes Flat Platform)	58500
MCVSC-1	Acrylic Cover for MCVSO02	4611
Acrylic Cover	HSN CODE : 3926 9099	Virtue Shaker HSN CODE : 8479 8200



Specifications	
Motion	Orbital
Orbit Dia/Tilt Angle	10mm
Max. Load	7.5kg
Speed Range	100-500 RPM /40-300RPM
Motor	Brushless DC Motor
Time	1min-19h 59min
Speed Display	Bright Backlit LCD
Timer Display	Bright Backlit LCD
Power	35W
Available Platform	Flat / Universal with Bars
Dimensions / Net Weight	420x360x100mm / 13Kg
Permissible ambient temp. & Humidity	5-40°C, 80%

- Bright Backlit LCD Display
- Sturdy & Compact Design
- Maintenance Free Brushless DC Motor
- Dual LCD for Display of Speed and Time



Virtue Pro Orbital Shaker (Load Capacity 7.5kg)

Cat No.	Description	Price
MCVSO75	Virtue Pro Orbital Shaker (Load Capacity 7.5kg)	105000
MCVSUP01	Universal Platform with Adjustable Bars	15300

HSN CODE : 8479 8200



Flat Platform (Included with Equipment)



Universal Platform With Adjustable Bars

Specifications	OS-20L	OS-40L
Speed range	100-2500RPM	100-2500RPM
Speed display	Backlit LCD Display	
Maximum Volume H2O	20L	40L
Motor	Brushless DC Motor	
Motor Output	600W	800W
Max. Torque	60nm	
Viscosity MAX	10,000mpas	50,000mpas
Timer	Yes	
Plate Size	200×300mm	
Plate Load	50kg	
Permissible Ambient Temperature	5 - 40°C	
Permissible Relative Humidity	80%	
Protection Class	IP42	
Voltage, Frequency	200 -240V, 50 Hz	
Dimensions	115×95×240mm	
Weight	6kg	7Kg



- Brushless Motor
- Heavy Base provides Stable design
- 20Lt. & 40Lt. Capacity Model Available
- Large Backlit LCD Display
- Variable Speed upto 2500 RPM
- Digital timer allows unsupervised operation
- Microprocessor Ensures accurate temperature control

Overhead Stirrer

Cat No.	Description	Price
OS20L	Overhead Stirrer 20Lt. (Price Includes Stand & Stainless Steel Cross Shaft)	70500
OS40L	Overhead Stirrer 40Lt. (Price Includes Stand & Stainless Steel Cross Shaft)	83400
OS-20 PTFE330	Accessory Straight stirrer PTFE coated (330x63mm)	5100
OS-20 PTFE400	Accessory Straight stirrer PTFE coated (400x80mm)	5100

HSN CODE : 8479 8200

Specifications	MCMiniDB1	MCMiniDBPro
Temperature Control Range	RT + 5°C-100°C	- 10°C-100°C
Temperature Max. Decrease	/	R.T. - 25°C
Temperature Stability @ 100°C	≤ ± 0.5°C	≤ ± 0.5°C
Temperature Stability @ 40°C	≤ ± 0.3°C	≤ ± 0.3°C
Block Temperature Uniformity	≤ ± 0.3°C	≤ ± 0.3°C
Temperature Display Accuracy	0.1°C	0.1°C
Heating Speed	≤ 15min (20°C to 100°C)	≤ 15min (20°C to 100°C)
Cooling Speed	Natural Cooling	≤ 30min (R.T. to 4°C) @ R.T. 26°C
Heating Cover	Yes	Yes
Time Range	1sec ~ 999sec or 1min ~ 1001min	1sec ~ 999sec or 1min ~ 1003min
Voltage / Power	DC24V adapter, 60W	DC24V adapter , 120W
Dimension (WxDxH)	110x156x97mm	110x156x108mm
Net Weight	1kg	1.4kg



- World's Smallest Dry Bath
- Smallest! Fits in the palm of your hand
- Economically priced & Easy to Use
- Exchangeable Blocks from 0.2 to 50ml
- Digital Temp. control Improves temp. Uniformity
- Used advanced thermoelectric technique
- Display with Simultaneous time and temp.
- Beep Sound After program Completion

Mini Dry Bath		
Cat No.	Description	Price
MCMiniDB1	Mini Dry Bath (RT+5°C to 100°C)	26700
MC-MiniDB Pro	Mini Dry Bath (-10 to100°C)	81000
MC-DB102	Block For Dry Bath 40 x 0.2ml	7200
MC-DB105	Block For Dry Bath 24 x 0.5ml	7200
MC-DB11520	Block For Dry Bath 15 x 1.5ml/2ml	7200
MC-DB115	Block For Dry Bath 4 x 15ml	8100
MC-DB150	Block For Dry Bath 2 x 50ml	8100

HSN CODE : 8419 8990



Specifications	MCMXDB1	MCMXDB2
Temperature Control Range	R.T. + 5°C - 150°C	R.T. + 5°C - 150°C
Temperature Setting Range	5°C - 150°C	5°C - 150°C
Temperature Stability @ 40 ~ 100°C	≤ ± 0.5°C	≤ ± 0.5°C
Temperature Stability @ > 100°C	≤ ± 1°C	≤ ± 1°C
Block Temperature Uniformity @ 40°C	≤ ± 0.3°C	≤ ± 0.3°C
Block Temperature Uniformity @ > 100°C	≤ ± 0.5°C	≤ ± 0.5°C
Temperature Display Accuracy	0.1°C	0.1°C
Heating Speed	≤ 30min(20°C to 150°C)	≤ 30min(20°C to 150°C)
Time Range	1min - 99h59min / Continuous	1min - 99h59min / Continuous
Sample Capacity	1 Block	2 Blocks
Voltage / Power	AC 220V/AC 110V,50.60Hz / 200W	AC 220V/AC 110V,50.60Hz / 400W
Dimension (WxDxH)	200x230x95mm	220x260x95mm
Net Weight	2.6 kg	3.3 kg



Maxi Dry Bath

Cat No.	Description	Price
MCMXDB1	Maxi Dry Bath (RT +5°C to 150°C)	47400
MCMXDB2	Maxi Dry Bath Dual Block (RT +5°C to 100°C)	60000
MCMXB02	Block For Dry Bath 48 x 0.2ml	10500
MCMXB05	Block For Dry Bath 42 x 0.5ml	10500
MCMXB152	Block For Dry Bath 24 x 1.5ml	10500
MCMXB20	Block For Dry Bath 24 x 2ml	10500
MCMXB15	Block For Dry Bath 12 x 15ml	10500
MCMXB50	Block For Dry Bath 4 x 50ml	10500
MCMXB96	Block For 96 Well Plates	14100

HSN CODE : 8419 8990



- Bright LED Display
- Easy user interface
- In-Built Over temperature protection
- In-Built Automatic fault detection
- Individual control for both blocks

Specifications	
Display	LED
Temperature Control Range	Heating: RT+5°C - 105°C Cooling: -10°C - 105°C
Temperature Max. Decrease	R.T. - 20°C
Temperature Setting Range	5°C - 105°C / -10°C - 100°C
Temperature Stability@100°C	≤ ± 0.5°C
Temperature Stability@40°C	≤ ± 0.3°C
Block Temperature Uniformity	≤ ± 0.3°C
Temperature Display Accuracy	0.1°C
Heating Speed	≤15min (20°C to 100°C)
Cooling Speed	≤25min (R.T. to 4°C) @ R.T.26°C
Time Range	1min-99h59min / Continuous
Voltage / Power	AC 220V, 50/60Hz / 170W
Dimensions (WxDxH)	240 x 260 x 168mm
Net Weight	2.6 kg



Maxi Dual Temperature Dry Bath

Cat No.	Description	Price
MCMXDBHC	Maxi Dry Bath Heating + Cooling	129000
MCMXHCB02	Block For Maxi Dual Dry Bath 24 x 0.2ml	3546
MCMXHCB05	Block For Maxi Dual Dry Bath 12 x 0.5ml	3546
MCMXHCB152	Block For Maxi Dual Dry Bath 6 x 1.5ml/2ml	3546
MCMXHCB15	Block For Maxi Dual Dry Bath 6 x 15ml	8454
MCMXHCB50	Block For Maxi Dual Dry Bath 3 x 50ml	8454
MCMXHCB96	Block For Maxi Dual Dry Bath 96 Well Plates	14190

HSN CODE : 8419 8990



- Compact size
- Excellent Temperature uniformity
- Built-in Cover Switch
- Perfect for low capacity application
- Brushless DC motor ensures smooth operation
- Beeps when Program Completes
- Temperature Protection

Specifications	
Speed Range	50-300 RPM
Shaking Orbit	20mm
Temperature Range	RT+5°C-60°C
Display Accuracy	±0.1°C
Timer	1min-999min
Display	Super Bright LED
Controller	Programmable Microprocessor
Power	400W
Voltage	220V, 50/60Hz
Dimensions	360x435x320mm
Weight	18.7kg



Virtue Incubator Shaker

Cat No.	Description	Price
Virtue IS300	Virtue Benchtop Incubator Shaker	183600
MCOS-FP	Flat platform with non-slip rubber mat	4740
MCOS-UPAB	Universal platform with adjustable bars	20700
MCOS-C10250	Platform with clamps for flasks 100-150ml	14535
MCOS-C25300	Platform with clamps for flasks 250-300ml	14535

HSN CODE : 8419 8990

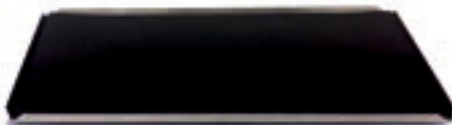

MCOS-FP



MCOS-UPAB



MCOS-C10250/
MCOS-C25300

- Compact size
- Excellent Temperature uniformity
- Built-in Cover Switch
- Perfect for low capacity application
- Brushless DC motor ensures smooth operation
- Beeps when Program Completes
- Temperature Protection

Specifications	
Speed Range	50rpm - 300rpm
Shaking Orbit	20mm
Temperature Range	4 ~ 60°C @ R.T. ≤ 25°C
Display Accuracy	±0.1°C
Temperature Stability @37°C	≤ ± 0.3°C
Timer	1min - 99h59min
Power	600W
Voltage	AC 220V, 50/60Hz
Dimension (WxDxH)	385 x 560 x 320mm
Net Weight	18.7kg



Virtue Incubator Shaker

Cat No.	Description	Price
Virtue ISC300	Virtue Benchtop Incubator Shaker 4-60°C	365100
MCOS-FP	Flat platform with non-slip rubber mat	4740
MCOS-UPAB	Universal platform with adjustable bars	20700
MCOS-C10250	Platform with clamps for flasks 100-150ml	14535
MCOS-C25300	Platform with clamps for flasks 250-300ml	14535
MCOS-PS	Platform with Springs (suitable for virtue ISC300)	28380

HSN CODE : 8419 8990

Specifications	MCMini-IS	MCMini-ISC
Speed Range	300 - 2000rpm	300 - 1500rpm
Shaking Orbit	3mm (horizontal)	3mm (horizontal)
Temperature Control Range	R.T. +5°C - 100°C	0°C - 100°C
Temperature Max Decrease	n/a	R.T. - 20°C
Temperature Setting Range	5°C - 100°C	0°C - 100°C
Temperature Stability	≤ ± 0.3°C	≤ ± 0.3°C
Block Temperature Uniformity	≤ ± 0.3°C	≤ ± 0.3°C
Temperature Display Accuracy	0.1°C	0.1°C
Heating Speed	≤15min (20°C to 100°C)	≤15min (20°C to 100°C)
Cooling Speed	/	≤30min @ R.T. 26°C
Time Range	1 min ~ 99h59min or continuous	1 min ~ 99h59min or continuous
Voltage /Power	AC 220V 50/60Hz / 200W	
Dimension (WxDxH) / Net Weight	196 x 270 x 170mm, 8.2kg	196 x 270 x 170mm, 8.8kg



Mini Incubator Shaker

Cat No.	Description	Price
MCMini-IS	Mini Incubator Shaker (RT+5°C to 100°C)	111210
MCMini-ISC	Mini Incubator Shaker (0°C to 100°C)	199200
MCMISB02	Block for 0.2ml	12900
MCMISB05	Block for 0.5ml	12900
MCMISB1520	Block for 1.5ml/2ml	12900
MCMISB0515	Block for 0.5ml+1.5ml	12900
MCMISB0215	Block for 0.2ml+1.5ml	12900
MCMISB02515	Block for 0.2ml+0.5+1.5ml	12900
MCMISB12	Block for 12mm Tube	12900
MCMISBWB	Block for Water Bath	12900
MCMISBMP	Block for Microplate	12900
MCMISB15	Block for 12x15ml	12900
MCMISB50	Block for 6x50ml	12900
MCMini-ISCS	Cover Small	3501
MCMini-ISCB	Cover Big	4110

HSN CODE : 8419 8990



Specifications	MT-13K	MT-30K
Speed	13000 RPM	8000-35000 RPM
Max. Circum. Speed	n/a	6.3-14m/sec
Noise	60dB	72dB
Dimensions	25x25x160	46x55x230
Weight	0.4 Kg	0.9 kg



Mini MT-13K Homogenizer

- Easy to Operate
- Fixed Speed
- Hand Held Design
- Smart & Light Weight with Ergonomic Design
- Autoclavable Pestle



MT-30K Homogenizer

- Easy to Operate
- Hand Held
- 35000 RPM Variable Speed
- Digital Display
- Smart & Light Weight
- Ergonomic Design



MT- C

MT- B

MT- A

Specifications					
Type	Handling Capacity	Dia Outer Head	Dia Inner head	Min./Max Dipping Depth	length of Head
MT-A	0.5-50ml	6mm	3.9mm	20/90mm	150mm
MT-B	1-100ml	8mm	6.1mm	20/107mm	167mm
MT-C	1-250ml	10mm	7.9mm	20/120mm	180mm

Homogenizer		
Cat No.	Description	Price
MT-13K	Mini Homogenizer (Includes Dispersing Head)	19500
MT-30K	Homogenizer (Doesn't Include Head)	58200
MT-A	Head (Handling Capacity 0.5-50ml)	17310
MT-B	Head (Handling Capacity 1-100ml)	17310
MT-C	Head (Handling Capacity 1-250ml)	17310
MT-HS	Stand - H Type (Height Adjustable)	11520

HSN CODE : 8479 8200

Specifications	Water Bath 2L	Water Bath 5L
Display	LED Display	
Temperature Range	RT.+5 - 100°C	
Temperature Accuracy	0.3°C	
Temperature Stability at 37°C	0.5°C	
Timer	Yes	
Both Volume	2L x 1	5L x 1
Inner Dimension	135mm x 150mm x 143mm x 1	325mm x 150mm x 176mm x 1
Parts Touch Water	Stainless Steel	
Voltage / Power	AC 220V 50/60Hz /300W	AC 220V, 50/60Hz /1000W
Dimension / Net Weight	198mm x 290mm 240mm / 2.3kg.	360mm

- Compact unique Design
- PID automatic temperature control
- Built in water level sensor
- Separate Display for temperature and time
- Easy user interface



Water Bath		
Cat No.	Description	Price
MCWB02	Water Bath 2L	59100
MCWB05	Water Bath 5L	74040

HSN CODE : 8419 8990

Specifications	
Temperature Control Range	R.T. +5°C - 60°C
Temperature Setting Range	5°C - 60°C
Temperature Stability @37°C	± 0.2°C
Temperature Uniformity	± 0.5°C
Temperature Display Accuracy	0.1°C
Time Range	1min - 99h59min
Fan Speed Range	1200 ~ 3200rpm
Incubation Space Size (WxDxH)	215 x 245 x 85mm
Voltage/Power	AC 220V 50/60Hz , 300 W
Dimensions (WxDxH) / Net Weight	275 x 395 x 150mm / 8.1kg



Maxi Air Bath		
Cat No.	Description	Price
MCMXAB	Maxi Air Bath	80220

HSN CODE : 8419 8990

Specifications	
Display	LCD
Heating Capacity	10L
Temperature Control Range	R.T. +5°C ~ 100°C
Temperature Stability (100°C)	± 0.5°C
Oscillation Mode	Reciprocating
Oscillation Range	0~26mm
Speed Range	20 ~ 200rpm
Sink Size (WxDxH)	250 x 304 x 200mm
Voltage / Power	AC 220/110V, 50/60Hz / 1100W
Dimension (WxDxH)	288 x 506 x 350mm
Net Weight	10kg



Water Bath Shaker

Cat No.	Description	Price
MCWBS10	Water Bath 20 ~200RPM R.T.+5 ~100°C	220800

HSN CODE : 8419 8990

STIRRMAG 280

- Compact and Sturdy design
- 5Lt. Stirring Capacity
- Large Superbright LED Display
- High Temp. Resistant Plastic Body
- Hot Surface WARNING! at 50°C
- Microprocessor Ensures accurate temperature control
- Independent digital wheels adjust speed & temperature

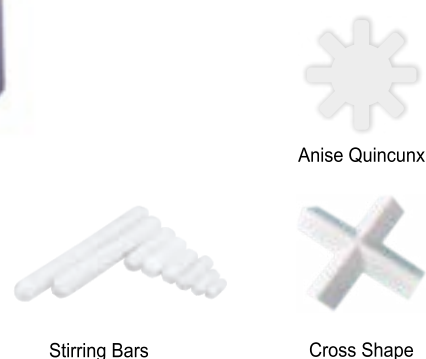

Stirring Bars

Anise Quincunx

Cross Shape

Magnetic Stirrer

Cat. No.	Description	Price
STIRRMAG-Mini	Mini Magnetic Stirrer	6900
STIRRMAG280	Magnetic Stirrer with Hotplate 280°C	29400
STIRRMAG350	Magnetic Stirrer with Hotplate 350°C (Price Includes Temp Sensor & SS Stand)	42000
Pt1000	Temperature Sensor	1950
SSSM280	SS Stand for STIRRMAG280	3930
SSSM350	SS Stand for STIRRMAG350	3930
MCSTRNG P	Stirring bars Assorted Pack 15x8(2Pcs.),20x8 (2Pcs.),25x8(2Pcs.), 40x8 (1Pcs.), 50x8 (1Pcs.)	1650
MCSTRNGX	Stirring Bar Cross Shape (2pcs./Pkg)	1194
MCSTRNGQ	Stirring Bar Quincunx Shape (2pcs./Pkg)	1194

Stirring Bars HSN CODE : 8505 1190

Magnetic Stirrer HSN CODE : 8479 8200

Specifications	STIRRMAG Mini	STIRRMAG 280	STIRRMAG 350
Operation Mode	Stirrer	Stirrer with Hotplate	Stirrer with Hotplate
Speed Range	100-2000RPM	100-1500RPM	200-2000RPM
Max Stirring Capacity (H2O)	1000ml	5000ml	5000ml
Dimensions of Plate	120mm	135mm	190x190mm
Working Plate Material	Plastic	Ceramic	Ceramic
Display	n/a	LED	LCD
Temperature Range	n/a	Increment 1°C	
Temperature Display Accuracy	n/a	± 0.1°C	± 0.1°C
External Temperature Sensor	n/a	Yes	Yes
External Temp. Sensor Accuracy	n/a	± 0.1°C	± 0.1°C
Timer	n/a	n/a	Yes
Hot Surface Warning	n/a	Yes	No
Heating Output	n/a	600 W	600W
Motor Type	Burshless DC motor	Burshless DC motor	Burshless DC motor
Permissible Temp./Humidity	5-40°C, 80%	5-40°C, 80%	5-40°C, 80%
Protection Class	IP21	IP42	Ip21
Voltage, Frequency	200-240V, 50/60Hz	200-240V, 50/60Hz	200-240V, 50/60Hz
Power	10W	630W	650W
Dimensions	138x60mm	268x160x85mm	320x190x125mm
Weight	0.7Kg	1.8Kg	5Kg

STIRRMAG 350

- Compact and Sturdy design
- 5Lt. Stirring Capacity
- Large Backlit LCD Display
- Indicate Speed, Temp. & Time at Same time
- High Temp. Resistant Plastic Body
- Digital timer allows unsupervised operation
- One key to shift inside and outside sensor
- Microprocessor Ensures accurate temperature control



STIRRMAG Mini

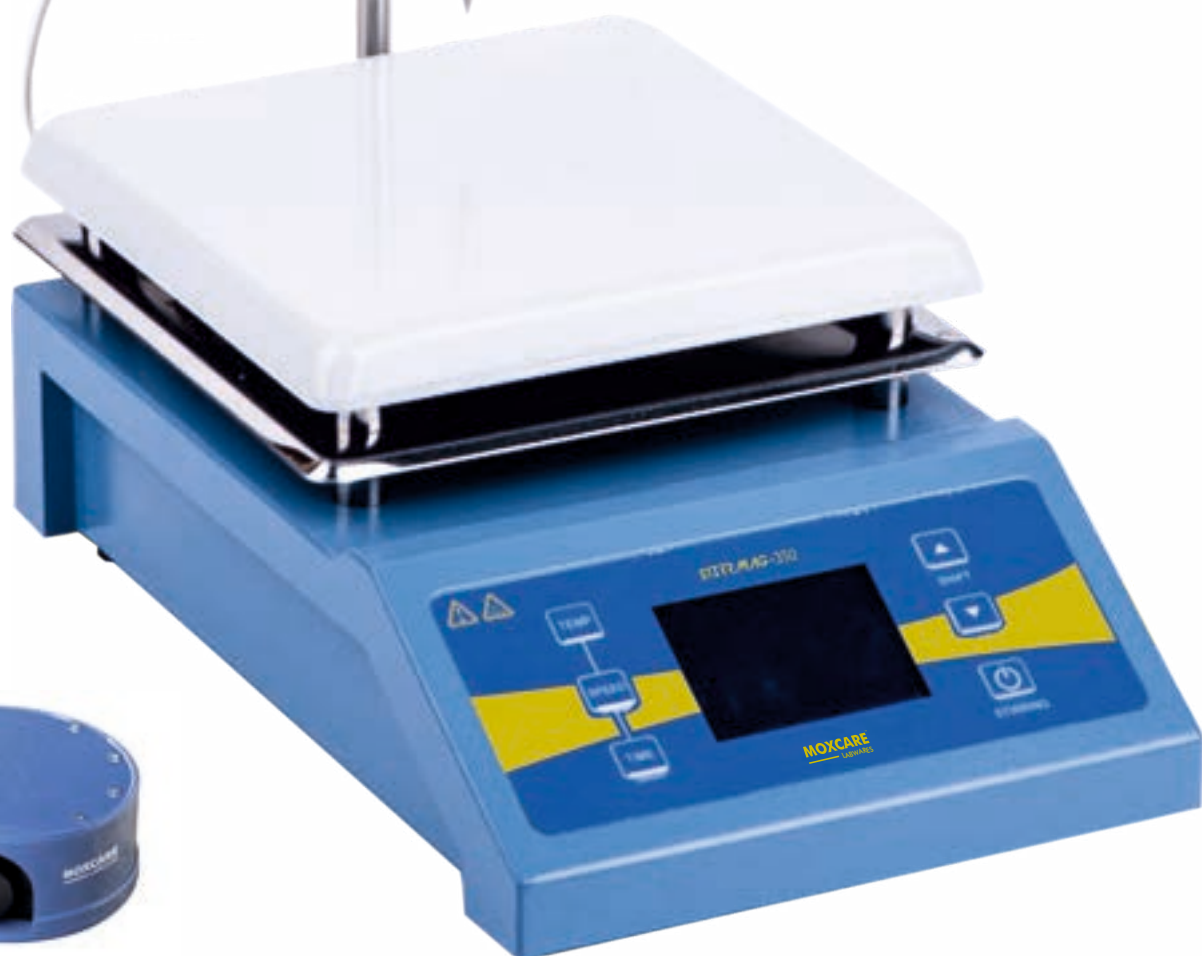

Specifications	
Motion	Orbital
Orbit Diameter	6mm
Speed range	0-3000RPM
Speed display	LED
Timer	0-99hr 59min
Operation Mode	Continuous/touch operation
Permissible Ambient Temperature	5 - 40°C
Permissible Relative Humidity	80%
Protection Class	IP 21
Voltage, Frequency	200 -240V, 50 Hz
Dimensions	107Wx146Hx166Dmm
Weight	3Kg

- Compact and Sturdy design
- Superbright Dual LED Display
- Large Orbital Dia of 6mm
- Digital timer allows unsupervised operation
- Heavy Iron Base with Suction foot provides Excellent stability
- 3 Modes available (Touch/Timer/Continuous Mode)



Vortex Mixer

Cat No.	Description	Price
MIX30PRO	Vortex Mixer LED	18600
MX-AP1	Accessory Pack Any One (0.2ml, 0.5ml, 1.5ml/2ml, 15ml)	2652
MX-AP4	Accessory Pack For All Tubes 0.2ml, 0.5ml, 1.5ml/2ml, 15ml	5307
MX-APM	Accessory Pack For Microplate Attachment	2400
MX-FPAD	Accessory Pack Flat Platform Pad with Universal Plate	1995

HSN CODE : 8479 8200



- Sturdy, Stable & Quiet
- Process upto 50 Samples at 1 time
- LED Display for Speed and Time
- Programmable Pulsing mode in 1 Sec. Intervals

Specification	
Speed	500~2500 Rpm
Timer	1s ~ 999 min
Orbit	4mm
Maximum Load	5kg
Tray Dimension	31X18cm
Dimensions	245x416x410mm
Weight	21.5 kg



Multi Tube Vortex Mixer

Catalog No.	Description	Price
MC-MTV	Multi Tube Vortex Mixer with Accessories	130900
MC-MTVAP1520	Accessory Pack for Multi Tube Vortex Microtubes 1.5ml/2ml	3520
MC-MTVAP15	Accessory Pack for Multi Tube Vortex Microtubes 15ml	3520
MC-MTVAP50	Accessory Pack for Multi Tube Vortex Microtubes 50ml	3520

* Cat. MC-MTV Price Includes All Accessories

HSN CODE : 8479 8200

Specifications	MicroMix
Motion	Orbital
Orbit Diameter	5.5mm
Speed range	3000RPM
Operation Mode	Touch operation
Permissible Ambient Temperature	5 - 40°C
Permissible Relative Humidity	80%
Protection Class	II, IP42
Voltage	200 -240V, 50 Hz
Dimensions	100x78mm(φ x H)
Weight	0.55kg

- Small But Sturdy design
- Large Orbital Dia of 5.5mm
- Fixed Speed 3000 RPM
- Digital timer allows unsupervised operation
- Heavy Base with Patent foot design Provides excellent stability



Vortex Mixer

Cat No.	Description	Price
MicroMix	Micro Vortex Mixer	11040

HSN CODE : 8479 8200



Specifications	
Motion	Rocking
Speed Range	15rpm
Maximum Loading Weight	2.5kg
Running Mode	Continuous
Rocking Angle	25°
Voltage / Power	AC 220V, 50/60Hz / 6W
Working plate size	252 x170mm
Dimensions	346 x 196 x 95mm
Net Weight	2.5kg

Gel Rocker

Cat No.	Description	Price
MCGR1	Gel Rocker (Fixed Speed)	27000

HSN CODE : 8479 8200

Specifications	
Operation Mode	360° Rotation
Diameter	30cm
Display	LED Display
Speed Range	5 ~ 35rpm
Timer	0 ~ 999min
Tube Holder Clips Available	1.5ml, 15ml, 50ml
Running Mode	Timer /Continuous
Voltage /Power	AC 220V, 50/60Hz / 10W
Protective Class	IP31
Permissible Ambient Temperature	5-50°C
Permissible Relative Moisture	80%
Dimensions	310 x 300 x 420mm
Net Weight	4.0kg



Tube Rotator

Cat No.	Description	Price
MCTRT1	Tube Rotator	29400
MCTRA015	Attachment Tube Holder Clips 1.5ml	3675
MCTRA15	Attachment Tube Holder Clips 15ml	3675
MCTRA50	Attachment Tube Holder Clips 50ml	3675

*Cat No. MCTRT1 Price Includes Any one 1 Types of Tube Holder Clips

HSN CODE : 8479 8200

Specifications	
Operation Mode	Rotation, Shaking & Vortex
Speed Range	5-40rpm
Timer	1min - 60Hr.
Running mode	Timer
Working plate	Type 1 - Tubes 1.5ml to 15ml x 22pcs, Type 2 - 50ml X 6pcs, 1.5ml-15ml x 4pcs
Voltage / Power	AC 220V, 50/60Hz / 15W
Protective Class	IP31
Permissible Ambient Temperature	5-50°C
Permissible Relative Moisture	80%
Dimensions	380 x 182 x 190mm
Net Weight	3 kg



Rotating Mixer

3 Operation Modes | Can fit various kinds of test tubes and centrifuge tubes | Low noise DC Motor
Backlit LCD Display - Can display Speed, time, operation mode

Cat No.	Description	Price
MCRTM1	Rotating Mixer	80250

*Cat No. MCRTM1 Price Includes Both Working Plates

HSN CODE : 8479 8200

Specifications	MC-3DRSV	MC-GM3
Motion	3D	3D
Speed Range	10-40RPM	20 RPM
Speed Display	LED	n/a
Running Mode	Timer	continuous
Timer	1s - 999min	n/a
Reciprocating Range	20°-90°	20°
Voltage / Power	AC 220V, 50/60Hz / 4W	AC 220V, 50/60Hz / 6W
Dimensions	240x145x210mm	200x160x160mm
Weight	1.2 kg	2.5kg



3D Rotating Shaker

Rotating Frame Configurations:

A- 5x15ml/10ml + 6x5ml/7ml, B- 3x50ml+18x0.5ml, C- 18x1.5ml/2ml

* Price Including All Rotating Frame Configurations



3D Gyrotory Mixer

Working Plate Dimensions - 24 x17cm



Specification	MCDTR11
Motion	Rocking + Rolling
Max. Load	1.5kg
Speed Range	20-100 RPM
Time	0-999min
No. of Rollers & Roller Length	7 Rollers. Length 235mm
Display	LED
Voltage / Power	AC 220V, 50/60Hz / 35W
Dimensions	410x270x100mm
Net Weight	4Kg

Rollers & Shakers

Cat No.	Description	Price
MCGM3	3D Gyrotory Mixer	28500
MC-3DRSV	3D Rotating Shaker Variable	54900
MCDTR11	Digital Tube Roller	35100

HSN CODE : 8479 8200

Specifications	
Wavelength	Dual Wavelength 254+365nm
UV Window Size	150x50mm
Dimensions	440x75x51mm
Power	220V 50-60Hz



Hand Held UV Transilluminator

Easy to use | Small Compact Hand Held design | Dual Wavelength 254 + 365nm | Inbuilt Small Battery to use without electricity

Cat No.	Description	Price
MCHHUV01	Hand held UV Transilluminator DUAL	49200

HS CODE : 8539 4900

MCHHUV01

Specifications	
Wavelength	470nm
Gel Size	100x160mm
Dimensions	210x210x30mm
Power	220V 50-60Hz
Weight	2.3 kg

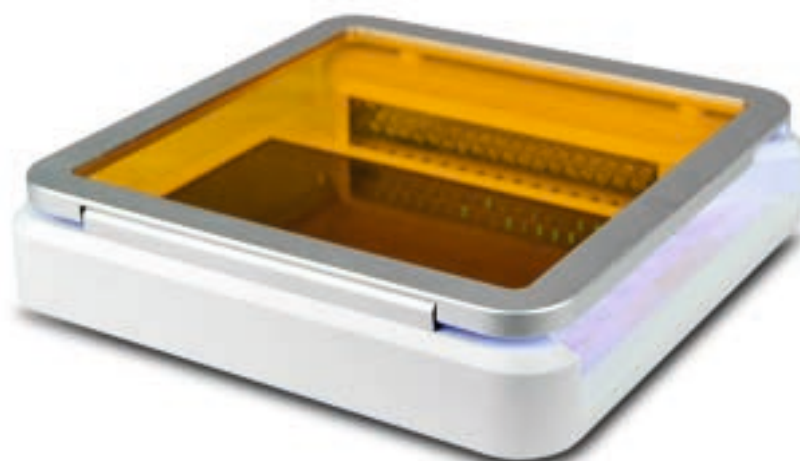

MCBLT01

Blue Light Transilluminator

Moxcare MCBLT01 is a high-intensity LED light transilluminator, which allows scientists safe viewing of a wide range of fluorescent stained DNA/RNA gels. It produce an Epi-blue light with a narrow emission peak centered at 470 nm. This is not only safer but is comparable to UV for the excitation of most fluorescent dyes, including Ethidium bromide, GelRed, GelGreen, SYBR Gold, SYBR Green, SYBR Safe, and Syngene's new UltraPower DNA safe dye.

Cat No.	Description	Price
MCBLT01	Blue Light Transilluminator	68820

HS CODE : 8539 4900

Terms & Conditions

Terms and Conditions:

- 1 This Price list is effective from 1st June 2024 till New Price List is released.
- 2 The Order value Should not be less than Rs. 20,000 otherwise packing charges will be extra.
- 3 The Prices mentioned in catalog are subject to F.O.R Station.
- 4 Please note GST & Insurance will be charged extra as applicable.
- 5 The goods will be supplied through surface cargo.
- 6 We will try to dispatch goods from our Ready Stock * otherwise Delivery schedule will be minimum 6 weeks.
- 7 We ensure you to provide healthy Packing but our responsibility ceases once the goods have dispatched our facility.
- 8 We reserve right to modify colour/ design/ Specification any time for advancement of our products.
- 9 Pictures shown in this catalog are modified for best printing. Actual Product may vary from the pictures shown in this Catalog.
- 10 This Catalog includes MOXCARE Brand Products and also other associated Brands of Moxcare Products Inc.
- 11 All disputes are subject to Ambala Jurisdiction only.
- 12 To avoid misconception Please specify Page No., Catalog No., Product description, Pack, quantity, GST No., Mode of Dispatch in Purchase Order.
13. * We require Minimum 3-5 Working days to Process order from Ready Stock.
14. Please Contact Moxcare Local Dealer / Distributor for More Information.

Liability & Warranty :

We believe that the information we provide to you in our General Catalog and also the information provided with MOXCARE products is correct and reliable to best of our knowledge and belief. We assure and make sure that products we provide you are free from manufacturing defects and we will replace any product that are found to be defective against any manufacturing defect at no cost.

Moxcare Products Inc. is liable exclusively and restrictively to replace defective products but under no circumstances Moxcare is liable for any kind of damage rising from its products.

List of HSN Code & GST Rate Applicable on Moxcare Range of Products

*Below GST Rate may change based on further information by GST Council. Any revision in HSN Code or GST Rate will be informed to the Local Dealer immediately, Please contact your Local dealer for such information or write to us at support@moxcare.in.

HSN Code	GST	HSN Code	GST	HSN Code	GST
39199090	18%	40159030	18%	84211910	18%
39209919	18%	48191010	18%	84212900	18%
39231090	18%	48232000	18%	84798999	18%
39232100	18%	62160090	12%	84798200	18%
39233090	18%	70179090	18%	84799090	18%
39262011	18%	73269090	18%	85051190	18%
39269099	18%	84141000	18%	85394900	18%
40151900, 40151990, 40151200	12%	84198990	18%	90049090	18%

COPYRIGHT WARNING !

The Data, Pictures accompanying this Catalog/Price List are Copyrighted and owned by MOXCARE PRODUCTS INC.(INDIA) and its partners overseas. Protected under applicable Indian and international copyright laws. Further Use of Data/Pictures without informing Moxcare is Strictly prohibited.

WE **CARE** FOR
YOUR **RESEARCH** NEEDS

www.moxcare.in



MOXCARE PRODUCTS INC.

Unit 1
115, HSIIDC Industrial Area
Ambala Cantt - 133006 Haryana-India

Unit 2
308-F Sector 2 Phase 1, HSIIDC Industrial Growth Center
Saha, Ambala 133104 Haryana
India

T: +91 171 2699017, 829 5958 829

E: info@moxcare.in
W: www.moxcare.in