



Vote Sheet

TO: The Commission
Alberta E. Mills, Secretary

DATE: July 10, 2024

THROUGH: Jessica L. Rich, General Counsel
Austin C. Schlick, Executive Director

FROM: Daniel R. Vice, Assistant General Counsel, Regulatory Affairs
Charlotte G. Alton, Attorney, Regulatory Affairs
Mary A. House, Attorney, Regulatory Affairs

SUBJECT: Notice of Proposed Rulemaking: Requirements for Toys Containing Button Cell or Coin Batteries

THIS MATTER IS NOT SCHEDULED FOR A BALLOT VOTE. Wednesday, July 31, 2024
A DECISIONAL MEETING FOR THIS MATTER IS SCHEDULED ON:

The Office of the General Counsel is forwarding for the Commission’s consideration a draft notice of proposed rulemaking (NPR) for *Federal Register* publication to establish a consumer product safety standard for toys that contain button cell or coin cell batteries. Pursuant to Section 106 of the Consumer Product Safety Improvement Act of 2008 (CPSIA), 15 U.S.C. § 2056b, the draft NPR would establish a new section of 16 C.F.R. part 1250, *Safety Standard Mandating ASTM F963 for Toys*, at part 1250.3, as the mandatory federal safety standard for toys containing button cell or coin cell batteries, to further reduce the risk of injury and death associated with such toys and achieve the highest level of safety for such products that is feasible. Further, the NPR proposes revising the title of part 1250 to *Safety Standard for Toys*, to reflect the inclusion of proposed requirements that do not incorporate by reference existing requirements in ASTM F963. Accordingly, the draft NPR proposes to revise the existing rule for toys in part 1250 to ensure that identified button cell and coin cell battery hazards are addressed.

CPSC staff recommends that the Commission publish the draft NPR, which would establish a new mandatory standard for toys containing button cell and coin cell batteries, to provide the highest level of safety for such toys that is feasible.

Please indicate your vote on the following options:

U.S. Consumer Product
Safety Commission
4330 East-West Highway
Bethesda, MD 20814

National Product Testing
and Evaluation Center
5 Research Place
Rockville, MD 20850

I. Approve publication of the attached notice in the *Federal Register*, as drafted.

(Signature)

(Date)

II. Approve publication of the attached notice in the *Federal Register*, with the specified changes.

(Signature)

(Date)

III. Do not approve publication of the attached notice in the *Federal Register*.

(Signature)

(Date)

IV. Take other action specified below.

(Signature)

(Date)

Attachment: Draft Notice of Proposed Rulemaking: Requirements for Toys Containing Button Cell or Coin Cell Batteries

CONSUMER PRODUCT SAFETY COMMISSION

16 CFR Parts 1112 and 1250

[CPSC Docket No. CPSC-2024-XXXX]

**Safety Standard for Toys: Requirements for Toys Containing Button Cell or Coin Cell
Batteries**

AGENCY: Consumer Product Safety Commission.

ACTION: Notice of proposed rulemaking.

SUMMARY: The U.S. Consumer Product Safety Commission (Commission or CPSC) proposes to address the risk of injury and death associated with children ingesting button cell or coin cell batteries obtained from toys by adding performance and labeling requirements for battery-operated toys containing such batteries. The proposed requirements would provide the highest level of safety feasible, and are consistent with the Commission's recent Reese's Law rulemaking and international standards for electronic toys. The Commission also proposes to amend CPSC's list of notice of requirements (NORs) to include toys containing button cell or coin cell batteries.

DATES: Submit comments by [INSERT DATE 60 DAYS AFTER DATE OF PUBLICATION IN THE FEDERAL REGISTER].

ADDRESSES: Comments related to the Paperwork Reduction Act aspects of the marking, labeling, and instructional literature requirements of the NPR should be directed to the Office of Information and Regulatory Affairs, the Office of Management and Budget, Attn: CPSC Desk Officer, FAX: 202-395-6974, or e-mailed to: oira_submission@omb.eop.gov.

OS 4
DRAFT

Submit all other comments, identified by Docket No. CPSC-XXXX, by any of the following methods:

Electronic Submissions: Submit electronic comments to the Federal eRulemaking Portal at: <https://www.regulations.gov>. Follow the instructions for submitting comments. Do not submit through this website: confidential business information, trade secret information, or other sensitive or protected information that you do not want to be available to the public. CPSC typically does not accept comments submitted by email, except as described below.

Mail/Hand Delivery/Courier/ Confidential Written Submissions: CPSC encourages you to submit electronic comments by using the Federal eRulemaking Portal. You may, however, submit comments by mail, hand delivery, or courier to: Office of the Secretary, Consumer Product Safety Commission, 4330 East-West Highway, Bethesda, MD 20814; telephone: (301) 504-7479. If you wish to submit confidential business information, trade secret information, or other sensitive or protected information that you do not want to be available to the public, you may submit such comments by mail, hand delivery, or courier, or you may e-mail them to: cpsc-os@cpsc.gov.

Instructions: All submissions must include the agency name and docket number. CPSC may post all comments without change, including any personal identifiers, contact information, or other personal information provided, to <https://www.regulations.gov>. Do not submit through this website: Confidential business information, trade secret information, or other sensitive or protected information that you do not want to be available to the public. If you wish to submit such information, please submit it according to the instructions for mail/hand delivery/courier/confidential written submissions.

Docket: For access to the docket to read background documents or comments received, go to: <https://www.regulations.gov>, and insert the docket number, CPSC-2024-XXXX, into the “Search” box, and follow the prompts.

FOR FURTHER INFORMATION CONTACT: Benjamin Mordecai, Project Manager, Division of Mechanical Engineering, Directorate for Laboratory Sciences, Consumer Product Safety Commission, 5 Research Place, Rockville, MD 20850; Telephone 301-987-2506; e-mail: bmordecai@cpsc.gov.

SUPPLEMENTARY INFORMATION:

I. Background and Statutory Authority

In 2008, Congress passed the Consumer Product Safety Improvement Act of 2008 (CPSIA) providing the CPSC with new regulatory and enforcement tools, particularly for the purpose of protecting the safety of children. Among other things, section 106(a) of the CPSIA made ASTM International’s voluntary standard for toys, ASTM F963–07, *Standard Consumer Safety Specification for Toy Safety* (except sections 4.2 and Annex 4) a mandatory standard beginning 180 days after the enactment date of the CPSIA, on February 10, 2009. 15 U.S.C. 2056b(a). Section 106 also directs the Commission to promulgate toy safety standards that are “more stringent than” the applicable voluntary standard if the Commission determines that more stringent requirements would further reduce the risk of injury associated with the product, as well as to periodically review and revise the rules set forth under section 106 to ensure that such rules provide the highest level of safety for such products that is feasible. 15 U.S.C. 2056b(c) and (d).

The CPSIA states that ASTM F963 shall be considered a consumer product safety standard issued by the Commission under section 9 of the Consumer Product Safety Act (CPSA);

OS 6
DRAFT

15 U.S.C. 2058). *Id.* Since 2009, CPSC has enforced ASTM F963 as a mandatory standard for toys.¹ In 2017, the Commission codified the mandatory toy standard in 16 CFR part 1250, Safety Standard Mandating ASTM F963 for Toys, and incorporated by reference the newly revised ASTM standard at that time, ASTM F963–16. 82 FR 8989 (Feb. 2, 2017). Most recently, on January 18, 2024, the Commission updated part 1250 to incorporate by reference a 2023 revision, ASTM F963–23. 89 FR 3344.

Some toys within the scope of ASTM F963 and 16 CFR part 1250 contain, or are designed to use, button cell or coin cell batteries.² Accordingly, section 4.25 of ASTM F963–23 contains requirements for “battery-operated toys,” including requirements for toys containing button cell or coin cell batteries. The ASTM requirements are intended to address hazards related to battery overheating, leakage, explosion, fire, and children choking on or swallowing batteries. The 2023 updates to ASTM F963 include improvements to safety requirements for toys that contain button cell or coin cell batteries, such as expanding the application of use and abuse testing of toys and labeling requirements that enhance battery accessibility requirements. However, as discussed in section IV of this preamble, ASTM F963–23 does not establish adequate requirements for toys containing button cell or coin cell batteries because the existing requirements do not address all of the identified hazards and are not as stringent as requirements for non-toy consumer products that are found in 16 CFR part 1263, Safety Standard for Button Cell or Coin Batteries and Consumer Products Containing Such Batteries.

¹ Since the CPSIA’s enactment in 2008, ASTM revised F963 five times: ASTM F963–08, ASTM F963–11, ASTM F963–16, ASTM F963–17, and ASTM F963–23 (approved August 1, 2023).

² In this notice of proposed rulemaking (NPR) we define the phrase “toy containing button cell or coin cell batteries” consistent with the definition of a “consumer product containing button cell or coin batteries” in Reese’s Law. 15 U.S.C. 2056e Notes (Definition 4). A “toy containing button cell or coin cell batteries” means a toy containing or designed to use one or more button cell or coin batteries, regardless of whether such batteries are intended to be replaced by the consumer or are included with the product or sold separately. *Id.*, proposed § 1250.3(b).

OS 7
DRAFT

Part 1263 implements Reese’s Law, Pub. L. No. 117-171, a law that protects children 6 years old and younger against hazards associated with the ingestion of button cell or coin batteries. 15 U.S.C. 2056e. Reese’s Law, however, excludes children’s toys subject to requirements in 16 CFR part 1250 from its scope. 15 U.S.C. 2056e Note. Specifically, the law states, “The standards promulgated under this Act shall not apply with respect to any toy product that is in compliance with the battery accessibility and labeling requirements of part 1250 of title 16, Code of Federal Regulations[.]”³ Therefore, the current part 1250 standard implementing ASTM F963 does not provide the highest level of safety feasible for such toys.

Accordingly, this notice of proposed rulemaking (NPR) proposes to amend the requirements in part 1250 specific to battery compartments for toys containing button cell or coin cell batteries to align the requirements more closely with the Commission’s new rule for consumer products containing button cell or coin batteries, codified at part 1263. Further, this NPR proposes revising the title of part 1250 from “Safety Standard Mandating ASTM F963 for Toys” to “Safety Standard for Toys,” to reflect the inclusion of proposed requirements that do not incorporate by reference existing requirements in ASTM F963.⁴

The Commission is authorized to issue this NPR pursuant to both sections 106(c) and (d) of the CPSIA, 15 U.S.C. 2056b(c) and (d). Section 106(d) of the CPSIA, 15 U.S.C. 2056b(d)(2), requires the Commission to: (1) examine and assess the effectiveness of ASTM F963, in consultation with representatives of consumer groups, juvenile product manufacturers, and independent child product engineers and experts; and (2) promulgate consumer product safety standards for such toys. Standards issued under section 106(d) are to be “more stringent than”

³ Consistent with 16 CFR part 1250, Reese’s Law defines a “toy product” as “any object designed, manufactured, or marketed as a plaything for children under 14 years of age.” 15 U.S.C. 2056e Notes (Definition 5).

⁴ On [insert date], the Commission vote (x-x) to publish this NPR.

OS 8
DRAFT

the applicable voluntary standard if the Commission determines that more stringent requirements would further reduce the risk of injury associated with the product. 15 U.S.C. 2056b(d)(2)(B). Since before the CPSIA, CPSC staff has consulted with stakeholders regarding provisions in the toy standard through the ASTM process. Since the passage of Reese's Law in 2022, CPSC staff has been corresponding with the relevant ASTM Subcommittee and task group, discussing the incident data associated with child battery ingestions, staff's testing of toy battery compartments, and staff's recommendations to update the performance and labeling requirements in the toy standard to adequately address the ingestion hazard associated with children accessing button cell or coin cell batteries from toys.⁵

Section 106(c) of the CPSIA, 15 U.S.C. 2056b(c), requires the Commission to periodically review and revise the rules set forth under section 106, to ensure that such rules provide the highest level of safety for such products that is feasible. The NPR proposes to add performance requirements and revise labeling requirements for toys containing button cell or coin cell batteries that are more stringent than the existing requirements in ASTM F963, which are incorporated by reference into 16 CFR part 1250, and that also provide the highest level of safety feasible, aligning with the requirements in 16 CFR part 1263.

This NPR provides an overview of staff's assessment and analysis, and it discusses the Commission's basis for issuing this NPR. Based on the information and analysis in this NPR,

⁵ See, e.g., August 19, 2022, Letter from Benjamin Mordecai, Project Manager for ASTM F963 to ASTM Subcommittee and Task Group Chair, regarding increasing number of incidents involving children gaining access to button and coin cell batteries in battery-operated toys, and requesting the toy safety F15.22 subcommittee to review the data and develop more stringent performance requirements to address these incidents in the next few months (available at: <https://www.cpsc.gov/s3fs-public/8-19-2022-Letter-to-ASTM-Battery-Operated-Toys.pdf?VersionId=PgFoeCeb0BYz0kyg6z87tbwHKv3x9W0y>); and March 20, 2023, Letter from Daniel Taxier, Children's Product Program Manager, and Benjamin Mordecai, Project Manager for ASTM F963, to ASTM Subcommittee and Task Group Chair, regarding Reese's Law, CPSC staff's toy testing to F963 and UL-4200A, and recommendations for updates to F963 to align with the Commission's then-proposed NPR to implement Reese's Law (available at: <https://www.cpsc.gov/s3fs-public/Letter-to-ASTM-F15-22-Reeses-Law-NPR-230320.pdf?VersionId=6ZGPs5nSLhBGIFdoz1IWHF1wo.oOgarH>).

the Commission preliminarily determines that the proposed performance and labeling requirements for toys containing button cell or coin cell batteries are more stringent than the existing requirements in ASTM F963–23, would further reduce the risk of injury associated with products within the scope of the NPR, and would provide the highest level of safety for such products that is feasible.

II. Description of Toys Within the Scope of the Rule

Many toys contain or are designed to use button cell or coin cell batteries like those shown in Figure 1. Generally, button cell batteries are small, disposable, single-cell batteries that range from 5 mm to 32 mm (0.2 inches to 1.3 inches) in diameter and are 1 mm to 6 mm (0.04 inches to 0.24 inches) in thickness. Common anode materials are zinc or lithium while common cathode materials are manganese dioxide, silver oxide, carbon monofluoride, cupric oxide, or oxygen from the air.⁶ Button cell batteries tend to be manganese dioxide (alkaline) (1.5 volt) or silver oxide (1.55 volt). Lithium coin batteries, also shown in Figure 1, were originally developed as a 3-volt power source for low-drain and battery-backup applications because of their high-energy density, correspondingly small size, and long shelf life. Lithium coin batteries are commonly approximately 20 mm (0.787 inch) in diameter.







		
LR44 button cell, 11.6mm (0.45 inch) diameter, 5.4mm (0.21 inch) thick	LR754 button cell, 7.9 mm (0.31 inch) diameter, 5.4mm (0.21 inch) thick	LR626 button cell, 6.8 mm (0.26 inch) diameter, 2.6mm (0.10 inch) thick
		
CR2032, 20mm (0.787 inch) diameter	CR2025, 20mm (0.787 inch) diameter	CR2450, 24mm (0.945 inch) diameter

Figure 1. Example Button Cell and Coin Cell Batteries

⁶ Anodes and cathodes are the positive or negative posts of a battery. The different materials allow the battery to lose or gain electrons dependent on the intended function.

Section 3.1.9 of ASTM F963–23 defines “battery, button cell” as a “small round non-lithium battery, in which the overall height is less than the diameter” while section 3.1.10 of ASTM F963–23 defines a “battery, coin cell” as a “small, round lithium battery in which the overall height is less than the diameter.” Generally, button cell and coin cell batteries are uniformly defined across safety standards. For example, section 5 of Reese’s Law defines “button cell or coin battery” similarly to the ASTM F963–23 definitions, in relevant part, as “...a single cell battery with a diameter greater than the height of the battery...” 15 U.S.C. 2056e Notes (Definition 1).

A button cell or coin cell battery (also referred to by industry and consumers as a cell or disc/disk battery) stores chemical energy which is converted to electrical energy when the battery is connected to a circuit. A button cell or coin cell battery consists of an anode, a cathode, and a separator and electrolyte between the anode and cathode, as shown in Figure 2. When connected with a conductive material, such as when the battery is pressed into moist human tissue (*i.e.*, when swallowed), the connected battery terminals form an electric circuit, and electric current flows through the conductive material and between the terminals. As already described, button cell or coin cell batteries come in many shapes and sizes and are composed of different materials and chemicals. Requirements for power (voltage and capacity) and size are the main driver of battery shape, chemical composition, and the number of batteries required to operate a toy.

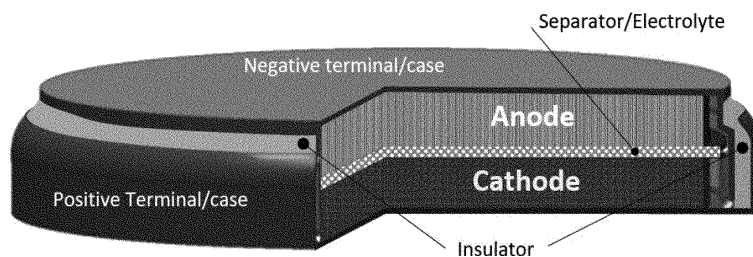

Figure 2. Components of a Button Cell or Coin Cell Battery

Section 3.1.92 of ASTM F963–23 defines a “toy” as “any object designed, manufactured, or marketed as a plaything for children under 14 years of age.” Section 3.1.11 of ASTM F963–23 defines a “battery-operated toy” as a “toy having at least one function dependent on electricity and powered by batteries.” Figure 3 provides examples of toys containing button cell or coin cell batteries that fall within the scope of this NPR. Such toys include, but are not limited to, light up toys, talking dolls, remote controlled vehicles, stuffed animals, science kits, musical toys, do-it-yourself light up craft kits, electronic board games, and learning tablets/games.



Figure 3. Examples of Toys Containing Button Cell or Coin Cell Batteries Within the Scope of this Notice of Proposed Rulemaking

Toys containing or designed to use other types of batteries, where the diameter is less than the height, such as AAA or AA batteries, or non-cylindrical batteries, are out of the scope of this NPR because their size and shape does not pose the same type or degree of ingestion hazard as button cell or coin cell batteries.

III. Incident Data and Hazard Patterns

CPSC staff searched two CPSC-maintained databases to identify incidents and hazard patterns associated with button cell and coin cell batteries in toys using product code 0884 for

batteries: the Consumer Product Safety Risk Management System (CPSRMS)⁷ and the National Electronic Injury Surveillance System (NEISS).⁸ The incidents considered were reported as occurring between January 1, 2016, and December 31, 2022. For this period staff identified incidents associated with battery insertions and ingestion, or the risk of ingestion, involving children who were able to access button cell or coin cell batteries from toy battery compartments. Specifically, staff identified one fatal incident and 46 non-fatal incidents in CPSRMS, and 185 NEISS reported hospital emergency department (ED)-treated incidents, associated with children accessing a toy battery compartment. Of the 47 CPSRMS incidents, all but one incident involved children younger than 9 years old, while 170 of the NEISS incidents involved children aged 6 years old or younger.

A. Overview of Button Cell and Coin Cell Battery Hazards

1. Ingestion

Children may be able to access button cell or coin cell batteries when playing with toys that are operated by such batteries. Children may access such batteries if a toy breaks apart and the batteries become exposed or if a battery compartment remains open while a caregiver is changing the batteries. Once exposed, children may remove and ingest the batteries. For example, in CPSC's In-Depth Investigation (IDI) 171024HCC1059, a 20-month-old male

⁷ CPSRMS includes data primarily from three groups of sources: incident reports, death certificates, and in-depth follow-up investigation reports. A large portion of CPSRMS consists of incident reports from consumer complaints, media reports, medical examiner or coroner reports, retailer or manufacturer reports (incident reports received from a retailer or manufacturer involving a product they sell or make), safety advocacy groups, law firms, and federal, state, or local authorities, among others. It also contains death certificates that CPSC purchases from all 50 states, based on selected external cause of death codes (ICD-10). The third major component of CPSRMS is the collection of in-depth follow-up investigation reports. Based on the incident reports, death certificates, or NEISS injury reports, CPSC field staff conduct in-depth investigations (on-site, telephone, or online) of incidents, deaths, and injuries, which are then stored in CPSRMS.

⁸ NEISS is the source of the injury estimates; it is a statistically valid injury surveillance system. NEISS injury data are gathered from emergency departments of a sample of hospitals with 24-hour emergency departments and at least six beds, selected as a probability sample of all U.S. hospitals. The surveillance data gathered from the sample hospitals enable the CPSC to make timely national estimates of the number of injuries associated with specific consumer products.

ingested a button battery from an electronic toy; the battery was removed surgically, but the child later died from injury. Medical literature details how death and serious injury are associated with button cell or coin cell battery ingestion. Such injuries including choking, internal chemical burns, chemical leakage, pressure necrosis (tissue damage), the creation of hazardous chemicals (such as sodium hydroxide and hydrochloric acid), and related hazards.⁹ Because of the nature of the risk of injury, as described in this section, it is important to identify a battery ingestion in a timely manner and remove the button cell or coin cell battery from the body to prevent serious injury or death.

CPSC staff reviewed medical literature related to battery-ingestion injuries that confirms ingested button cell or coin batteries can lodge in the esophagus and cause severe tissue damage after only a few hours, as discussed in Tab B of the Reese's Law NPR Staff Briefing Package (SBP).¹⁰ The conductive soft tissue in the digestive tract can form a circuit between the battery terminals, creating an electric current. When lodged in the esophagus, button cell or coin batteries can cause damage to the esophagus, burning nearby tissue and creating perforations. The battery current generates hydroxide when in contact with tissue in the digestive tract. Hydroxide can create chemical burns. Lithium coin batteries pose a particular threat of chemical burn if ingested because such batteries have a higher voltage and capacity than non-lithium batteries. Other injuries associated with button cell or coin battery ingestion include alkaline

⁹ See, *supra* n.3, citing Tab B of Staff's Reese's Law NPR Briefing Package.

¹⁰ The information in this proposed rule is based in part on information and analysis provided in the January 11, 2023, Staff Briefing Package: Draft Proposed Rule to Establish a Safety Standard and Notification Requirements for Button Cell or Coin Batteries and Consumer Products Containing Such Batteries (Staff's Reese's Law NPR Briefing Package), available at: <https://www.cpsc.gov/s3fs-public/NoticeofProposedRulemakingSafetyStandardandNotificationRequirementsforButtonCellorCoinBatteriesandConsumerProductsContainingSuchBatteries.pdf?VersionId=kDinNeydtkkt3T8RRtzN4u1GTXPjEj>. Tab B and its appendices contain staff's review of the medical literature and battery ingestion data from the National Capitol Poison Center (Poison.Org).

electrolyte leakage from alkaline button cell batteries or pressure necrosis from extended contact of the battery with tissue.

While ingested button cell or coin batteries may be able to pass through the digestive tract without complications, ingestion complications can occur, usually when such batteries become stuck (impacted) in the esophagus.¹¹ The primary injury from impaction is from the transmission of electric current eliciting the production of sodium hydroxide (NaOH) and hydrochloric acid (HCl) in tissues adjacent to the cathode and anode terminals, respectively.¹² After only a few hours of a battery maintaining contact with moist tissue, tissue pH on either side of the battery increases, causing substantial tissue damage. The erosive and perforating effects of esophageal impaction may continue even after removing the battery.¹³ Another mechanism of injury involves an electrical burn created by electric current passing between the anode and the cathode.

An imperfectly sealed alkaline button cell battery may leak electrolyte solution when ingested, causing injury or death. The large concentration of potassium hydroxide (KOH) in the electrolyte solution is particularly corrosive to human tissue. Alkalis penetrate deep into the tissue layers, which may cause extensive tissue damage.

Another mechanism of injury common to foreign body impaction is pressure necrosis, which creates ischemic,¹⁴ blackened areas of tissue damage.¹⁵ Impaction of a button cell or coin battery in the esophagus leads to esophagus burns in as little as two hours. A burn in the

¹¹ Sigalet D, Laes G, Tracheo-esophageal injury secondary to disc battery ingestion, American Journal of Otolaryngology 23 (1988) 996–998.

¹² Hamilton JM, Schraff SA, Notrica DM. Severe injuries from coin cell battery ingestions: 2 case reports. Journal of Pediatric Surgery (2009) 44, 644–647.

¹³ Gao Y, Wang J, Ma J, Gao Y, Zhang T, Lei P, Xiong X. Management of button batteries in the upper gastrointestinal tract of children. Medicine (2020) 99:42.

¹⁴ Ischemia is a condition where blood flow is blocked or reduced, depriving oxygen and nutrients.

¹⁵ Alvi A, Bereliani A, Zahatz GN. Miniature disc battery in the nose: a dangerous foreign body. Clin Pediatr (Phila). 1997 Jul;36(7):427-9.

esophagus may cause a perforation of the esophagus or an esophageal stricture (a narrowing of the esophagus). Perforation or stricture of the esophagus can make eating difficult, requiring use of a feeding tube in the stomach or dilations of the esophagus to expand the stricture to allow normal swallowing.

A button battery that burns through the esophagus can also burn through nearby tissues, creating a fistula, which is an abnormal connection between the esophagus and the other surrounding tissues. When fistulas are created in the esophageal area, they are commonly found with the trachea (tracheoesophageal fistulas or TEF) and with the aorta (aortoesophageal fistulas or AEF). Both of these fistulas are life threatening injuries because they can lead to an open artery and, thus, excessive blood loss. Researchers report that esophageal burns and fistulas sometimes require multiple surgeries to repair.¹⁶ These injuries could require weeks of treatment in a hospital.¹⁷

Diagnosing an ingested button cell or coin battery requires an x-ray because physical examination after ingestion does not always confirm a battery was ingested. Symptoms of button cell or coin battery ingestion, such as respiratory distress, can be mistaken for other ailments, like an asthma attack.¹⁸ As an example, a child who ingested a button cell or coin cell battery may have a fever but no other evidence of having ingested a button cell or coin battery. Alternatively, the physical examination can be normal, making an ingestion diagnosis difficult.¹⁹

¹⁶ Slamon NB, Hertzog JH, Penfil SH, Raphaely RC, Pizarro C, Derby CD. An unusual case of button battery-induced traumatic tracheoesophageal fistula. *Pediatric Emergency Care*. Volume 24, Number 5, May 2008.

¹⁷ Liao W, Wen G, Zhang X. Button battery intake as foreign body in Chinese children. Review of case reports and the literature. *Pediatr Emer Care* 2015;31: 412-415; Kimball SJ, Park AH, Rollins II MD, Grimmer JF, Muntz H. A review of esophageal disc battery ingestions and a protocol for management. *Arch Otolaryngology Head Neck Surg/Vol* 136 (NO. 9), SEP 2010. 866-871.

¹⁸ Takahashi T, Teramoto Y, Aoyama T, Sahakibara H, Hara M, Maseki M, Yamaguchi S. Anesthetic management of a child with an esophageal foreign body with was misdiagnosed as asthma. *MASUI. THE JAPANESE JOURNAL OF ANESTHESIOLOGY*. 2009 Feb;58(2):199-201. 199-201.

¹⁹ Cruz CI, Patel D. (2013). Impacted Button-Battery Masquerading as Croup. *The Journal of Emergency Medicine*, Vol.45, No. 1, pp.30-33.

Lithium button cell or coin battery ingestions have become more common as such batteries are used in more household products, including toys, than they were historically.²⁰ As noted, lithium batteries pose a significant safety hazard when ingested because lithium batteries generate a relatively high voltage, causing rapid local injury, even when partially discharged (used). Therefore, even partially discharged batteries can cause life-threatening injuries when ingested. Medical literature confirms that caregivers only have approximately two hours to remove a lithium battery from a child's esophagus to prevent injury.²¹

2. Nasal Insertion

Not only do children ingest button cell or coin cell batteries, but children also insert such batteries into the nasal cavity. For example, in NEISS case 170555849, a 2-year-old male put into his nose a button battery that was likely liberated from a toy, as batteries were later found to be missing from a toy. A proportion of nose insertions ultimately become ingestions or aspirations because such batteries travel through the nasal passage and enter the digestive tract or airways. Button cell or coin batteries impacted in the nose can lead to severe damage to the endonasal mucous membranes (tissue inside the nasal passage), necrosis (tissue damage) of the nasal septum cartilage (the tissue that separates the left and right nostril), and nasal septum perforation.

When the battery is not removed immediately, most children experience long-term effects, such as saddle nose; saddle nose is a flattening of the nose after a battery has damaged the nasal septum to the point of disintegration by burning a hole in the tissue. Reconstructive surgery is required to artificially recreate a septum inside the child's nose. The severity of nasal

²⁰ Dawe N, Puvanendran M, Flood L. Unwitnessed lithium-ion disc battery ingestion: case report and review of best practice management of an increasing clinical concern. *The Journal of Laryngology & Otology* (2013), 127, 84–87.

²¹ Gao Y, Wang J, Ma J, Gao Y, Zhang T, Lei P, Xiong X. Management of button batteries in the upper gastrointestinal tract of children. *Medicine* (2020) 99:42.

insertion complications depends on the duration of impact (longer duration can lead to more damage), the type of button cell or coin battery (a higher voltage can cause more damage), and in which part of the nasal cavity the battery gets lodged (the septum is most susceptible to damage because it is the thinnest tissue in the nose). Septum perforation complications can result in lifelong consequences, such as facial deformity.²² A button cell or coin battery that becomes dislodged inside the nose can be ingested, causing damage not only to the nasal structure but to the digestive tract as well.²³

Tab B, Appendix B of the Reese's Law NPR SBP shows 56 cases from medical literature of nasal insertion with button cell or coin batteries from 1985 to 2015. The most severe injury is septal perforation after a battery burned a hole in the tissue. Sometimes the battery remained lodged in the nose for long periods of time, sometimes for months, leading to extensive damage to the nose.²⁴ Sometimes an impaction occurred for only a few hours and led to septal perforation of the nose.²⁵

3. Ear Insertion

Button cell or coin batteries inserted into the ear canal cause injuries similar to that of nasal insertions when they become impacted. A button cell or coin battery that is inserted into the ear canal may cause ear drum perforation or destruction, marked erosion of the ear canal with exposed bone, hearing impairment, facial nerve paralysis, and destruction of the small bones in

²² Bakshi SS, Coumare VN, Priya M, Kumar S. Long-term complications of button batteries in the nose. The Journal of Emergency Medicine, Vol. 50, No. 3, pp. 485-487, 2016.

²³ Alvi A, Bereliani A, Zahtz GN. Miniature disc battery in the nose: a dangerous foreign body. Clin Pediatr (Phila). 1997 Jul;36(7):427-9

²⁴ Fosarelli P, Feigelman S, Pearson E, Calimano-Diaz A. An unusual intranasal foreign body. Pediatric Emergency Care. Vol 4 No 2. 1988.117-118.

²⁵ Liao W, Wen G, Zhang X. Button battery intake as foreign body in Chinese children. Review of case reports and the literature. Pediatr Emer Care 2015;31: 412-415.

the middle ear.²⁶ Like nose insertions, the severity of ear insertion complications depends on the duration of impact, the voltage of the button cell or coin battery, and in which part of the ear canal the battery gets lodged. Appendix C of the Reese's Law NPR SBP shows 10 cases from medical literature of button cell or coin batteries having been inserted into the ear canal.

B. Incident Data Hazard Scenarios – How Children Accessed Batteries

1. Durability

Fifty reported nonfatal incidents between 2016 and 2022, including 20 CPSRMS and 30 NEISS incidents, involve a toy battery compartment breaking apart or opening unintentionally, allowing children to access and potentially ingest or insert button cell or coin cell batteries. Reports describe battery compartment failures where the toy was dropped (nine incidents), thrown or smashed (two incidents), crushed by foot (one incident), or manipulated by a child's hands or mouth to open the battery compartment in a manner that defeated the locking mechanism (nine incidents). These incident reports demonstrate that some toy battery compartments are not strong enough to withstand reasonably foreseeable use or abuse to prevent children from accessing batteries. For example, incident I17B0493A describes an 8-year-old male who dropped a light-up spinner toy that easily broke apart; the child swallowed the battery, which required surgery to remove and caused tissue damage to his esophagus. Further, incident I1910003A describes a 3-year-old male who was playing with an action figure when the battery compartment unexpectedly broke open; the consumer indicated they were only able to locate two of three batteries.

The NPR proposes to address these incidents by improving the durability of battery compartments through performance tests. The NPR proposes to require sequential use and abuse

²⁶ Bhisitkul DM and Dunham MD. An unsuspected alkaline battery foreign body presenting as malignant otitis external. *Pediatric Emergency Care*. Vol 8 No 3. 141-142. 1992.

testing that aligns with use and abuse testing in part 1263, adopting similar use and abuse performance requirements.

2. Fastener Engagement

Twenty reported nonfatal incidents, including 18 CPSRMS and two NEISS incidents, involve a toy battery compartment fastener, such as a screw, that did not adequately secure or close the compartment, potentially allowing children to access and ingest or insert the button cell or coin cell batteries inside. Incident reports describe failing fasteners as not being long enough to engage the threads (four incidents), fasteners continuously spinning, or threads being stripped (four incidents). These incidents demonstrate that some fasteners do not adequately secure toy battery compartments and that the engagement of the fastener can degrade over time. For example, incident I6C0676A describes a 4-year-old male who was found playing with a light up toy in his room with the battery compartment cover off the toy; the batteries were all located, but the screw intended to secure the battery compartment continuously spun when a caregiver attempted to tighten it. Consistent with part 1263 fastener requirements, and to ensure more durable fastener engagement, the NPR proposes minimum requirements for battery compartment thread attachment as well as a test to simulate repeated battery replacement.

3. Sibling Interaction

Twenty-four (24) reported nonfatal incidents, including seven CPSRMS and 17 NEISS incidents, describe a button cell or coin cell battery becoming accessible from a toy when, for example, two or more siblings played with a toy together, or a younger sibling played with an older sibling's toy. Incident reports demonstrate that basing performance requirements for the durability of toy battery compartments on the intended user's age does not adequately address typical use and abuse scenarios leading to the ingestion hazard. For example, incident

I1910347A describes a 2-year-old female who played with her 4-year-old male sibling's toys; the 2-year-old dropped the toys on the floor and the toys fell apart; three button batteries fell out of the toys. The NPR proposes to address these incidents by improving the durability of battery compartments through performance tests with limited reliance on age grading. The NPR proposes to require sequential use and abuse testing that aligns with testing in part 1263, incorporating UL 4200A-23 performance requirements.

4. Changing Batteries

Seven reported nonfatal incidents, all from NEISS, describe a child accessing a button cell or coin cell battery while a parent or caregiver was changing batteries in a toy. All children involved in these incidents were taken to a hospital for treatment. For example, NEISS case 190447495 describes an incident where a babysitter was changing a button battery in a toy when an 8-month-old male was able to swallow one battery. The NPR proposes to address these incidents by improving required product warning labels for toy battery compartments to better warn consumers about battery ingestion hazards while the consumer is interacting with the compartment.

5. Easily Accessed Battery Compartments

Four reported nonfatal incidents, all from CPSRMS, involve a child who was able to open a toy battery compartment without the use of a tool. For example, IDI 170623CFE0001 describes a 9-year-old boy who opened a battery compartment by pulling a battery compartment access tab with his teeth. The remaining three incidents describe toys that lacked battery compartment securing mechanisms or that opened easily without a tool. The NPR proposes to better address the hazard of easily accessed battery compartment incidents by mandating minimum performance requirements for battery compartment threaded attachments.

C. National Estimates from NEISS

Based on NEISS data, CPSC staff estimates that over the seven-year period from 2016 through 2022 there were 4,500 U.S. hospital emergency department visits (sample size = 185, coefficient of variation = 0.1705) associated with a person (generally a child) accessing a button cell or coin cell battery from a toy.²⁷ An estimated 81 percent of victims ingested or swallowed a button cell or coin cell battery or put a button cell or coin cell battery in their mouth. An estimated 92 percent of the victims were children between the ages of 6 months and 5 years old. An estimated 58 percent of the victims were male, while an estimated 42 percent were female. An estimated 81 percent were treated at the hospital emergency department and released, 16 percent were admitted for hospitalization, and 3 percent were held for observation. Of the 185 sample cases supporting these estimates, none were fatal. To ensure that only button cell and coin cell battery incidents involving toys are captured, CPSC staff's estimates do not include cases that failed to identify battery source or battery type. Accordingly, the injury estimates based on NEISS data are conservative and represent a lower bound for actual ED-treated injuries associated with button cell and coin cell batteries in children's toys.

D. Availability of Incident Data

Upon publication of this NPR in the Federal Register, CPSC will make available for review and comment, to the extent allowed by applicable law, the CPSRMS and NEISS incident reports relied upon and discussed, along with the associated IDIs. The data can be obtained by submitting a request to: [\[insert link\]](#). You will receive a website link to access the data at the email address you provided. If you do not receive a link within two business days, please contact [\[insert email\]](#).

²⁷ One instance involving an 18-year-old who ingested batteries from a toy is included. Two other cases involve 15-year-old children, although the majority of this data includes substantially younger aged children.

E. Child Supervision and Behavior

Battery compartment security is important for toys containing button cell or coin cell batteries because children often play with these types of toys while unsupervised, and infants or toddlers often mouth objects, leading to incidents of battery ingestion or insertion.

Research by Morrongiello and colleagues (2006)²⁸ indicates that older toddlers and preschool children (ages 2 through 5 years old) typically are out of view of a supervising parent for about 20 percent of their awake time at home and are not within visual range or hearing distance for about 4 percent of awake time in the home because caregivers reasonably allow young children to be unsupervised for a few minutes in a presumably safe room. Most caregivers recognize hazards such as a hot stove and actively guard against them; however, items such as toys reasonably do not present a high level of concern. Therefore, consumers may not be aware that certain toys contain button or coin cell batteries and that such products pose a hazard. Often, caregivers notice that a toy is missing a battery only after a child has already accessed it.

Mouthing and ingestion of non-food items is a normal part of children's exploratory behavior that contributes to incidents of choking and poisoning.²⁹ Because of this, CPSC has banned small parts for toys intended for children younger than 3 years of age and mandates small-parts warnings for toys and games intended for children ages 3 to 6 years old.³⁰ Still, toys containing button or coin cell batteries pose a similar danger. Unintentional foreign body ingestion is one of the top five leading causes for nonfatal emergency department visits in

²⁸ Morrongiello, B. A., Corbett, M., McCourt, M., & Johnston, N. (2006). Understanding unintentional injury-risk in young children I. The nature and scope of caregiver supervision of children at home. *Journal of Pediatric Psychology*, 31(6): 529–539.

²⁹ Tulve, N., Suggs, J., McCurdy, T., Cohen-Hubal, E., & Moya, J. (2002). Frequency of mouthing behavior in young children. *Journal of Exposure Analysis and Environmental Epidemiology*. 12, 259 – 264.

³⁰ 16 CFR part 1501; 16 CFR § 1500.19.

children under the ages of 9 years old.³¹ Medical literature indicates that children most commonly ingest or insert foreign objects found in the home environment that are small, round, shiny, and relatively smooth, as are button cell and coin batteries.^{32, 33}

Children develop rapidly, both physically and cognitively, in the first few years of life, learning to grasp object, bring object to their mouth, stand, and often walk all during the first year.³⁴ Between the ages of 12 to 18 months of age, children progress from walking, to running and climbing. Increased mobility, physical strength, and coordination, combined with an inherent predisposition towards curiosity and exploration can lead to dangerous situations for young children who may discover hazardous items.³⁵

F. Recalls

From January 1, 2011, through March 19, 2024, CPSC's Office of Compliance and Field Operations conducted six recalls of toys containing button cell or coin cell batteries. Table 1 below summarizes the recalls, including the press release date, firm, hazard, approximate number of recalled units, number of incidents and injuries reported, and press release number.

³¹ Centers for Disease Control and Prevention. Web-based Injury Statistics Query and Reporting System (WISQARS) [Online]. (2003). National Center for Injury Prevention and Control, Centers for Disease Control and Prevention. Available from: URL: www.cdc.gov/ncipc/wisqars. [10/1/2022].

³² Kay, M., & Wyllie, R. (2005). Pediatric foreign bodies and their management. 7(3):212-8; Lee, J.H., (2018) Foreign Body Ingestion in Children. *Clinical Endoscopy*, 51:129-136; Kramer et al., 2015; Conners GP, & Mohseni M. Pediatric Foreign Body Ingestion. [Updated 2021 Jul 18]. In: StatPearls [Internet]. Treasure Island (FL): StatPearls Publishing; 2022 Jan-. Available from: <https://www.ncbi.nlm.nih.gov/books/NBK430915/> -.(accessed 4/12/22) [Pediatric Foreign Body Ingestion - StatPearls - NCBI Bookshelf \(nih.gov\)](https://pubmed.ncbi.nlm.nih.gov/36111111/).

³³ Svider, P.F., Vong, A., Sheyn, A., Bojrab, D.I., Hong, R. S., Eloy, J.A., and Folbe, A.J. (2015). What are we putting in our ears? A consumer product analysis of aural foreign bodies. *The Laryngoscope*. 125, 709-714; Heim, S.W., & Maughan, K.L. (2007). Foreign Bodies in the ear, nose, and throat. *American Academy of Family Physicians*, 76, p.1186-1189.

³⁴ Frankenburg, W.K., Dodds, J., Archer, P. (1990). The DENVER II Technical Manual 1990, Denver Developmental Materials, Denver, CO.

³⁵ [2020 Age Determination Guidelines | CPSC.gov](https://www.cpsc.gov/2020-Age-Determination-Guidelines).

**Table 1 – Recalls of Toys Containing Button Cell or Coin Cell Batteries
January 1, 2011 to March 19, 2024.**

Press Release Date	Firm	Hazard	Approximate Number of Recalled Units	Number of Incidents & Injuries Reported³⁶	Press Release Number
October 10, 2016	Target	The gel clings can separate and expose the inner decal and LED/button battery compartment, posing choking and button battery ingestion hazards to children.	About 172,000 units Halloween LED Gel Clings	No Injuries Reported	17-020 ³⁷
May 23, 2017	Hobby Lobby	The battery cover can detach and expose the small coin cell batteries, posing choking and ingestion hazards to young children.	About 43,400 units Easter and July 4th-themed Light-Up Spinner Toys	Received one report of a 14-month-old child who ingested the battery.	17-166 ³⁸
December 19, 2019	Toysmith	The battery cover can detach and expose the button-cell batteries, posing choking and ingestion hazards to young children.	About 58,000 units Light-Up Magic Wands	One report of a child swallowing one of the batteries removed from the toy. Medical attention was required to remove the battery.	20-045 ³⁹
May 12, 2021	K & M International	The coin cell battery inside the slap watches can fall out, posing battery ingestion and choking hazards to young children.	About 463,000 units Wild Republic Slap Watches	None reported.	21-134 ⁴⁰
December 1, 2021	Halo Brand Solutions	A child can disassemble the projector flashlight and access the button cell batteries, posing ingestion and choking hazards.	About 82,500 units Projector Flashlights.	Received two reports of children accessing the button cell batteries from the flashlight, and in one case, a child required surgery to remove a swallowed battery.	22-024 ⁴¹

³⁶ When the recall press release delineates the approximate number of recalled units, number of incidents, or number of injuries by country, this summary only includes the reported United States values.

³⁷ <https://www.cpsc.gov/Recalls/2017/Target-Recalls-Halloween-LED-Gel-Clings>.

³⁸ <https://www.cpsc.gov/Recalls/2017/hobby-lobby-recalls-easter-and-july-4th-light-up-spinner-toys>.

IV. Voluntary Standard Development

ASTM F963 includes performance requirements and test methods for children’s toys, as well as requirements for warning labels and instructional literature, to reduce or prevent death of children or injury to children from mechanical, chemical, and other hazards associated with toys. Similar to other ASTM standards, ASTM F963 contains the following sections: scope, terminology, referenced documents, safety requirements, labeling requirements, instructional literature, producer’s markings, test methods, and additional sections appropriate for toys, such as age grading and flammability testing of certain types of toys. Since passage of the CPSIA in 2008, the voluntary standard has been revised five times: ASTM F963–08, ASTM F963–11, ASTM F963–16, ASTM F963–17, and ASTM F963–23. Pursuant to the update procedures in section 106 of the CPSIA, the Commission has accepted the sequential revisions as the mandatory standard. 15 U.S.C. 2056b(g).

Section 4.25 of ASTM F963–23 addresses the safety of all battery-operated toys. Sections 4.25.4 addresses the hazards of choking or swallowing batteries. Section 4.25.4.1 addresses the accessibility of batteries from toy battery compartments for children less than 3 years old, while section 4.25.4.2 addresses the accessibility of small part batteries (*i.e.*, batteries that fit within the small parts cylinder described in 16 CFR 1501.4, including button cell or coin cell batteries). The 2023 update to ASTM F963 included changes to strengthen requirements associated with children accessing batteries, such as adding the definition of a “tool” that may be used to access the battery, strengthening labeling requirements associated with battery

³⁹ <https://www.cpsc.gov/Recalls/2020/Toysmith-Recalls-LightUp-Magic-Wands-Due-to-Choking-and-Ingestion-Hazards>.

⁴⁰ <https://www.cpsc.gov/Recalls/2021/K-M-International-Recalls-Slap-Watches-Due-to-Coin-Cell-Battery-Ingestion-and-Choking-Hazards>.

⁴¹ <https://www.cpsc.gov/Recalls/2022/Halo-Recalls-Promotional-Childrens-Projector-Flashlights-Due-to-Button-Battery-Ingestion-and-Choking-Hazards>.

accessibility, and improving safety requirements by expanding the application of use and abuse testing of toys, including toys containing small part batteries.

Still, ASTM F963–23 does not establish adequate performance requirements for toys containing button cell or coin cell batteries.⁴² Incident data described in section III of this preamble and staff’s toy testing in section V of this preamble demonstrate weaknesses in the ASTM toy standard. For example, existing requirements in ASTM F963–23 are not as stringent as performance requirements in part 1263 for non-toy consumer products, which incorporate UL 4200A. Therefore, ASTM F963-23 fails to adequately address children accessing toy battery compartments, leading to children ingesting or inserting button cell or coin batteries, and fails to provide the highest level of safety feasible.

V. Description and Explanation of the NPR

To address the risk of injury described in section III of this preamble, this NPR proposes to add performance and labeling requirements for toys containing button cell or coin cell batteries. The NPR proposes to add test requirements for captive fasteners, minimum requirements for threaded fasteners, and sequential use and abuse testing (stress relief, battery replacement, impact, crush, torque, tension, compression, and compliance verification tests), and to update marking and labeling requirements. The additional requirements are more stringent than the existing requirements in part 1250 to further reduce the risk of injury from these batteries and represent the highest level of safety feasible to address child ingestion of button cell or coin cell batteries from toys. The additions also are intended to align the requirements for such toys with the requirements for consumer products subject to part 1263, which could

⁴² The Commission issues a direct final rule on September 21, 2023, codifying 16 CFR part 1263, and found that some provisions of ASTM F963 were inadequate to address button cell or coin cell battery hazards. 88 FR 65278, Table 1a.

promote design and manufacturing efficiencies. This section of the preamble describes the proposed additions in new subpart 1250.3, Requirements for Toys Containing Button Cell or Coin Cell Batteries.

A. Performance Requirements

Section 106(c) requires that the Commission periodically review and revise the rules for children's toys, including battery-operated toys, to ensure that such rules provide the highest level of safety for such products that is feasible. Section 106(d) requires the Commission promulgate safety standards for toys that are more stringent than ASTM F963 if the Commission determines that more stringent standards would further reduce the risk of injury.

In the Direct Final Rule by which the Commission implemented Reese's Law (DFR), CPSC staff evaluated the requirements of both ASTM F963-23 and the UL 4200A standard the Commission incorporated by reference pursuant to that statute. 88 FR 65274 (Sept. 21, 2023). Tables 1a and 1b of the DFR that established part 1263 evaluate and compare those two standards. 88 FR 65278-89. Table 1a of the DFR explains that UL 4200A-23 sets requirements for products that require a tool to open the battery compartment, a captive fastener, a minimum number of fastener threads, or two independent motions to open the battery compartment. An accessibility test measures the adequacy of the requirements. Table 2, below, summarizes CPSC staff's review of ASTM F963-23's relevant provisions and whether a higher level of safety than that provided in ASTM F963-23 is feasible for toys containing button cell or coin cell batteries, based on the existing performance requirements in UL 4200A-23 (as incorporated by reference for non-toy consumer products in part 1263) and other international voluntary standards for electrical toys and other products, including IEC 62115 – *Electric toys – Safety* (IEC 62115) and

IEC 62368-1:2023 – *Audio/video, information and communication technology equipment - Part 1: Safety requirements* (IEC 62368-1).

Table 2 – Summary of Assessment of ASTM F963–23 Performance Requirements in Comparison to Other Safety Standards.

	Requirement Category	ASTM F963–23 (Section # - Assessment)	Reference Standard – Section #
Safety Requirements	Battery Accessibility - Use and Abuse Testing	4.25.4 - higher level of safety is feasible	UL 4200A-23 - 6
	Battery Accessibility - Probe	4.25.4.2 - higher level of safety is feasible	UL 4200A-23 - 6.3.5.1
	Captive screws	4.25.4.3 - higher level of safety is feasible	IEC 62115 - 13.4.6
	Threaded fastener securement requirements	Not Addressed - higher level of safety is feasible	UL 4200A-23 - 5.5a
Use and Abuse Testing	Pre-conditioning in oven	Not Addressed - higher level of safety is feasible	UL 4200A-23 - 6.2.1a, IEC 62368-1:2023 - 4.8.4.2
	Simulated battery replacement (x10)	Not Addressed - higher level of safety is feasible	UL 4200A-23 - 6.2.1b
	Normal Use Testing	8.5 - Inadequate	N/A
	Abuse Testing	8.6 - higher level of safety is feasible	UL 4200A-23 - 6
	Drop test - based on product weight/type	8.7.1 - higher level of safety is feasible	UL 4200A-23 - 6.3.2
	Drop test - based on age grading	8.7.1 - higher level of safety is feasible	UL 4200A-23 - 6.3.2
	Battery Compartment Impact Test	Not Addressed - higher level of safety is feasible	UL 4200A-23 - 6.3.3
	Crush Test (big surface area)	Not Addressed - higher level of safety is feasible	UL 4200A-23 - 6.3.4
	Torque Test	8.8 - higher level of safety is feasible	UL 4200A-23 - 6.3.4A
	Tension Test	8.9 - higher level of safety is feasible	UL 4200A-23 - 6.3.4B
Compression Test (little surface area)	8.10 - higher level of safety is feasible	UL 4200A-23 - 6.3.4C	

As summarized in Table 2, and based on staff’s assessment described below, a higher level of safety is feasible for toys containing button cell or coin cell batteries. In fact, only one section of the ASTM standard that is deemed inadequate does not have a comparable UL or International Electrotechnical Commission (IEC) standard. This unique provision, Section 8.5 of ASTM F963–23, addresses normal use testing, which is “intended to simulate

normal use conditions so as to ensure that hazards are not generated through normal wear and deterioration.... The tests are intended to uncover hazards rather than to demonstrate the reliability of the toy.” This section does not define any specific test procedures; for example, it provides only that toys with wheels should be “operated repeatedly.” Accordingly, CPSC preliminarily finds that this section is inadequate to consistently identify hazards and that the abuse testing located elsewhere in ASTM F963–23, UL 4200A–23, and other voluntary standards, as discussed below, is better suited to addressing the risks associated with accessible button cell or coin cell batteries.

The NPR proposes the following performance requirements and test methods to improve safety by addressing the hazards of children ingesting button cell or coin cell batteries that have been accessed from toys.

1. Captive Fasteners

One hazard related to children ingesting button cell or coin cell batteries is that consumers permanently remove or lose the fastener securing the battery compartment cover, thereby exposing the button cell or coin cell battery and allowing child access. Section 4.25.4.3 of ASTM F963–23 requires that fasteners used to secure toy battery compartments shall remain attached to the toy or battery compartment cover before and after testing in accordance with sections 8.5 – 8.10. CPSC staff understands that when conducting use and abuse testing of a battery-operated toy in accordance with sections 8.5 – 8.10 of ASTM F963–23, test laboratories visually inspect any fastener used to secure the battery compartment both before and after testing to verify that the fastener remains attached to the toy or battery compartment cover.

Section 13.4.6 of IEC 62115 – *Electric toys – Safety*, contains a similar requirement for use and abuse testing of fasteners but specifies to verify compliance by both inspection and

through testing: “A force of 20 N is applied to the screw or similar fastener without jerks for a duration of 10 s in any direction.” Under the IEC 62115 requirements, to pass the test the fastener must remain with the toy or battery compartment cover after compliance verification testing, meaning after using a force to make sure that the fastener does not fall off if pushed or pulled. This test method is more stringent than the ASTM F963 test method that allows purely visual inspection, and improves safety by better ensuring that battery cover fasteners remain attached to the product.

To improve compliance verification, the NPR proposes to incorporate into part 1250 a compliance test for battery-operated toys similar to the IEC requirement. The proposed requirement clarifies how to confirm compliance with the requirement in section 4.25.4.3 of ASTM F963–23 and establishes a minimum threshold of attachment force for the fastener. Therefore, to verify the fastener cannot be easily pulled out by a child, and to align with a similar requirement in the international standard IEC 62115, the NPR proposes to add a sentence to section 4.25.4.3, stating that after use and abuse testing, the battery compartment fastener will be subject to 4.5 lbf (20 N) of force, increasing from 0 lbf to 4.5 lbf, within 5 seconds, which should be maintained for a duration of 10 seconds in any direction likely to remove the fastener. The fastener must remain attached to the battery compartment to pass the test. Such functional testing will help further reduce the risk of injury from accessible button cell or coin cell batteries because it works to ensure fasteners cannot be lost or removed completely, thereby keeping batteries better contained.

2. Minimum Battery Compartment Threaded Attachment Requirements

Another hazard related to children ingesting button cell or coin cell batteries is battery compartments being unsecured because the screws intended to keep the door or cover secure

were either too short to remain attached to the toy or did not engage the threads. ASTM F963–23 currently does not have performance requirements addressing the minimum battery compartment fastener length or the removal torque for the door or cover for toys containing batteries.

Section 5.5(a) of UL 4200A–23 includes specific requirements addressing threaded fastener securement and twist-on battery compartment cover securement. In the DFR, the Commission determined that two requirements in UL 4200A–23 adequately ensure battery compartment securement: (1) screws or similar fasteners must engage at least two full threads (*i.e.*, the fasteners must screw into the product for at least two full turns), and (2) battery compartment twist-on access covers shall require a minimum torque of 0.5 Nm (4.4 in-lbf) and a minimum of 90 degrees of rotation to open the compartment. 88 FR 65274.

To ensure that toy battery compartment fasteners are just as secure as non-toy consumer product battery compartment fasteners subject to part 1263, § 1250.3(c)(2)(i)-(iii) of the NPR proposes to add sections 4.25.4.5, .6, and .7 to ASTM F963–23, incorporating requirements consistent with these two UL 4200A–23 provisions. These more stringent requirements work to address incidents of children gaining access to batteries because fasteners had an insufficient length and could be easily removed when the threads did not engage strongly, or twist-on battery compartments were easily opened because minimal force was needed to remove the cover.

3. Sequential Use and Abuse Test Requirements

To address the hazard of button cell or coin cell batteries becoming accessible when a toy breaks, falls apart, or the battery compartment opens unexpectedly, the NPR proposes to add requirements to ensure that batteries remain inaccessible to children during reasonably foreseeable use and misuse of toys. Currently, most of the tests in ASTM F963–23 do not

require sequential testing on a battery-operated toy sample. Section 4.25.4 of ASTM F963–23 requires that the accessibility of button cell or coin cell batteries in toys be determined before and after testing in accordance with the applicable use and abuse test requirements in sections 8.5 – 8.10. The test requirements include normal use testing, abuse testing, impact testing (including drop testing), torque and tension testing, and compression testing. Each individual test may be performed on a toy or component that has not yet been subjected to the abuse testing, in accordance with section 8.1. The Commission preliminarily determines that sequential testing better addresses real-world scenarios of toys experiencing different uses and abuses over time, such as a drop followed by a crush force. It is foreseeable that a toy will endure multiple and varied uses and abuses over time. Therefore, ensuring that a toy battery compartment can withstand various tests sequentially improves safety.

In contrast to the ASTM test method, section 6 of UL 4200A–23 requires that products containing button cell or coin cell batteries have all use and abuse tests conducted sequentially on the same sample. This sequence of tests includes pre-conditioning of plastic products in the oven, simulated battery replacement, drop testing, battery compartment impact testing, crush testing, torque testing, tension testing, compression testing, and compliance verification testing. The sequential testing in UL 4200A–23 means that each test can affect the results of subsequent testing, which results in a more comprehensive and more stringent series of tests as compared to ASTM F963–23.

Illustratively, prior to the 2023 versions of the ASTM F963 and UL 4200A standards, CPSC staff compared the performance of eight toy products when tested to section 4.25.5 of ASTM F963–17 (equivalent to testing to section 4.25.4.2 of ASTM F963–23) and section 6 of

UL 4200A-20.⁴³ Seven of the eight toy products tested were associated with incidents known to CPSC where a child gained access to the toy battery.⁴⁴ Six out of the eight toy products passed ASTM F963 performance requirements and failed the sequential performance requirements in UL 4200A, meaning the battery became accessible. Five of these six toy products failed the simulated battery replacement test in UL 4200A. Two of these six toy products also failed during the drop test, the impact test, and the compliance verification (accessibility) test. This testing further indicates that the performance requirements in UL 4200A better address known hazard patterns for children accessing battery compartments than requirements in ASTM F963 because they better ensure toy battery compartments remain intact when exposed to foreseeable uses and abuses.

To provide a more stringent toy requirement that improves the safety of toys and aligns with the requirement for non-toy consumer products,⁴⁵ the NPR proposes to require similar sequential use and abuse testing for toys containing button cell or coin cell batteries by adding to part 1250 a sequence of tests based on UL 4200A–23: stress relief; battery replacement; drop or tip-over; impact; crush; torque, tension, and compression; and compliance verification.

a. Stress Relief Test

The NPR proposes requiring a pre-conditioning test to account for thermal stress. Thermoplastics, or polymer materials used in certain molding or forming manufacturing processes (such as acrylic, nylon, Polylactic Acid, and polycarbonate), are susceptible to change

⁴³ See March 20, 2023, Letter from Daniel Taxier, Children’s Product Program Manager, and Benjamin Mordecai, Project Manager for ASTM F963, to ASTM Subcommittee and Task Group Chair, regarding Reese’s Law, CPSC staff’s toy testing to F963 and UL-4200A, and recommendations for updates to F963 to align with the Commission’s then-proposed NPR to implement Reese’s Law (available at: <https://www.cpsc.gov/s3fs-public/Letter-to-ASTM-F15-22-Reeses-Law-NPR-230320.pdf?VersionId=6ZGPs5nSLhBGIFdozIIWHF1wo.oOgarH>).

⁴⁴ Refer to the “Incident” column in Table 1 of the March 20, 2023 letter.

⁴⁵ This standard has been incorporated by reference in 16 CFR part 1263 as a safety standard for non-toy consumer products,

when subjected to thermal stresses or heat. In particular, the manufacturing process will leave parts of a molded or formed component stressed after it has cooled to room temperature; then, when exposed to heat, the stress will relax, causing the dimensions and strength of the component to change.

Toys containing button cell or coin cell batteries are regularly exposed to thermal stresses, including during shipping, when left in a hot car or in the sun, and from the battery(ies). To ensure that plastic button cell or coin cell battery compartments in toys are designed and manufactured in a manner that adequately accounts for the effects of heat on the material, the NPR proposes stress relief test requirements that pre-condition the battery compartment, and are intended to ensure that any potential relaxation or warping of molded or formed thermoplastic components does not affect the mechanical integrity of the battery compartment as determined through the subsequent tests in the sequence.

ASTM F963–23 does not require any pre-conditioning testing of battery-operated toys prior to use and abuse testing. The proposed test method is based on the UL 4200A-23 requirement that the entire toy or toy component be placed in an oven at 70°C, or 10°C higher than the maximum operating temperature of the battery compartment, if that temperature would be greater than 70°C, if any part of the battery compartment is made of molded or formed thermoplastic materials.

The proposed test also incorporates some clarifications based on a similar test in IEC 62368-1:2023, allowing battery compartments and the supporting framework to be removed from large and bulky toys and placed in the oven, without the remainder of the product. This clarification allows components of large and bulky toys to be tested in smaller ovens without compromising the test with a large and bulky object interfering with use of the appropriate test

oven. The proposed requirement also clarifies that the batteries may be removed from the compartment during the test, which will not affect the outcome. The proposed pre-conditioning test ensures that battery compartments of toys containing button cell or coin batteries withstand potential thermal stressors that may weaken the compartment and allow children's access to batteries, risking ingestion, or insertion.

b. Battery Replacement Test

The NPR proposes testing requirements for toys with a replaceable battery to address the hazard of battery compartments becoming unsecure after a user replaced the battery and the fastener or battery compartment threads became stripped, thereby preventing proper securement of the battery compartment, allowing a child to access the battery. The data described above includes four such nonfatal incidents. ASTM F963–23 does not require any simulated battery replacement tests. However, repeated opening and closing of a battery compartment locking mechanism has the potential to reduce the strength of the lock. This is particularly true when threaded fasteners are used and threads of different hardness engage with each other (such as a metal screw into a plastic toy), creating the potential for the harder material to damage or strip the threads from the softer material.

UL 4200A–23 addresses this hazard in section 6.2.1b by requiring that the battery compartment is opened; the battery is removed and replaced; and the battery compartment is closed and secured 10 times. If the battery compartment is secured with a fastener, the screw must be loosened and tightened using a suitable screwdriver and a continuous linear torque in accordance with Table 20 of UL 60065 *Standard for Audio, Video and Similar Electronic Apparatus – Safety Requirements*.

The proposed test method is based on UL 4200A–23, but similar requirements can be found in the international standards IEC 62115 and IEC/UL 62368-1. The test requires that the battery compartment door or cover be opened, the battery removed and replaced, and the battery compartment door closed 10 times. If the battery compartment is secured with one or more screws, then the screws are to be loosened and tightened using a suitable screwdriver, and a continuous linear torque must be used in accordance with the Torque to be Applied to Screws table, Table 20, of UL 60065, *Standard for Audio, Video and Similar Electronic Apparatus – Safety Requirements*.

c. Drop Test and Tip over Test

Drop testing has long been used to assess the durability of toys, yet the data contains reports of 50 nonfatal incidents where a toy’s battery compartment broke apart or opened unintentionally, including nine incidents specifically describing the toy as having been dropped. Staff’s testing, along with the incident reports, illustrates the need for rigorous drop testing to ensure the integrity of the battery compartment.

Section 8.7.1 of ASTM F963–23 outlines drop test requirements based on the age grading of the toy and specific weight limits. The age grading of the toy determines the maximum weight of the toy subject to the test; the number of drops; and the drop height. For example, a toy for a child age 18 months or less must weigh 3.01 lbs. (1.4 kg) or less to be subject to the drop test, and it would be dropped 10 times from a height of 4.5 ft; a toy for a child age over 36 months to 96 months must weigh 10.01 lbs. (4.5 kg) or less to be subject to the test, and it would be dropped four times from a height of 3 ft. Toys are dropped in a random orientation onto 1/8-inch-thick vinyl tile over concrete with the batteries in place. Large and bulky toys, defined as toys with a projected base area of more than 400 square inches (0.26 m²) or a volume of more

than 3 cubic feet (0.08 m³), are subject to the tip-over test in section 8.7.2 instead of the drop test. These toys are tipped over three times onto the same test surface as used in the drop test.

Comparatively, section 6.3.2 of UL 4200A–23 varies the number of drops for each product based on the weight of the product and how the product is used. A portable device, which is reasonably foreseeable to be routinely carried or lifted but not operated during transit with a mass not exceeding 19 kg (39.7 lbs.), is dropped three times. A hand-held product, which is reasonably foreseeable to be used or misused while being held in one or both hands, with a mass not exceeding 4.5 kg (10 lbs.), is dropped 10 times. Products are dropped in positions likely to produce the maximum force on the battery compartment from a height of 1.0 m (3 ft 3.4 in) onto a hardwood surface.

The application of both the ASTM F963–23 drop test and the UL 4200A–23 depend on characteristics of the product intended to be dropped to determine the appropriate test protocol, and as a result, which of the tests is more stringent than the other depends on what product is being tested. For example, the impact surface used in ASTM F963–23 is harder than the surface used in UL 4200A–23 and is therefore expected to produce greater impact forces on the toy. Meanwhile, all hand-held products weighing 10 lbs. or less are dropped 10 times in UL 4200A–23, while many toys weighing 10 lbs. or less are subject to only four drops or are not dropped at all pursuant to ASTM F963–23 test requirements. Additionally, the drop test in UL 4200A–23 targets the button cell or coin cell battery compartment for failure, while the drop test in ASTM F963–23 is intended to identify ingestion hazards and other hazards, such as small parts, sharp edges, or other hazards generally created by the test.

Because aspects of the drop test in UL 4200A–23 are more stringent than the drop test in ASTM F963–23 and better ensure the integrity of the battery compartment, the proposed test

OS 38
DRAFT

combines aspects of the drop test in UL 4200A–23 with the drop test in ASTM F963–23 to achieve the highest level of safety feasible for toys containing button cell or coin cell batteries. The proposed test surface is vinyl tile on concrete, consistent with the test surface currently used for toy drop testing in ASTM F963–23. The vinyl on concrete test surface will absorb less energy and produce a harder impact as compared to the wood test platform used in UL 4200A–23. The proposed test also uses minimum drop heights based on the specifications in Table 5 of ASTM F963–23: 4.5 ft (137 cm) for toys for children aged 0 to 18 months, and 3.0 ft (91 cm) for all other toys. The drop height specified in UL 4200A–23 is 1.0 m (100 cm, 3.3 ft). While the UL 4200A–23 drop height is greater than the proposed drop height for toys for children ages over 18 months, the Commission expects that the harder test platform in the proposed drop test will ultimately make the test at least as stringent as the UL 4200A–23 drop test. This expectation is based on testing of a product which failed both the ASTM F963–23 drop test and the UL 4200A–23 drop test (see section V.A.3. of this preamble).

Establishing separate weight tiers based on age grading is not appropriate for this test given known incidents where sibling interaction could have contributed to the incident, including cases where younger siblings were playing with an older sibling’s toy.⁴⁶ Instead, the proposed test method uses a 10 lbs. product weight criteria for all toys to establish a maximum weight for the drop test. The proposed weight limit is consistent with the weight limit for hand-held products in UL 4200A–23, which uses a lesser number of drops for portable devices weighing up to 18 kg (39.7 lbs.) that are carried or lifted but not operated during transit as part of their foreseeable use or misuse. The proposed test adapts the drop test for such portable products in UL 4200A–23 for toys weighing at least 10.01 lbs. up to 39.7 lbs., and it also adds the existing

⁴⁶ CPSC staff has identified 24 such incidents.

tip-over test for large and bulky toys from section 8.7.2 of ASTM F963–23. CPSC staff anticipates that most toys weighing at least 10.01 lbs. would be subject to the proposed tip-over test, rather than the proposed drop test. The Commission seeks comment on whether there are toys for which the proposed drop test for toys weighing at least 10.01 lbs. up to 39.7 lbs. would ever be applicable instead of the proposed tip-over test, and whether the drop test should be removed for these heavier toys.

d. Impact Test

The Commission is aware of 50 reported nonfatal incidents where a toy’s battery compartment broke apart or opened unintentionally, including two incidents where the toy was described as having been thrown or smashed. To address this hazard, the NPR proposes mandating an impact test directly on the battery compartment. The proposed test is based on the test in UL 4200A–23 and simulates impacts directly to the toy battery compartment.

ASTM F963–23 does not adequately address direct impacts to battery compartment enclosures that can occur when children throw, punch, kick, or smash toys together or against another surface (such as furniture). The drop test in section 8.7.1 simulates random impacts from flat surface contact and the compression test in section 8.10 applies a static load on surfaces not contacted by the flat surface in the drop test, but neither of these tests adequately tests to protect against batteries becoming unintentionally accessed from toy battery compartments because these tests do not simulate direct impacts against the battery compartment.

To address direct impacts to battery compartment enclosures that can occur when children throw, punch, kick, or smash toys together or against another surface (such as furniture), the proposed test adopts the impact test used in UL 4200A–23 and in several other voluntary standards, such as IEC/UL 62368-1, which subjects the battery enclosure or compartment

door/cover to three impacts with an energy of 1.5-ft·lbf (2-J). The impacts are produced by either dropping or swinging a 2.00 in. (50.8 mm) diameter steel sphere, weighing approximately 1.1 lbs. (0.5 kg), from the height necessary to produce the specified kinetic energy at impact, as shown in Figures 6 and 7. The sphere must strike the battery enclosure or compartment door/cover perpendicular to the surface to ensure the impact has the maximum amount of energy possible.

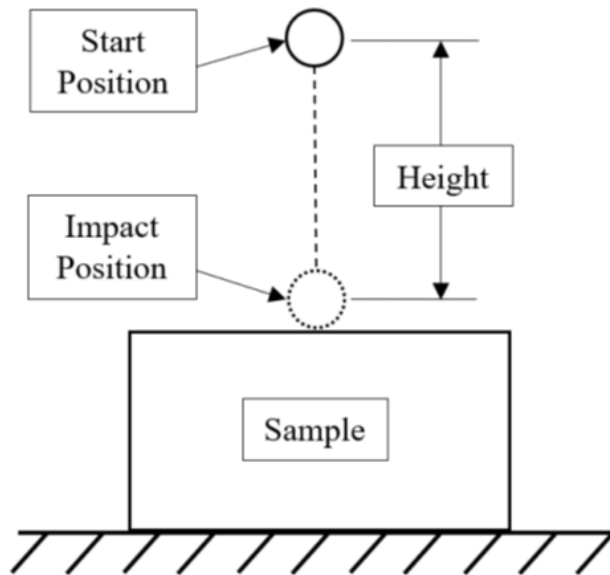

Figure 6. Example impact test with a dropped steel sphere

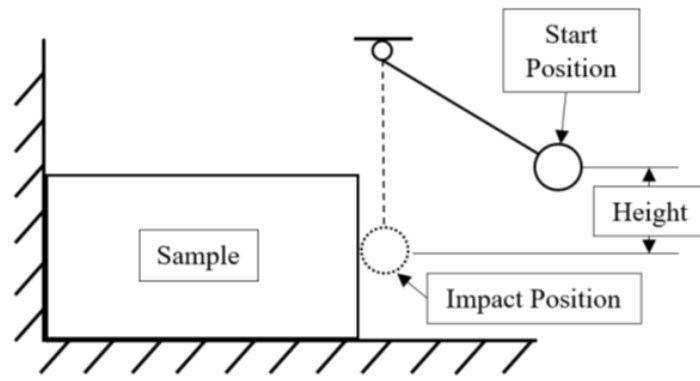

Figure 7. Example impact test with a swinging steel sphere

e. Crush Test

The NPR proposes requiring a test to account for crushing forces exerted on toys during normal use and abuse, such as if a person steps on a toy, to ensure the battery compartment remains intact and does not break open. ASTM F963–23 does not include a test to address this hazard pattern. Staff has reviewed incident data demonstrating that a battery can become accessible when a child crushes a toy that is required to comply with ASTM F963 as incorporated in 16 CFR part 1250. The NPR therefore proposes adopting a crush test based on the test in section 6.3.4 of UL 4200A–23 for all toys subject to the rule. This test simulates a crushing force, such as the force exerted on a toy from a child or adult stepping or sitting on it, to ensure the toy does not split open and allow access to the battery. The crush test involves placing the toy sample on a fixed rigid supporting surface (such as the floor or a flat rigid table), in stable positions likely to produce the most adverse results. The test applies a crushing force of $74.2 \text{ lbf} \pm 1.1 \text{ lbf}$ ($330 \text{ N} \pm 5 \text{ N}$) for a period of 10 seconds to exposed surfaces using a flat surface measuring approximately 3.9 in by 9.8 in (100 mm by 250 mm). The more stringent requirements directly address one scenario in which children have accessed batteries, as shown in the incident data.

f. Torque, Tension, and Compression Tests

The NPR proposes including torque, tension, and compression tests to address the hazard of children manipulating a toy with their hands or mouth to open the battery compartment. The data includes nine nonfatal incidents where children were able to open the compartment in this manner. Sections 8.8, 8.9, and 8.10 of ASTM F963–23 include torque, tension, and compression use and abuse tests that simulate a child grasping a component (with at least a thumb and forefinger, or with teeth). Testing involves use of a clamp to grab the toy component, and then

the part is twisted (torque) or pulled (tension). The compression test is applied to any area on the surface of a toy that is accessible to a child and not exposed to flat surface contact during the impact (drop) test. A flat metal disk with a diameter of 1.125 inches (28.58 mm) and a thickness of 0.375 inches (9.52 mm) is pressed into the surface. Like the drop test, the forces and torques applied in these tests depend on the age grading of the toy. Torques range from 1.8 in·lbf to 4.2 in·lbf (0.20 Nm to 0.47 Nm); tensile forces range from 9.5 lbf to 15.5 lbf (42 N to 69 N); and compression forces range from 19.5 lbf to 30.5 lbf (86.7 N to 135.7 N). The torque and tension tests are conducted in sequence with each other, but these tests are otherwise not conducted in sequence with the other ASTM tests.

In contrast, all of the use and abuse tests outlined in UL 4200A–23 are conducted in sequence. UL 4200A–23 requires the same torque, tension, and compression tests as ASTM F963–23 but applies the tests specifically to the battery compartment and has higher minimum torque and force values. Under the UL standard, the minimum torque is 0.5 Nm (4.4 in·lbf);⁴⁷ the minimum tensile force is 72.0 N (16.2 lbf); and the minimum compression force is 136 N (30.6 lbf). These higher forces and torques in the UL test are better able to ensure the integrity of the battery compartment than the ASTM test. Accordingly, the proposed torque, tension, and compression test sequence are based on the existing methods in sections 8.8 – 8.10 of ASTM F963–23 and must be conducted in the same order in which they appear, while the proposed minimum values align with UL 4200A–23 to achieve the highest feasible level of safety to best address unintended access to toy battery compartments.

⁴⁷ This minimum torque aligns with the required torque for twist-on access covers.

g. Compliance Verification Test

CPSC staff is aware of incidents of children gaining access to button cell or coin cell batteries from toy battery compartments without the use of a tool, such as a screwdriver. Section 4.25.4.2 of ASTM F963–23, *Battery Accessibility*, requires that batteries which fit completely within the small parts test cylinder (including button cell and coin cell batteries), shown in Figure 4 from 16 CFR part 1501.4, shall not be accessible without requiring the use of a common household tool.⁴⁸ Any area of the toy that can be contacted by any portion forward of the collar of the probes shown in Figure 5 is considered to be accessible.⁴⁹ Per section 4.25.4.4, specialty fasteners may also be used to secure the battery compartment.⁵⁰ Because the accessibility probes have hinges, they reflect the bending functionality of a finger, however the probes cannot be applied with force like that of a real finger because of limitations associated with hinging ability.

UL 4200A–23 uses a rigid finger probe to determine battery accessibility. Section 5.3 of UL 4200A–23 requires application of a test probe, Test Probe 11 of IEC 61032 *Standard for Protection of Persons and Equipment by Enclosures – Probes for Verification*, with minimum force before testing to determine accessibility and, per section 6.3.5, application of the probe with 50 N (newtons) to 60 N (11.2 lbf to 13.4 lbf) after testing to verify the battery compartment enclosure remains functional. The data described above includes incidents where children were able to access toy battery compartments by manipulating the product with hands or teeth. To address this hazard, application of a finger probe with force after testing is necessary to verify the secureness of toy battery compartments. This cannot be accomplished with the accessibility

⁴⁸ By definition, common household tools include straight-blade or Phillips screwdrivers, pliers, coins, or other objects commonly found in most households.

⁴⁹ Probe A is for toys age graded for children 0 – 36 months, and Probe B is for toys age graded for children 37 – 96 months.

⁵⁰ Specialty fasteners (such as with Torx or Hex drivers) may be used to secure battery compartments, so long as the tool is included with the toy and specific instructional material is included.

OS 44
DRAFT

probe in ASTM F963–23 but can be accomplished with the accessibility probe in UL 4200A–23. Therefore, the use of the accessibility probe in UL 4200A–23 is necessary to further reduce the risk of injury from accessible button cell or coin cell batteries. To address this hazard, the proposed test uses the design of Test Probe 11 of the *Standard for Protection of Persons and Equipment by Enclosures – Probes for Verification*, IEC 61032. The probe is used to apply 11.2 lbf + 2.2/-0 lbf (50 N + 10/-0 N) for 10 seconds at the most unfavorable place and in the most unfavorable direction to ensure that the battery compartment door/cover does not open and remains functional, while also verifying that the battery is not touched or made accessible.

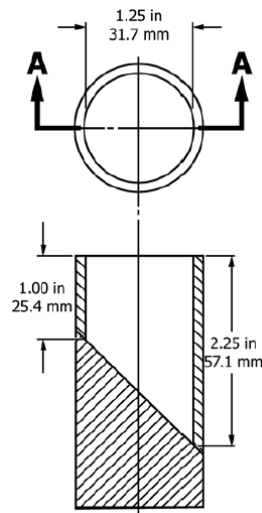

Figure 4. Small Parts Cylinder (16 CFR part 1501.4)

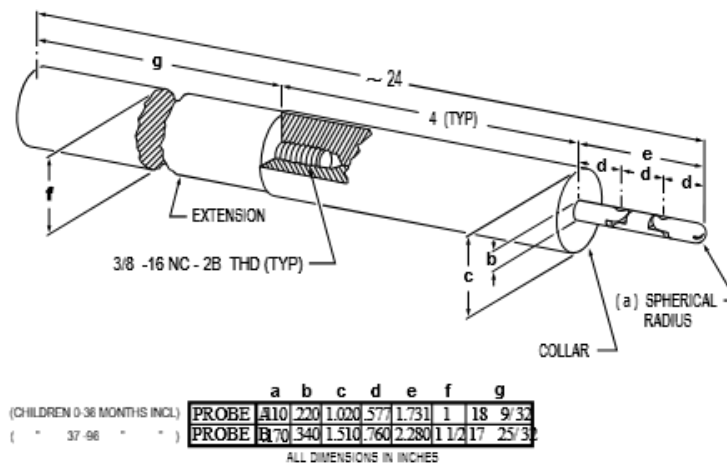

Figure 5. Accessibility Probes

The proposed test method addresses 50 reported nonfatal incidents where the toy battery compartment broke apart or opened unintentionally, including nine nonfatal incidents where children accessed batteries from the battery compartment while playing with the toy with their hands and mouth.⁵¹ This test verifies that the battery compartment enclosure remains secure and functional beyond the use of the accessibility probe currently referenced in ASTM F963–23.

B. Marking, Warning, Labeling, and Instructional Literature Requirements

During the Reese’s Law rulemaking process, staff evaluated required warnings for battery-operated toys in ASTM F963–17, the previous version of ASTM F963. Tab C, Appendix A, Reese’s Law NPR SBP. Warning requirements for battery-operated toys have not changed between the 2017 version of ASTM F963 and ASTM F963–23. ASTM F963 sets forth uniform methods of addressing mechanical and chemical safety hazards and associated safety messaging in toys that are intended for children. Table 3 summarizes CPSC’s review of marking and labeling requirements in ASTM F963–23 and whether a higher level of safety is feasible for toys containing button cell or coin batteries based on requirements in other safety standards. Detail of staff’s analysis follows.

**Table 3 – Summary of Assessment of ASTM F963–23
Marking and Labeling Requirements in Comparison to UL 4200A–23.**

	Requirement Category	ASTM F963–23 (Section # - Assessment)	Comparison (Standard - Section #)
Warnings	On Toy Product Packaging	5.14.2 - higher level of safety is feasible	UL 4200A-2023 - 7B
	On Toy Products	4.25.1 - higher level of safety is feasible	UL 4200A-2023 - 7C
	In Accompanying Instructions	5.14.2- higher level of safety is feasible	UL 4200A-2023 - 9

Packaging – Section 5.14.2. of ASTM F963–23 requires that toys powered by “button or coin cell batteries that are 1.5 volts or greater, regardless of chemistry, and are greater than

⁵¹ In one of these incidents, Y214K670A, the battery compartment opened while the fastener remained in place. This failure mode may not be detected using ASTM F963–23’s existing accessibility probe because the probe cannot be applied with force due to its joints.

15mm in diameter and fit within the small parts cylinder” must have the following warning on the toy packaging:

- **⚠ WARNING:** “Contains button or coin cell battery. Hazardous if swallowed – see instructions” (§ 5.14.2.1 (1)).

Products with batteries subject to the packaging requirements specified in UL 4200A–23 are not limited by battery voltage or diameter; all consumer products containing button cell or coin cell batteries are included (with the exception of toys and zinc-air batteries). The Commission has determined that zinc-air button cell or coin batteries do not present an ingestion hazard. 16 CFR § 1263.1(d). Both ASTM F963–23 and UL 4200A–23 require similar warning formats with a signal word, safety alert symbol (*e.g.*, exclamation mark in a triangle), and message statement noting the presence of button cell or coin cell batteries. The UL 4200A–23 warning label improves safety compared to the ASTM warning, however, because it also provides an explicit hazard statement and detailed hazard information, the severity and consequences if the warning is disregarded, and appropriate hazard-avoidance behaviors. The warning additionally instructs the consumer to take appropriate action should they suspect a button cell or coin cell battery was ingested. Specifically, the warning label shall have the following statements,

- **INGESTION HAZARD:** This product contains a button cell or coin battery.
- **DEATH** or serious injury can occur if ingested.
- A swallowed button cell or coin battery can cause **Internal Chemical Burns** in as little as **2 hours**.
- **KEEP** new and used batteries **OUT OF REACH OF CHILDREN**.
- **Seek immediate medical attention** if a battery is suspected to be swallowed or inserted inside any part of the body.

The UL warning label format uses a bulleted list, capitalization, and bolding that aligns with industry best practices as outlined in ANSI Z535.4 (American National Standard for Product Safety Signs and Labels) and ASTM’s Ad Hoc Language Task Group recommendations.

OS 47
DRAFT

Additionally, UL 4200A–23 incorporates the use of a safety icon accompanying the text to quickly attract the reader’s attention to the label. Either the “Keep out of Reach” icon or the internationally recognized “Warning: Contains coin battery” icon may be used depending on applicability.

Product – ASTM F963–23 safety labeling requirements for toys that use batteries must specify the type of battery, the size of the battery, and the number of batteries used within the toy. Section 4.25.1 of ASTM F963–23 requires that the toy be marked with battery polarity, size, and voltage, although size and voltage may be provided in the instructions. It also requires additional on-product markings if the toy is powered by more than one battery per circuit.

Pursuant to section 6.5 and 5.14 of ASTM F963, the toy or instructions must state the following:

- “Do not mix old and new batteries.”
- “Do not mix alkaline, standard (carbon-zinc), or rechargeable batteries.”
- “Battery is not replaceable” (if applicable).

Additionally, the location of on-product safety labeling is dependent on the size of the product, as determined by the manufacturer. If the product is too small, the above information must be included in the toy instructions. Button cell or coin cell battery-operated toys are not required to be marked if the toy is so small that marking is not feasible. UL 4200A–23 on-product marking requirements include a warning label identifying an ingestion hazard and the presence of a button cell or coin cell battery. If the toy’s small size limits the ability to print a warning on the product, the warning can be replaced with an internationally recognized warning icon. If a toy’s small size does not allow inclusion of an on-product warning or icon, UL 4200A–23 requires that a hangtag or sticker label be included with the toy.

Instructions – ASTM F963–23 requires toys powered by “button or coin cell batteries that are 1.5 volts or greater, regardless of chemistry, and are greater than 15mm in diameter and fit within the small parts cylinder” to have the following instructions:

▲ WARNING: This product contains a Button or Coin Cell Battery. A swallowed Button or Coin Cell Battery can cause internal chemical burns in as little as two hours and lead to death. Dispose of used batteries immediately. Keep new and used batteries away from children. If you think batteries might have been swallowed or placed inside any part of the body, seek immediate medical attention.

If the toy does not come with instructions, the above warning must be on the packaging or on a paper insert inside the toy packaging. Products with accessible (with the use of a coin, screwdriver or household tool), non-replaceable batteries must contain a statement that the batteries are not replaceable. UL 4200A–23 has the same requirement for non-replaceable button cell or coin cell batteries. As previously discussed, the UL 4200A–23 warning label requires detailed warning message statements and a safety icon to capture the reader’s attention; these requirements are not dependent on battery voltage or diameter. This same warning must be printed on the instructions or manual if provided. Similar to the ASTM F963–23 standard, should no instructions or manual be provided, UL 4200A–23 requires the warning to be on the packaging, or it must be on a hangtag or sticker label if the product does not include packaging. UL 4200A–23 requires additional battery safety information on the product packaging or in the instructions/manual as applicable. These statements address battery replacement and disposal, compatibility with the product, securement of the battery compartment, and electrical or fire hazards associated with misused batteries.

Section 1263.4, which implements Reese’s Law for consumer products generally, establish warning label requirements for the packaging of button cell or coin batteries, while § 1263.3 incorporates the labeling requirements in UL 4200A–23, which establish warnings for the

consumer product packaging, battery compartment, and accompanying instructional materials. To provide the highest level of safety feasible, this NPR seeks to align required warnings for toy packaging, toy battery compartments, and accompanying instructional literature, with part 1263 because such requirements are worded and formatted in a manner that better warns of hazards identified in the incident data and better captures reader's attention.

The proposed formatting requirements taken from part 1263 are based largely on warning label research and ANSI Z535.4, which is the primary voluntary consensus standard providing guidelines for the design of safety signs and labels for application to consumer products. ANSI Z535.4 includes recommendations for the design, application, use, and placement of warning labels, such as having the signal word "WARNING" and the safety alert symbol of an equilateral triangle surrounding an exclamation mark. Tab C, Reese's Law NPR SBP. Children's juvenile product standards, as well as standards involving common household items that may be hazardous to children, commonly rely on the warning formatting specifications in ANSI's Z535.4.

Spare batteries included with toys not contained in child-resistant packaging present an ingestion hazard to children. Pursuant to section 3 of Reese's Law, the Commission already requires that button cell or coin cell batteries included separately within toy packaging meet child resistant packaging requirements to address the possibility of children opening and accessing the contents of retail toy packaging. As such, the Commission already requires that button cell or coin cell battery packaging, including button cell or coin cell batteries sold separately along with a toy, meet § 1263.4, Requirements for labeling of button cell or coin battery packaging.

VI. Feasibility of Proposed Requirements

Pursuant to section 106(c) of the CPSIA, Congress directed the Commission to “periodically review and revise the rules set forth under this section to ensure that such rules provide the highest level of safety for such products that is feasible.” 15 U.S.C. 2056b(c). The safety hazards identified in section III of this preamble can feasibly be addressed by the requirements proposed in this NPR.

Many toys on the market already comply with the proposed requirements. The technology to comply is already available (*e.g.*, threaded fasteners), and the proposed requirements align with existing, already-required performance requirements applicable to non-toys products in part 1263, which are currently on the market. Third party labs are already International Organization for Standardization (ISO) accredited and CPSC-accepted to test to UL 4200A; complying with the proposed requirements for toys would use the same or similar testing and test equipment.

Nor will the proposed rule present insurmountable economic challenges. Staff estimates that only 20 percent of the manufacturers and importers/wholesalers (approximately 3,775) would incur any costs related to redesign required by the proposed rule. As stated in section IX of this preamble, the maximum cost expected per firm to redesign a battery compartment is \$6,586, which equates to a maximum total cost to the industry of approximately \$25 million. Estimates of U.S. children’s toys sales revenue in 2023, published by Circana,⁵² equate to a total industry size of \$28 billion. Maximum cost estimates are 0.09 percent of revenue.

⁵² 2023 US Toy Industry Sales Analysis - Circana. <https://www.circana.com/intelligence/press-releases/2024/us-toy-industry-sales-decline-8-in-2023-while-remaining-5-7-billion-above-2019-sales-circana-reports/>.

VII. Incorporation by Reference

Section 1250.3 of proposed rule would incorporate by reference UL 60065, *Standard for Audio, Video and Similar Electronic Apparatus – Safety Requirements*, Table 20 (Torque to be Applied to Screws) and IEC 61032, *Standard for Protection of Persons and Equipment by Enclosures – Probes for Verification*, Test Probe 11. The Office of the Federal Register (OFR) has regulations regarding incorporation by reference. 1 CFR part 51. Under those regulations, agencies must discuss, in the preamble to a final rule, ways the material the agency incorporates by reference is reasonably available to interested parties and how interested parties can obtain the material. In addition, the preamble to the final rule must summarize the material. 1 CFR § 51.5(b)(3).

In accordance with the OFR regulations, section V of this preamble summarizes the major provisions of UL 60065, *Standard for Audio, Video and Similar Electronic Apparatus – Safety Requirements*, Table 20 (Torque to be Applied to Screws) and IEC 61032, *Standard for Protection of Persons and Equipment by Enclosures – Probes for Verification*, Test Probe 11 that the Commission proposes to incorporate by reference into proposed § 1250.3. The standard itself is reasonably available to interested parties. By permission of UL and IEC, the standards can be viewed as read-only documents during the comment period for this NPR, at: [\[INSERT HYPERLINK\]](#). Interested parties can also schedule an appointment to inspect a copy of the standard at CPSC’s Office of the Secretary, U.S. Consumer Product Safety Commission, 4330 East-West Highway, Bethesda, MD 20814, telephone: (301) 504-7479; e-mail: cpsc-os@cpsc.gov. Alternatively, interested parties can purchase copies of the standard from ANSI, 11 West 42nd Street, New York, New York, 10036, (212) 642-4900.”

VIII. Effective Date

The Administrative Procedure Act (APA) generally requires that the effective date of a rule be at least 30 days after publication of the final rule. 5 U.S.C. 553(d). The rule would apply to all toys containing button cell or coin cell batteries manufactured after the effective date. 15 U.S.C. 2058(g)(1).

Although many toys may already comply with the proposed requirements, some toys would need to be redesigned, and all toys containing button cell or coin cell batteries would require third-party testing to the new requirements. 15 U.S.C. 2063(a)(3).⁵³ Accordingly, to provide time to comply with the rule, to ensure adequate lab capacity to test and certify toys, and to spread the cost of compliance over approximately six months, the Commission proposes to make this rule effective 180 days after publication of the final rule in the Federal Register.

Although the NPR proposes to add performance requirements, 180 days should be sufficient to come into compliance, because battery-operated toys already must satisfy third party testing, and because the proposed new test methods and test equipment are consistent with the testing required in part 1263, incorporating ANSI/UL 4200A-23, which utilizes similar methods and equipment. For example, currently 142 third party laboratories are CPSC-accepted to test to part 1250's requirements for battery-operated toys, and 35 labs are CPSC-accepted to test to part 1263. Accordingly, CPSC expects that these laboratories are competent to conduct the required testing and can have their ISO accreditation and CPSC-acceptance updated in the normal course. The Commission invites comments, particularly from small businesses, regarding the proposed testing and the amount of time needed to come into compliance with a final rule.

⁵³ Section 14(a)(3) specifies laboratories must have at least 90 days to test for compliance.

IX. Regulatory Flexibility Act (RFA)

The RFA requires agencies to review each proposed rule's potential economic impact on small entities, including small businesses. Section 603 of the RFA generally requires that agencies prepare an initial regulatory flexibility analysis (IRFA) and make the analysis available to the public for comment when the agency publishes an NPR, unless the rule would not have a significant economic impact on a substantial number of small entities. 5 U.S.C. 603, 605(b).

If the proposed rule is finalized, CPSC staff does not expect a significant impact to a substantial number of small businesses. Small manufacturers may incur a one-time redesign cost and ongoing component costs (*i.e.*, screws and threads) to comply with the rule for product lines that currently do not meet the proposed requirements. However, CPSC does not expect small firms to incur a cost that exceeds 1 percent of the annual revenue of the firm (nor 1 percent of the retail price of the product). Therefore, the Commission certifies that the rule will not, if promulgated, have a significant economic impact on a substantial number of small entities.

A. *Reason for Agency Action, NPR Objectives, Product Description, and Market Description*

Section I of this preamble explains why CPSC proposes to establish mandatory requirements for toys containing button cell or coin cell batteries to prevent access to battery compartments by children aged 6 years old and younger and provides a statement of the objectives of, and legal basis for, the proposed rule. Section II of this preamble describes the types of products within the scope of the NPR, the market for button cell and coin cell batteries in toys, and the use of such batteries in toys in the U.S. The requirements in the NPR are more stringent than ASTM F963-23, which was incorporated into the mandatory rule 16 CFR part 1250, as described in sections IV and V of this preamble. The NPR addresses the known

ingestion hazard, discussed in section III of this preamble, that the current rule does not adequately address.

B. Small Entities to Which the Rule Would Apply

Section II of this preamble describes the products within the scope of the rule and provides an overview of the market for toys containing button cell or coin cell batteries. This section of the preamble provides additional details on the market for products within the scope of the rule.

The North American Industry Classification System (NAICS)⁵⁴ defines product codes for U.S. firms. Firms that manufacture button cell or coin cell battery-powered children's toys may list their businesses under various NAICS product codes, as these toys include a variety of children's products, such as dolls and musical instruments. Most of these firms likely fall under NAICS code 339930 Doll, Toy, and Game Manufacturing, but some may also fall under code 339992 Musical Instrument Manufacturing or 339999, All Other Miscellaneous Manufacturing. Importers of battery-operated toys containing button cell or coin cell batteries also fall under multiple NAICS codes, with a majority of the firms following under NAICS codes as wholesalers: 423920 Toy and Hobby Goods and Supplies Merchant Wholesalers, 423910 Sporting and Recreational Goods and Supplies Merchant Wholesalers, and 423990 Other Miscellaneous Durable Goods Merchant Wholesalers.

Retailers of toys containing button cell or coin cell batteries similarly include a variety of retailer types, from large "big box" retailers to smaller specialized product firms. CPSC staff estimates that a majority of these products fall under NAICS codes 459120 Hobby, Toy, and

⁵⁴ The NAICS is the standard used by Federal statistical agencies in classifying business establishments for the purpose of collecting, analyzing, and publishing statistical data related to the U.S. business economy. For more information, see <https://www.census.gov/naics/>. Some programs use 6-digit NAICS codes, which provide more specific information than programs that use more general 3- or 4-digit NAICS codes.

Game Stores, 451110 Sporting Goods Stores, 459140 Musical Instrument and Supplies Stores, 455110 Department Stores, and 455211 Warehouse Clubs and Supercenters. Some of these products may also be sold in stores coded as 445110 Grocery Stores, 445121 Convenience Stores, and 443142 Electronic Stores, among other outlets; however, CPSC expects the number of such toys sold at these stores to be negligible.

Under U.S. Small Business Administration (SBA) guidelines, a manufacturer, importer, and retailer of toys containing button cell or coin cell batteries is categorized as “small” based on the SBA’s size thresholds associated with each NAICS code. SBA uses the number of employees to determine whether a manufacturer or importer is a small entity, while SBA uses annual revenues to consider a retailer. Based on the U.S. Census Bureau’s 2021 and 2017 Statistics of U.S. Businesses (SUSB) data, CPSC staff estimated the number of firms classified as small for the most relevant NAICS codes. Tables 4 and 5 provide the estimated number of small firms by each NAICS code.⁵⁵ Staff estimates a total of 18,968 small manufacturers and importers, and 28,619 small retailers.

Table 4 – Estimated Number of Small Manufacturers and Importers.

NAICS Code	Description	SBA Size Standard for Firms (# of Employees)	Number of Firms that meet size standard (Based on SUSB data)
339930	Doll, Toy, and Game Manufacturing	700	485
339992	Musical Instrument Manufacturing	1000	587
339999	All Other Miscellaneous Manufacturing	550	2,951
423920	Toy and Hobby Goods and Supplies Merchant Wholesalers	175	1,846
423910	Sporting and Recreational Goods and	100	4,432

⁵⁵ Some discrepancies exist between the published SBA size standard NAICS code and the SUSB code. Staff used the code description to match the size standard to the correct value. Retailer size determination is made using 2017 SUSB data by applying the ratio of firms that meet the standard to the 2021 data values.

	Supplies Merchant Wholesalers		
423990	Other Miscellaneous Durable Goods Merchant Wholesalers	100	8,567

Table 5 – Estimated Number of Small Retailers.

NAICS Code	Description	SBA Size Standard for Firms (Annual Revenue) Millions \$	Number of Firms that meet size standard (Based on SUSB data)
452210	Department Stores	\$40.0	15
452310	General Merchandise Stores, Including Warehouse Clubs and Supercenters	\$47.0	8,006
451110	Sporting Goods Retailers	\$26.5	13,751
451120	Hobby, Toy, and Game Stores	\$35.0	4,660
451140	Musical Instrument and Supplies Stores	\$22.5	2,187

C. Compliance Requirements of the NPR, Including Reporting and Recordkeeping Requirements

The NPR would improve the performance and labeling requirements applicable to toys containing button cell or coin cell batteries. Under section 14 of the CPSA, manufacturers, importers, and private labelers of toys containing button cell or coin cell batteries would be required to certify, based on testing by an ISO-accredited, CPSC-accepted third party conformity assessment body, that their toy complies with the requirements of the proposed rule. Each certificate of compliance must identify the third-party conformity assessment body on whose testing the certificate depends. The certificate must be legible and in English and include the date and place of manufacture, the date and place where the product was tested, including the full mailing address and telephone number for each party, and the contact information for the person responsible for maintaining records of the test results. The certificates may be in electronic format and must be provided to each distributor or retailer of the product. Upon request, the

certificates must be provided to CPSC and/or U.S. Customs and Border Protection. 15 U.S.C. 2063(a) and (g); 16 CFR part 1110.

D. Costs of NPR That Would Be Incurred by Small Manufacturers

Toys containing button cell or coin cell batteries may require minor redesign to comply with the proposed rule. CPSC anticipates one likely method of redesign is to replace plastic screw thread inserts with metal inserts to strengthen fastener attachment and prevent easy stripping of screws. The potential costs of this modification are the incremental cost to incorporate the screw thread insert and make that material change, and the one-time design changes to battery compartments.⁵⁶

CPSC estimates that the incremental costs to modify the screw thread are negligible (less than \$0.01) per product. CPSC estimates a range of one to two weeks of labor for an electrical engineer to redesign a toy battery compartment. Data from the Bureau of Labor Statistics (BLS) indicates that the average full hourly compensation rate of an electrical engineer, which includes wages⁵⁷ and benefits,⁵⁸ in the U.S. is \$84.87.⁵⁹ Because battery compartment designs are very similar across product models and firms, CPSC assesses that firms would be able to incorporate the updated battery compartment designs across all children's products lines that the manufacturer offers without additional effort required for each product line. Considering this equates to a range of possible design costs of \$3,395 to \$6,791 per firm.⁶⁰

⁵⁶ Re-tooling costs are not expected from the changes in the draft proposed rule.

⁵⁷ The mean hourly wage of an electrical engineer is \$56.58 per hour as of May 2023 according to BLS, available at: <https://www.bls.gov/oes/current/oes172071.htm>.

⁵⁸ The ratio of full compensation to wages for someone in *Professional and related occupations* in the Manufacturing industry is 1.50 (\$68.94 compensation per hour ÷ \$46.02 wage per hour) as of March 2024. See Table 4 at: <https://www.bls.gov/news.release/ecec.t04.htm>.

⁵⁹ \$84.87 per hour = \$56.58 wage per hour × 1.50 compensation factor.

⁶⁰ Calculated as work hours in a week times compensation rate. (40 x \$84.87 = \$3,394.80 and 80 x \$84.87 = \$6,789.60).

Some additional costs might be incurred related to updating and/or adding labels. Generally, the costs associated with modifying or adding warning labels are low on a per unit basis and all manufacturers of children's products are already required to provide warning labels with their product. Therefore, CPSC expects the incremental cost related to the labeling provision to be negligible.

Manufacturers would likely incur additional costs to certify that their toys containing button cell or coin cell batteries meet the rule, if finalized, as required by Section 14 of the CPSA, 15 U.S.C. 2063. Certification of children's products must be completed by a CPSC-accepted, third party conformity assessment body (*i.e.*, third party laboratory). Based on quotes from testing laboratories for ASTM F963 mechanical services, the cost of the certification testing will range from \$130 to \$250 per product sample. Because toys containing button cell or coin cell batteries are already tested to part 1250, CPSC does not expect the additional testing proposed in this rule to materially increase the cost of third-party testing.

E. Impact on Small Manufacturers

If the rule is finalized, small manufacturers would incur a one-time redesign cost and continuous component costs (*i.e.*, screws and threads) to comply with the rule for product lines that currently do not meet the proposed requirements. Retail prices for toys containing button cell or coin cell batteries vary greatly, with the least expensive toys costing approximately \$3. CPSC does not expect small firms to incur a cost that exceeds 1 percent of the annual revenue of the firm (nor 1 percent of the retail price of the product).

Generally, CPSC considers an impact to be potentially significant if it exceeds 1 percent of a firm's revenue. CPSC does not expect a potentially significant impact on small firms that manufacture toys containing button cell or coin cell batteries. CPSC does not expect that small

businesses will incur costs that exceed 1 percent of their annual revenue. The high end of CPSC's cost estimate range is \$6,791. Any firm with annual revenues less than \$678,100 could potentially incur a significant impact, however, CPSC is unaware of any firms with revenues of this amount that have costs at the highest end of the cost estimate range. The Commission seeks comments from firms stating their annual revenue and estimated redesign and continuous component costs.

F. Alternatives for Reducing the Adverse Impact on Small Entities

CPSC considered three alternatives to the NPR that could reduce the impact on small entities: (1) not taking any action regarding toys containing button cell or coin cell batteries, (2) establishing an information and education campaign for these batteries, and (3) providing a later effective date. In addition, although the statute allows CPSC to provide "small batch" exemptions to testing requirements or alternative requirements for small providers of certain products, allowing no testing or alternate testing would undermine the Commission's effort to require battery accessibility testing in ASTM F963-23 the same as for non-toy consumer products. 15 U.S.C. 2063(d)(4).

1. No Action Alternative

Under this alternative the status quo would be maintained, and no firm would incur a rule-based cost. While not promulgating a mandatory standard for toys containing button cell or coin cell batteries would have no impact on U.S. small businesses, it would also allow hazardous products to remain on the market and ignore a known ingestion hazard to children. Further, impact on small U.S. businesses if the Commission took no action would be limited because of the low cost for small businesses to comply with the rule.

Taking no action to address the risk of button cell or coin cell battery child ingestion by making the requirements for securing toy battery compartments more stringent, to ensure that they provide the highest level of safety feasible, would be inconsistent with the Commission's statutory mandate described in section I of this preamble. 15 U.S.C. 2056b(c) and (d). After preliminarily determining that the existing requirements in ASTM F-963 are inadequate to address the risk of potential ingestion, the Commission is moving forward with this rulemaking to comply with the statutory mandate and to prioritize the safety of children by mitigating potential child ingestions of button cell or coin cell batteries obtained from toys.

2. Information and Education Campaign

The Commission could create an information and education campaign to better alert parents and caregivers regarding the risks associated with children ingesting button cell or coin cell batteries. This would require consumer outreach efforts like advertising and marketing related to the hazards. This alternative could be implemented independent of any regulatory action. Although information campaigns may be helpful, standing alone they are inadequate to address the ingestion hazard associated with these batteries.

3. Later Effective Date

To reduce burden on small businesses, the Commission considered an effective date later than 180 days after Federal Register publication, to spread the cost of compliance over a longer period. Although many toys may already comply with the proposed requirements, some toys would need to be redesigned, and all toys containing button cell or coin cell batteries would require third-party testing to the new requirements. In this case, as described above, 180 days is reasonable for firms to comply with the rule, the cost of compliance is low, and many labs are already CPSC-accepted to conduct the same or similar testing. Providing a 180-day effective

date is consistent with section 106(g) of the statute and addressing this known health hazard associated with children's toys.

X. Environmental Consideration

The Commission's regulations address whether the agency is required to prepare an environmental assessment or an environmental impact statement. Under these regulations, certain categories of CPSC actions normally have "little or no potential for affecting the human environment," and therefore do not require an environmental assessment or an environmental impact statement. Safety standards providing performance and labeling requirements for consumer products come under this categorical exclusion. 16 CFR 1021.5(c)(1). The NPR falls within the categorical exclusion.

XI. Paperwork Reduction Act (PRA)

This NPR for toys containing button cell or coin cell batteries contains information collection requirements that are subject to public comment and review by the Office of Information and Regulatory Affairs (OMB) under the Paperwork Reduction Act of 1995 (44 U.S.C. 3501–3521). Toys are children's products. Accordingly, CPSC proposes to update the PRA estimate for toys containing button cell or coin cell batteries into a new control number, and then include this updated estimate in the Children's Product OMB Control Number in the next update. In this document, pursuant to 44 U.S.C. 3507(a)(1)(D), we set forth:

- A title for the collection of information;
- A summary of the collection of information;
- A brief description of the need for the information and the proposed use of the information;
- A description of the likely respondents and proposed frequency of response to the collection of information;
- An estimate of the burden that shall result from the collection of information; and
- Notice that comments may be submitted to the OMB.

Title: Safety Standard for Toys: Requirements for Toys Containing Button Cell or Coin Cell Batteries

Description: As described in section V of this preamble, the proposed rule would require each toy containing a button cell or coin cell battery to comply with the performance and labeling requirements in 16 CFR 1250.3. CPSC will seek a new OMB control number for this update. Sections 5, 6, and 7 of ASTM F963–23 contain requirements for marking, labeling, and instructional literature. These requirements fall within the definition of “collection of information,” as defined in 44 U.S.C. 3502(3).

Description of Respondents: Persons who manufacture or import toys containing one or more button cell or coin cell batteries, as defined in proposed part 1250.3(b).

Estimated Burden: We estimate the burden of this collection of information as follows:

Table 6 – Estimated Annual Reporting Burden

Burden Type	Number of Respondents	Frequency of Response	Total Annual Responses	Hours per Response	Total Burden Hours
Labeling and instructions	18,868	2	37,736	2	75,472

This estimate is based on the following: CPSC estimates that 18,868 respondents would provide labeling and instructional literature annually, based on the number of identified small firms that manufacture or import toys containing cell or coin cell batteries. We exclude retailers from our estimate because we assume that labeling and instructional literature would be provided by manufacturers and importers, but not retailers. While the number of responses per respondent would vary, we estimate that on average, each respondent will respond twice annually for products that are updated and brought to market, for a total of 37,736 annual responses (18,868 respondents × 2 responses per year).

OS 63
DRAFT

CPSC assumes that on average it will take 1 hour for each respondent to create the required label and one hour for them to create the required instructions, for an average response burden of 2 hours per response. Therefore, the total burden hours for the collection are estimated to be 75,472 hours annually (37,736 responses × 2 hours per response = 75,472 total burden hours).

We estimate the hourly compensation for the time required to create and update labeling and instructions is \$41.55 (U.S. Bureau of Labor Statistics, “Employer Costs for Employee Compensation,” December 2023, Table 4, total compensation for all sales and office workers in goods-producing private industries:

https://www.bls.gov/news.release/archives/ecec_03132024.pdf). Therefore, the estimated annual cost of the burden requirements is \$3,135,862 (\$41.55 per hour x 75,472 hours = \$3,135,861.60).

No operating, maintenance, or capital costs are associated with the collection. Based on this analysis, the proposed revisions to the standard would impose a burden to industry of 75,472 hours at a cost of \$3,135,862 annually.

In compliance with the PRA (44 U.S.C. 3507(d)), we have submitted the information collection requirements of this rule to the OMB for review. Interested persons are requested to submit comments regarding information collection by **[INSERT DATE 60 DAYS AFTER DATE OF PUBLICATION IN THE FEDERAL REGISTER]**, to the OMB (see the ADDRESSES section at the beginning of this notice). Pursuant to 44 U.S.C. 3506(c)(2)(A), we invite comments on:

- Whether the collection of information is necessary for the proper performance of CPSC’s functions, including whether the information will have practical utility;

- The accuracy of CPSC’s estimate of the burden of the proposed collection of information, including the validity of the methodology and assumptions used;
- Ways to enhance the quality, utility, and clarity of the information to be collected;
- Ways to reduce the burden of the collection of information on respondents, including the use of automated collection techniques, when appropriate, and other forms of information technology; and
- The estimated burden hours associated with the update and modification of labels and instructions, including any alternative estimates.

XII. Preemption

Section 26(a) of the CPSA, 15 U.S.C. 2075(a), states that when a consumer product safety standard is in effect and applies to a product, no state or political subdivision of a state may either establish or continue in effect a standard or regulation that prescribes requirements for the performance, composition, contents, design, finish, construction, packaging, or labeling of such product dealing with the same risk of injury unless the state requirement is identical to the federal standard. Section 106(f) of the CPSIA deems rules issued under that provision “consumer product safety standards.” Therefore, once a rule issued under section 106 of the CPSIA takes effect, it will preempt in accordance with section 26(a) of the CPSA.

XIII. Certification and Notice of Requirements

Section 14(a) of the CPSA imposes the requirement that products subject to a consumer product safety rule under the CPSA, or to a similar rule, ban, standard, or regulation under any other act enforced by the Commission, must be certified as complying with all applicable CPSC-enforced requirements. 15 U.S.C. 2063(a). Section 14(a)(2) of the CPSA requires that certification of children’s products subject to a children’s product safety rule be based on testing conducted by a CPSC-accepted third party conformity assessment body. Section 14(a)(3) of the CPSA requires the Commission to publish an NOR for the accreditation of third-party

conformity assessment bodies (or laboratories) to assess conformity with a children's product safety rule to which a children's product is subject. The proposed rule for 16 CFR 1250.3, Requirements for Toys Containing Button Cell or Coin Cell Batteries, if issued as a final rule, would be a children's product safety rule that requires the issuance of an NOR.

16 CFR part 1112 establishes requirements for accreditation of third-party conformity assessment bodies to test for conformity with a children's product safety rule in accordance with section 14(a)(2) of the CPSA. Part 1112 also codifies all of the NORs issued previously by the Commission. To meet the requirement that the Commission issue an NOR for the proposed standard, the Commission proposes as part of the NPR to add § 1250.3, Requirements for Toys Containing Button Cell or Coin Cell Batteries, to the list of children's product safety rules for which CPSC has issued an NOR.

Testing laboratories applying for acceptance as a CPSC-accepted third party conformity assessment body to test to the new standard for button cell and coin cell batteries in toys would be required to meet the third-party conformity assessment body accreditation requirements in part 1112. When a laboratory meets the requirements as a CPSC-accepted third party conformity assessment body, the laboratory can apply to CPSC to have 16 CFR 1250.3, Requirements for Toys Containing Button Cell or Coin Cell Batteries, included within the laboratory's scope of accreditation listed for the laboratory on the CPSC website at: <https://www.cpsc.gov/cgi-bin/labsearch/>.

XIV. Request for Comments

The Commission requests comments on all aspects of this NPR, including the effective date. Submit comments in accordance with the instructions in the **ADDRESSES** section at the beginning of this document.

CPSC specifically requests comment on the following topics:

A. Proposed Performance Requirements for Toys Containing Button Cell or Coin Cell Batteries

1. Do the proposed performance requirements align with the requirements in part 1263? If not, what requirements should the Commission add or remove to align the two standards?

2. Are the proposed performance requirements adequate to address the risk of ingestion and insertion from children accessing button cell or coin batteries from toys? Please provide details of any additional requirements proposed.

3. Are there any toys weighing over 10 lbs. and up to 39.7 lbs., that would not be considered large and bulky (as defined in ASTM F963–23), and should a separate drop test for such toys be included?

B. Proposed Warning Label Requirements for Toys Containing Button Cell or Coin Cell Batteries

1. Are the proposed warnings adequate to address the hazards associated with toys containing button cell or coin cell batteries?

2. Should CPSC consider additional warnings on toy packaging, on toys, or on instructional literature accompanying toys?

3. Should CPSC consider other warning formats?

C. Regulatory Flexibility Analysis

1. *Significant impact.* Is CPSC's estimated cost of redesign to achieve compliance appropriate? If not, please provide additional information and support for your proposed correction. Also, do the estimated costs represent more than one percent of annual revenue for individual small U.S. manufacturers and importers?

2. *Testing costs.* Will third party testing costs for toys containing button cell or coin cell batteries increase as a result of the requirements in this NPR, and if so, by how much?

3. *Effective date of 180 days after Federal Register publication.* How much time is required to come into compliance with a final rule (including product compliance and third-party testing)? Please provide supporting data with your comment supporting a 180-day period or other effective date, particularly for small businesses.

4. *Alternatives to reduce the impact on small businesses.* Are there any alternatives to the rule not discussed in this NPR that could reduce the impact on small businesses without reducing safety? Please provide supporting data with your comment, particularly addressing small businesses.

D. Feasibility

1. Are the proposed requirements in this NPR feasible, both technically and economically?

2. What would be the total cost to industry of implementing this rule? Please be specific about labor and/or materials costs to redesign products, and costs of third-party testing.

3. Will complying with this rule increase the costs of production or the retail price of toys containing button cell or coin cell batteries? Why? By how much?

List of Subjects

16 CFR Part 1112

Administrative practice and procedure, Audit, Consumer protection, Reporting and recordkeeping requirements, Third party conformity assessment body.

16 CFR Part 1250

Consumer protection, Incorporation by reference, Infants and children, Labeling, Law enforcement, Toys.

For the reasons discussed in the preamble, the Commission proposes to amend Title 16 of the Code of Federal Regulations as follows:

PART 1112—REQUIREMENTS PERTAINING TO THIRD PARTY CONFORMITY ASSESSMENT BODIES

1. The authority citation for part 1112 continues to read as follows:

Authority: 15 U.S.C. 2063.

2. Amend § 1112.15 by adding paragraph (b)(32)(ii)(LL) to read as follows:

§ 1112.15 When can a third-party conformity assessment body apply for CPSC acceptance for a particular CPSC rule and/or test method?

* * * * *

(b) * * *

(32) * * *.

(ii) * * *

(LL) 16 CFR part 1250.3, Requirements for Toys Containing Button Cell or Coin Cell

Batteries.

* * * * *

3. The title of part 1250 is revised to read as follows:

PART 1250—SAFETY STANDARD FOR TOYS

4. The authority citation for part 1250 is revised to read as follows:

Authority: 15 U.S.C. 2056b.

5. Revise § 1250.1 to read as follows:

§ 1250.1 Scope

This part establishes a consumer product safety standard for toys.

6. Add § 1250.3 to read as follows:

§ 1250.3 Requirements for toys containing button cell or coin cell batteries.

(a) *Scope and purpose.* This section establishes additional performance and labeling requirements for toys containing button cell or coin cell batteries to prevent child access to such batteries during reasonably foreseeable use and abuse of battery-operated toys. This section is intended to eliminate or adequately reduce the risk of injury or death to children 6 years old and younger from ingesting button cell or coin cell batteries accessed from toy battery compartments.

(b) *Definitions.* In addition to the definitions incorporated by reference in § 1250.2(a), the following definitions apply for purposes of this section:

Product Display Panel means the surface area on, near, or in the battery component of the toy using or containing button or coin cell batteries that is visible while replacing the batteries.

Secondary Display Panel means the side opposite or next to the principal display panel of the retail package of a toy using or containing button or coin cell batteries.

Toy(s) containing button cell or coin cell battery(ies) means a toy or toys containing or designed to use one or more button cell or coin cell batteries, regardless of whether such batteries are intended to be replaced by the consumer or are included with the product or sold separately.

(c) *Performance and labeling requirements.* Each toy containing button cell or coin cell batteries must comply with applicable provisions of the version of ASTM F963 incorporated by reference in § 1250.2(a), with the following additions and exclusions to that ASTM standard:

OS 70
DRAFT

(1) Add the following sentence to the end of section 4.25.4.3: “Confirm compliance after testing by opening the battery door or cover and applying a force of at least 4.5 lbf (20 N) to the fastener evenly within 5 s and maintained for an additional duration of 10 s in any direction likely to remove the fastener.”

(2) Add the following paragraphs to section 4.25.4:

(i) 4.25.4.5 For all toys with battery compartments using replaceable button cell or coin cell batteries secured by a screw or similar fastener, a minimum of two full rotations of the screw or fastener shall be required to open or remove the battery compartment, door, or cover.

(ii) 4.25.4.6 For all toys with battery compartments using replaceable button cell batteries or coin cell batteries secured by a rotating or twist-on access cover, a minimum torque of 4.4 in-lbf (0.5 Nm) shall be required to unlock the cover, and a minimum angle of 90 degrees of rotation shall be required to remove the cover.

(iii) 4.25.4.7 All toys containing button cell or coin cell batteries shall be tested in accordance with section 8.31.

(3) Instead of complying with section 5.14.2, comply with the following:

(i) 5.14.2 *Button Cell or Coin Cell Batteries:*

(ii) 5.14.2.1 For each toy containing button cell or coin cell batteries, each toy, toy packaging, and toy instructions shall meet the requirements in 16 CFR 1263.3, Packaging Markings, Product Markings, and General Instructions.

(4) Add the following paragraphs as section 8.31.

(i) 8.31 *Button Cell or Coin Cell Battery Use and Abuse Testing*—All testing in this section shall be performed in series on each unique toy or toy component containing button cell or coin cell batteries. Manufacturer recommended batteries shall be in place during the testing unless

otherwise specified. No button cell or coin cell batteries shall become accessible without the use of a tool as a result of testing.

(ii) 8.31.1 *Stress Relief Test*—Subject all toys with a battery compartment that utilizes molded or formed thermoplastic materials to this test. The sample shall consist of either the entire toy or toy component, or for large and bulky toys or toy components, at least the complete battery compartment enclosure together with any supporting framework. Batteries may be removed during this test.

(A) Place the sample in a circulating air oven for a period of 7 hours. Set the oven temperature to the higher of (1) 70°C or (2) 10°C higher than the maximum temperature of thermoplastic enclosures, battery compartment door/covers, or battery compartment door/cover mechanisms, during the most stringent normal operation of the sample.

(B) After removal from the oven, permit the sample to cool to room temperature.

(iii) 8.31.2 *Battery Replacement Test*—Subject all toys or toy components containing replaceable button cell or coin cell batteries to this test.

(A) The battery compartment door/cover shall be opened, the battery removed and replaced, and the battery compartment door/cover shall be closed, for a total of ten cycles. The test procedure shall simulate battery replacement according to the manufacturer's instructions.

(B) If the battery compartment is secured with a screw(s), loosen and then tighten the screw(s) by means of a suitable screwdriver, applying a continuous linear torque according to the Torque to be Applied to Screws table, Table 20, of UL 60065 *Standard for Audio, Video and Similar Electronic Apparatus – Safety Requirements*.

(iv) 8.31.3 *Drop Test*—(A) Except for large and bulky toys, toys intended for children aged 0 to 18 months that weigh less than 10.01 lbs. (4.5 kg) shall be dropped at least 4.5 ft (137 cm)

onto the test surface specified in 8.7.1 in positions likely to produce maximum force on the battery enclosure or compartment.

(A) Toys intended for children aged over 18 months that weigh less than 10.01 lbs. (4.5 kg) shall be dropped 10 times from a height of at least 3.0 ft (91 cm) onto the test surface specified in 8.7.1 in positions likely to produce maximum force on the battery enclosure or compartment.

(B) Regardless of the intended child age, all toys that weigh at least 10.01 lbs. (4.5 kg) up to 39.7 lbs. (18 kg), shall be dropped three times from a height of at least 3.0 ft (91 cm) onto the test surface specified in 8.7.1 in the positions likely to produce maximum force on the battery enclosure or compartment.

(v) 8.31.3.1 *Tipover Test*—Large and bulky toys shall not be subject to the drop test in 8.31.3, instead subject such toys to the *Tipover Test for Large, Bulky Toys* in accordance with the procedure in 8.7.2.1.

(vi) 8.31.4 *Impact Test*—(A) Subject the battery enclosure or compartment door/cover to three, 1.5-ft·lbf (2-J) impacts. Produce the impact by dropping a steel sphere, 2.00 in (50.8 mm) in diameter, and weighing approximately 1.1 lbs. (0.5 kg), from the height required to produce the specified impact, as shown in Figure 50, or the steel sphere is to be suspended by a cord and swung as a pendulum, dropping through the vertical distance required to cause it to strike the surface with the specified impact as shown in Figure 51. The steel sphere is to strike the battery enclosure or compartment door/cover perpendicular to the enclosure surface.

(B) Add Figure 50 to section 8.31.4:

Figure 50. Example impact test with a dropped steel sphere

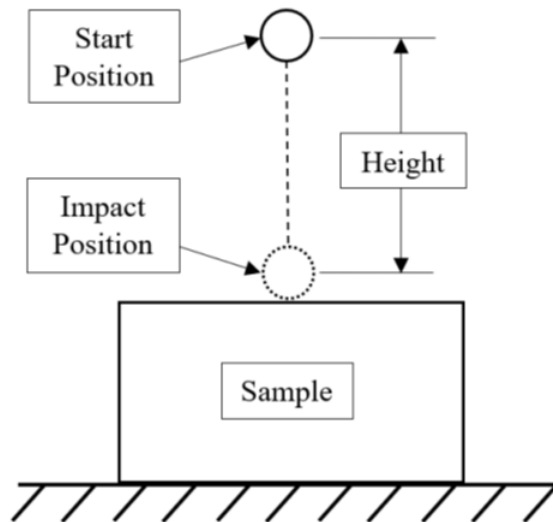

(C) Add Figure 51 to section 8.31.4:

Figure 51. Example impact test with a swinging steel sphere

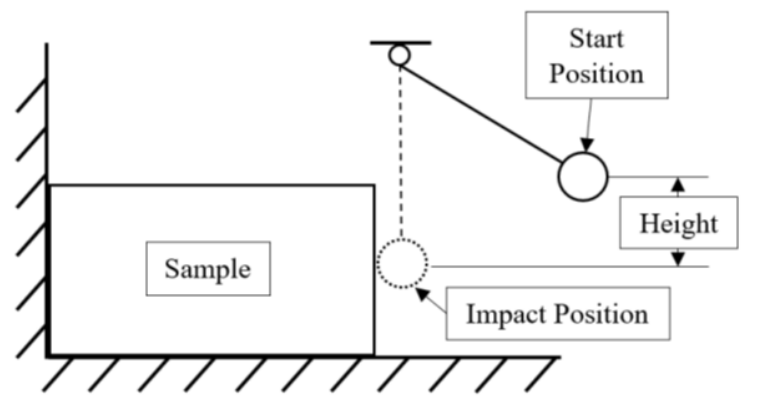

(vii) 8.31.5 *Crush Test*—Support the sample by a fixed rigid supporting surface in positions likely to produce the most adverse results, so long as the position can be self-supported. Apply a crushing force of $74.2 \text{ lbf} \pm 1.1 \text{ lbf}$ ($330 \text{ N} \pm 5 \text{ N}$) for a period of 10 s to the exposed surfaces. Apply the force using a flat surface measuring approximately 3.9 in by 9.8 in (100 mm by 250 mm).

(viii) 8.31.6 *Torque Test*—If a child can grasp any part of the battery compartment enclosure on a toy or toy component, including the door or cover, with at least the thumb and forefinger, or

using teeth, apply the *Torque Test for Removal of Components* in section 8.8 to the battery compartment enclosure, using a torque of at least 4.4 in-lbf (0.50 Nm).

(ix) 8.31.7 *Tension Test*—If a child can grasp any part of the battery compartment enclosure on a toy or toy component, including the door or cover, with at least the thumb and forefinger, or using teeth, apply the *Tension Test for Removal of Components* from section 8.9 to the battery compartment enclosure, using a force of at least 16.2 lbf (72.0 N).

(x) 8.31.8 *Compression Test*—If any surface of the battery compartment enclosure is accessible to a child and inaccessible to a flat surface contact during the *Drop Test* in 8.7.1, apply the *Compression Test* from section 8.10 to the surface of the battery compartment enclosure, using a force of at least 30.5 lbf (135.7 N).

(xi) 8.31.9 *Compliance*—(A) Apply a force of 11.2 lbf +2.2/-0 lbf (50 +10/-0 N) for 10 s to the battery compartment door/cover or enclosure with a rigid test finger probe, Test Probe 11 of IEC 61032, *Standard for Protection of Persons and Equipment by Enclosures – Probes for Verification* (Figure 52). Apply the probe at the most unfavorable place and in the most unfavorable direction. Apply force in only one direction. (B) To pass, the battery compartment door/cover shall not open and shall remain functional, and the battery shall not be touched by the probe or made accessible.

(d) *Incorporation by reference.* Certain material is incorporated by reference into this section with the approval of the Director of the Federal Register in accordance with 5 U.S.C. 552(a) and 1 CFR part 51. All approved incorporation by reference material is available for inspection at the Consumer Product Safety Commission and at the National Archives and Records Administration (NARA). Contact the U.S. Consumer Product Safety Commission at: Office of the Secretary, U.S. Consumer Product Safety Commission, 4330 East-West Highway, Bethesda,

OS 75
DRAFT

MD 20814; telephone (301) 504-7479, email cpsc-os@cpsc.gov. For information on the availability of this material at NARA, visit www.archives.gov/federal-register/cfr/ibr-locations or email fr.inspection@nara.gov. The material may be obtained from the following sources:

(1) UL Standards and Engagement, International, 151 Eastern Avenue, Bensenville, IL 60106; phone: 1-888-853-3503; website: www.shopulstandards.com.

UL 60065, *Standard for Audio, Video and Similar Electronic Apparatus – Safety Requirements*, (approved June 19, 2020).

(2) American National Standards Institute (ANSI), 11 West 42nd Street, New York, New York, 10036; phone: 212-642-4900.

IEC 61032, *Standard for Protection of Persons and Equipment by Enclosures – Probes for Verification*, (published December 1, 1997).

Alberta E. Mills
Secretary, Consumer Product Safety Commission



Memorandum

TO: The Commission
Alberta E. Mills, Secretary

DATE: July 10, 2024

THROUGH: Jessica L. Rich, General Counsel
Austin C. Schlick, Executive Director
DeWane Ray, Deputy Executive Director for Safety
Operations

FROM: Duane E. Boniface, Assistant Executive Director,
Office of Hazard Identification and Reduction

Benjamin Mordecai, Mechanical Engineer, Division of Mechanical Engineering,
Directorate for Laboratory Sciences

Daniel Taxier, Children's Program Manager, Directorate for Engineering Sciences

Jacqueline Campbell, Voluntary Standards Coordinator, Risk Management Group

Jill Hurley, Engineering Psychologist, Division of Human Factors, Directorate for
Engineering Sciences

Cheryl Scorpio, Ph.D., Pharmacologist, Division of Pharmacology and Physiology
Assessment, Directorate for Health Sciences

John Topping, Mathematical Statistician, Division of Hazard Analysis, Directorate
for Epidemiology

Salman Sarwar, Compliance Officer, Division of Regulatory Enforcement, Office of
Compliance and Field Operations

Mark Bailey, Economist, Division of Economic Analysis

Cynthia Gillham, Economist, Division of Economic Analysis

SUBJECT: Safety Standard for Toys: Requirements for Toys Containing Button Cell or Coin Cell
Batteries

Section 106 of the Consumer Product Safety Improvement Act of 2008 (CPSIA) states that ASTM F963 shall be a consumer product safety standard under section 9 of the Consumer Product Safety Act (CPSA). In 2023, the U.S. Consumer Product Safety Commission (CPSC) incorporated ASTM International's (ASTM) latest update to the voluntary standard for toys – ASTM F963–23, into 16 CFR part 1250, *Safety Standard Mandating ASTM F963 for Toys*, to further reduce the risk of injury or death associated children's toys.

On February 9, 2023, pursuant to Reese's Law ([Pub. L. 117–171](#), [15 U.S.C. § 2056e](#)), the Commission published a Notice of Proposed Rulemaking (NPR) to establish performance and labeling

requirements for button cell or coin cell batteries and consumer products containing such batteries.¹ 88 Fed. Reg. 8,692. On September 21, 2023, the Commission published in the *Federal Register* a determination that the voluntary standard ANSI/UL 4200A, *Standard for Safety for Products Incorporating Button Batteries or Coin Cell Batteries*, published on August 30, 2023 (UL 4200A-2023), met the performance requirements in Reese’s Law, and a Direct Final Rule (DFR) incorporating by reference UL 4200A-23 as the mandatory standard for non-toy consumer products. 88 Fed. Reg. 65,274 (creating 16 C.F.R. part 1263, Safety Standard for Button Cell or Coin Batteries and Consumer Products Containing Such Batteries).

While Reese’s Law applies to most consumer products, it does not apply to toys that comply with 16 CFR part 1250. Instead, CPSC already has authority and responsibility to require more stringent requirements for toys containing button cell or coin batteries by amending part 1250 pursuant to section 106 of the CPSIA. 15 U.S.C. 2056b. The battery containment requirements in ASTM F963–23 for toys containing button or coin cell batteries are not as stringent as the requirements in 16 C.F.R. part 1263, which applies to non-toy consumer products. Staff therefore recommends that the Commission propose a more stringent safety standard for toys containing button cell or coin batteries to bring the level of safety for toys at a minimum up to that of non-toy products.

Section 106 directs CPSC to assess the effectiveness of ASTM F963 and its adequacy to protect children from safety hazards associated with toys and, thereafter, to promulgate consumer product safety standards for toys that are more stringent than the existing standard if the Commission concludes that more stringent requirements would further reduce the risk of injury associated with toys. 15 U.S.C. § 2056b(b). CPSC also must periodically review and revise ASTM F963 to ensure that such standards provide the highest level of safety for such products that is feasible. 15 U.S.C. § 2056b(c).

This draft NPR reflects the views and recommendations of the above-listed staff. The draft NPR is intended to reduce the risk of injury associated with the ingestion and insertion of button or coin cell batteries found in battery-operated toys as defined in ASTM F963–23.

Section 4.25.4, *Battery Accessibility* of ASTM F963–23 establishes performance requirements for battery-operated toys that use button cell or coin cell batteries. ASTM defines a battery-operated toy as a “toy having at least one function dependent on electricity and powered by batteries.” ASTM also defines a button battery as a “small round non-lithium battery, in which the overall height is less than the diameter.” Similarly, ASTM defines a coin cell battery as a “small round lithium battery, in which the overall height is less than the diameter.”

As discussed in section III of the draft NPR regarding incident data and hazard patterns, staff identified three human factor hazards associated with the accessibility of button cell or coin cell batteries from battery-operated toys: ingestion, nasal insertion, and ear insertion.

Staff identified one fatal incident and 46 non-fatal incidents in the CPSRMS database and 185 NEISS hospital emergency department visits associated with toys containing button cell or coin cell batteries during the seven-year period of January 1, 2016, to December 31, 2022.

¹ <https://www.cpsc.gov/s3fs-public/NoticeofProposedRulemakingSafetyStandardandNotificationRequirementsforButtonCellorCoinBatteriesandConsumerProductsContainingSuchBatteries.pdf?VersionId=kDinNeydtkkt3T8RRtzN4u1GTXPjE>

As explained in section V of staff's draft NPR, battery-operated toys utilizing button or coin cell batteries are currently regulated under 16 C.F.R part 1250, which incorporates by reference section 4.25 of ASTM F963–23 for *Battery-operated Toys*. This NPR proposes to require more stringent performance requirements and test methods as follows:

1. Captive Fasteners: Section 4.25.4.3 of ASTM F963–23 now requires that fasteners used to secure toy battery compartments shall remain attached to the toy or battery compartment cover before and after testing in accordance with sections 8.5 – 8.10. This requirement addresses situations where the screw was lost and the battery compartment could no longer be secured. Staff proposes replacing this requirement with Standard IEC 62115 – *Electric toys – Safety*, which contains a similar requirement (from section 13.4.6) for use and abuse testing of fasteners, but also specifies that compliance be tested by applying a 20 N tensile force to the screw directly. Without this test, there is no way to quantitatively evaluate the fastener's ability to stay with the toy or battery compartment cover.
2. Minimum Battery Compartment Threaded Attachment Requirements: ASTM F963–23 currently does not specify any requirements for minimum thread engagement, which was an identified hazard pattern leading to a child's ability to access a battery. Without a required minimum thread engagement, the fastener could have insufficient means to secure the battery compartment. Staff assesses that two requirements in UL 4200A–23 better ensure battery compartment securement: (1) screws or similar fasteners must engage at least two full threads (*i.e.*, the fasteners must screw into the product for at least two full turns) and (2) battery compartment twist-on access covers shall require a minimum torque of 0.5 Nm (4.4 in-lbf) and a minimum of 90 degrees of rotation to open the compartment. The NPR proposes to apply these UL requirements to children's toys.
3. Sequential Use and Abuse Test Requirements: ASTM F963–23 currently only allows for one type of test to be conducted on a sample at a given time. It is foreseeable that a toy will experience different use and abuse situations throughout its lifecycle, such as a crush force and a drop. Staff assesses that the requirements in UL 4200A-23 for conducting the following use and abuse tests in sequence are more stringent and are more indicative of real-world scenarios, improving safety:
 - a. *Stress Relief Test* – ASTM F963–23 currently does not specify a thermal stress relieve test. This UL test requires the battery compartment to be subject to increased temperatures to simulate environmental or battery thermal stress.
 - b. *Battery Replacement Test* – ASTM F963–23 currently does not specify a conditioning protocol to simulate the use conditions of repeatedly replacing batteries. This UL test requires the screw and thread engagement be subjected to normal wear and tear to determine if the fasteners or battery compartment threads become stripped.

- c. *Drop Test and Tip Over Test* – ASTM F963–23 specifies these tests in section 8.7, and now the parameters are updated to include children of older ages. Staff assesses these parameters increase safety to include situations where a child was playing with an older sibling’s toy.
- d. *Impact Test* – ASTM F963–23 does not specify an impact test. This UL test simulates direct hits onto the battery compartment, accounting for kicking, hitting, or throwing.
- e. *Crush Test* – ASTM F963–23 does not specify a crush test. This UL test simulates a toy being stepped on or pressed on by hand.
- f. *Torque, Tension, and Compression Tests* – ASTM F963–23 specifies these tests in sections 8.8 – 8.10, and now the parameters are updated to include children of older ages. Staff assesses these parameters increase safety to include situations where a child was playing with an older sibling’s toy.
- g. *Compliance Verification Test* - The accessibility probe in ASTM F963–23 has flexible joints and cannot apply significant force on a toy due to that design. To address incidents where a child was able to open the battery compartment without the use of a tool, the proposed test uses a rigid test finger probe to apply force, which is consistent with the probe used in UL 4200A-23.

Section 603 of the Regulatory Flexibility Act (RFA, 5 U.S.C. §603) requires the Commission to prepare an Initial Regulatory Flexibility Analysis (IRFA) for this proposed rule, describing the impact of the proposed rule on small entities and identifying efforts by the Commission to reduce those impacts, unless the rule would not have a significant economic impact on a substantial number of small entities. 5 U.S.C. 603, 605(b). Staff explains in section IX of the draft NPR that this proposed rule would not have a significant economic impact on a substantial number of small U.S. entities, and therefore recommends that the Commission certify that the rule would not have such a significant impact. Staff notes that alternatives that could reduce the minimal impact on small entities include no action to change current requirements in part 1250, relying on information and education campaigns, or instituting a longer effective date. However, maintaining the current rule based on ASTM F963–23 without modifications would not address the identified hazards; staff assesses that information and education campaigns are inadequate to protect against the hazards of swallowing button and coin cell batteries; and applying a longer effective date would delay addressing the hazards. A cost/benefit analysis is not required because this draft proposed rule would be issued under section 106 of the CPSIA.

For the reasons stated in section VIII of the draft NPR regarding the effective date, staff recommends an effective date of 180 days after publication of the final rule to allow time for suppliers to bring their products into compliance and to test to the new standard. Staff also recommends posing a number of questions for comment to further inform a final rule.