

1 Je trace le chiffre 0.

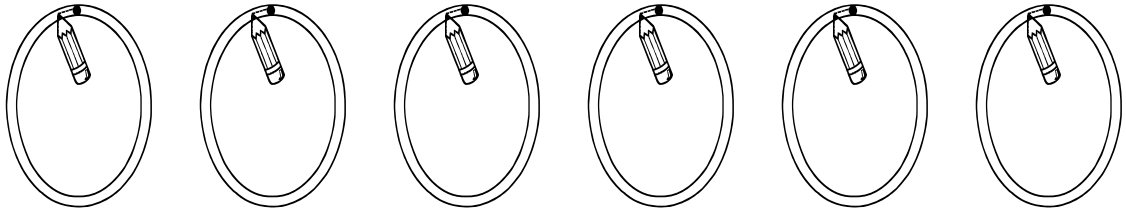

2 Je trace le chiffre 0 dans la règle.

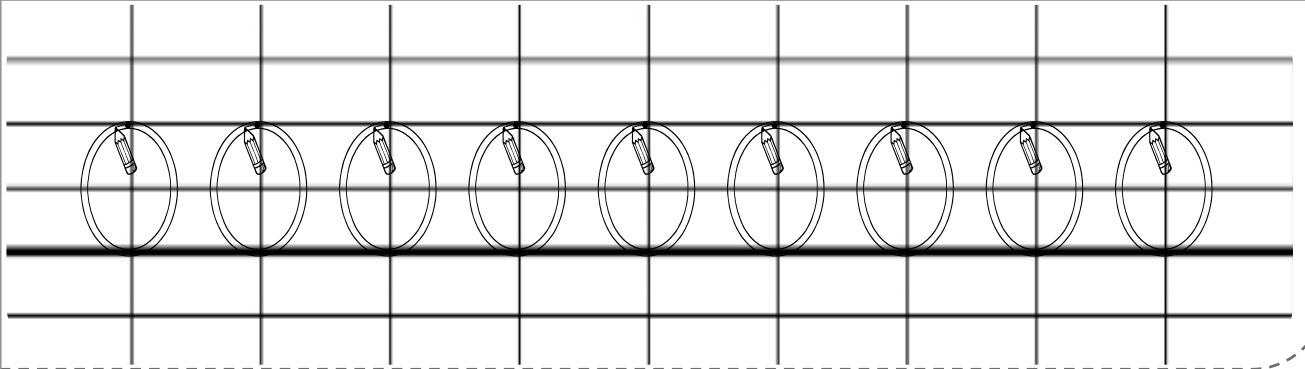

3 J'écris le chiffre 0.

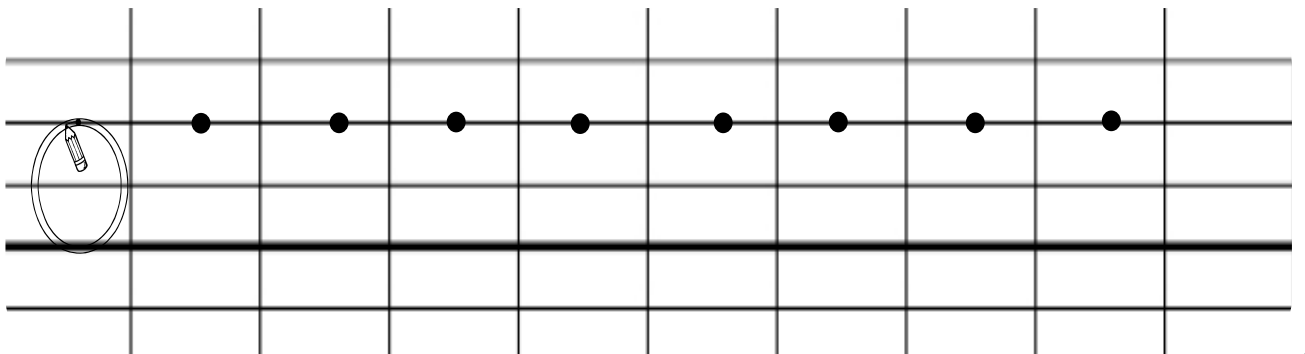

4 J'écris le chiffre 0 sans aide.

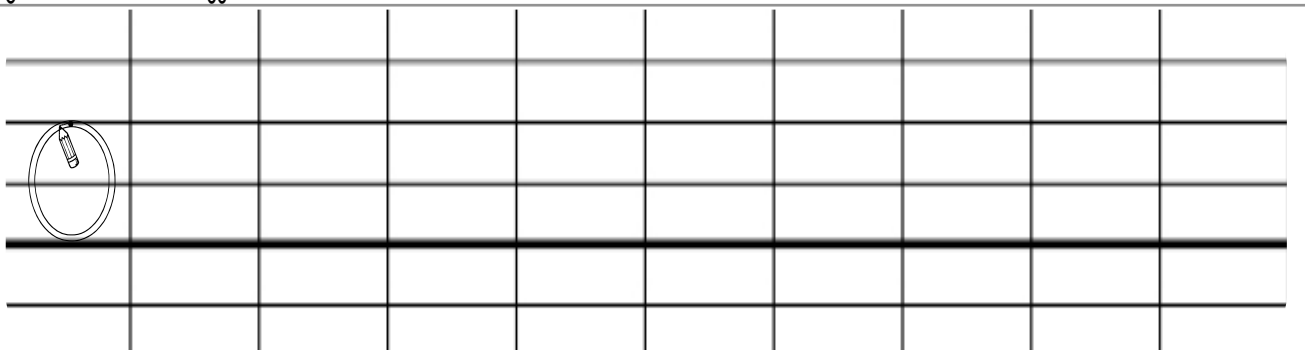

Le chiffre

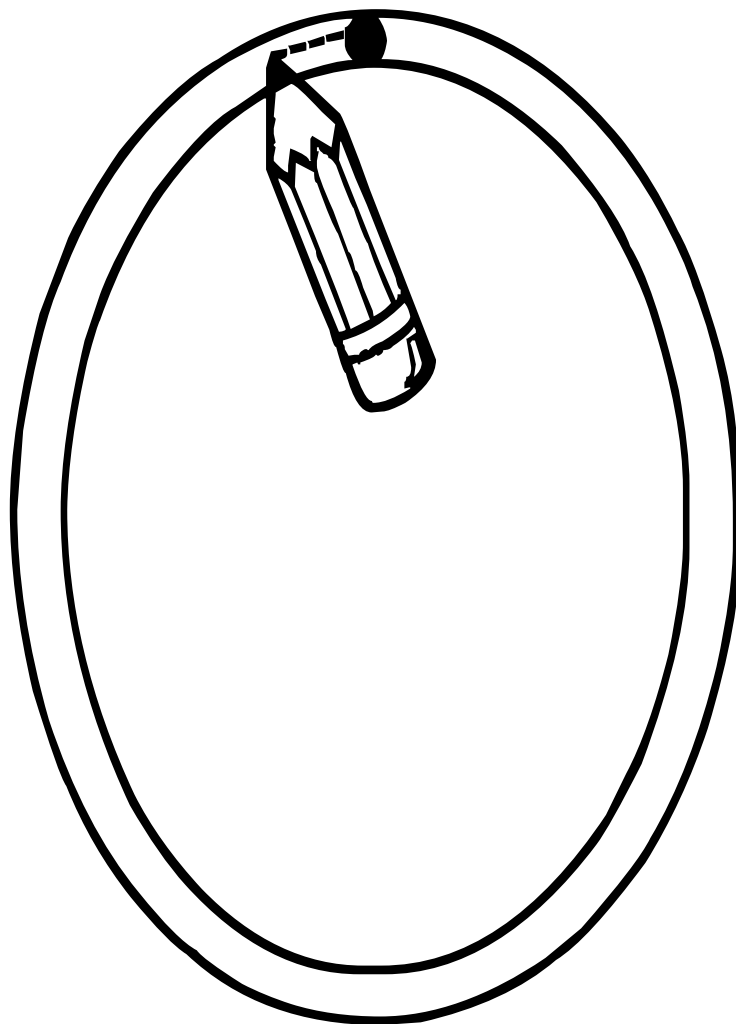
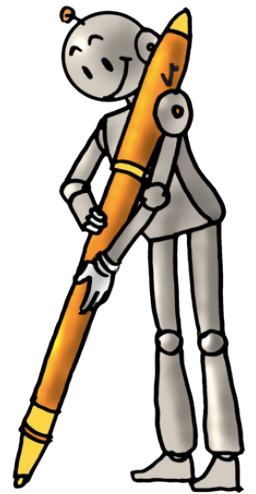

1 Je trace le chiffre 1.

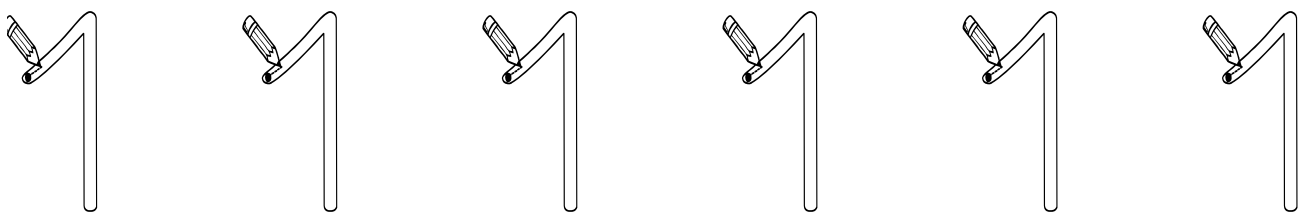

2 Je trace le chiffre 1 dans la règle.

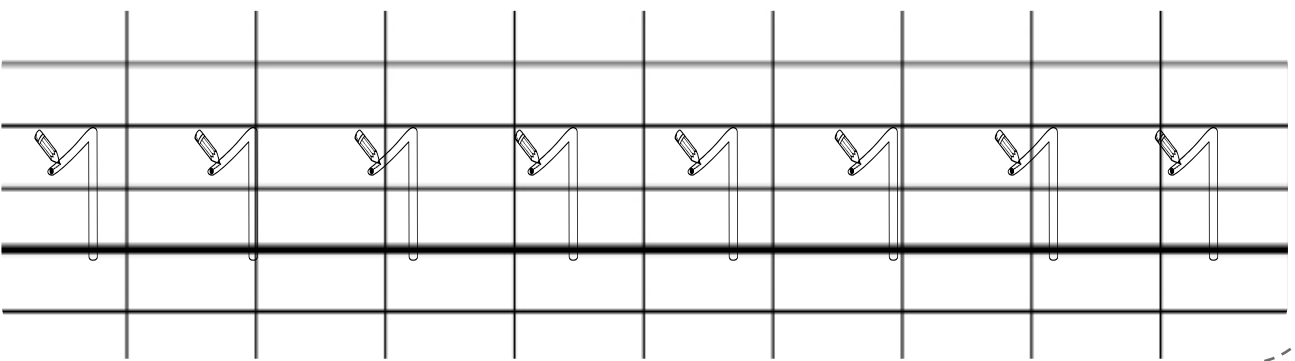

3 J'écris le chiffre 1

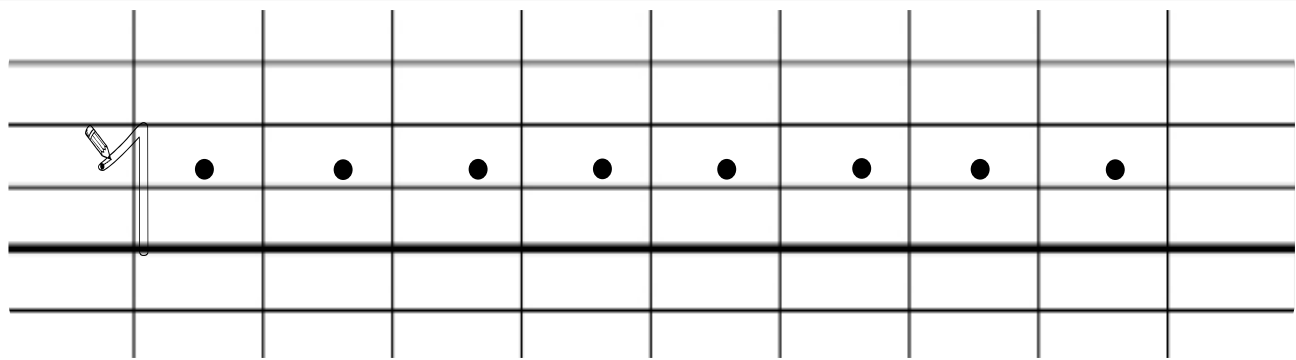
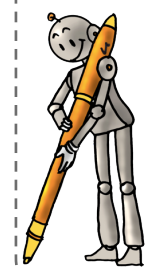

4 J'écris le chiffre 1 sans aide.

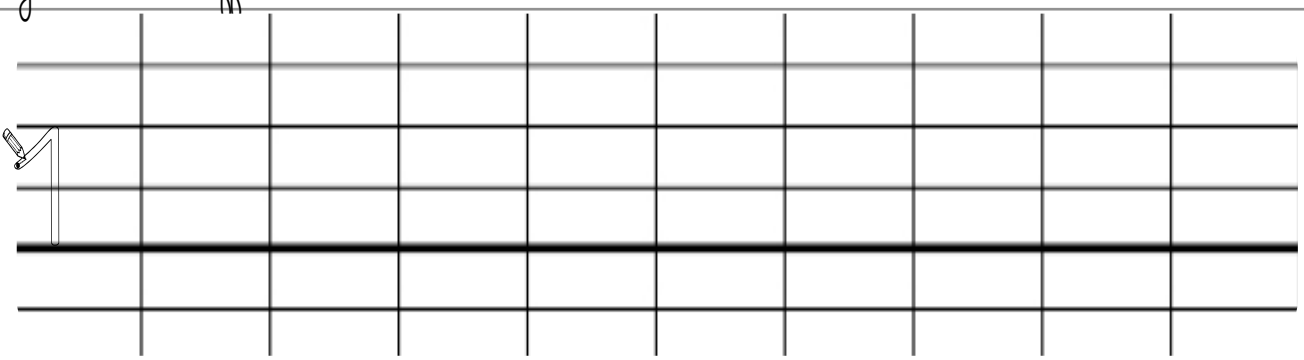
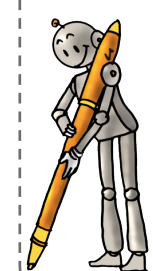

# Le chiffre 1

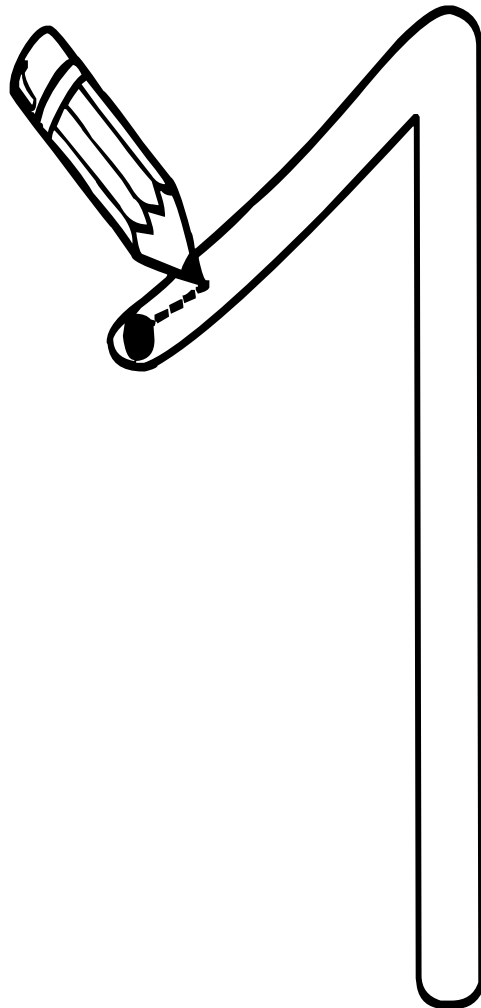
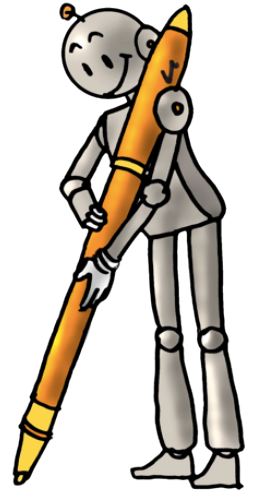

1 Je trace le chiffre 2.

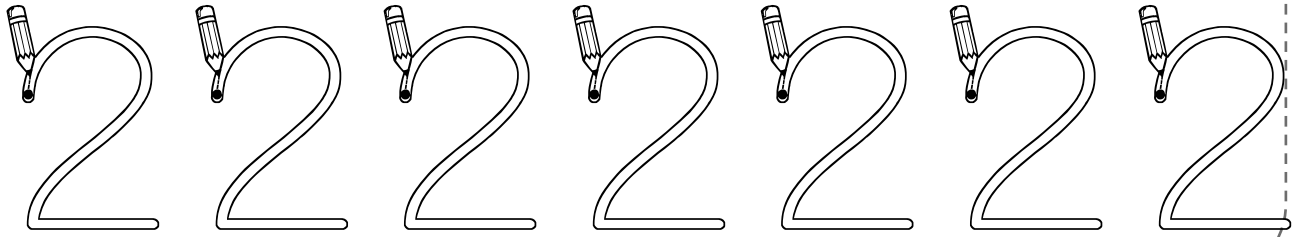

2 Je trace le chiffre 2 dans la règle.

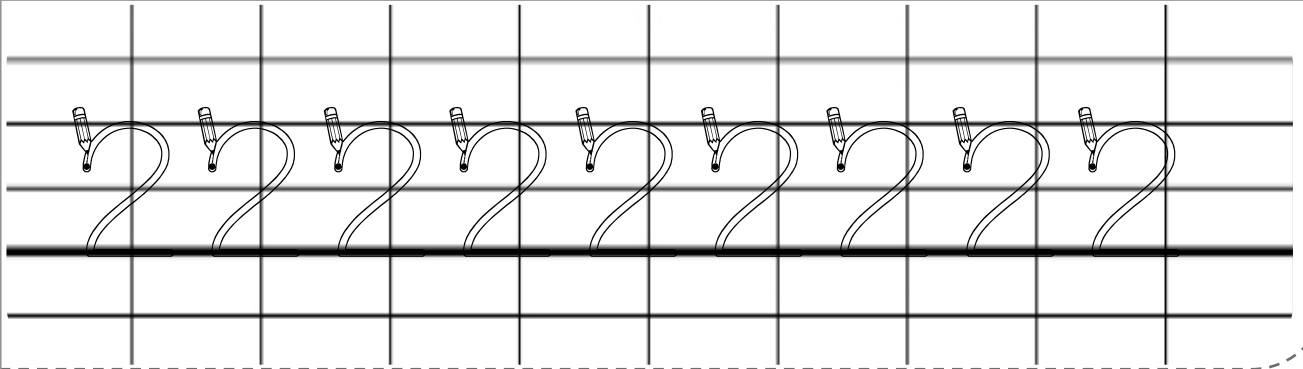

3 J'écris le chiffre 2.

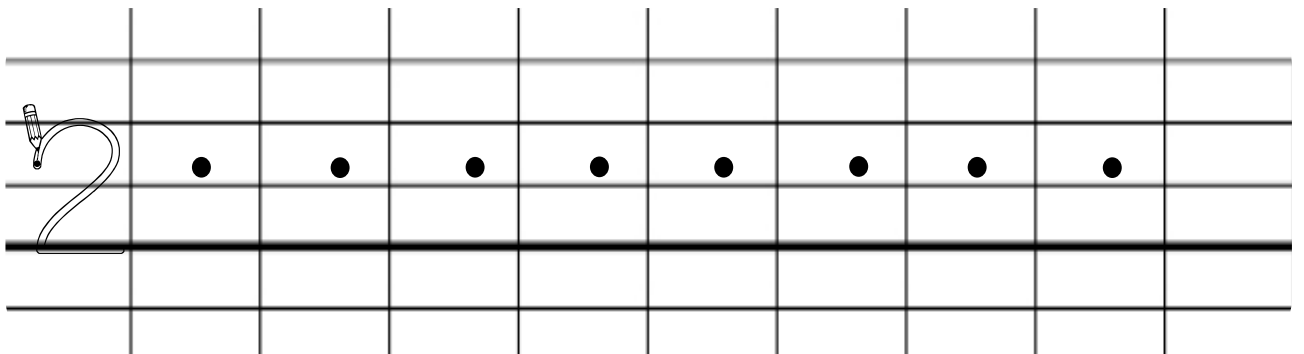

4 J'écris le chiffre 2 sans aide.

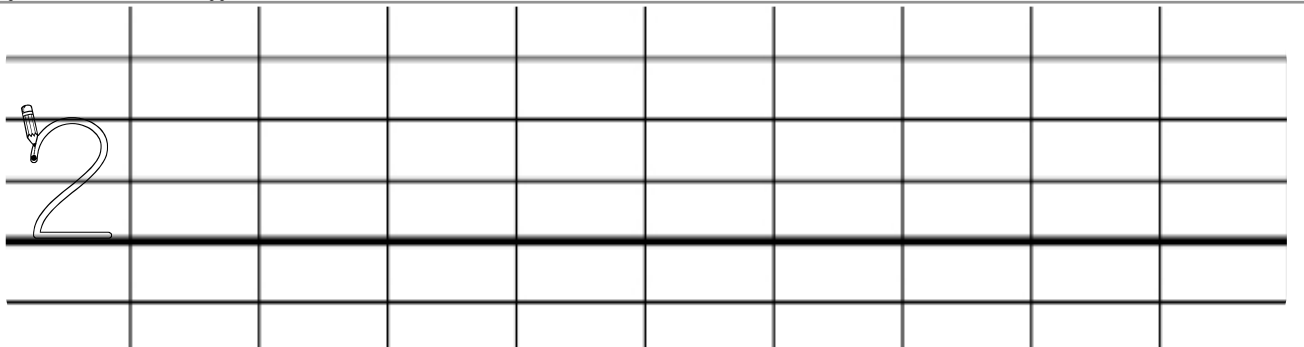

# Le chiffre 2

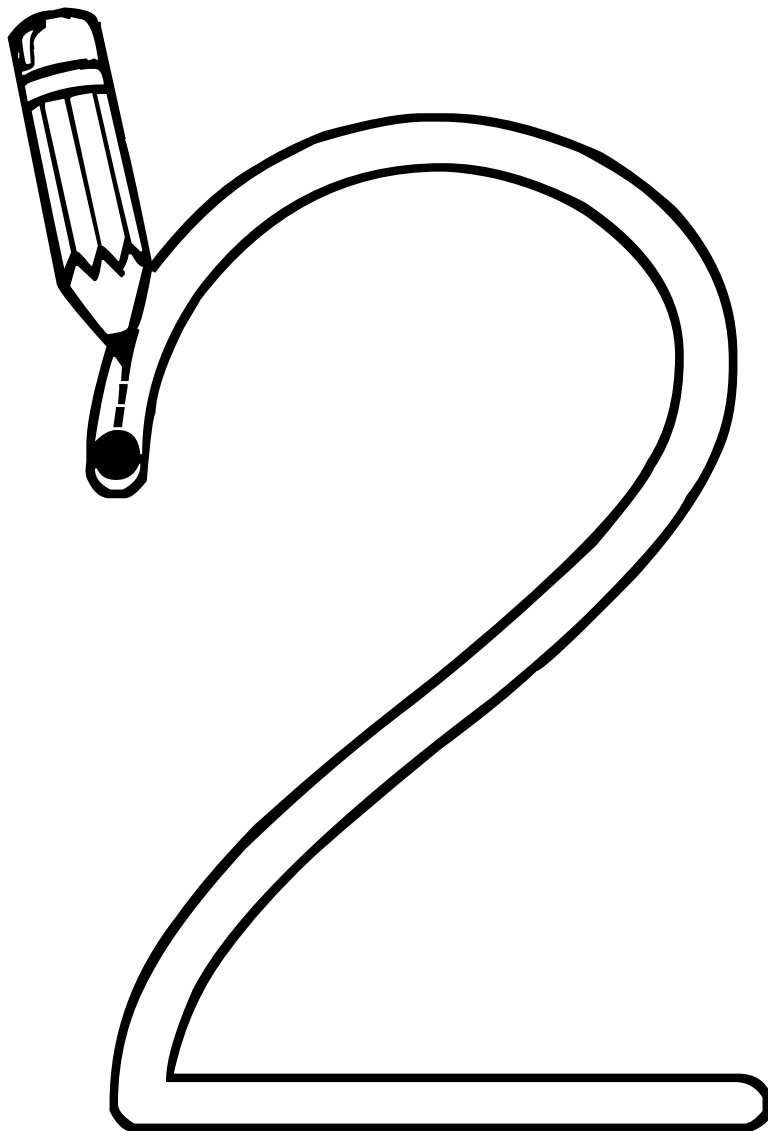
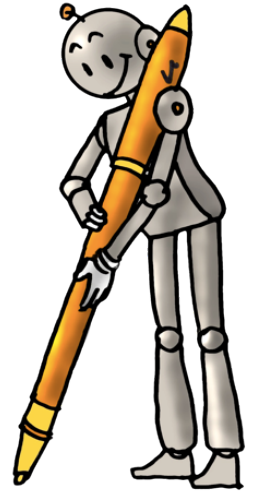

1 Je trace le chiffre 3.

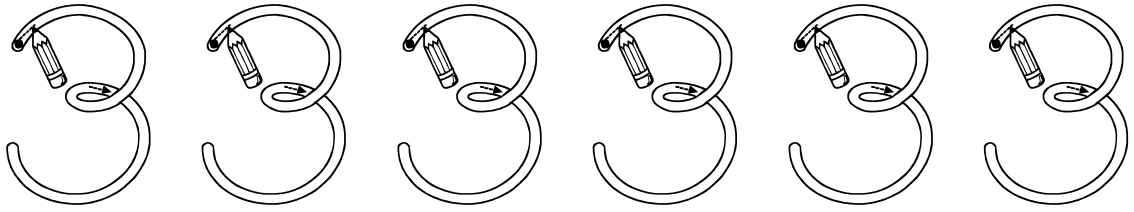

2 Je trace le chiffre 3 dans la règle.

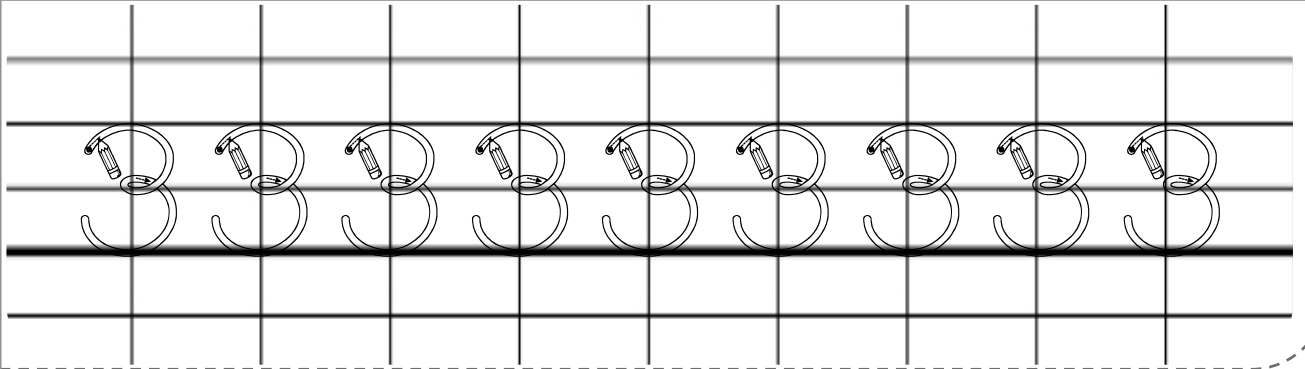

3 J'écris le chiffre 3.

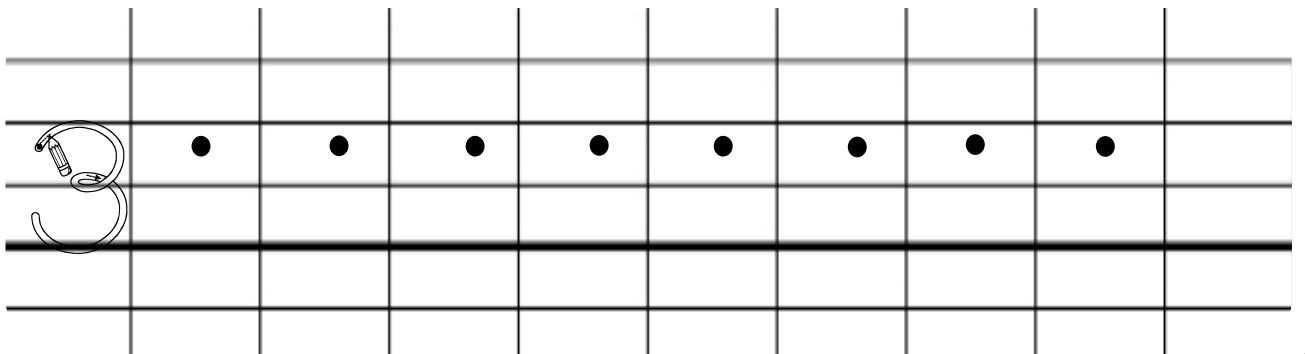

4 J'écris le chiffre 3 sans aide.

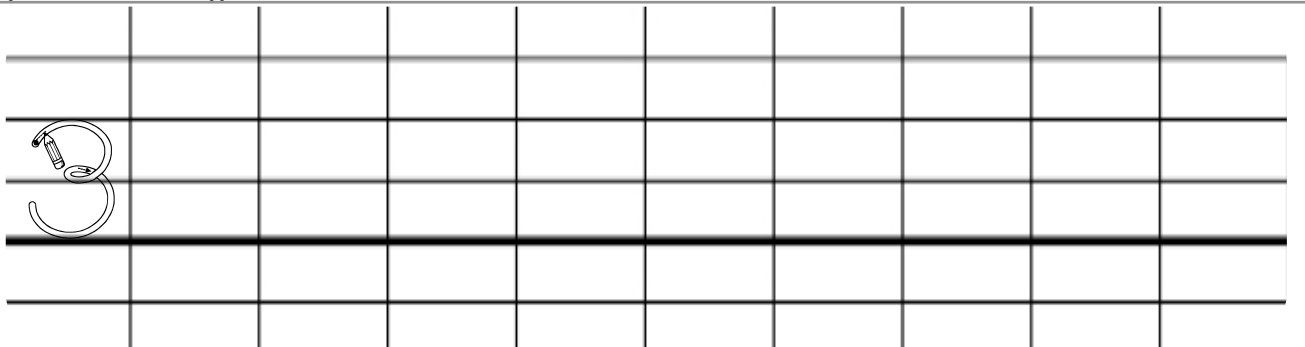

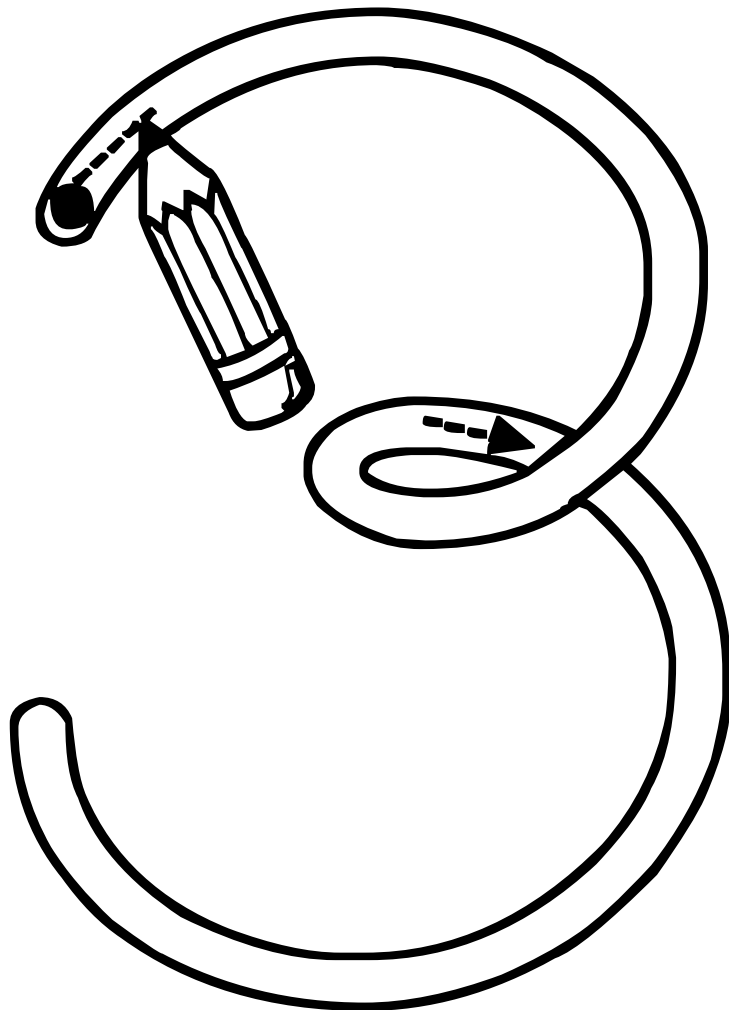
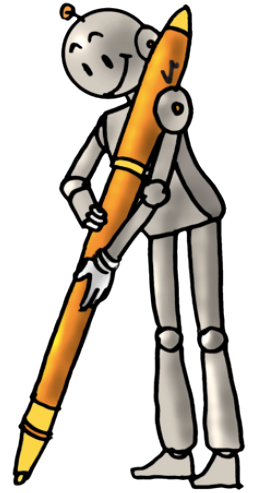



1 Je trace le chiffre 4.

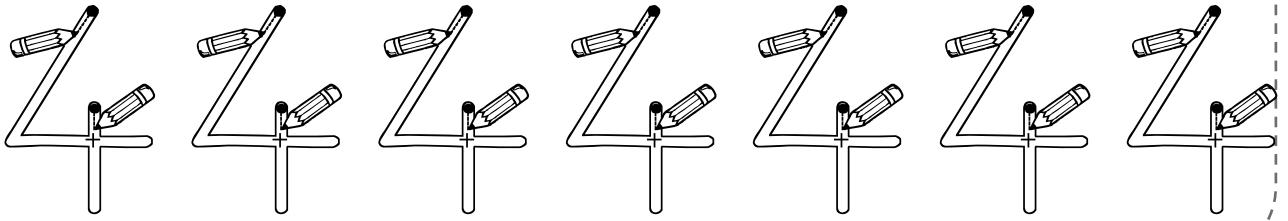

2 Je trace le chiffre 4 dans la règle.

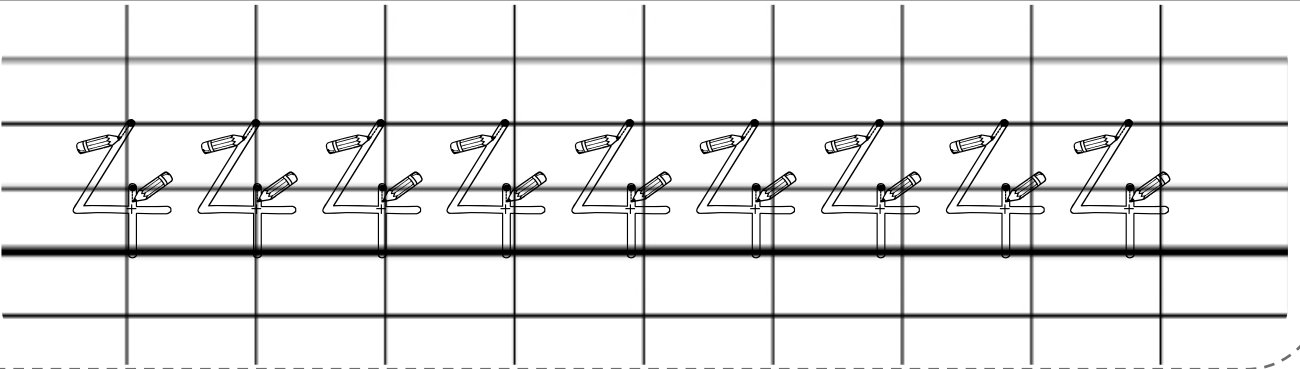

3 J'écris le chiffre 4.

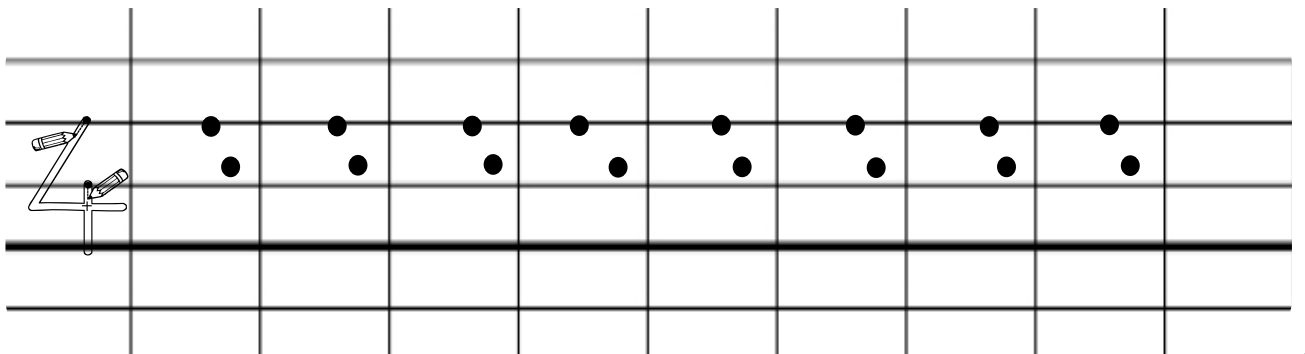

4 J'écris le chiffre 4 sans aide.

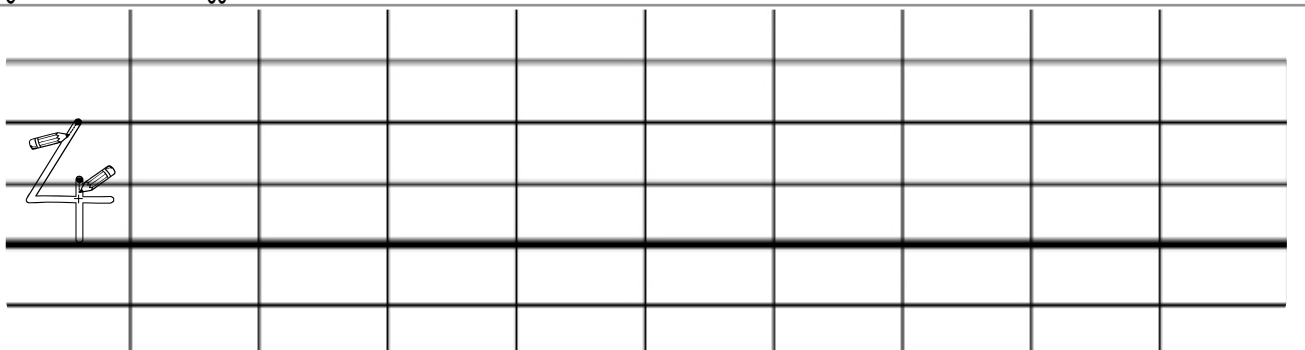

# Le chiffre 4

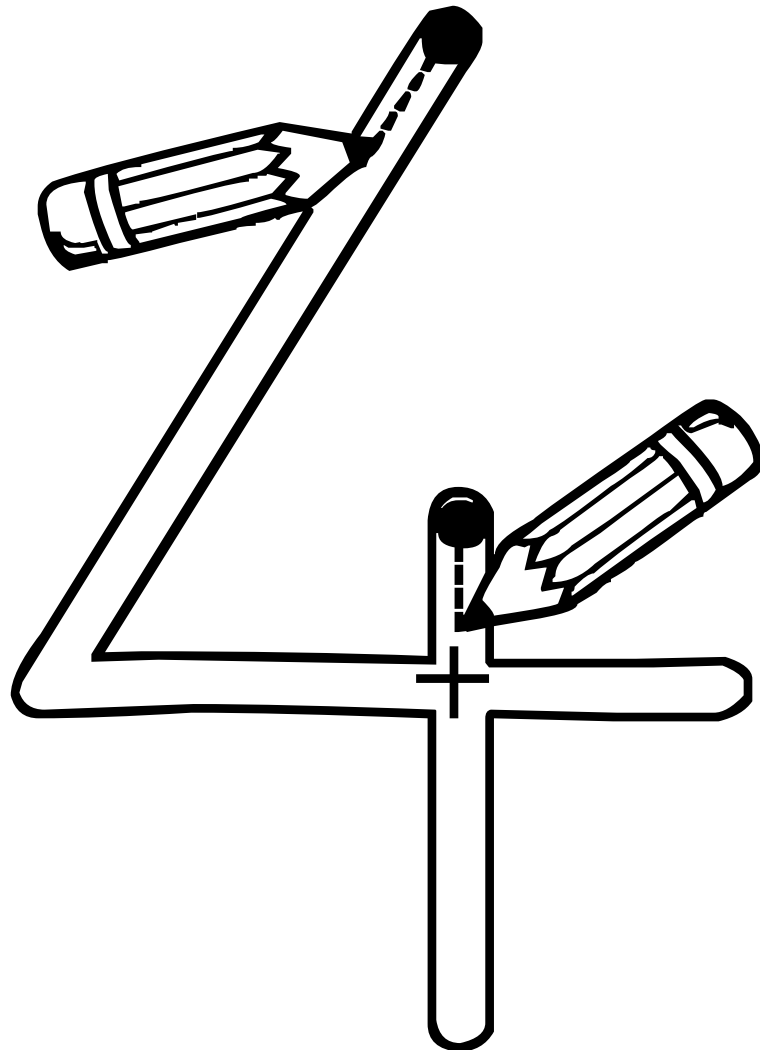
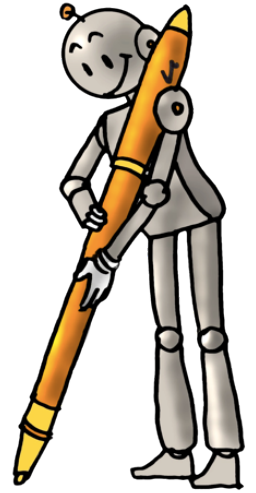

1 Je trace le chiffre 5.

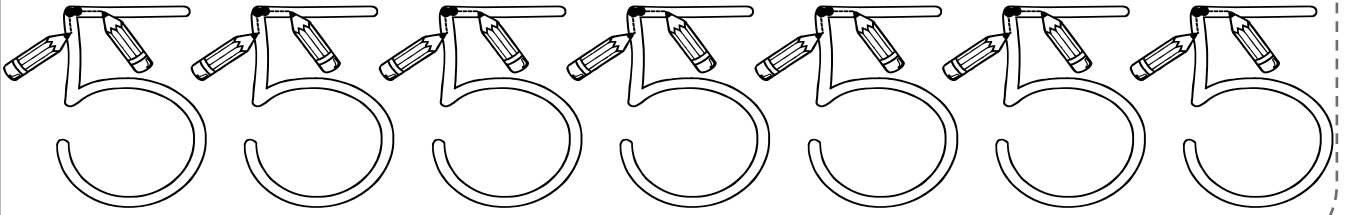

2 Je trace le chiffre 5 dans la règle.

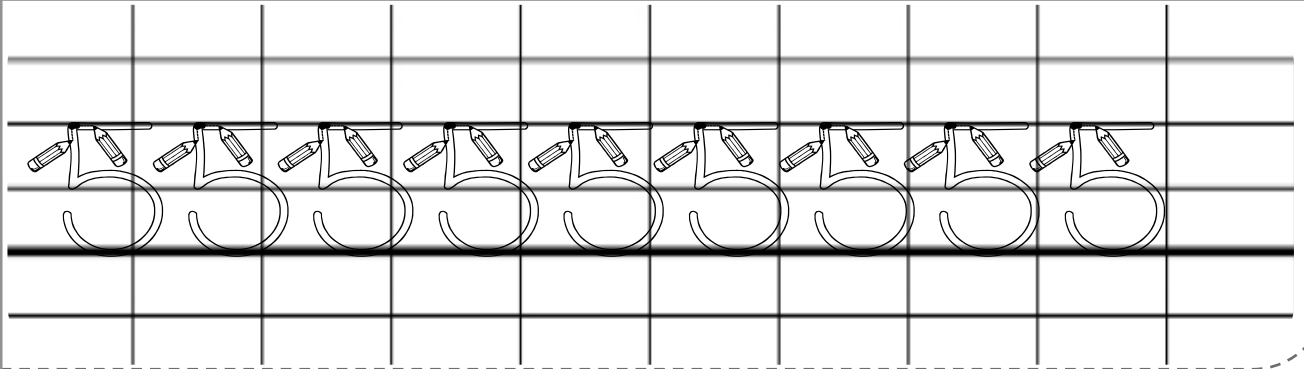

3 J'écris le chiffre 5.

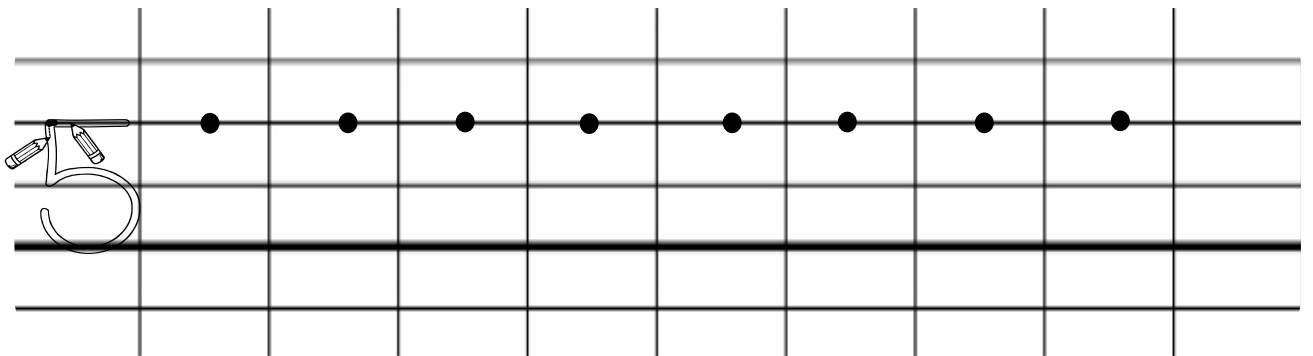

4 J'écris le chiffre 5 sans aide.

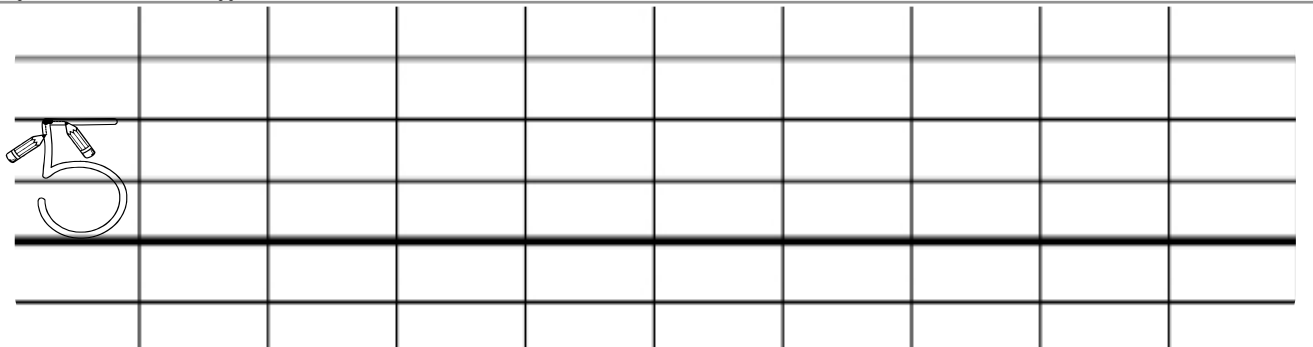

# Le chiffre 5

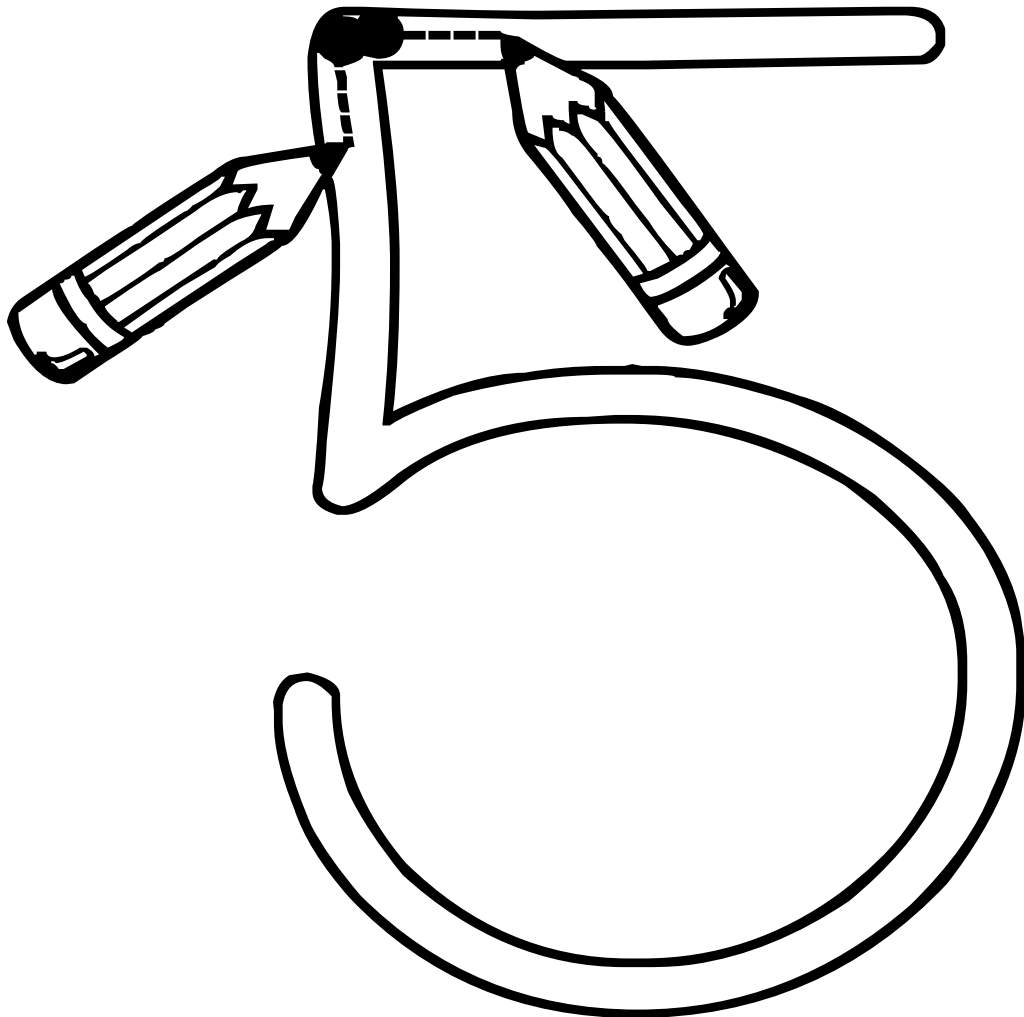
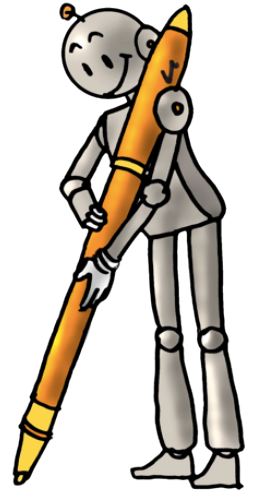

1 Je trace le chiffre 6.

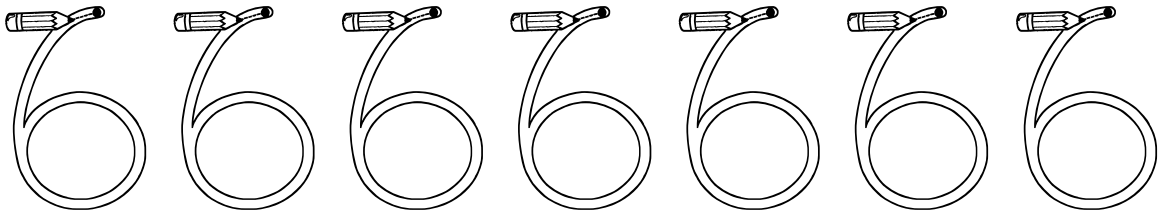

2 Je trace le chiffre 6 dans la règle.

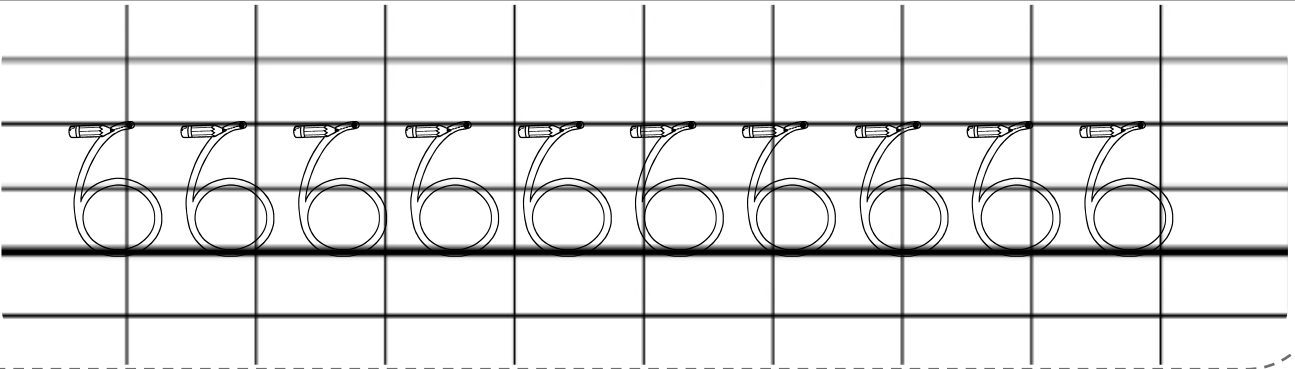

3 J'écris le chiffre 6.

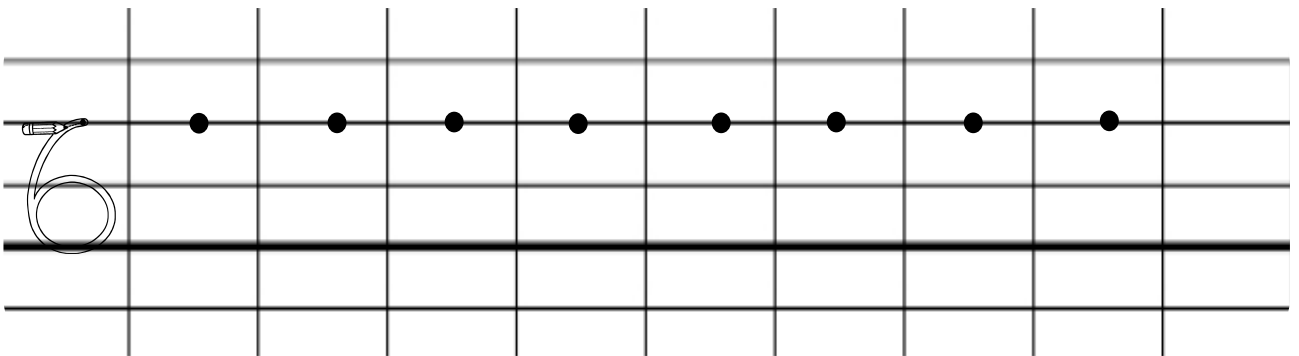

4 J'écris le chiffre 6 sans aide.

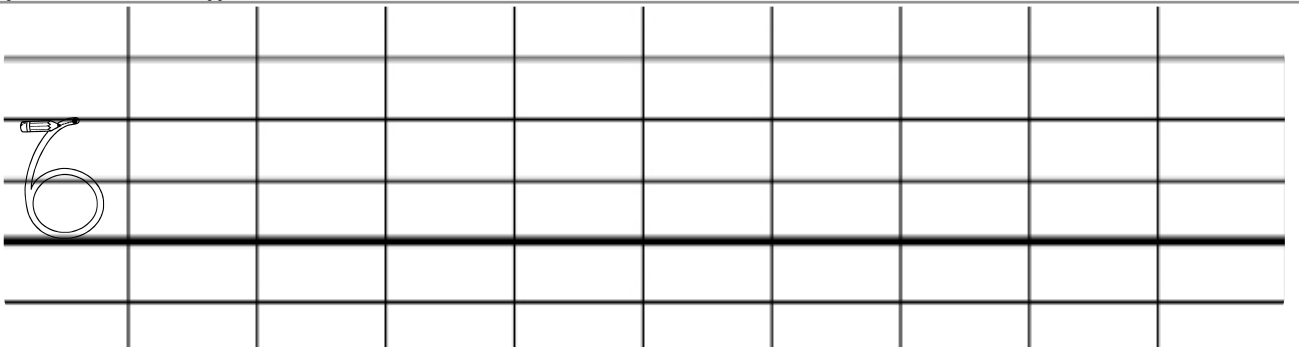

# Le chiffre 6

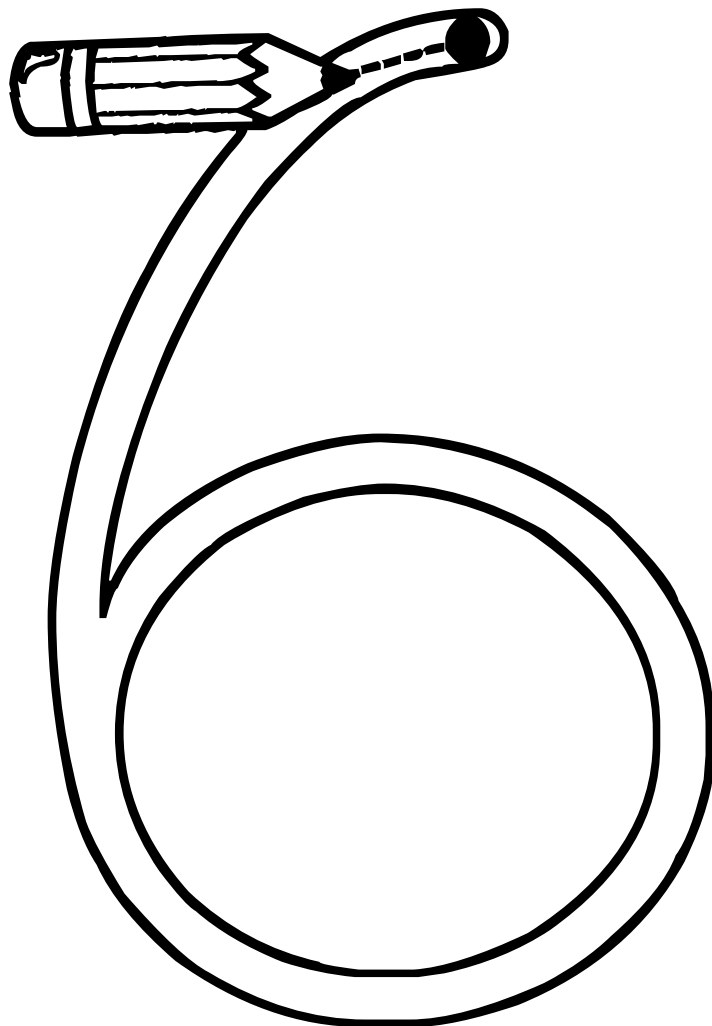
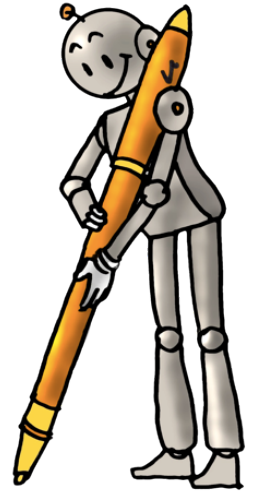

1 Je trace le chiffre 7.

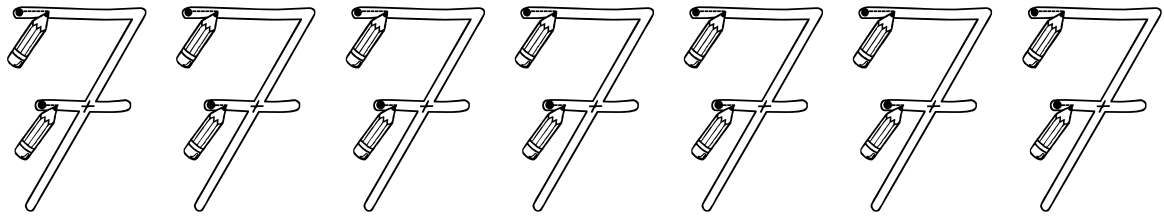

2 Je trace le chiffre 7 dans la règle.

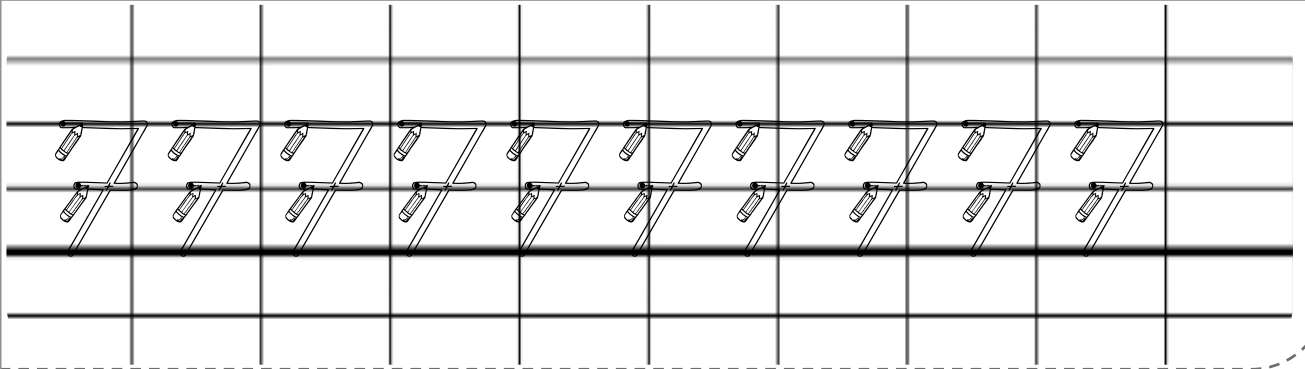

3 J'écris le chiffre 7.

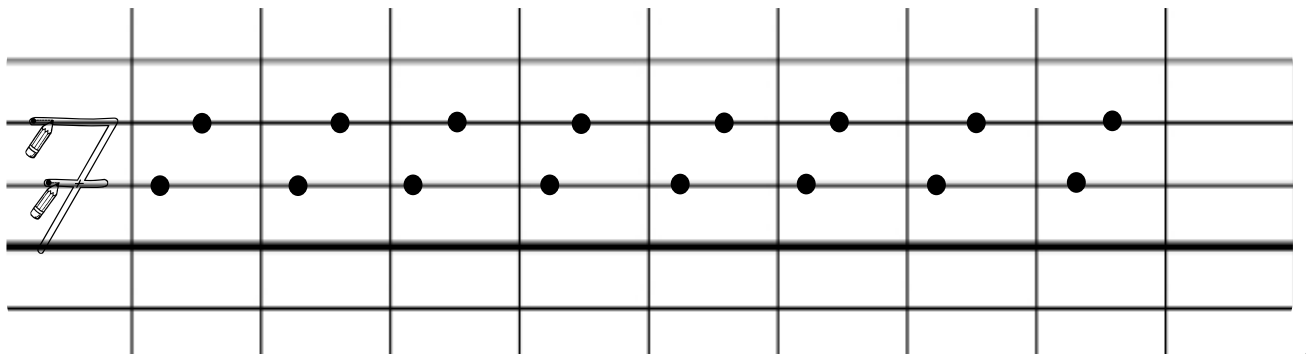

4 J'écris le chiffre 7 sans aide.

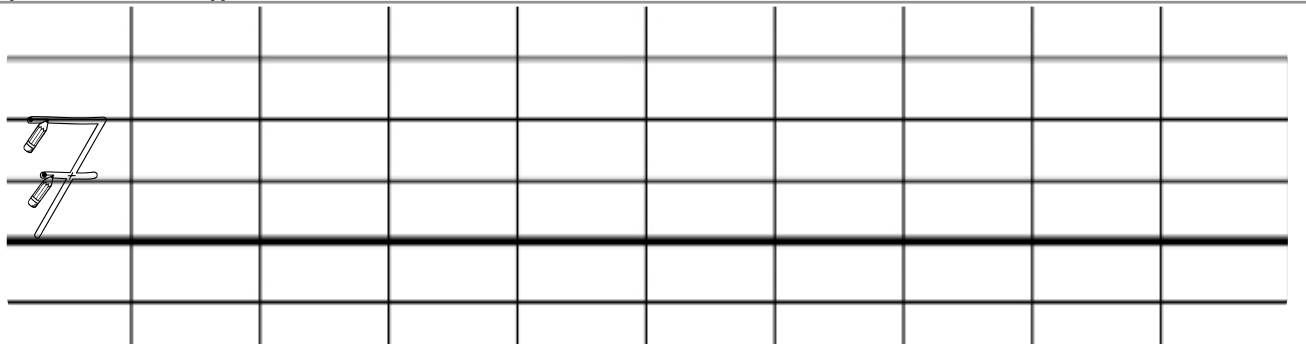

# Le chiffre 7

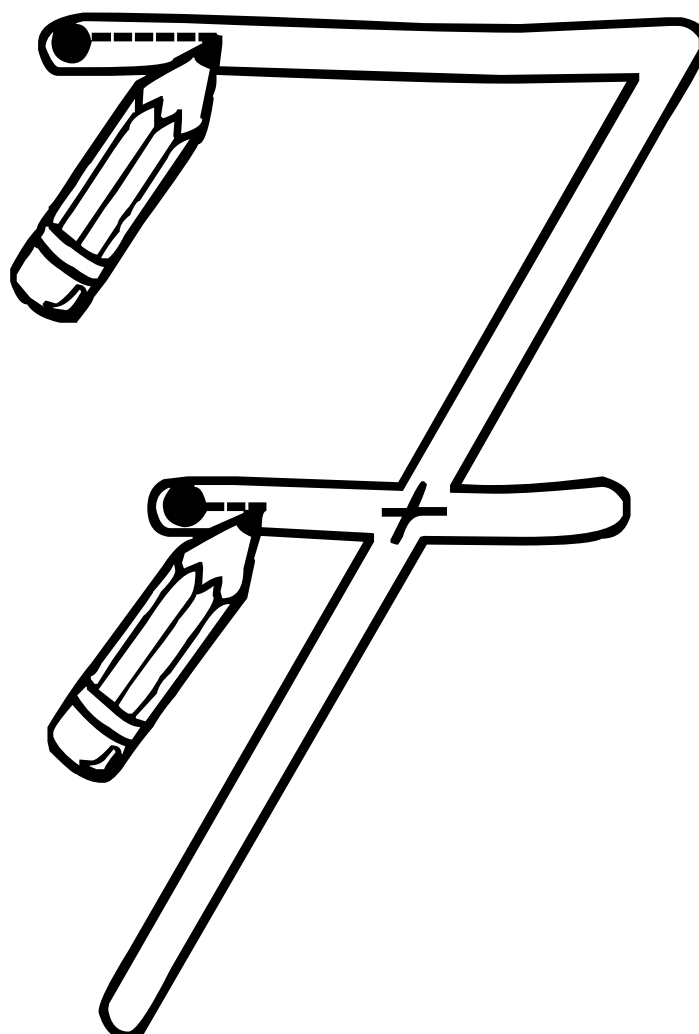



1 Je trace le chiffre 8.

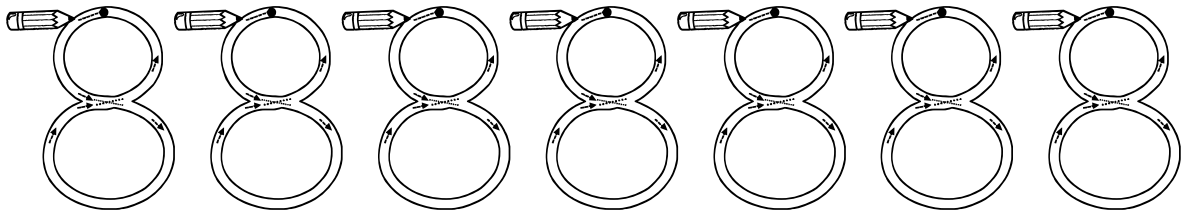

2 Je trace le chiffre 8 dans la règle.

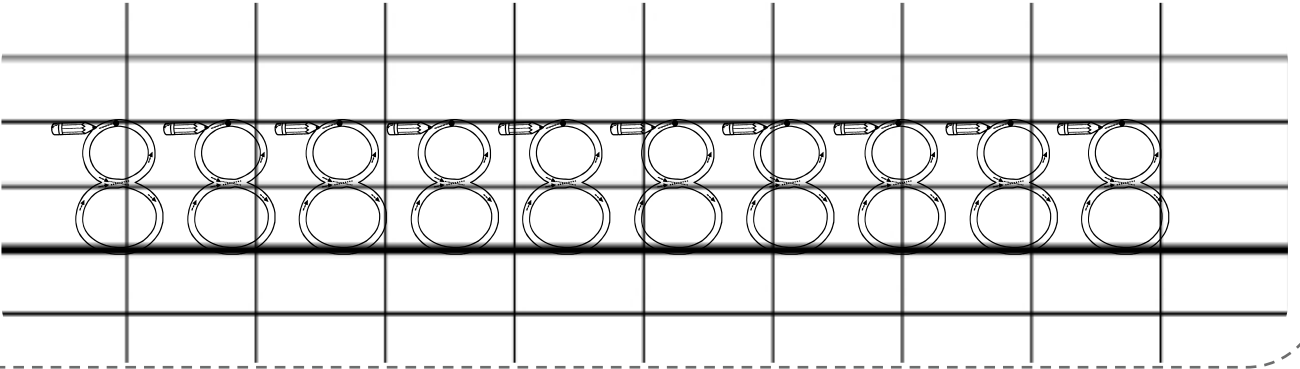

3 J'écris le chiffre 8.

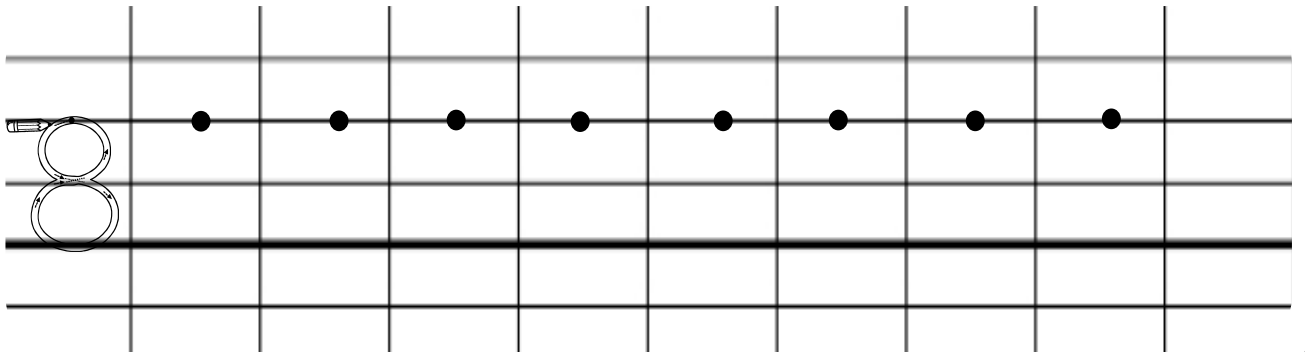

4 J'écris le chiffre 8 sans aide.

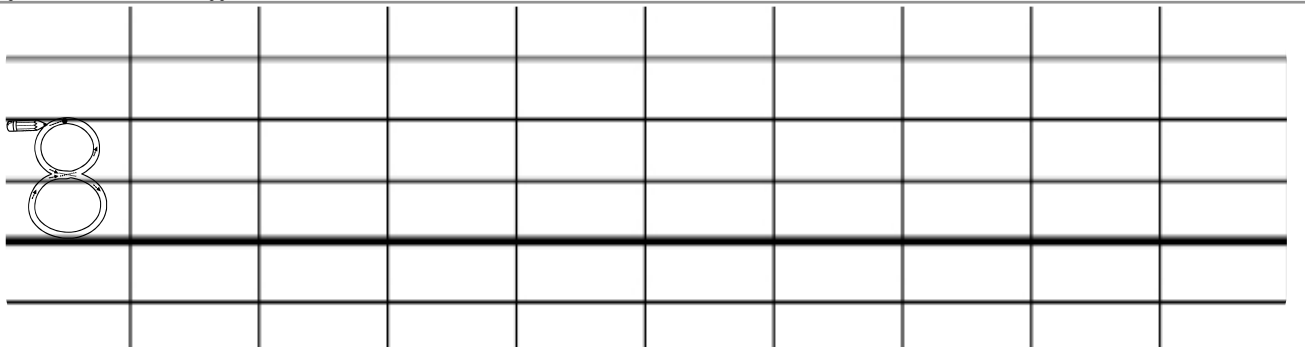

# Le chiffre 8

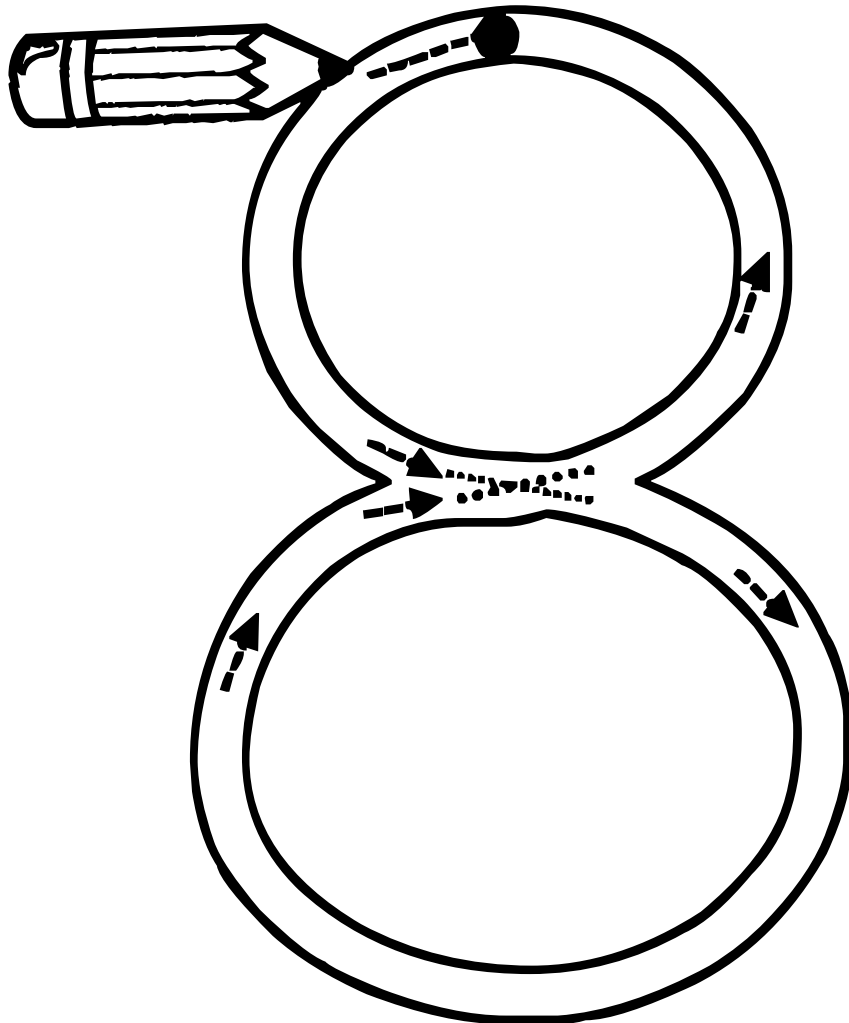
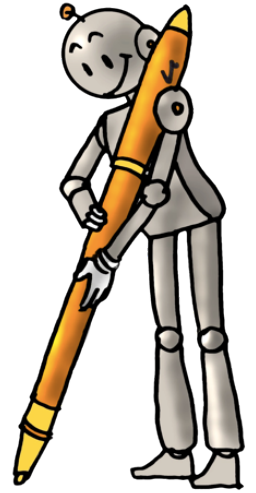

1 Je trace le chiffre 9.

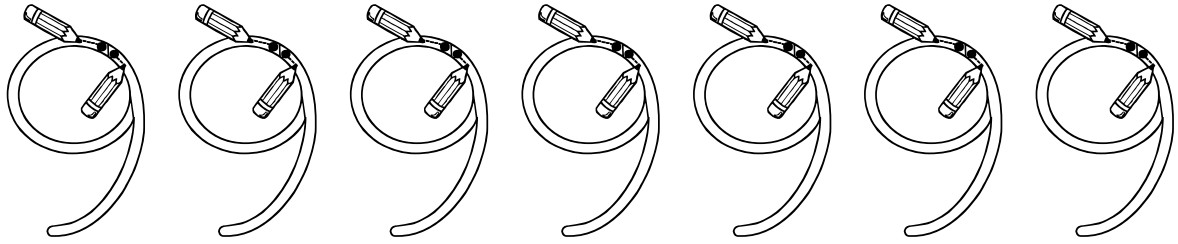

2 Je trace le chiffre 9 dans la règle.

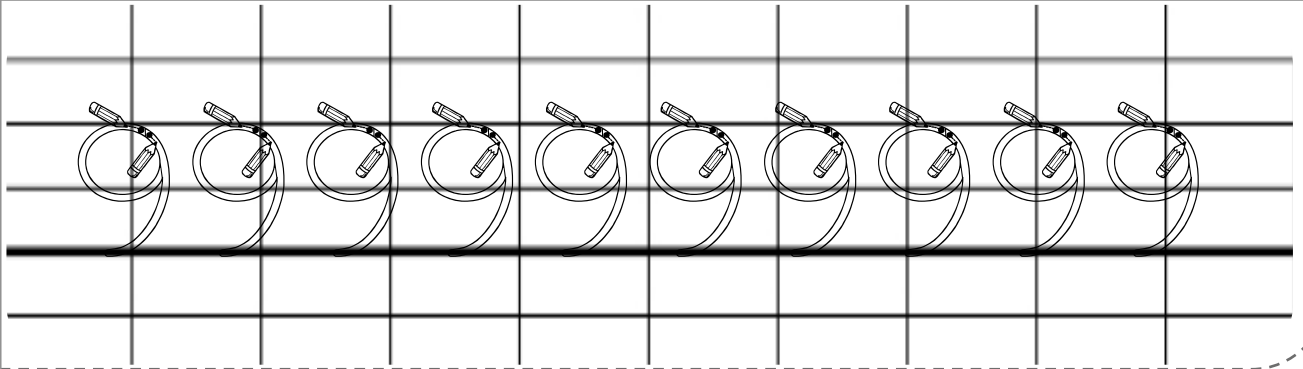

3 J'écris le chiffre 9.

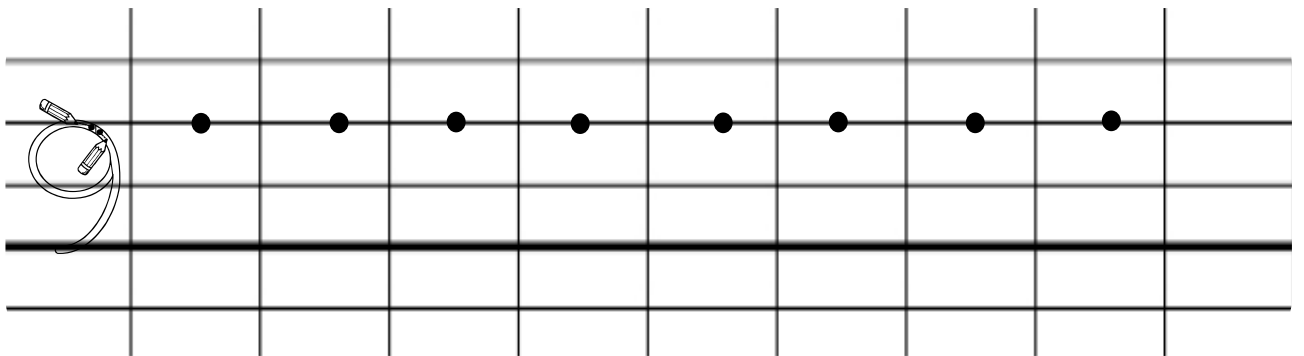

4 J'écris le chiffre 9 sans aide.

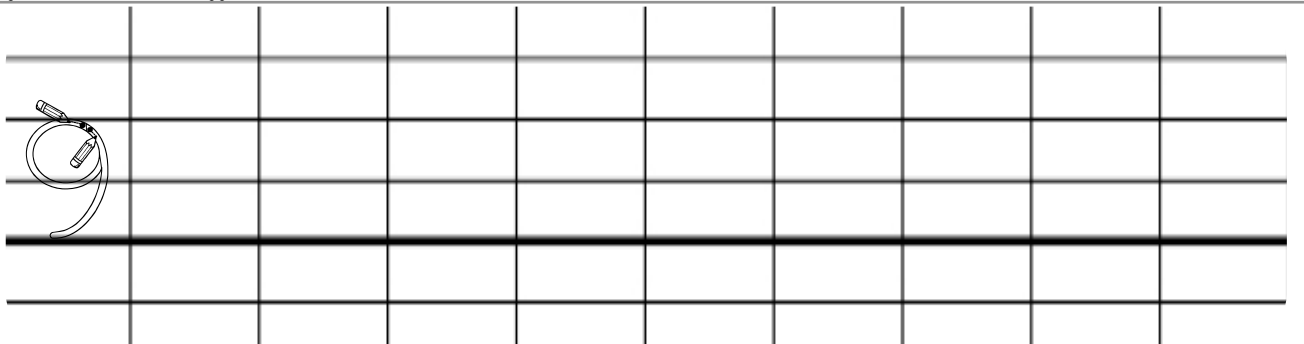

# Le chiffre 9

