

Methane Digesters For Fuel Gas and Fertilizer

With Complete Instructions For Two
Working Models

by

L. John Fry
Santa Barbara, California

"Methane Digesters" is also published, independently, as Newsletter No. 3,
Spring 1973,
by The New Alchemy Institute, Box 432, Woods Hole, Massachusetts 02543,
price \$3.00.

Eighth Printing

© 1973 L. John Fry
Richard Merrill

Inspiration: L. John Fry
Contributors: L. John Fry, Richard Merrill
Editors: Richard Merrill, Yedida Merrill
Artwork: Beth Amine
Thanks to: Earl Barnhart
Kim Mitchell

Methane Digesters For Fuel Gas and Fertilizer

With Complete Instructions For Two Working Models

by L. John Fry

1. Background



Mr. L. John Fry beside a three-digester unit he made in 1973. Gas holder center, water-heater on the right. Buckets in the foreground were for loading raw materials. This unit was taken down in 1974.

Figures

(On my S. African farm):

Capital cost = \$10,000

Gas per day = 8,000 ft³

Value, as gas = \$7.57/day or \$16,578 over six years

Value, as electricity = \$7.43/day or \$16,271 over six years

PLUS savings down from 8 man/days per week to 1 man/day

PLUS 5 tons Nitrogen, 4 1/2 tons Phosphates and 1 ton Potash per year in liquid end products.

When organic material decays it yields useful by-products. The kind of by-product depends on the conditions under which decay takes place. Decay can be *aerobic* (with oxygen) or *anaerobic* (without oxygen). Any kind of organic matter can be broken down either way, but the end products will be quite different (Fig. 1).

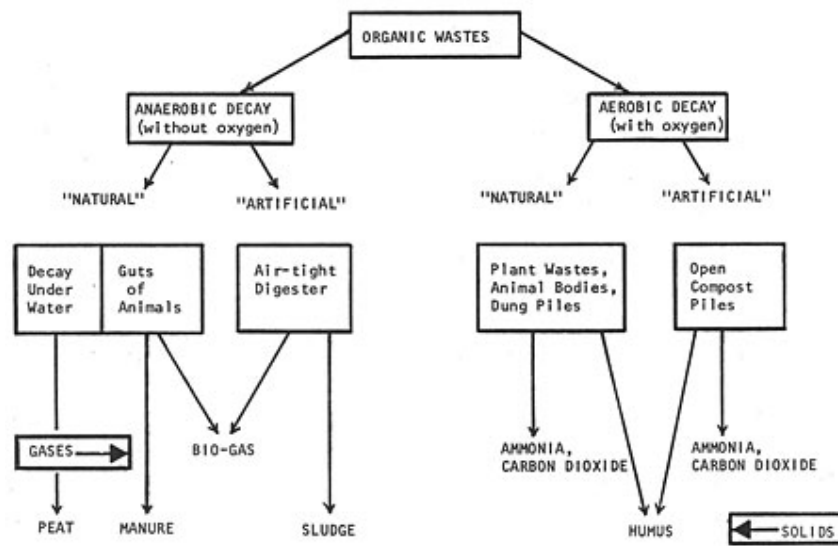

FIG.1 End Products of Organic Decay

It is possible to mimic and hasten the natural anaerobic process by putting organic wastes (manure and vegetable matter) into insulated, air-tight containers called digesters. Digesters are of two types:

1. Batch-load digesters which are filled all at once, sealed, and emptied when the raw material has stopped producing gas; and
2. Continuous-load digesters which are fed a little, regularly, so that gas and fertilizer are produced continuously.

The digester is fed with a mixture of water and wastes, called "slurry." Inside the digester, each daily load of fresh slurry flows in one end and displaces the previous day's load which bacteria and other microbes have already started to digest.

Each load progresses down the length of the digester to a point where the methane bacteria are active. At this point large bubbles force their way to the surface where the gas accumulates. The gas is very similar to natural gas and can be burned directly for heat and light, stored for future use, or compressed to power heat engines.

Digestion gradually slows down toward the outlet end of the digester and the residue begins to stratify into distinct layers (Fig. 2)

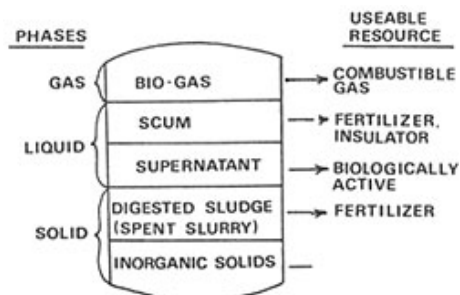

FIG.2 Layering of By-Products In the Digester

- *Sand and Inorganic Materials* at the bottom.
- *Sludge*, the spent solids of the original manure reduced to about 40% of the volume it occupied in the raw state. Liquid or dry sludge makes an excellent fertilizer for crops and pond cultures.
- *Supernatant*, the spent liquids of the original slurry. Note that the fertilizing value of the liquid is as great as sludge, since the dissolved solids remain.
- *Scum*, a mixture of coarse fibrous material, released from the raw manure, gas, and liquid. The accumulation and removal of scum is one of the most serious problems with digesters. In moderate amounts, scum can act as an insulation. But in large amounts it can virtually shut down a digester.

For perspective, consider the total fuel value of methane that could be produced from the *available organic wastes* in the United States.

Table 1.
Total Fuel Value of U.S. Methane Resources Supplied by Digestion of Readily Collectable, Dry, Ash-Free Organic Wastes.

| | |
|---|---|
| I. Fuel Value of U.S. Methane Resources (From Ref. 1) | |
| A. Organic wastes in U.S./year | 2 billion tons (wet weight) 800 million tons (dry weight) |
| B. Dry organic waste readily collectable | 136.3 million tons |
| C. Methane available from "B" | 1.36 trillion ft ³ /year (@10,000 ft ³ /ton)* |
| D. Fuel value of methane from "C" | 1,360 trillion BTU/yr (1000 BTU/ft ³) |
| II. Fuel Consumption of U.S. Farm Equipment (From Ref. 2) | |
| A. Total gasoline consumed (1965) | 7 billion gallons/year |
| B. Total energy consumed by "A" | 945 trillion BTU/year (1 gallon gasoline = 135,000 BTU) |
| III. Total U.S. Natural Gas Consumption (1970) | 19,000 trillion BTU |
| IV. Total U.S. Energy Consumption (1970) | 64,000 trillion BTU |

*Urban refuse; higher figure for manure and agricultural wastes.

So, speaking generally, methane gas converted from *easily available* organic wastes could supply about 150% of the gasoline energy used by all U.S. farm equipment (1965), 7% of the 1970 natural gas energy, and 2% of the total 1970 U.S. energy demands.

Methane-Gas Plant: Synergy at Work

When we consider digesters on a homestead scale, there are two general questions to ask: (1) with the organic wastes and resources at hand, what kind of digester should be built, and how big should it be? And (2) what is the best way of using the gas and sludge produced to satisfy the energy needs of the people involved (whether the sludge should be used to fertilize crops, fish or algae ponds, and whether the gas should be used directly for heat, and light, or stored, or fed back to the digester to heat it, etc. Fig. 3)?

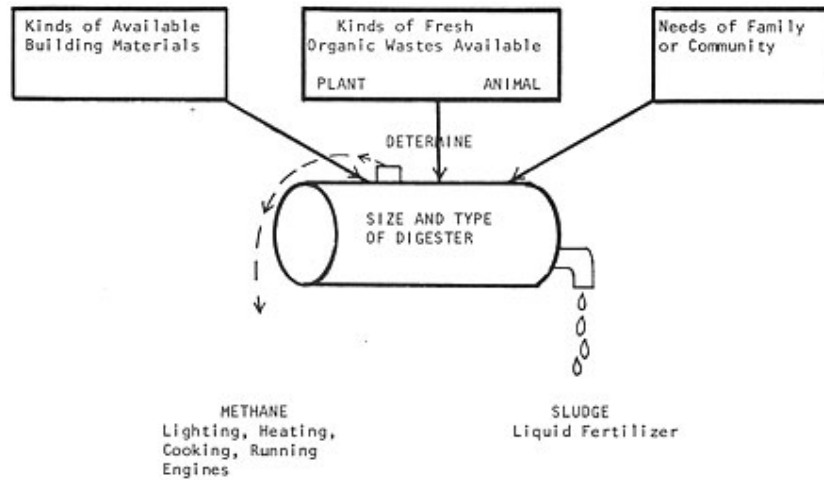

Fig. 3 Related considerations of a digester operation

The first question involves the digester itself, which is just the heart of a whole energy system. The second question is synergistic; you can choose which products are to be generated by digestion and how to use them or feed them back to the digester, creating an almost endless cycle if you wished (Fig. 4).

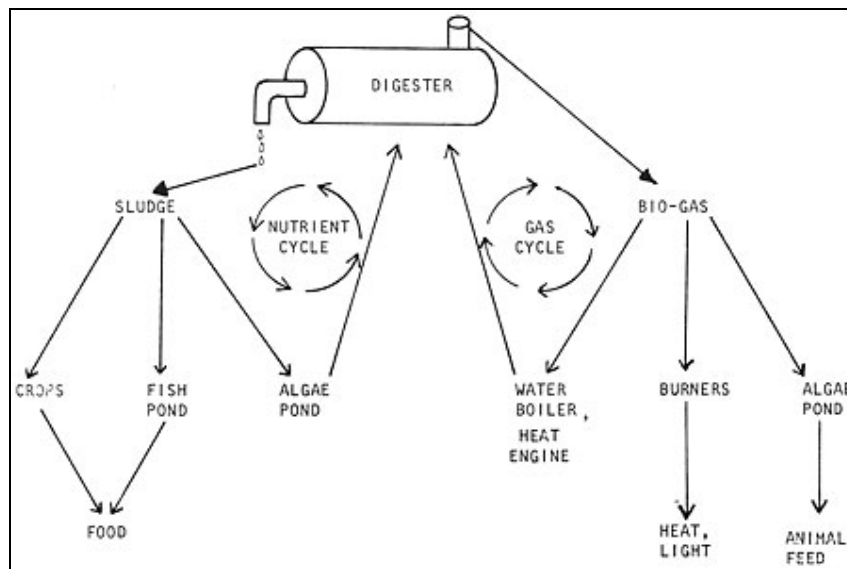

Fig. 4 The closed nutrient system of a complete digester operation

The model in Fig. 4 is idealized from oriental aquaculture systems and other ideas, both old and new.

A single pathway can be developed exclusively (have your digester produce only sludge to feed an algae pond) or you can develop the potential synergy (many possible systems working together as an integrated whole, Fig. 5).

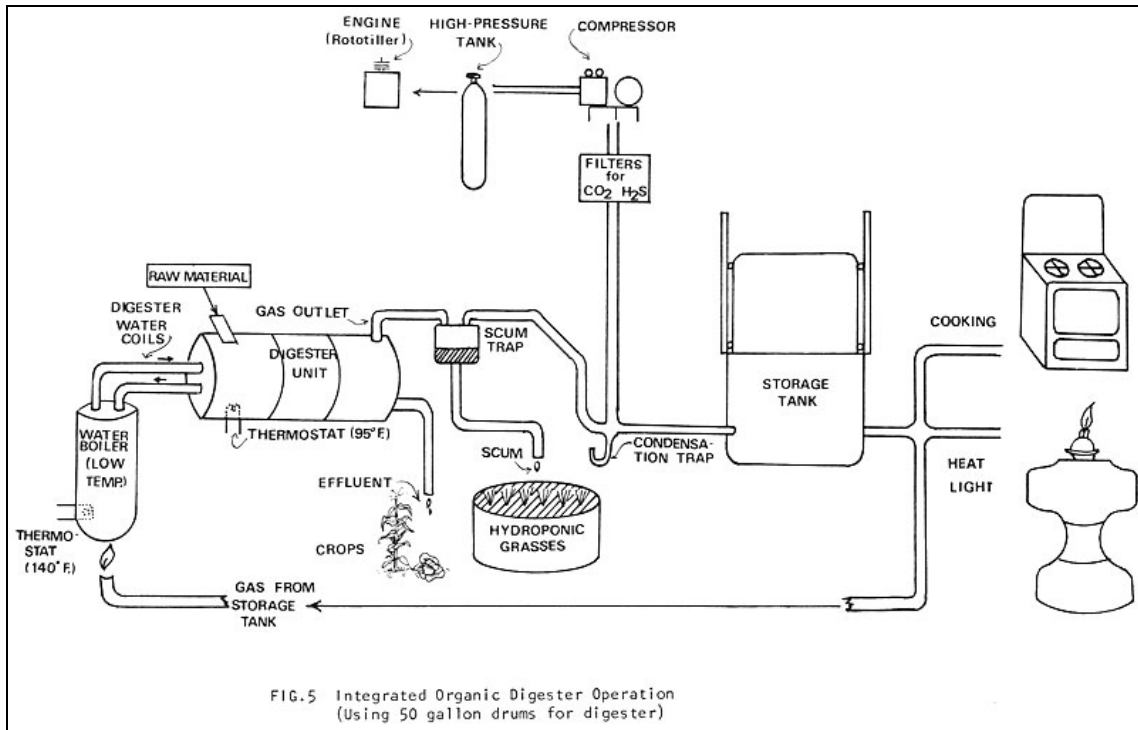

Fig. 5 Integrated organic digester operation (using 50 gallon drums for digester)

The small farmer or rural homesteader can take a step toward ecological self-sufficiency by producing some of his fuel and fertilizer needs using a digester to convert local wastes.

Total dependence on conventional fuels, especially in rural areas, is likely to become a serious handicap in the years to come as reserve shortages and specialized technologies hike the costs of fossil and nuclear fuels. But by producing energy from local resources, it is possible to be partially freed from remote sources of increasingly expensive fuel supplies.

2. History

In nature, anaerobic decay is probably one of the earth's oldest processes for decomposing wastes. Organic material covered by a pool of warm water will first turn acid and smell rank, then slowly over about six months will turn alkali. The methane bacteria, always present, will take over and decompose it, and gas bubbles will rise to the surface.

Anaerobic decay is one of the few natural processes that hasn't been fully exploited until recent times. Pasteur once discussed the possibilities of methane production from farmyard manure. And (according to a report issued from China, April 26, 1960) the Chinese have used "covered lagoons" to supply methane fuel to communes and factories for decades. But the first attempt to build a digester to produce methane gas from organic wastes (cow dung) appears to have been in Bombay, India in 1900. At about this time, sewage plants started digesting sewage sludge in order to improve its quality. This started a mass of laboratory and small-scale experiments during the 20's and 30's (many of them summarized by Acharya, Ref. 3).

During World War II, the shortage of fuel in Germany led to the development of methane plants in rural areas, where the gas was used to power tractors. The idea spread into Western Europe, until fossil fuels once again became available (although, today, many farmers in France and Germany continue to use home digesters to produce their own methane fuel gas).

Currently the focus of organic digester/bio-gas research is in India. India's impetus has been the overwhelming need of a developing country to raise the standard of living of the rural poor. Cows in India produce over 800 million tons of manure per year; over half of this is burned for fuel and thus lost as a much needed crop fertilizer. (Ref. 4) The problem of how to obtain cheap fuel *and* fertilizer at a local level led to several studies by the Indian Agricultural Research Institute in the 1940's to determine the basic chemistry of anaerobic decay. In the 1950's, simple digester models were developed which were suitable for village homes. These early models established clearly that bio-gas plants could:

1. provide light and heat in rural villages, eliminating the need to import fuel, to burn cow dung, or to deforest land;
2. provide a rich fertilizer from the digested wastes; and
3. improve health conditions by providing air-tight digester containers, thus reducing disease borne by exposed dung.

More ambitious designs were tested by the Planning Research and Action Institute in the late 1950's. Successes led to the start of the Gobar Gas Research Station at Ajitmal where, with practical experience from the Khadi and Village Industries Commission, two important pamphlets (Ref. 5, 6) were published on the design of village and homestead "bio-gas" plants in India.

In America, where the problem is waste disposal, rather than waste use, organic digesters have been limited to sewage treatment plants. (Ref. 7, 8.) In some cases sludge is recycled on land or sold as fertilizer (Ref. 9, 10), and methane gas is used to power generators and pumps in the treatment plants (Ref. 11). The Hyperion sewage treatment plant in Los Angeles generates enough methane from its primary treatment alone to power its 24-2,000 hp. diesel engines. Usually, however, both sludge and gas are still regarded as waste problems.

Much information on digestion and small-scale digester operations comes from experiences in India, Western Europe and South Africa and journals such as: *Compost Science, Water Sewage Work, Soils and Fertilizer, Waste Engineering, Sewage and Industrial Wastes* and recent publications of the U.S. Environmental Protection Agency and Solid Waste Conferences (see Bibliography at end). An *excellent* book to learn from is called: *Manual of Instruction for Sewage Plant Operators*, put out by the New York State Dept. of Health and available from the Health Education Service, P.O. Box 7283, Albany, New York 12224.

A great deal of information can be found in pre-WW II sewage journals, especially *Sewage Works Journal*. After WW II, as with most other kinds of science and technology, waste treatment research became a victim of the trend to make machines ever bigger, and information increasingly incomprehensible.

3. Biology of Digestion

Bio-Succession in the Digester

Perhaps the most important thing to remember is that digestion is a biological process.

The "anaerobic" bacteria responsible for digestion can't survive with even the slightest trace of oxygen. So, because of the oxygen in the manure mixture fed to the digester, there is a long period after loading before actual digestion takes place. During this initial "aerobic" period, traces of oxygen are used up by oxygen-loving bacteria, and large amounts of carbon dioxide (CO₂) are released.

When oxygen disappears, the digestion process can begin. That process involves a series of reactions by several kinds of anaerobic bacteria feeding on the raw organic matter. As different kinds of these bacteria become active, the by-products of the first kind of bacteria provide the food for the other kind (Fig. 6). In the first stages of digestion, organic material which is digestible (fats, proteins and most starches) are broken down by *acid producing bacteria* into simple compounds. The acid bacteria are capable of rapid reproduction and are not very sensitive to changes in their environment. Their role is to excrete enzymes, liquefy the raw materials and convert the complex materials into simpler substances (especially *volatile acids*, which are low molecular weight organic acids -- See **4 Raw Materials**). The most important volatile acid is acetic acid (table vinegar is dilute acetic acid), a very common by-product of all fat, starch and protein digestion. About 70% of the methane produced during fermentation comes from acetic acid (Ref. 12).

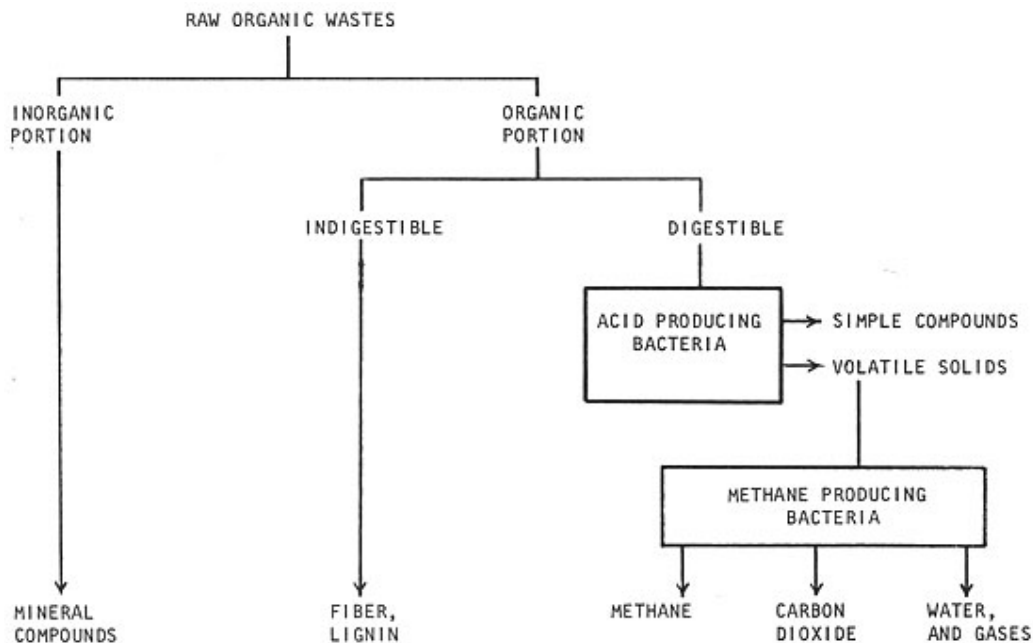

FIG.6 The Biological Breakdown of Wastes in the Digester

Once the raw material has been liquefied by the *acid producing bacteria*, *methane producing bacteria* convert the volatile acids into methane gas. Unlike the acid bacteria, methane bacteria reproduce slowly and are very sensitive to changes in the conditions of their environment. (More information on the biology of methane fermentation can be found in Ref. 13 and 14.)

Biologically, then, successful digestion depends upon achieving and (for continuous-load digesters) maintaining a balance between those bacteria which produce organic acids and those bacteria which produce methane gas from the organic acids. This balance is achieved by a regular feeding with enough liquid (see **4 Raw Materials**) and by the proper pH, temperature and the quality of raw materials in the digester.

pH and the Well-Buffered Digester

To measure the acid or alkaline condition of a material, the symbol "pH" is used. A neutral solution has pH = 7; an acid solution has pH below 7; and an alkaline solution has pH above 7. The pH has a profound effect on biological activity, and the maintenance of a stable pH is essential to all life. Most living processes take place in the range of pH 5 to 9. The pH requirements of a digester are stricter (pH 7.5-8.5, Fig. 7).

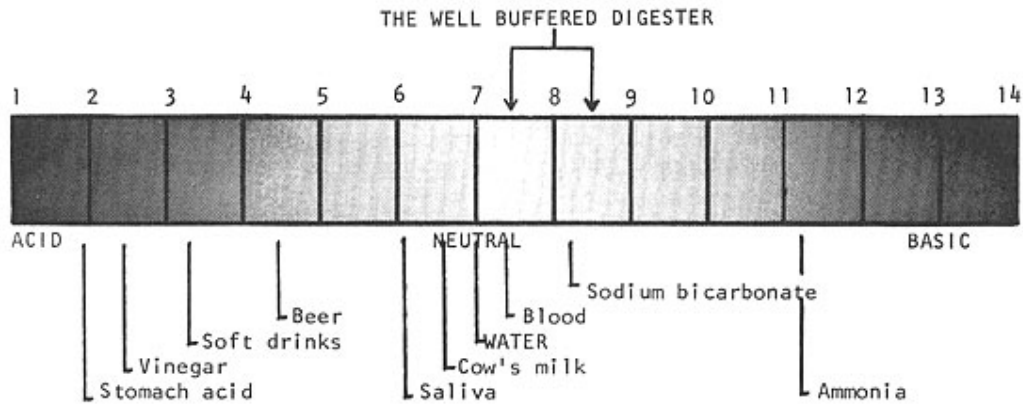

FIG. 7 The pH Scale

During the initial acid phase of digestion, which may last about two weeks, the pH may drop to 6 or lower, while a great deal of CO₂ is given off. This is followed by about three months of a slow decrease in acidity during which volatile acids and nitrogen compounds are digested, and ammonia compounds are formed (this ammonia becomes important when we consider the fertilizer value of sludge). As digestion proceeds, less CO₂ and more methane is produced and the pH rises slowly to about 7. As the mixture becomes less acid, methane fermentation takes over. The pH then rises above the neutral point (pH = 7), to between pH 7.5 and 8.5. After this point, the mixture becomes well *buffered*; that is, even when large amounts of acid or alkali are added, the mixture will adjust to stabilize itself at pH 7.5 to 8.5.

Once the mixture has become well buffered, it is possible to add small amounts of raw material periodically and maintain a constant supply of gas and sludge (continuous load digesters). If you don't feed a digester regularly (batch-load digesters), enzymes begin to accumulate, organic solids become exhausted and methane production ceases.

After digestion has stabilized, the pH should remain around 8.0 to 8.5. The ideal pH values of effluent in *sewage* treatment plants is 7 to 7.5, and these values are usually given as the best pH range for digesters in general. From our experience, a slightly more alkaline mixture is best for digesters using raw animal or plant wastes.

You can measure the pH of your digester with "litmus" or pH paper which can be bought at most drug stores. Dip the pH paper into the effluent as it is drawn off. Litmus paper turns red in acid solutions (pH 1 to 7) and blue in alkaline solutions (pH 7 to 14). You can get more precise measurements using pH paper which changes colors within a narrow range of pH values.

**Table 2.
Problems with pH.**

| Condition | Possible Reasons | "Cure" |
|--------------------------------|--------------------------------------|--|
| | 1) Adding raw materials too fast | Reduce feeding rate; Ammonia |
| Too acid (pH 6 or less) | 2) Wide temperature fluctuation | Stabilize temperature |
| | 3) Toxic Substances | |
| | 4) Build-up of scum | Remove scum |
| Too Alkaline (pH 9 or more) | 1) Initial raw material too alkaline | Patience Never put acid into digester |

If the pH in the continuous-load digester becomes too acidic (Table 2), you can bring it up to normal again by adding fresh effluent to the inlet end, or by reducing the amount of raw material fed to the digester, or as a last resort, by adding a little ammonia. If the effluent becomes too alkaline, a great deal of CO₂ will be produced, which will have the effect of making the mixture more acidic, thus correcting itself. Patience is the best "cure" in both cases. NEVER add acid to your digester. This will only increase the production of hydrogen sulfide.

Temperature

For the digesting bacteria to work at the greatest efficiency, a temperature of 95°F (35°C) is best. Gas production can proceed in two ranges of temperature: 85-105°F (29-40°C) and 120-140°F (49-60°C). Different sets of acid-producing and methane bacteria thrive in each of these different ranges. Those active in the higher range are called heat-loving or "thermophilic" bacteria (Fig. 8). Some raw materials, like algae, require this higher range for digestion. But digesters are not commonly operated at this higher range because:

1. most materials digest well at the lower range,
2. the thermophilic bacteria are *very* sensitive to any changes in the digester,
3. the sludge they produce is of poor fertilizer quality, and
4. it is difficult to maintain such a high temperature, especially in temperate climates.

The bacteria that produce methane in the "normal range" 90-95°F (32-35°C) are more stable and produce a high quality sludge. It is not difficult to maintain a digester temperature of 95°F (35°C) (See **6 Digesters -- Heating Digesters**).

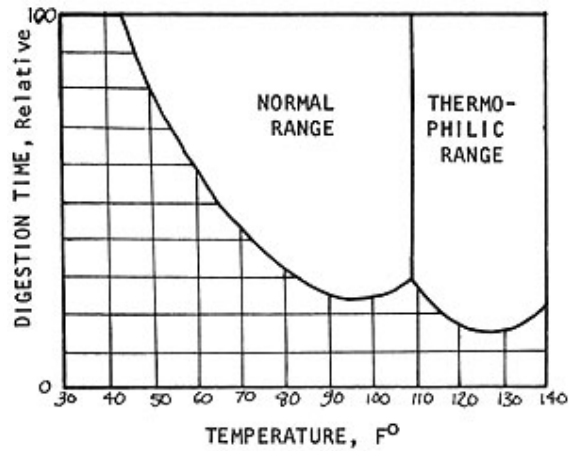

FIG.8 Digestion Time and Temperature
(after Ref. 7)

The same mass of manure will digest twice as fast at 95°F (35°C) than it will at 60°F (15°C) (Fig. 8) and it produces nearly 15 times more gas in the same amount of time! (Fig. 9) (See how the amount of gas produced improves with temperature to 80-100°F (27-38°C), where production is optimum.) In Fig. 10 it can be seen how a different amount of gas is produced when the digester is kept at 60°F (15°C) than when it is kept at 95°F (35°C).

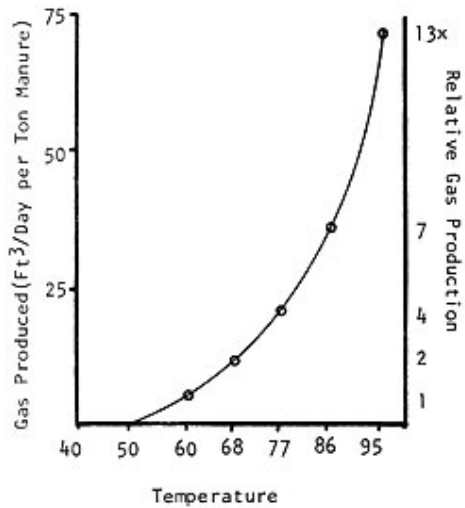

FIG.9 Gas Production and Temperature
(after Ref. 15)

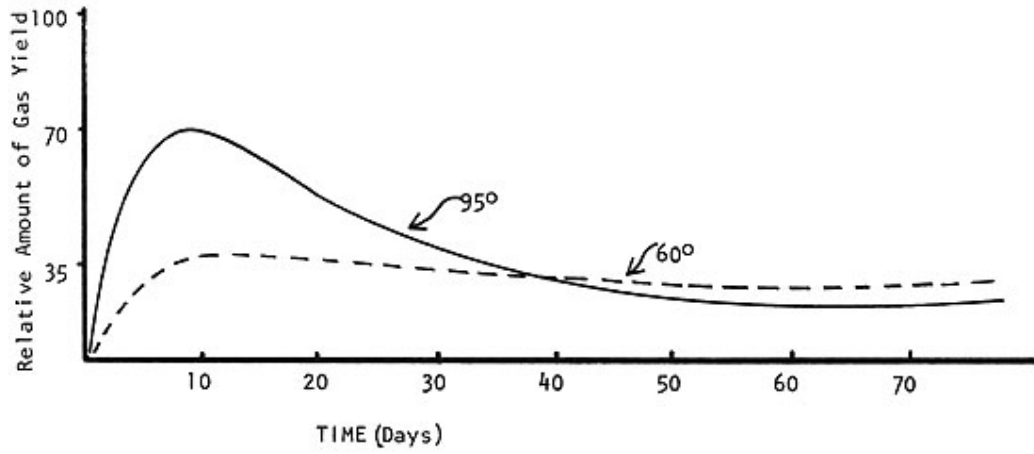

FIG.10 Comparison of Gas Production Rates at 60°F and 95°F
(Measured from time new sludge added
to buffered digester).

4. Raw Materials

The amount and characteristics of organic materials (both plant and animal wastes) available for digestion vary widely. In rural areas, the digestible material will depend upon the climate, the type of agriculture practiced, the animals used and their degree of confinement, the methods of collecting wastes, etc. There are also degrees of quality and availability unique to urban wastes. Because of all these things, it is practically impossible to devise or use any formula or rule-of-thumb method for determining the amount and quality of organic wastes to be expected from any given source. There is, however, some basic information which is useful when you start wondering how much waste you can feed your digester.

Digestible Properties of Organic Matter

When raw materials are digested in a container, only part of the waste is actually converted into methane and sludge. Some of it is indigestible to varying degrees, and accumulates in the digester or passes out with the effluent and scum. The "digestibility" and other basic properties of organic matter are usually expressed in the following terms (see Ref. 16):

- *Moisture*: The weight of water lost upon drying at 220°F (105°C) until no more weight is lost.
- *Total Solids (TS)*: The weight of dry material remaining after drying as above. TS weight is usually equivalent to "dry weight." (However, if you dry your material in the sun, assume that it will still contain around 30% moisture.) TS is composed of digestible organic or "Volatile Solids" (VS), and indigestible residues or "Fixed Solids."
- *Volatile Solids (VS)*: The weight of organic solids burned off when dry material is "ignited" (heated to around 1000°F, 538°C). This is a handy property of organic matter to know, since VS can be considered as the amount of solids actually converted by the bacteria.
- *Fixed Solids (FS)*: Weight remaining after ignition. This is biologically inert material.

As an example, consider the make-up of fresh chicken manure (Ref. 17).

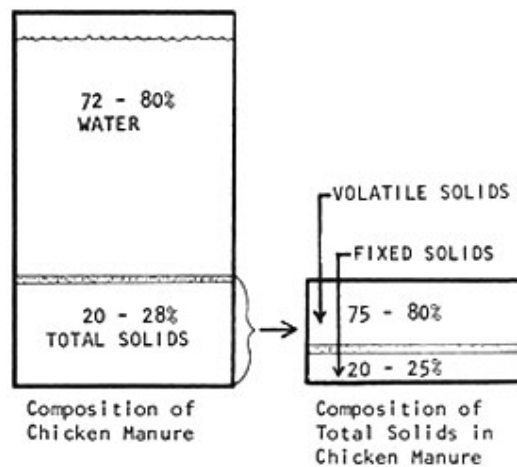

FIG.11 Properties of Chicken Manure

So if we had 100 pounds of fresh chicken manure, 72-80 pounds of this would be water, and only 15-24 pounds (75-80% Volatile Solids of the 20-28% Total Solids) would be available for actual digestion.

Amount of Manure Collectable

When you see a table which shows the amount of manure produced by different kinds of livestock, it's important to know that the amount on the table may not be the amount that is actually available from your animals. There are three major reasons for this:

1) The Size (Age) Of The Animal

Consider the total wet manure production of different sized pigs:

Table 3

| Hog Weight | Total Manure Lbs/Day | Faeces | Urine | Ratio Manure/Hog Wt. |
|-------------------|-----------------------------|---------------|--------------|-----------------------------|
| 40-80 | 5.6 | 2.7 | 2.9 | 1:11 |
| 80-120 | 11.5 | 5.4 | 6.1 | 1:9 |
| 120-160 | 14.6 | 6.5 | 8.1 | 1:10 |
| 160-200 | 17.6 | 8.5 | 9.1 | 1:10 |

(From 37)

So the size (age) of your livestock has a lot to do with the amount of manure produced. Notice that the ratio of total wet manure production to the weight of the pig is fairly constant. It is likely that similar ratios could be worked out for other kinds of livestock, enabling you to estimate the production of manure from the size of livestock.

2) The Degree of Livestock Confinement

Often the values given for manure production are for commercial animals which are totally confined. All of their manure can be collected. On the homestead or small farm, total confinement of the livestock is not always possible or even desirable. (Foraging and uncrowded livestock are less likely to contract diseases and more likely to increase the quality of their diet with naturally occurring foods.) Because of this, a large proportion of the manure is deposited in fields and thus hard to collect. For example, the fresh manure production of commercial chickens in total confinement is about 0.4 lbs. per chicken per day (Ref. 17, 28). However, for small-scale operations like homesteads and small farms, where preference tends to favor the well-being of the chickens rather than the economics of egg production, chickens are often allowed to forage all day and confined only at night. In such cases, only manure dropped during the night from roosts can be conveniently collected. In our experience, this may amount to only about 0.1 to 0.2 pounds of fresh manure per day per adult chicken. Similar reasoning holds for other livestock.

3) The Kind of Manure that is Collected

- a) All the fresh excrement (feces and urine).
- b) All the fresh excrement plus the bedding material.
- c) Wet feces only.
- d) Dry feces only.

Manure Production and the Livestock Unit

Keeping in mind all these factors that can affect the type and amount of manure that can be collected, we can assemble a general manure production table. The table only shows rough average values obtained for many sources (Ref. 15, 17, 21--39). Values are expressed as the amount in pounds of wet manure, dry manure and volatile solids that could be expected from various adult livestock per day. For the table, an adult animal is: cow -- 1000 lbs; horse -- 850 lbs; swine -- 160 lbs; human -- 150 lbs; sheep -- 67 lbs; turkey -- 15 lbs; duck -- 6 lbs; chicken -- 3-1/2 lbs. (We need information on goats and rabbits.)

Table 4 enables us to get some idea of the production of readily digestible material (volatile solids) from different animals. Only the feces is considered for cows, horses, swine, and sheep, since their urine is difficult to collect. However, for humans and fowl, both urine and feces are given, since they are conveniently collected together.

| Average Adult Animal | lbs/day/animal | | Total Solids/Day | Volatile Solids/Day | Livestock Units | |
|----------------------|---------------------------|------------------|------------------|---------------------------|-----------------|---------------|
| | Urine | Feces | 20% of Feces | 80% of TS - 85% for Swine | | |
| BOVINE (1000 lbs.) | 20 | 52 | 10 | 8.0 | | |
| Bulls | | | | | 130-150 | |
| Dairy cow | | | | | 120 | |
| Under 2 yrs | | | | | 50 | |
| Calves | | | | | 10 | |
| HORSES (850 lbs.) | 8 | 36 | 7 | 5.5 | | |
| Heavy | | | | | 130-150 | |
| Medium | | | | | 100 | |
| Pony | | | | | 50-70 | |
| SWINE (160 lbs.) | 4.0 | 7.5 | 1.5 | 1.3 | | |
| Boar, sow | | | | | 25 | |
| Pig >160 lbs | | | | | 20 | |
| Pig <160 lbs | | | | | 10 | |
| Weaners | | | | | 2 | |
| SHEEP (67 lbs.) | 1.5 | 3 | 0.5 | 0.4 | | |
| Ewes, rams | | | | | 8 | |
| Lambs | | | | | 4 | |
| | <u>Portion</u> | <u>Amount</u> | <u>%TS</u> | <u>TS/Day</u> | <u>%VS</u> | <u>VS/Day</u> |
| HUMANS (150 lbs.) | Urine | 2 pints, 2.2 lbs | 6% | .13 | 75% | .10 |
| | Feces | 0.5 lbs | 27% | .14 | 92% | .13 |
| | Both | 2.7 lbs | 11% | .3 | 84% | .25 |
| FOWL | Geese, Turkey (15 lb.) | 0.5 | | | | |
| | Ducks (6 lb.) | | | | | 2 |
| | Layer Chicken (3 1/2 lb.) | 0.3 | 35% | .1 | 65% | 1.5 |
| | Broiler Chicken | 0.1 | | | | 1 |

TABLE 4. Manure and the Livestock Unit

The relative values of digestible wastes produced are not given in pounds of manure per animal per day, but in a more convenient relative unit called the "Livestock Unit." The table shows that *on the average* one medium horse would produce as much digestible manure as 4 large pigs, 12-1/2 ewes, 20 adult humans or 100 chickens.

Carbon to Nitrogen Ratio (C/N)

From a biological point of view, digesters can be considered as a culture of bacteria feeding upon and converting organic wastes. The elements *carbon* (in the form of carbohydrates) and *nitrogen* (as protein, nitrates, ammonia, etc.) are the chief foods of anaerobic bacteria. Carbon is utilized for energy and the nitrogen for building cell structures. These bacteria use up carbon about 30 times faster than they use nitrogen.

Anaerobic digestion proceeds best when raw material fed to the bacteria contains a *certain* amount of carbon *and* nitrogen together. The carbon to nitrogen ratio (C/N) represents the proportion of the two elements. A material with 15 times more carbon than nitrogen would have a C/N ratio of 15 to 1 (written C/N = 15/1, or simply 15).

A C/N ratio of 30 (C/N = 30/1, 30 times as much carbon as nitrogen) will permit digestion to proceed at an optimum rate, if other conditions are favorable, of course. If there is *too much carbon* (high C/N ratio; 60/1 for example) in the raw wastes, nitrogen will be used up first, with carbon left over. This will make the digester slow down. On the other hand, if there is *too much nitrogen* (low C/N ratio; 30/15 for example, or simply 2), the carbon soon becomes exhausted and fermentation stops. The remaining nitrogen will be lost as ammonia gas (NH₃). This loss of nitrogen decreases the fertility of the effluent sludge.

There are many standard tables listing the C/N ratios of various organic materials, but they can be very misleading for at least two reasons:

1. The ratio of carbon to nitrogen measured chemically in the laboratory is often not the same as the ratio of carbon to nitrogen *available* to the bacteria as food (some of the food could be indigestible to the bacteria; straw, lignin, etc.).
2. The nitrogen or carbon content of even a specific kind of plant or animal waste can vary tremendously according to the age and growing conditions of the plant; and the diet, age, degree of confinement, etc., of the animal.

Nitrogen: Because nitrogen exists in so many chemical forms in nature (ammonia, NH₃; nitrates, NO₃; proteins, etc.), there are no reliable "quick" tests for measuring the total amount of nitrogen in a given material. One kind of test might measure the organic and ammonia nitrogen (the Kjeldahl test), another might measure the nitrate/nitrite nitrogen, etc. Also, nitrogen can be measured in terms of wet weight, dry weight or volatile solids content of the material; all of which will give different values for the proportion of nitrogen. Finally, the nitrogen content of a specific kind of manure or plant waste can vary, depending on the growing conditions, age, diet, and so forth.

For example, one study reported a field of barley which contained 39% protein on the 21st day of growth, 12% protein on the 49th day (bloom stage), and only 4% protein on the 86th day (Ref. 18). You can see how much the protein nitrogen depends on the age of the plant.

The nitrogen content of manure also varies a great deal. Generally, manures consist of feces, urine and any bedding material (straw, corn stalks, hay, etc.) that may be used in the livestock shelters. Because urine is the animal's way of getting rid of excess nitrogen, the nitrogen content of manures is strongly affected by how much urine is collected with the feces.

For example, birds naturally excrete feces and urine in the same load, so that the nitrogen content of chickens, turkeys, ducks, and pigeons are highest of the animal manures in nitrogen content. Next in nitrogen content, because of their varied diets or grazing habits are humans, pigs, sheep, and then horses. Cattle and other ruminants (cud chewers) which rely on bacteria in their gut to digest plant foods, have a low content of manure nitrogen because much of the available nitrogen is used to feed their intestinal bacteria. (Fig.12)

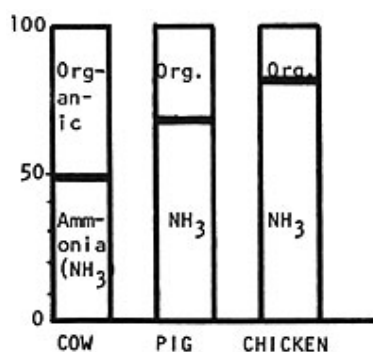

FIG.12 Types of Nitrogen Found in Different Kinds of Manure

Even with the same kind of animal there are big differences in the amount of manure-nitrogen. For example, stable manure of horses may have more nitrogen than pasture manure because feces and urine are excreted and collected in the same small place.

Since there are so many variables, and because anaerobic bacteria can use most forms of nitrogen, the *available nitrogen* content of organic materials can best be generalized and presented as *total nitrogen* (% of dry weight).

Carbon: Unlike nitrogen, carbon exists in many forms which are not directly useable by bacteria. The most common indigestible form of carbon is *lignin*, a complex plant compound which makes land plants rigid and decay-resistant. Lignin can enter a digester either directly with plant wastes themselves or indirectly as bedding or undigested plant food in manure. Thus, a more accurate picture of the C part of the C/N ratio is obtained when we consider the "non-lignin" carbon content of plant wastes.

Calculating C/N Ratios

Table 5 can be used to calculate roughly the C/N ratios of mixed raw materials. Consider the following examples:

Example 1

Calculate the C/N ratio of 50 lbs horse manure (C/N=25) and 50 lbs dry wheat straw (C/N=150).

Nitrogen in 50 lbs horse manure = 2.3% x 50 = 1.2 lbs

Carbon in 50 lbs horse manure = 25 times more than nitrogen = 25 x 1.2 = 30 lbs

Nitrogen in 50 lbs wheat straw = 0.5% x 50 = .25 lbs

Carbon in 50 lbs wheat straw = 150 times more than nitrogen = 150 x .25 = 37.5 lbs

| | Manure | Straw | Total |
|------------------------------|--------|-------|----------|
| Carbon | 30 | 37.5 | 67.5 lbs |
| Nitrogen | 1.2 | .25 | 1.45 lbs |
| C/N ratio = 67.5/1.45 = 46.5 | | | |

Although a bit high, this would be a satisfactory ratio for most digestion purposes.

Example 2

Calculate the C/N ratio of 8 lbs grass clippings (C/N=12) and 2 lbs of chicken manure (C/N=15).

Nitrogen in 8 lbs grass clippings = 4% x 8 = .32 lbs

Carbon in 8 lbs grass clippings = 12 times more than nitrogen = 3.8 lbs

Nitrogen in 2 lbs chicken manure = 6.3% x 2 = .13 lbs

Carbon in 2 lbs chicken manure = 15 times more than nitrogen = 1.9 lbs

| | Manure | Grass | Total |
|----------|---------------|--------------|--------------|
| Carbon | 3.8 | 1.9 | 5.7 |
| Nitrogen | 0.32 | 0.13 | 0.45 |

C/N ratio = 5.7/.45 = 12.6

The C/N ratio of this mixture is low. We might want to add a higher proportion of chicken manure since it contains more carbon per weight than the grass.

The following table is a summary of the important chemical properties of organic materials. Values are averages derived from many sources (Ref. 14, 16, 18--33) and should be used only for approximation.

**Table 5
Carbon & Nitrogen Values of Wastes**

| | Total Nitrogen % Dry weight | C/N Ratio |
|----------------------|--|----------------------|
| Animal Wastes | | |
| Urine | 16 | 0.8 |
| Blood | 12 | 3.5 |
| Bone Meal | - | 3.5 |
| Animal Tankage | - | 4.1* |
| Dry Fish Scraps | - | 5.1* |
| Manure | | |
| Human faeces | 6 | 6-10 |
| Human urine | 18 | - |
| Chicken | 6.3 | 15 |
| Sheep | 3.8 | - |
| Pig | 3.8 | - |
| Horse | 2.3 | 25* |
| Cow | 1.7 | 18* |
| Sludge | | |
| Milorganite | - | 5.4* |
| Activated | 5 | 6 |
| Fresh Sewage | - | 11* |
| Plant Meals | | |
| Soybean | - | 5 |
| Cottonseed | - | 5* |
| Peanut Hull | - | 36* |
| Plant Wastes | | |
| Hay, Young Grass | 4 | 12 |
| Hay, Alfalfa | 2.8 | 17* |
| Hay, Blue Grass | 2.5 | 19 |
| Seaweed | 1.9 | 19 |
| Non-Legume | 2.5-4 | 11-19 |
| Vegetables | | |
| Red Clover | 1.8 | 27 |
| Straw, Oat | 1.1 | 48 |
| Straw, Wheat | 0.5 | 150 |
| Sawdust | 0.1 | 200 - 500 |

Nitrogen is total nitrogen dry weight and carbon is either total carbon (dry weight) or (*) non-lignin carbon (dry weight).

5. The Gas

Composition

The gas produced by digestion, known as marsh gas, sewage gas, dungas, or bio-gas, is about 70% methane (CH₄) and 29% carbon dioxide (CO₂) with insignificant traces of oxygen and sulfurated hydrogen (H₂S) which gives the gas a distinct odor. (Although it smells like rotten eggs, this odor has the advantage of being able to trace leaks easily.)

The *basic* gas producing reaction in the digester is: carbon plus water = methane plus carbon dioxide (2C + 2H₂O = CH₄ + CO₂). The methane has a specific gravity of 0.55 in relation to air. In other words, it is about half the weight of air and so rises when released to the atmosphere. Carbon dioxide is more than twice the weight of air, so the resultant combination of gases, or simply bio-gas, when released to atmosphere, will rise slowly and dissipate.

As a general rule, pure methane gas has a heat value of about 1,000 British Thermal Units (BTU) per cubic foot (ft³). One BTU is the amount of heat required to raise one pound (one pint) of water by 1°F (0.56°C). Five ft³, or 5000 BTU of gas, is enough to bring ½ gallon of water to the boil and keep it there for 20 minutes. If you have a volume of bio-gas which is 60% methane, it will have a fuel value of about 600 BTU/ft³, etc.

Table 6.
General Composition of Bio-Gas
Produced From Farm Wastes

| | | |
|------------------|------------------|----------|
| CH ₄ | methane | 54 - 70% |
| CO ₂ | carbon dioxide | 27 - 45% |
| N ₂ | nitrogen | 0.5 - 3% |
| H ₂ | hydrogen | 1 - 10% |
| CO | carbon monoxide | 0.1% |
| O ₂ | oxygen | 0.1% |
| H ₂ S | hydrogen sulfide | trace |

Fuel Value

The fuel value of bio-gas is directly proportional to the amount of methane it contains (the more methane, the more combustible the bio-gas). This is because the gases, other than methane, are either non-combustible, or occur in quantities so small that they are insignificant. Since tables of "Fuel Values of Bio-Gas" may not show how much combustible methane is in the gas, different tables show a wide variety of fuel values for the same kind of gas, depending on the amount of methane in the gas of each individual table.

Table 7
Fuel Value of Bio-Gas and Other Major Fuel Gases

| Fuel gas | Fuel value (BTU/ft ³) |
|--|-----------------------------------|
| Coal (town) gas | 450-500 |
| Bio-gas | 540-700 |
| Methane | 896-1069 |
| Natural gas (methane or propane-based) | 1050-2200 |
| Propane | 2200-2600 |
| Butane | 2900-3400 |

The composition and fuel value of bio-gas from different kinds of organic wastes depend on several things:

1. The temperature at which digestion takes place. This has already been discussed.
2. The nature of the raw material. According to Ram Bux Singh (Ref. 2): "pound for pound, vegetable waste results in the production of 7 times more gas than animal waste." In our experience, pressed plant fluids from succulent plants (cactus), greatly increases the amount of gas produced, but certainly not by a factor of 7. Harold Bate (the chicken manure car) has noted that more gas is produced from manure with a little straw added. But, we are more interested in the production of methane than bio-gas. Laboratory experiments (Ref. 40, 41) have shown that plant materials produce bio-gas with a high proportion of carbon dioxide. So, the extra gas produced by plants may be less valuable for our purposes of *fuel* production.

The general quality of bio-gas can be estimated from the C/N ratio of the raw materials used. (Table 8)

Table 8
Gas Production According to C/N Ratios of Raw Wastes

| | | Methane | CO ₂ | Hydrogen | Nitrogen |
|------------------------------------|---|---------|-----------------|----------|----------|
| C/N Low (high nitrogen) | blood, urine | little | much | little | much |
| C/N High (low nitrogen) | sawdust, straw, sugar and starches such as potatoes, corn, sugar beet wastes | little | much | much | little |
| C/N Balanced (C/N = near 30) | manures, garbage | much | some | little | little |

With good temperature and raw materials, 50 to 70% of the raw materials fed into the digester will be converted to bio-gas.

Amount of Gas From Different Wastes

The actual amount of gas produced from different raw materials is extremely variable depending upon the properties of the raw material, the temperature, the amount of material added regularly, etc. Again, for general rule-of-thumb purposes, the following combinations of wastes from a laboratory experiment can be considered as minimum values: (Table 9)

Table 9
Cubic Feet of Gas Produced by Volatile Solids of Combined Wastes (Ref. 40)

| Material | Proportion | Ft³ Gas Per lb VS Added | CH₄ Content of Gas (%) |
|----------------------------------|-------------------|---|--|
| Chicken Manure | 100% | 5.0 | 59.8 |
| Chicken Manure & Paper Pulp | 31% : 69% | 7.8 | 60.0 |
| Chicken Manure & Newspaper | 50% : 50% | 4.1 | 66.1 |
| Chicken Manure & Grass Clippings | 50% : 50% | 5.9 | 68.1 |
| Steer Manure | 100% | 1.4 | 65.2 |
| Steer Manure & Grass Clippings | 50% : 50% | 4.3 | 51.1 |

Other values for gas production are from *working* digester operations. These are shown as cubic feet of gas produced by the *Total Solids* and are more liberal values than in Table 9.

Table 10
Gas Produced By Total Solids of Wastes

| Manure | Ft³/lb of Dry Matter (TS) |
|---------------------------|---|
| Pig | 6.0 - 8.0 |
| Cow (India) | 3.1 - 4.7 |
| Chicken | 6.0 - 13.2 |
| Conventional Sewage | 6.0 - 9.0 |
| From Ref. 5, 7, 8, 17, 42 | |

As an example, suppose we had 100 chickens which were allowed to forage during the day, but were cooped at night, so that only about half of their manure was collectable. At 0.1 lb/chicken/day this would amount to about 10 lbs of wet or 3.5 lbs dry (Table 4) manure per day. Other conditions being equal, this could be equivalent to about 20-40 ft³ of bio-gas (assuming 60% methane) 12-24 ft³ of methane gas per day.

6. Digesters

Basic Digester Design

Digesters can be designed for batch-feeding or for continuous feeding. With batch digesters a full charge of raw material is placed into the digester which is then sealed off and left to ferment as long as gas is produced. When gas production has ceased, the digester is emptied and refilled with a new batch of raw materials.

Batch digesters have advantages where the availability of raw materials is sporadic or limited to coarse plant wastes (which contain undigestible materials that can be conveniently removed when batch digesters are reloaded). Also, batch digesters require little daily attention. Batch digesters have disadvantages, however, in that a great deal of energy is required to empty and load them; also gas and sludge production tend to be quite sporadic. You can get around this problem by constructing multiple batch digesters connected to the same gas storage. In this way individual digesters can be refilled in staggered sequence to ensure a relatively constant supply of gas. Most early digesters were of the batch type.

With continuous-load digesters, a small quantity of raw material is added to the digester every day or so. In this way the rate of production of both gas and sludge is more or less continuous and reliable. Continuous-load digesters are especially efficient when raw materials consist of a regular supply of easily digestible wastes from nearby sources such as livestock manures, seaweed, river or lake flotsam or algae from production sludge-ponds. The first continuous-load digester seems to have been built in India by Patel in 1950 (Ref. 43).

Continuous-feeding digesters can be of two basic designs: vertical-mixing or displacement (Fig. 13). Vertical-mixing digesters consist of vertical chambers into which raw materials are added. The slurry rises through the digester and overflows at the top. In single-chamber designs the digested or "spent" slurry can be withdrawn directly from effluent pipes. In double-chamber designs the spent slurry, as it overflows the top, flows into a second chamber where digestion continues to a greater degree of completion.

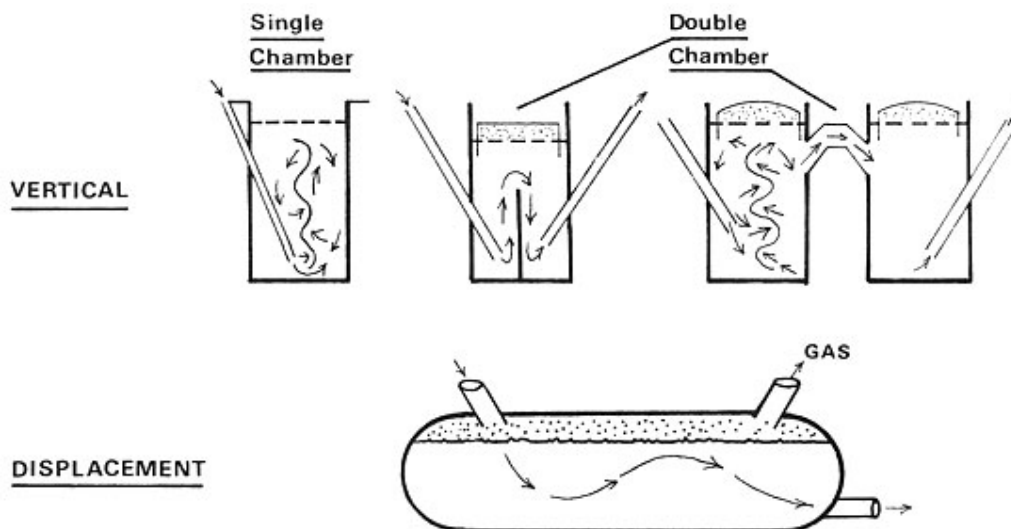

FIG.13 Types of Continuous-Feeding Digesters

Displacement digesters consist of a long cylinder lying parallel to the ground (e.g., inner tubes, oil drums welded end on end, tank cars, etc.). As it is digested the slurry is gradually *displaced* toward the opposite end, passing a point of maximum fermentation on the way.

The displacement digester design seems to have distinct advantages over vertical-mixing designs popularized in India:

1. In vertical-mixing digesters raw material is subject to a vertical pumping motion and often escapes the localized action of digesting bacteria. Slurry introduced at one time can easily be withdrawn soon afterwards as incompletely digested material. In displacement digesters slurry must pass an area of maximum fermentation activity so that all raw materials are effectively digested (much like the intestines of an animal).
2. From a practical point of view, displacement digesters are easier to operate. If digester contents begin to sour for one reason or another, strongly buffered material at the far end can be recirculated efficiently by simply reversing the flow of material along the line of the cylinder. In addition, raw materials can be digested to any desired degree without the need for constructing additional chambers or digesters.
3. The problem of scum accumulation is reduced in displacement digesters. Since scum forms evenly on the surface of the digesting slurry, the larger the surface area, the longer it takes to accumulate to the point where it inhibits digestion. A prone cylinder has a larger surface area than an upright one.
4. Any continuous-load digester will eventually accumulate enough scum and undigested solid particles so that it will have to be cleaned. The periodical washing out of displacement digesters is considerably easier than vertical-mixing digesters.

The first large-scale displacement digester was designed and built by L. John Fry during the late 1950's on his pig farm in South Africa (Ref. 42, 44). Mr. Fry, now a resident of Santa Barbara, is acting consultant for the New Alchemy digester project which is currently focusing attention on the design and utilization of small-scale displacement digesters.

Raw Materials and Digester Design

Plant Wastes: The primary advantage to plant wastes is their availability. Their disadvantage for a small farm operation is that plant wastes can often be put to better use as livestock feed or compost. Also, plants tend to be bulky and to accumulate lignin and other indigestible materials that must be regularly removed from digesters. This severely limits the use of plant wastes in continuous-feeding digesters.

There seem to be three possible ways to take advantage of plant wastes in continuous digesters:

1. Press plant fluids out of succulent plants (e.g., cacti, iceplant, etc.) and digest juices directly, or use them as a diluter for swill.
2. Culture algae for digestion.
3. Digest plants not containing lignin (e.g., seaweed).

Animal Manures: The main advantage to animal manure, with respect to continuous digesters, is that it is easy to collect (with proper design of livestock shelters) and easy to mix as slurry and load into digesters. Successful continuous digesters have been set up using pig manure (Ref. 26, 42, 44), cow dung (Ref. 3, 5, 6) and chicken manure (Ref. 17). The general consensus seems to be that, among animal manures, chicken manure "is easily digested, produces large quantities of gas and makes a fertilizer very high in nitrogen (Ref. 4, 5).

Human Waste: Human waste or "night soil" has long been used as a fertilizer, especially in the Orient (Ref. 46, 47). However, there seems to be little information on using human wastes as raw materials for anaerobic digesters. A few ideas involving outhouses and latrines are described by Gotaas (Ref. 15) in his chapter, *Manure and Night Soil Digesters for Methane Recovery on Farms and in Villages*. It seems possible, also, that digesters could be incorporated into aerobic dry toilet designs of the "Clivus" type (Ref. 48). This may be especially fruitful since the main drawback to using human wastes from flush toilets is the excess water that is carried with it which inhibits digestion. A well-

designed privy digester which paid special attention to the transmission of diseases peculiar to humans would be a real asset to homestead technology. A solution to this problem would be welcomed. One suggestion is a seat with a clip-on plastic bag. When filled it could be dropped into a digester intact. The plastic would have to be a material which would decompose only in the presence of methane bacteria, or liquids generally after so many hours.

Loading Rate, Detention Time and Digester Size

In calculating the size of a continuous-load digester the most important factors are loading rate and detention time.

Loading Rate: Is defined as the amount of raw material (usually pounds of volatile solids) fed to the digester per day per ft³ of digester space. Most municipal sewage plants operate at a loading rate of 0.06-0.15 lb VS/day/ft³. With good conditions, much higher rates are possible (up to 0.4 lbs VS/day/ft³). Again, as with most aspects of digesters, the optimum situation is a compromise. If you load too much raw material into the digester at a time, acids will accumulate and fermentation will stop. The main advantage to a higher loading rate is that by stuffing a lot into a little space, the size (and therefore cost) of the digester can be reduced.

Example

Suppose you had 10 lbs of fresh chicken manure (total manure from about 30 chickens) available for digestion every day: 10 lbs fresh chicken manure = 2.3 volatile solids (Table 4). At a loading rate of 0.2 lbs VS/day/ft³ this would require a digester $2.3/0.2 = 12$ ft³ in volume (about the size of two 50-gallon drums). At a loading rate of 0.1 lb VS/day/ft³, this would double the necessary size of the digester with the same amount of manure.

Detention Time: Is the number of days that a given mass of raw material remains in a digester. Since it is very difficult to load straight manure into a digester it is usually necessary to dilute it with water into a *slurry*. If too much water is added, the mixture will become physically unstable and settle quickly into separate layers within the digester, thus inhibiting good fermentation. The general rule-of-thumb is a slurry about the consistency of cream. The important point here is that as you dilute the raw material you reduce its detention time.

Example

The volume of 10 lbs of fresh chicken manure is about 0.2 ft³. If this is diluted 1:1 with water the volume becomes about 0.4 ft³. With the 12 ft³ digester described above, this would mean a detention period of $12/0.4 = 30$ days. If the manure were diluted more, say 2:1, the volume would be 0.6 ft³ and the detention period would be reduced to $12/0.6 = 20$ days.

Up to a point, then (usually no less than 6% solids), diluting raw materials will produce the same amount of gas in a shorter period of time.

These relationships between loading rate, detention time and digester size reveal themselves more clearly after direct experience with continuous-load digesters. However, generalities can be of some use in the beginning.

Heating Digesters

For the most efficient operation, especially in temperate climates, digesters should be supplied with an external supply of heat to keep them around 95°F (35°C); there are several ways to do this. Methods which heat the outside of digesters (e.g., compost piles, light bulbs, and water jackets) could be more effectively used as insulation since much of their heat dissipates to the surroundings. (Since digesters should be constantly warmed rather than sporadically heated, compost "blankets" are not very practical unless you coordinate a regular program of composting with digestion.) Similarly, green houses built over digesters tend to overheat the digester during the day and cool it down at night.

The most effective method of keeping digesters warm is to circulate heated water through pipes or coils placed *within* the digester. The water can be heated by solar collectors or by water boilers heated with methane.

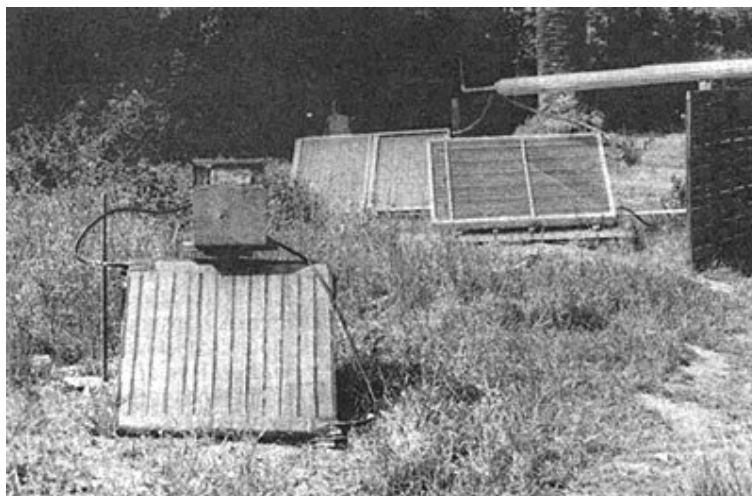

Fig. 14 Solar water heaters (built by Irving Thomas of Santa Barbara)

Gas-heated water boilers are a good idea since they allow the digestion process to feed back on itself, thus increasing efficiency. One practical gas-heater design we have used is shown in Fig. 5. The thermostat in the water boiler is set at 140°F (60°C) because slurry will cake on surfaces (e.g., the water coils) warmer than this. The digester thermostat is set at the optimum 95°F (35°C). Until the digester begins producing methane, propane can be used as a fuel source for the water boiler.

For optimum heat exchange within the digester, a ratio of 1 ft² coil area per 100 ft³ of digester volume is recommended (Ref. 8).

Insulating Digesters

A word of caution if you insulate your digester. Methane is not only combustible but highly explosive when it makes up more than 9% of the surrounding air in confined spaces. If you use synthetic insulation, avoid porous materials such as spun glass which can trap gas mixtures. It's easy to scrounge styrofoam sheets since they are so commonly used as packing material and regularly discarded. Styrofoam is one of the best insulating materials, although it is slightly flammable.

7. Using Gas

Properties of Methane

| | |
|--|--------------|
| Specific Gravity (air = 1.0) | 0.55 |
| Dry Weight, lb/ft ³ | 0.04 (gas) |
| Liquid Weight, lb/gal | 3.5 (liquid) |
| Fuel Value, BTU/ft ³ | 950-1050 |
| Air for Combustion, ft ³ /ft ³ | 9.5 |
| Flammability in Air, % Methane | 5-14 |

Uses of Methane

General: Methane can of course be used in any appliance or utility that uses natural gas. The natural gas requirements of an average person with a U.S. standard of living is about 60 ft³/day. This is equivalent to 10 lbs of chicken or pig manure per day (7 pigs and 100 chickens) or 20 lbs of horse manure (about 2 horses). Other uses and methane requirements are listed in Table 11.

Table 11
Uses for Methane

| Use | Ft ³ | Rate |
|------------------|-----------------|---|
| Lighting | 2.5 | per mantle per hour |
| Cooking | 8 - 16 | per hour per 2-4" burner |
| | 12 - 15 | per person per day |
| Incubator | 0.5 - 0.7 | ft ³ per hour per ft ³ incubator |
| Gas Refrigerator | 1.2 | ft ³ per hour per ft ³ refrigerator |
| Gasoline Engine* | | |
| CH ₄ | 11 | per brake horsepower per hour |
| Bio-Gas | 16 | per brake horsepower per hour |
| For Gasoline | | |
| CH ₄ | 135 - 160 | per gallon |
| Bio-Gas | 180 - 250 | per gallon |
| For Diesel Oil | | |
| CH ₄ | 150 - 188 | per gallon |
| Bio-Gas | 200 - 278 | per gallon |

*25% efficiency

Heat Engines: Methane, the lightest organic gas, has two fundamental drawbacks to its use in heat engines: it has a relatively low fuel value (Table 7), and it takes nearly 5,000 psi to liquefy it for easy storage. (87.7 ft³ methane gas = 1 gallon of liquid methane or 1 ft³ methane gas = 9 tablespoons liquid methane.) So a great deal of storage is required of methane for a given amount of work. For comparison, propane liquefies around 250 psi. Consider the following example where methane is compressed to just 1,000 psi in a small bottle and used to power a rototiller of 6 brake horsepower:

Example

1 horsepower hr = 2540 BTU

Fuel value of methane = 950 BTU/ft³

TV (tank vol.) = 2' x 6" cylinder = 678 in³ = 0.39 ft³

TP (tank pressure) = 1000 psi = 68 atmos EV (effective vol.) = (TP) (TV) = 26.7 ft³
= 25,300 BTU

hp = brake horsepower of engine

hr = hours of running

x = heat value of gas (BTU/ ft³)

y = efficiency of engine (25% for conventional gas engines)

Methane Gas Consumption (G) (ft³)

of general heat engine:

$$G = \frac{(hp) (2540) (hr)}{(x) (y)}$$

of gasoline engine on methane:

$$G = \frac{(hp) (2540) (hr)}{(0.25) (9.50)} = (10.7 \text{ ft}^3/\text{hp-hr})$$

for a 6 hp rototiller:

$$G = (hp)(hr)(10.7 \text{ units}) = (64.2 \text{ ft}^3/\text{hr})(hr)$$

Operating Time (OT)

$$OT = \frac{EV}{G} = 0.414 \text{ hr} = 25 \text{ minutes/tank}$$

Useful Work Supplied = 2.5 hp hr = 6,350 BTU = (25,300 BTU/tank) (25% eff)

At 25% compressor efficiency it would take 0.52 hp-hr to compress the gas (1320 BTU). In other words, it would take 1320 BTU to compress 25,300 BTU worth of gas that provides 6,350 BTU worth of work. Clearly the system is not very "efficient" in the sense that 21% of the resulting work energy is needed for compression while 75% of the available energy is lost as heat.

Methane has been used in tractors (Ref. 49, 50) and automobiles (Ref. 51). The gas bottles carried by such vehicles are often about 5 ft long by 9 in diameter (1.9 ft³) charged to 2800 psi so that about 420 ft³ of methane is carried (about 3-1/2 gal. gasoline). However, it seems that the most efficient use of methane would be in *stationary* heat engines located near the digester (e.g., compressors and generators). There are two reasons for this:

1. The engine's waste heat can be recirculated in digester coils instead of dissipating in the open.
2. Gas can be used directly as it is produced, without the need of compressors. For example, bio-gas produced from pig manure was used at ordinary pressures by John Fry to power a Crossley Diesel engine. The diesel ran an electric generator and the waste heat was recirculated directly back into the digesters (Ref. 52). It is likely that bio-gas produced from mixed wastes would have to be "scrubbed" of corrosive hydrogen sulfide (by passing through iron filings), and possibly CO₂ (by passing through lime water).

Efficiency of Digestion

The efficiency of anaerobic digestion can be estimated by comparing the energy available in a specific amount of raw material to the energy of the methane produced from that material. Four such estimates are given below. (Fig. 15)

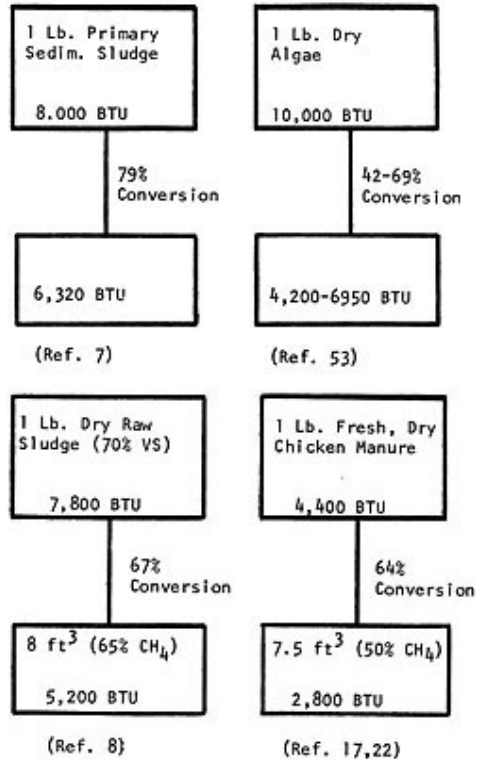

FIG.15 Efficiency of Methane Production from Different Materials

It seems fair to conclude that anaerobic digestion is about 60-70% "efficient" in converting organic waste to methane. However, it would probably be more accurate to call this a *conversion rate* since, like all biological processes, a great deal of energy is required to *maintain* the system, and most of this extra energy is not included in the conversion. For example, consider how much energy is needed just to keep a digester warm in a general temperate climate.

Example

Direct-heating hot water boilers have an efficiency of about 70%. Gas engines have a power efficiency of 20-25% and a water heating efficiency of about 50% (Ref. 7). As hot water heaters, then, heat engines are about as efficient as water boilers. In either case about 20-30% of the gas energy derived from digestion must be put back into the system to heat digesters. Without even considering the energy needed to collect raw materials or load and clean the digesters, the conversion efficiency of digestion should be closer to 50%.

8. Using Sludge

Sludge as a Fertilizer

Most solids not converted into methane settle out in the digester as a liquid *sludge*. Although varying with the raw materials used and the conditions of digestion, this sludge contains many elements essential to plant life: nitrogen, phosphorus, potassium plus small amounts of metallic salts (trace elements) indispensable for plant growth such as boron, calcium, copper, iron, magnesium, sulfur, zinc, etc.

Nitrogen is considered especially important because of its vital role in plant nutrition and growth. Digested sludge contains nitrogen mainly in the form of ammonium (NH₄), whereas nitrogen in aerobic organic wastes (activated sludge, compost) is mostly in oxidized forms (nitrates, nitrites). Increasing evidence suggests that for many land and water plants ammonium may be more valuable as a nitrogen source than oxidized nitrogen; in the soil it is much less apt to leach away and more apt to become fixed to exchange particles (clay and humus). Likewise, important water algae appear to be able to utilize ammonium easier than nitrates (Ref. 54). Generally speaking, this is a reversal from the earlier belief by fertilizer scientists that oxidized nitrogen always presented the most available form of nitrogen for plants. Because of these things, it has been suggested that liquid digested sludge produces an increase of nitrogen comparable with those of inorganic fertilizers in equivalent amounts (Ref. 55).

Most of the information showing the poor fertilizer value of sludge has been based on *municipal* sewage sludge. It is a bad measure of the fertilizer value of digested sludge in general. (Municipal treatment flushes away all the fertilizer-rich liquid effluent.) In one case (Ref. 7) digested sewage sludge was found to contain only about ½ the amount of nitrogen in fresh sewage, whereas elsewhere (Ref. 26) digested pig manure was found to be 1.4 times richer in nitrogen content than raw pig manure. Similar results have been found with digested chicken manure.

Sludge from your digester can be recycled in a wide variety of ways, both on land and in water and pond cultures. The possibilities are many and only brief descriptions of potentials can be given here.

Table 12
Nitrogen Fertilizer Value of Various Sludges
and Finished Compost

| | N (% dry wt.) | Reference |
|-------------------------------|----------------------|------------------|
| Raw Sewage | 1.0-3.5 | 56 |
| DIGESTED SLUDGE | | |
| 10 municipalities | 1.8-3.1 | 9 |
| 12 Ohio municipalities | 0.9-3.0 | 9 |
| 51 samples, 21 cities | 1.8-2.3 | 10,57 |
| General average | 2.0 | 9 |
| General average | 1.0-4.0 | 56 |
| ACTIVATED SLUDGE | | |
| 5 municipalities | 4.3-6.4 | 9 |
| General average | 4.0-6.0 | 9 |
| General average | 4.0-7.0 | 56 |
| DIGESTED MANURE-SLUDGE | | |
| Hog | 6.1-9.1 | 26 |
| Chicken | 5.3-9.0 | 23 |
| Cow | 2.7-4.9 | 23 |
| FINISHED COMPOST | | |
| Municipal | 0.4-1.6 | 58 |
| Garbage | 0.4-4.0 | 58 |
| Garden | 1.4-3.5 | 58 |

Sludge Gardening and Farming

The application of digested sludge to crops serves a double purpose since it is both a soil conditioner and fertilizer. The sludge humus, besides furnishing plant foods, benefits the soil by increasing the water-holding capacity and improving its structure. In some preliminary experiments with garden and house plants we have obtained astounding results with the use of sludge from our chicken manure digester. However, there are some things to consider first:

1. *Fresh* digested sludge, especially from manures, contains high amounts of ammonia, and in this state may act like a chemical fertilizer by force-feeding large amounts of nitrogen into the plant and increasing the accumulation of toxic nitrogen compounds (Ref. 59, 60). There is no direct evidence for this, but the possibility exists. For this reason it is probably best to let your sludge "age" for a few weeks in an open area (oil drums, plastic swimming pools, etc.), or in a closed container for a few months before using it on crops. The fresher it is the more you should dilute it with water before application.
2. The continued use of digested sludge in any one area tends to make soils acidic. You should probably add a little dolomite or limestone at regular intervals to your sludge plots, allowing at least 2 weeks interval between applications to avoid excess nitrogen loss. Unfortunately, limestone tends to evaporate ammonia so you may experience a temporary nitrogen loss when you apply it on your sludge plots.
3. Unlike digested municipal sludge, sludge from farm wastes does not contain large amounts of heavy metals or salts so there is little danger of applying it too heavily over a period of time. However, you should pay attention to the structure of your soil. If it contains a lot of clay, the sludge will tend to accumulate and possibly present problems in the root area of your plants. In general, keep close tabs on your sludge plots in the beginning until you become familiar with its behavior in your own particular soil.

Sludge-Pond Cultures

There are at least three general ways to integrate pond cultures with organic digesters: hydroponic crops, sludge-algae-fish and sludge-algae-methane systems. All have their advantages depending on local needs and resources.

Sludge Hydroponics: Hydroponics is the process of growing plants directly in nutrient solution rather than soil. The nutrients may consist of soluble salts (i.e., chemical fertilizers) or liquid organic wastes like digested sludge and effluent. Plants grown hydroponically in sludge-enriched solutions can serve a variety of purposes for organic digester operations:

1. They can do away with the cost and energy of transporting liquid fertilizer to crop lands since they can be grown conveniently near to digesters.
2. They tend to be more productive than conventional soil crops, and thus can serve as a high-yield source of fodder, compost, mulch or silage.
3. They can serve as convenient high-yield sources of raw materials for the digester itself.

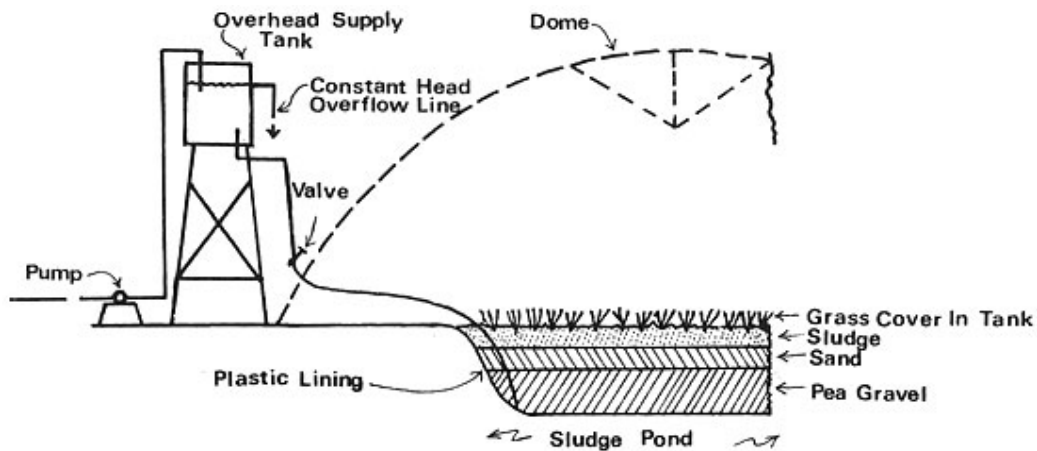

Fig. 16 Hydroponic sludge culture of pasture grasses

Information about the use of sludge to fertilize water plants comes from projects to treat waste water in run-off areas or "sewage lagoons" (Ref. 61, 62). Some plants, for example water hyacinth, *Ipomoea repens* (water spinach, swamp morning-glory) and some cool season pasture grasses such as rye, fescue and canary grass, have the ability to grow well in waste water and to take up great amounts of nutrients efficiently, thus helping to control polluted waters. These crops have the added advantage that they are easy to harvest for livestock feed, thus giving an efficient method of converting sludge nutrients into animal protein.

Usually, the plants are grown in shallow ponds filled with a diluted sludge solution. The process consists of slowly adding sludge under a gravel bed lining the pond and covered with a layer of fine sand. Over the sand, plants are sprouted in containers floating on the effluent that percolates up through the gravel and sand layers. After sprouting the grasses then root and anchor in the sand and gravel.

Sludge-Algae-Fish: The essence of the sludge-algae-fish or "aquaculture" system consists of placing sludge into ponds and stimulating the growth of algae. The algae are then used as feed for small invertebrates or fish growing in the pond. The idea is modeled after Oriental aquaculture systems.

During the last two years, under the direction of Bill McLarney, New Alchemy has established preliminary models for experimental fish cultures (Tilapia). A general description of small-scale fish farming methods using organic fertilizers and invertebrate fish food cultures has been presented elsewhere (Ref. 63--65).

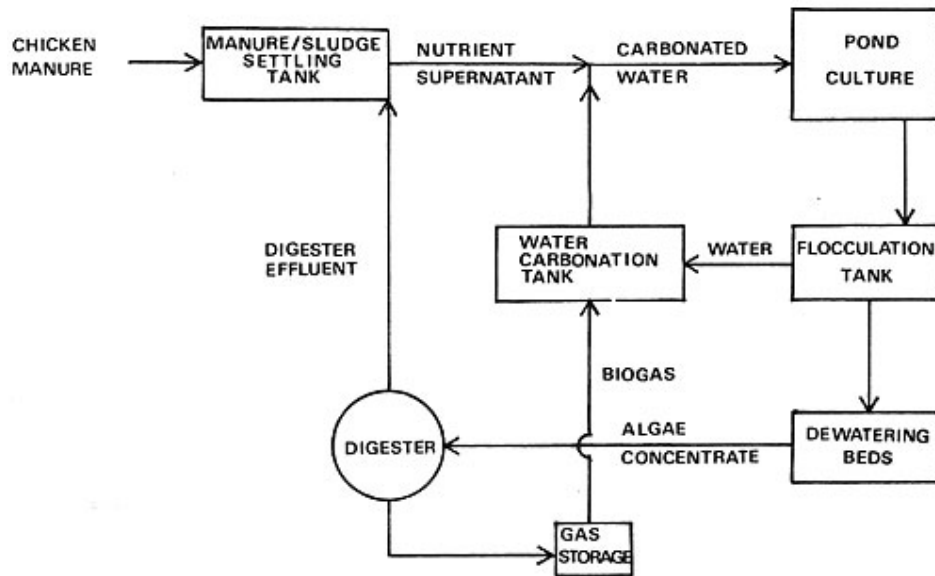
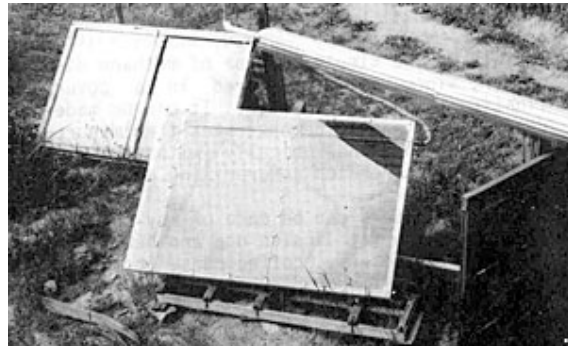
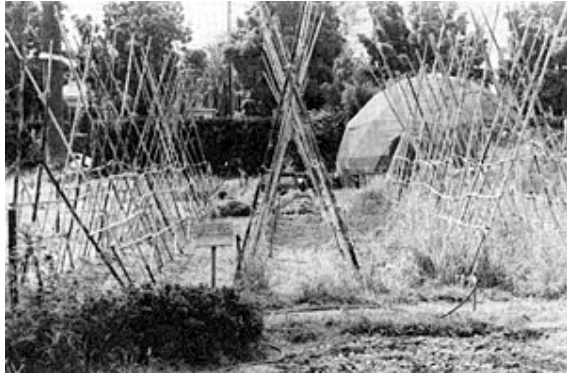

FIG.17 Flow Diagram of Sludge-Algae-Methane Conversion System

Sludge-Algae-Methane: In the Sludge-algae-methane system green algae is grown in diluted sludge, then harvested, dried and digested to produce methane for power and sludge for recycling. This procedure of transforming solar energy and sludge nutrients into the chemical energy of methane is potentially a very efficient and rapid biological process: (1) It is a closed nutritional system and (2) the rate of turnover is extremely high; organic matter is decomposed relatively quickly by anaerobic bacteria in the pond while it is most rapidly made by green algae. The complete sludge-algae-methane system involves a series of processes. The principle features of the system are integration of the algae culture with the gas in such a manner that nutrients and water are recycled from one process to the other (Fig. 17). Most of the information concerning this system has been developed by researchers at Berkeley in a manner that has real potential for the homestead or small farm (Ref. 53, 66-69). Space does not permit even a brief discussion of the considerations: (1) cultivated algae, (2) pond design and operation, (3) harvesting of algae, (4) digestion of algae, (5) efficiency and yield.



(From upper left, clockwise): Chinese bamboo trellis with lathe house in the background; drum digester heater; drum digesters; solar water heater.

9. Building a Sump Digester



Fig. 18 Original sump digester. Upper drums have been forced up by methane

This is the simplest type of methane digester, since gas is stored in a cover floating over the digester. It can be made very cheaply and it demonstrates that manure *does* decompose anaerobically (without air), and that it generates a surprising amount of gas.

Sump digesters can be made of any two cylinders where one fits inside the other, such as drums, buckets, coffee cans, etc. The sump digester described below is made of a 30 gallon drum fitted into a 50 gallon drum.

Making Starter Brew

Before starting, read the Safety Precautions *Warning* (#11 below).

One of the first steps in the construction of any sized unit is the brewing up of a batch of starter material. (Unless you're lucky enough to have an operating digester in your area, from which you can get some bacteria.)

It takes weeks and even months to cultivate the strain of bacteria that functions best on the manure being used locally. Once you have your starter going, though, like a sourdough bread or yogurt culture, you can have it for a long time.

Starter brew can be generated in a 1 or 5 gallon glass bottle. Care must be taken to fill the bottle only about $\frac{1}{4}$ full with either (a) active supernatant from a local sewage works or (b) the runoff from the low point on the land of any intensive stock farm in your district. Fill $\frac{1}{4}$ more with fresh dung. Leave the other 50% of the bottle for fresh manure additions at weekly intervals. Never fill to near the screw cap, since foaming could block off the opening and burst the bottle. Of course, the screw cap must be left loose to keep the bottle from exploding, except when agitating the bottle. It is a peculiarity of methane brews that a slight agitation when adding material is beneficial, but that continuous agitation has an adverse effect.

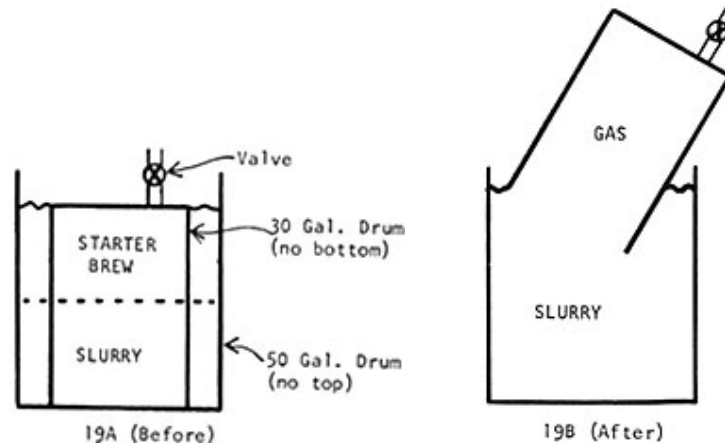

Fig. 19A & B: Sump digester before and after methane Production

- 1) Get two metal drums, one 30 gallon with an outlet on top and one 50 gallon. (Fig. 19a.)
- 2) Remove the top of the 50 gallon drum and the bottom of the 30 gallon drum.
- 3) Fit a valve into the small outlet in the top of the 30 gallon drum. Solder or weld it securely. This will be the gas outlet.
- 4) Firmly tape a hose to the outlet pipe with polyvinyl chloride tape (adhesive on one side only).
- 5) The hose can be led to an inner tube to be filled with gas for storage (10 - Building an Inner Tube Digester, #10 Inner Tube Storage); or led directly to a simple burner (10 - Building an Inner Tube Digester, #11 Burner).
- 6) The 50 gallon drum is ready to be filled. It should be filled only to the *height of the 30 gallon drum* with a mixture of half slurry and half starter "brew," Fig. 19a.
- 7) Make a slurry the thickness of cream by mixing fresh, raw manure with warm or hot water, 90-95°F (32-35°C).
- 8) To this, add an equal amount of starter "brew."
- 9) With the valve *open*, sink the 30 gallon drum all the way down into the slurry and starter mixture (Fig. 19). This *must* exclude all the air from the 30 gallon drum. Then *close* the valve.
- 10) In cool climates, active compost can be packed around the outer drum, to maintain a steady temperature of between 80° and 95°F (27-35°C). After about three weeks, gas should begin to generate. The smaller drum will fill slowly with gas and rise above the surface of the slurry (Fig. 18, 19b).
- 11) **Safety Precautions:** *A Note of Warning.* When the small drum rises the first time, do not attempt to burn the gas. Rather, let it escape to the atmosphere, push the 30 gallon gas holder completely down into the slurry again, shut off the valve and allow it to rise a second time. This is to insure that no air is mixed with the gas. A gas and air mixture is highly explosive between the range of 1 part in 4, to 1 in 14. Even outside this range it could be dangerous. Also, the first gas yield probably will not light anyway due to a high proportion of carbon dioxide when fermentation first starts. When burning the gas, open the valve only slightly, press down lightly on the 30 gallon drum to create a positive pressure on the gas. Close the valve before releasing the pressure. In rare cases there occurs an abundance of gray foamy bubbles at about the time when fermentation starts. If this happens leave the digester alone for a few days. Do not feed any raw material. If the digester is heated, reduce the heat.

12) Periodic supplies of fresh raw material should be "fed" in to keep the digestion going. This can vary from daily to once every three months depending on the requirements of the user and the digester design. To feed this digester it is necessary to remove the 30 gallon drum, take out about 5 gallons of material and replace it with fresh slurry. Again press down the small drum to exclude air.

Sump designs are particularly good units to learn from since they are so easy to build and maintain.

10. Building an Inner Tube Digester

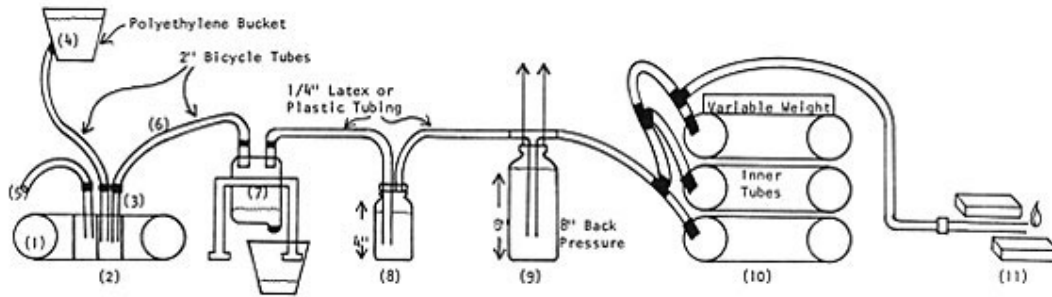

- | | |
|------------------------------------|-------------------------|
| (1) Main Chamber of Digester | (7) Scum Collector |
| (2) The Plastic Cylinder | (8) Gas Yield Indicator |
| (3) Inlet, Gas, and Effluent Pipes | (9) Pressure Releaser |
| (4) Inlet Feeding Bucket | (10) Inner Tube Storage |
| (5) The Effluent Outlet | (11) Burner |
| (6) The Gas and Scum Outlet | |

FIG.20 DIAGRAM OF INNER TUBE DIGESTER



Fig. 21 Attachment of pipes and buckets

I hope that in these times of ever increasing pressures in the energy crisis, that this inner tube unit will be made available to the millions on millions of people around the world who could benefit from it. To those on the land eking out an existence, I dedicate this unit. As a morsel of technology, it might well benefit them more than a man standing on the moon.

-- L. John Fry

Inner Tube Digester Parts List

1. Main Chamber of the Digester
2. The Plastic Insert
 - A. The Plastic Cylinder
 - B. The Inlet, Gas and Effluent Pipes
 - Inlet Pipe
 - Gas Outlet Pipe
 - Effluent Pipe
3. Attaching the Cylinder to the Inner Tube
4. Inlet Fittings and Attachment of the Slurry (Feeding) Bucket
 - Attachment of Bucket
5. Fitting the Effluent Pipe
6. Fitting the Gas Outlet
7. The Scum Collector
 - Gas Outlet Continuation
8. Gas Yield Indicator
9. Pressure Release Bottle
10. Inner Tube Storage
11. Burner
12. Temperature
13. The Bacterial Brew
14. Feeding
15. Removing Scum and Effluent
 - A. Scum
 - B. Effluent
16. Safety Precautions
 - Precautions In Gas Usage
17. Lighting the Flame
18. pH

The following inner tube unit was made at a cost of about \$20. If it could be produced in quantity, the cost might be as low as \$2 using cheaper material.

The unit has no working parts and should last the normal life of the materials used.

This inner tube digester has been tested out in Santa Barbara for over 18 months, during which all the "bugs" have been eliminated. It is a thoroughly reliable device.

NOTE: Read "Safety Precautions" (#16 below) and "Starting The Bacterial Brew" (Sump Digester) before beginning construction.

Inner Tube Digester Parts List

1. Truck or tractor sized inner tube
2. Plexiglass (1/8" thick) 7" x 28" (or circumference of inner tube). Plexiglass 10" x 10".
3. Methyl chloride liquid (hobby shop)
4. Plexiglass tubes (2" x 3')
5. 2 x 2-inch diameter bicycle inner tubes
6. Polyvinylchloride (PVC) tape
7. 3 x 5-gallon polyethylene buckets
8. 5-gallon container -- metal or plastic -- for scum collector
9. Epoxy resin
10. Rubber sealing compound
11. Rubber cement
12. Wire
13. Pipe adapter (kind that goes from steel to plastic)

14. ¼" rubber or latex hose
15. 1 gallon jug with cork with two ¼-inch holes
16. Bottle
17. T pieces
18. Truck inner tubes (storage)
19. Screw type pinch clamp.

1. Main Chamber of the Digester

This consists of a discarded truck-sized (or better still, a tractor-sized) inner tube.

1. Test carefully for leaks. (Bear in mind that every part going into the digester should be carefully tested for leaks. *Any gas escaping, out of even a pinhole, is a potential cause of explosion.*)
2. Patch over, if necessary. If there is a large gash or hole, cut that portion completely out of the tube.
3. Make a clean cut at right angles to the long circumference of the tube. This is where the plastic cylinder will be inserted (Fig. 21).
4. Thoroughly wash and dry the inside of the tube. The inner tube is now ready for the plastic insert.



Fig. 22: Preparation of the inner tube

2. The Plastic Insert

A. The Plastic Cylinder

1. Heat a 1/8" thick x 7" wide x about 28" long (length should be the circumference around the opening of the inner tube, picture 2) piece of plexiglass in a 400°F (200°C) oven, until it will bend (about 5 minutes).
2. Bend it around a saucepan or other cylindrical object which has the same circumference as your inner tube. Make the ends of the plexiglass meet to form a cylinder.
3. Glue the ends together by generously applying methyl-chloride glue. The glue can be made by melting some acrylic scraps in methyl-chloride.

4. Cut a round flat piece of plexiglass to fit inside the cylinder, and glue this plate with methyl-chloride glue midway inside the cylinder (Fig. 23, 24). This will make a central dividing wall to keep the manure from circling around and around the inner tube.
5. The lip. Heat a ¼" x 29" strip in a 400°F (200°C) oven for 5 or 10 minutes. Wrap around the outside edge of the plastic cylinder to form a rim. (This will help keep the inner tube from sliding off the cylinder.) Hold the hot plastic strip in place with clothespins until cold. Eye-drop straight methyl-chloride between the two surfaces. Keep the clothespins on until surfaces are securely stuck together. Repeat for other cylinder edge.

B. The Inlet, Gas and Effluent Pipes

These are constructed of 2" diameter, heavy-duty plexiglass tubes. The inlet pipe will be inserted on one side of the central dividing wall of the cylinder and the gas and effluent tubes on the other side, as follows (Fig. 23, 24).

1. Make three 2" diameter holes, one on one side of the center divider, two on the other side (Fig. 23, 24). Exact placement is not important, but must be so close to the baffle as to touch it and in the general area shown in Fig. 24. Apply a little glue at the touching point for added strength. Allow at least 1" between the tubes to the lip of the cylinder (Fig. 23). We made the holes by burning around the outside edge of the hole with a simple soldering iron. A FRET saw would do a better job.
- 2.

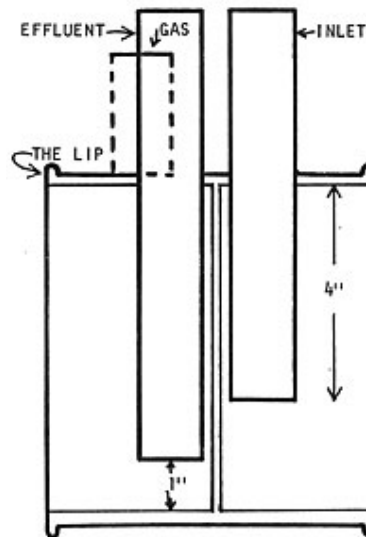

Fig. 23 Cross section of the plastic insert

Inlet Pipe:

2. Ream out the inlet pipe hole to allow the inlet pipe to go in at a slight angle (Fig. 24). This angle helps the mixing in the inner tube, by tending to make the incoming raw slurry revolve in the tube.
3. Insert the pipe in at an angle, 4" down into the cylinder (Fig. 23). The distance the pipe sticks out the top of the cylinder is not important.
4. To eliminate leaks, seal the seam around the pipe and hole with: (1) a layer of melted plexiglass and methyl-chloride and then (2) a layer of rubber sealing compound available in hardware stores.

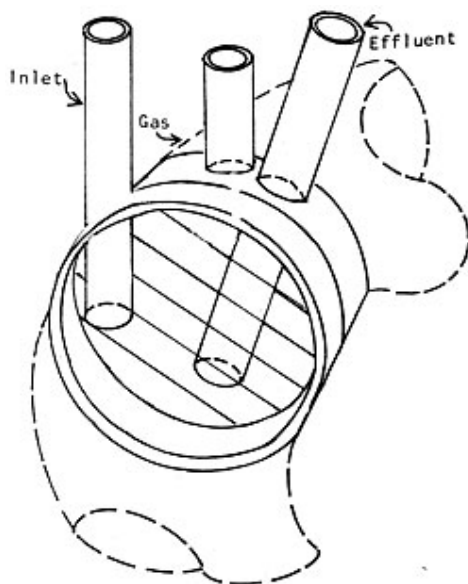

FIG.24 Placement of Pipes
In Plastic Cylinder (Note
Angle of Pipes)

Gas Outlet Pipe:

5. This pipe is glued to the top of the cylinder (Fig. 23). Again, the length of the pipe sticking out the top of the cylinder should be about 6 inches. Length in Fig. 23 is about right.

6. Seal as above.

Effluent Pipe:

7. Insert the effluent pipe straight down into the cylinder to *1" from the bottom*. (Fig. 23.) Again 6" above top.

8. Seal seams as above. Where the inlet and outlet pipes touch the center baffle, apply a little glue to give added strength to them, as mentioned above.



Fig. 25 Placing the cylinder in the inner tube

3. Attaching the Cylinder to the Inner Tube

1. Paint the inside of each open end of the inner tube to a depth of about 2" with any kind of rubber cement (Fig. 22).
2. Insert the cylinder into the inner tube, past the lip, to a distance far enough to ensure a good seal (Fig. 25).
3. Tape in place with polyvinylchloride (PVC) tape to hold cylinder and inner tube securely in position (Fig. 26).
4. Then wind wire twice around on the tape. Twist the ends of the wire to make a very tight hold. (The wire and the tape are never removed.)

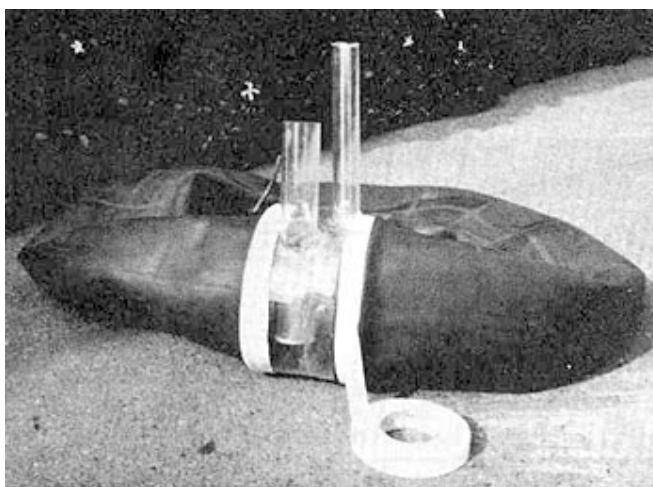

Fig. 26 Fastening tube to plexiglass cylinder

4. Inlet Fittings and Attachment of the Slurry (Feeding) Bucket

1. Cut a 2" diameter balloon bicycle inner tube to a length of about 3', after checking for leaks.
2. Place it on the inlet pipe (Fig. 21).
3. Tape with PVC tape which is adhesive on one side only, by stretching the tape very tightly around the pipe and inner tube. Make sure it is taped firmly.

Attachment of Bucket:

4. Burn a hole in the polyethylene slurry bucket, *1" from the bottom of the bucket.* (Fig. 20 and 22.) When the hose is attached to this hole *off* the bottom, it will allow sand, feathers and other heavy indigestible material to settle to the bottom of the bucket and be left behind when feeding the slurry to the digester.
5. Attach an adapter in the hole of the type used to go between steel and plastic pipe.
6. Attach a length of 2" bicycle inner tube to the adapter in the slurry bucket with PVC tape. The tube should be long enough to allow the bucket to be held up for gravity feeding the slurry into the digester (Fig. 20).

5. Fitting the Effluent Pipe

1. Simply tape another length of 2" bicycle inner tube to the effluent pipe (Fig. 21) .
2. Hang the tube in a bucket.

6. Fitting the Gas Outlet

1. Attach a 2' or 3' length of the 2" bicycle tire tubing to the gas outlet with PVC tape.
2. Lead it to the scum collector.

7. The Scum Collector

If you remember, scum is a mixture of (1) floating material (bedding, straw, feathers, etc.) and (2) liquid interspersed with (3) gas bubbles. Scum rises up with the gas out of the gas outlet. Scum formation is a major problem in any sized digester. On this scale, though, it is simple to eliminate.

1. Select a metal or firm polyethylene container with at least a 2" wide filler cap. We used a 5 gallon, plastic milk container. It is much easier to attach the pipes to a metal container, though.
2. Turn the container upside-down (filler cap underneath) and make a 2" hole in the top. Solder or weld a short length of 2" wide metal pipe to the top (this was the bottom of the container originally) (Fig. 27).
3. Firmly tape the inner tube coming from the gas outlet to the short length of pipe. Scum will be forced through the gas outlet, through the cycle tube and drop in the container. Gas will continue on its way to storage via:

Gas Outlet Continuation:

4. Solder or weld a second pipe at another point on the top of the container. The hole should be 1/4" in diameter (Fig. 27).
5. Tape a length of 1/4" rubber or latex hose to the 1/4" pipe. This will go to the gas yield indicator bottle (Fig. 20).

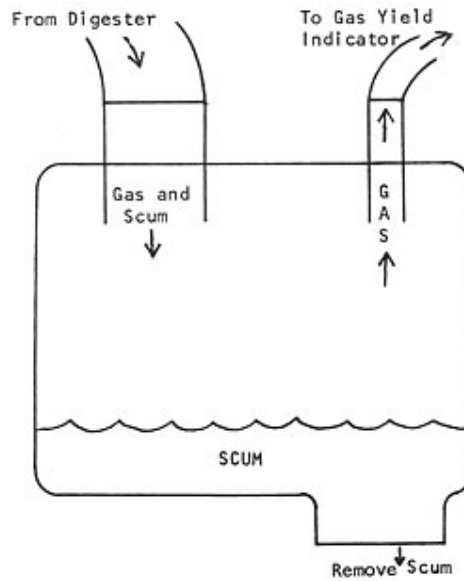

Fig. 27 Scum collector

8. Gas Yield Indicator

This is a jug of water, through which the gas from the digester bubbles. It is a nice way to see that your digester is producing gas. (Also, if the water is changed frequently, it will filter out some of the carbon dioxide in the gas.)

1. Take a 1 gallon jug and place a cork with two $\frac{1}{4}$ " holes in the bottle's mouth (Fig. 28).
2. Place between the scum accumulator and pressure release bottle (Fig. 20).
3. Fill the jug with about 6" of water.
4. Run the hose from the scum accumulator, through one cork hole and to 4" below the level of water in the bottle.
5. Run another piece of $\frac{1}{4}$ " rubber or latex tubing out of the other cork hole, to the pressure release (overflow) bottle.

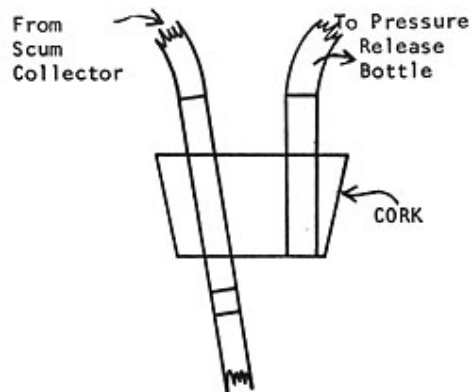

FIG.28 Gas Yield Indicator

9. Pressure Release Bottle

This bottle is placed between the gas yield indicator and inner tube storage (Fig. 20). It allows the release of extra pressure in the inner tube storage, or overflow of gas to escape through the water in the bottle, rise to the atmosphere, and disperse harmlessly.

1. A 12" or so deep bottle is fitted with a "T" piece (Fig. 29).
2. The tubing from the gas yield indicator is attached to one arm of the "T" and tubing to storage is attached to the other arm.
3. Plastic tubing is attached to the leg of the "T" piece and immersed in 8" of water.
4. In the event that the gas pressure is more than 8" water gauge, the gas will escape through the water, to the atmosphere.

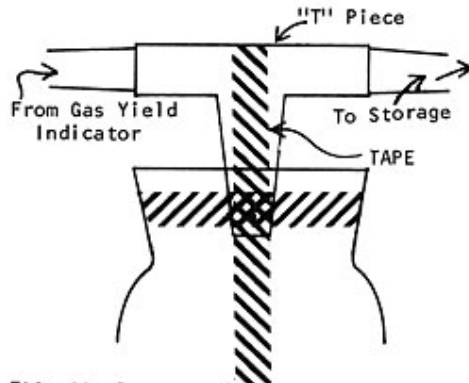

FIG. 29 Pressure Release

10. Inner Tube Storage

1. Gas can be stored in one or a number of truck inner tubes, stacked on each other and interconnected with "T" pieces (Fig. 20). Check for leaks and patch if necessary.
2. Weights, such as pieces of lumber, are placed on the topmost tube to create pressure.

11. Burner

The gas produced by this digester is about 700 BTU per cubic foot at sea level (585 BTU at 6000 ft. altitude). The average daily production of this system is 5 cubic feet; enough to bring ½ gallon of water to the boil and keep it there 20 minutes. THIS IS ENOUGH TO COOK A MEAL.

1. The simplest burner can be a piece of ½" metal pipe 18" to 2' long.
2. Place on a reducer to ¼" to fit the tubing from storage.
3. Place some sort of on/off clamp on the tubing, plus a pinch screw to regulate the amount of gas (Fig. 30).
4. The 1/2" pipe is laid between 2 bricks and a third brick is placed on the pipe to hold it in position.

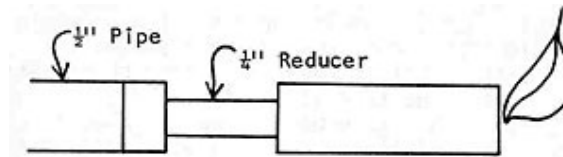

FIG. 30 Simple Burner

12. Temperature

Methane bacteria only work their best when kept warm. The best temperature is 95°F (35°C). Without artificial heating the only areas in which a digester will function is in or near the tropics. Thus, without supplemental heat, this unit is limited to the tropics. Alternatively, if placed in an insulated box and heated by two 100 watt light bulbs in *series* (this takes very little electricity and the bulbs last a long time), with a thermostat set to 95°F in the circuit, it can be operated almost anywhere.

13. The Bacterial Brew

Add to Manure Contents (See **9 Building a Sump Digester -- Making Starter Brew**)

14. Feeding

1. The daily routine consists of collecting three 1-pound coffee cans full of dry chicken manure. (Almost any kind of manure is suitable, but to avoid excessive scum formation, a finer texture manure is better. Chicken or pig manure is probably the most suitable.)
2. Stir in the slurry bucket with $\frac{3}{4}$ gallon of water or urine to form a slurry. If you can use urine instead of water, it will aid fermentation and make the effluent a better fertilizer after digestion.
3. Now raise the bucket high so that the slurry will gravity feed into the digester. It will mix with yesterday's load, which by now has been "seeded" with active, hungry bacteria. The inlet pipe (set at an angle) helps the mixing, by tending to make the incoming raw slurry revolve in the inner tube.
4. Dispose of the feathers, fiber, sand, etc., left in the bottom of the bucket.

The action inside the digester is the same on any scale. The raw material, heavily seeded, tends to skulk along the floor of the digester but as the bacteria work on it, gas is formed and lightens it in relation to surrounding material. Vertical motion begins, throwing up chunks of dung and bubbles of gas. Each load displaces the last, around the circuit round the inner tube. At some stage each and every particle has to pass a point of maximum fermentation where the whole mass seethes and bubbles furiously. Up and down currents mix the contents thoroughly. From there the fermentation slows and stratification begins into the layers of gas, scum, supernatant and sludge... the spent portion of the original solids. Through digestion this sludge will have contracted considerably from the original raw state.

Failure of the bacterial "brew" will occur if excessive loads of manure are used. Keep to three 1-pound coffee cans daily. If not fed daily for one reason or another and the unit is left without "food" for a week for instance, start it up again with four and one-half coffee cans full the first day and continue as usual afterwards. Do not feed in *back coffee cans full for each missed day* (21 cans for 7 missed days).

A second reason of failure of the brew is an excess of water, particularly cold water.

15. Removing Scum and Effluent

A. Scum

1. When the scum collector container feels heavy, remove the filler cap from the bottom of the scum container and let the scum out.
2. Care must be taken that *air is not allowed to enter the container* at this point.

B. Effluent

3. Effluent is drawn off daily or so to the extent of approximately half of volume of daily input at feeding. The other half of daily input is accounted for as (1) gas and (2) contraction during fermentation.

4. The superior fertilizing value of the effluent is discussed elsewhere. This inner tube digester will produce enough to improve growth of plants on an area of 2,152 sq. ft. per year -- a good sized vegetable patch.

16. Safety Precautions

Precautions In Gas Usage

Gas will burn with a hot flame when ignited as it leaves the burner (in contact with air). But if gas and air are mixed together in proportions of 1 part in 4 to 1 in 14 and then ignited in a closed area or container, a violent explosion will ensue.

To avoid any possibility of explosion in this sized unit, the first time the digester produces enough gas to fill the pipes, scum accumulator and storage tanks, this gas should be allowed to disperse to the atmosphere. The second time it fills up will be relatively -- almost certainly -- safe to light. The flame is so clean and blue that it will be difficult to see in sunlight but clearly visible at night.

The second safety factor is to keep a positive (however slight) pressure of gas in the pipelines and storage, so that air is never drawn into any part of the unit. (Weights on the storage inner tubes, pressure on the main tube when emptying the scum, so the pipes won't collapse).

The third safety factor is to check the unit daily for leaks; there will be a discoloration of the tubing in places where the gas has leaked out.

Finally, smell is important in safety handling. Never light a match in a room with a strong smell of gas -- or even a slight smell. Air out the room first.

17. Lighting the Flame

A small gas flame can be lit at the open end, provided the gas flow is held low. If the flow is too strong, the flame will burn inches away from the open end and be difficult to control. The adapter on the burner decreases the flow.

18. pH

To keep track of pH values, narrow range litmus paper with a range from 6.5 to 8.5 or 9 can be used to check effluent. In my experience of digesting animal manures, a healthy brew, working at top efficiency will have an effluent pH of around 8.5. This is in contrast to all published literature on digestion of sewage plant solids in which a working range of 7 to 7.6 is considered average. If it should drop to 7.6 or so in this unit, reduce feeding to miss the first day, then half feed until the pH of the effluent rises to 8 at least.

Should the pH drop as low as 7 or 7.2, add a cup of ammonia (the ordinary ammonia bought in a store) to the raw slurry at the next feed in. Reduce the feed in (or loading) slightly from then on.

When organic material decays it yields useful by-products. The kind of by-product depends on the conditions under which decay takes place. Decay can be *aerobic* (with oxygen) or *anaerobic* (without oxygen). Any kind of organic matter can be broken down either way, but the end products will be quite different (Fig. 1).

A Brief Personal Account of The First Large-Scale Displacement Digester

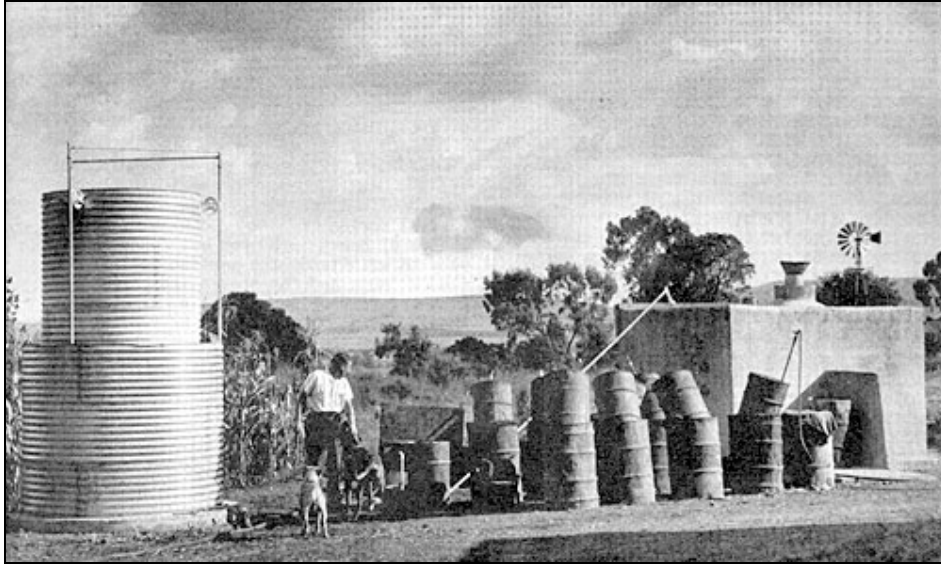

Fig. 31 Where it all began. L.J. Fry's South Africa farm

I owned and operated a hog farm outside Johannesburg. The average standing population was 1000. It was a model farm on 25 acres and ran most efficiently except for one considerable problem: the two tons (wet weight) of manure produced daily.

For years I composted it and spread it inches thick over the farm and used a rotary hoe to chop it into the soil. This required scraping it up, piling it, watering it, and turning the piles twice, at least, then loading it on a truck and finally spreading it more or less evenly. Heavy rains played havoc with it at times. Often drought required using precious water to dampen the compost. It required a lot of labor.

I then read of a suggestion that manure might decompose in the same manner as solids do in most sewage works, namely decomposition in a liquid form by methane bacteria. Would it work on pig manure also?

I went to the main sewage treatment plant in Johannesburg, and was taken round the entire unit. I found the decomposition of solids (called digestion) most interesting. If such solids could undergo a complete metamorphosis as to be unrecognizable from the raw product, then manure solids would presumably do the same. There was one big difference. Municipal waste is washed down the sewer lines with large quantities of water. On the other hand, manure was collected by shovel and carted by wheelbarrow. Water had to be added to turn it into a slurry.

After many months, frequent visits to the sewage works, and long hours in the local University library, I took back to the farm a sample of actively working bacteria in a sealed container as a "starter" to try out on pig manure. I used a series of 50 gallon oil drums, cut the tops off and poured in a slurry of pig manure. Into each drum I then added a measured quantity of "starter," some from the sewage works and some from a sump located at the lowest point below the piggery. Next I fitted 30 gallon drums into the slurry. Some three weeks later the drum with the "sump starter" began to generate gas. The smaller drum filled slowly with gas and rose above the surface of the slurry.

It was then the summer of 1956-1957, days in the low 80°F (27°C), nights 20° cooler. It was surprising that the sharp variations of 20°F (11°C) did not kill the bacterial "brew." The first drum to rise was the one half fresh raw pig slurry and half "brew" from the sump. All the others followed eventually, some weeks later, probably due to insufficient starter "brew."

Design of the First Full Scale Displacement Methane Plant

After my success with the sump digester and a great deal of "weighing the options" I decided on a plan of twin digesters with fixed roofs and a series of gas holders to store some of the gas generated. Having twin digesters side by side had the advantages of:

1. Using one as a primary and the other as a secondary digester.
2. Should the primary be overloaded and have a bacterial breakdown, the secondary would then be available to receive at least part of the load. The primary digester would eventually be brought back to use by splitting the load between the two.
3. Different manures could be used for experimentation.

Digester Description

Outside the digester a basin was made 12' x 8' x 2' deep with the floor sloping to a grid made of angle iron 3' x 6' with a steel screen of 3/8" rod with 1" mesh. The very heavy 3/8" rod was found necessary to withstand the suction pull of the sludge pump and for preventing corrosion. A short ramp up to the basin allowed for wheelbarrows of manure to be run up and tipped into the basin. This was done daily and amounted to about 26 wheelbarrow loads of about 2 cubic feet each.

Water (about 250 gallons) was then hosed in and the whole mass raked with a garden rake. When mixed to a slurry, the pump was started and the mass moved to a sand trap. A simple but efficient system was used.

A drum with a tight fitting lid and sturdy clamp had an inlet half way down and an outlet near the top. Sand settled to the bottom. It was inefficient in that the sand had to be cleaned out daily and this could be done only after the top half was cleaned out first.

From there the raw slurry entered the digester through a short straight pipe, the outside portion being 2' above the level of the inside of the digester and the digester end down to 1' from the floor. Thus no air entered the digester.

The digesters were each 50' long and 11' wide, concrete floor flat at the inlet end and sloping down sharply to the far end.

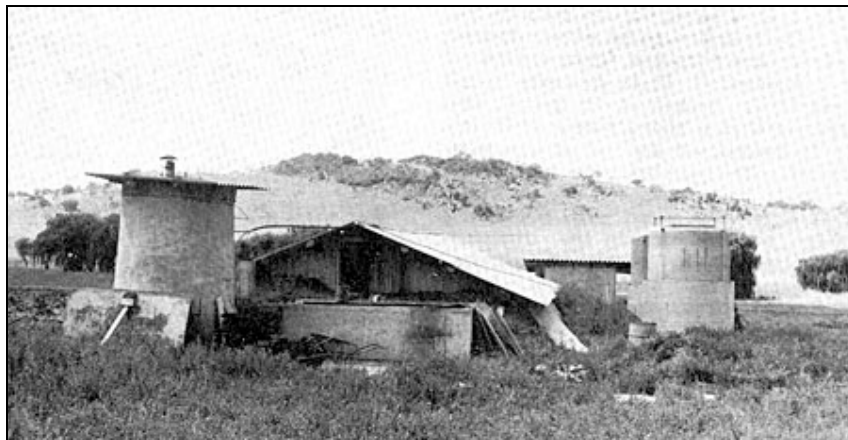

Fig. 32 Digester with storage tank in background

At the lowest point was another straight pipe as a digester outlet made of 3" pipe with a gate valve. It is important to note that all pipes in a digester be straight to allow for rodding out. It is necessary from time to time.

Vital statistics to digester design and loading were brought to light by this first unit and will be discussed in detail under the heading of 1) loading rates, 2) displacement, 3) scum accumulation, and 4) gas yields.

In anticipation of having a serious problem with scum accumulation I set short lengths of pipe into the concrete roof at various angles pointing down to the digester contents, in line with the long sides of the digester. The intention was to recirculate supernatant under pressure with a sludge pump to break the scum layer by getting the whole digester contents to rotate. The scum would then be broken up and forced into the more liquid mass.

In practice all that happened was that the jet of supernatant made a neat hole in the scum and the mass did not move.

As a second measure, I let in a series of pipes through the floor of the digesters and recirculated gas through a compressor to bubble up and crack the scum. This might have been effective if used daily or weekly with absolute regularity. But once the scum became a foot thick it would no longer break up. Also the vent holes in the floor became clogged with sand. Both methods were failures. Scum remained a major problem.

I suspect that many have encountered similar difficulties and have abandoned methane digestion in favor of other methods of treatment, solely because of it. In a small digester it is not too difficult to handle (Inner Tube Digester). In a large scale unit it can build up to 1 foot depth in a year. Scum consists of tightly knit scraps of straw from bedding or animal feed, held together by a dark colored sticky substance thrown up through the supernatant levels in the bubbling zone. It covers the entire surface more or less evenly. Here we come to another advantage of the displacement digester.

Since the scum forms evenly, the larger the surface area it has to form on, the longer it takes before it becomes a thick mat. It takes up so much digester space that the whole digester becomes overloaded due to the slurry being forced through too quickly. It then has to be either broken up and mixed back into the fermentation or physically removed. It is my experience that when it is broken up it merely reforms again within a short time. Little, if any, is decomposed and withdrawn with the effluent. The problem, therefore, resolves itself to a question of physical removal at intervals.

In order to make room in the digester to load in the daily quota of slurry, withdrawals were made from the outlet end from the lowest point, that is, the sludge outlet. I withdrew 3 or 4 days' worth of effluent at a time, of 500 gallons each. To do this I backed my tank truck into a short excavation so that the top of the tanker was about 2 feet below the digester roof level. A 3" plastic connection and two 3" valves completed the withdrawal circuit. On the top of the tank truck was an opening to vent out air when the tanker was being filled. Into this I fitted a tennis ball in a cage so that when sludge rose to the vent joint, the tennis ball shut off when the tank filled. This prevented messy overflows.

The effluent was then spread on fields as a fertilizer. There was also a strong demand for it in Johannesburg where it was used in winter to bring up the grass faster in the spring than any other known method.

Gas yield from the two digesters averaged 8,000 cubic feet per day. The gas was analyzed at the City Gas Works at 711 BTU per cubic foot (sea level value). Sometimes the gas yield went as high as 12,000 ft³ for weeks at a time, after a digester had recently been returned to work. It was a matter of delayed action of the brew. From the time the digester was half full to the time it was full (about 3 weeks), the bacteria did not generate much gas. At about the time it filled up, the backlog would surge gas production.

To provide the heat to the first displacement digester, I built an engine room adjacent to the digester outlet end. The engine was fueled by 6000 cubic feet of gas daily and the cooling water and exhaust gases were returned to the digester to maintain the optimum temperature. The exhaust gas was led through a series of boulders against one digester wall. The boulders were packed with dry earth covered, in turn, by a layer of concrete as weatherproofing.



Fig. 33 Spreading the effluent

The engine design called for a maximum cooling water temperature of 140°F (60°C). This coincided exactly with the maximum temperature for pipes laid on the digester floor. If a higher temperature had been used, the sludge would have "caked" on the pipes and prevented the transfer of the heat.

So a small $\frac{3}{4}$ " pump was installed, driven directly by the engine, and run at slow speed (to improve endurance) to circulate water. In the circuit there was also a 200 gallon header tank to keep the lines full at all times. In winter it was bypassed and in summer the 200 gallon tank was taken into the circuit as a means of cooling the water to prevent the digester temperature from rising over 95°F (35°C). The engine and digester combination ran day and night for 6 years, except for occasional stoppages and for repairs.

We are taking the experience gained from this major experiment to draw plans for a series of projects in methane digestion, in a range of sizes. However, it is worth mentioning that the whole methane plant including engine cost about \$10,000 and produced 8000 ft³ gas daily. At the altitude of 5500 ft above sea level the B.T.U. value was 585 per ft³. Thus, 4,680 B.T.U. ($\times 10^3$) per day or 46.8 Therms. At the present 1973 price in Santa Barbara this amounts to \$7.57 per day or \$16,578 over the 6 years, in gas alone. The saving in labor in the loading and spreading of manure made for a far faster return on capital. By far the greatest return was neither in gas nor labor saving, but in the value to the soil of the effluent returned as a fertilizing material.

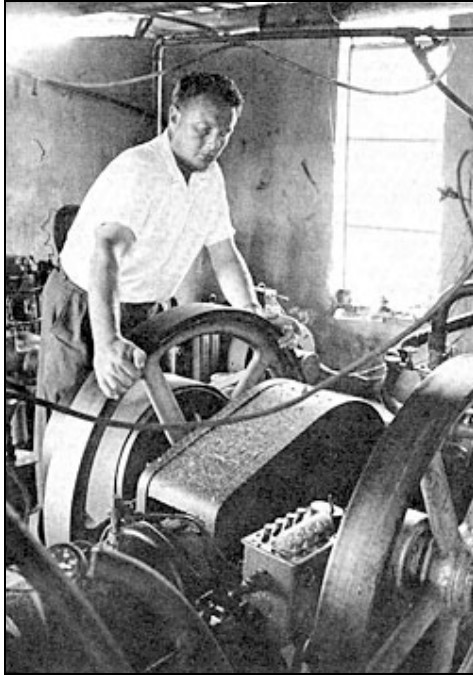
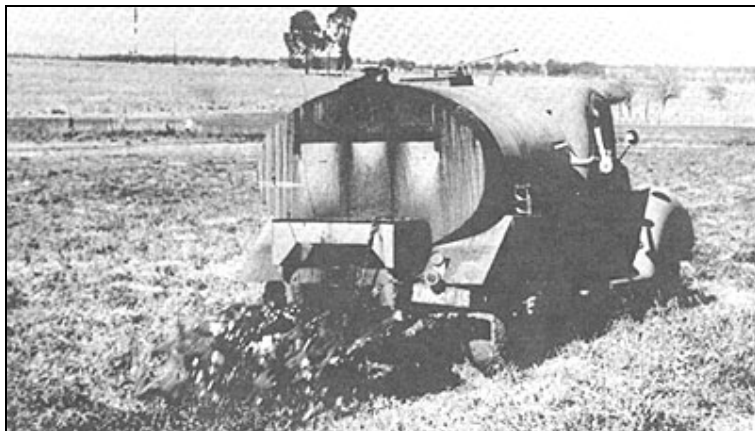
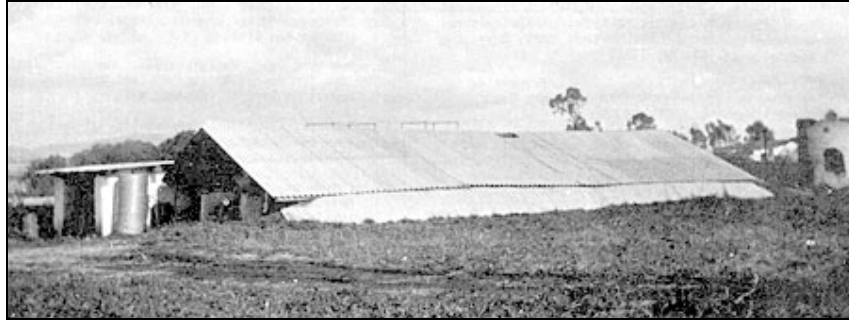

Fig. 34 13 hp diesel engine converted to run on methane gas



One day's manure production from 1000 pigs, once digested, spread on crops in 5 minutes.



Engine room, summer cooling tank and digester on the first full scale methane power plant to operate on the linear displacement principle. Water heating tower on right was abandoned in the first year.

11. References

1. Anderson, L. 1972. Energy Potential from Organic Wastes: A Review of the Quantities and Sources. Bureau of Mines Information Circular 8549, U.S. Dept. Interior.
2. Perelman, M. 1973. Efficiency in Agriculture: The Economics of Energy. In Radical Agriculture. R. Merrill (ed.), Harper & Row (In press).
3. Acharya, C. 1958. Preparation of Fuel Gas and Manure by Anaerobic Fermentation of Organic Materials. Indian Council of Agricultural Research, ICAR Research Series No. 15, 58 pp, New Delhi.
4. Acharya, C. N. 1952. Organic Manures. Indian Council Agriculture Research. Research Revision Series, Bulletin 2, New Delhi.
5. Singh, Ram Bux. 1971. Bio-Gas Plant. Gobor Gas Research Station. Ajitmal, Etawah (U.P.) India.
6. Singh, Ram Bux. 1971. Some Experiments with Bio-Gas. Gobor Gas Research Station, Ajitmal, Etawah (U.P.) India.
7. Imhoff, K. & G. Fair. 1956. Sewage Treatment (2nd ed.). John Wiley & Sons, Inc., New York.
8. Imhoff, K., W. Muller & D. Thistlethwayle. 1971. Disposal of Sewage and other Water-Borne Wastes. Ann Arbor Science Publishers, Inc., Ann Arbor, Mich.
9. Anderson, M. S. 1955. Sewage Sludge for Soil Improvement. USDA Circular No. 972. Sup. Doc. Washington D. C. 0.25.
10. Law, James P. 1968. Agricultural Utilization of Sewage Effluent and Sludge. Annotated Bibliography Federal Water Pollution Control Administration, U.S. Dept. Inter. (Super. Docum. - \$0.45).
11. Greeley, S. and C. R. Velzy. 1936. Operation of Sludge Gas Engines. Sewage Works Journal 8(1): 57-62.
12. Jeris, J. & P. McCarty. 1965. The Biochemistry of Methane Fermentation Using C14 Traces. Journal Water Poll. Control Fed., 37(2): 178-192.
13. Boswell, A. M. 1947. Microbiology and Theory of Anaerobic Digestion. Sewage Works Journal 19:28.
14. Barker, H. 1956. Bacterial Fermentations. John Wiley & Sons, New York.
15. Gotaas, H. 1956. Composting: Sanitary Disposal and Reclamation of Organic Wastes. World Health Organization, Geneva.
16. American Public Health Association. 1960. Standard Methods for the Examination of Water and Wastewater. 11 ed. New York.
17. Dugan, Gordon L. et. al. 1970. Photosynthetic Reclamation of Agricultural Solid & Liquid Wastes. Sanitary Engineering Research Laboratory, University of California at Berkeley SERL Report no. 70-1.
18. Schnabel, C. F. 1973. Grass. Acres: A Voice Eco-Agriculture, March 1973. Box 1456, Kansas City, Mo. (A monthly newspaper of high quality.)
19. Rubins, E. and F. Bear. 1942. Carbon-nitrogen Ratios in Organic Fertilizer Materials in Relation to the Availability of their Nitrogen. Soil Sci. 54:411-423.

20. Sanders, F. A. & D. Bloodgood. 1965. The Effect of Nitrogen to Carbon Ratio on Anaerobic Decomposition. *J. Wat. Pollut. Control Fed.* 37:1741.
21. Waksman, S. 1938. *Humus: Origin, Chemical Composition and Importance in Nature.* Williams & Wilkins Co., Baltimore.
22. Management of Farm Animal Wastes. 1966. Proc. National Symposium on animal waste management. May 5-7, 1966. East Lansing Mich. From: American Society of Agricultural Engineers. St. Joseph, Mich. 49085 (\$5.00)
23. Hart, Samuel. 1960. Sludge Digestion Tests of Livestock Manures. Dept. Agr. Engr. Univ. of Calif. Davis. Offprint manuscript.
24. Hart, S. 1963. Fowl Fecal Facts: National Symposium on Poultry Foul Wastes, Lincoln American Society Agricultural Engineers, University of Nebraska.
25. Heck, A. 1931. The Availability of the Nitrogen in Farm Manure under Field Conditions. *Soil Sci.* 31: 467:481.
26. Taiganides, Eliseos P. 1963. Characteristics and Treatment of Wastes from a Confinement Hog Production Unit. PhD dissertation, Iowa State Univ. Science and Technology, Agricultural Engineering. Available from University Micro-film Inc. Ann Arbor, Mich. #63-5200, 177 pp.
27. Taiganides, E. P. 1963. Anaerobic Digestion of Poultry Manure. *World's Poultry Science Journal* 19(4).
28. Taiganides, E. P., E. Baumann, H. Johnson, T. Hazen. Anaerobic Digestion of Hog Wastes. *Journal Agricultural Engin. Research* 8(4).
29. Papandos, S. & B. Brown. 1950. Poultry Manure. Connecticut Agric. Exper. Station Bulletin 272.
30. Mishihara, S. 1935. Digestion of Human Fecal Matter. *Sewage Works Journal.* 7(5): 798-809.
31. Salter, R. M. and Schollenberger, C. J. 1939. Farm Manure. Ohio Agricultural Experiment Station Bulletin 605.
32. Sobel, A. 1966. Physical Properties of Annual Manures Associated with Handling, In "Management of Farm Animal Wastes;" Proceedings National Symposium on Animal Waste Management.
33. Anderson, S. 1957. Farm Manure. U. S. Dept. Agriculture, Yearbook of Agric. 1957: 229-257.
34. Eby, H. 1961. Design Criteria for Manure Lagoons. Amer. Society of Agricult. Engineers. Paper 61-935.
35. Loehr, R. 1968. Pollution Implications of Animal Wastes. Federal Water Pollution Control Administration, Kerr Water Research Center, Ada, Okla, July 1968.
36. Miner, J. R. 1971. Farm Animal-Waste Management. Iowa State Univ. of Sci. & Technol. Agricultural and Home Economics Expt. Station, Ames, Iowa, Special Rept. 67, May 1971.
37. Taiganides, E. & T. Hazen. 1966. Properties of Farm Animal Excreta. *Trans. Amer. Soc. Agric. Engin.* 9(3)374-376.
38. Hazen, T. & D. Mangold. 1960. Functional and Basic Requirements of Swine Housing. *Agricultural Engineering.* 41:585-590.
39. British Oil & Cake Mills Ltd. 1964. Poultry Manure and its Disposal. Poultry Advisory Board, Albion Wharf, Erith, Kent, England.

40. Klein, S. 1972. Anaerobic Digestion of Solid Wastes. *Compost Science Jour.* Feb. 1972.
41. Laura, R. & M. Idnai. 1971. Increased Production of Biogas from Cowdung by Adding Other Agricultural Waste Materials. *Journal of the Science of Food and Agriculture*. 22:164-167.
42. Fry, J. 1961. Manure Smell Furnishes Farmstead's Power Needs. *National Hog Farmer* 6:3.
43. Patel, J. 1951. Digestion of Waste Organic Matter and Organic Fertilizer and a New Economic Apparatus for Small Scale Digestion. *Poona Agricultural College Magazine (India)*, 42(3): 150-159.
44. Fry, J. 1960. Power and Electric Light from Pig Manure. *Farm and Country*. April, 1960. London.
45. *Mother Earth News*. 1972. Plowboy Interview with Ram Bux Singh. No. 18. Madison, Ohio.
46. King, F. H. 1911. *Farmers of Forty Centuries: Permanent Agriculture in China, Korea and Japan*. Jonathan Cape, London.
47. Scott, J. 1952. *Health and Agriculture in China*. Faber & Faber. London.
48. Hills, L. 1972. The Clivus Toilet — Sanitation Without Pollution. *Compost Science*, May/June 1972.
49. Schmidt, F. & Eggersgluess, W. 1954. Gas From Agricultural Waste. *Gas Journal* 279:2861.
50. Rosenberg, G. 1952. Methane Production from Farm Wastes as a Source of Tractor Fuel. *J. Min. Agric. (England)* 58:487-94.
51. Imhoff, K. & C. Keefer. 1952. Sludge Gas as Fuel for Motor Vehicles. *Wat. Sewage Wks.* 99:284.
52. Fry, L. John. 1961a. Farmer Turns Pig Manure Into Horse-Power. *Farmer's Weekly*. Feb. 22, 1961. Page 16. Bloemfontein, South Africa.
53. Golueke, C. & W. Oswald. 1963. Power from Solar Energy via Algae-Produced Methane. *Solar Energy* 7(3):86-92.
54. Ministry of Agriculture, Fisheries & Food. 1964. Nitrogen and Soil Organic Matter. National Agricultural Advisory Service. Her Majesty's Stationery Office, London.
55. Coker, E. 1966. The Value of Liquid Digested Sludge. *Journal of Agricultural Science, Cambridge*. 67:91-97.
56. New York Dept. Health. 1965. *Manual of Instruction for Sewage Treatment Plant Operators*. Health Education Service, Albany, N.Y.
57. De Turk, E. 1935. Adaptability of Sewage Sludge as a Fertilizer. *Sewage Works Journal*. 7(4): 597-610.
58. Poincelot, R. 1972. The Biochemistry and Methodology of Composting. Connecticut Agricultural Experiment Station. Bulletin 727, March 1972. New Haven, Conn. 06504.
59. Wolff, A. & A. Wasserman. 1972. Nitrates, Nitrites, and Nitrosamines. *Science*, 177(4043): 15-18.
60. Walters, H. 1970. Nitrate in Soil, Plants and Animals. *Journal Soil Association*, 16(3): 1-22.
61. Law, James P. 1969. Nutrient Removal From Enriched Waste Effluent By The Hydroponic Culture of Cool Season Grasses. Federal Water Quality Administration. Department Interior. From: Super. Doc. Washington, D. C. \$0.50.

62. Iby, H. 1966. Evaluating Adaptability of Pasture Grasses to Hydroponic Culture & Their Ability to Act as Chemical Filters. Farm Animal Wastes Symposium May 5-7, 1966. Beltsville, Maryland.
63. McLarney, W. 1973. The Backyard Fish Farm. Organic Gardening and Farming Magazine, Readers Research Project #1, New Alchemy Institute, Rodale Press, Emmaus, Penn.
64. McLarney, W. 1971. An Introduction to Aquaculture on the Organic Farm and Homestead. Organic Gardening and Farming Magazine, Aug. 1971, pgs. 71-76.
65. McLarney, William. 1973. Aquaculture: Toward an Ecological Approach. In: Radical Agriculture, Richard Merrill, ed., Harper & Row, New York (In press).
66. Golueke, C. G. & W. J. Oswald. 1959. Biological Conversion of Light Energy to the Chemical Energy of Methane. Applied Microbiology, 7:219-227.
67. Oswald, W. J. & C. Golueke, 1960. Biological Transformation of Solar Energy. Advances in Applied Microbiology. 2:223-262.
68. Oswald, W. J. & C. G. Goleuke. 1964. Solar Power Via A Botanical Process. Mechanical Engineers, Feb. 1964. pgs 40-43.
69. Golueke, C. & W. Oswald. 1965. Harvesting and Processing Sewage-Grown Planktonic Algae. Journal Water Pollution Control Federation.