

# PREDICTING APPLICATION PERFORMANCE USING SUPERVISED LEARNING ON COMMUNICATION FEATURES

**Nikhil Jain**<sup>\*</sup>, Abhinav Bhatele<sup>†</sup>,  
Michael P. Robson<sup>\*</sup>, Todd Gamblin<sup>†</sup>, Laxmikant V. Kale<sup>\*</sup>

<sup>\*</sup>University of Illinois at Urbana-Champaign

<sup>†</sup>Lawrence Livermore National Laboratory



This work was performed under the auspices of the U.S. Department of Energy by Lawrence Livermore National Laboratory under Contract DE-AC52-07NA27344. This work was funded by the Laboratory Directed Research and Development Program at LLNL under project tracking code 13-ERD-055. LLNL IM Release:



# SUPERCOMPUTERS



48 GB/s, 1-2  $\mu$ s

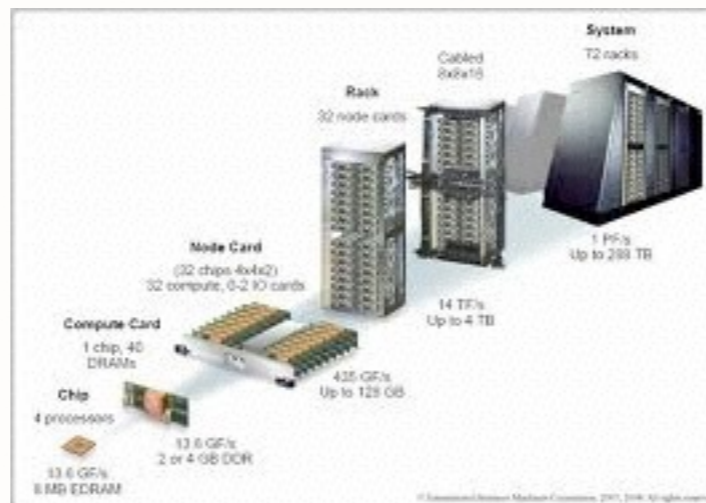

40 GB/s, 1-3  $\mu$ s



150 GB/s, 0.8  $\mu$ s

Higher Bandwidth  
Lower Latency  
Fewer hops

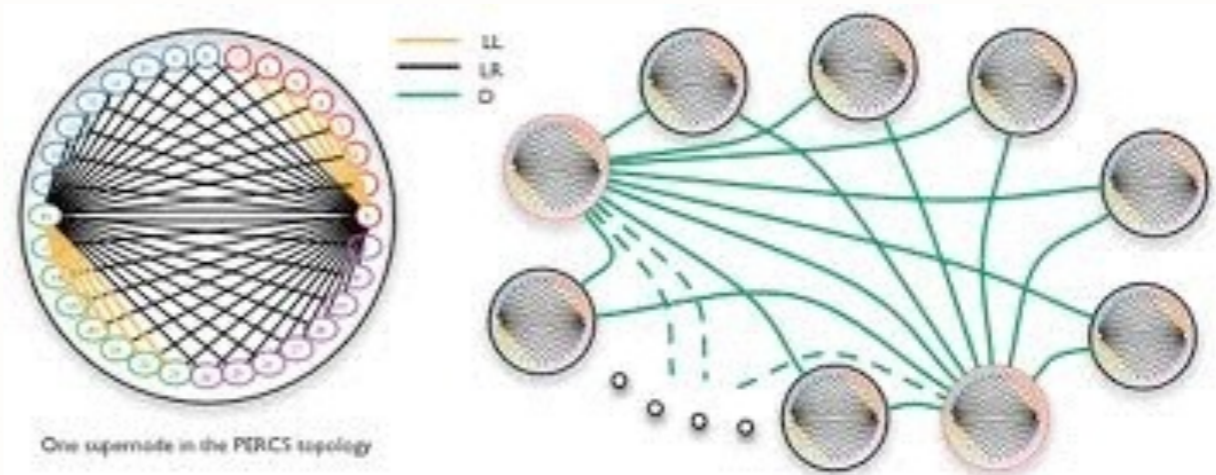

420 GB/s, 1-2  $\mu$ s

# WHY STUDY NETWORK PERFORMANCE?

- Peak bandwidth and latency are never obtained in presence of congestion
- High raw bandwidth **does not guarantee** proportionate observed performance
  - Topology, job interference, I/O
- Find the next generation topology
- Savings are proportionate to core-count

# QUANTIFYING IMPACT

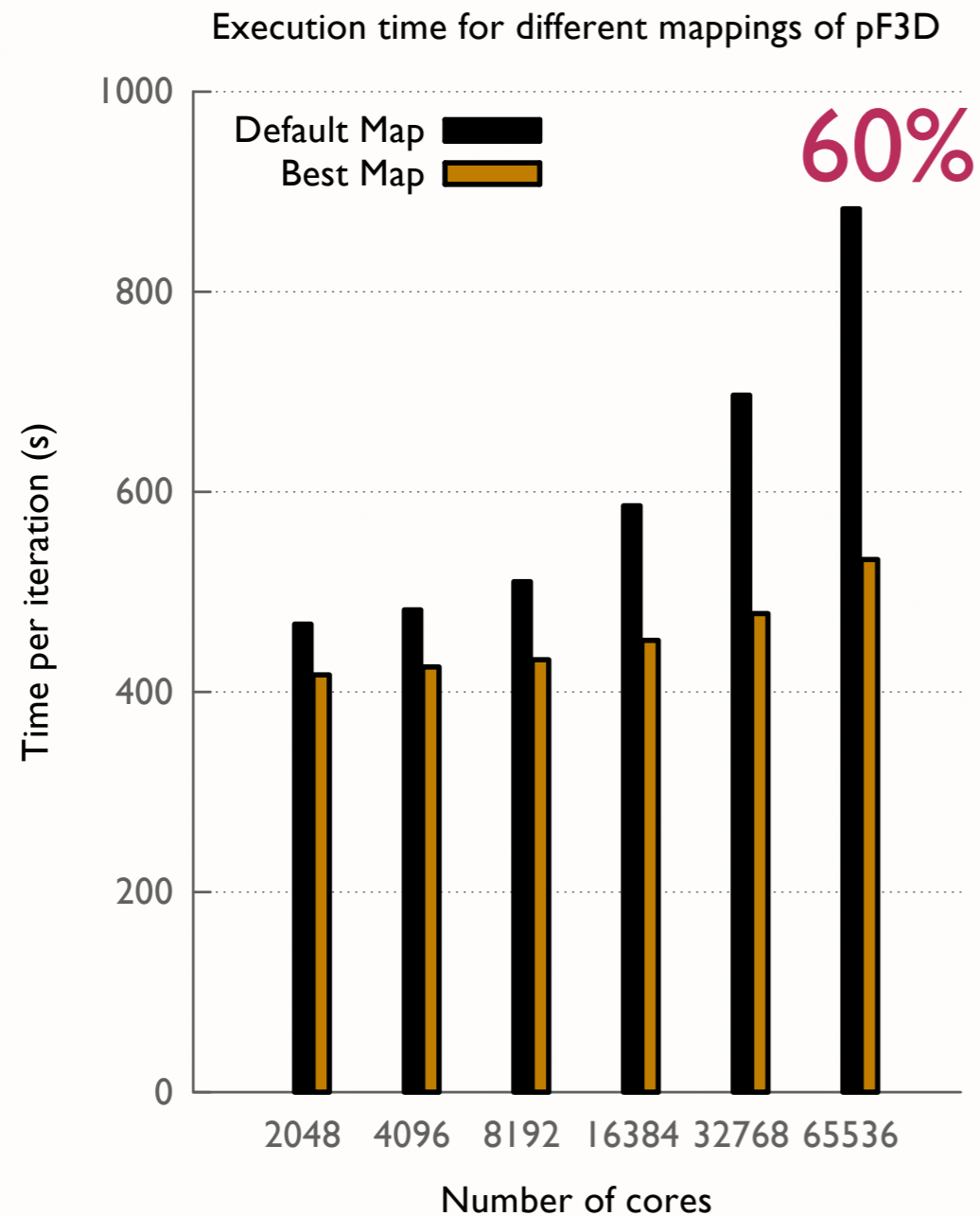

- Mapping via logical operations in Rubik
- What about others mappings?
- How far are we from the best performance?
- Which is the best performing mapping?

A. Bhatle, et al Mapping applications with collectives over sub-communicators on torus networks. In Proceedings of the ACM/IEEE International Conference for High Performance Computing, Networking, Storage and Analysis, SC '12. IEEE Computer Society, Nov. 2012 (to appear). LLNL-CONF-556491.

# PERFORMANCE PREDICTION METHODS

- Theoretically: NP hard
- Simulations: too slow
  - Few days to simulate one use case\*
- Real runs: very expensive
  - Application / allocation specific information

	2012	2013
Intrepid	4.16M	0.73M
Mira	0.17M	7.67M
Total	4.33M	8.40M

**13 million core hours!**

\*Abhinav Bhatele, Nikhil Jain, William D. Gropp, and Laxmikant V. Kale. 2011b. Avoiding hot-spots on two-level direct networks. In *Proceedings of 2011 International Conference for High Performance Computing, Networking, Storage and Analysis (SC '11)*. ACM, New York, NY, USA, 76:1–76:11.

# HEURISTICS

## PRIOR FEATURES

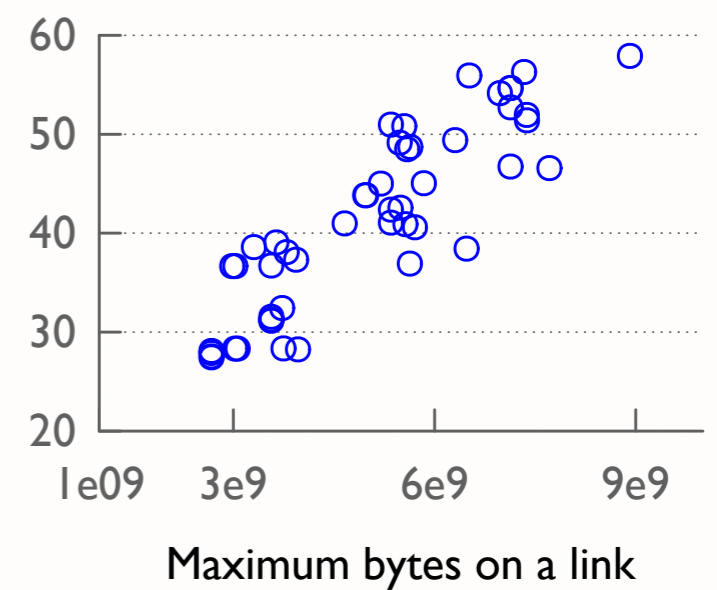
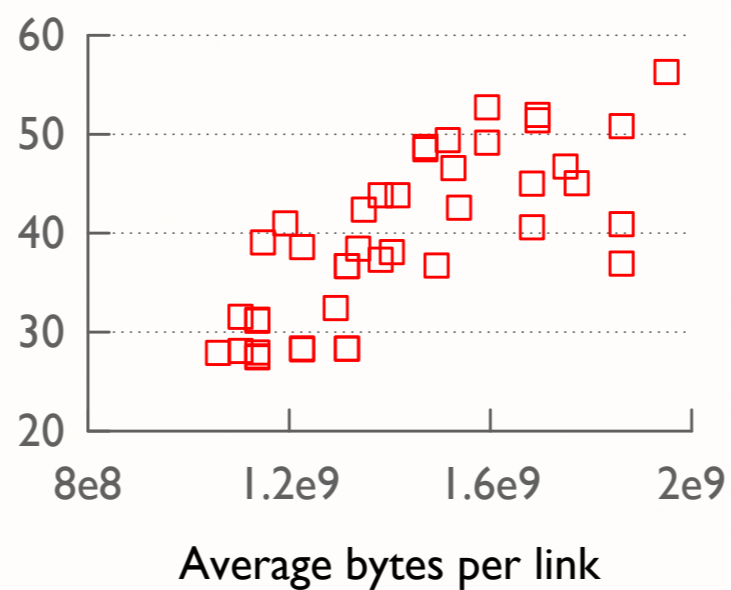
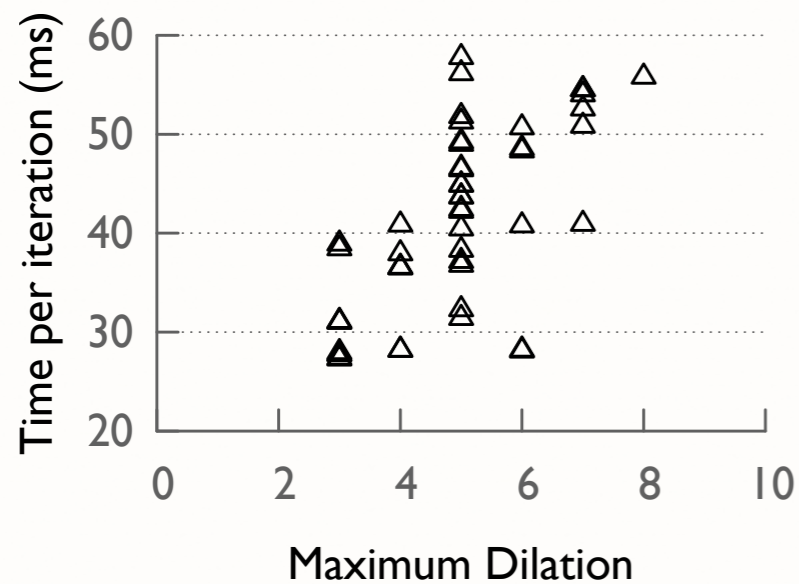

2D-Halo: predicting performance using a linear regression model for prior features

# SUPERVISED LEARNING: OVERVIEW

- Collect/generate data and summarize
- Build models: train performance prediction based on independent features
- Predict and correlate

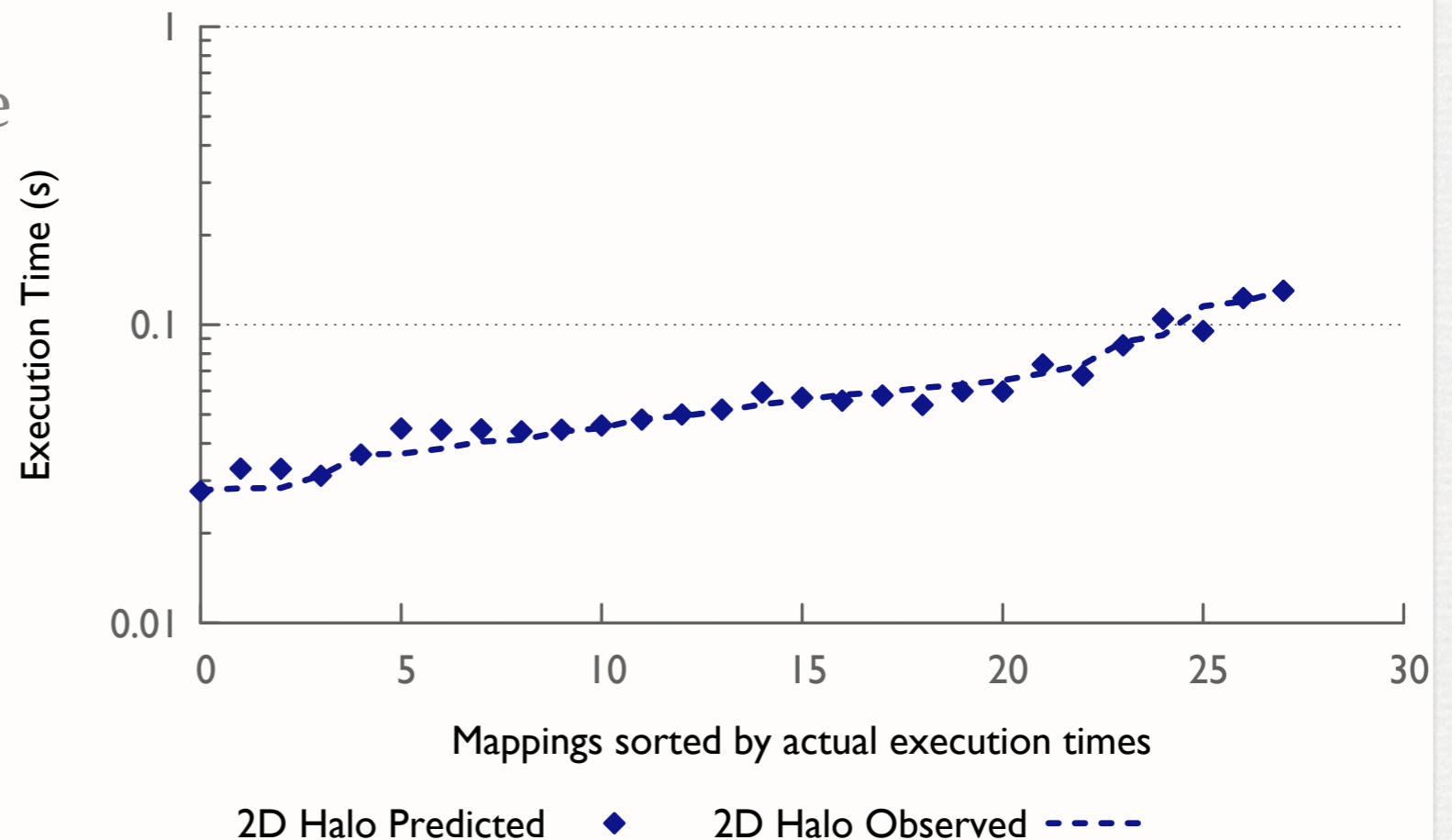

# MESSAGE LIFE CYCLE ON BLUE GENE/Q

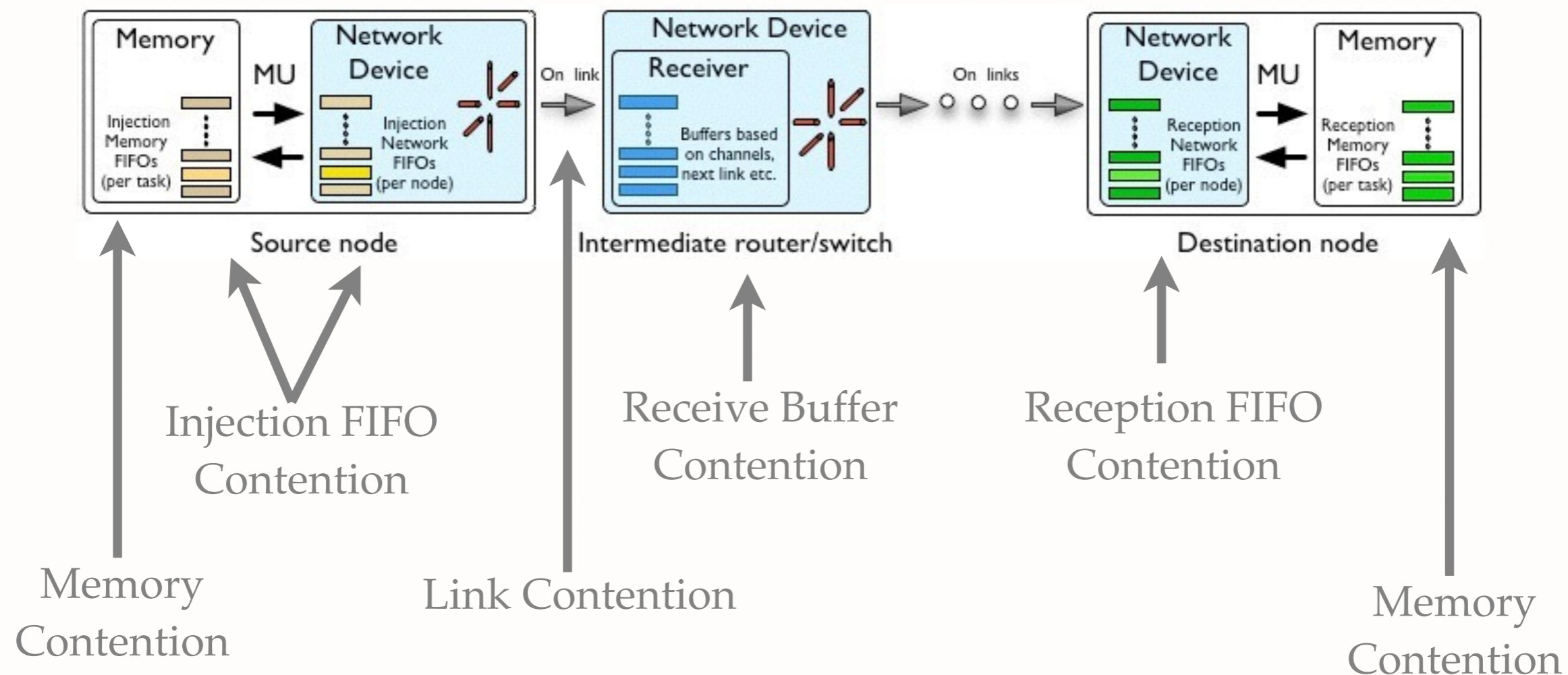



# INPUT FROM NETWORK COUNTERS

- A PMPI based BG/Q-Counter collection module
- Packets sent on links in specific directions: A, B, C, D, E
  - deterministic, dynamic
- Packets received on a link
- Packets in buffers

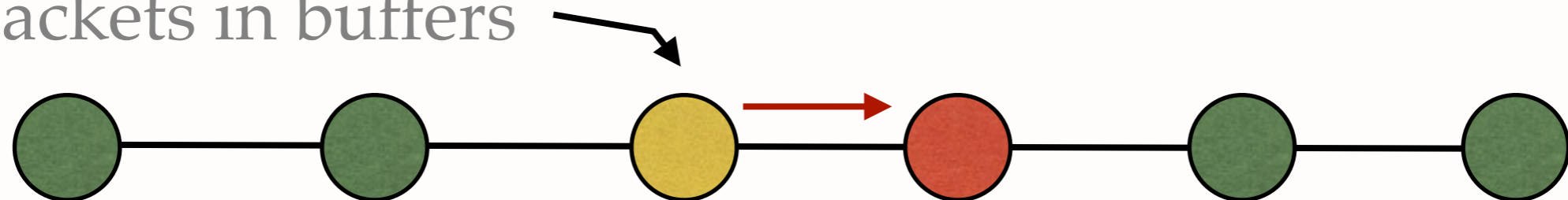
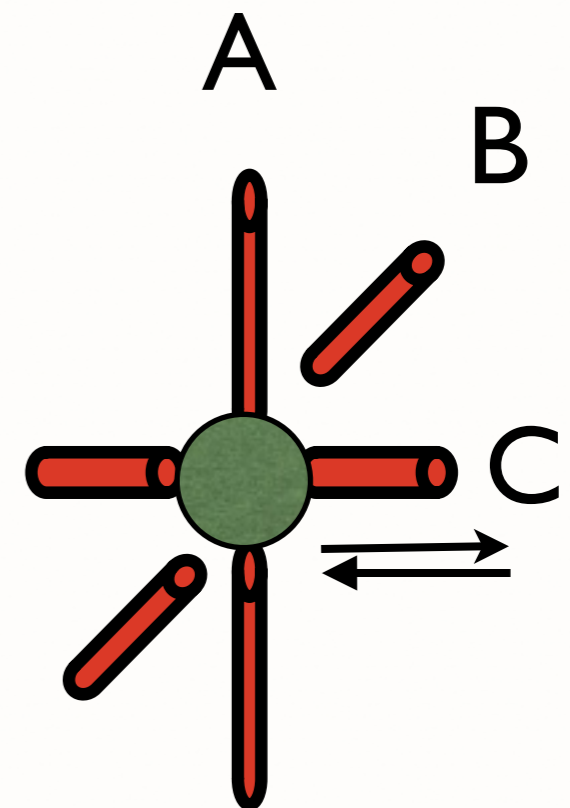

# INPUT FROM SIMULATION

- Simulate the injection mechanism
  - Selection of memory injection FIFO
  - Mapping of memory FIFO to network injection FIFO
- Simulate routing to obtain hops / dilation

# INPUT DATA

Indicator	Source	Derived from
Bytes on links	Counters	Sent chunks
Buffer length	Counters	#Packets in buffers
Delay per link	Counters	#Packets in buffers / #received packets
Dilation	Analytical	Shortest path routing
FIFO length	Analytical	Based on PAMI

# BUILDING MODEL

- Derive features from the raw data on entities, e.g. average bytes on links
- Create a database of derived features and performance; we have used 100 mappings
  - 33% mappings generated randomly
  - 33% using Rubik
  - Rest are based on better performing mappings
- Select two-third entries as training set:
  - Derived features are independent variables
  - Performance is a dependent variable

# BUILDING MODEL

- The training set is used to create a model for prediction
- Remaining entries from the database are used as the test set  
- derived features as input
- Prediction is compared with observed values
- Experimented with a large number of algorithms - linear, bayesian, SVM, near-neighbors, etc.



<http://scikit-learn.org>

# LEARNING ALGORITHM

## Decision trees

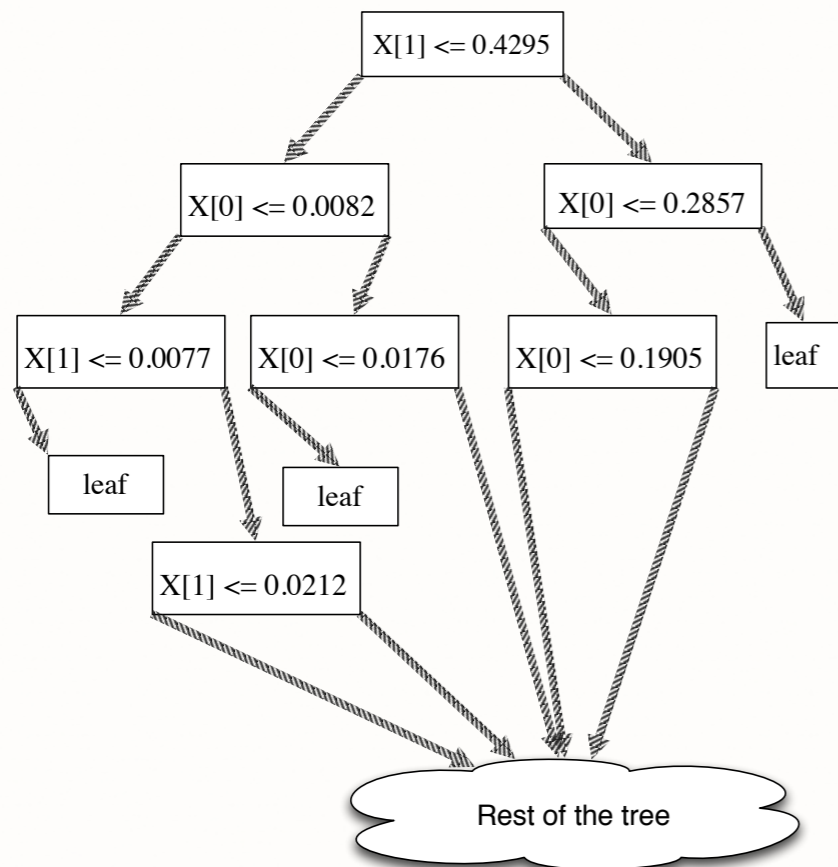

## Randomized forest of trees

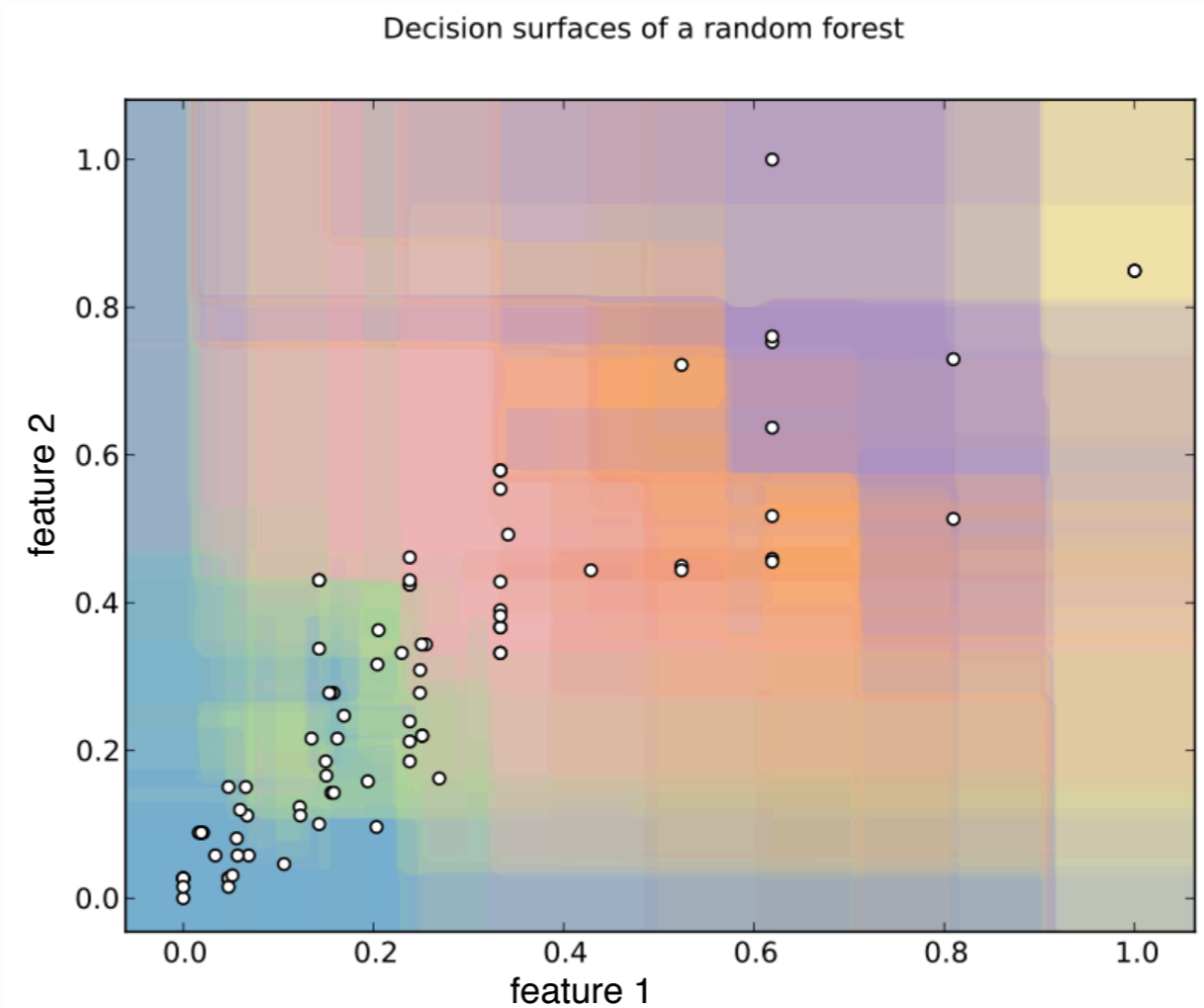

L. Breiman. Random forests. *Machine Learning*, 45(1):5–32, 2001.

# HOW TO JUDGE A PREDICTION

- Rank Correlation Coefficient (RCC): fraction of the number of pairs of task mappings whose ranks are in the same partial order in predicted and observed performance list

$$concord_{ij} = \begin{cases} 1, & \text{if } x_i \geq x_j \ \& \ y_i \geq y_j \\ 1, & \text{if } x_i < x_j \ \& \ y_i < y_j \\ 0, & \text{otherwise} \end{cases}$$

$$RCC = \left( \sum_{0 \leq i < n} \sum_{0 \leq j < i} concord_{ij} \right) / \left( \frac{n(n-1)}{2} \right)$$

- Absolute Correlation

$$R^2(y, \hat{y}) = 1 - \frac{\sum_i (y_i - \hat{y}_i)^2}{\sum_i (y_i - \bar{y})^2}$$

- Higher is better!**

# RESULTS: SETUP

- Three communication kernels
  - Five-point 2D stencil
  - 14-point 3D stencil
  - All-to-all over sub-communicators
- Four message sizes to span MPI and routing protocols



# PRIOR FEATURES

- Entities
  - Bytes on a link
  - Dilation
- Derivation Methods
  - Maximum
  - Average
  - Sum

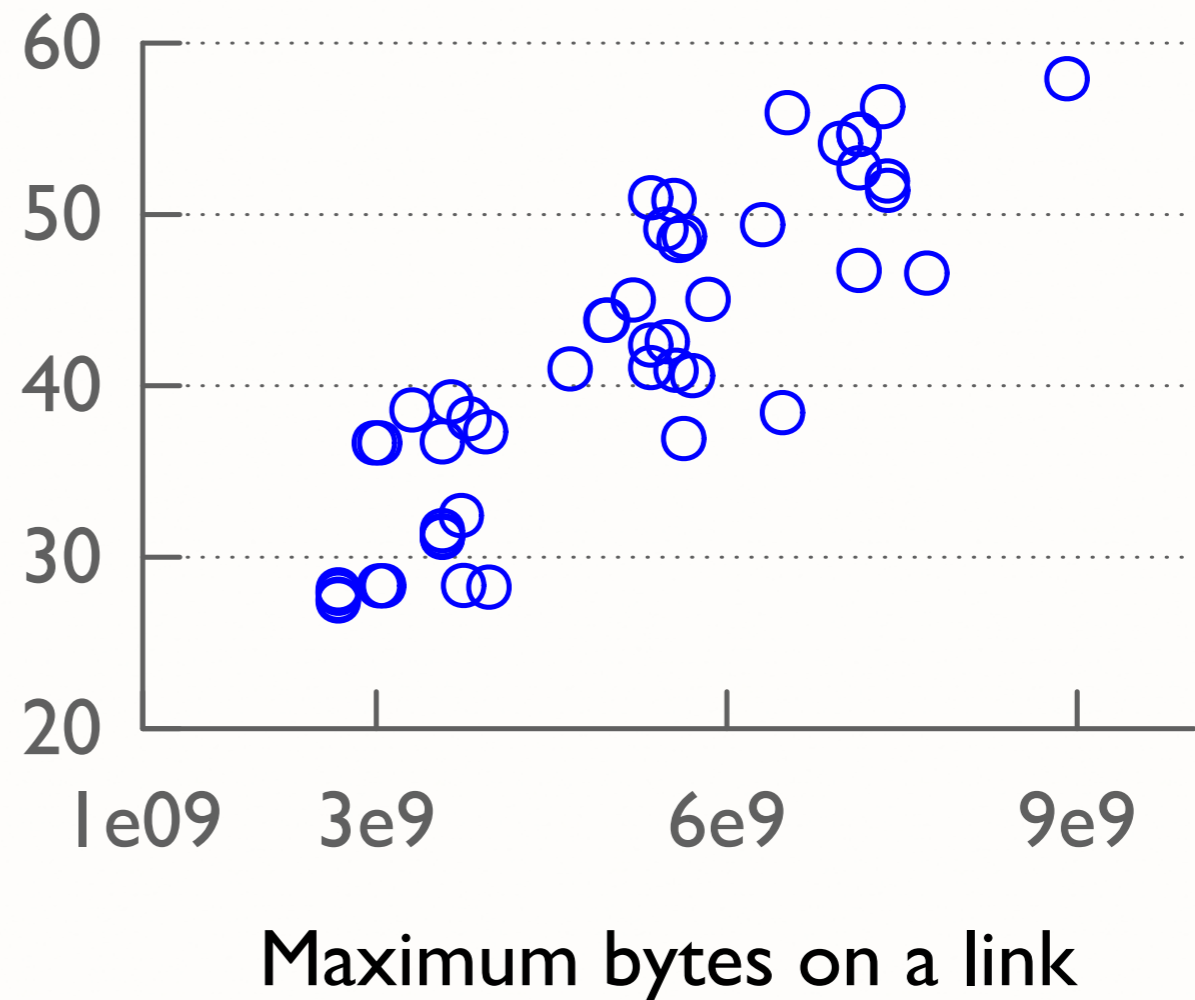

# RESULTS

## PRIOR FEATURES

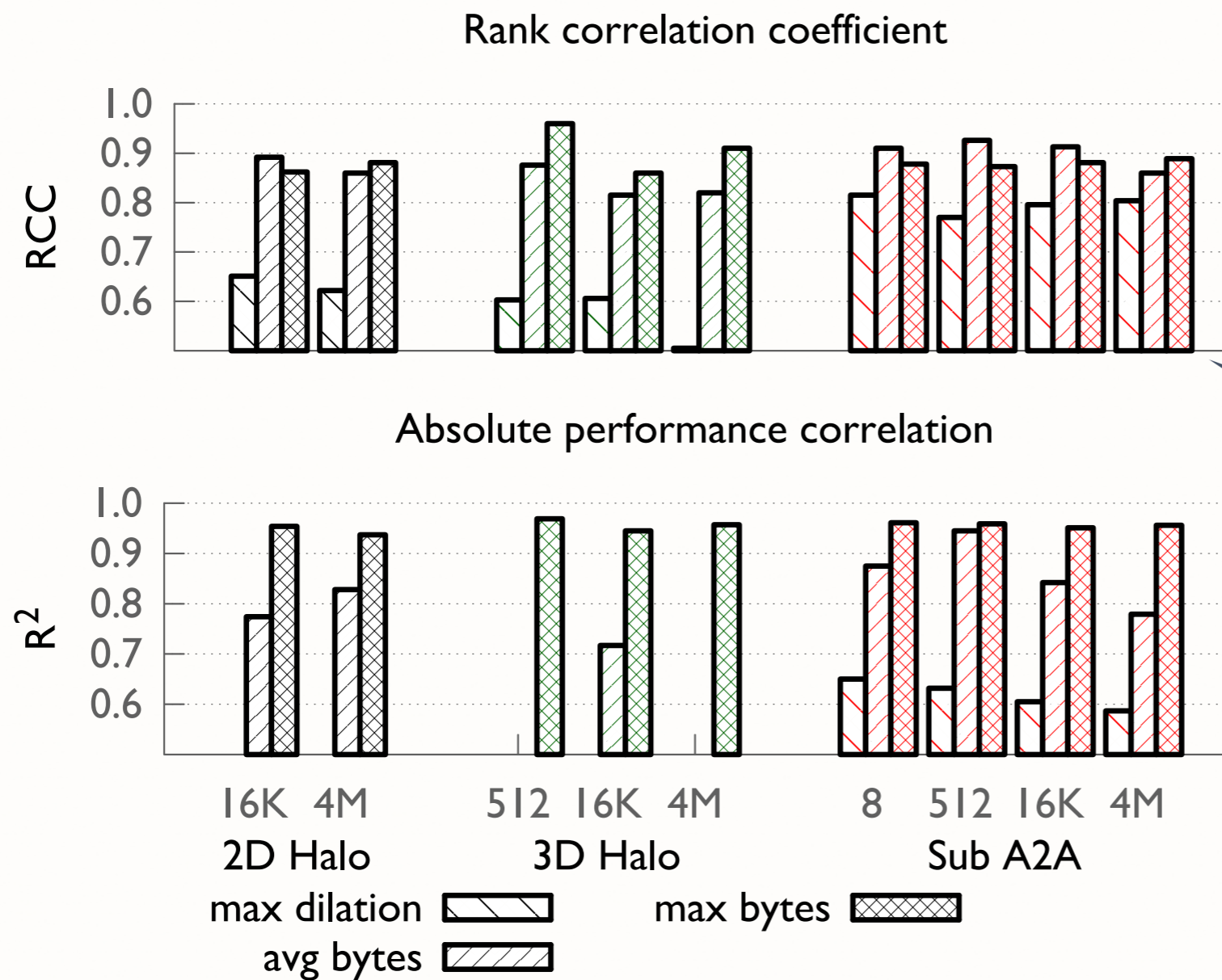

max bytes is good, but incorrect in 10% cases

# NEW FEATURES

- Entities
  - Buffer length (on intermediate nodes)
  - FIFO length (packets in injection FIFO)
  - Delay per link (packets in buffer / packets received)
- Derivation methods
  - Average Outliers (AO)
  - Top Outliers (TO)

# RESULTS

## NEW FEATURES

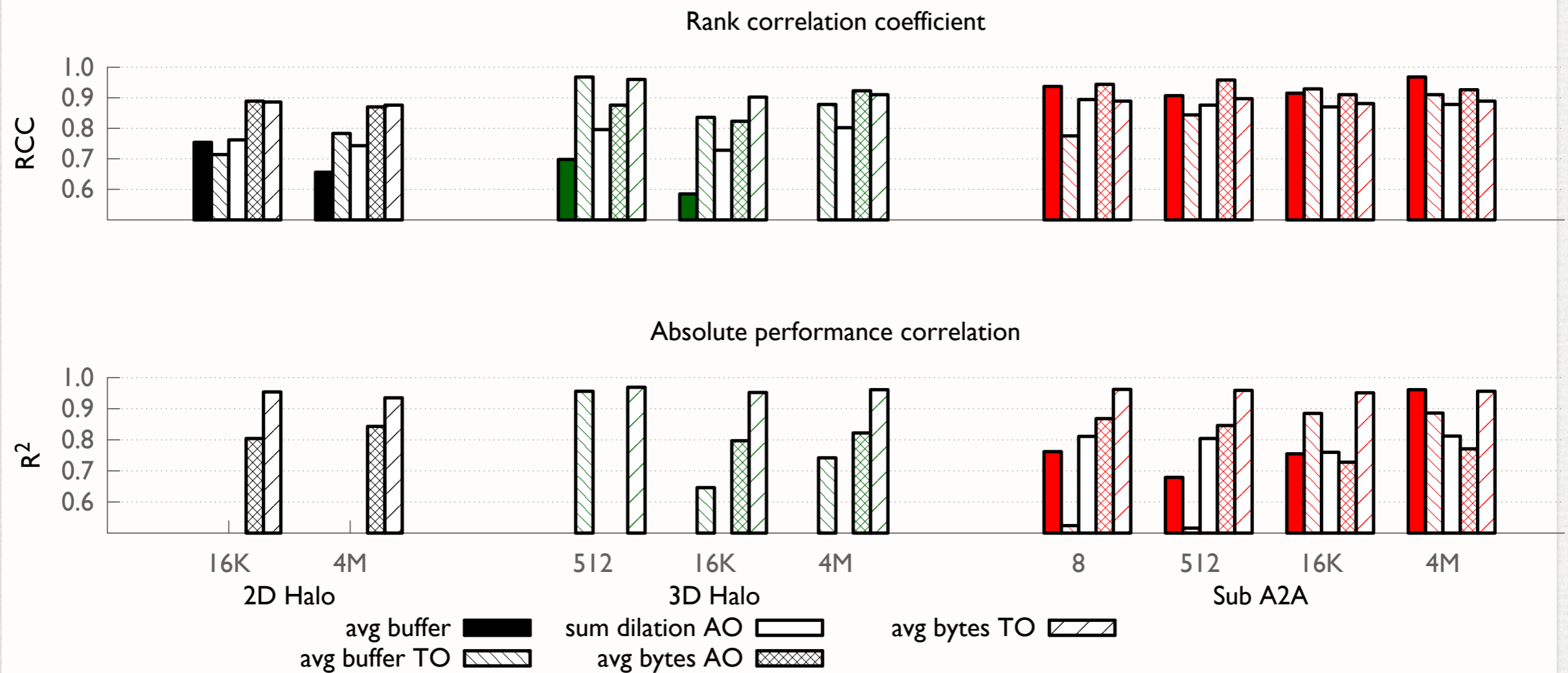

# HYBRID FEATURES

- Combine multiple metrics to complement each other
- Some combinations
  - H1: avg bytes + max bytes + max FIFO
  - H3: avg bytes + max bytes + avg buffer + max FIFO
  - H4: avg bytes + max bytes + avg buffer TO
  - H5: avg bytes TO + avg buffer TO + avg delay AO + sum hops AO + max FIFO

# RESULTS

## HYBRID FEATURES

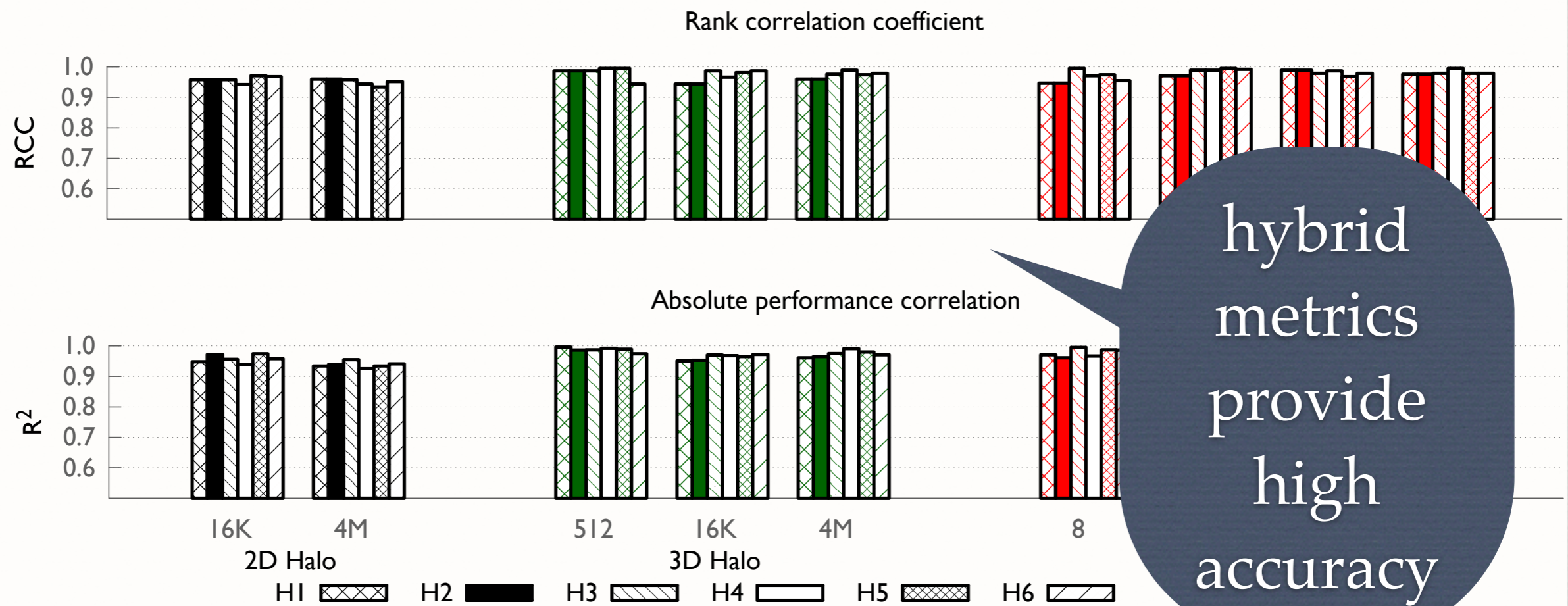

# SUMMARY ON 64K CORES

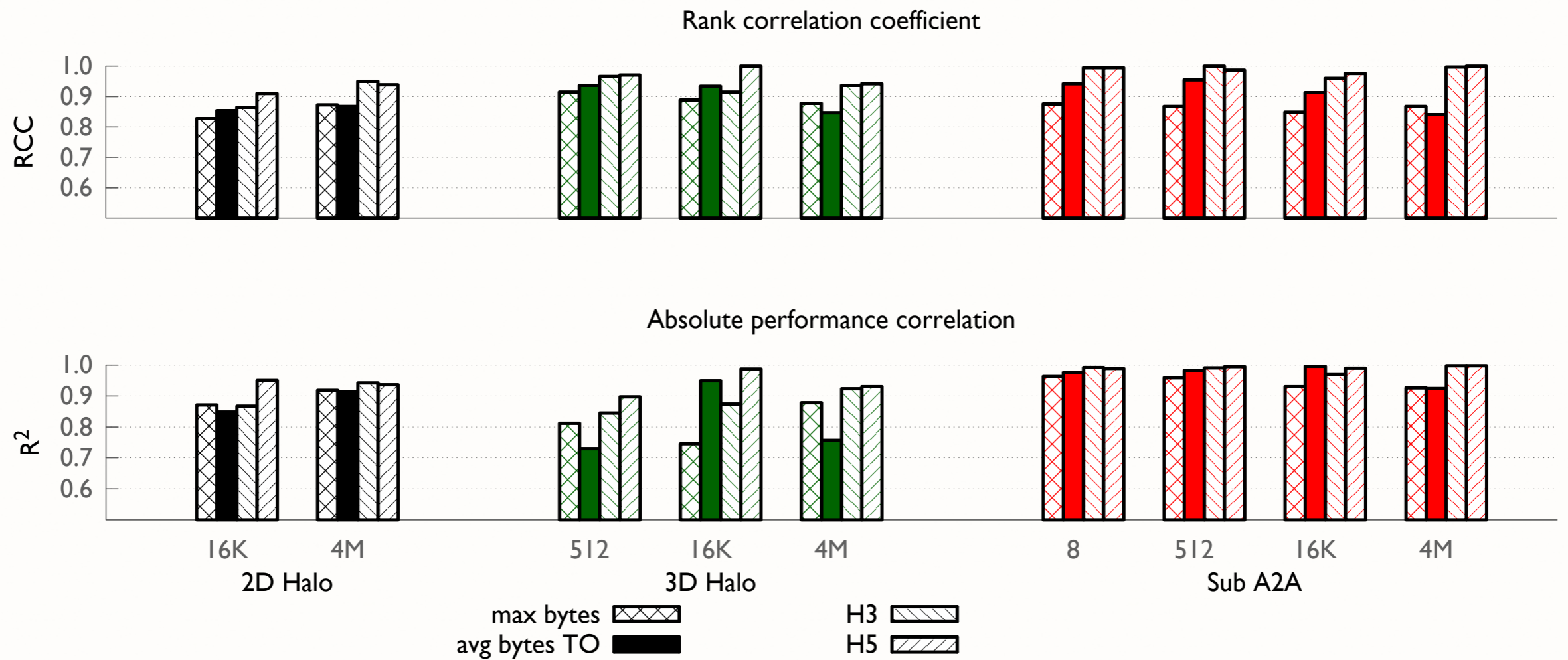

# RESULTS: TREND

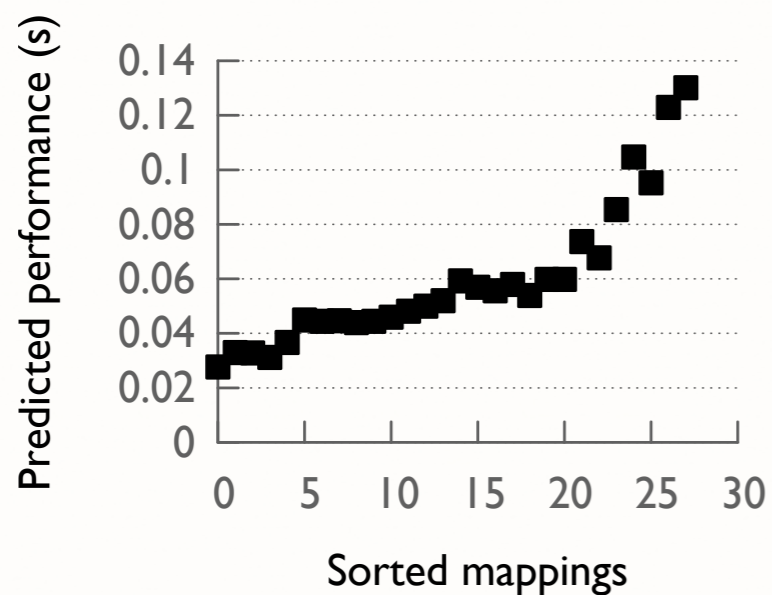

2D Halo

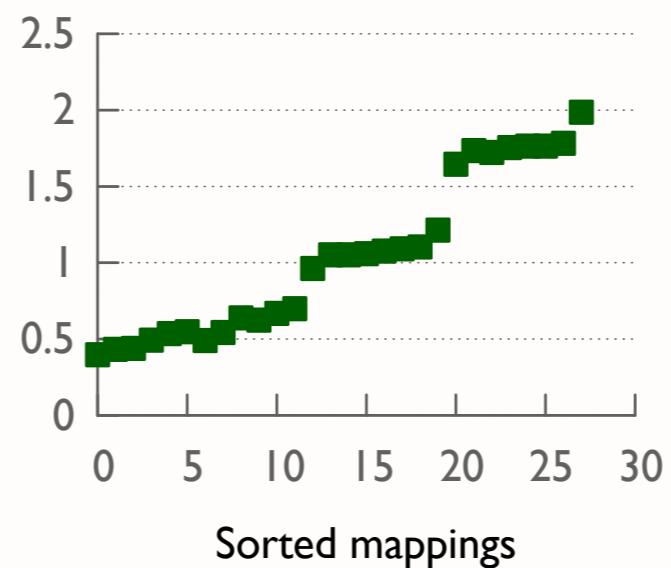

3D Halo

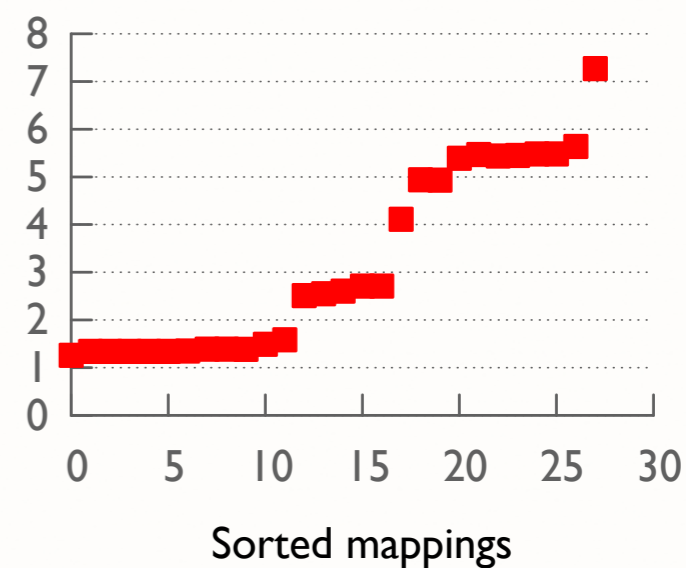

Sub A2A



# RESULTS

## ABSOLUTE PERFORMANCE

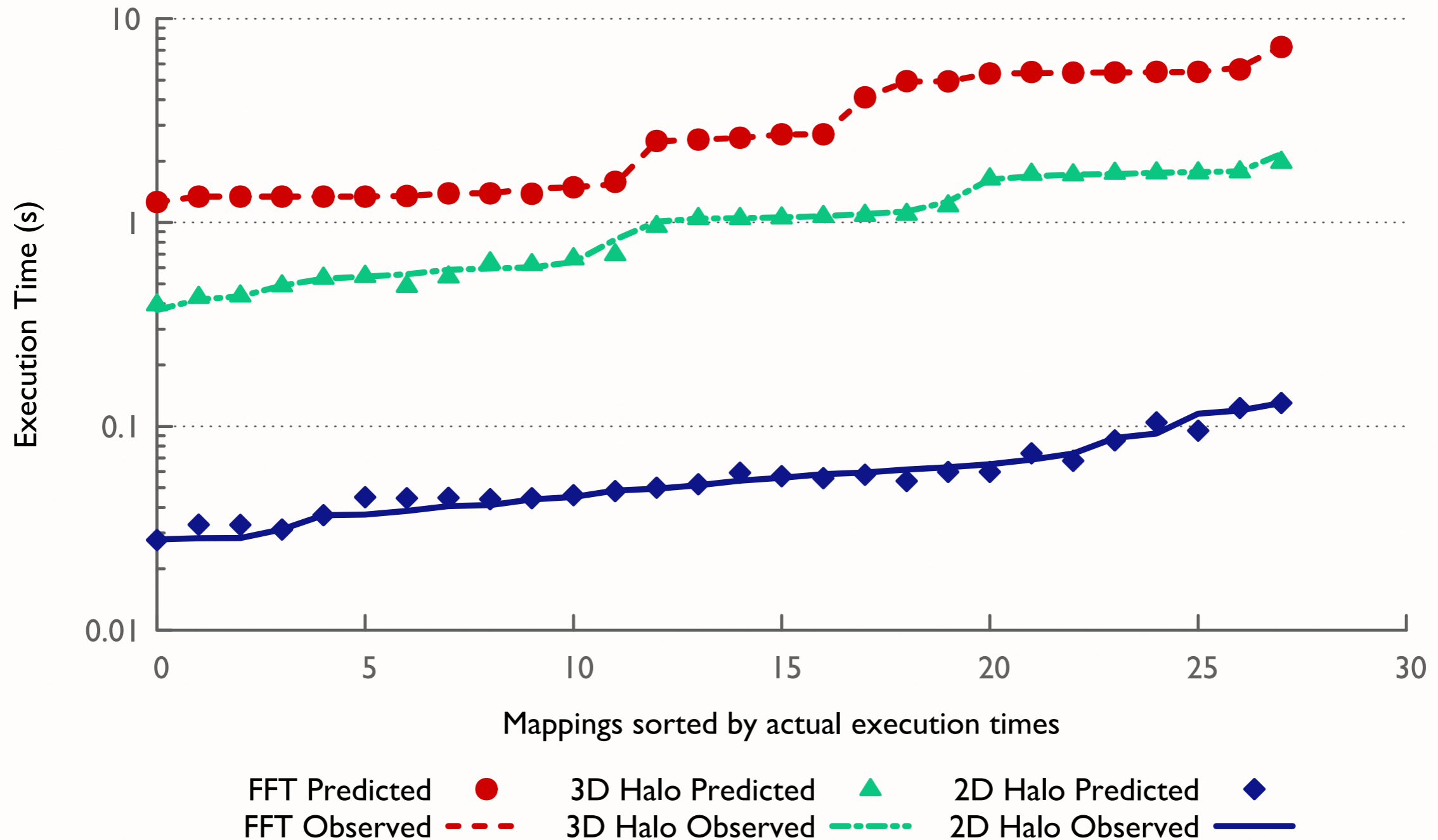

# COMBINING BENCHMARKS

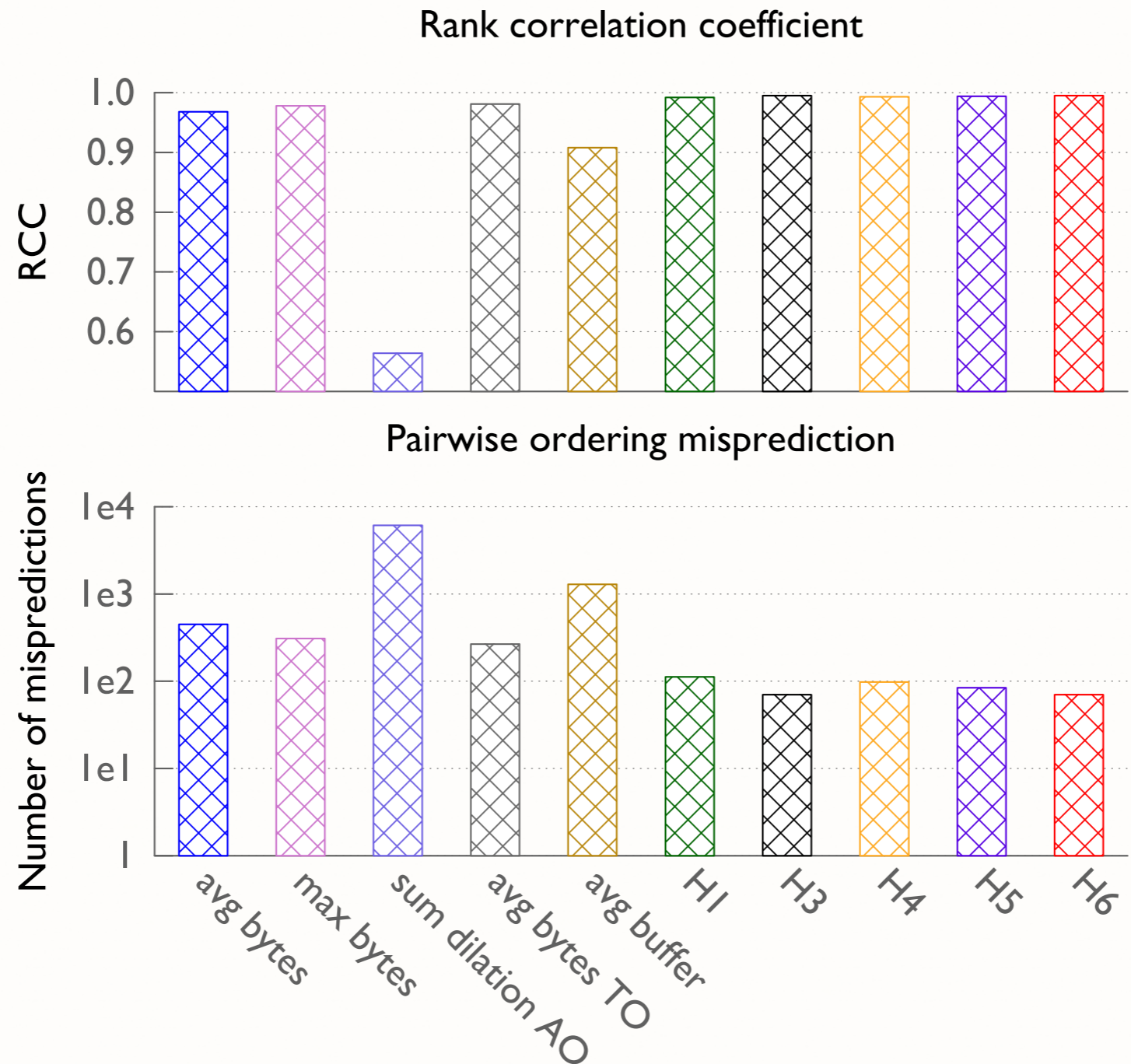

# PREDICTING FOR 64K CORES USING 16K CORES

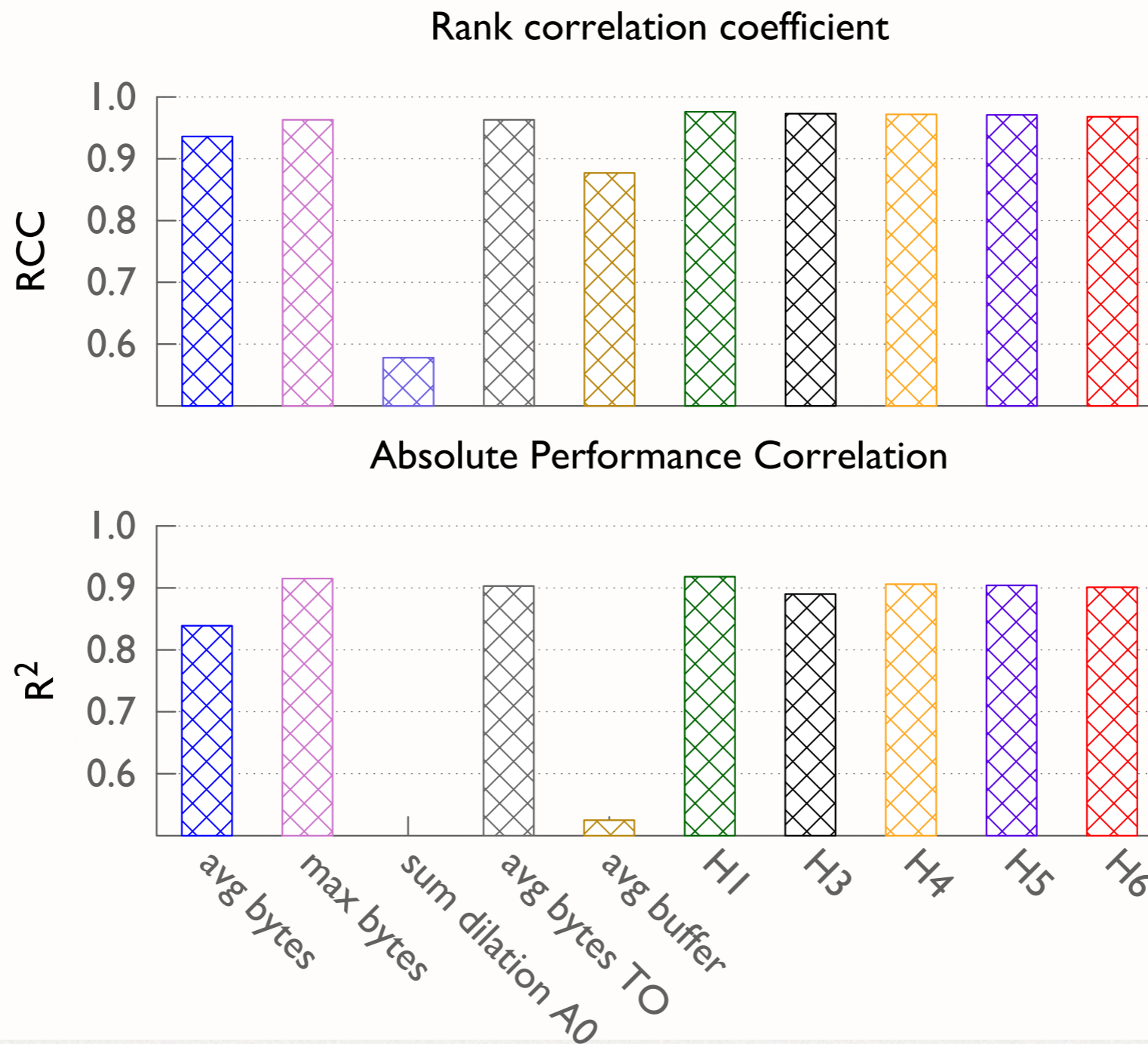

# RESULTS: PF3D

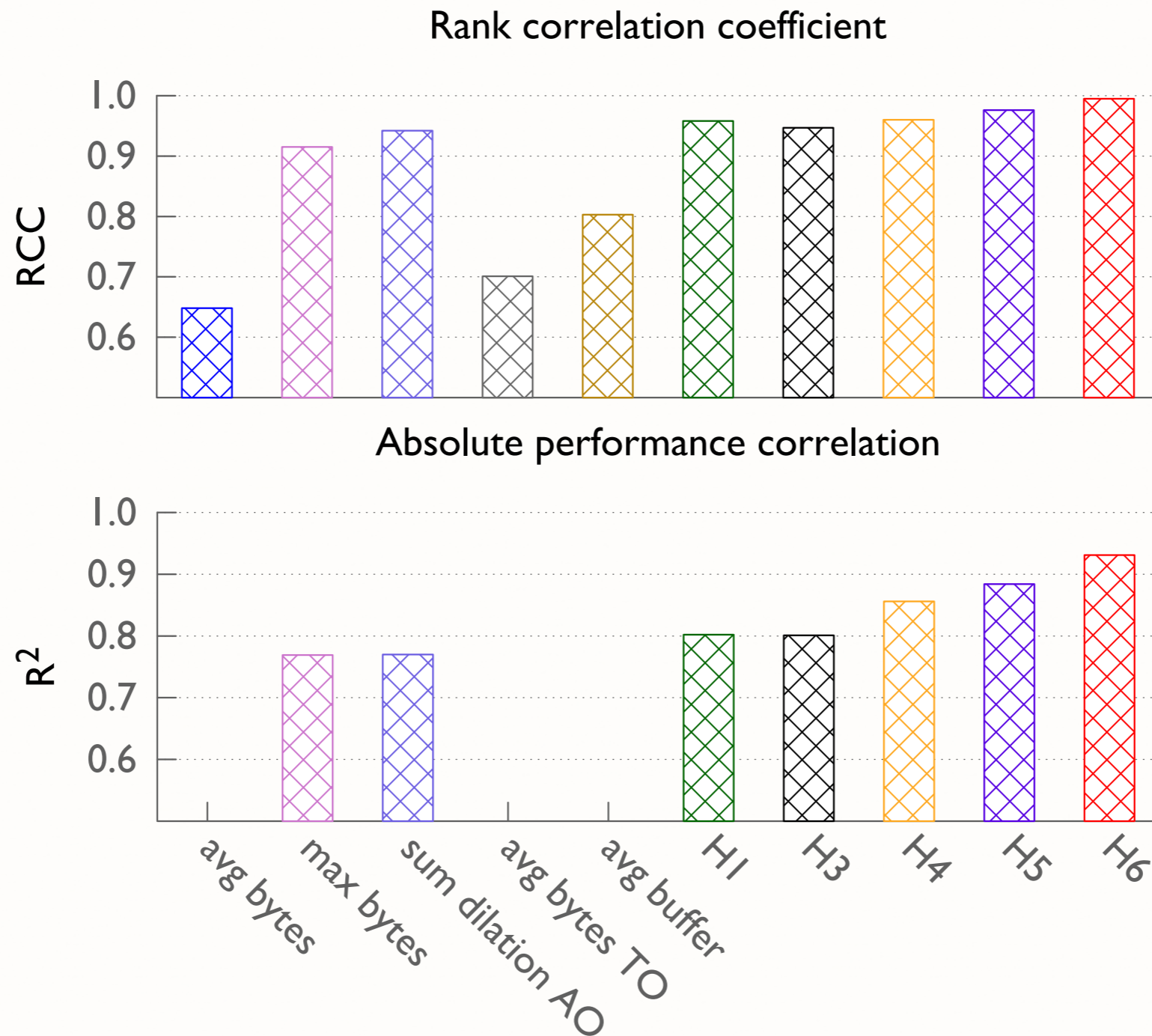

# RESULTS: PF3D

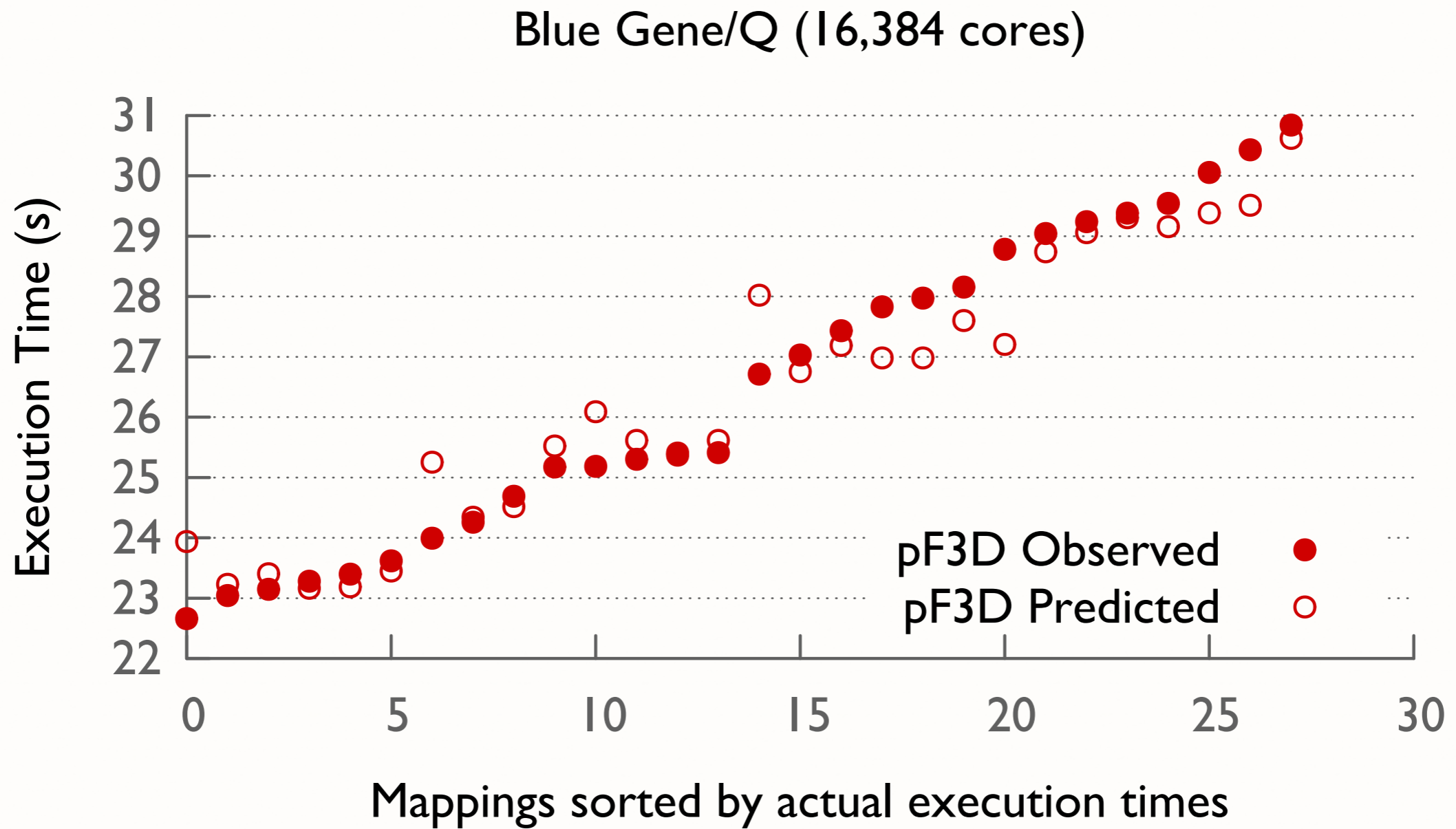

# SUMMARY

- Communication is not just about peak latency / bandwidth
- Simultaneous analysis of various aspects of network is important
- Complex models are required for accurate prediction
- There are patterns waiting to be identified!

# FUTURE WORK

- More applications!
- More metrics
- Weighted analysis
- Offline prediction of entities

Questions?