

The Coming Era of *Adaptive Control Systems* in HPC

Laxmikant (Sanjay) Kale

<http://charm.cs.illinois.edu>

Just as I was preparing this

- I read an abstract of a talk yesterday:
 - “Supercomputing has had two “easy” decades”
 - where most of the increased performance of supercomputers came from the increase in uniprocessor performance
- I thought we were having fun these decades
 - But not because it was easy
- But then, I trust Marc Snir (who said this)..
 - And he did put those quotes
 - So, it means its going to get even harder
 - We all know why: sophisticated apps, complex machines
 - More fun, and more employment!



What *control systems* am I talking about?

- Runtime Systems?
- Java runtime:
 - JVM + Java class library
 - Implements JAVA API
- MPI runtime:
 - Implements MPI standard API
 - Mostly mechanisms
- I want to focus on runtimes that are “smart”
 - i.e. include strategies in addition to mechanisms
 - Many mechanisms to enable adaptive strategies



Why?

And what kind of adaptive
runtime system I have in
mind?

Let us take a detour



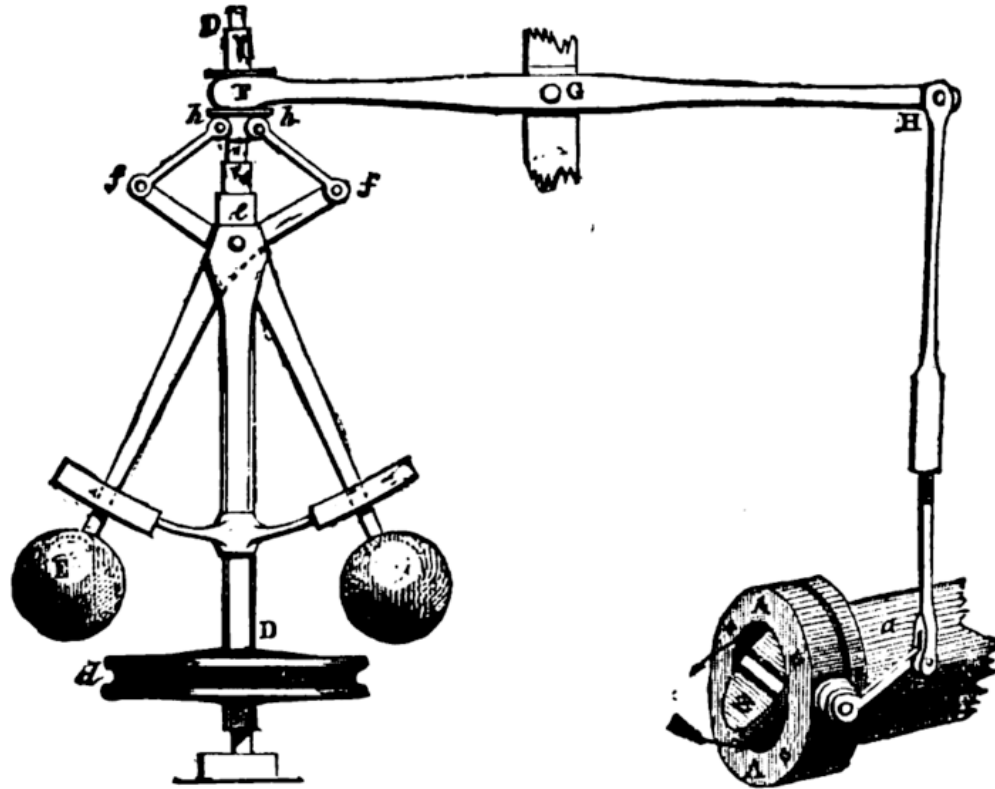

FIG. 4.—Governor and Throttle-Valve.

Source: Wikipedia

Governors

- Around 1788 AD, James Watt and Mathew Boulton solved a problem with their steam engine
 - They added a cruise control... well, RPM control
 - How to make the motor spin at the same constant speed
 - If it spins faster, the large masses move outwards
 - This moves a throttle valve so less steam is allowed in to push the prime mover



Feedback Control Systems Theory

- This was interesting:
 - You let the system “misbehave”, and use that misbehavior to correct it..
 - Of course, there is a time-lag here
 - Later Maxwell wrote a paper about this, giving impetus to the area of “control theory”

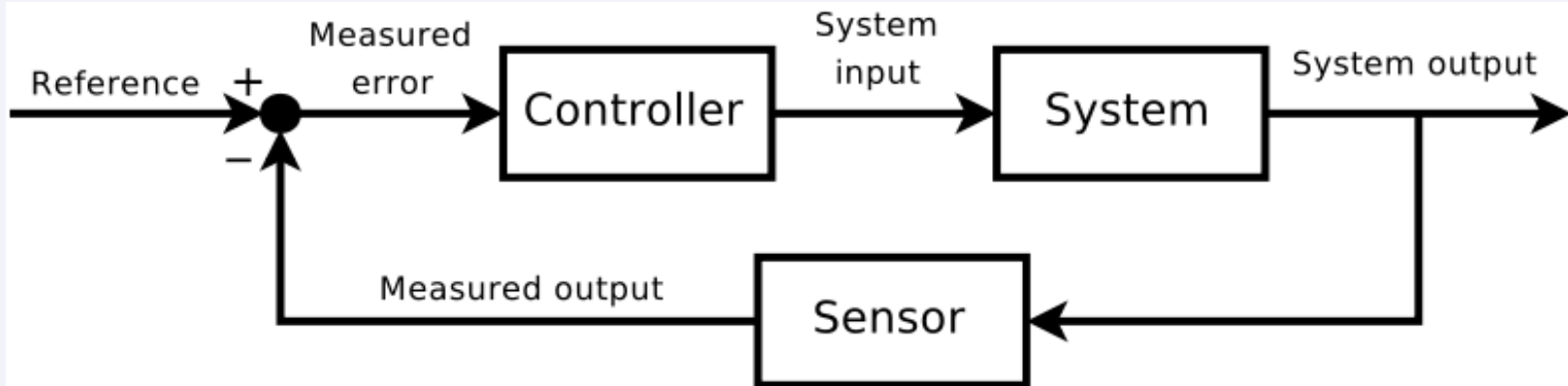

Source: Wikipedia



Control theory

- The control theory was concerned with stability, and related issues
 - Fixed delay makes for highly analyzable system with good math demonstration
- We will just take the basic diagram and two related notions:
 - Controllability
 - Observability



A modified system diagram

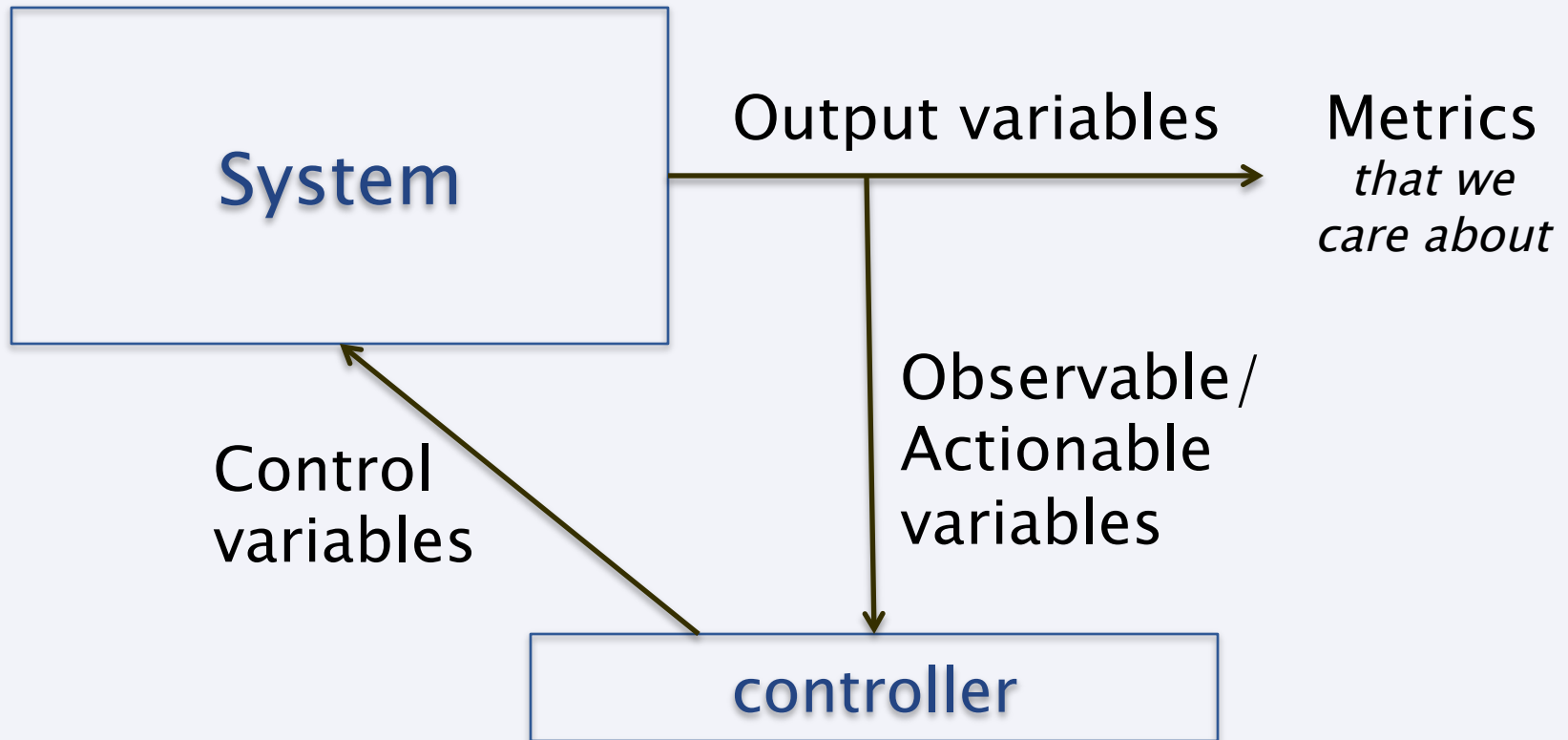

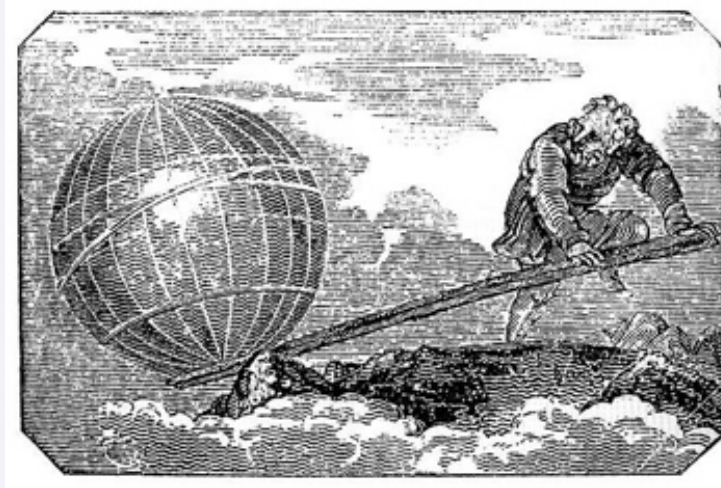

Source: Wikipedia

Archimedes is supposed to have said, of the lever:
Give me a place to stand on,
and I will move the Earth



Need to have the lever

- **Observability:**
 - If we can't observe it, can't act on it
- **Controllability:**
 - If no appropriate control variable is available, we can't control the system
 - (bending the definition a bit)
- **So: an effective control system needs to have a rich set of observable and controllable variables**



A modified system diagram

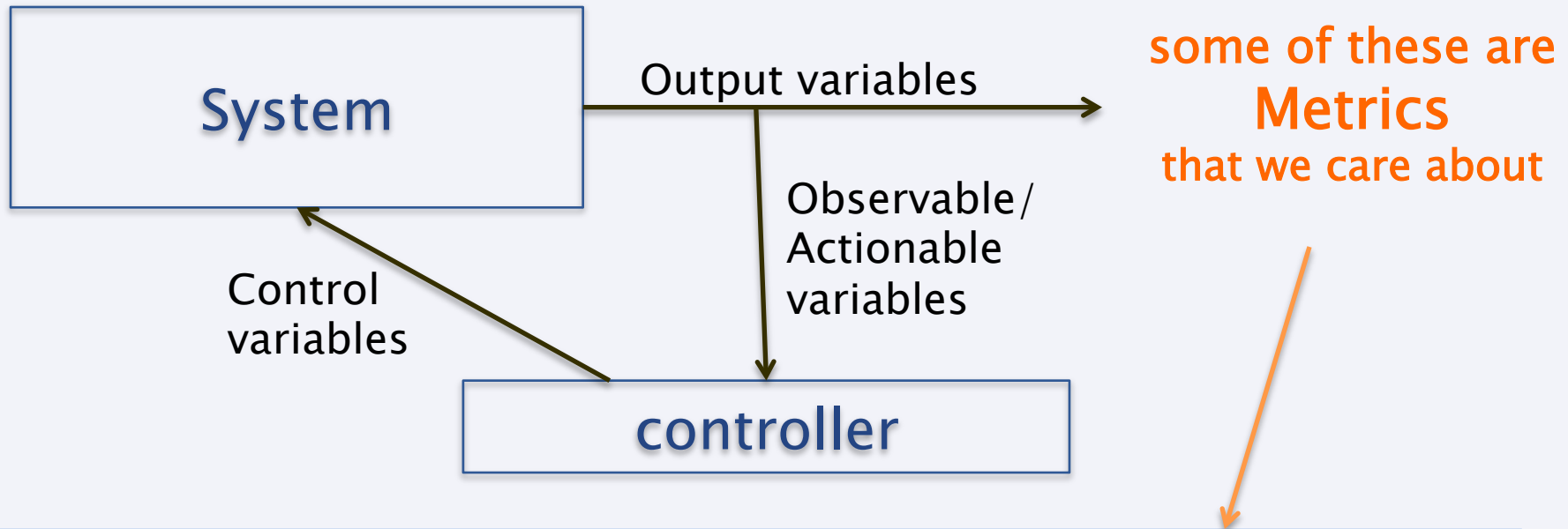

These include one or more:

- Objective functions (minimize, maximize, optimize)
- Constraints: “must be less than”, ..



Feedback Control Systems in HPC?

- Let us consider two “systems”
 - And examine them for opportunities for feedback control
- A parallel “job”
 - A single application running in some partition
- A parallel machine
 - Running multiple jobs from a queue



A Single Job

- System output variables that we care about:
 - (Other than the job's science output)
 - Execution time, energy, power, memory usage, ..
 - First two are objective functions
 - Next two are (typically) constraints
 - We will talk about other variables as well, later
- What are the observables?
 - Maybe message sizes, rates? Communication graphs?
- What are the control variables?
 - Very few. Maybe MPI buffer size? Bigpages?



Control System for a single job?

- Hard to do, mainly because of the paucity of control variables
- This was a problem with “Autopilot”, Dan Reed’s otherwise exemplary research project
 - Sensors, actuators and controllers could be defined, but the underlying system did not present opportunities
- We need to “open up” the single job to expose more controllable knobs



Alternatives

- Each job has its own ARTS control system, for sure
- But should this be:
 - Specially written for that application?
 - A common code base?
 - A framework or DSL that includes an ARTS?
- This is an open question, I think..
 - But it must be capable of interacting with the machine-level control system
- My opinion:
 - Common RTS, but specializable for each application



The Whole Parallel Machine

- Consists of nodes, job scheduler, resource allocator, job queue, ..
- Output variables:
 - Throughput, energy bill, energy per unit of work, power, availability, reliability, ..
- Again, very little control
 - About the only decision we make is which job to run next, and which nodes to give to it..
 - Maybe a few more ideas now, in the context of energy:
 - How many nodes to leave idle
 - What power limit to assign to a job



The Big Question/s:

How to add more control variables?

How to add more observables?

And then, how to build a powerful adaptive control system?



It so happens 😊

- My group's research over the past 15–20 years can be thought of as a quest to add more observables and control variables
 - Programming models, languages, libraries, including:
 - Charm++, AMPI, Charisma, MSA, Charj,
- Now, I'd like to consolidate the experience and knowledge gained, and express it in a new *abstract programming model*



XMAPP

- XMAPP is an abstract programming model:
 - That means it characterizes a set of prog. models
- For a programming model to belong to this set, it must support
 - X: Overdecomposition
 - (as in: 8X objects than cores)
 - M: Migratability
 - A: Asynchrony
 - and Adaptivity, as a consequence of all the above
- So, XMAPP stands for:
 - Overdecomposition-based Migratability, Asynchrony and Adaptivity in Parallel Programming



Members of XMAPP-class

- The programming models in XMAPP, or exhibit some features of it
 - Charm++
 - Adaptive MPI
 - KAAPI
 - ProActive
 - FG-MPI (if it adds migration)
 - HPX (once it embraces migratability)
 - ParSEC
 - CnC
 - MSA (multi-phase Shared arrays)
 - Charisma
 - Charj
 - DRMS (old abstraction from IBM research..)
 - Chapel: may be a higher level model
 - X10: has asynchrony, but not migratable units
 - Tascel

Also, general work on adaptivity is relevant: Trilinos, Hank Hoffman/UIUC, ...



Over-decomposition

- Let the programmer decompose a computation into entities
 - Work units, data-units, composites
 - Into *coarse-grained* set of objects
 - Independent of number of processors
- Let the entities communicate with each other without reference to processors
 - So each entity is like a virtual processor by itself
- Let an intelligent runtime system assign these entities to processors
 - RTS can change this assignment during execution
- This empowers the control system
 - A large number of observables
 - Many control variables created



Grainsize

- It is important to understand what I mean by coarse-grained entities
 - You don't write sequential programs that some system will auto-decompose
 - You don't write programs when there is one object for each *float*
 - You consciously choose a grainsize, BUT choose it independent of the number of processors
 - Or parameterize it, so you can tune later



Crack Propagation

This is 2D, circa 2002...
but shows over-decomposition for unstructured meshes..

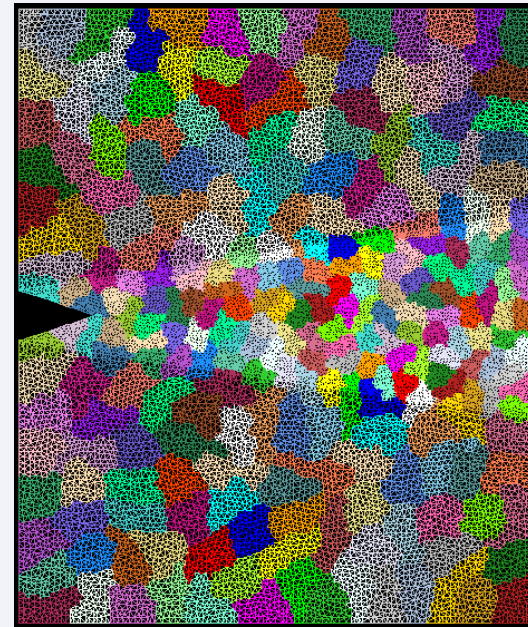
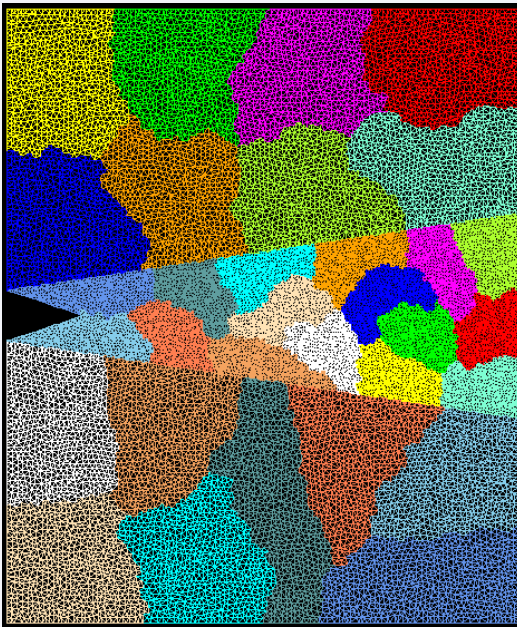

Decomposition into 16 chunks (left) and 128 chunks, 8 for each PE (right). The middle area contains cohesive elements. Both decompositions obtained using Metis. Pictures: S. Breitenfeld, and P. Geubelle



Grainsize example: NAMMD

- High Performing examples: (objects are the work-data units in Charm++)
- On Blue Waters, 100M atom simulation,
 - 128K cores (4K nodes), 5,510,202 objects
- Edison, Apoa1 (92K atoms)
 - 4K cores , 33124 objects
- Hopper, STMV, 1M atoms,
 - 15,360 cores, 430,612 objects



Grainsize: Weather Forecasting in BRAMS

- Brams: Brazillian weather code (based on RAMS)
- AMPI version (Eduardo Rodrigues, with Mendes , J. Panetta, ..)

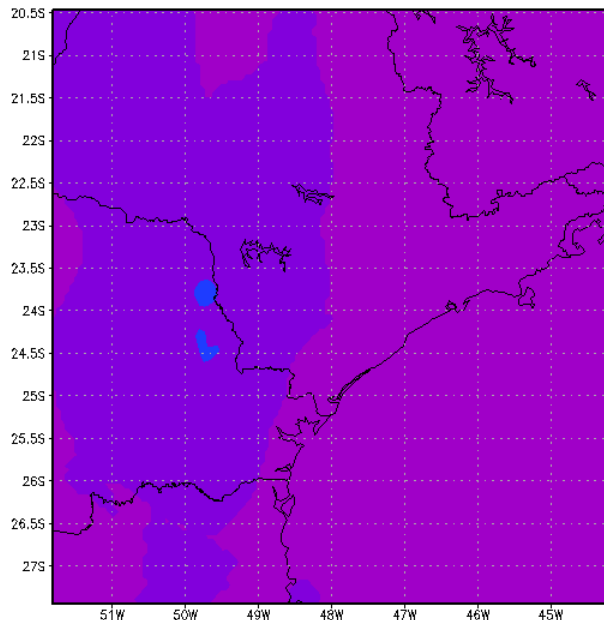

2010-02-18-09:46 GrADS: OOLA/IGES



2010-02-18-10:00



Instead of using 64 work units on 64 cores, used 1024 on 64



Working definition of grainsize :
amount of computation per remote interaction

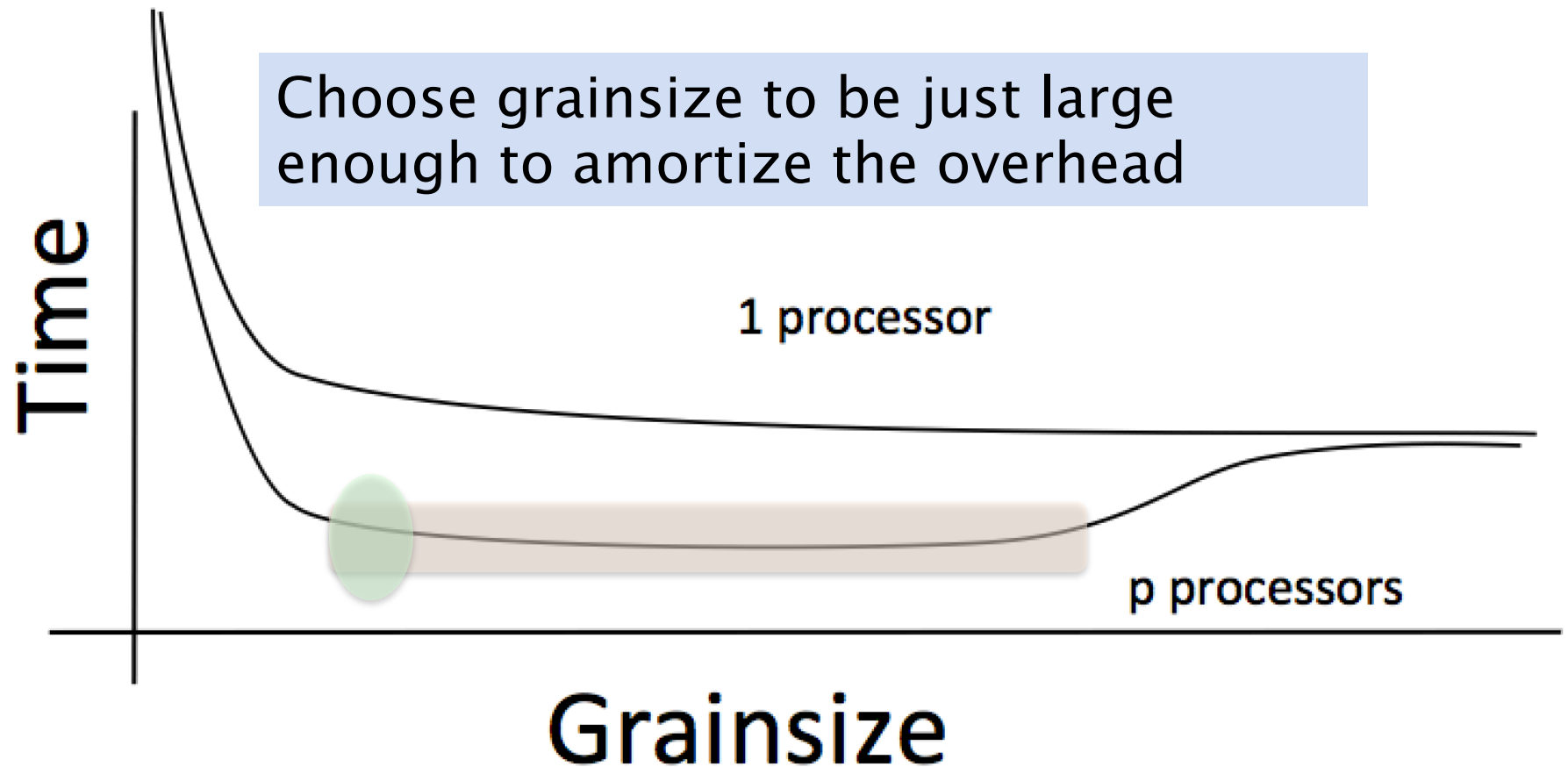

Grainsize in a common setting

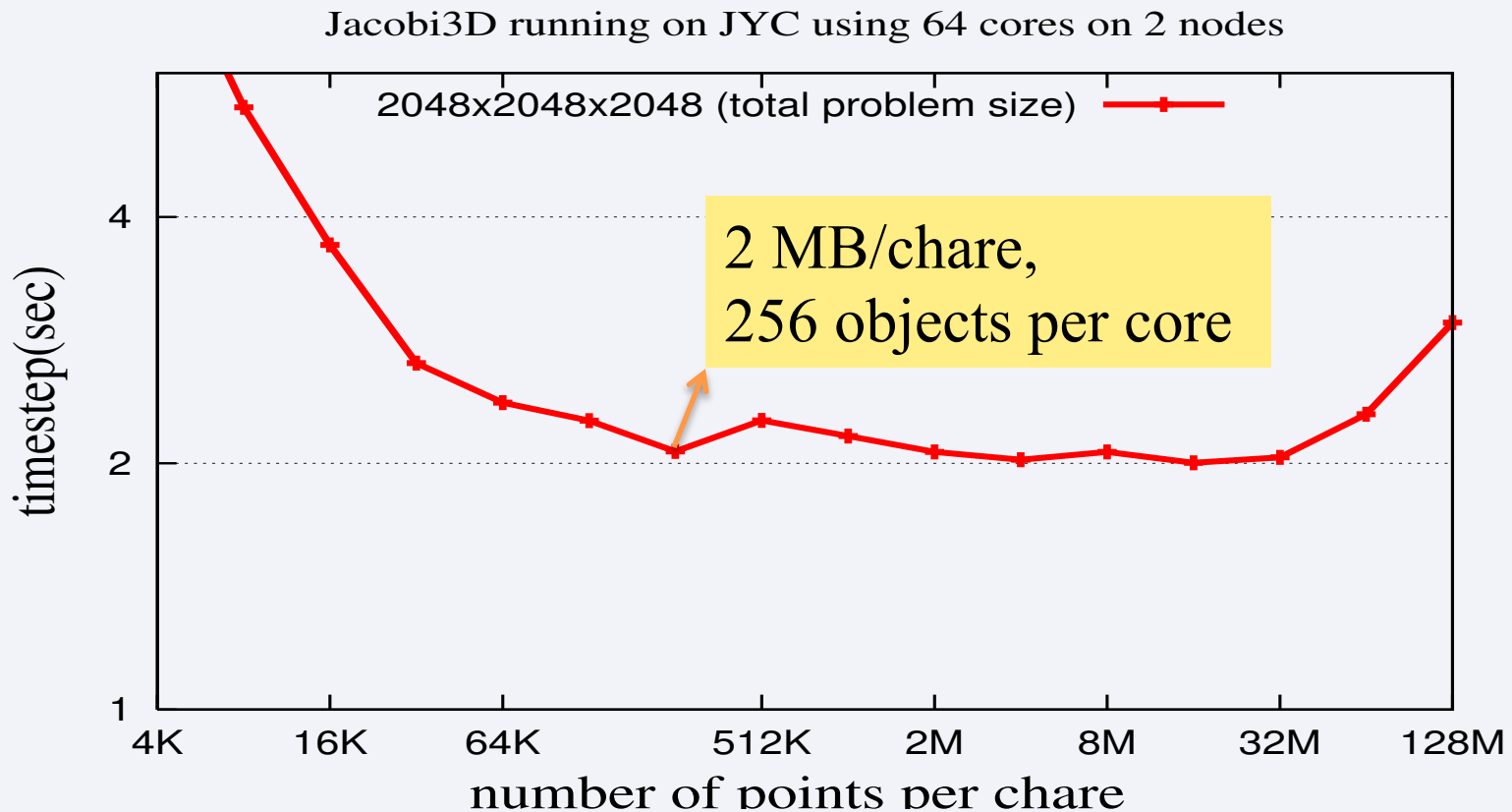

Impact on communication

- Current use of communication network:
 - Compute–communicate cycles in typical MPI apps
 - So, the network is used for a fraction of time,
 - and is on the critical path
- So, current *communication networks are over-engineered for by necessity*

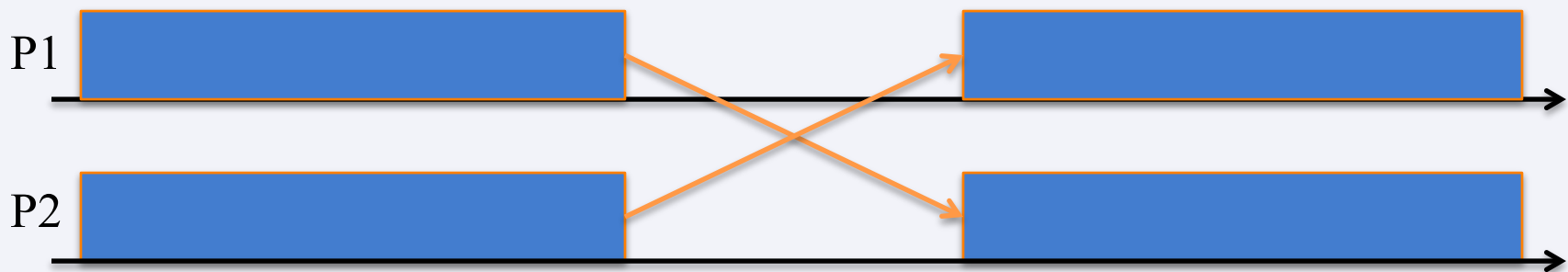

BSP based application



Impact on communication

- With overdecomposition
 - Communication is spread over an iteration
 - Also, adaptive overlap of communication and computation

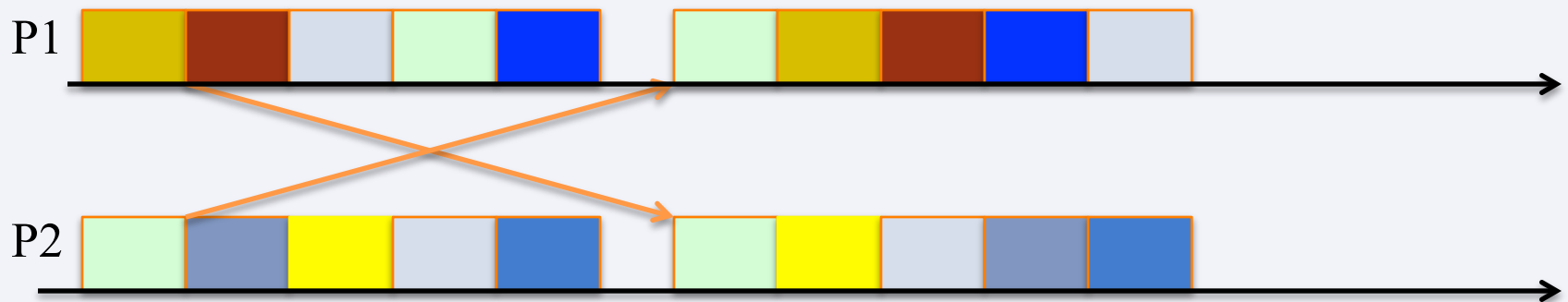

Overdecomposition enables overlap



Object-based over-decomposition: Charm++

- Multiple “indexed collections” of C++ objects
- Indices can be multi-dimensional and/or sparse
- Programmer expresses communication between objects
 - with no reference to processors

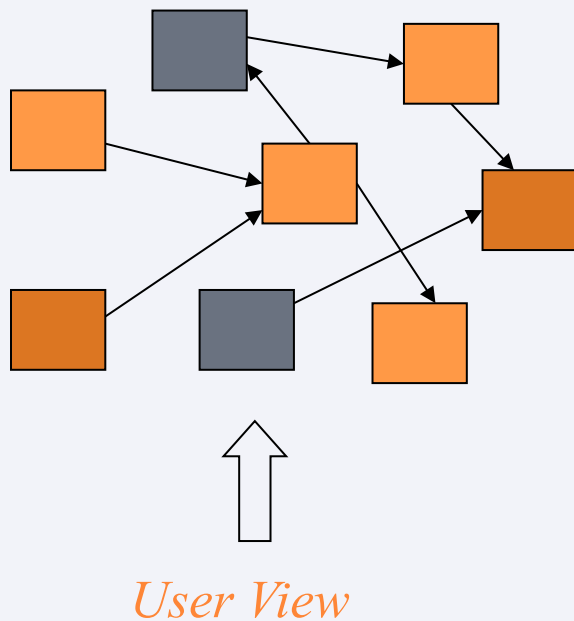

System implementation

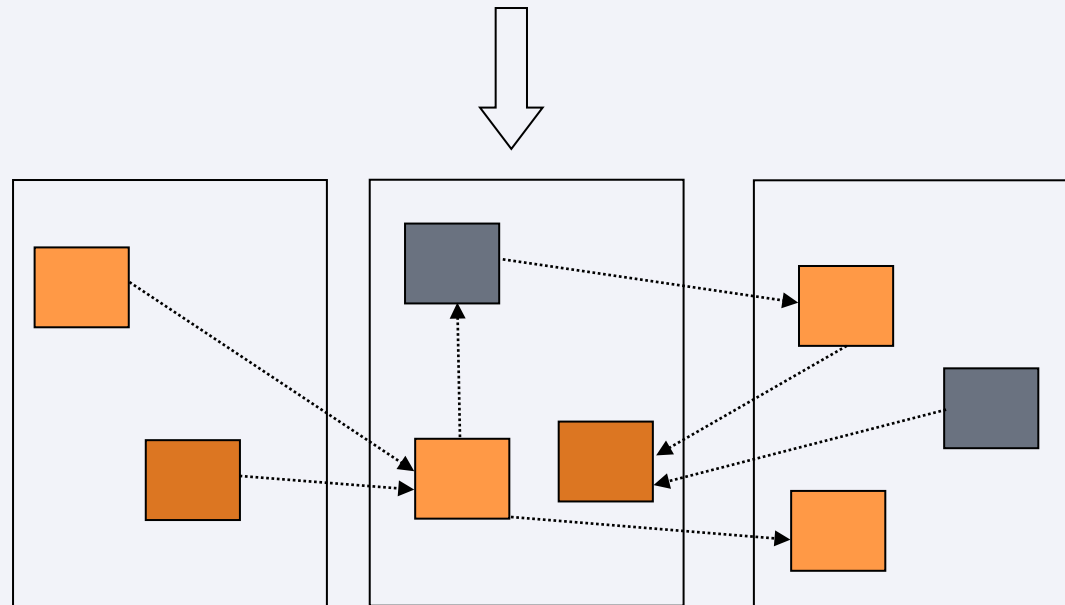

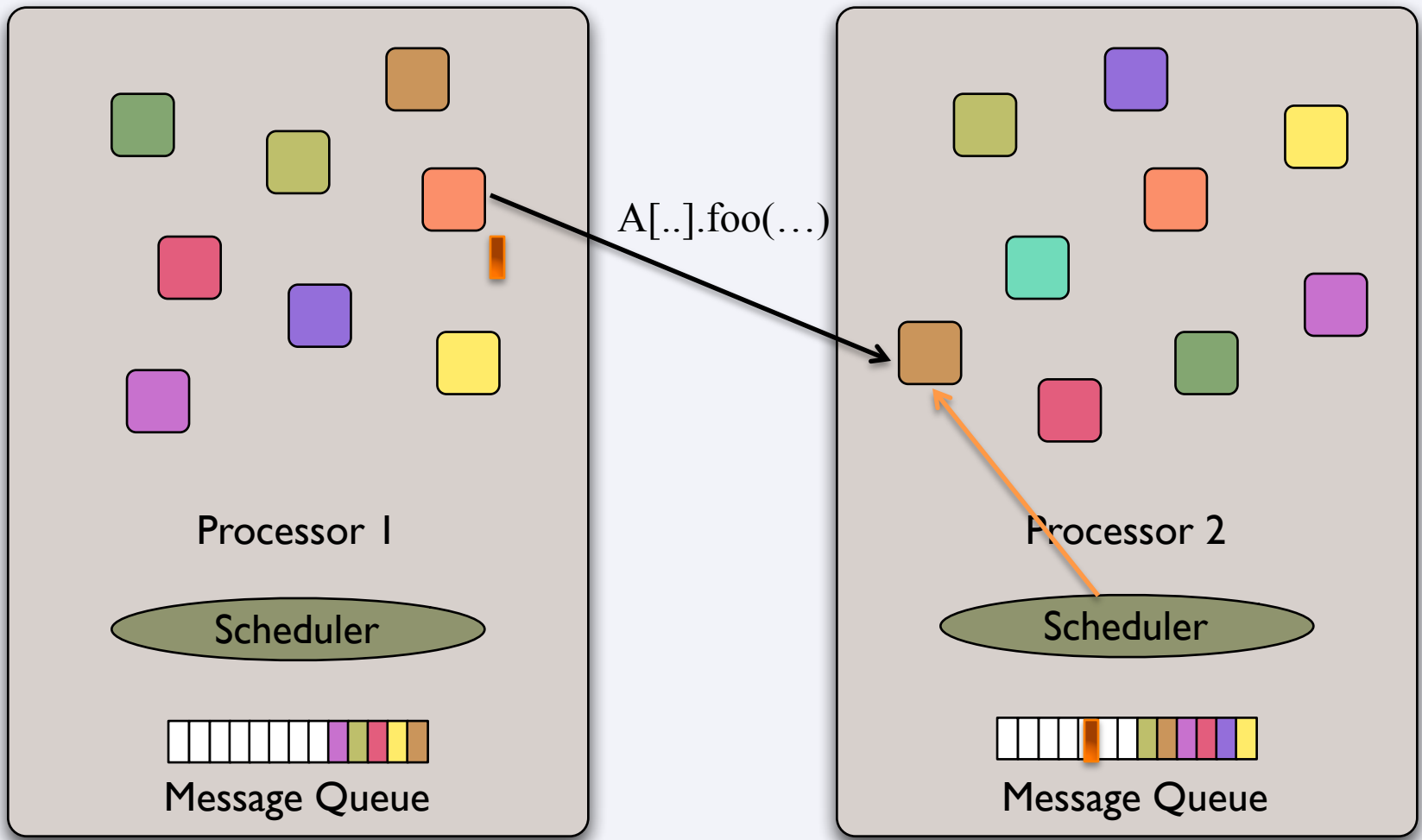

Note the control points created

- Scheduling (sequencing) of multiple method invocations waiting in scheduler's queue
- Observed variables: execution time, object communication graph (who talks to whom)
- Migration of objects
 - System can move them to different processors at will, because..
- This is already very rich...
 - What can we do with that??



Optimizations Enabled/Enhanced by These New Control Variables

- Communication optimization
- Load balancing
- Meta-balancer
- Heterogeneous Load balancing
- Power/temperature/energy optimizations
- Resilience
- Shrink/Expand sets of nodes
- Application reconfiguration to add control points
- Adapting to memory capacity



Principle of Persistence

- Once the computation is expressed in terms of its natural (migratable) objects
- *Computational loads and communication patterns tend to persist, even in dynamic computations*
- So, recent past is a good predictor of near future

In spite of increase in irregularity and adaptivity, this principle still applies at exascale, and is our main friend.



Measurement-based Load Balancing

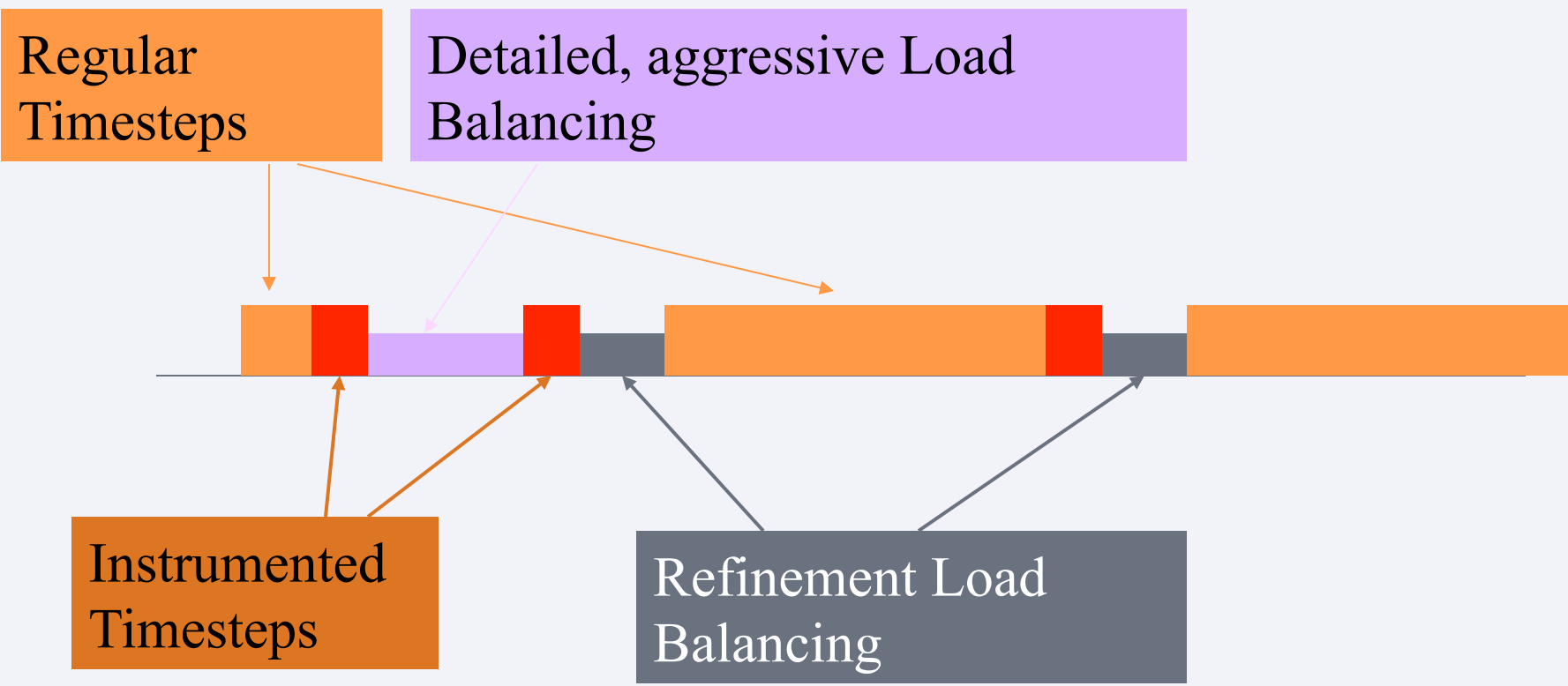

XMAPP ideas and features
have been demonstrated in
full-scale production
Charm++ applications



NAMD: Biomolecular simulations

- Collaboration with K. Schulten
- With over 45,000 registered users
- Scaled to most top US supercomputers
- In production use on supercomputers and clusters and desktops
- Gordon Bell award in 2002

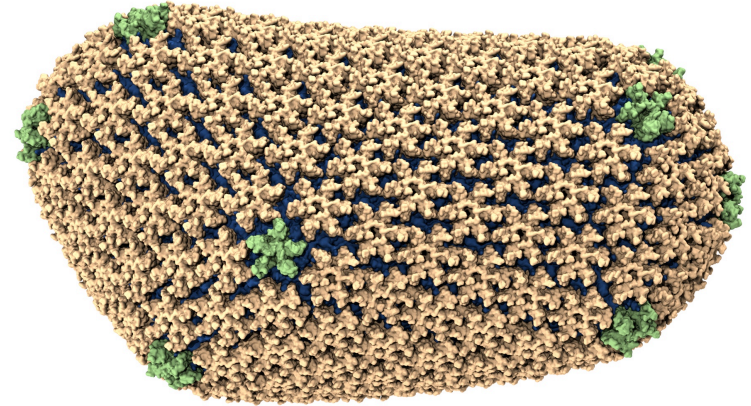

Recent success:
Determination of the
structure of HIV capsid
by researchers including
Prof Schulten



ChaNGa: Parallel Gravity

- Collaborative project (NSF)
 - with Tom Quinn, Univ. of Washington
- Gravity, gas dynamics
- Barnes–Hut tree codes
 - Oct tree is natural decomp
 - Geometry has better aspect ratios, so you “open” up fewer nodes
 - But is not used because it leads to bad load balance
 - Assumption: one-to-one map between sub-trees and PEs
 - Binary trees are considered better load balanced

Evolution of Universe and Galaxy Formation



With Charm++: use Oct-Tree, and let Charm++ map subtrees to processors



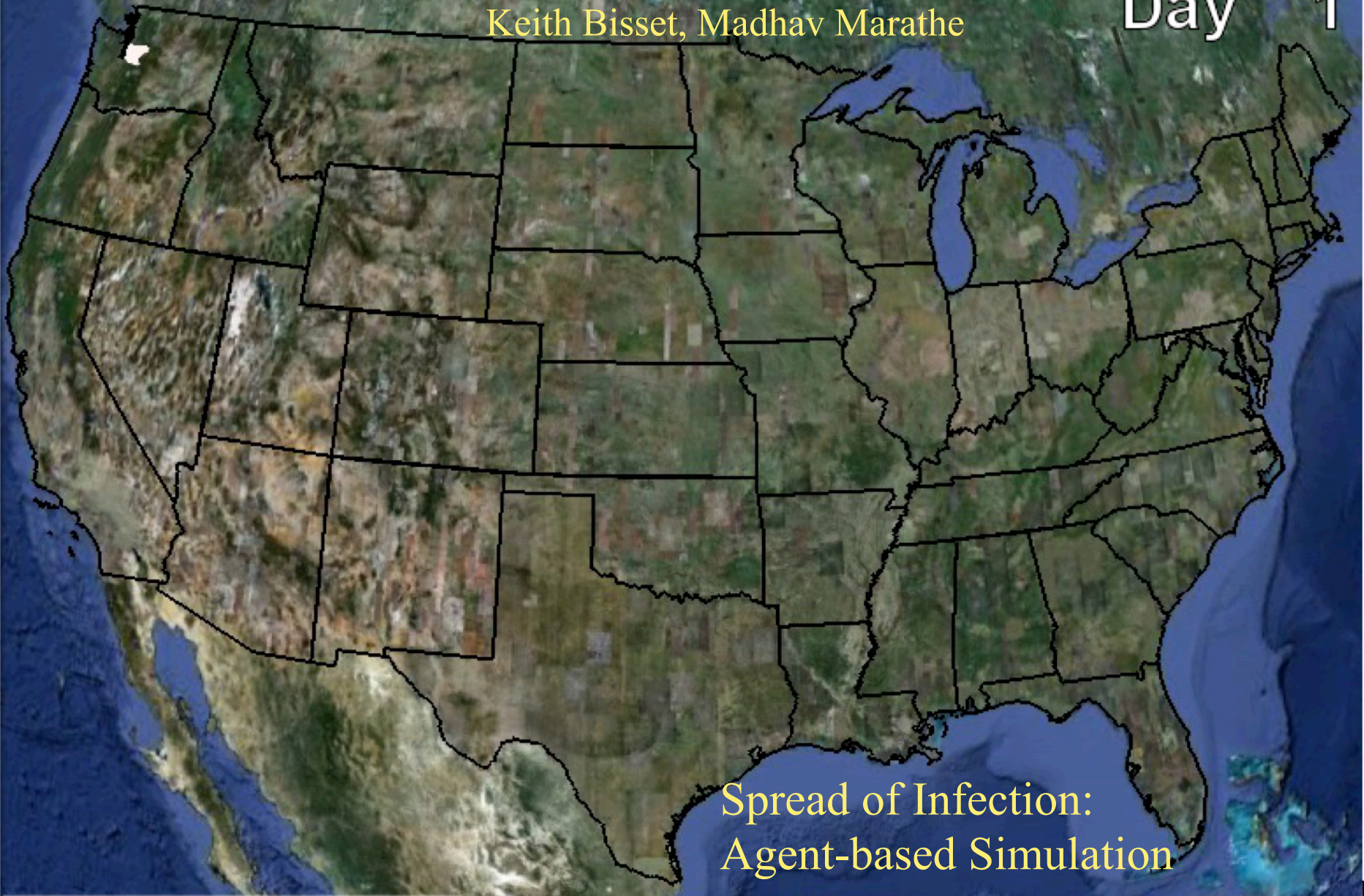

Spread of Infection:
Agent-based Simulation



Data SIO, NOAA, U.S. Navy, NGA, GEBCO
Image © 2011 TerraMetrics
Image USDA Farm Service Agency
© 2011 Cnes/Spot Image



Parallel Science and Engineering Applications
The Charm++ Approach

An upcoming book
Surveys seven
major applications
developed using
Charm++

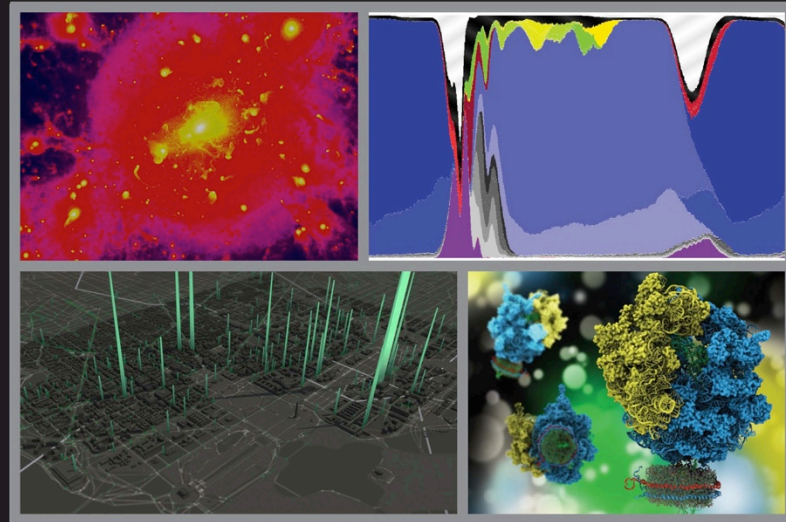

Edited by
Laxmikant V. Kale
Abhinav Bhatele



10/3/13



Saving Cooling Energy

- Easy: increase A/C setting
 - But: some cores may get too hot
- So, reduce frequency if temperature is high
 - Independently for each core or chip
- **But**, this creates a load imbalance!
- No problem, we can handle that
 - Migrate objects away from the slowed-down procs
 - Balance load using an existing strategy
 - Strategies take speed of processors into account
- Implemented in experimental version
 - SC 2011 paper, IEEE TC paper
- Several new power/energy-related strategies
 - PASA '12: Exploiting differential sensitivities of code segments to frequency change



Fault Tolerance in Charm++ /AMPI

- Four Approaches:
 - Disk-based checkpoint/restart
 - In-memory double checkpoint/restart
 - Proactive object migration
 - Message-logging *with parallel restart*: scalable fault tolerance
- Common Features:
 - Leverages object-migration capabilities
 - Based on dynamic runtime capabilities
- Several new results in the last year:
 - FTXS 2012: scalability of in-mem scheme
 - Hiding checkpoint overhead .. with semi-blocking..
 - Energy efficiency of FT protocols : best paper SBAC-PAD

Ships in Charm++
distribution, for years



Another idea for
increasing
controllable variables:

Reconfigurable
Applications



App based Creation of Control Points

- A richer set of control points can be generated if we enlist help from the application
 - Or its DSL runtime, or compiler
- The idea is:
 - Application exposes some control knobs
 - Describes the effects of the knobs
 - The RTS observes performance variables, identifies the knobs that will help the most, and turns them in the right direction
- Examples: granularity, yield frequencies in inner loops, CPU–Accelerator balance



Load Balancing Framework

- Charm++ load balancing framework is an example of “customizable” RTS
- Which strategy to use, and how often to call it, can be decided for each application separately
- But if the programmer exposes one more control point, we can do more:
 - Control point: iteration boundary
 - User makes a call each iteration saying they can migrate at that point
 - Let us see what we can do: metabalancer



Meta-Balancer

- Automating load balancing related decision making
- Monitors the application continuously
 - Asynchronous collection of minimum statistics
- Identifies when to invoke load balancing for optimal performance based on
 - Predicted load behavior and guiding principles
 - Performance in recent past



Fractography: Without LB

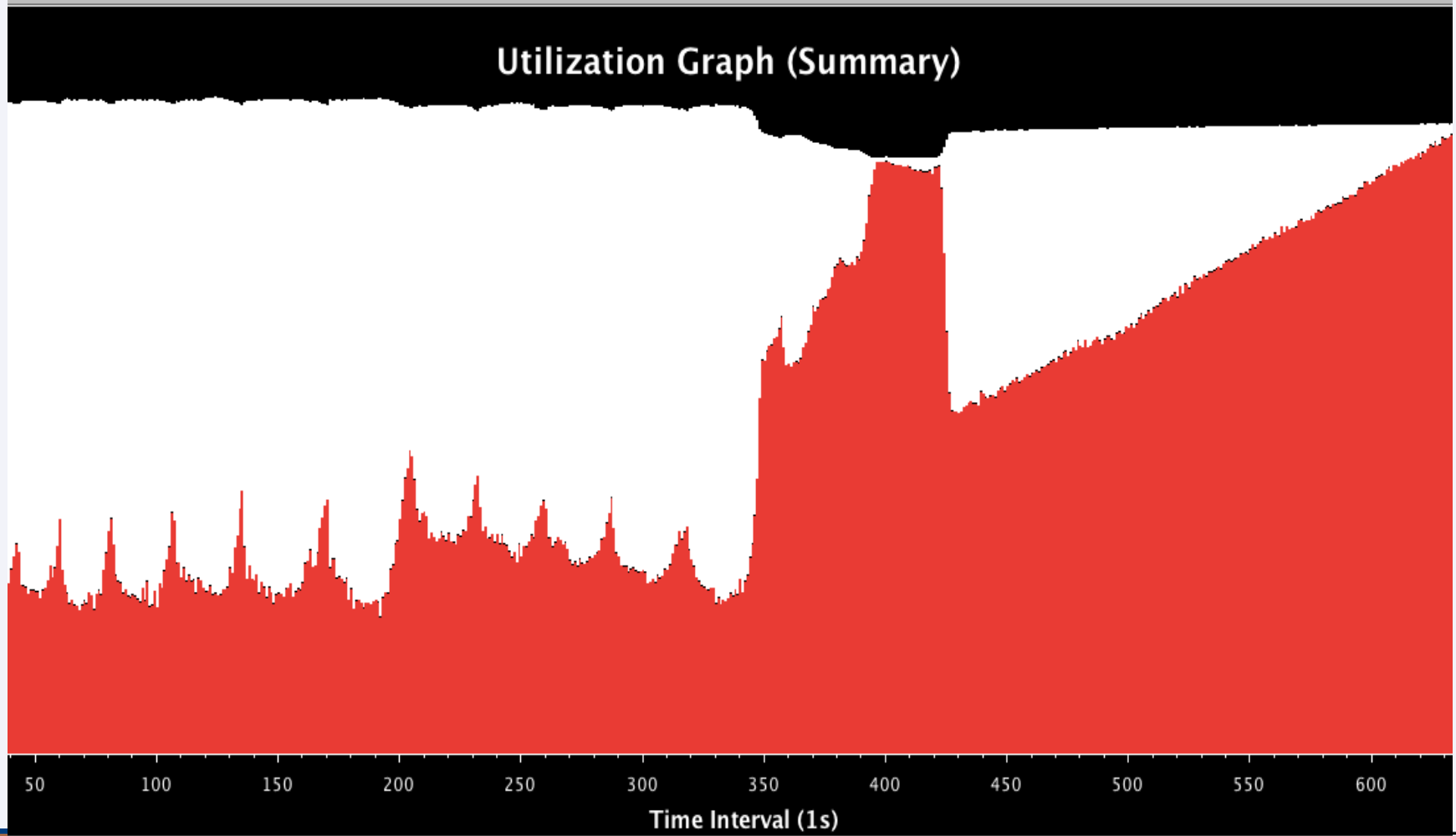

Meta-Balancer on Fractography

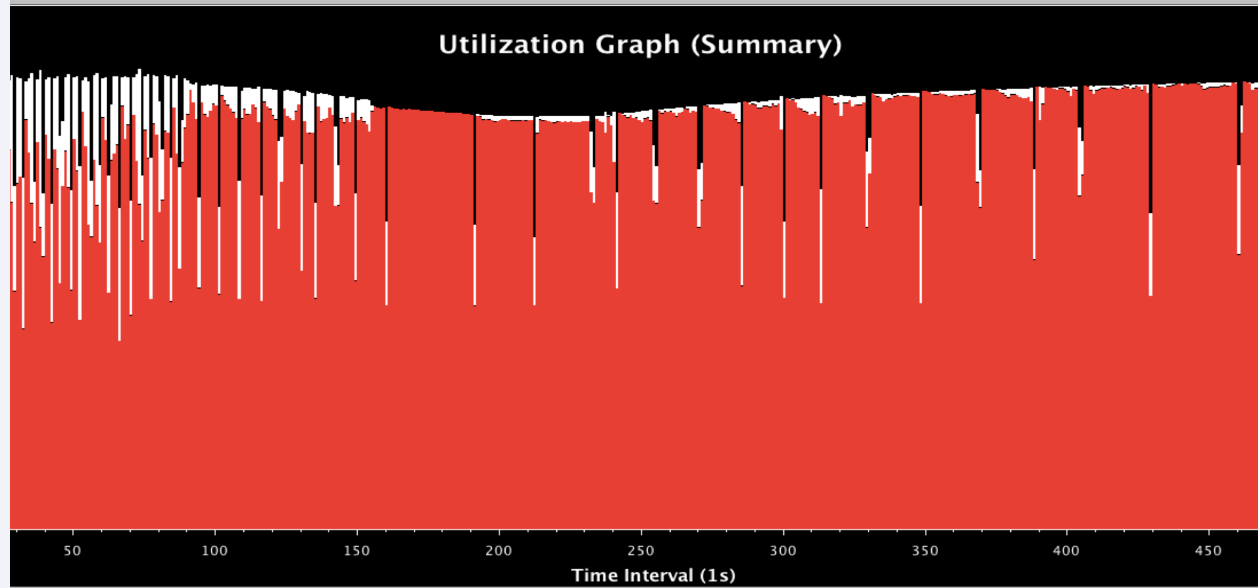

- Identifies the need for frequent load balancing in the beginning
- Frequency of load balancing decreases as load becomes balanced
- Increases overall processor utilization and gives gain of 31%



Shrink/Expand job

- If a job is told to reduce the number of nodes it is using..
- It can do so now by migrating objects..
- Same with expanding the set of nodes used
- Empowered by migratability



Inefficient Utilization within a cluster

16 Processor system

■ Job A

■ Job B

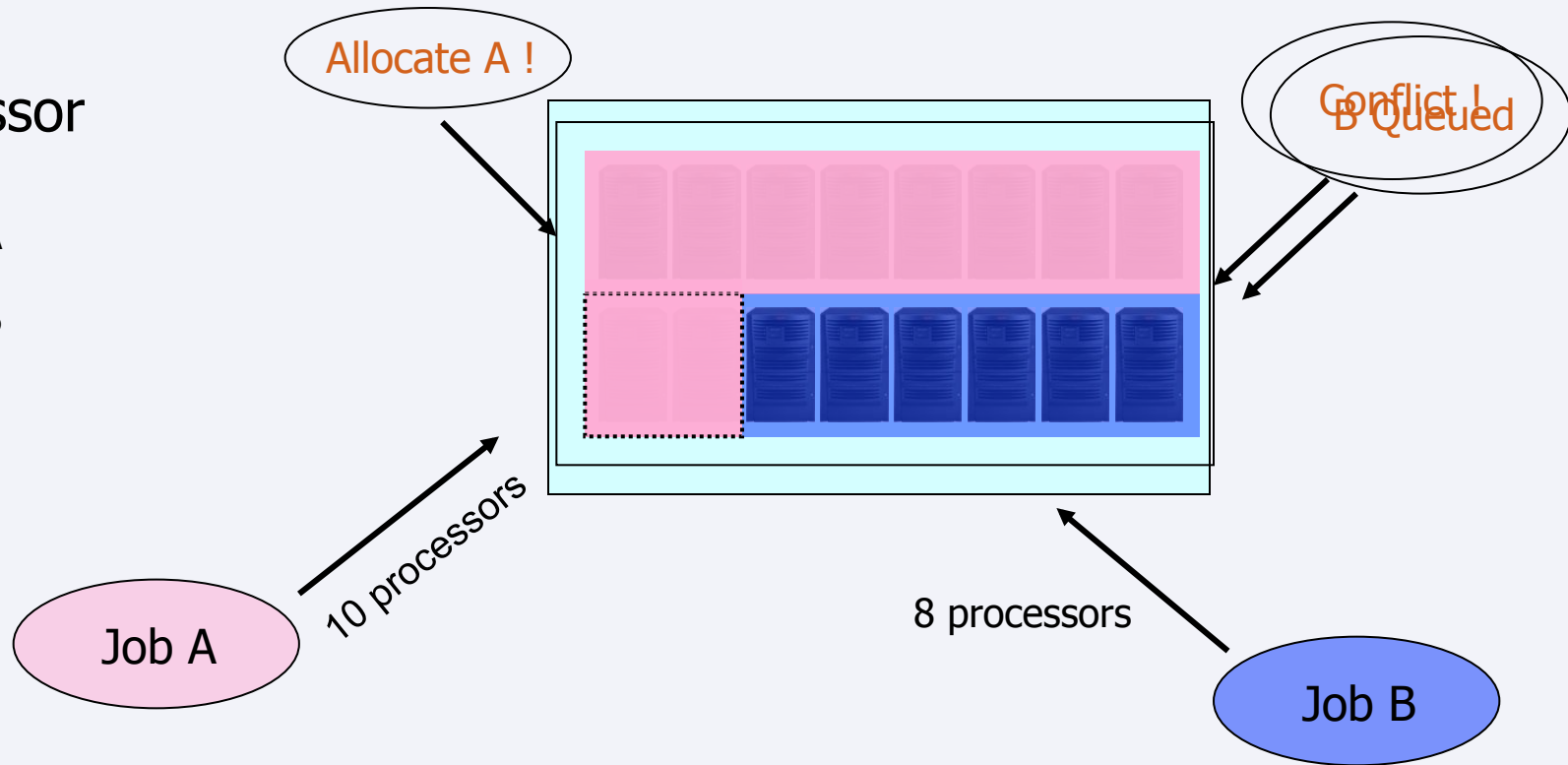

Current Job Schedulers can lead to low system utilization !



Adaptive Job Scheduler

- Scheduler can take advantage of the adaptivity of XMAPP jobs
- Improve system utilization and response time
- Scheduling decisions
 - Shrink existing jobs when a new job arrives
 - Expand jobs to use all processors when a job finishes
- Processor map sent to the job
 - Bit vector specifying which processors a job is allowed to use
 - 00011100 (use 3 4 and 5!)
- Handles regular (non-adaptive) jobs



Two Adaptive Jobs

16 Processor system

Job A

Job B

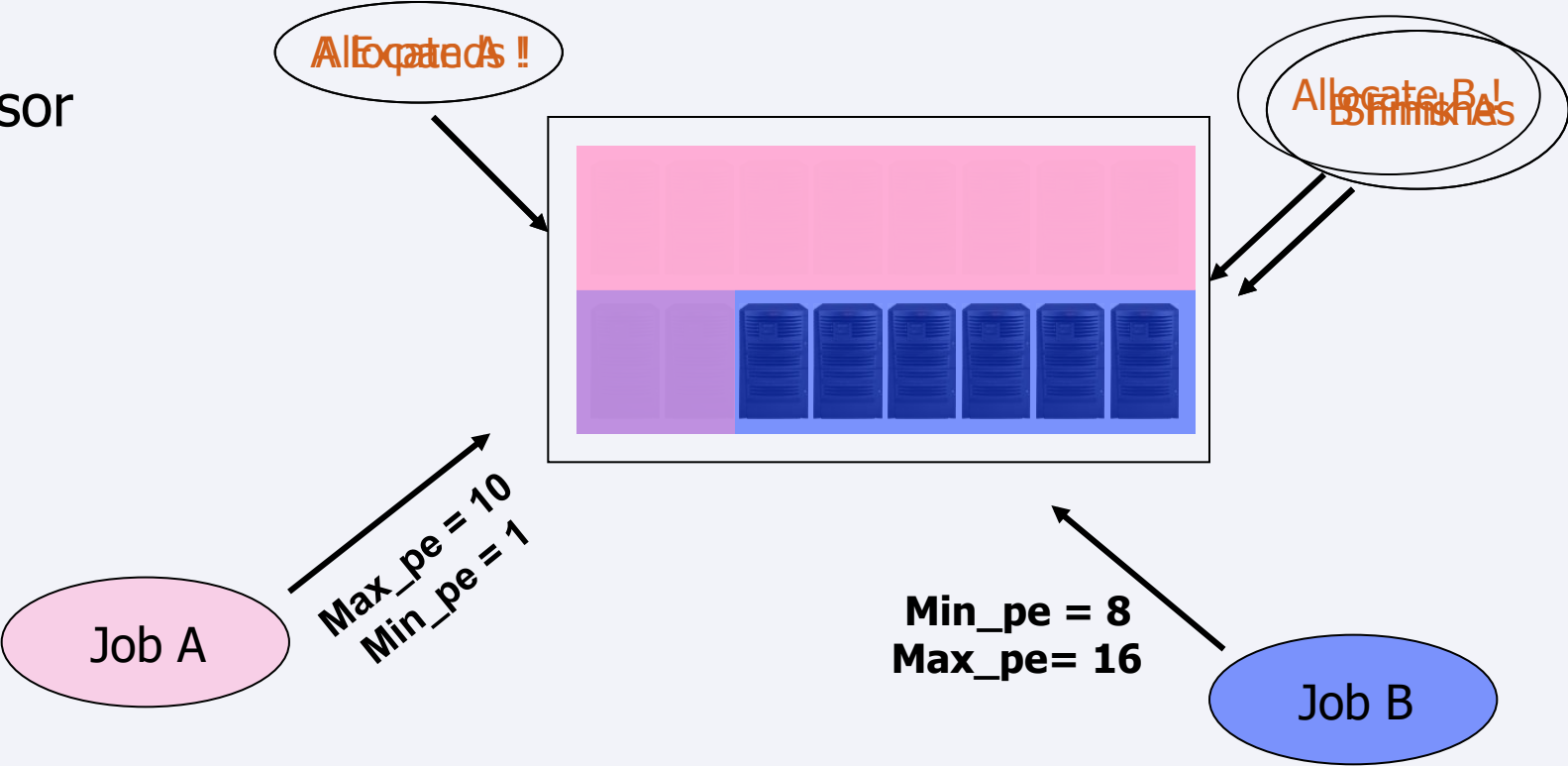

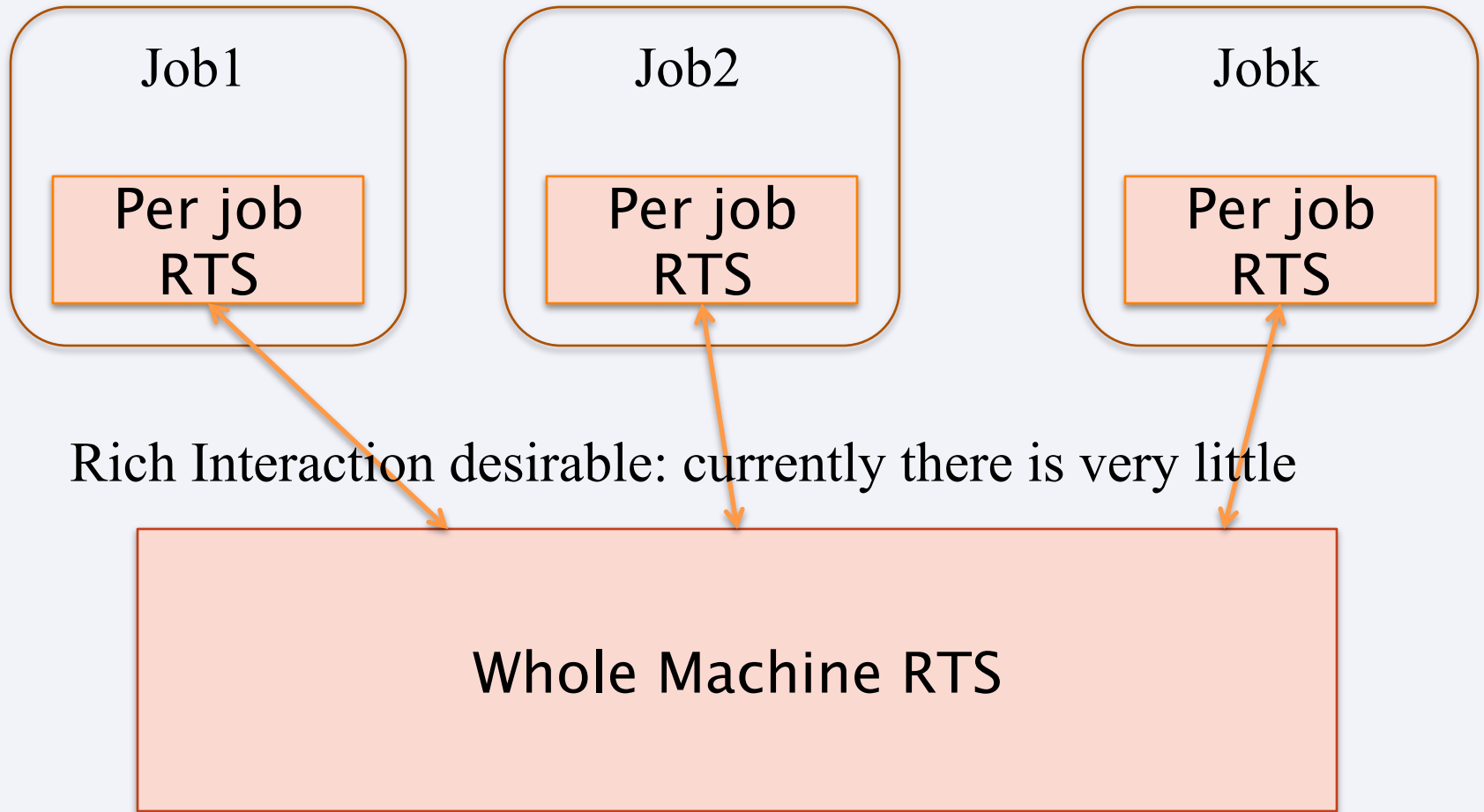

Rich Interaction desirable: currently there is very little

Whole Machine RTS



Whole machine runtime

- Job schedulers and resource allocators:
 - Accept more flexible QoS specifications from jobs
 - Creating more control variables
 - “moldable” specification:
 - This job needs between 3000–5000 nodes
 - Memory requirements..
 - Topology sensitivity, speedup profiles,...
 - Malleable:
 - this job can be told to shrink/expand after it has started



Whole machine control

- Monitor failures, and act in job-specific ways
- Global power constraints:
 - Inform, negotiate with and constrain jobs
- Thermal management
- I/O system and job I/O interactions
- Shrink and Expand jobs as needed to optimize multiple metrics



Novel, Revolutionary and Old?

- These concepts have been around for a while
 - E.g. Charm++ even in the present form is 13–15 years old
- An analogy might help



Dinosaurs, mammals and primates

- When the asteroid created a shock to the ecosystem
 - For us, multiple asteroids together:
 - End of frequency scaling,
 - Complex heterogeneous hardware,
 - Thermal, power, energy issues,
 - Component failures
 - increasingly complex apps
 - Dinosaurs (well.. MPI) and mammals (XMAPP) both existed
 - But dinosaurs died out, mammals survived, and evolved further
 - The premium on “smart” rather than “big” in the ecosystem eventually saw the emergence of humans
 - Well.. Bending the truth a bit for the sake of analogy
 - Well, dinosaurs survived as birds... maybe MPI 5?



XMAPP models: adoption

- It is challenging to get the community to adopt a new programming model
 - And here we are talking about a whole class of them!
- It helps
 - To get a few from-scratch success stories
 - Some apps may get “refactored” to use the new model (Episimdemics)
- But large-scale adoption will be helped if we can support true “interoperability”



Interoperation of Parallel Languages

- Implement a library in the language that suits it the most, and use them together!
- MPI + UPC, MPI + OpenMP + Charm++

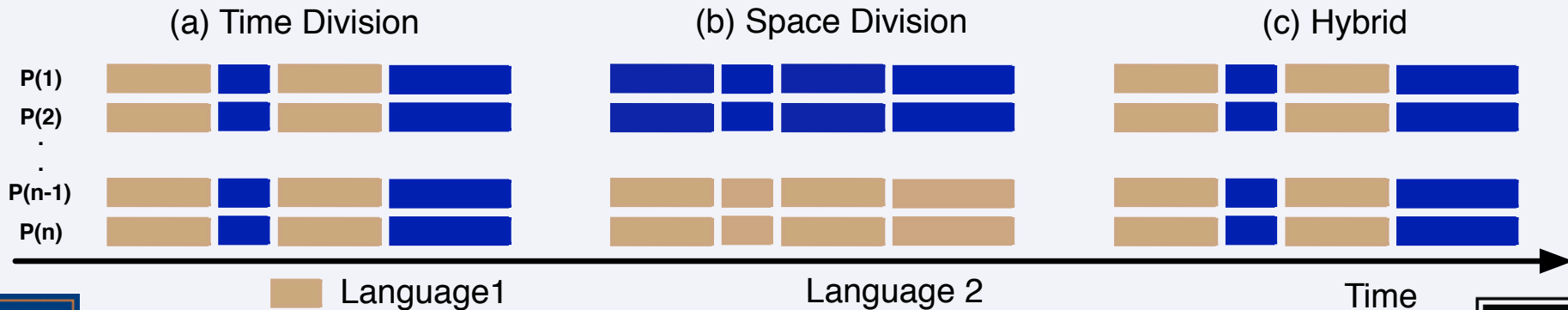
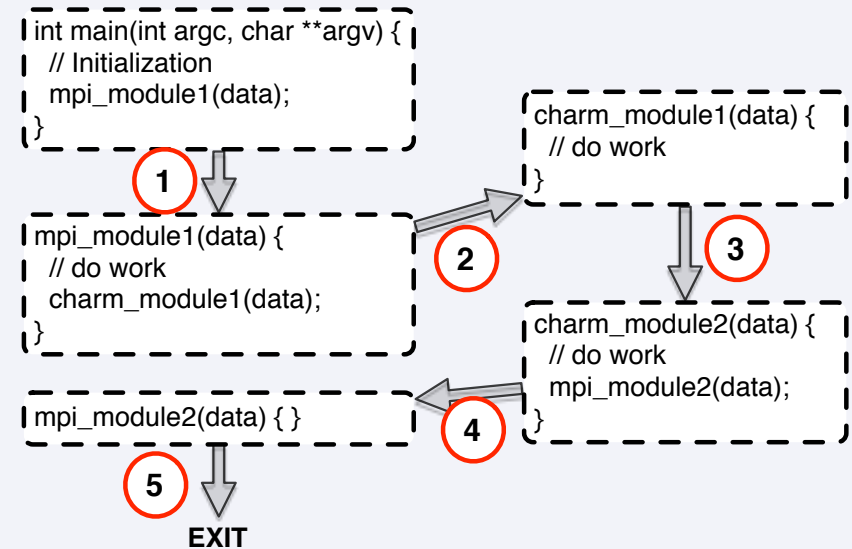

Is Interoperation Feasible in Production Applications?

Application	Library	Productivity	Performance
CHARM in MPI (on Chombo)	HistSort in Charm++	195 lines removed	48x speed up in Sorting
EpiSimdemics	MPI IO	Write to single file	256x faster input
NAMD	FFTW	280 lines less	Similar performance
Charm++'s Load Balancing	ParMETIS	Parallel graph partitioning	Faster applications



Conclusions

- We need a much richer control system
 - For each parallel job
 - For parallel machine as a whole
- Current status: paucity of control variables
- Programming models can help create new observable and controllable variables
- As far as I can see,
 - XMAPP class programming models, with overdecomposition and migratability, and the resultant asynchrony and adaptivity are the main vehicle for this..
 - Do you see other ideas?



Conclusion

- HPC community suggestions:
 - Develop new XMAPP models
 - But: make sure you develop it in the context of at least two reasonable-size applications
 - Collaborate and compete on runtime adaptation strategies, based on the common assumptions of XMAPP models
 - Possibly develop standards for mature pieces

I am looking for a postdoc
and/or a research programmer

See you at Charm++ BOF at
SC: Tuesday noon

More info on Charm++:
<http://charm.cs.illinois.edu>

