



# User Guide

## Pan/Tilt AI Home Security Wi-Fi Camera

# Contents

About This Guide .....	1
Introduction .....	2
Appearance .....	3
Set Up Your Camera .....	5
Set Up Using Amazon Frustration-Free Setup .....	6
Set Up HomeKit .....	10
Mount Your Camera .....	12
Authentication .....	13

# About This Guide

This guide provides a brief introduction to the Pan/Tilt AI Home Security Wi-Fi Camera and the Tapo app, as well as regulatory information.

Please note that features available in Tapo may vary by model and software version. Tapo availability may also vary by region. All images, steps, and descriptions in this guide are only examples and may not reflect your actual Tapo Camera experience.

## Conventions

In this guide, the following convention is used:

Convention	Description
Blue	Key information appears in blue, including management page text such as menus, items, buttons and so on.
<u>Underline</u>	Hyperlinks are in blue and underlined. You can click to redirect to a website.
■ Note:	Ignoring this type of note might result in a malfunction or damage to the device.

## More Info

- Specifications can be found on the product page at <https://www.tapo.com>.
- Our Technical Support and troubleshooting information can be found at <https://www.tapo.com/support/>.
- The setup video can be found at <https://www.tp-link.com/support/setup-video/#cloud-cameras>.

# Introduction

When you are away home, there are always something you care about. This is where the smart camera functions. No matter your child is climbing the kitchen cabinet, or the pet is stealing snacks, the Pan/Tilt AI Home Security Wi-Fi Camera helps you stay with them anytime, anywhere. Receive a notification whenever your camera detects motion and see a video clip of this motion to check everything.

- **Smart AI Detection and Notification** – Smart AI identifies people, pets, and vehicles while also recognizing abnormal sounds, notifying users as needed.
- **Physical Privacy Mode** – Maintains privacy with the lens blocked by the housing when physical privacy mode is enabled.
- **Superior Starlight Vision with Ultra Large Aperture** – Reveals high-fidelity details in low-light environments with an f1.6 ultra-large aperture.
- **Customizable Block Zones** – Set customizable block zones to keep private areas from being monitored.
- **Customizable Smart Tracking** – Tracks and follows the subjects you set, keeping it within the camera's field of view.
- **Discreet Night Vision with 940nm IR LED** – Enjoy unobtrusive night-time monitoring of your baby or pet with the barely-noticeable, low-intensity 940nm IR LED.
- **2K QHD\* + HDR** – Capture sharper, more revealing images with HDR technology and 1.7× more pixels than 1080p.  
\*Compatible with Alexa and Google Assistant supported displays. User experience is dependent on the connected device's specifications.
- **Local\* and Cloud\*\* Storage Supported** – Save recorded videos on the microSD card\* (up to 512 GB) or by using Tapo Care cloud storage services.  
\*microSD card needs to be purchased separately. Actual storage capacity depends on the size of the microSD card used.  
\*\*Subscribe for cloud storage at <https://www.tapo.com/tapocare/>
- **Activity Zones** – Notifies you when activity is detected in specific zones.

# Appearance

## Front

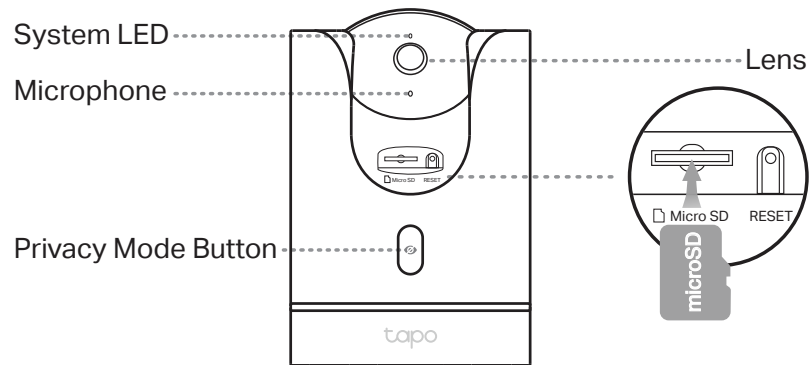

## Back

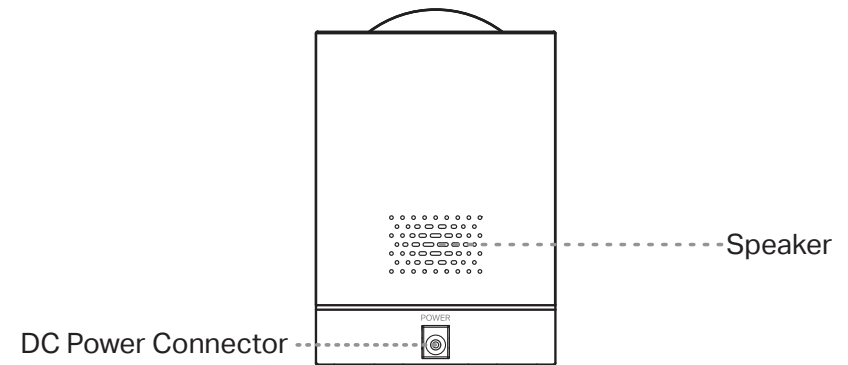

**Note:** Tilt the camera lens up to find the RESET button and the microSD card slot.

## Slot & Button Explanation

### **RESET Button**

While the camera is on, press and hold the RESET button for at least 5 seconds until the LED blinks red.

### **microSD Card Slot**

Insert a microSD card (not included) and initialize it on the Tapo app for local recording.

### **Privacy Mode Button**

Press the button to turn Privacy Mode on and off. When Privacy Mode is on, the camera lens is hidden.

## System LED Indication

<b>Solid red</b>	Starting up, video recording or live streaming
<b>Blinking red and blue</b>	Ready for setup
<b>Blinking blue quickly</b>	Connecting to Wi-Fi
<b>Blinking red slowly</b>	Connected to Wi-Fi
<b>Solid blue</b>	Connected to the cloud
<b>Blinking red quickly</b>	Camera updating or camera resetting

# Set Up Your Camera

Follow the steps below to get started with your new camera.

## Step 1. Download Tapo App

Get the [Tapo](#) app from the App Store or Google Play, or by scanning the QR code below.



OR

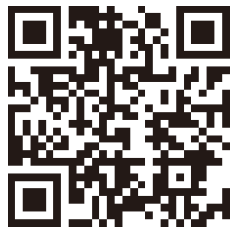

## Step 2. Log In

Open the app, and log in with your TP-Link ID. If you don't have an account, create one first.

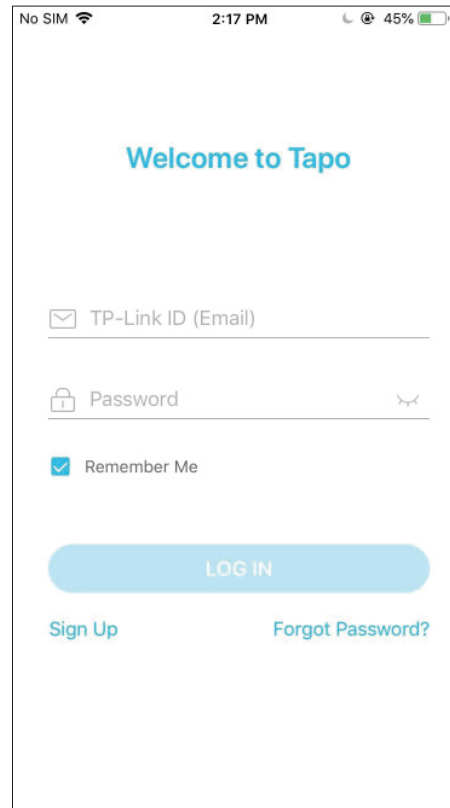

## Step 3. Add Your Camera

Tap the  $\oplus$  button in the app and search for your model. Follow the app instructions to complete setup.

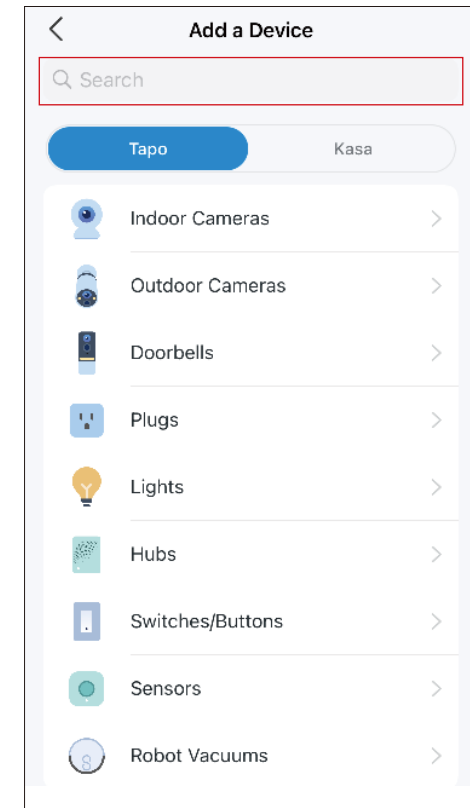

# Set Up Using Amazon Frustration-Free Setup

## What is Amazon Frustration-Free Setup?

Amazon Frustration-Free Setup can help connect and set up Tapo smart devices in fewer steps, without having to remember and re-enter your Wi-Fi password on each device.

To use this feature, confirm the following:

- The new Tapo device supports Amazon FFS.
- The new Tapo device is purchased from Amazon.
- You have an Amazon FFS enabled Alexa device or router.
- You have saved your Wi-Fi information to Amazon by using Alexa echo.
- Your Tapo device and router are on the same network as your Alexa echo.

## LED Indications during Amazon Frustration-Free Setup

LED	Status
Blinking red and blue	Ready for setup
Blinking blue	FFS setup in progress
Solid blue	Working properly

If the LED does not turn solid blue after a long time, you can try to add the Tapo device manually. (Press the Reset button on your Tapo device once. Then open the Tapo app, tap the + button on the page, select your device model, and follow the app instructions.)



# How to use Amazon Frustration-Free Setup with Tapo devices

1. Open the Amazon Alexa app. Then tap **More** and select **Skills & Games**.

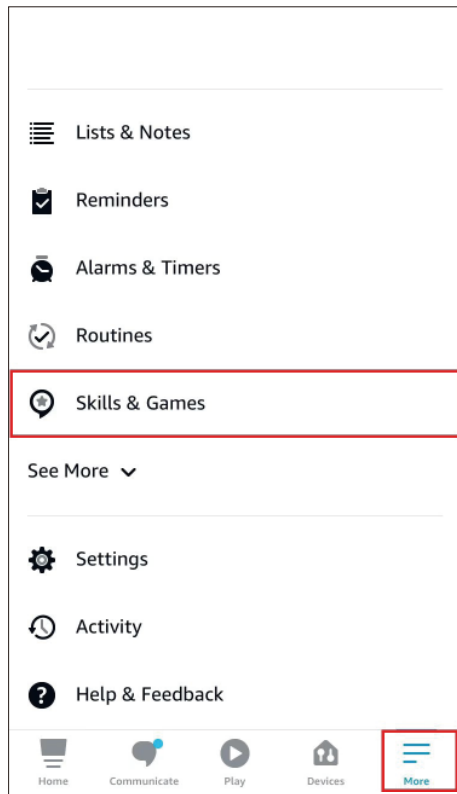

2. Enter **Tapo** in the search bar and choose **Tapo**.

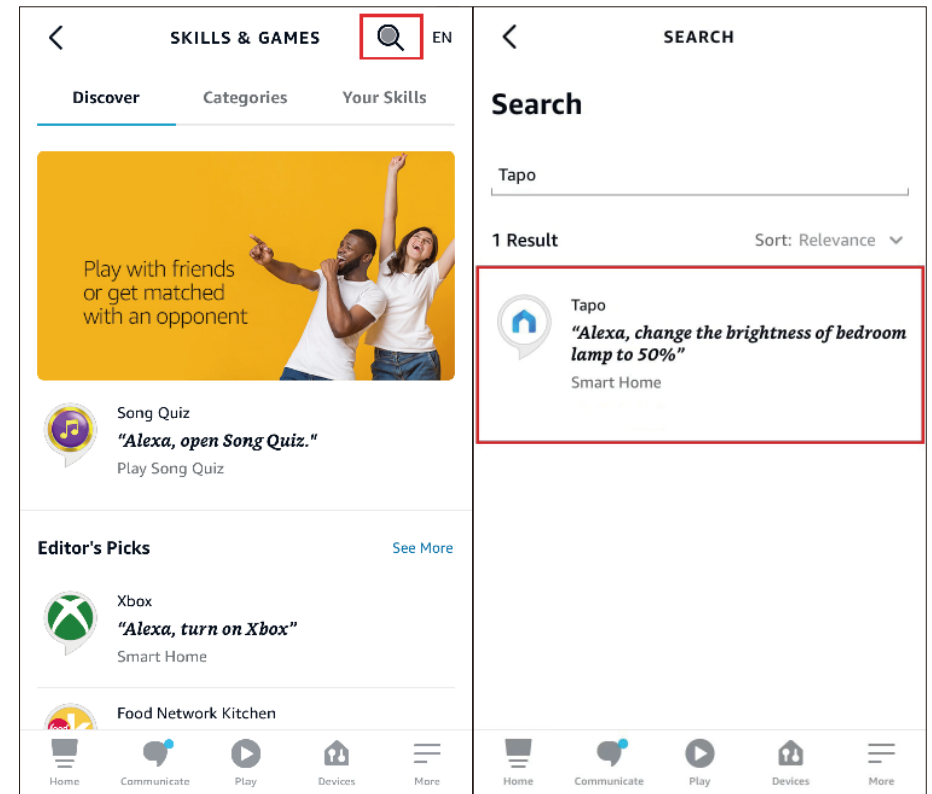

3. Tap the **ENABLE TO USE** button.

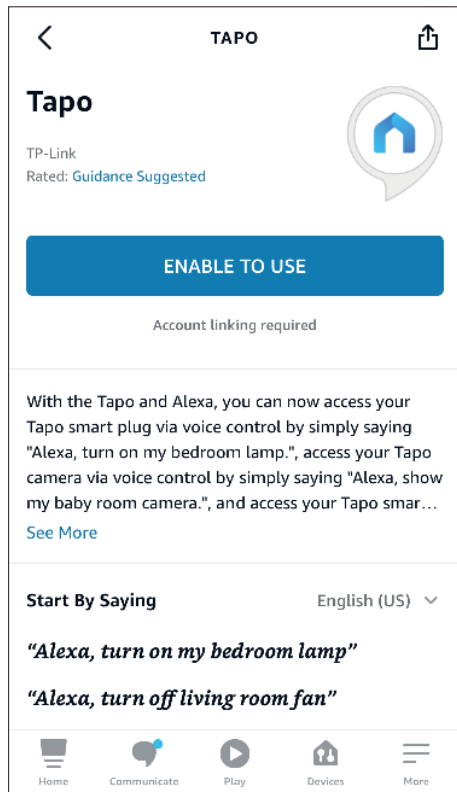

4. Log in with your TP-Link ID that has bound to your Tapo device, and tap **Authorize**. After authorized successfully, the message **Tapo has been successfully linked** will come up.

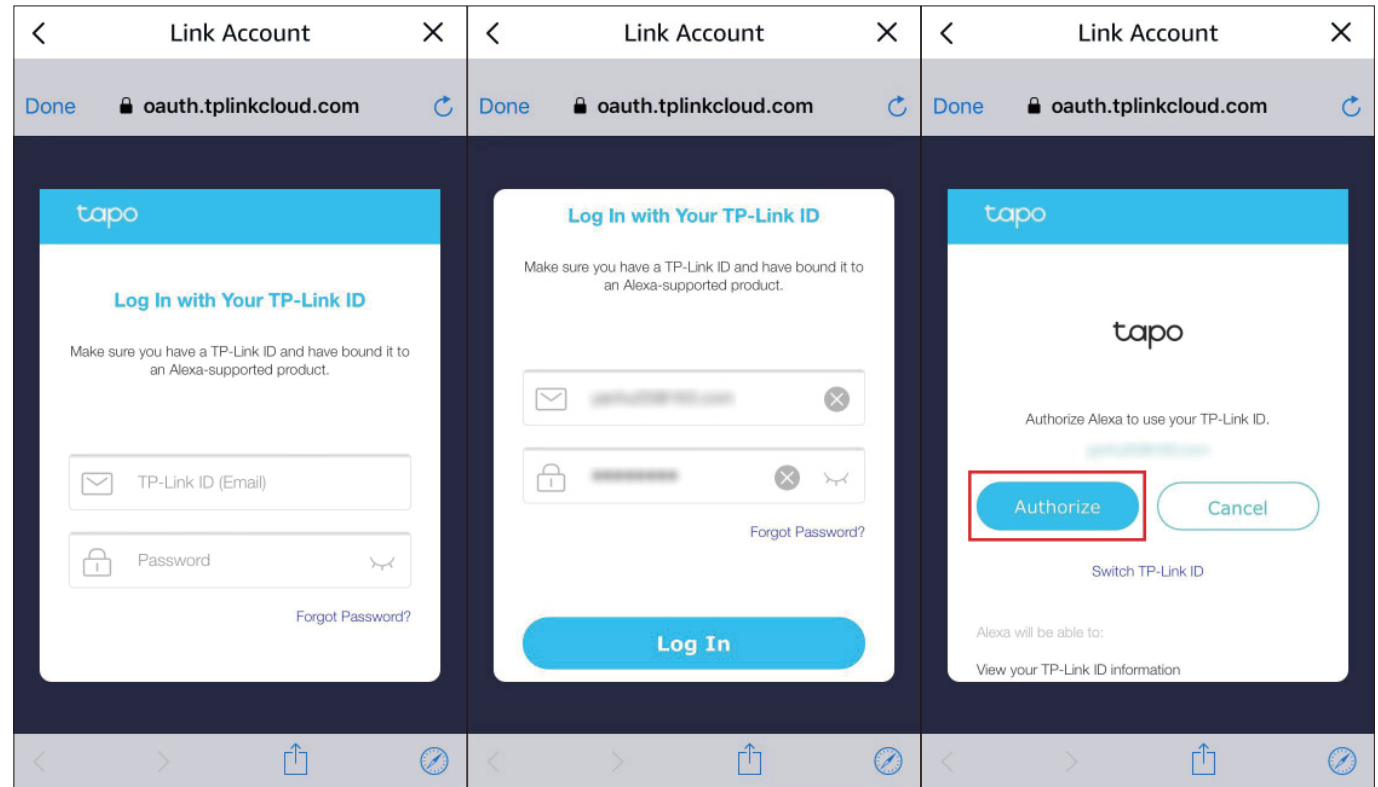

5. Plug in your Tapo device and the setup will complete automatically in two minutes.

For setting up more Tapo devices, just plug in and enjoy!

### **Done!**

If this device displays on the Home page in the Tapo app, it indicates this device has been successfully associated with your Amazon account and joined your Wi-Fi network automatically.

If this device does not display on the Home page in the Tapo app, try setting it up manually. (Tap the + button on the page, select your device model, and then follow the app instructions.)

# Set Up HomeKit

This is a HomeKit-enabled device. You can set up and easily control your Tapo devices with HomeKit from your iPhone or iPad.

## Before You Start:

1. Your iPhone/iPad should be connected to a stable 2.4 GHz Wi-Fi network with internet access.
2. Ensure your iPhone/iPad and Apple home hub (if any) are connected to the same Wi-Fi network.
3. To control this HomeKit-enabled device, the latest iOS or iPadOS version is recommended.
4. HomeKit will be disabled 10 minutes after the Tapo device is powered on. You can power off your Tapo device, then power it on and try again.

## Set Up HomeKit

### Option 1: Set Up in the Home App

1. Find the QR code as below on your Tapo device or in its packaging.



2. Open the Home app and add the accessory by scanning the HomeKit QR code or entering the provided numeric setup code.
3. Follow the instructions in the Home app to complete setup.

### Option 2: Set Up in the Tapo App

1. Open the Tapo app. If you have set up the device, go to **Device Settings > Add to Home**.
2. Find the QR code as below on your Tapo device or in its packaging.



3. Follow the instructions in the Tapo app to complete setup.

To control a Tapo device in the Home app, we must follow Apple guidelines. As a result, some Tapo app features will be disabled.

To know about the disabled features in the Home app, refer to <https://www.tp-link.com/support/faq/3653/> or scan the QR code on the right.



### Failed to Set Up HomeKit?

- Move your iPhone/iPad and the Tapo device closer to the router to get a stronger Wi-Fi signal.
- Factory reset the Tapo device and restart your phone. Then try again.
- Refer to the FAQ below for detailed instructions: <https://www.tp-link.com/support/faq/3390/>



# Mount Your Camera

When you finish adding your camera in the Tapo app, you can set it on a table or shelf. You can also mount it using the camera base. Follow the steps below to install your new camera.

## 1. Mark Position

Place the mounting template where you want the camera. For wall mounting, drill two holes through two circles.

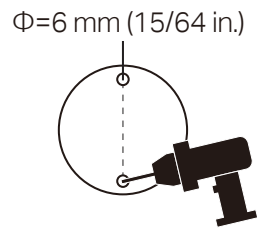

## 2. Mount Base

Affix the camera base using the screws. For wall mounting, insert two anchors into the holes and use the screws to affix the camera base over the anchors.

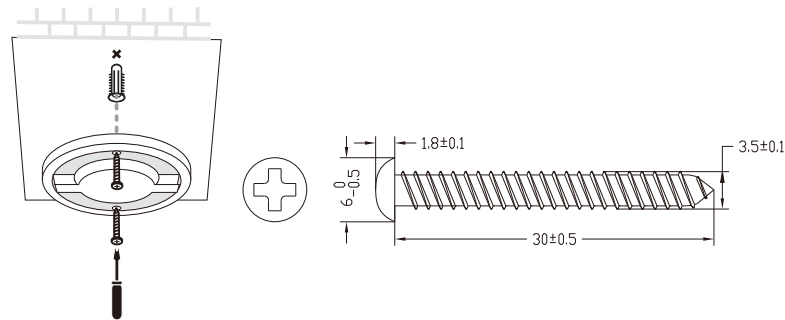

## 3. Secure Camera

Attach the camera on the base and rotate to secure the camera.

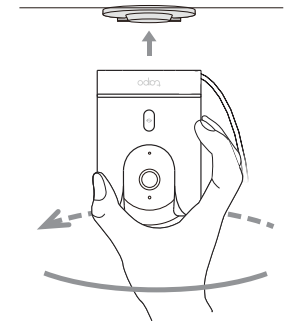

# Authentication

## FCC compliance information statement



**Product Name: Pan/Tilt AI Home Security Wi-Fi Camera**

**Model Number: Tapo C225/TC73**

Component Name	Model
I.T.E. Power Supply	T120100-2B1

### **Responsible Party:**

**TP-Link USA Corporation**

Address: 10 Mauchly, Irvine, CA 92618

Website: <http://www.tp-link.com/us/>

Tel: +1 626 333 0234

Fax: +1 909 527 6804

E-mail: [sales.usa@tp-link.com](mailto:sales.usa@tp-link.com)

This equipment has been tested and found to comply with the limits for a Class B digital device, pursuant to part 15 of the FCC Rules. These limits are designed to provide reasonable protection against harmful interference in a residential installation. This equipment generates, uses and can radiate radio frequency energy and, if not installed and used in accordance with the instructions, may cause harmful interference to radio communications. However, there is no guarantee that interference will not occur in a particular installation. If this equipment does cause harmful interference to radio or television reception, which can be determined by turning the equipment off and on, the user is encouraged to try to correct the interference by one or more of the following measures:

- Reorient or relocate the receiving antenna.
- Increase the separation between the equipment and receiver.
- Connect the equipment into an outlet on a circuit different from that to which the receiver is connected.
- Consult the dealer or an experienced radio/ TV technician for help.

This device complies with part 15 of the FCC Rules. Operation is subject to the following two conditions:

1. This device may not cause harmful interference.
2. This device must accept any interference received, including interference that may cause undesired operation.

Any changes or modifications not expressly approved by the party responsible for compliance could void the user's authority to operate the equipment.

Note: The manufacturer is not responsible for any radio or TV interference caused by unauthorized modifications to this equipment. Such modifications could void the user's authority to operate the equipment.

### **FCC RF Radiation Exposure Statement**

This equipment complies with FCC RF radiation exposure limits set forth for an uncontrolled environment. This device and its antenna must not be co-located or operating in conjunction with any other antenna or transmitter.

"To comply with FCC RF exposure compliance requirements, this grant is applicable to only Mobile Configurations. The antennas used for this transmitter must be installed to provide a separation distance of at least 20 cm from all persons and must not be co-located or operating in conjunction with any other antenna or transmitter."

We, **TP-Link USA Corporation**, has determined that the equipment shown as above has been shown to comply with the applicable technical standards, FCC part 15. There is no unauthorized change is made in the equipment and the equipment is properly maintained and operated.

**Issue Date:** 2023-09-07

### **FCC compliance information statement**

**Product Name:** I.T.E. Power Supply

**Model Number:** T120100-2B1

**Responsible Party:**

**TP-Link USA Corporation**

Address: 10 Mauchly, Irvine, CA 92618

Website: <http://www.tp-link.com/us/>

Tel: +1 626 333 0234

Fax: +1 909 527 6804

E-mail: [sales.usa@tp-link.com](mailto:sales.usa@tp-link.com)



This equipment has been tested and found to comply with the limits for a Class B digital device, pursuant to part 15 of the FCC Rules. These limits are designed to provide reasonable protection against harmful interference in a residential installation. This equipment generates, uses and can radiate radio frequency energy and, if not installed and used in accordance with the instructions, may cause harmful interference to radio communications. However, there is no guarantee that interference will not occur in a particular installation. If this equipment does cause harmful interference to radio or television reception, which can be determined by turning the equipment off and on, the user is encouraged to try to correct the interference by one or more of the following measures:

- Reorient or relocate the receiving antenna.
- Increase the separation between the equipment and receiver.
- Connect the equipment into an outlet on a circuit different from that to which the receiver is connected.
- Consult the dealer or an experienced radio/ TV technician for help.

This device complies with part 15 of the FCC Rules. Operation is subject to the following two conditions:

1. This device may not cause harmful interference.
2. This device must accept any interference received, including interference that may cause undesired operation.

Any changes or modifications not expressly approved by the party responsible for compliance could void the user's authority to operate the equipment.

We, **TP-Link USA Corporation**, has determined that the equipment shown as above has been shown to comply with the applicable technical standards, FCC part 15. There is no unauthorized change is made in the equipment and the equipment is properly maintained and operated.

**Issue Date:** 2023-09-07

## **CE Mark Warning**



This is a class B product. In a domestic environment, this product may cause radio interference, in which case the user may be required to take adequate measures.

## **OPERATING FREQUENCY (the maximum transmitted power)**

2412MHz—2472MHz (20dBm)

## **EU Declaration of Conformity**

TP-Link hereby declares that the device is in compliance with the essential requirements and other relevant provisions of directives 2014/53/EU, 2009/125/EC, 2011/65/EU and (EU)2015/863.

The original EU Declaration of Conformity may be found at <https://www.tapo.com/en/support/ce/>.

## **RF Exposure Information**

This device meets the EU requirements (2014/53/EU Article 3.1a) on the limitation of exposure of the general public to electromagnetic fields by way of health protection.

The device complies with RF specifications when the device used at 20 cm from your body.

Restricted to indoor use.

UKCA Mark



### UK Declaration of Conformity

TP-Link hereby declares that the device is in compliance with the essential requirements and other relevant provisions of the Radio Equipment Regulations 2017.

The original UK Declaration of Conformity may be found at <https://www.tapo.com/support/ukca/>.



### Korea Warning Statements:

당해 무선설비는 운용중 전파혼신 가능성이 있음.

## NCC Notice & BSMI Notice

### 注意!

取得審驗證明之低功率射頻器材，非經核准，公司、商號或使用者均不得擅自變更頻率、加大功率或變更原設計之特性及功能。

低功率射頻器材之使用不得影響飛航安全及干擾合法通信；經發現有干擾現象時，應立即停用，並改善至無干擾時方得繼續使用。

前述合法通信，指依電信管理法規定作業之無線電通信。

低功率射頻器材須忍受合法通信或工業、科學及醫療用電波輻射性電機設備之干擾。

為避免本器材影像畫面遭偷窺或擷取，本器材使用者應先修改預設密碼，並定期更新密碼。

### 安全諮詢及注意事項

- 請使用原裝電源供應器或只能按照本產品注明的電源類型使用本產品。
- 清潔本產品之前請先拔掉電源線。請勿使用液體、噴霧清潔劑或濕布進行清潔。
- 注意防潮，請勿將水或其他液體潑灑到本產品上。
- 插槽與開口供通風使用，以確保本產品的操作可靠並防止過熱，請勿堵塞或覆蓋開口。
- 請勿將本產品置放於靠近熱源的地方。除非有正常的通風，否則不可放在密閉位置中。
- 不要私自拆開機殼或自行維修，如產品有故障請與原廠或代理商聯繫。

### 限用物質含有情況標示聲明書

設備名稱：Pan/Tilt AI Home Security Wi-Fi Camera				型號（型式）：Tapo C225/TC73		
Equipment name				Type designation (Type)		
單元 Unit	限用物質及其化學符號 Restricted substances and its chemical symbols					
	鉛 Lead (Pb)	汞 Mercury (Hg)	鎘 Cadmium (Cd)	六價鉻 Hexavalent chromium (Cr <sup>+6</sup> )	多溴聯苯 Polybrominated biphenyls (PBB)	多溴二苯醚 Polybrominated diphenyl ethers (PBDE)
PCB	○	○	○	○	○	○
外殼	○	○	○	○	○	○

電源供應器	—	○	○	○	○	○
其他及其配件	—	○	○	○	○	○

備考 1. “超出 0.1 wt %” 及 “超出 0.01 wt %” 係指限用物質之百分比含量超出百分比含量基準值

Note 1: “Exceeding 0.1 wt %” and “exceeding 0.01 wt %” indicate that the percentage content of the restricted substance exceeds the reference percentage value of presence condition.

備考 2. “○” 係指該項限用物質之百分比含量未超出百分比含量基準值。

Note 2: “○” indicates that the percentage content of the restricted substance does not exceed the percentage of reference value of presence.

備考 3. “—” 係指該項限用物質為排除項目。

Note 3: The “—” indicates that the restricted substance corresponds to the exemption.



Продукт сертифіковано згідно с правилами системи УкрСЕПРО на відповідність вимогам нормативних документів та вимогам, що передбачені чинними законодавчими актами України.



## Safety Information













- Keep the device away from water, fire, humidity or hot environments.
- Do not use damaged charger or USB cable to charge the device.
- Do not use any other chargers than those recommended.
- Do not use the device where wireless devices are not allowed.
- Adapter shall be installed near the equipment and shall be easily accessible.
- Use only power supplies which are provided by manufacturer and in the original packing of this product. If you have any questions, please don't hesitate to contact us.
- For indoor use only.
- Do not disassemble, repair or modify the product.
- Do not use the product if the casing has been broken. Danger of electric shock.
- Never touch the product with wet hands.
- Do not expose to heavy rain or any type of moisture.
- Do not place near automatically controlled devices such as fire alarms. Radio waves emitted from this product may cause such devices to malfunction resulting in an accident.
- Observe restrictions on using wireless products in fuel depots, chemical plants or when blasting operations are in progress.
- Do not use liquid to clean the product. Only use a dry cloth.
- Never put metal objects inside the product. If a metal object enters the product turn off the circuit breaker and contact an authorised electrician.
- This product is not intended to be used when providing medical care. Consult the manufacturer of any personal medical devices, such as pacemakers or hearing aids to determine if they are adequately shielded from external RF (radio frequency) energy.
- Do not use this product in health care facilities. Hospitals or health care facilities may be using equipment that could be sensitive to external RF energy.
- Do not use this product near water for example near a bath tub, wash bowl, kitchen sink or laundry tub, in a wet basement or near a swimming pool.
- The product should be kept free from excessive smoke, dust or high temperature and vibration.
- This product should not be exposed to direct sunlight
- Do not place heavy objects on top of the product.

- When you leave the product unused for a long time unplug the product from the power outlet.
- This product may interfere with other electronic products such as TV, radios, personal computers, phones or other wireless devices.
- Operating Temperature: 0 °C ~ 40°C (32°F ~ 104°F)











Please read and follow the above safety information when operating the device. We cannot guarantee that no accidents or damage will occur due to improper use of the device. Please use this product with care and operate at your own risk.

## Explanation of the symbols on the product label

Note: The product label is on the bottom of the product and its power supply. Symbols may vary from products.

Symbol	Explanation
	Class II equipment
	Class II equipment with functional earthing
	Alternating current
	DC voltage
	Polarity of output terminals
	Indoor use only
	Dangerous voltage
	Caution, risk of electric shock
	Energy efficiency Marking
	Protective earth
	Earth
	Frame or chassis



Symbol	Explanation
	Functional earthing
	Caution, hot surface
	Caution
	Operator's manual
	Stand-by
	"ON"/"OFF" (push-push)
	Fuse
	Fuse is used in neutral N
	<p>RECYCLING</p> <p>This product bears the selective sorting symbol for Waste electrical and electronic equipment (WEEE). This means that this product must be handled pursuant to European directive 2012/19/EU in order to be recycled or dismantled to minimize its impact on the environment.</p> <p>User has the choice to give his product to a competent recycling organization or to the retailer when he buys a new electrical or electronic equipment.</p>
	Caution, avoid listening at high volume levels for long periods
	Disconnection, all power plugs

<b>Symbol</b>	<b>Explanation</b>
m	Switch of mini-gap construction
μ	Switch of micro-gap construction (for US version) Switch of micro-gap / micro-disconnection construction (for other versions except US)
ε	Switch without contact gap (Semiconductor switching device)