



User Guide

Smart Wire-Free Security Camera

Contents

About This Guide	1
Introduction	2
Appearance	3
Charge the Battery.....	5
Set Up Your Camera.....	6
Set Up Using Amazon Frustration-Free Setup.....	7
Mounting Tips.....	11
Mount Your Camera.....	12
Work with Tapo Solar Panel.....	15
Authentication.....	16

About This Guide

This guide provides a brief introduction to the Smart Wire-Free Security Camera and the Tapo app, as well as regulatory information.

Please note that features available in Tapo may vary by model and software version. Tapo availability may also vary by region. All images, steps, and descriptions in this guide are only examples and may not reflect your actual Tapo Camera experience.

Conventions

In this guide, the following convention is used:

Convention	Description
Blue	Key information appears in blue, including management page text such as menus, items, buttons and so on.
<u>Underline</u>	Hyperlinks are in blue and underlined. You can click to redirect to a website.
■ Note:	Ignoring this type of note might result in a malfunction or damage to the device.

More Info

- Specifications can be found on the product page at <https://www.tapo.com>.
- Our Technical Support and troubleshooting information can be found at <https://www.tapo.com/support/>.

Introduction

Smart Wire-Free Security Camera is a full-featured weatherproof security camera that you can access from anywhere. Receive instant notifications and check feeds when the motion is detected. Moreover, the automatic siren system will trigger light and sound to frighten away unwanted visitors after the camera detects motion.

Day or night, rain or shine, the Tapo camera protects what you love most.

- **Free Person/Pet/Vehicle Detection** – Smart AI accurately identifies people, pets, and vehicles, reducing false alerts and unnecessary notifications, which also extends battery life.
- **2K QHD Live View** – Now with 1.7× more pixels than 1080p, providing clearer videos and more crisp photos.
- **Person Detection and Notification** – Receive instant notification from the Tapo app when a person is detected.
- **Local* and Cloud** Storage** – Save recorded video on a microSD card (up to 512 GB)*, no subscription required. Cloud storage** is also supported for flexibility.

*microSD card must be purchased separately. Actual storage capacity depends on the size of the microSD card used.

**Subscribe for cloud storage at <https://www.tapo.com/tapocare/>

- **Full-Color Night Vision** – Enhances your security by revealing vivid colors with built-in spotlights and starlight sensor.
- **150° Super-Wide FOV** – Expands your visual coverage and ensures you to keep an eye on more vital areas.
- **Customizable Sound and Light Alarm** – Record your own audio as an alarm and adjust the brightness of dual spotlights for your customized use.
- **10000mAh Rechargeable Battery** – The built-in 10000mAh rechargeable battery leads to a long-lasting life (up to 300 days)Δ, extending your usage.
- **Activity Zones** – Set customized detection areas to only let what matters alert you.
- **IP66 Weatherproof** – Performs well even in harsh environments with rain and dust, ideal for indoor/outdoor scenarios.

Appearance

Front

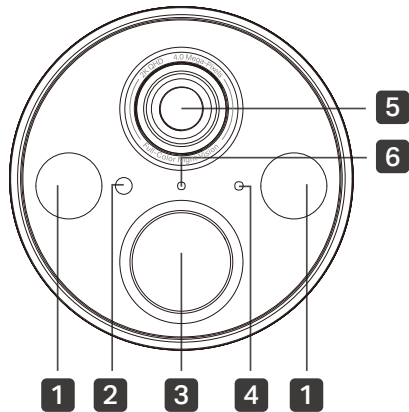

- 1** Spotlights
- 2** Light Sensor
- 3** Motion Sensor
- 4** Microphone
- 5** Lens
- 6** Status LED

Side

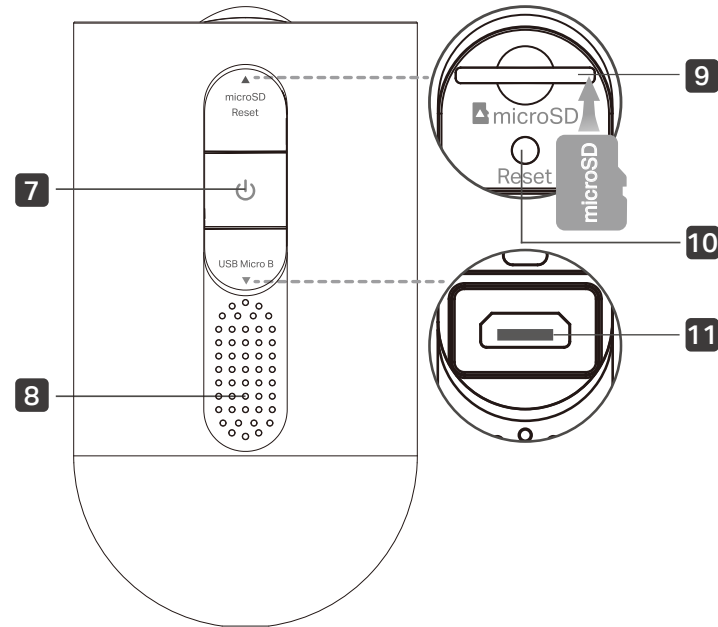

- 7** **Power Button** 
Press and hold for about 3 seconds to turn on/off the camera.
- 8** **Speaker**
- 9** **microSD Card Slot**
Open the cover. Insert a microSD card* and initialize it on the Tapo app for local recording.
*microSD card not included.
- 10** **Reset Button**
Open the cover. Use a pin to press and hold for at least 5 seconds to reset the camera to factory default settings.
- 11** **USB Micro B Charging Port**
Open the cover for USB charging.

Status LED Indication

Blinking amber quickly for 3 seconds	Plugging in USB charger
Solid red	Starting up
Blinking red and green	Ready for setup
Blinking red slowly	Connecting to Wi-Fi
Solid amber	Connected to Wi-Fi
Solid green	Connected to the cloud
Blinking red quickly	Camera resetting
Blinking green quickly	Camera updating

Charge the Battery

The battery comes partially charged. We recommend that you fully charge the battery before use. This will take about **five and a half hours** with the included charger.

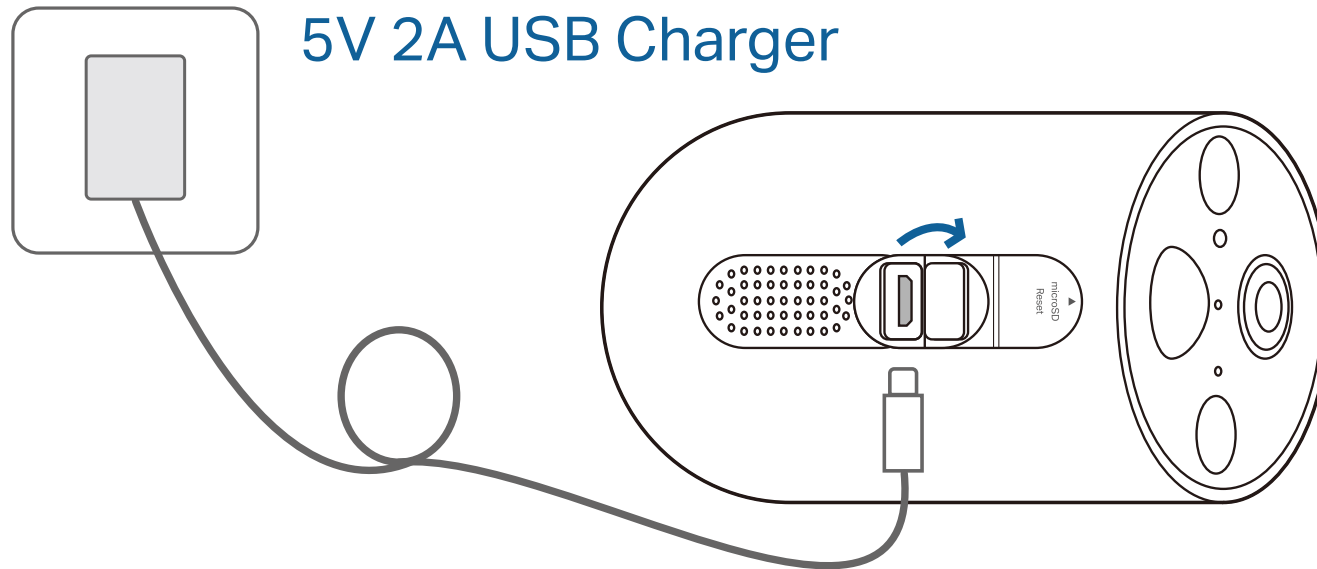

Note:

1. Peel off film from the camera before use.
2. Warning: Do not tear off the silicone part by force as it may affect the waterproof performance.
3. When you plug in the USB charger, the LED should blink amber quickly for 3 seconds. If not, make sure the power is running and check your connection.
4. Charge the battery using the USB cable and charger included in the package. Inappropriate cables may result in slow charging or failure to charge.
5. Keep the ports firmly covered when not in use to ensure waterproof performance.
6. Check the battery status in the Tapo app after setup.

Set Up Your Camera

Follow the steps below to get started with your new camera.

Step 1. Download Tapo App

Get the Tapo app from the App Store or Google Play, or by scanning the QR code below.



OR



Step 2. Log In

Open the app, and log in with your TP-Link ID. If you don't have an account, create one first.

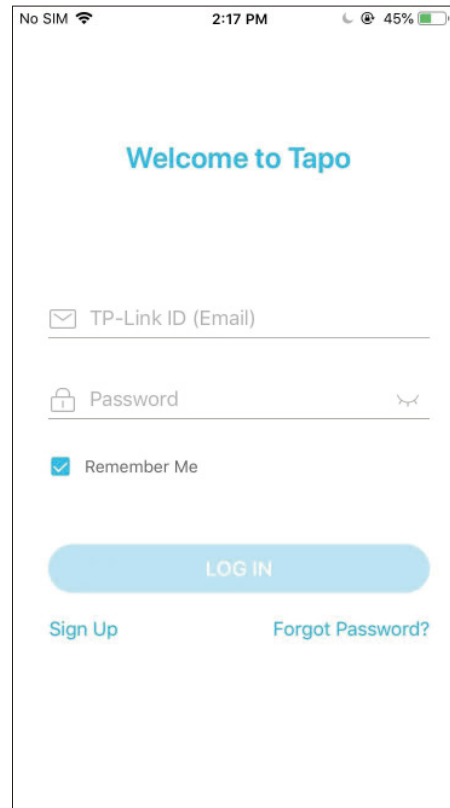

Step 3. Add Your Camera

Tap the ⊕ button in the app and select your model. Follow app instructions to complete the setup.

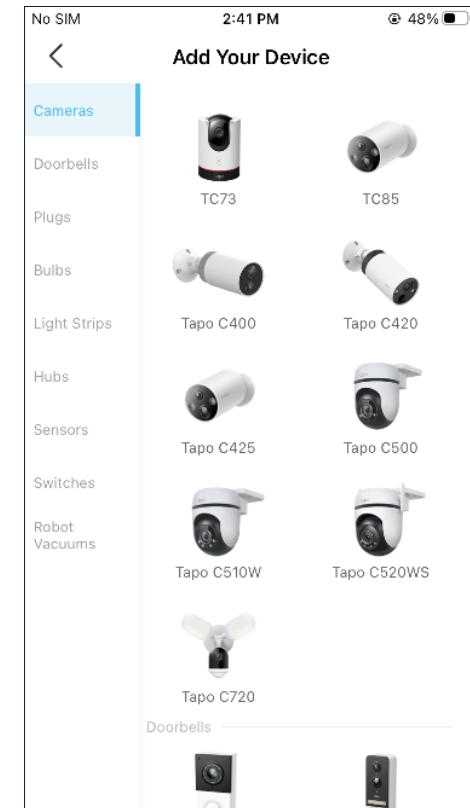

Set Up Using Amazon Frustration-Free Setup

■Note: Amazon Frustration-Free Setup is only available for Tapo C425. TC85 doesn't support Amazon Frustration-Free Setup.

What is Amazon Frustration-Free Setup?

Amazon Frustration-Free Setup can help connect and set up Tapo smart devices in fewer steps, without having to remember and re-enter your Wi-Fi password on each device.

To use this feature, confirm the following:

- The new Tapo device supports Amazon FFS.
- The new Tapo device is purchased from Amazon.
- You have an Amazon FFS enabled Alexa device or router.
- You have saved your Wi-Fi information to Amazon by using Alexa echo.
- Your Tapo device and router are on the same network as your Alexa echo.

LED Indications during Amazon Frustration-Free Setup

LED	Status
Blinking red and green	Ready for setup
Blinking amber	FFS setup in progress
Solid green	Working properly

If the LED does not turn solid green after a long time, you can try to add the Tapo device manually. (Press the Reset button on your Tapo device once. Then open the Tapo app, tap the + button on the page, select your device model, and follow the app instructions.)

How to use Amazon Frustration-Free Setup with Tapo devices

1. Open the Amazon Alexa app. Then tap **More** and select **Skills & Games**.

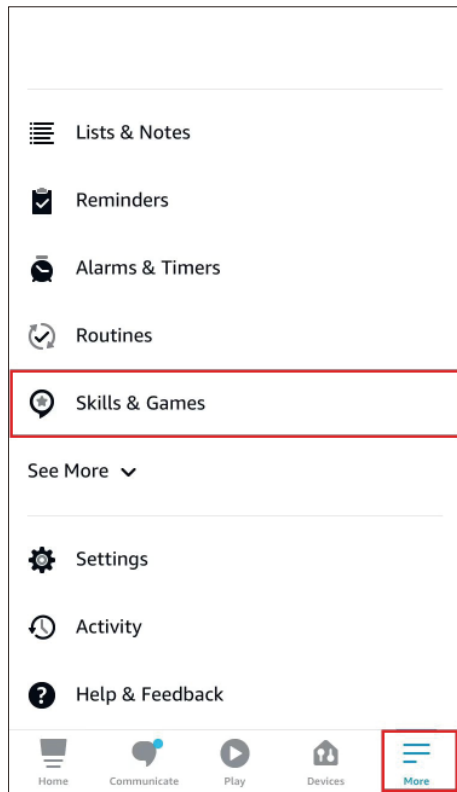

2. Enter **Tapo** in the search bar and choose **Tapo**.

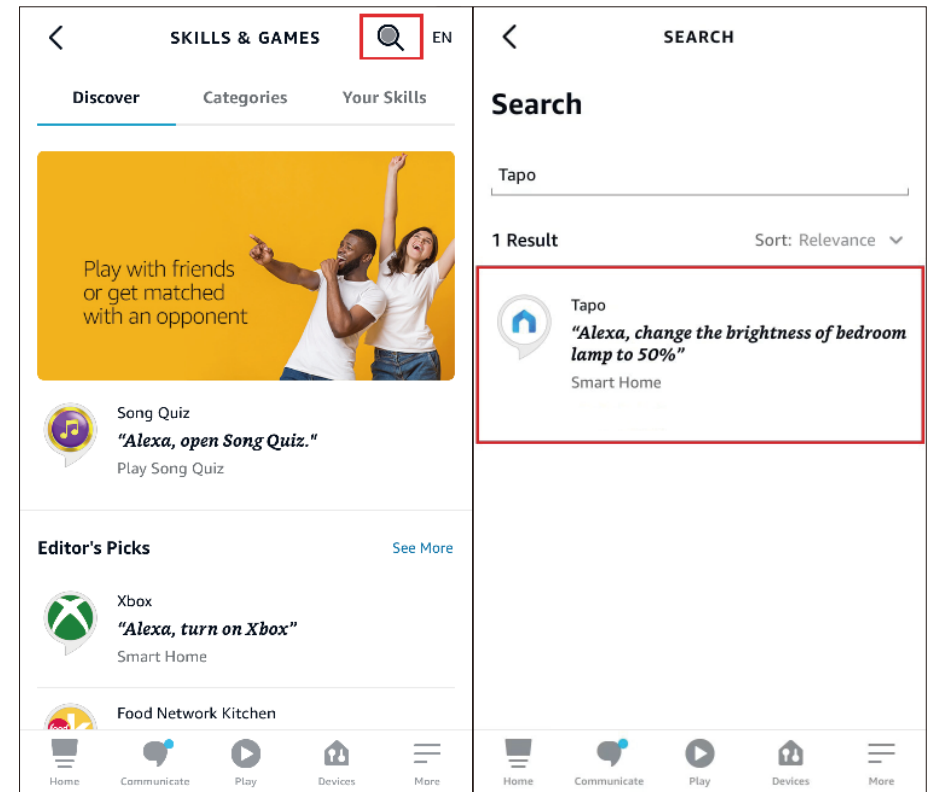

3. Tap the **ENABLE TO USE** button.

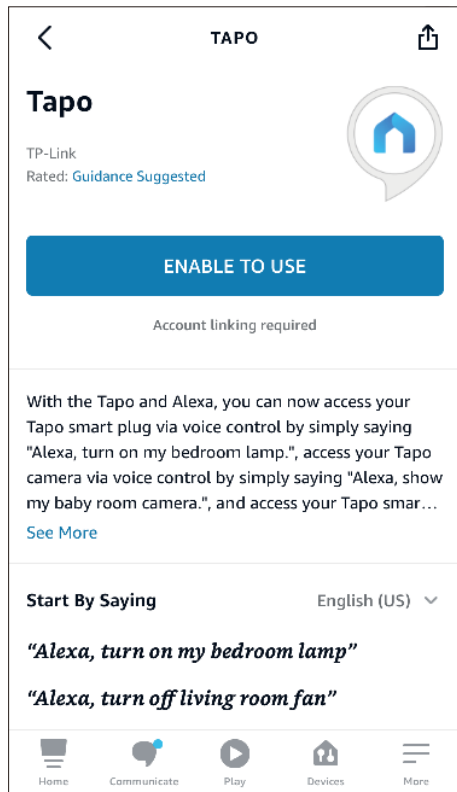

4. Log in with your TP-Link ID that has bound to your Tapo device, and tap **Authorize**. After authorized successfully, the message **Tapo has been successfully linked** will come up.

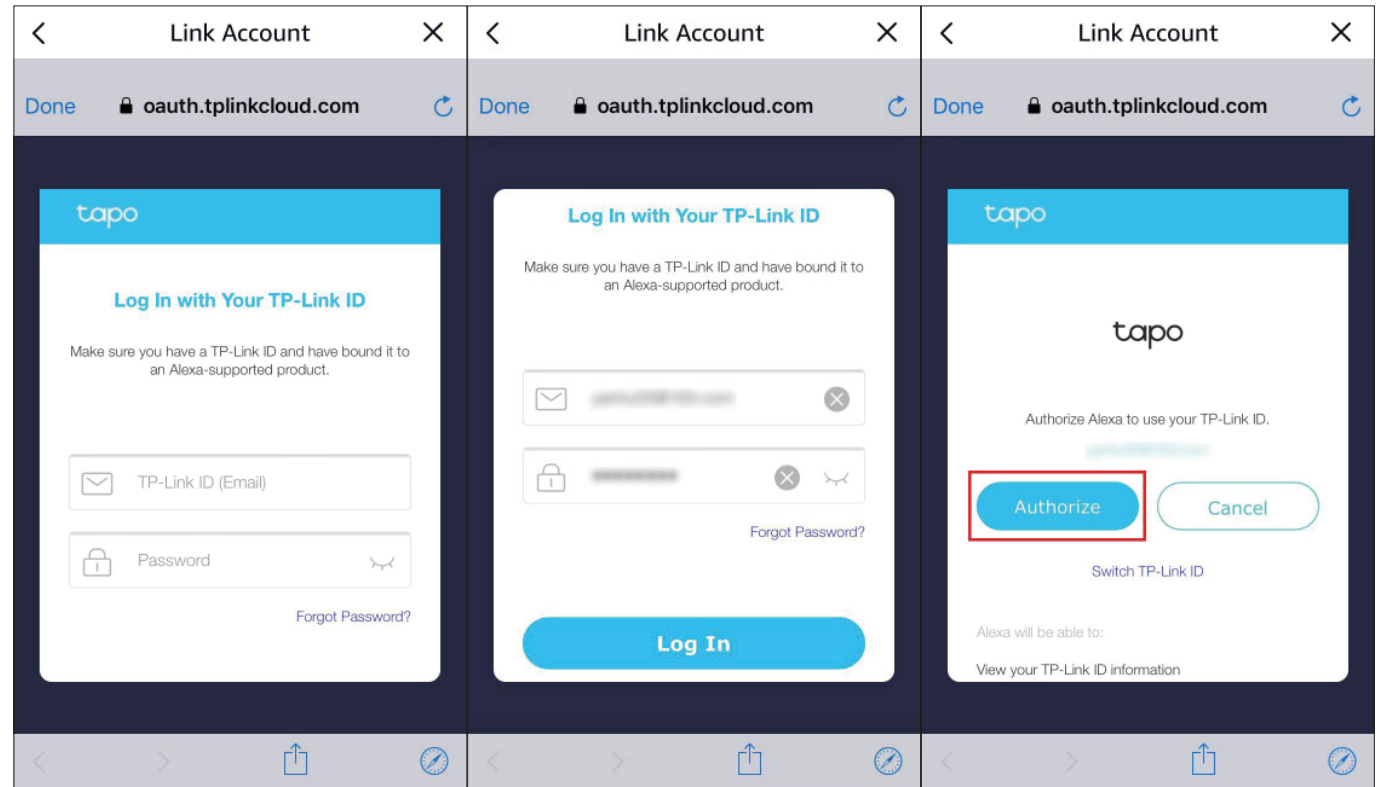

5. Plug in your Tapo device and the setup will complete automatically in two minutes.

For setting up more Tapo devices, just plug in and enjoy!

Done!

If this device displays on the Home page in the Tapo app, it indicates this device has been successfully associated with your Amazon account and joined your Wi-Fi network automatically.

If this device does not display on the Home page in the Tapo app, try setting it up manually. (Tap the + button on the page, select your device model, and then follow the app instructions.)

Mounting Tips

Read mounting tips before you mount the camera.

1. Avoid placing behind glass. Glass will obstruct the motion sensor of your camera.
2. Choose a proper location to mount your camera, or it will be triggered too often by false alarms.
 - Avoid pointing the camera directly at swaying trees.
 - Avoid pointing the camera directly at vehicles and pedestrians on the road.
 - Avoid pointing the camera directly at street lamps and sunlight.
3. Mount your camera to the side so that movement goes across the len's field of view to better trigger motion detection and AI detection.

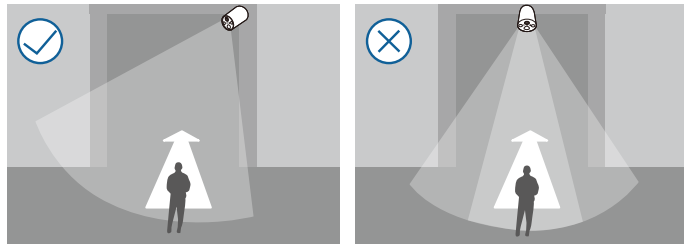

*Do not mount facing the direction of movement.

4. Tilt the camera downwards at an angle of about 15°.

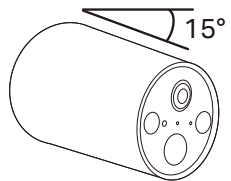

5. Do not place the camera upside down.
6. Keep the motion sensor level for best results.

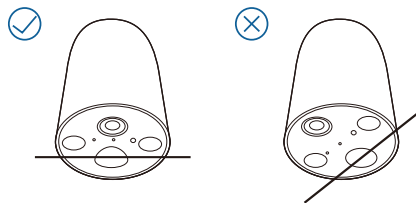

Mount Your Camera

When you finish adding your camera in the Tapo app, you can follow the steps below to mount the camera.

■Note: You can always get detailed mounting instructions in the Tapo app.

Option 1: Mount to metallic surfaces

The camera has a magnet in its base, allowing magnetic attachment to metallic surfaces.

 **CAUTION**
Strong Magnet. Crushing Hazard.

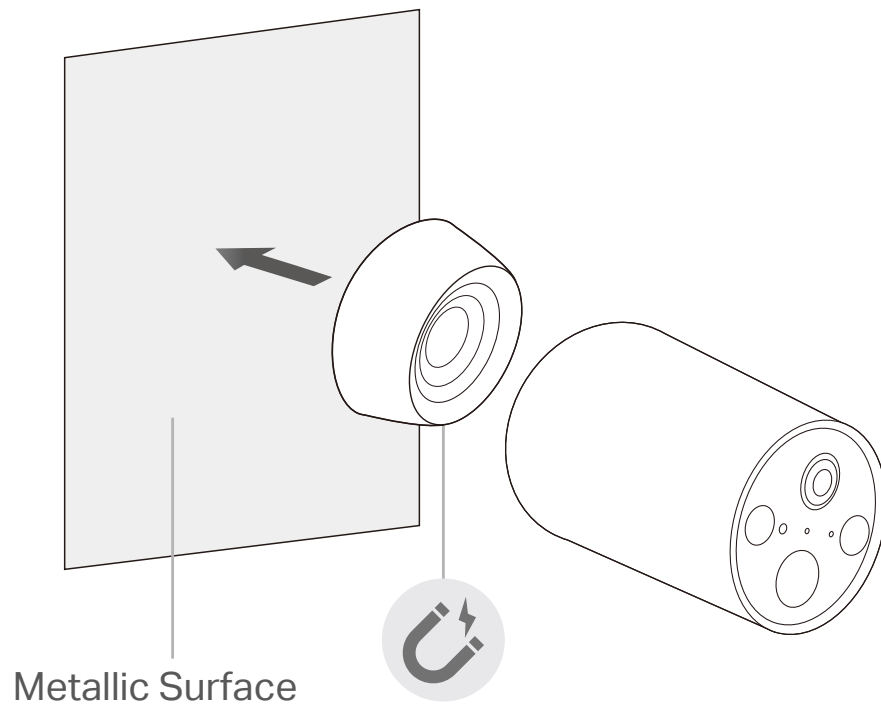

Option 2: Stick to a clean wall

1. Attach the included adhesive to the back of the metal plate properly.

■Note: The adhesive is for one-time use. Avoid re-using the adhesive to ensure its adhesion.

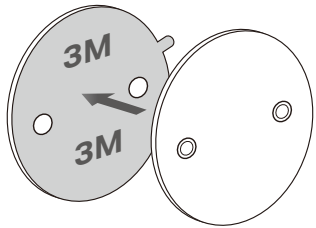

2. Wipe off the dust from the surface, stick the metal plate with the adhesive to the clean wall, and press it down for 15 seconds to ensure the plate is firmly attached. Then attach the camera to the plate.

■Note: This is applicable with tile, glass, marble, metal, stainless steel, and hard wall surfaces. Sticking to other surfaces may result in damage from falling off.

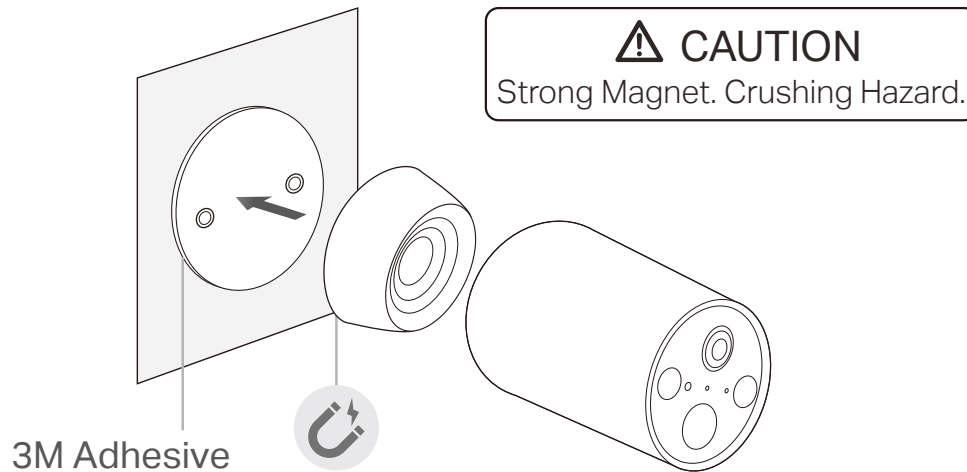

Option 3. Mount to a wall

1. Stick the mounting template to a desired mounting place. Drill two holes according to the template.

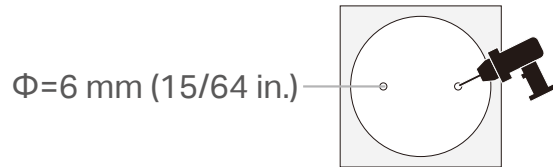

2. Insert two anchors into the holes and use the screws to affix the metal plate over the anchors. Then attach the camera to the plate.

■ **Note:** The front with concave holes of the metal plate should face the magnetic base.

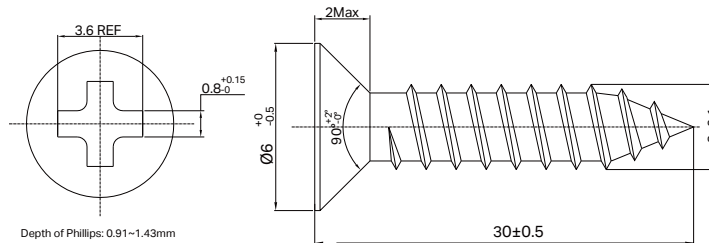
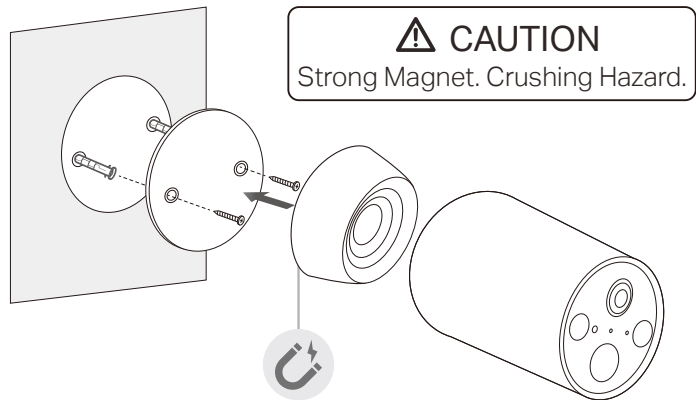

■ **Note:** At 2 meters (6.5 feet) or higher,* we recommend using the Wall Mount Bracket (not included).

*Recommended Installation Height: 2 ~ 3 m (7 ~ 10 ft) above the ground

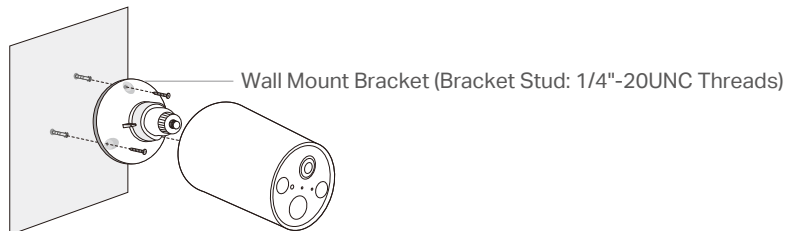

Work with Tapo Solar Panel

The Tapo Solar Panel charges your Smart Wire-Free Security Camera continuously.

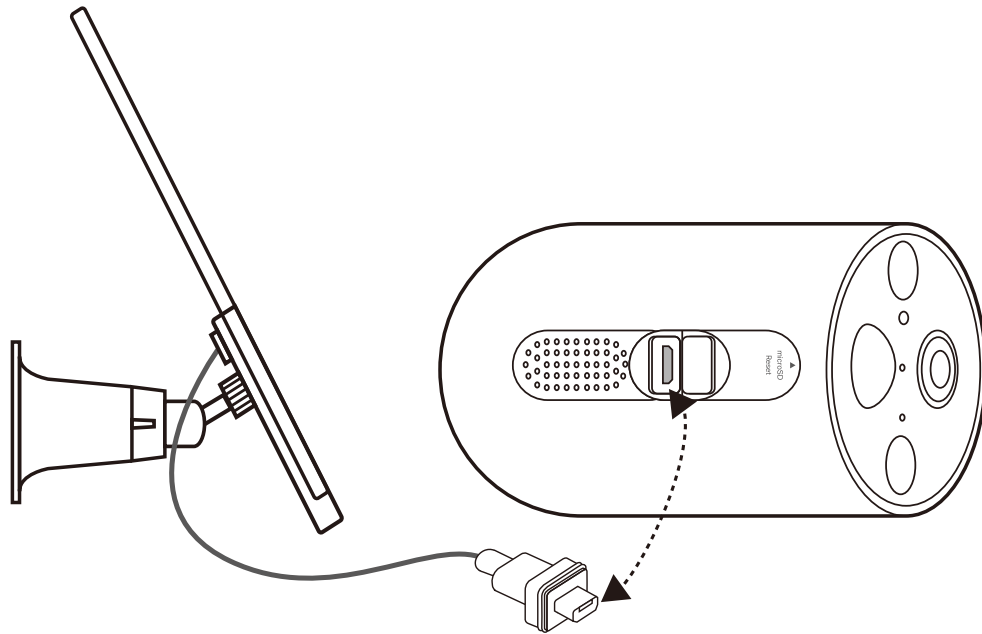

If you don't yet have a Tapo Solar Panel, charge the rechargeable battery with a standard and high-quality DC 5V/2A battery charger. Keep the charging port firmly covered when fully charged.

■ **Note:** If you use a third-party solar panel to charge this camera, we cannot guarantee the waterproof performance.

Authentication

FCC compliance information statement



Product Name: Smart Wire-Free Security Camera

Model Number: Tapo C425/TC85

Component Name	Model
USB ADAPTER	A8A-050200U-US1

Responsible Party:

TP-Link USA Corporation

Address: 10 Mauchly, Irvine, CA 92618

Website: <http://www.tp-link.com/us/>

Tel: +1 626 333 0234

Fax: +1 909 527 6804

E-mail: sales.usa@tp-link.com

This equipment has been tested and found to comply with the limits for a Class B digital device, pursuant to part 15 of the FCC Rules. These limits are designed to provide reasonable protection against harmful interference in a residential installation. This equipment generates, uses and can radiate radio frequency energy and, if not installed and used in accordance with the instructions, may cause harmful interference to radio communications. However, there is no guarantee that interference will not occur in a particular installation. If this equipment does cause harmful interference to radio or television reception, which can be determined by turning the equipment off and on, the user is encouraged to try to correct the interference by one or more of the following measures:

- Reorient or relocate the receiving antenna.
- Increase the separation between the equipment and receiver.
- Connect the equipment into an outlet on a circuit different from that to which the receiver is connected.
- Consult the dealer or an experienced radio/ TV technician for help.

This device complies with part 15 of the FCC Rules. Operation is subject to the following two conditions:

1. This device may not cause harmful interference.
2. This device must accept any interference received, including interference that may cause undesired operation.

Any changes or modifications not expressly approved by the party responsible for compliance could void the user's authority to operate the equipment.

Note: The manufacturer is not responsible for any radio or TV interference caused by unauthorized modifications to this equipment. Such modifications could void the user's authority to operate the equipment.

FCC RF Radiation Exposure Statement

This equipment complies with FCC RF radiation exposure limits set forth for an uncontrolled environment. This device and its antenna must not be co-located or operating in conjunction with any other antenna or transmitter.

"To comply with FCC RF exposure compliance requirements, this grant is applicable to only Mobile Configurations. The antennas used for this transmitter must be installed to provide a separation distance of at least 20 cm from all persons and must not be co-located or operating in conjunction with any other antenna or transmitter."

We, **TP-Link USA Corporation**, has determined that the equipment shown as above has been shown to comply with the applicable technical standards, FCC part 15. There is no unauthorized change is made in the equipment and the equipment is properly maintained and operated.

Issue Date: 2023-07-21

FCC compliance information statement

Product Name: USB Adapter

Model Number: A8A-050200U-US1

Responsible Party:

TP-Link USA Corporation

Address: 10 Mauchly, Irvine, CA 92618

Website: <http://www.tp-link.com/us/>

Tel: +1 626 333 0234

Fax: +1 909 527 6804

E-mail: sales.usa@tp-link.com

This equipment has been tested and found to comply with the limits for a Class B digital device, pursuant to part 15 of the FCC Rules. These limits are

designed to provide reasonable protection against harmful interference in a residential installation. This equipment generates, uses and can radiate radio frequency energy and, if not installed and used in accordance with the instructions, may cause harmful interference to radio communications. However, there is no guarantee that interference will not occur in a particular installation. If this equipment does cause harmful interference to radio or television reception, which can be determined by turning the equipment off and on, the user is encouraged to try to correct the interference by one or more of the following measures:

- Reorient or relocate the receiving antenna.
- Increase the separation between the equipment and receiver.
- Connect the equipment into an outlet on a circuit different from that to which the receiver is connected.
- Consult the dealer or an experienced radio/ TV technician for help.

This device complies with part 15 of the FCC Rules. Operation is subject to the following two conditions:

1. This device may not cause harmful interference.
2. This device must accept any interference received, including interference that may cause undesired operation.

Any changes or modifications not expressly approved by the party responsible for compliance could void the user's authority to operate the equipment.

We, **TP-Link USA Corporation**, has determined that the equipment shown as above has been shown to comply with the applicable technical standards, FCC part 15. There is no unauthorized change is made in the equipment and the equipment is properly maintained and operated.

Issue Date: 2023-07-21

CE Mark Warning



This is a class B product. In a domestic environment, this product may cause radio interference, in which case the user may be required to take adequate measures.

OPERATING FREQUENCY (the maximum transmitted power)

2412MHz—2472MHz (20dBm)

EU Declaration of Conformity

TP-Link hereby declares that the device is in compliance with the essential requirements and other relevant provisions of directives 2014/53/EU, 2009/125/EC, 2011/65/EU and (EU)2015/863.

The original EU Declaration of Conformity may be found at <https://www.tapo.com/en/support/ce/>.

RF Exposure Information

This device meets the EU requirements (2014/53/EU Article 3.1a) on the limitation of exposure of the general public to electromagnetic fields by way of health protection.

The device complies with RF specifications when the device used at 20 cm from your body.

UKCA Mark



UK Declaration of Conformity

TP-Link hereby declares that the device is in compliance with the essential requirements and other relevant provisions of the Radio Equipment Regulations 2017.

The original UK Declaration of Conformity may be found at <https://www.tapo.com/support/ukca/>.

Canadian Compliance Statement

This device contains licence-exempt transmitter(s)/receiver(s) that comply with Innovation, Science and Economic Development Canada's licence-exempt RSS(s). Operation is subject to the following two conditions:

1. This device may not cause interference.
2. This device must accept any interference, including interference that may cause undesired operation of the device.

L'émetteur/récepteur exempt de licence contenu dans le présent appareil est conforme aux CNR d'Innovation, Sciences et Développement économique Canada applicables aux appareils radio exempts de licence. L'exploitation est autorisée aux deux conditions suivantes :

1. l'appareil ne doit pas produire de brouillage;
2. l'utilisateur de l'appareil doit accepter tout brouillage radioélectrique subi, même si le brouillage est susceptible d'en compromettre le fonctionnement

Radiation Exposure Statement:

This equipment complies with IC radiation exposure limits set forth for an uncontrolled environment. This equipment should be installed and operated with minimum distance 20cm between the radiator & your body.

Déclaration d'exposition aux radiations:

Cet équipement est conforme aux limites d'exposition aux rayonnements IC établies pour un environnement non contrôlé. Cet équipement doit être installé et utilisé avec un minimum de 20 cm de distance entre la source de rayonnement et votre corps.

Industry Canada Statement

CAN ICES-3 (B)/NMB-3(B)



Korea Warning Statements:

당해 무선설비는 운용중 전파혼신 가능성이 있음.

NCC Notice & BSMI Notice

注意!

取得審驗證明之低功率射頻器材，非經核准，公司、商號或使用者均不得擅自變更頻率、加大功率或變更原設計之特性及功能。

低功率射頻器材之使用不得影響飛航安全及干擾合法通信；經發現有干擾現象時，應立即停用，並改善至無干擾時方得繼續使用。

前述合法通信，指依電信管理法規定作業之無線電通信。

低功率射頻器材須忍受合法通信或工業、科學及醫療用電波輻射性電機設備之干擾。

為避免本器材影像畫面遭偷窺或擷取，本器材使用者應先修改預設密碼，並定期更新密碼。

安全諮詢及注意事項

- 請使用原裝電源供應器或只能按照本產品注明的電源類型使用本產品。
- 清潔本產品之前請先拔掉電源線。請勿使用液體、噴霧清潔劑或濕布進行清潔。
- 注意防潮，請勿將水或其他液體潑灑到本產品上。
- 插槽與開口供通風使用，以確保本產品的操作可靠並防止過熱，請勿堵塞或覆蓋開口。
- 請勿將本產品置放於靠近熱源的地方。除非有正常的通風，否則不可放在密閉位置中。
- 不要私自拆開機殼或自行維修，如產品有故障請與原廠或代理商聯繫。
- 電源供應器應使用在環境溫度低於或等於40°C的室內。

限用物質含有情況標示聲明書

設備名稱：Smart Wire-Free Security Camera		型號（型式）：Tapo C425/TC85				
Equipment name		Type designation (Type)				
單元 Unit	限用物質及其化學符號 Restricted substances and its chemical symbols					
	鉛 Lead (Pb)	汞 Mercury (Hg)	鎘 Cadmium (Cd)	六價鉻 Hexavalent chromium (Cr ⁺⁶)	多溴聯苯 Polybrominated biphenyls (PBB)	多溴二苯醚 Polybrominated diphenyl ethers (PBDE)
PCB	○	○	○	○	○	○

外殼	○	○	○	○	○	○
電源供應器	—	○	○	○	○	○
其他及其 配件	—	○	○	○	○	○

備考 1. “超出 0.1 wt %” 及 “超出 0.01 wt %” 係指限用物質之百分比含量超出百分比含量基準值

Note 1: “Exceeding 0.1 wt %” and “exceeding 0.01 wt %” indicate that the percentage content of the restricted substance exceeds the reference percentage value of presence condition.

備考 2. “○” 係指該項限用物質之百分比含量未超出百分比含量基準值。

Note 2: “○” indicates that the percentage content of the restricted substance does not exceed the percentage of reference value of presence.

備考 3. “—” 係指該項限用物質為排除項目。

Note 3: The “—” indicates that the restricted substance corresponds to the exemption.



Продукт сертифіковано згідно с правилами системи УкрСЕПРО на відповідність вимогам нормативних документів та вимогам, що передбачені чинними законодавчими актами України.

EAC

Safety Information

- Do not use damaged charger or USB cable to charge the device.
- Do not use any other chargers than those recommended.
- Do not use the device where wireless devices are not allowed.
- Adapter shall be easily accessible.
- Use only power supplies which are provided by manufacturer and in the original packing of this product. If you have any questions, please don't hesitate to contact us.
- Keep the device away from fire or hot environments. DO NOT immerse in water or any other liquid.
- Do not disassemble, repair or modify the product.
- Do not place near automatically controlled devices such as fire alarms. Radio waves emitted from this product may cause such devices to malfunction resulting in an accident.
- Observe restrictions on using wireless products in fuel depots, chemical plants or when blasting operations are in progress.
- Do not use liquid to clean the product. Only use a dry cloth.
- Never put metal objects inside the product. If a metal object enters the product turn off the circuit breaker and contact an authorised electrician.
- This product is not intended to be used when providing medical care. Consult the manufacturer of any personal medical devices, such as pacemakers or hearing aids to determine if they are adequately shielded from external RF (radio frequency) energy.
- Do not use this product in health care facilities. Hospitals or health care facilities may be using equipment that could be sensitive to external RF energy.
- Do not place heavy objects on top of the product.
- When you leave the product unused for a long time unplug the product from the power outlet.
- This product may interfere with other electronic products such as TV, radios, personal computers, phones or other wireless devices.
- Operating Temperature: -20°C ~ 45°C (-4°F ~ 113°F)
- When mounting the camera with the magnetic base, we recommend installing it no higher than 2 meters.
- Adapter should be used indoors where the ambient temperature is lower than or equal to 40°C.

CAUTION!













Avoid replacement of a battery with an incorrect type that can defeat a safeguard. Avoid disposal of a battery into fire or a hot oven, or mechanically crushing or cutting of a battery, that can result in an explosion.











Do not leave a battery in an extremely high temperature surrounding environment that can result in an explosion or the leakage of flammable liquid or gas; Do not leave a battery subjected to extremely low air pressure that may result in an explosion or the leakage of flammable liquid or gas.

Please read and follow the above safety information when operating the device. We cannot guarantee that no accidents or damage will occur due to improper use of the device. Please use this product with care and operate at your own risk.

Explanation of the symbols on the product label

Note: Symbols may vary from products.

Symbol	Explanation
	Class II equipment
	Class II equipment with functional earthing
	Alternating current
	DC voltage
	Polarity of output terminals
	Indoor use only
	Dangerous voltage
	Caution, risk of electric shock
	Energy efficiency Marking
	Protective earth
	Earth
	Frame or chassis

Symbol	Explanation
	Functional earthing
	Caution, hot surface
	Caution
	Operator's manual
	Stand-by
	"ON"/"OFF" (push-push)
	Fuse
	Fuse is used in neutral N
	<p>RECYCLING</p> <p>This product bears the selective sorting symbol for Waste electrical and electronic equipment (WEEE). This means that this product must be handled pursuant to European directive 2012/19/EU in order to be recycled or dismantled to minimize its impact on the environment.</p> <p>User has the choice to give his product to a competent recycling organization or to the retailer when he buys a new electrical or electronic equipment.</p>
	Caution, avoid listening at high volume levels for long periods
	Disconnection, all power plugs

Symbol	Explanation
m	Switch of mini-gap construction
μ	Switch of micro-gap construction (for US version) Switch of micro-gap / micro-disconnection construction (for other versions except US)
ε	Switch without contact gap (Semiconductor switching device)