

# LP-100A

## Digital Vector RF Wattmeter



## Assembly & Operations Manual

June 2012  
TelePost Incorporated  
Rev. G14

Covers LP-100A serial numbers starting  
at 2020, and firmware beginning at v1.2.3.1

# Compliance Statements...



## Federal Communications Commission Statement (USA)

This device complies with Part 15 of the FCC Rules. Operation is subject to the following two conditions: (1) this device may not cause harmful interference, and (2) this device must accept any interference received, including interference that may cause undesired operation.



## European Union Declaration of Conformity

TelePost Inc. declares that the product:

**Product Name: Digital Vector RF Wattmeter**

**Model Number: LP-100(A)**

**Conforms to the following Product Specifications:**

**EN 55022: 1998 Class B**

following the provisions of the Electromagnetic Compatibility Directive 89/336/EEC, tested and verified 3-17-2006 at FCC accredited laboratory.

## Industry Canada Compliance Statement

Canada Digital Apparatus EMI Standard

This Class B digital apparatus meets all the requirements of the Canadian Interference-Causing Equipment Regulations.

Cet appareil numérique de la classe B respecte toutes les exigences du Règlement sur le matériel brouilleur du Canada.

## Copyright and Trademark Disclosures

LP-100(A) is a trademark of TelePost Inc. Windows® is a registered trademark of Microsoft Corporation. Teflon® is a registered trademark of E.I. du Pont de Nemours and Company. PICmicro® is a registered trademark of MicroChip Technology Inc.

Material in this document copyrighted © 2012 TelePost Inc. All rights reserved. All firmware and software used in the LP-100(A), VCP and Plot programs copyrighted © 2004-2012 TelePost Inc. All rights reserved. MicroCode Loader is a copyrighted program from Mecanique, <http://www.mecanique.co.uk/>.

# Table of Contents

Introduction .....	4
Parts List .....	5
Meter Assembly.....	9
Coupler Assembly .....	15
Setup .....	24
Calibration .....	26
Operation.....	30
Circuit Description .....	35
Schematic .....	37
Troubleshooting .....	39
Software .....	40
Specifications and CAL Table .....	46
Warranty .....	47
Appendix A .....	48

# Introduction

The LP-100 is designed as an accurate instrument for monitoring station performance. It provides a number of unique features not seen before in a ham radio wattmeter.

The most obvious of these is the vector display. This display shows the complex impedance of the load in two ways. The top line of the display shows impedance in polar form... i.e., magnitude and phase of the impedance. The bottom line shows the real and imaginary components of impedance... i.e.,  $R + jX$ . The parameters are displayed in a range of 0.1 to 999.9 ohms. Phase is displayed in 0.1 degree increments from 0-90 degrees.

Features include...

- Fast, high contrast GVFD display with bargraphs for power and SWR, along with numerical readout for both
- Bargraphs customizable for style, decay, behavior and range
- Professional dBm / Return Loss display
- 50 mW to 3000W with three autoranging scales (options for 5 & 10KW)
- Power display resolution of 0.01 to 1W depending on scale
- Frequency coverage of 1.8-54 MHz, with automatic per-band correction
- Z, R,  $|X|$  display from 0-999.9 ohms each
- Separate coupler with 50 ohm ports for uncluttered desktop
- Peak-hold numerical power readout with "hang" characteristic for power and SWR
- SWR accuracy < .15 (5%) from about .1W to 3000W, .05 typical
- Power accuracy is 3% typical at any rated power level or frequency from 1W to 3000W after calibration, usable to 0.05W
- Can be easily matched in the field to external standard to within 0.1% on each band
- Power display is Fwd or Net power delivered to the load ( Fwd minus Ref power).
- SWR Alarm system with set points for Off, 1.5, 2.0, 2.5, 3.0 and user setting. Includes "snooze" button for tuning, and power threshold.
- Windows freeware Virtual Control Panel for software / remote control
- Support within TRX-Manager for direct remote monitoring
- Advanced automatic charting capability for SWR, RL, Z, R, X , reflection coefficient and Smith Chart
- Built-in bootloader to allow for firmware upgrades to be downloaded and installed.
- Call sign screen saver to extend life of display, scrolls a full screen call sign across the screen. Call sign is set in Setup screen.
- Direct input for bench testing & field strength measurements, -15 to +33 dBm.
- Conforms to FCC Part 15 A & B, ICAS and CE radiated emission limits, tested and verified by accredited lab

This manual will address the assembly of the LP-100A, initial checkout, calibration and operation. You may wish to read through the circuit description and study the schematic before beginning assembly to familiarize yourself with the project. **It is highly recommended that you thoroughly read through the [Assembly](#) section before even unpacking the LP-100A kit.**

## RoHS Statement

The EU adopted a set of standards for the "Reduction of Hazardous Substances" in July 2006. There is considerable confusion over which devices and companies are affected by the new rules. It is our opinion that home-built kits are exempt from this legislation, and there may well be a further exemption under the heading "Measurement Equipment" for the LP-100A. Also, since TelePost does not have a presence in Europe, we do not import to or export from a member State, as stipulated in the rules.

Regardless of these exemptions, we provide 100% RoHS compliant parts, PCBs and assembly processes for LP-100As exported to EU member countries and other countries with lead restrictions. For LP-100As shipped to other countries, we use leaded solder to eliminate any possibility of reduced performance or reliability over time. We recommend the use of standard Pb/Sn alloy solders for assembly of LP-100A kits, mainly for performance and longevity reasons. This is perfectly acceptable under the rules for "own use built equipment (hobbyist)". Use of lead-free solder is also permissible, since the PCBs are lead-free, but be aware that special equipment and techniques are required to use lead-free solder, and PCB rework has a higher chance of damaging the PCB.

In summary, the LP-100A is as lead-free as possible without compromising performance, long-term reliability or local restrictions, and builders in member States are free to assemble an LP-100A with whatever solder they wish.

## Hardware Upgrades

Starting with serial #101, the LP-100 uses an upgraded PIC processor, with twice the memory of the previous chip. Starting with serial number 701 (LP-100A), a new display is used in the LP-100, with some PCB changes to support it. There is an upgrade path to the LP-100A display. Contact the factory for details.

# Parts List - Subject to change without notice. Pictures shown at end of parts list.

## Pre-installed SMT parts

QTY	Part No.	Description
4	C9,10,12,13	0.01uF 50V
2	R4,18	Resistor 26.7 1% .25W
2	R5, 12	Resistor 49.9 1% .5W
2	R6,21	Resistor 56.2 1% .25W
2	R9, 27	Resistor 56.2 1% .5W
2	R10, 20	Resistor 422 1% .25W
1	R24	Resistor 174 1% .25W
1	R30	Resistor 120 1% .25W
1	R33	Resistor 32.4 1% .25W
1	R35	Resistor 75 1% .25W
1	D8	HSMS-2805 dual Schottky diode
1	U1	AD8302
1	U9	AD8367
1	U10	ADCMP600
1	T1	ADP-2-1W Combiner

## Parts to be installed – main chassis

QTY	Part No.	Description
16	C1,2,4,5,6,7,11,14, 20,22,30,32,33,34,47,48	0.1uF monolithic, 25 or 50V marked 104 <b>(Fig. 1)</b>
3	C3,41,44	10uF electrolytic, 25, 50 or 63V <b>(Fig. 2)</b>
6	C8,21,28,29,38,39	0.01uF ceramic, 25 or 50V marked 103 <b>(Fig. 3)</b>
8	C15,16,17,18,19,31,35,49	1uF electrolytic, 25 or 50V <b>(Fig. 2)</b>
4	C23,24,25,26	0.001uF ceramic, marked 102 <b>(Fig. 3)</b>
1	C36	330pF ceramic, 50V marked 331 <b>(Fig. 3)</b>
1	C37	39pF or 47pF Silver Mica marked 39J or 47J <b>(Fig. 4)</b>
1	D1	1N4740A 10V Zener <b>(Fig. 21, large glass diode)</b>
1	D2	Rt. Ang. LED Red <b>(Fig. 16)</b>
1	D3	Rt. Ang. LED Green <b>(Fig. 16)</b>
1	D4	1N4001 <b>(Fig. 20)</b>
1	D5	1N4148 <b>(Fig. 21, small glass diode)</b>
1	RC1	flex cable assembly <b>(Fig. 43)</b>
1	J5	6-pin SIL header for display <b>(Fig. 19)</b>
1	JP3	8-pin SIL header for dual input daughtercard <b>(Fig. 19)</b>
2	J2,7	BNC jack, rt. Angle <b>(Fig. 47)</b>
1	J3	Power jack 2.5mm <b>(Fig. 14)</b>
1	J4	DB9 PCB mount <b>(Fig. 51)</b>
1	J6	Dual RCA PCB mount <b>(Fig. 13)</b>
1	JP1	2-pin SIL header <b>(Fig. 18)</b>
3		Shorting jumper <b>(Fig. 18)</b>
4	L1,2,3,5	1mH, 100mA molded choke (brown body) (br-blk-red-gold) <b>(Fig. 5)</b>
2	L4, 6	330uH, 30 mA molded choke (brown body) (or-or-br-gold) <b>(Fig. 6)</b>
1	VFD-1	Graphic VFD display 140x16 <b>(Glass...handle carefully.) (Fig. 35)</b>
1		Neutral density filter for display <b>(Fig. 34)</b>
2	R1,13	1M 1% 1/8w br-blk-blk-yel-br <b>(Fig. 23)</b>
3	R2,43,45	10k 5% 1/8w br-blk-or <b>(Fig. 23)</b>
8	R3,7,11,14,16,17,34,36	1k 5% 1/8w br-blk-red <b>(Fig. 23)</b>
2	R19,29	4.7 5% 1/4W yel-viol-gold <b>(Fig. 23)</b>
1	R22	150k 1% 1/8W br-grn-blk-or-br <b>(Fig. 23)</b>
2	R23,25	10k 1% 1/8w br-blk-blk-red-br <b>(Fig. 23)</b>
1	R26	6.34k 1% 1/8W blu-or-yel-br-br <b>(Fig. 23)</b>
2	R28,40	2.0k 5% 1/8W red-blk-red <b>(Fig. 23)</b>
1	R31	100 ohms 5% 1/8W br-blk-br <b>(Fig. 23)</b>

# Parts List – Cont'd

QTY	Part No.	Description
2	R8,44	220 ohms 5% red-red-br, <b>R8 = 1/4W, R44 = 1/8W (Fig. 23)</b>
1	RL1	Omron G5V-2-H1-DC5 <b>(Fig. 46)</b>
1	S1	CEM-1212C Piezo transducer <b>(Fig. 12)</b>
3	SW1, 2, 3	4mm tactile switch, rt. Angle & keycaps <b>(Fig. 10)</b>
1	SW4	DPDT pushbutton switch & keycap <b>(Fig. 7)</b>
1	Q1	2N4401 <b>(Fig. 17)</b>
1	U2	LM7805 <b>(Fig. 49)</b>
1	U3	18F2620 PIC Microcontroller <b>(Fig. 48)</b>
1	U4	TLC-271BCP <b>(Fig. 48)</b>
1	U5	MAX6225BEP A <b>(Fig. 48)</b>
1	U6	MAX232N <b>(Fig. 48)</b>
1	U7	LM34DZ <b>(Fig. 17)</b>
1	U8	MCP3304 <b>(Fig. 48)</b>
1	U11	18F1320 PIC Microcontroller <b>(Fig. 48)</b>
1	Y1	Crystal, 10 MHz <b>(Fig. 22)</b>
1		Pwr Cable 2.5mm <b>(Fig. 15)</b>
1	Enclosure	Main Enclosure (top & bottom) <b>See Assembly Section.</b>
1	PCB	Main PCB w/pre-installed SMT parts <b>See Assembly Section.</b>
1	Heatsink	Heatsink for 7805 regulator <b>(Fig. 11)</b>
2	IC Socket	8-pin sockets <b>(Fig. 50)</b>
2	IC Socket	16-pin sockets (Socket not used for the relay) <b>(Fig. 50)</b>
1	IC Socket	28-pin socket <b>(Fig. 50)</b>
1	IC Socket	18-pin socket <b>(Fig. 50)</b>
4	Rubber Feet	Round <b>(Fig. 33)</b>

## Parts to be installed – coupler

QTY	Part No.	Description
1	Enclosure	Coupler <b>(Fig. 36)</b>
1	PCB	Coupler <b>(Fig. 38)</b>
2	T1, 2	Toroid cores FT140-61 <b>(Fig. 30)</b>
2	UHF Connector	SO-239, Teflon® / silver <b>(Fig. 42b- supplied in bags)</b>
2	BNC Connector	UG1094/U <b>(Fig. 44 - supplied in bags)</b>
2	BNC cable	6' (1.83m) M/M – RG58U <b>(Fig. 37- may be in bags)</b>
4	R3, 4, 9,10	75 ohm 1% 1W (2512 SMT) <b>(See text for LPC4, LPC5) (Fig. 9)</b>
8	R1, 2, 5-8, 11,12	301 ohm 1% 1W (2512 SMT) <b>(See text for LPC4, LPC5) (Fig. 9)</b>
1	Teflon® bushing	With 3/8" hole (9.54mm) <b>(See text for LPC4, LPC5) (Fig. 31)</b>
1	Teflon® bushing	With 1/16" hole (1.59mm) <b>(Fig. 31)</b>
2	Adhesive Teflon® tape	~0.5" ((12.72mm) <b>(Fig. 39)</b>
1	Terminal Strip	2 lug terminal strip <b>(Fig. 8)</b>
1	#20 wire for xfms	(2) 45" (1.14m) lengths
1	RG-393/U Teflon® coax	(1) 2" (5.08cm) length <b>(See text for LPC4, LPC5) (Fig. 40)</b>
1	RG-316U Teflon® coax	(1) 2" (5.08cm) length <b>(Fig. 40)</b>
4	Rubber Feet	Round <b>(Fig. 32)</b>
1	Nylon Tie Wrap	For Current Xfmr
1	Adhesive Label	Coupler Top Label <b>(Fig. 41)</b>

# Parts List – Cont'd

## Hardware

QTY	Part No.	Description
1		4-40 x 0.625" (1.59cm) threaded standoff – may be hex or round (Fig. 24)
1		4-40 x 0.75" (1.91mm) machine screw (Fig. 25)
14		#4 self-tapping screws – 1/4" (6.35mm) – plated (for coupler)
14		#4 lockwashers (11 for coupler, 3 for main chassis) (Fig. 26)
1		#4 split lockwasher for coupler PCB (Fig. 26)
11		4-40 x 3/8" (9.53mm) machine screws – plated (9 for coupler, 2 for DB9) (Fig. 25)
3		4-40 x 1/4" (6.35mm) machine screws pltd (2 for coupler, 1 for heatsink) (Fig. 25)
12		4-40 nuts – large (for coupler, DB9 and heat sink) (Fig. 45)
1		4-40 nut – small (for coupler PCB) (Fig. 45)
8		4-40 x 3/16" (4.76mm) machine screws –black (for mounting main PCB) (Fig. 28)
8		4-40 x 1/4" (6.35mm) machine screws – black (for mounting display) (Fig. 28)
4		4-40 x 1/4" (6.35mm) threaded standoffs (for mounting main PCB) (Fig. 24)
4		4-40 x 3/8" (9.53mm) threaded standoffs (for mounting display) (Fig. 24)
6		#4 x 1/4" (6.35mm) self-tapping screws – black (for main enclosure) (Fig. 27)
1		#4 x 1/4" (6.35mm) self-tapping screw – black (for RCA connector) (Fig. 27)
2		Jack screw for DB9 (Fig. 51)
2		#4 lockwasher (Fig. 51)
2		1/2" plug for coupler holes (not used with dual coupler option) (Fig. 52)
2		#4 Solder Lug (Fig. 29)

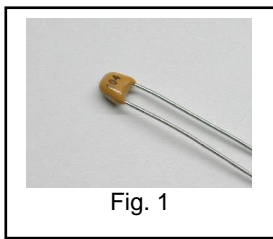

Fig. 1

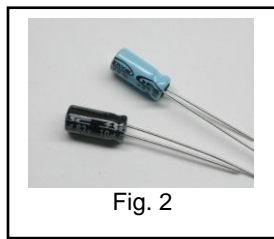

Fig. 2

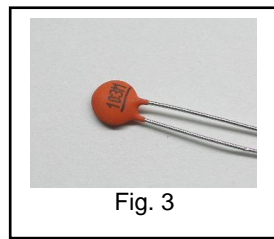

Fig. 3

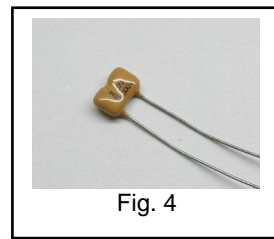

Fig. 4

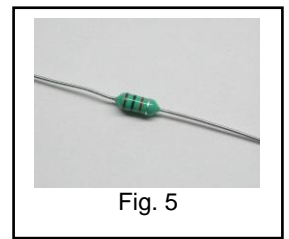

Fig. 5

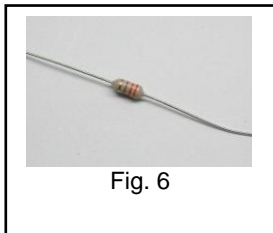

Fig. 6



Fig. 7

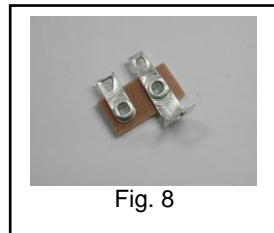

Fig. 8

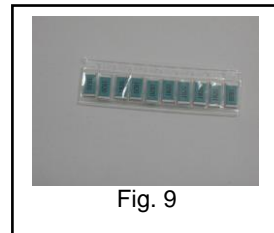

Fig. 9

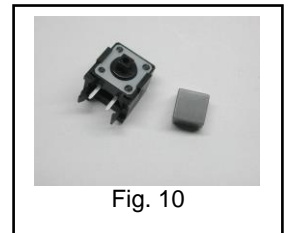

Fig. 10

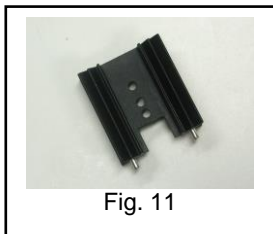

Fig. 11



Fig. 12

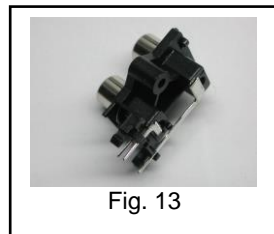

Fig. 13

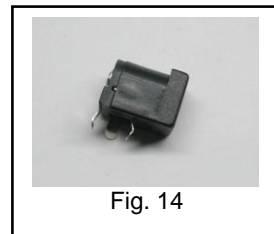

Fig. 14



Fig. 15



Fig. 16

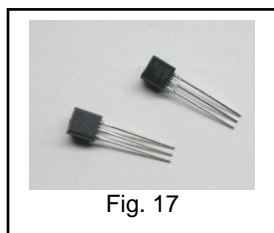

Fig. 17

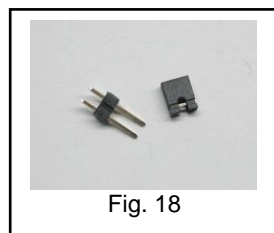

Fig. 18

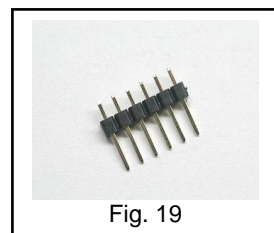

Fig. 19

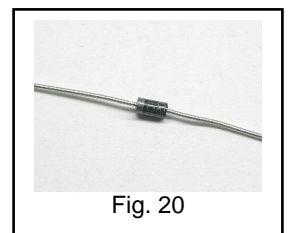
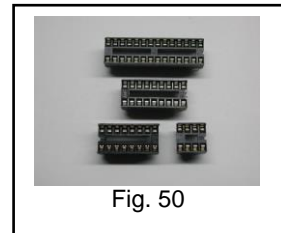
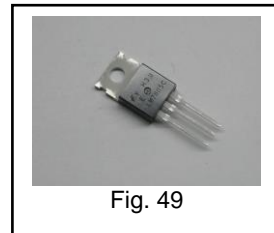
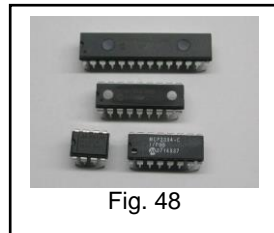
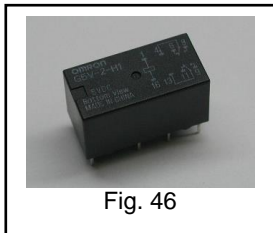
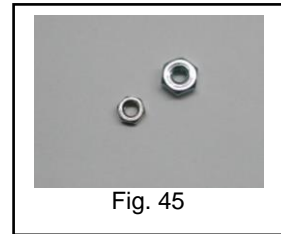
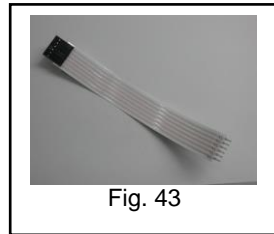
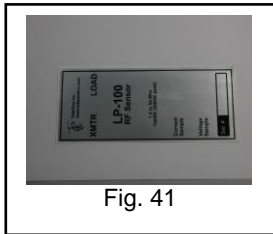
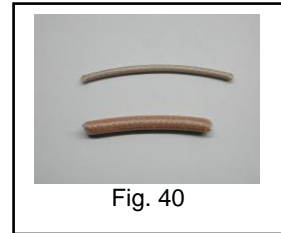
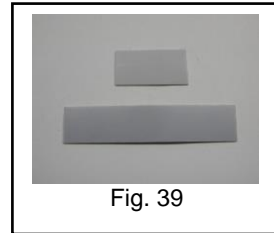
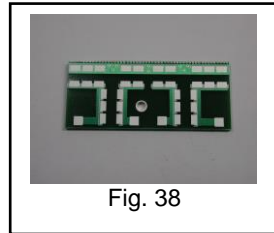
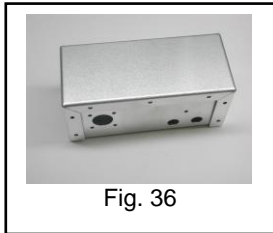
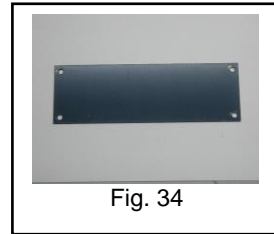
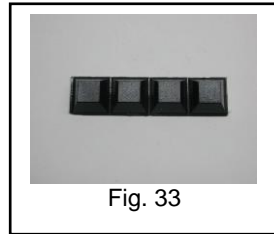
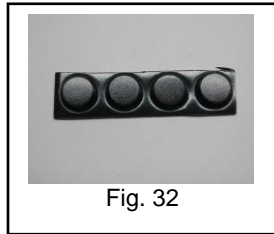
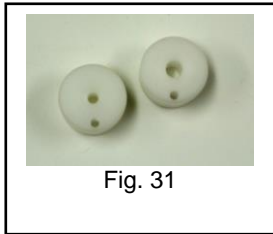
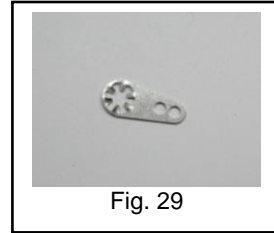
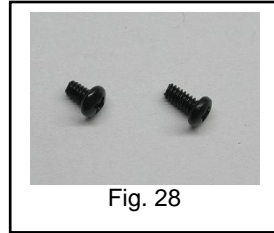
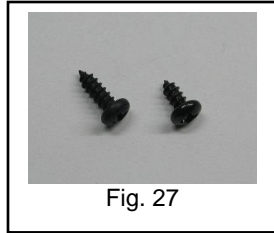
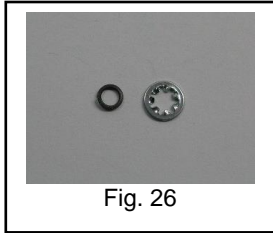
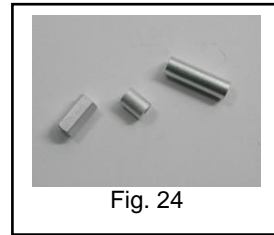
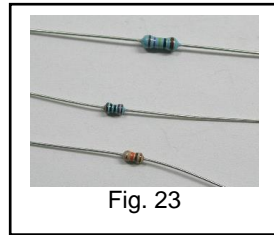
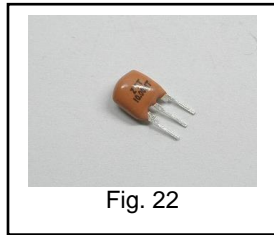
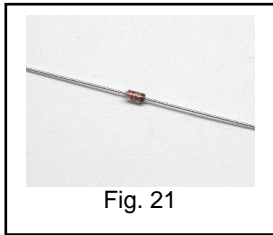

Fig. 20

# Parts List – Cont'd





# Assembly

## Important warnings – read this before starting assembly

You should visually inspect all the solder pads/traces with a magnifier for any etching problems. This is done before shipping, but I recommend the builder do a second inspection as well. We also now do 100% continuity checks of all pads before shipment using computer controlled flying probes based on PCB netlist coordinates.

All of the SMT components are pre-installed on the main board for your convenience. SMT parts are supplied wherever necessary for performance or availability reasons. **CAUTION:** Be very careful handling this board to avoid damage to the installed parts. Anti-static measures are highly recommended, such as use of an anti-static mat, grounded soldering iron and wrist band.

You may wish to clean the flux from the board after assembly, although it is not necessary with most modern solders. A toothbrush and alcohol are good for this. Only use rosin core solder. Use of acid core solder voids the warranty. Lead-free solder is OK, and the boards are RoHS compliant, but it will be more difficult to remove parts without damaging the board should you have to.

## Overview

Below is the component placement diagram for the main PCB. These markings match the silk-screening on the PCB, but are repeated here for clarity. You can also cross out the parts on this graphic as they are installed. The map coordinates match the component locations on the next page. **Note:** Use this manual only for assembly of LP-100A. For serial numbers before 701, see LP-100 web page for appropriate manual to use.

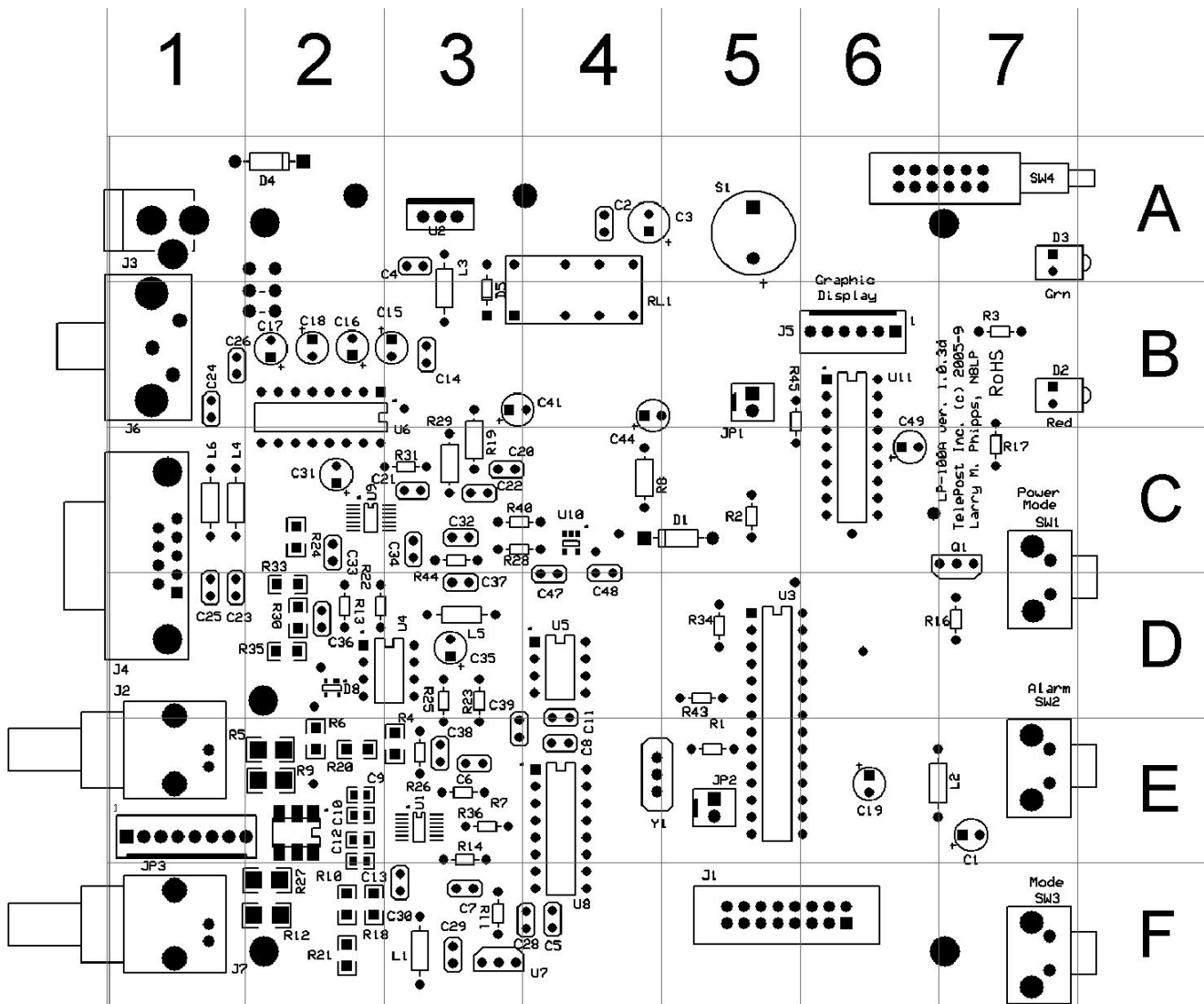

# Assembly Cont'd

You should check all parts before starting to allow you to start the process of obtaining replacement parts as soon as possible. It is also a good idea to sort the parts in advance... egg cartons are handy for this (passive parts only). Many crafts stores, Like Michael's, also have nice plastic cases with dividers at low prices.

Below is a map of part locations, courtesy of Tony, K1KP. The grid coordinates can be matched up with the component layout map on the previous page to help locate each part.

Part	Grid	Part	Grid	Part	Grid	Part	Grid
C1	E7	C39	D3	L5	D3	R4	E3
C10	E2	C4	A3	L6	C1	R40	C3
C11	D4	C41	B4	Q1	C7	R43	D5
C12	E2	C44	B4	R1	E5	R44	C3
C13	E2	C47	C4	R10	F2	R45	B5
C14	B3	C48	C4	R11	F3	R5	E2
C15	B3	C49	B6	R12	F2	R6	D1
C16	B2	C5	F4	R13	D2	R7	E3
C17	B2	C6	E3	R13	D2	R8	C4
C18	B2	C7	F3	R14	E3	R9	E2
C19	E6	C8	E4	R16	D7	RL1	A4
C2	A4	C9	E2	R17	B7	S1	A5
C20	C3	D1	C5	R18	F2	SW1	C7
C21	C3	D2	B7	R19	B3	SW2	D7
C22	C3	D3	A7	R2	C5	SW3	F7
C23	D1	D4	A2	R20	E2	SW4	A7
C24	B1	D5	A3	R21	F2	U1	E3
C25	D1	D8	D2	R22	D2	U10	C4
C26	B1	J1	F5	R23	D3	U11	B6
C28	F4	J2	E1	R24	C2	U2	A3
C29	F3	J3	A1	R25	D3	U3	D5
C3	A4	J4	D1	R26	E3	U4	D3
C30	F3	J5	B6	R27	F2	U5	D4
C31	C2	J6	B1	R28	C3	U6	B2
C32	C3	J7	F1	R29	C3	U7	F3
C33	C2	JP1	B5	R3	B7	U8	F4
C34	C3	JP2	E5	R30	D2	U9	C2
C35	D3	JP3	E1	R31	C3	Y1	E5
C36	D2	L1	F3	R33	C2		
C37	C3	L2	E7	R34	D5		
C38	E3	L3	A3	R35	D2		
C39	D3	L4	C1	R36	E3		

# Assembly Cont'd

## Pre-assembly overview.

When assembly starts it will roughly follow this order...

- Installation of all IC sockets
- Installation of resistors
- Installation of capacitors
- Installation of connectors and switches
- Installation of 7805 regulator
- Installation of jumpers for PTT
- Installation of chokes selectively as outlined in the instructions

**Note: Nothing is installed at J1. It is provided for industrial versions which use a large character based VFD display.**

The idea is be able to lay the board flat as much as possible during construction... Especially during socket installation. Following this order will also facilitate initial checkout. The chokes will be selectively installed to allow for checkout of various sections of the circuit.

Checkout will roughly follow this order...

- Verify proper +5vdc before powering any devices
- Installation of U2, L2, U3, U11 and GVFD cable to check for proper display and PIC operation
- Installation of L1, L3, U5, U7 and U8 to verify proper operation of ADC and frequency counter
- Installation of L5 and U4 and verify proper power detection
- Installation of U6 and verify proper serial port operation

The above checks will require only a DVM and the Setup screens except for the power display check. To check the power display, you will need a transmitter and completed coupler. **I will list expected current drain in red at each step so that you can verify that nothing is shorted in each section. A current limited or fused power supply with 0.50 amp maximum fuse should be used during checkout.**

To calibrate the power readings of the LP-100A will require a minimum of an accurate 50-ohm dummy load and a means to measure rf power. You will need a diode peak detector or a calibrated oscilloscope to measure rf voltage across the load. An alternative would be an accurate reference wattmeter.

To calibrate the impedance gain and phase detectors you will also need a 25 ohm dummy load. This can be easily made up out of inexpensive 3W, 5% metal oxide resistors, such as used in my LP-200 or the Elecraft DL-1. Alternatively, you can use a pair of 50 ohm dummy loads with coax adapters to allow them to be paralleled to provide 25 ohms. This calibration can be done with as little as 5W of power. This adjustment is not imperative, as the default value is quite acceptable.

SWR calibration requires setting offset and slope adjustments for the AD8302 gain detector. Calibration of the AD8302 phase detector requires a delay line of known electrical length. You can get pretty close by using a high quality piece of poly dielectric RG-58, and calculate the electrical length in degrees using the following formula...

$$\text{Phase} = (360 * L * F) / (984 * VF)$$

Where Delay is in degrees, L is in feet and F in MHz. VF would be 0.66 for poly dielectric. A convenient length is about 6' (1.83m), which would provide a delay of ~45 degrees (the center of the range) at 14 MHz. You will find more about calibration in the **Calibration** section. I am contemplating an inexpensive calibration kit in the \$25 range, which would include a switchable dummy load PCB and pre-cut delay line. I will also calibrate any assembled LP-100 kit free of charge if you pay for return shipping.

You will need the following tools to complete assembly...

- Adjustable soldering iron – 800 degrees maximum
- 60/40 alloy solder... .020" (0.51mm) diameter recommended for thermal pads
- Needle-nose pliers
- Wire cutters
- Small Philips head screwdriver
- Razor knife
- Digital Multimeter

**NOTE: The LP-100A is an intermediate level kit. If care is taken, you should have no difficulty building it. I would peg the assembly time at about 8 hours total, plus some reading through the manual in advance, and some time for calibration afterward. Take your time, and double-check your work.**

# Assembly Cont'd

## Step-by-step assembly instructions for main board.

Below is a picture of the assembled PCB. The SMT parts come pre-installed.

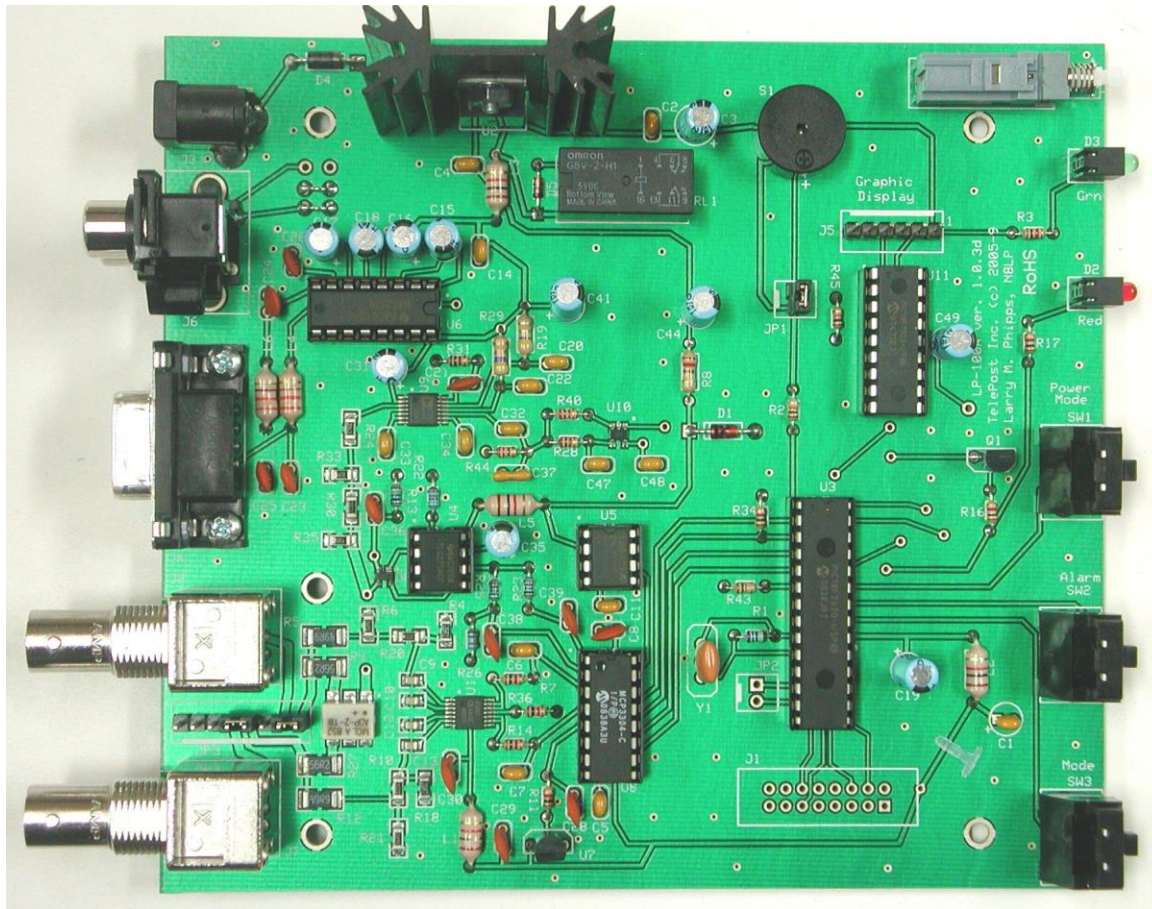

It is recommended that you print this manual to allow for easy reference while building, and to allow you to check off the steps as you complete them. There will also be a table of calibration values you can enter as you do the calibration. This will enable you to return to the original settings should you need to in the future.

Make sure your work area is static-free to avoid damage to the pre-installed SMT parts. It is also advisable to wear an anti-static wrist band. Refer to the parts placement graphic on page 6 or the above picture for questions regarding parts placement. You can zoom into the pdf version of this document for easier parts identification if needed.

- Install all IC sockets, keeping the board flat as you go to avoid gaps.
- Install resistors. To avoid messiness when trimming leads, I would do about 6 at a time. Follow the parts list and check them off as you go. If you are unsure of the colors used by some of the manufacturers for the color code, measure the value with a DMM.
- Install all .01 uF caps (marked 103).
- Install all .1 uF caps (marked 104). This should be done in at least two batches.
- Install remaining caps, leaving the electrolytics for last. Observe polarity on the electrolytics. Referring to the component placement guide and picture may help with parts placement.
- Install green and red LEDs. NOTE: Do not install these tight against the board. Because of manufacturing tolerances on these parts, they may not line up with the front panel holes when installed tight against the board. It is desirable to leave about 1/16" of spacing below the LEDs, so that they can be bent forward to line up if necessary.

# Assembly Cont'd

- ❑ Install miscellaneous parts such as the piezo transducer (S1), transistor, diodes, etc. Install the crystal (Y1). Note: this is shown in the pictures as a 3-pin resonator, but is now a 2-pin crystal. Ignore the center hole in the PCB. Do not install ICs yet or chokes yet. **NOTE: Remove the protective covering on the transducer before using. Also, the "+" lead goes to the side that connects to the jumper, per the placement guide. The outside leads of the resonator are interchangeable. Do not install chokes yet.**
- ❑ Install connectors, headers and switches, except for J4, the DB9 connector. You will probably have to prop sections of the board up to ensure that the parts are flush with the board.
- ❑ Install 7805 regulator (U2). Attach heatsink to the regulator before installing on PCB, using 4-40 x 1/4" (6.35mm) machine screw, #4 lockwasher and hex nut. The regulator sits on the inside edge of the heat sink, as shown above in the picture. Make sure you leave a little space between the bottom of the board and the heat sink to prevent any chance that the trace under the heat sink might get damaged. A good way to check this is to position the heat sink assembly, then solder just the center pin of the regulator. Make sure there is a small gap, that the heat sink is level and the tabs protrude through the board. Then solder the heat sink tabs to the board. For best results, you will need about 800-850 degrees F to do this. Finally, solder the remaining two regulator leads.
- ❑ Install L4 and L6. The remaining chokes will be installed as part of the initial checkout of the board, in order to enable powering up of circuits individually. These may be brown or green, but are smaller than the other chokes. **NOTE: If you check the chokes with an LC meter like the AADE, the readings may be low. This is because the chokes use ferrite cores, and the L varies with frequency. The little meters tend to test at very low frequencies.**

- ❑ The jumpers for the PTT connector can be wired now. The normal wiring is shown on the component placement diagram at the beginning of this chapter, and below. This provides for a normally closed connection between the center conductors of the two RCA connectors. This will work for most rig/amp combinations. For more options for PTT wiring, check out the SteppiR Tuning Relay section of my webpage.

← Back of board

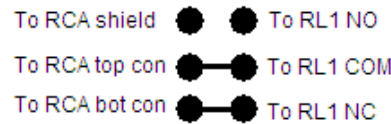

Normal connection for PTT loop-thru. The RCA connector wires go to the respective center conductors of the stacked jack. This configuration breaks the normally closed PTT connection from the rig to the amplifier when the alarm goes off.

- ❑ Install jumpers from pins 4-5 & 7-8 on JP3 at this time. These jumpers are required to connect the input connectors to the circuitry. JP3 will be used for the future dual coupler daughtercard.
- ❑ Attach J4, the DB-9 connector to the PCB using 4-40 x 3/8" (9.53mm) screws, lockwashers and hex nuts. The lockwashers and nuts go on the bottom of the board. Solder the pins after tightening the screws to avoid stressing the pins after soldering.
- ❑ You can install RL1 at this time.

## Initial checkout of main board.

- ❑ Make sure that your bench is clean and the PCB is not sitting on any cut off component leads. Connect supplied power cable to a supply of 12-15 VDC. The green LED should light. The dashed white lead on the supplied power cable is the + lead (center pin). Using your DMM, check for 5.0 VDC (+/- 0.25V) at pin 3 of U2 (the one nearest C2 & C3). Power down. **~21 mA.**
- ❑ Install U3, L2 and U11, being careful of proper orientation as indicated on silkscreen and component layout.
- ❑ Install 4-40 x 3/8" (9.53mm) standoffs on the front side of the GVFD module at the corners using the 4-40 x 1/4" black machine screws. These are the longer of the two sizes of 4-40 black machine screws provided. **Handle the display with care as it is mostly made of glass.**
- ❑ Install the flex ribbon cable to the back of the GVFD display. The silver colored trace should go to pin 1 on the display, as shown. Temporarily connect display to main board. Again, the silver colored trace should go to pin 1 on the display header.

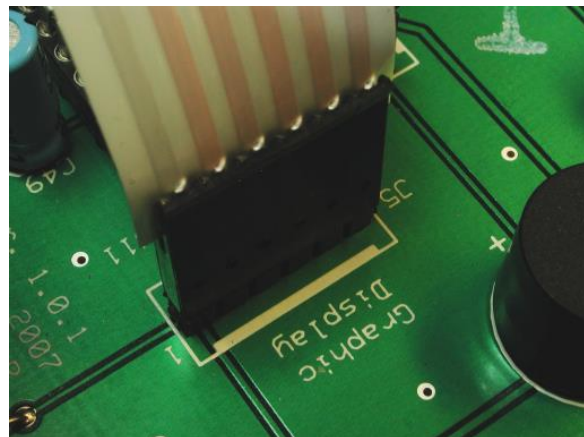
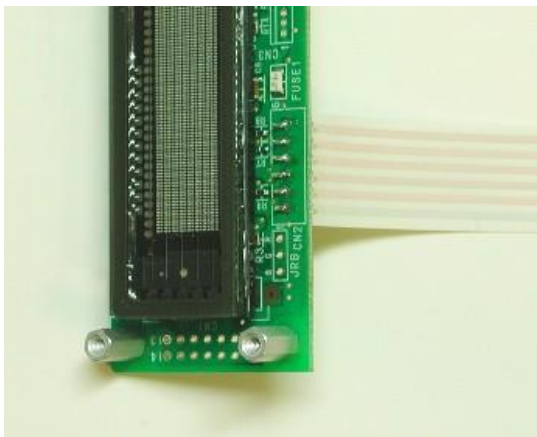

## Assembly Cont'd

- Power the board up again, and verify that you are seeing the “splash” screen with version and copyright information, followed by the main LP-100A screen. The main screen should look like this, but with no bargraph deflection and showing 0.00W and SWR=1.00. The display brightness will be full on the splash screen, and drop to 25% for the main screen. This is part of the screen saver function. It only happens in the main mode, since that is the most often used mode. Transmitting, or changing screens, will restore it to the brightness level you set later in setup (default is 75%). Power down. ~240/280mA. In all cases, the first current value is for the SS dim level, and the second is for the preset brightness level. The splash screen will be about 20mA higher than the preset level.



- Install L1, L3, U5, U7 and U8. ~280/320mA. Temporarily enter the Setup mode. Entering Setup is accomplished by holding the Mode button for about a second until the screen changes. You should now see the first Setup screen, shown here.



This screen shows the reference voltage generated by U1 (the gain/phase detector), the Received Signal Strength Indicator voltage from U9 (the AGC chip) and temperature in degrees F and C (from the temp sensor, U7). Note: the RSSI reading shown in this photo is with RF power applied. The resting voltage with no RF is generally between .150V and .250V. Temp will be in degrees F initially, but can be toggled to degrees C by tapping the Up button. To exit Setup mode, press and hold Mode button until you pass through the initial Calibration screen and return to the main screen. Power down.

- Install L5, U4 and U6 and check the current. ~285/325mA. If all is well, power down and set the board aside until the coupler assembly is completed to allow checkout of the power detector circuit and frequency counter.

# Assembly Cont'd

Step-by-step assembly instructions for the coupler.

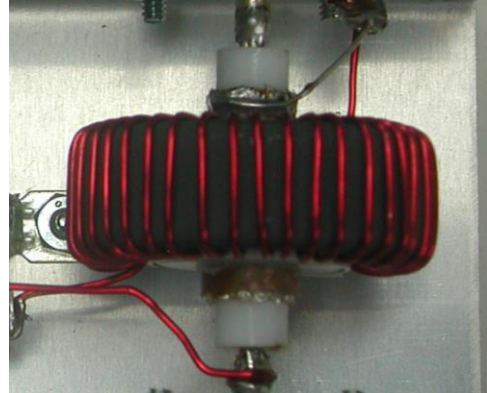
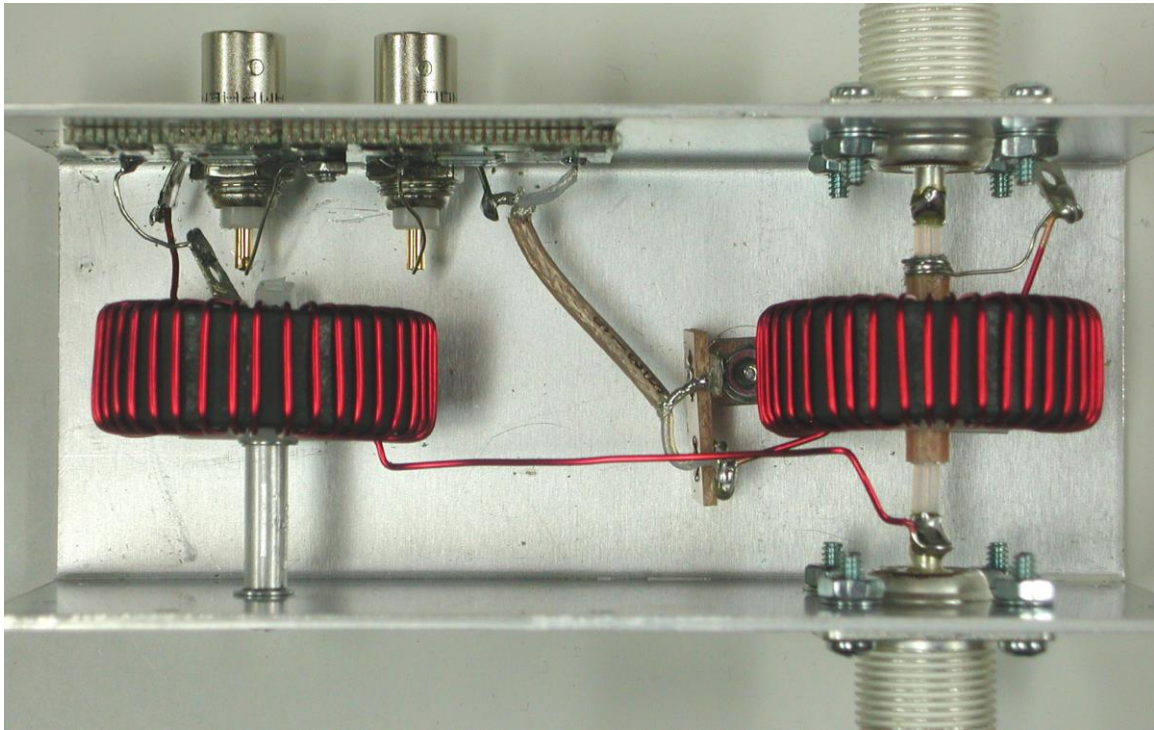

Refer to the drawing and pictures during assembly of the coupler. The top picture is courtesy of Dario, N5QVF, and shows the RG-142 sampling section previously used in the LPC1. The lower right one is of the larger LPC2 / LPC4 / LPC5 sampling section, which is now used for LPC1 as well. The sequence of pictures below is from Jack K8ZOA. Jack developed a clever way to ensure proper winding of the cores, both for spacing and coverage of the windings. Details of Jack's winding methodology is found below.

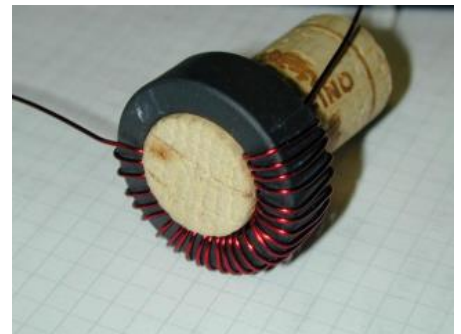

# Assembly Cont'd

Construction of the coupler consists of only a few steps. The main components are the transmission line, toroidal transformers and the attenuator PCB. The most critical step is the winding of the transformers. They are wound with 26 turns each of #20 enameled wire for LPC1 & LPC4, 35 turns for LPC2 & LPC5. The cores are wound in opposite directions, i.e. they should be mirror images of each other. The windings should be evenly spaced over ~60% of the core, as shown later. The cores are supported by nylon bushings with Teflon tape over them, which are inserted into the core centers after winding. If the wires are wound tightly, the cores should fit snugly, but should not have to be forced. The cores should be wound by hand, don't use any tools on the cores or wires as they may break.

Here are some details of the winding aid that Jack, K8ZOA developed. He created the rule using Excel, using the following method.

Start with a fresh Excel workbook. Click on the upper left cell, and select underline. Right click and select copy, then highlight cells 2 thru 25 in row 1, right click and select paste. You should now have a stack of 25 lines in row 1. Adjust row height for 0.10" (2.54mm) between lines, which corresponds to a row height of 7.2. Do this by highlighting the 25 rows, select Format > Row > Height in the toolbar, and set row height to 7.2. This gives 60% coverage which matches the small Teflon tape size gap. Copy the cells and paste extra copies so that you will have at least two to use after printing.

The reduced size screen capture to the right shows what the screen should look like before printing. Print the screen, cut to the rules out and tape to the cores. Use a white laundry marker or grease pencil to mark the lines on the toroids. Jack recommends the use of a tight fitting cork to hold the windings in place as you proceed, and to help flatten the wire against the core on the inside.

The bushing with the larger hole is mounted between the SO-239 connectors, and supported by the RG-393/U Teflon® coax. This piece of coax forms the primary winding of the current sampling transformer. The other transformer is supported by a 0.625" (1.59cm) standoff and 1.0" (2.54cm) screw which forms the primary of the voltage sampling transformer. One end of this standoff is grounded, and the other connects to the attenuator PCB. The transformer secondaries are wired as shown in the drawing. It is important that the cores be positioned as shown, and the wires be routed as shown. Improper routing or core orientation will affect performance, especially above 25 MHz.

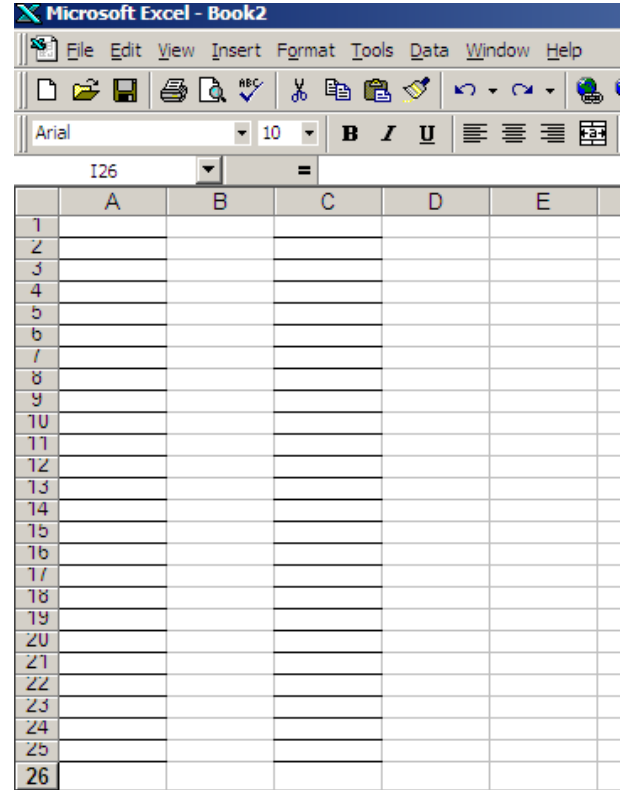

- ❑ Install the two SO-239 UHF connectors using 4-40 x 3/8" (9.53mm) machine screws, #4 lockwashers and large #4 hex nuts for 7 of the mounting holes. The remaining hole, uses 4-40 x 3/8" (9.53mm) hardware and a solder lug as shown. The solder cups on the SO-239s should be facing upward. The flange goes on the outside of the case. If you want to change this, you'll have to adjust the length of the cable.
- ❑ Solder two short pigtails about 1.5" (3.81cm) long into the center pin of the two BNCs. You can use cut ends from other parts for this. Install the two BNC connectors using the supplied special hardware, including solder lugs, as shown. **Note: RG-142 has been replaced with RG-393/U.**

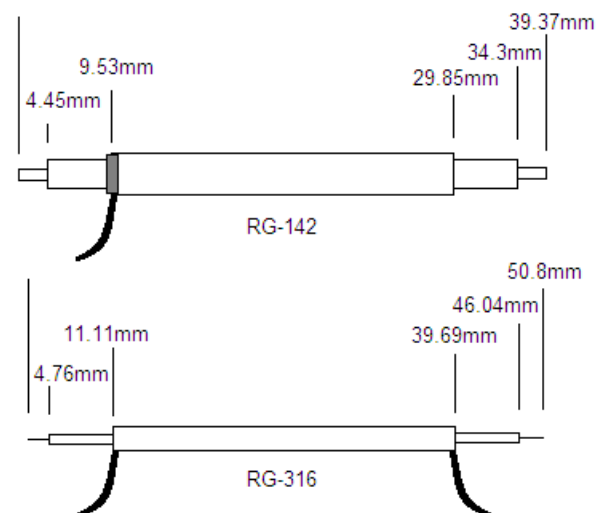
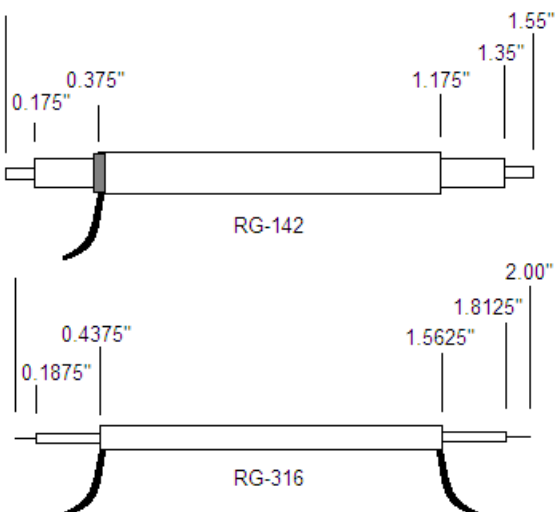



## Assembly Cont'd

- Prepare the two pieces of coax as shown in the diagram. Make sure that the shield wires don't short out to the center conductor on either end. RG-142U (RG-393U) is double silver shielded. Leave a little shield showing on one end as shown in the pics above, and then wrap a short pigtail of wire around it. It is safe to apply a reasonable amount of heat to the Teflon coax without worry about melting the insulation.
- Wind 26 turns of #20 enameled wire on each of the FT140-61 cores (35 turns for LPC2 or LPC5). The cores will be wound in opposite directions, so that the finished toroids will be mirror images of each other, as shown in the wide picture below. A winding is defined as the wire passing through the center of the core. If you count windings on the outside edge of the core, your count will be one short of the actual number of turns. Mis-counting by one turn will give you a power reading error of 8%, and cause other problems as well. The current sampling xfmr is installed between the SO-239 connectors, and will be supported by the short piece of Teflon® coax. The voltage sampling xfmr is supported by the 0.625" (1.59cm) long standoff. Leave 1" (2.54cm) long pigtailed on the xfmrs except for the lead that exits from the back of the voltage xfmr, which should be 3" (7.62cm) long (shown exiting the frame to the left in the "front" picture below, to the right in the "back" one). Scrape the enamel off the ends of the short leads. A razor knife or sandpaper is good for this, or a small file or emery board. Wind the wire tightly. Use your fingers to keep the windings formed close to the cores on the inside.

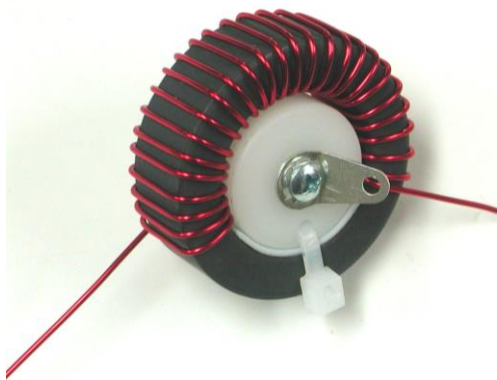

Front

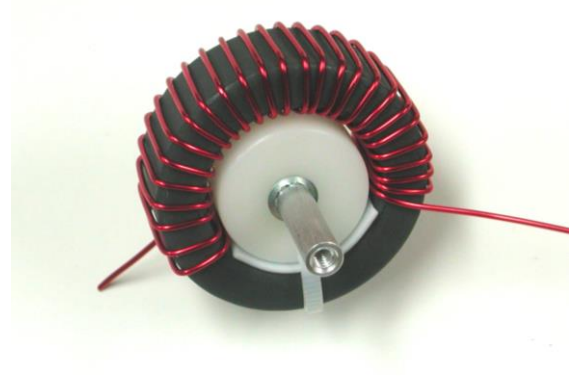

Back

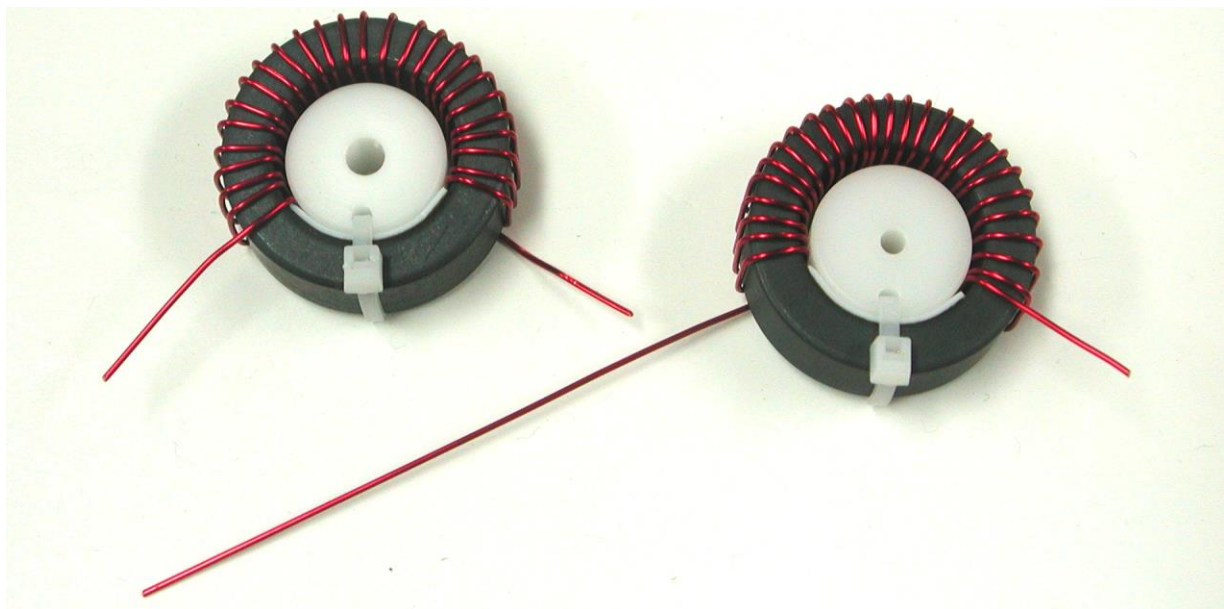

Current

Voltage

- See the pictures above for winding details. **Note: The hole on the bushing for the current xfmr is now larger than shown.** Before slipping the nylon bushings into the xfmr cores, take a piece of Teflon® tape, peel the paper off of the adhesive side, and press it into place between the ends of the winding on the xfmr, with the adhesive against the core. Align the small hole at the bottom of the bushing with the bottom of the core. Be careful when pushing the core in place not to dislodge the Teflon® tape. Insert the nylon tie-wrap into the small hole, and snug as shown to hold the core in place.

# Assembly Cont'd

- ❑ Solder the 12 SMT resistors onto the attenuator board as shown on top right. Starting at about serial # 650, the second PCB was adopted. This allows room for the extra resistors needed for the LPC4 & LPC5 couplers. If you have this PCB, you will have four unused pads. It doesn't matter which pair of each group of three that you use. **For LPC4 & LPC5 couplers, place the resistors as shown in the third picture.** Don't be afraid of these parts. These are VERY big parts as SMT goes. The resistor values are printed on the resistors. Use a fine tip on the soldering iron, and tin ONE of the PCB pads for each resistor with a small amount of solder before attempting to solder the resistors. Hold the resistors in place with a tweezers, and apply a little heat to the edge between each pad and the board until the solder flows between the resistor and pad. It is helpful to slide the resistor over the pad as it melts onto the solder drop, so that the other end exposes a little of the pad on the other side. Solder the other side in place by applying heat and solder to the edge where the resistor sits on the pad. Applying a little flux to the board ahead of time will help to hold the parts in place and aid in solder flow. To verify the proper installation of the resistors, use an ohmmeter to check the resistance of each bare stripline connection to ground. The mounting hole is grounded, as well as the long strip along the top edge. Each point should be about 83 to 84 ohms (62 to 64 for LPC4/5). If not, check your soldering.

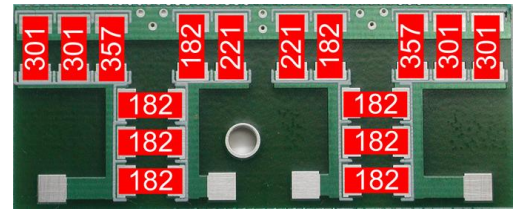
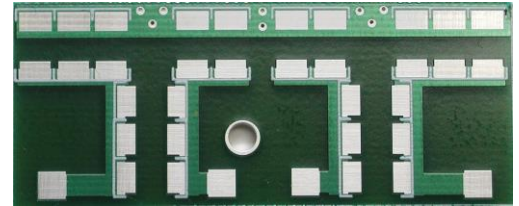
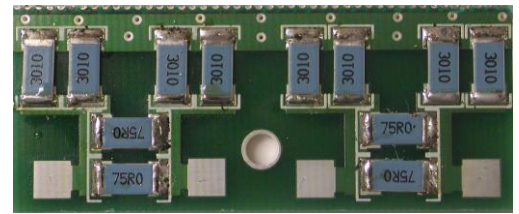

- ❑ Install the PCB onto the side of the coupler above the BNCs as shown. The board mounts with the hole near the bottom edge. Bend and solder the pigtails from the BNCs to the two striplines near the mounting hole. Use 4-40 x 1/4" (6.35mm) machine screw, the small split lockwasher and small hex nut to mount the board.
- ❑ Install the 2-lug terminal strip on the case bottom as shown.
- ❑ Solder one end of the short piece of RG-316U prepared earlier to the solder terminal on the bottom of the coupler, with the coax shield connecting to the grounded lug, and the center to the lug that connects to the current sampling xfmr.
- ❑ Solder the center conductor from the other end of the coax to the remaining PCB stripline pad, and the shield to the ground lug on the center-most BNC.
- ❑ Slide the current sampling transformer over the short piece of RG-142 (or RG-393U) as shown in the diagrams, being careful to position the windings and the coax shield as shown. This is a tight fit, but if you take your time and rotate the coax as you press it into place, you shouldn't have any trouble.
- ❑ The xfmr should be oriented level, with the windings facing up before soldering. Solder the coax on the shield end into the SO-239 connector, and the shield wire to the solder lug on the XMTR connector. Cut the wire from the outside left of the transformer secondary to length and solder it to the lug on the XMTR connector. The other end of the coax will be soldered along with the long wire from the voltage xfmr in an upcoming step.
- ❑ Cut and solder the wire coming from the inside right side of the xfmr to the insulated lug on the terminal strip.
- ❑ Prepare the voltage xfmr as shown in the photos on the bottom of page 16, using the 0.625" (1.59cm) standoff, 4-40 x 0.75" (1.91cm) screw, lockwasher and solder lug. Bend the solder lug at an angle before attaching to allow for a connecting wire to be soldered to it. The long lead should exit the core on the side with the standoff as shown in the overhead picture of the coupler.
- ❑ Solder a short piece of leftover component lead wire to the lug.
- ❑ Attach the assembly to the side of the coupler using 4-40 x 3/8" (9.53mm) hardware. The solder lug and pigtail should be facing the PCB. **It is important that this assembly be attached firmly or you will see erratic operation. You may even wish to use a product like Loctite to ensure that the screw won't work loose over time.** A lockwasher should be placed between the coupler wall and standoff, and one between the screw head and outside of the coupler. The xfmr should be positioned with the gap in the winding facing the bottom of the enclosure.
- ❑ Prepare and solder the short end of the toroid winding so that it connects to the solder lug on the right-most BNC. If the core is mounted correctly, this wire should come off the right side of the core from the inside. Solder the pigtail from the standoff to the stripline pad on the end of the PCB. Leave a small bend in this lead to allow for flexing when the top is attached to the coupler and the walls are pulled apart.

# Assembly Cont'd

- ❑ The long wire coming off the outside left side of the core goes to the output SO-239 as shown. The end of the wire should be placed inside the SO-239 center conductor alongside the RG-142 (or RG-393U) center conductor, or looped around the SO-239 center conductor as shown in the photos. Be sure to scrape the end to allow good soldering in either case. Before soldering these wires to the SO-239, the walls of the coupler need to be pre-tensioned so that there won't be any stress on the coax when the top is attached to the coupler. To do this, I use a 2" (5.08cm) long standoff placed between the walls above the xfmr to separate the walls slightly. A suitable substitute would be a 2" (5.08cm) long piece of wood dowel. The wire should be routed about 1/8" (3.18mm) from the current xfmr as shown. For best phase accuracy at 50 MHz, a little coupling to the current xfmr secondary is desirable. Remove the spacer.

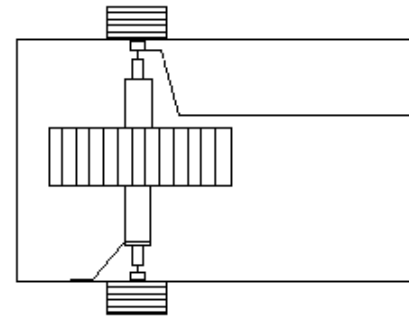

- ❑ Make sure that all connections are soldered well, and that the cores are level. Slip the top on and attach with (14) 4-40 x 1/4" (6.35mm) sheet metal screws. Apply pressure the ends of the cover to prevent gaps from forming as the screws are tightened.
- ❑ Clean and wipe the top of the coupler. Carefully line up the top label and apply starting at one end and smoothing as you go to prevent the formation of bubbles.

## Final Checkout and Assembly

Before going through the Setup screens, it is necessary to verify that the remaining basic circuits are working. Power up the LP-100, and verify that the current draw is correct. (330 mA) Connect the Current and Voltage ports of the controller and coupler together using the supplied 6' (1.83m) coax cables. You may want to bundle the cables using electrical tape to make for a neater installation. One cable should be marked with colored tape at both ends so that the cables are always connected consistently in the future. I also mark the Current jacks on both ends so that the colored cable always connects to Current. This prevents crossing of the cables, and also eliminates errors due to cable variations.

Connect a 50 ohm dummy load to the LOAD port. Select the Power Mode for Average display (press Power Mode button until you see a lower case "w" after the power value), and apply a small amount of power. The Power and SWR bargraphs should deflect upward, and the numerical readouts should display a number very close to the expected value. Switch to the vector display (press Mode button once), and you should see values close to 50 ohms for Z and R, and close to zero for phase.

Next, enter Calibrate mode by pressing and holding the Mode button until you see the initial Calibration screen. Release the Mode button. Scroll to the Counter Calibration screen by tapping the Mode button until you see it. When you transmit, the frequency display should be within about 10kHz of your actual frequency. Use the Dn/Up buttons to match the LP-100 frequency to your transmitter's. This is best done on a higher band for greater resolution. The trim setting should be somewhere near 1605. Exit Calibration Mode.

Press and hold the Alarm Set button until it displays "1.5", then release. Remove the dummy load and transmit into the coupler at low power. The Red Alarm LED should light on the front panel, and the relay should click. If you have JP1 in place, the Piezo transducer should also sound. Note: the transducer will sound pretty loud since it's not inside a case at this point. Reconnecting the dummy load will cancel the alarm after a second or so. You can double-check the PTT connections with an ohmmeter at this time. The center conductors of the RCA connectors would be normally shorted together, and open when the alarm sounds. Unplug the display.

You are now ready to install the controller board in the case. Before installing the board, it is a good idea to sand away the paint overspray inside the case, near the holes for the PCB. This will ensure good electrical contact to the case. Then, loosely install the 4-40 x 1/4" (6.35mm) threaded standoffs on the bottom of the case using 4-40 x 3/16" (4.76mm) black machine screws. Next, slide the board into the rear holes as you drop the front down toward the bottom. Be careful not to scrape the bottom of the board on the front panel as you slide it.

Once the board is in place, align the front holes with the switches and LEDs, and loosely screw the board down with four more 4-40 x 3/16" (4.76mm) black screws. The switch caps will be installed after calibration, in case a problem shows up that requires removal of the board from the case. The caps can be scratched during removal if they are installed now.

Insert the top two 4-40 x 1/4" (6.35mm) black machine screws into the front of the chassis where the display mounts. Remove the protective plastic from both sides of display filter. The dull side of the filter faces the operator, and the shiny part faces the display. **Be careful not to scratch the filter or get fingerprints on it.** You can clean the filter if necessary using lens cleaning tissue or a soft cloth. Slide the filter over the screws from the inside of the enclosure. Loosely mount the VFD to the enclosure using the 4-40 x 3/8" (9.53mm) standoffs you installed previously on the front of the GVFD PCB, then install the remaining two screws and tighten all four. Plug the ribbon cable into J5 on the main PCB, remembering that the silver colored wire goes to pin 1. The top cover will be installed after calibration.

# Assembly Cont'd



## Connections...

Power: 11-16 VDC @ 330 mA max., center pin +, 2.5mm ID. The lead with the white stripe on the supplied cable is +  
 PTT: Loop the PTT (amp keying) between your amplifier and rig through the LP-100A using RCA connectors  
 RS-232: Connects to computer... standard M-F straight through DB9 serial cable. See manual for usage.  
 Current/Voltage: Connect to corresponding jacks on the coupler using supplied RG-58U cables.

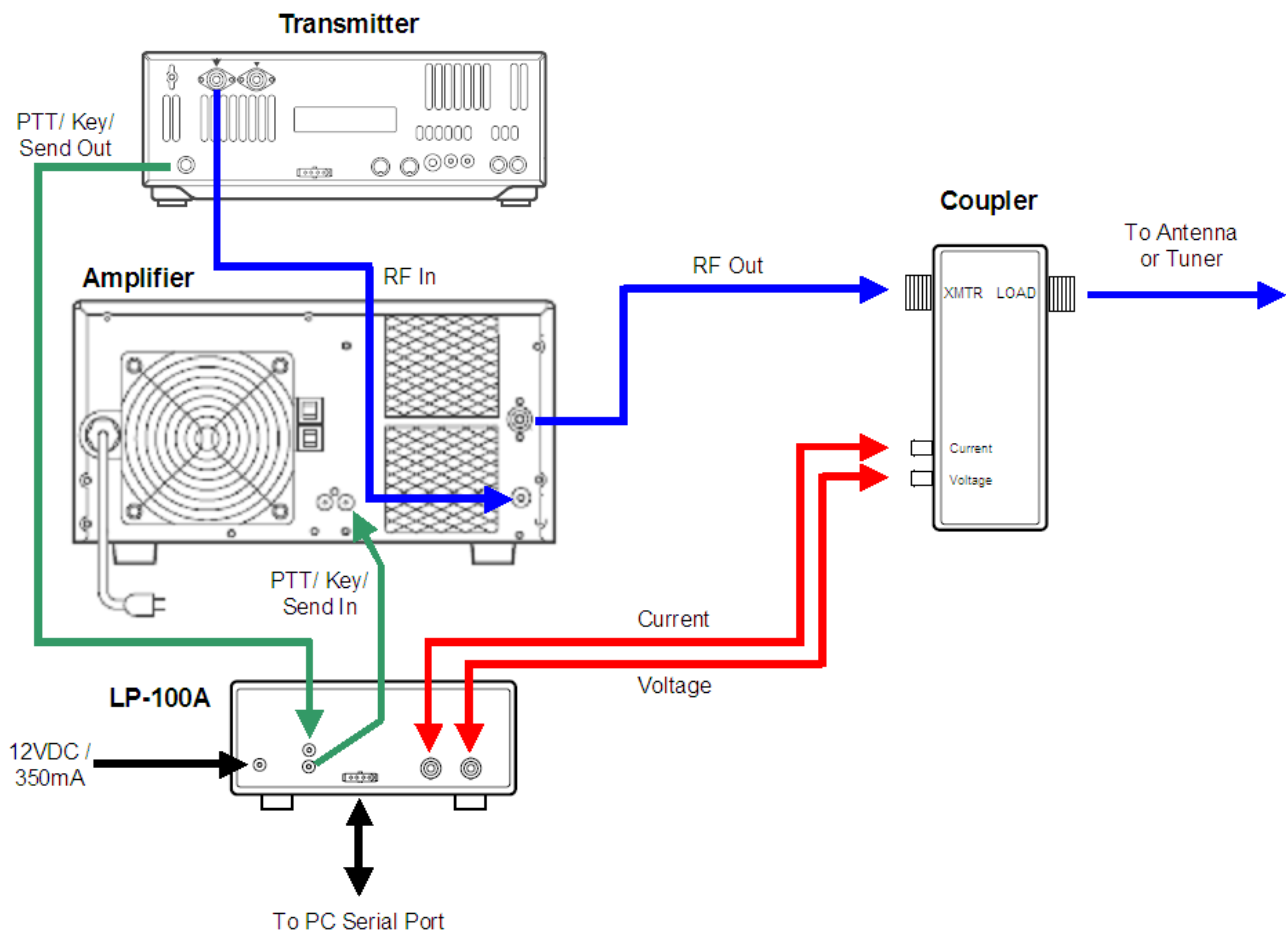

Note: This guide assumes you are using firmware version 1.2.1.5 or newer.

# Basic Operation

Operation of the LP-100A is straightforward, and designed to require a minimum of input. There are only three buttons which are used in combination to access all the menus on the LP-100A. There are five main modes for the LP-100A, which are accessed by momentarily pressing the "Mode" button. The mode status is saved in non-volatile memory, and the LP-100A will return to the saved mode upon powering up. There is also an automatic three-step screen saver mode which dims the screen after 1 second of inactivity, scrolls your call sign across the screen after a user programmed delay time, and turns the display off after another user programmed delay time. The first step is only active in the Normal (most often used) mode. More on this below.

## Mode Button

There are five basic modes, selectable with the Mode button... Normal, Vector, dBm, Field Strength and Peak-to-Average. The mode button is also used to access Setup and Calibrate modes by holding the button for 1 second to access Setup and another 1 second to access Calibration. To return to the normal sequence of mode selections, press Mode button for 1 second from the Calibrate mode.

*Normal* mode is designed to display all the information you normally need on one screen. It displays power in three auto-ranging scales, and SWR (or Ref Pwr), plus bar graphs for both. A summary of the behavior options for the bargraph and numerical displays is provided below in the Setup section, along with the default settings. There are more details in the manual. [For those in a hurry, see the section below on Normal Operation.](#)



*Vector* mode displays magnitude of Z, phase angle of Z, X and R. These values are relative to the "LOAD" connector, not the antenna. There is much more info in the manual on interpreting this screen, as well as using the Plot program to do automatic graphing of a number of parameters.



*dBm* mode uses professional dBm and RL (Return Loss) terminology instead of watts and SWR to indicate power and load quality. The resolution is 0.1 dB for both. The range is +15 dBm to +64.9 dBm, and RL from 0 to 49.9 dB.



*Direct/Field Strength* mode is similar to dBm mode except that it is calibrated to display power from -15 dBm to +33 dBm. There is no return loss in this mode because it does not utilize the coupler. Power is supplied directly to one of the inputs on the back of the LP-100A. This mode can be used for accurate low power bench measurements, as in checking the output to a transverter or the level of a local oscillator or mixer. It is also very useful for doing antenna field strength measurements, as in plotting a beam pattern. There is more on this in the manual, including the use of VCP (Virtual Control Panel) and a program called PolarPlot to automatically plot antenna patterns. **NOTE: The maximum power for the direct inputs is 2W.**



*Peak-to-Average Ratio* displays the ratio of the peak signal to average level of the RF envelope. It is used to determine the effectiveness of speech processing and compression equipment in your radio. It requires the use of an audio test tone, available on my website, that I created specifically for this mode. Again, there is more information in the manual.



*Setup and Calibrate* Allows accessing the Setup and Calibrate modes. Hold Mode button for 1 second to enter Setup mode (top right picture). Hold another second to enter Calibration mode (bottom right picture). Once you are in each of these modes, the Mode button lets you cycle through the choices of that mode. There is more information on the Setup page of this guide. Details for the Calibration mode are in the LP-100A Assembly and Operation manual. Normally, this mode is not used except by kit builders, since the assembled meters are factory calibrated with accuracy traceable to NIST.



# Basic Operation Cont'd

## Alarm (Dn) Button



The Alarm button is used to set the SWR alarm set point. There are 6 choices... OFF, 1.5, 2.0, 2.5, 3.0 & User. The User setting is adjusted in Setup mode, and the programmed value is shown next to the word "User" on the display. Holding the Alarm button will advance the choices every half second or so. Tapping the button will put the Alarm in "snooze" mode for a minute. Tapping again during tuning will reset the function for another minute. The snooze mode allows adjusting an antenna tuner without the alarm going off, but it returns to normal after tuning to protect the amplifier as intended.

## Peak/Avg/Tune (Up) Button

This button provides two functions.

- 1) Short Tap (momentary) – Cycles among the three power display modes... Average, Peak Hold and Tune.



----- Power Mode Indicator. W=Average, W=Peak, T=Tune (pulser)

In all cases, the bar graphs remain in fast attack mode, with decay that's adjustable in Setup. The character after the numerical power readout indicates which mode you are in. A "W" indicates peak mode, a "w" indicates average mode and a "T" indicates tune mode. Average mode is best for taking accurate measurements with steady state signals, or for tuning an antenna tuner. Peak is best for CW or SSB operating. Note: The Peak Mode is VERY fast, and can respond to a lip smack, mic button click, etc. Don't be alarmed by this... it is normal, and allows the LP-100A to provide an accurate indication of peak power. Unless a lot of compression is used, the peak reading will occasionally be somewhat higher than the indication with a carrier... as much as 30% depending on the ALC attack time in your rig, and power supply regulation of rig or amplifier. Tune mode is similar to Peak mode, except that the peak hold time constant is set to 0.25 sec as opposed to the hold time set in Setup. The Average and Tune modes use the preset bargraph range in the setup section, while the Peak mode shows a fixed 13 dB range. The Tune mode is designed mainly for tuning an amplifier using a pulser, and uses a much longer decay to smooth out the pulses.

## Peak/Avg/Tune (Up) Button cont'd

- 2) Long Tap (1/2 second) - Cycles among the three dual coupler selections... Coupler 1, Coupler 2, Auto-Sense.

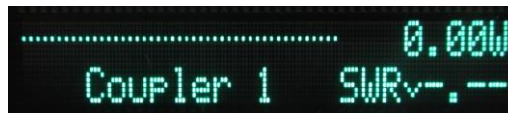

The dual coupler option must be installed for the selections to do anything. When in Auto-Sense, the LP-100A will display the data from whichever coupler is receiving the most power. This is especially useful for SO2R operation, or when using a rig with separate HF and 6m outputs. The meter automatically applies the correct calibration table for the active coupler. Coupler models can be intermixed. A little "arrow" next to the "SWR" text indicates which coupler is active (down for coupler 1, up for coupler 2).

# Basic Operation Cont'd

## Normal Operation

The default settings that affect normal operation are supplied set as below...

<b>Net/Fwd power...</b>	<b>Net</b>
<b>Low power range...</b>	<b>15W</b>
<b>Mid power range...</b>	<b>100W</b>
<b>High power range...</b>	<b>1500W</b>
<b>Alarm Pwr Threshold...</b>	<b>0W</b>
<b>Alarm Set Point...</b>	<b>2:1</b>
<b>Tuning Range...</b>	<b>12dB</b>
<b>Pwr Average samples...</b>	<b>8</b>
<b>SWR Average samples...</b>	<b>2</b>
<b>Peak Hold Time...</b>	<b>2 sec</b>
<b>Bargraph Decay...</b>	<b>Med</b>
<b>Coupler...</b>	<b>LPC1 (or other coupler as ordered)</b>
<b>SWR Resting Style...</b>	<b>- - -</b>
<b>Lower Bargraph Mode...</b>	<b>SWR</b>
<b>Display Brightness...</b>	<b>6</b>
<b>SS Timers...</b>	<b>Scroll=2, Sleep=5</b>
<b>SS Reset...</b>	<b>Mode button or RF Power Sensing</b>
<b>Optional Mode Display...</b>	<b>All modes On</b>
<b>SWR Power Threshold...</b>	<b>0.5W</b>
<b>Peak Power Reset Threshold...</b>	<b>50%</b>
<b>Dual Coupler Option...</b>	<b>Disabled unless you ordered dual couplers</b>

See Setup Mode section for details on setup options.

Generally, the LP-100A is left in the Normal mode. For SSB or CW operation, you should use Peak power mode. You can access this mode by tapping the Peak/Avg/Tune button until you see a capital "W" next to the power readout. This mode will show peak power and SWR and hold them for the preset hold time unless a higher peak is detected, at which time the timer resets. Do not use this mode for steady-state power or SWR measurements.

The peak power reading can be as much as 30% higher than steady-state power readings taken in the Fast mode. This is because of the ability of the transmitter or amplifier to deliver short bursts of higher power due mainly to power supply regulation issues. This is especially true of older amplifiers with unregulated power supplies, but also is affected by the ALC timing characteristics of modern rigs in both CW and SSB. The peak detector in the LP-100A is very fast, and will grab even the smallest peak. Peak SWR will show values a little higher than steady-state at times due to the wide dynamic range of the LP-100A. There is more about this in the Appendix of the manual.

For amplifier tuning with a carrier, you should use the Average mode (small "w") to see both bargraph and numerical readout change as you tune. You can stay in Peak mode if all you care about is the bargraph. When using a pulser for tuning, switch to Tune mode ("capital T") for fast update of both bargraph and numerical readout. The bargraph sampling in the LP-100A is about 100 samples/second, and it will display a single dit at 60 wpm, or a string of pulses from a pulser. Full accuracy should be attainable down to about 500 mW for both power and SWR. Good accuracy should still be maintained down to < 100 mW. For antenna tuner adjustment, any mode is good, as both the bargraph and numerical readout update continuously. Use the dBm/RL mode if you prefer peaking rather than dipping. Tapping the Alarm button will temporarily disable the alarm during tuning, then turn it back on after a minute. Normally, the SWR Alarm should be set for 2.0:1 unless you purposely operate with an antenna that is close to 2.0:1 SWR. It is up to you whether to enable the alarm sounder, by using JP1. In any case, it is recommended that you loop your amplifier PTT (keying) through the LP-100A. This helps protect your amplifier.

# Setup

The Setup mode is accessed by pressing and holding the Mode button for about 1 second until you see the Reference screen shown below. Exiting the Setup mode is done by holding the Mode button for about 2 seconds until you see the Main operating screen. You will pass through the Calibration mode on the way back to Operate.

<pre>Re 1.82 AGC .684 78F AL:Reset FS:TempF/C</pre>	<p>Reference screen. Displays the reference voltage from the gain/phase detector, as well as the RSSI voltage (Received Signal Strength Indicator) from the AGC chip used in the frequency counter preamp. The screen also shows temperature in Deg F &amp; C. The Dn button resets the microprocessor, and is useful when flash updating the firmware in the LP-100. The Up button toggles the temperature mode.</p>
<pre>User Alarm Settings 3.5</pre>	<p>This screen is used to set the "User" SWR Alarm setpoint. It can be set between 1.0 and 5.0 in steps of 0.1. Use Dn to lower value, Up to increase it.</p>
<pre>AL Thresh Pwr Mode 000.0W Net</pre>	<p>This screen allows setting the SWR Alarm power threshold and Power display type. The alarm threshold is used mainly in contesting stations with multiple transmitters to prevent false alarms when energy from another transmitter is picked up by an antenna. The choices are 0,0.1, 1.0 and 10.0 W. The default setting is 0.0W (active at all power levels). The Dn button will allow you to cycle through these choices. <b>Note: This threshold only affects the alarm. Use the SWR threshold Setup screen to limit both the SWR display and alarm below the selected power level.</b></p> <p>Pwr Mode options are Fwd Power and Net Power (Fwd minus Ref). The Up button toggles these choices. The default is Net.</p>
<pre>CH1 Range Scale Max High 1500w</pre>	<p><i>Range.</i> Allows setting of maximum bargraph scale for the three autoranging scales. The Dn button cycles between Low, Mid &amp; High range. Select a power range, and then set the bargraph maximum range.</p> <p><i>Bargraph Max Range.</i> The Up button scrolls through the various max power options for each range... Low – 5, 10, 15, 20, 25W ... Mid – 50, 75, 100, 125, 150, 175, 200, 225, 250W...High – 500, 750, 1000, 1250, 1500, 1750, 2000, 2250, 2500, 3000W. The displayed range includes 10% above the indicated value. Note: Defaults are 15W, 100W, and 1500W. <b>Note: These ranges are scaled by a factor of x1.67 when using a 5KW coupler, and 3.33 when using a 10KW coupler.</b></p>
<pre>Bargraph Tuning Range 12 dB</pre>	<p>This screen is used to set the width of the bargraph in the Average and Tune modes. The Peak mode is always 13dB. It is useful for optimizing the bargraph resolution for amplifier tuning, for instance. The displayed range goes from the maximum set in the previous screen, to a minimum which is the selected number of dB below that maximum. Default is 12dB Use Dn to lower value, Up to increase it.</p>
<pre>Avg. Samples PWR SWR 8 2</pre>	<p>This screen allows setting of the number of samples used to average the numerical readout in Average Power mode, and for SWR in all modes. The range is 2 to 24 samples for Power, and 0 to 5 samples for SWR. The default is 8 samples for Power and 2 samples for SWR. Use Dn to cycle through Power settings and Up to cycle through SWR settings. Both wraparound to the beginning.</p>
<pre>Peak Hold Time 2.00 sec</pre>	<p>This screen allows setting the peak hold time in the Peak mode. The range is 0.25 to 5 seconds. The default of 2 seconds is good for normal SSB or CW operation. Use Dn to lower value, Up to increase it.</p>
<pre>Bargraph Decay Med</pre>	<p>This screen is used to set the decay rate for the bargraphs. Decay choices are "Fast", "Med." and "Slow. The slowest setting corresponds to a decay of about 3 seconds, and smoothes the response considerably for SSB. Default is Med. Try all the settings to see what suits you. Use Dn to lower value, Up to increase it. Note: the attack setting is always fast, and will provide full response to a single dit at 100wpm.</p>
<pre>CH1 Coupler Type LPC1 3KW 1.8-54 MHz</pre>	<p>This screen is used to select different maximum power values to be used with custom high power couplers. Use Dn/Up to cycle through the choices. The default is LPC1 (the standard coupler). Current choices are "LPC1 3KW 1.8-54MHz", "LPC2 5KW 1.8-30MHz", "LPC3 250W 0.1 - 20MHz", "LPC4 5KW 1.8-54MHz", "LPC5 10KW 1.8-30MHz" and "LPC6 1KW 0.10 to 10MHz". Use Dn/Up to cycle through choices.</p>
<pre>SWR Resting Style &lt;-,--&gt;</pre>	<p>This screen is used to select the way you want SWR displayed when you are not transmitting. The choices are... "-.-", "1.00", ". . . .", blank and hold last SWR reading. If you select Hold Last, it will be reset when you transmit again. Use Dn/Up to cycle through choices. Default is as shown.</p>



# Setup Cont'd

<pre>Lower Bargraph Mode &gt;SWR REF</pre>	<p>This screen is used to select what parameter is displayed on the lower half of the display. The choices are SWR and Reflected Power. If you select Reflected Power, remember that the reflected power will be referenced to either NET power or Forward Power (F+R) depending on your earlier selection for the power display. F+R is the preferred choice to use with REF pwr. Use Dn/Up to select.</p>
<pre>Ltr Pos'n    Callsign  1           N8LP</pre>	<p>This screen is used to program your callsign into the screen saver. The Dn button is used to select the position of the letter you want to change... 1 thru 6 from left to right. The Up button is used to scroll through the choices... 0 thru 9, A thru Z, space, / and -. Both buttons wrap around. Step thru the positions, scrolling to the letter you want for each position. The callsign is saved as you see it.</p>
<pre>Display Brightness Dim -----+-- Bright</pre>	<p>This screen is used set the display brightness. Each step represents a 12.5% change in brightness. The default setting is 6, which equals a brightness level of 75%. This provides almost full brightness, and provides some measure of added display life. You can use any brightness level you like. The display is rated for 50,000 hours (5.7 years) of continuous display at full brightness before brightness drops to half. With the LP-100A's screen savers, you can expect much more than that with typical operating habits. Use Dn to reduce brightness, Up to increase. The brightness of the screen changes as you adjust it.</p>
<pre>SS Timers - Minutes Scroll=02  Sleep= 05</pre>	<p>This screen is used set the display screen savers. The two timers that can be set are the Scroll timer and the Sleep timer. The Scroll timer sets the time in minutes from the last transmission to the time when your call sign starts scrolling across the screen. The Sleep timer sets the time from the last transmission to the time when the display turns off. The Scroll saver should be set first, since it also affects the Sleep timeout. Each can be adjusted for up to 10 minutes (20 minutes total). The screen saver extends display life, and reduces power consumption and heat when the meter is idle. There is also a third screen saver timer, but it is factory preset. It dims the screen to 25% one second after transmission ends when in the Main Mode. If Peak power mode is selected and the hold time is set for 1 second or more, it dims at the end of the hold period. The default is as shown.</p>
<pre>SS Reset Mode Mode Button or RF Sense</pre>	<p>This screen is used to determine how the meter is waked from ScreenSaver or Sleep modes. The options are... Mode Button or RD Sense, Mode Button Only. The second option is useful in industrial installations where it operation is 24/7 continuous, and protects the display from excessive wear when the meter is monitored remotely. The default is as shown.</p>
<pre>Opt. Mode Display dBm / RL           On</pre>	<p>Allows disabling of modes that the user may not use or doesn't want to scroll through. The optional modes are... dBm/RL, Direct Input (Field Strength) and Peak to Average Ratio. The default is all ON.</p>
<pre>SWR Power Threshold  0.50W</pre>	<p>Sets the lower limit that the meter will display. The choices are... 0.05W, 0.5W, 2.0W, 5.0W, 10.0W. Setting the value higher allows the meter to ignore samples taken during voice pauses. This eliminates some samples taken at the limit of the gain/phase detector accuracy, where SWR readings may be slightly higher. It smooths out the SWR display, and lets SWR adjustments be made while talking, for instance.</p>
<pre>Pk. Tmr Reset Threshold 50 Percent of Peak</pre>	<p>This screen sets how far below a peak reading that power must drop before the peak hold timer resets and grabs a new sample. The default is 10%.</p>
<pre>Dual Coupler Option Not Installed</pre>	<p>This screen allows enabling or disabling of the dual coupler option. This is done so that most users don't have to see the up/down arrows that show which coupler is active. The choices are "Installed" and "Not Installed".</p>

# Calibration

Accessing the Calibration mode is similar to accessing Setup mode, except that you hold the Mode button until you see the initial Calibration screen. Exiting Calibration Mode is done by holding the Mode button for about 1 second until you see the main operating screen. **Wherever CH1 is shown, there is also a similar screen for CH2 that is displayed when the CH2 coupler is active.**

<pre>***Calibration Mode*** Proceed with Caution</pre>	<p>Calibration Mode title screen. This place holder makes it difficult to accidentally change a setting when entering Calibration Mode. It acts as a buffer.</p>
<pre>Serial Number Range 1201-1400</pre>	<p>Starting with serial #400, this menu was changed to a serial number selection, and covers any hardware change between versions instead of just cables as before. In the case of the 5<sup>th</sup> run, it covers the change in response of a slightly different model power combiner. For the LP-100A, it will be at least #701.</p>
<pre>Copy CH1 Table to CH2 Press DN to Copy Table</pre>	<p>This screen facilitates calibration of the 2<sup>nd</sup> coupler when Dual Coupler Display Option is installed. It copies the data from the CH1 coupler, which will populate the CH2 CAL Table with values close to those which will be required. You will be asked to confirm this action by pressing the UP button.</p>
<pre>CH1 Gain Zero - Trim 40m G=50.0 Trim=120</pre>	<p>This screen allows you to enter the actual impedance of your dummy load on a per band basis. This will result in a more accurate calibration if your dummy load is other than exactly 50.0 ohms, or changes with frequency.</p>
<pre>CH1 Phase Zero - Trim 40m P= 0.0 Trim=138</pre>	<p>This screen allows you to zero the phase detector on a per band basis, correcting for slight variations in the coupler on the higher bands.</p>
<pre>CH1 Gain Slope Trim 25.0 0.0012</pre>	<p>This adjustment is used to calibrate the slope of the gain detector. It is accomplished by transmitting into a 25 ohm load and setting the Trim for a reading of 25.0 (or whatever the actual load resistance is if it's not exactly 25.0).</p>
<pre>CH1 Phase Slope Trim 0.0 0.996</pre>	<p>This adjustment is used to calibrate the slope of the phase detector. It is simply done by inserting a line with known delay into the Current input of the LP-100, and transmitting into a high quality 50 ohm dummy load. The controls are then adjusted so that the display correctly shows the line delay. If coax of known velocity factor is used, the line length in degrees can be simply calculated.</p>
<pre>Offset Volts Trim 0.000 0.000</pre>	<p>Allows adjustment of the accuracy of the op-amp detector and ADC to provide correct conversion values at low power levels. The screen shows the output voltage of the detector, and the Trim level is set by adjusting for zero voltage with no RF power applied.</p>
<pre>Pwr-Lo Pwr-Hi Trim 102.5 102.5 1.024</pre>	<p>This screen is used to match the readings of the low power and high power ADC inputs. It is done at a power level below 380W, which is the point at which the low power input reaches maximum. Its purpose is to allow compensating for any error in the 1% precision divider parts used in the high power input.</p>
<pre>CH1 Master Pwr Trim 102.5 1.010</pre>	<p>Adjusts overall power accuracy of the LP-100. This adjustment affects all frequencies equally, and is made by comparing the LP-100 power reading with an accurate reference. Acceptable reference measurement devices can be inexpensively made, and will be described later.</p>
<pre>CH1 Fine Pwr Trim 40m 102.5 1.001</pre>	<p>Same as above, but adjusts the displayed power reading on a per band basis. The built-in frequency counter detects the band you're on, and stores the CAL constant for each band automatically for 11 bands from 160m through 6m. The counter works from 50 mW to 3000W.</p>
<pre>Counter Calibration F= 7.15MHz Trim=1600</pre>	<p>This screen is used to adjust the frequency counter to compensate for differences in the reference ceramic resonator used as a time base in the LP-100. Counter accuracy is 10kHz, which is far more than needed to calculate interpolated trim settings between bands for power and impedance. Nominal trim setting is 1605.</p>

# Calibration Cont'd

The first step in Calibration is to make sure that you have the correct serial number range set. This compensates for a number of factors that may have changed slightly from run to run of the hardware. Also check the maximum power range selected in the Setup screens.. It also sets the maximum power to match your coupler. There are six couplers currently available for the LP-100, with more to come. The standard unit is the LPC1 3KW, 160-6m coupler.

## Impedance Calibration

Calibration is done in a couple of steps. First the impedance measurement system is calibrated, and then power levels are calibrated. The required tools for this calibration are a high quality 50 ohm dummy load, a high quality power meter or other method of determining power as described in the text and a short coaxial line of known electrical length. A second dummy load is also desirable for calibrating the slope of the gain detector for impedance, but not absolutely necessary as this adjustment seems to vary only slightly from meter to meter. I normally do calibration at 100W, but very close to full accuracy can be had with power as low as 5W, and somewhat reduced accuracy is attainable down to <1W.

I am working on a "calibrator" design which would use inexpensive 1% thick film resistors or 5% metal oxide resistors to provide switchable 50/25 ohm impedance with a 10W rating. It would include a diode peak detector for measuring power with a calibrated table of voltage vs. power. I am also testing a method of using a 6' long length of RG-59U which, when terminated with a 50 ohm dummy load, produces a known complex impedance. This provides a more accurate way of setting the Gain and Phase slope adjustments, and takes into account coupler variations as opposed to the delay line method. I have characterized readily available and inexpensive cables available from Jameco, Radio Shack and Mouser, and will provide part numbers. The cables are BNC-to-BNC, and may require UHF adapters if you don't already have them. These are also available from the above suppliers.

If you don't have a good way to measure your dummy load, you can measure the resistance at DC using a DMM. If you know the load to be low-inductance through 6m, this will give a reasonable approximation. If you are looking for a high quality dummy load, check out [www.ridgeequipment.com](http://www.ridgeequipment.com). They have some excellent surplus loads for as little as \$10.

The first screen is the Gain Zero Trim screen. This allows for band-by-band balancing of the gain detector. To do this, connect your dummy load to the ANT connector on the LP-100 coupler. Starting with the lowest band you can transmit on, key the transmitter. Adjust the Cal constants using the Dn/Up buttons until the displayed resistance matches your dummy load, then unkey the transmitter. Repeat this procedure for all bands.

Advance to the Phase Zero screen and repeat the procedure for each band, this time adjusting for a phase of zero degrees. There will probably be some jitter in this case. Just adjust so that the average setting is zero.

The next adjustment screen is Phase Slope. This adjustment sets the slope of the transfer curve of the phase detector so that the measurement limits are correct. The above Zero adjustment ensures that zero degrees reads close to zero. This adjustment ensures that higher phase delays display accurately. Together they define the slope of the phase detection curve.

As mentioned in the Overview, adjusting the Phase Slope is simply a matter of matching the reading to a known delay line value. Again, the formula for determining delay in degrees is...

$$\text{Phase Delay (Degrees)} = (360 \cdot L \cdot F) / (984 \cdot VF)$$

Where L is in feet and F in MHz. VF would generally be 0.66 for polyethylene dielectric. Foam dielectrics generally have a VF of about .80. Check for the correct value of the coax type/brand you are using. A 6' length with poly dielectric will provide a delay of near 45 degrees at 14 MHz. This is a good range to use, as it places the phase display at about midrange.

Insert the delay line into the Current cable between the controller and coupler, using a BNC barrel connector. With a 50 ohm load, the phase should read close to the calculated value in degrees. If not, use the Dn/Up buttons to adjust the reading to the correct value. Leaving this setting at the default 1.000 will result in a maximum phase error of a few degrees over most of the frequency range.

The last impedance adjustment screen is called Gain Slope. This sets the slope of the gain detector so that it is linear with increasing Z. The adjustment requires a load other than 50 ohms, A convenient value is 25 ohms, which can be created easily by paralleling two 50 ohm loads using a "T" connector. It is important when making this adjustment that there is no coax between the 25 ohm load and the coupler "Load" connector, otherwise the line will transform the 25 ohm resistive load to some mixed R+jX value. The easiest way to do this is to screw a UHF Tee connector directly to the Load connector, and then use adapters or lengths of 50 ohm coax to connect to the two 50 ohm loads. With the transmitter set to 20m, apply power and see what the impedance reads on this screen. If the displayed value is slightly higher or lower than the actual value, adjust the Dn/Up buttons to match the load's actual Z (or resistance on a DMM). **If a 25 ohm load reads 100 ohms, you have the current and voltage cables crossed.** Correct this and start calibration over from the top. Remember to return to a 50 ohm load after this test. The expected trim value should be in the range -.0004 to +.0004, and will usually be even closer than that. Leaving this adjustment at 0.0000 will result in a maximum error of a few tenths of an ohm.

# Calibration Cont'd

## Miscellaneous Settings

The next screen adjusts the Offset cal constant to compensate for any residual offset voltage on the output of the TLC271 op amp. Simply adjust the Dn/Up buttons for a displayed voltage of 0.000V with no RF power applied.

The next screen compensates for any variations in the precision resistive divider which is used in the high power mode. It is adjusted by transmitting at 100W or some other convenient value, and using the Dn/Up buttons to match the readings of the Low and High power detectors.

## Power Calibration

Before starting power calibration, it should be pointed out that calibration is not absolutely necessary. In calibrating hundreds of the assembled versions of the LP-100, it was found that the maximum band to band error, as read on a HP-436A power meter, was +/- 1.5% before calibration on 160-10m. The error on 6m can be more like +/- 5-10% before calibration. The Master trim setting on my assembled meters was within 3%, and can be left at 1.000. Of course, there is more consistency in coupler construction on the assembled units than there would be with dozens of different builders, but it would be unlikely that the error would be more than about 5% if care is taken to follow the instructions on the coupler assembly.

The first test requires no test equipment. While in the Setup > Offset screen, adjust the Dn/Up buttons for a zero reading of the displayed voltage with no RF power applied. This nulls out the residual offset voltage of the op-amp detector.

The next screen allows for the adjustment of Master power sensitivity. This value will normally be near 1. Both the Master and Fine power adjustments have a range of +/- 12.5% in 0.1% increments.

The Fine sensitivity adjustment is made while transmitting into the LP-100. The adjustments affect the trim values for the band being displayed. The frequency display follows the transmit frequency automatically when you transmit. Before adjusting either the Mstr or Fine trims, it is necessary to provide an accurate means of measuring power that is independent of the LP-100. The simplest approach to this is to borrow a high quality meter like a Bird or Alpha to use as a reference, and connect it between the LP-100 and dummy load with a UHF male-male adapter. An even better approach, which is what is used for the factory calibration, uses a calibrated 30 dB attenuator feeding a laboratory power meter (HP436A or Boonton 4200 in my case). The power meter is calibrated against an NIST (National Institute of Standards and Technology) traceable reference calibration signal.

The most accurate simple method for doing this with common tools is to use a high quality dummy load with a diode peak voltage detector and DMM. Here is the setup...

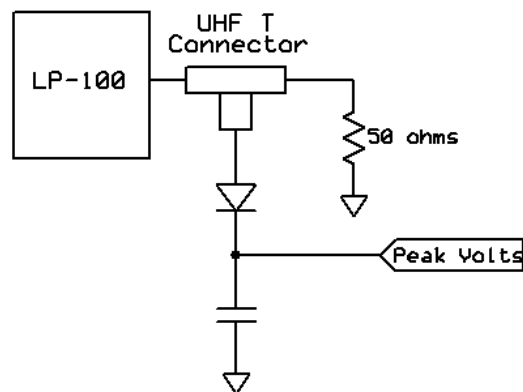

The following formula can be used to determine power.

$$P \text{ (watts)} = (V_{pk} + .25) * (V_{pk} + .25) / 100$$

The diode is a 1N5711 Schottky diode, and the cap is .01uF. A convenient power level to use is 10W, as it is within the PIV specs of the 1N5711. 10W produces a peak voltage of ~31 V across a 50 ohm load. The diode will handle up to 40W, but I have only tested the circuit for accuracy at 10W. The voltage needs to be measured by a high impedance DMM with good accuracy. Most quality DMMs have > 1 meg input impedance, and many have > 10 meg input impedance.

# Calibration Cont'd

The accuracy of this setup will mainly be related to the quality of the load. If the dummy load error is 5%, then the power calculation will be roughly 5% off. You can roughly guess at the RF resistance of your dummy load by measuring it at DC with a DMM, although that method will most likely be inaccurate at 50 MHz, and probably at 28 MHz as well. Make sure you measure the resistance with the load at operating temperature. Also, all connecting cables / adapters need to be as short as possible. If you are unsure of the quality of your dummy load, I recommend visiting [www.ridgeequipment.com](http://www.ridgeequipment.com) to look at some of their offerings. These are high quality loads, and for a small fee they will supply you with a calibration table and chart of the return loss of the load.

The actual diode drop will very likely be within about .2V of the assumed value in the formula, for a voltage error of under 2%. If you don't have access to these methods, you can send your completed LP-100 back to me for calibration if you are willing to pay for return shipping costs.

The first step in power calibration is to set the Master Trim value. This should be done on 3.5 or 7.0 MHz. Make sure the Fine Trim setting for this band is 1.000, then transmit at a known power level and adjust the Master Trim for the correct power reading. The Mstr setting will not be touched after this.

To adjust the Fine power constants for each band, simply transmit on the band of interest and adjust the Dn/Up buttons for the correct power readings. Move through all bands in sequence until they have all been adjusted. You will notice that when you transmit now, the band indicator shows the band you are transmitting on and the Trim value changes automatically based on the band.

The Mstr Trim setting will typically be within 2% , and the variation of Fine Trim setting should be < 2% from 160-10m and <10% on 6m. This is dependent on a number of factors to do with xfmr winding (mainly total % of core wound), positioning and wire routing, and so will vary from builder to builder... BUT the calibration routine will eliminate any variances. Setting the fine trims to 1.000 should provide less than 2% band-to-band variation through 10m. 6m can be as much as 10% off without specific calibration.

Log all your constants for future reference, and you're done. There is a page at the end of this manual to make that easy. **NOTE:** Normal use of the LP-100A, including the flash programming of a new firmware version, will not disturb the saved CAL constants unless you have the MCLoader software set to "Program Data". Jotting the values down will allow you to return to your original settings in case you accidentally change a value by mistake. I am planning a Windows utility to allow saving, editing and restoring of the CAL table.

## Final details

If everything has checked out to this point, you can complete the assembly of the controller by adjusting the LEDs on the front panel to line up with the holes, and snap the switch caps in place on the switches. **Note: If you need to remove the PCB in the future, you can carefully pull of the square keycaps using a pliers or channel locks, but you will need to use a needle nose pliers on the shaft of the power switch behind the panel to prevent stressing and damaging the internals of the switch.**

Line everything up on the front and rear, and then tighten the four screws on the top of the PCB, and the four on the chassis bottom. You can also attach the rear panel to the RCA connectors using the 4-40 x 3/8" (9.53mm) self-tapping screw provided. Don't overtighten. Install the DB9 jack screws using #4 split lockwashers. Snug up but don't overtighten. Snap the two plastic hole plugs into the CH 2 coupler input holes.

You can now install the cover on the controller using the 4-40 x 1/4" (6.35mm) self-tapping screws provided.

# Operation



Operation of the LP-100 is straightforward, and designed to require a minimum of input once set up and calibrated. There are only three buttons which are used in combination to access all the menus on the LP-100. There are five main modes for the LP-100, which are accessed by momentarily pressing the "Mode" button. Pressing the button in mode 4 returns you to mode 1. The mode status is saved in non-volatile memory, and the LP-100 will return to the saved mode upon powering up. There is also an automatic two-step screen saver mode which dims the screen after approx. 30 sec of inactivity, and marches your call sign across the screen after approx. 2 min. of inactivity. This is done to extend the life of the GVFD display.

## Mode

There are five selectable modes... Normal, Vector, dBm, Field Strength and Compression. A sixth mode which display relative power and phase between phased array elements or stacked beams is in the works as well.

*Normal* mode is designed to display all the information you normally need on one screen. It displays power in three auto-ranging scales, and SWR, plus bar graphs for both.

*Vector* mode displays Z, Phase angle of Z, X and R. These values are relative to the "LOAD" connector, not the antenna. Antenna Z can be calculated by knowing the feedline length and using a program like TLW, or a Smith Chart. Note: The LP-100 cannot determine the sign of X automatically.

*dBm* mode uses professional dBm and RL (Return Loss) instead of watts and SWR to indicate power and load quality. The resolution is 0.1 dB for both. The range is +15 dBm to +64 dBm, and RL from 0 to 49.9 dB.

*Direct/Field Strength* mode is similar to dBm mode except that it is calibrated to display power from -15 dBm to +33 dBm. There is no return loss in this mode because it does not utilize the coupler. Power is supplied directly to one of the inputs on the back of the LP-100.

This mode can be used for accurate low power bench measurements, as in checking the output to a transverter or the level of a local oscillator or mixer. It is also very useful for doing antenna field strength measurements, as in checking a beam pattern. This requires feeding a small pickup antenna to one of the inputs. The LP-100 could be set up in a field, connected to a laptop computer with wi-fi, and the results can be read over the wireless LAN back in the shack. This eliminates any wiring that could distort the pattern. **NOTE:** The maximum power for the direct inputs is 2W.

*Peak-to-Average Ratio* displays the ratio of the peak signal to average level of the RF envelope. It is used to determine the effectiveness of speech processing and compression equipment in your radio.

## Alarm

The Alarm button is used to set the SWR alarm set point. There are 6 choices... OFF, 1.5, 2.0, 2.5, 3.0 & User. The User setting is adjusted in Setup/CAL mode, and the programmed value is shown next to the word "User" on the display. Holding the Alarm button will advance the choices every half second or so. Tapping the button will put the Alarm in "snooze" mode for a minute. Tapping again during tuning will reset the function for another minute. This allows adjusting an antenna tuner without the alarm going off, but it returns to normal after tuning to protect the amplifier as intended. If "Avg. During Snooze" is selected for the W Mode SWR Display setting, then entering Snooze mode will also make the SWR display average instead of peak until the timer times out. This makes antenna tuning easier since you can stay in the W mode even during antenna tuning.

# Operation Cont'd

## Peak/Avg/Tune

This button toggles between a pseudo-average numerical display, a peak-hold display and a tune mode. In all cases, the bar graphs remain in fast mode. The character after the numerical power readout indicates which mode you are in. A "W" indicates peak mode, a "w" indicates average mode and a "T" indicates tune mode. Average mode is best for taking accurate measurements with steady state signals, or for tuning an antenna tuner. Peak is best for CW or SSB operating. Note: The Peak Mode is VERY fast, and can respond to a lip smack, mic button click, etc. Don't be alarmed by this... it is normal, and allows the LP-100A to provide an accurate indication of peak power. Unless a lot of compression is used, the peak reading will usually be somewhat higher than the indication with a carrier... as much as 30% depending on the ALC attack time in your rig, and power supply regulation of rig and amplifier. Tune mode is similar to Peak mode, except that the peak hold time constant is set to 0.25 sec as opposed to the hold time set in Setup. The Average and Tune modes use the preset bargraph range in the setup section, while the Peak mode shows a fixed 13 dB range. The Tune mode is designed mainly for tuning an amplifier using a pulser.

The button also allows selection of couplers if the Dual Coupler Option is installed. Holding the button for a second will display and advance the coupler choice. Choices are "Channel 1", Channel 2", "AutoSense". Press/hold once for each change. A small arrow next to the SWR title indicates which coupler is active. A down arrow indicates CH1, and up arrow CH2.

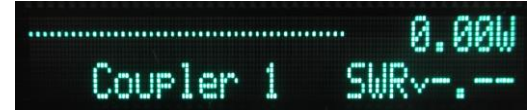

## Setup

The Setup/Calibration modes can be accessed with the Mode button. To enter Setup mode, press and hold Mode button for about 1 second. Once in Setup mode, the Mode button is used to cycle through the setup screens. If you hold the button too long, you will advance to the Calibrate mode. Simply hold the button again to return to the main screen and start over.

*Reference.* This screen display the reference voltage from the gain/phase detector, the RSSI output from the counter AGC amplifier and temperature in degrees F & C. It is only mainly for diagnostics. Pressing the Alarm button in this mode resets the PIC, quite useful when flash programming the PIC. The reset does not affect setup/calibration settings. Pressing the Peak/Avg/Tune button toggles the Temp display between degrees C and F.

*User Alarm Setting.* Allows setting a user threshold other than the preset choices. Any setting from 1.0 to 5.0 is permissible.

*AL Thresh/Pwr Mode.* Allows selection of a power threshold for the SWR alarm. The normal setting is zero, meaning that the alarm will work at any power level. Choices are 0, 0.1, 1.0, 10.0, 100.0W. This is useful for multi-transmitter contest setups where significant energy from a nearby antenna might be present on the output of the LP-100 coupler. If the energy is from another band, the LP-100 will display SWR, which will be high. By setting a power threshold for the alarm, it will keep the alarm from tripping on induced power. The Pwr Mode allows selection of Net or Fwd power. Net is Fwd minus Ref... or delivered power. F+R is the total incident power (including Ref) as displayed on typical wattmeters like a Bird 43.

*Range.* Sets the maximum excursion of the bargraph for the three automatically selected ranges. The choices are...

Low – 5, 10, 15, 20, 25W

Mid – 50, 75, 100, 125, 150, 175, 200, 225, 250W

High – 500, 750, 1000, 1250, 1500, 1750, 2000, 2250, 2500, 3000W

Defaults are 15W, 100W and 1500W.

Each range allows 10% overhead, so that the 100W selection would extend to 110W, for example. **Note: These settings do not affect the numerical readout, which has no limits of any kind.**

The Dn button selects the range, and the Up button sets the power level, with wraparound to the beginning values.

*Bargraph Tuning Range.* Sets the width of the bargraph in Average and Tune modes from 3dB to 12dB. This allows tailoring of the bargraph resolution for amplifier tuning to simulate an analog meter. The response is still logarithmic to minimize jitter, and be more like the typical square law analog meter response. The default is 12dB. You can use a narrower range to increase bargraph resolution for amplifier tuning. The default setting of 12dB gives almost 1% bargraph resolution, and the other choices give much better than 1% resolution.

*Averaging Samples.* Sets the number of samples for power averaging, adjustable from 2 to 24 samples. Default is 8 samples.

*Peak Hold Time.* Sets the hold time in Peak mode. Adjustable from 0.25 to 5 seconds. The default setting is 2 seconds for normal SSB or CW operation.

# Operation Cont'd

*Bargraph Decay.* Allows setting the decay time of the power bargraph. The default setting is Fast, and provides a decay of less than one second. The longest setting is Slow, and provides about a 3 second decay. In all cases, the attack is instantaneous.

*Coupler Type.* This screen is used to select different maximum power values to be used with custom high power couplers. Use Dn/Up to cycle through the choices. The default is LPC1 (the standard coupler). Current choices are "LPC1 3KW 1.8-54MHz", "LPC2 5KW 1.8-30MHz", "LPC3 250W 0.1 - 20MHz", "LPC4 5KW 1.8-54MHz", "LPC5 10KW 1.8-30MHz" and "LPC6 1KW 0.10 to 10MHz". Use Dn/Up to cycle through choices.

*SWR Resting Style.* This screen is used to select the way you want SWR displayed when you are not transmitting. The choices are... "--", "1.00", ". . .", blank and hold last SWR reading. If you select Hold Last, it will be reset when you transmit again. Use Dn/Up to cycle through choices.

*Lower Bargraph Mode.* This screen is used to select what parameter is displayed on the lower half of the display. The choices are SWR and Reflected Power. If you select Reflected Power, remember that the reflected power will be referenced to either NET power or Forward Power (F+R) depending on your earlier selection for the power display. F+R is the preferred choice to use with REF pwr. Use Dn/Up to select.

*Callsign Entry.* This screen is used to program your callsign into the screen saver. The Dn button is used to select the position of the letter you want to change... 1 thru 6 from left to right. The Up button is used to scroll through the choices... 0 thru 9, A thru Z, space, / and -. Both buttons wrap around. Step thru the positions, scrolling to the letter you want for each position. The callsign is saved as you see it.

*Display Brightness.* This screen is used set the display brightness. Each step represents a 12.5% change in brightness. The default setting is 6, which equals a brightness level of 75%. This provides almost full brightness, and provides some measure of added display life. You can use any brightness level you like. The display is rated for 50,000 hours (5.7 years) of continuous display at full brightness before brightness drops to half. With the LP-100A's screen savers, you can expect much more than that with typical operating habits. Use Dn to reduce brightness, Up to increase. The brightness of the screen changes as you adjust it.

*Screen Save Timers.* This screen is used set the display screen savers. The two timers that can be set are the Scroll timer and the Sleep timer. The Scroll timer sets the time in minutes from the last transmission to the time when your call sign starts scrolling across the screen. The Sleep timer sets the time from the last transmission to the time when the display turns off. The Scroll saver should be set first, since it also affects the Sleep timeout. Each can be adjusted for up to 10 minutes (20 minutes total). The screen saver extends display life, and reduces power consumption and heat when the meter is idle. There is also a third screen saver timer, but it is factory preset. It dims the screen to 25% one second after transmission ends when in the Main Mode. If Peak power mode is selected and the hold time is set for 1 second or more, it dims at the end of the hold period.

## Calibration

*Calibration Initial Screen.* This screen simply identifies that you are in the Calibration mode.

*Serial Number.* All LP-100s after serial #100 are supplied with RG-58U connecting cables between the coupler and main chassis. Earlier versions used RG-174U. This screen allows selection of the appropriate cable. It selects the proper correction table for the cable loss vs. frequency. On later versions, this screen name was changed to Serial Number to compensate for other hardware changes as well as cable type.

*Gain Zero Trim.* This screen allows band-by-band calibration of the balance of the gain detector. The process simply requires a good quality dummy load. The Dn/Up buttons are adjusted until the resistance on the screen matches the resistance of your dummy load. The LP-100 automatically saves the Cal constants for each band, indexed to frequency. The built-in frequency counter automatically determines the frequency.

*Phase Zero Trim.* This screen allows band-by-band calibration of the balance of the phase detector. The Dn/Up buttons are adjusted until the phase on the screen reads zero degrees. The LP-100 automatically saves the Cal constants for each band, indexed to frequency. The built-in frequency counter automatically determines the frequency.

*Gain Slope Trim.* Allows setting the slope of the magnitude for proper Z at a value removed from 50 ohms. This can be done with any reasonable known load in the 25 or 75-100 ohm range. I am also working on a calibrator kit to simplify this.

*Phase Slope Trim.* Allows calibrating the phase detector. This requires a delay line of known value. In its simplest form, this can be done by calculating the electrical length of an existing piece of coax in the 3-10' range, and matching the readout to the calculated length at the frequency used for the calculation. More on this in the Calibration section. I am also working on a calibrator kit to simplify this.



# Operation Cont'd

*Offset Trim.* Provides for calibrating the low level ADC converter accuracy. The screen shows the output voltage of the detector, and the Trim level is set by adjusting for zero voltage with no RF power applied.

*Hi/Lo Trim.* This screen allows the matching of the direct and divided inputs to the ADC to account for any slight variations in the precision divider.

*Master Trim.* Adjusts the overall gain for power readout for all frequencies.

*Fine Trim.* Adjusts gain by band for power readout, indexed by frequency. Frequency is determined automatically by a built-in frequency counter.

*Counter Calibration.* Allows synchronizing the LP-100A clock with an external reference.

## Normal Operation

In normal operation, the LP-100A is left in the Normal mode. You'll notice that the screen dims to 25% one second after powering up or when transmission ends. If Peak power mode is selected and the hold time is set for 1 second or more, it dims at the end of the hold period. This is part of the screen saver, and is designed to maximize display life. All other modes provide full brightness as preset in Setup, since they are not used nearly as much as the Normal mode.

For SSB or CW operation, you should use the Peak mode. This mode will show peak power and SWR and hold them for the preset hold time unless a higher peak is detected, at which time the timer resets. Both the numerical value is held, plus a "sticky bar" in the bargraph. This lets you see your maximum peak, but still allows the bargraph to follow your transmitted power at very high speed. Do not use this mode for steady-state power or SWR measurements, as it will be affected by momentary power fluctuations that many modern rigs have.

The peak power reading can be as much as 30% higher than steady-state power readings taken in the Average mode. This is because of the ability of the transmitter or amplifier to deliver short bursts of higher power due mainly to power supply regulation issues. This is especially true of older amplifiers with unregulated power supplies, but also is affected by the ALC timing characteristics of modern rigs in both CW and SSB. The peak detector in the LP-100 is very fast, and will grab even the smallest peak. Peak SWR will show values a little higher than steady-state at times due to the wide dynamic range of the LP-100. There is more about this in the Appendix.

As power drops to below 100 mW during speech, the SWR detector can sometimes grab a higher peak because of the lower accuracy at extreme low power levels. The worst-case error in this case should be  $< .10$ . For best accuracy during measurements, use the average mode and at least .5 watts of power. The directivity of the LP-100A can easily be greater than 40 dB as you may have noticed during calibration, even at low power.

For amplifier tuning, you should switch to Tune mode for fast update of both bargraph and numerical readout. The bargraph sampling in the LP-100A is about 60 samples/second, and it will display a single dit at 100 wpm, or a string of pulses as with a pulser or keyer set for high speed. Full accuracy should be attainable down to about 500 mW for both power and SWR. Good accuracy should still be maintained down to  $< 100$  mW. Note. For antenna tuner adjustment, the Average mode provides the best numerical readout, or dBm/RL if you prefer peaking rather than dipping.

Normally, the SWR Alarm should be set for 2.0:1 unless you purposely operate with an antenna that is close to 2.0:1 SWR. It is up to you whether to enable the Piezo transducer, by using JP1. In any case, it is recommended that you loop your amplifier PTT through the LP-100. This not only helps protect your amplifier, but also the coupler in the LP-100A... especially if you have an older amplifier which is capable of delivering full power into a high SWR load.

The other normal settings include NET power, 12dB bargraph range bargraph decay of "Off". You may find, however, that you prefer to use a slower decay for a smoother response. The choice of 36-bar or 60-bar style for the bargraph depends on your personal preferences and needs.

## Vector Mode

In the vector mode, you can see the impedance of the load in two ways. The top line of the display shows the magnitude and phase of the complex impedance, and the lower line shows the resistive and reactive components, ie.  $R + jX$ . It is important to note here that the sign of the reactive, or imaginary component cannot be determined automatically by the LP-100.



Z:	49.3	PH:	5.0
R:	49.1	X:	4.3

# Operation Cont'd

If you QSY up from your current frequency, and the reactance goes up, then the reactance is inductive (sign is "+"), and conversely if it goes down, then the reactance is capacitive (sign is "-"). A suitable distance is QSY is about 100 kHz or more. The LP-Plot program has

the ability to determine sign automatically, since it can control your transmitter's frequency. When it plots a range of frequencies, it uses the slope of the reactance curve to determine sign, and plots the results accordingly.

It is important to remember that the impedance displayed on the screen is referenced to the coupler LOAD port. This value is related to actual feedpoint impedance of the antenna by factors relating to the characteristic Z of the line, line length and loss. I plan to add the ability to display actual antenna feedpoint Z into the LP-100 VCP and Plot programs by providing input boxes for feedline type and length.

A simple way to provide reasonably accurate antenna Z on the LP-100 display would be to use a feedline which is a multiple of  $\frac{1}{2}$  wavelength in electrical length. There would still be some residual error due to feedline loss, but it would give a better representation of feedpoint Z. I am considering adding a CAL screen to allow selection of feedline loss to compensate for this, and I may also allow the future entry of feedline length and Zo data. There will be more info on this and other Impedance related subjects in the upcoming Appendix A.

## **dBm/RL Mode**

Displays power in dBm from +15 to +64 dBm, and load integrity in dB of return loss from 0 to 49.9 dB.

## **Direct Input/Field Strength Mode**

Similar to dBm mode except that it is calibrated to display power from -15 dBm to +33 dBm. There is no return loss in this mode because it does not utilize the coupler. Power is supplied directly to either one of the inputs on the back of the LP-100. This mode can be used for accurate low power bench measurements, as in checking the output to a transverter or the level of a local oscillator or mixer.

It is also very useful for doing antenna field strength measurements, as in checking a beam pattern. This requires feeding a small pickup antenna to one of the inputs. Selecting this mode automatically returns the Peak/Avg/Tune mode to Average. **NOTE: The maximum power for the direct inputs is 2W.**

## **Peak-to-Average Mode**

This mode lets you determine the average power in a signal by taking 40,000 samples/second, and compares this to the peak power in the signal. The result is displayed as a ratio in dB. I provide a couple test tones, which are available on my website at <http://www.telepostinc.com/Files/two-level-tone-loop3.zip> and [http://www.telepostinc.com/Files/loud\\_tone.zip](http://www.telepostinc.com/Files/loud_tone.zip). The loud tone is used to set the maximum power and proper ALC range (with processing OFF). The two-level tone is used to determine the peak-to-average ratio of the output signal. It can be played back on your PC, or converted to mp3 and played on a portable player. It can be played over a speaker into the microphone, or directly into the mic input. The two-level tone provides alternating loud and soft tones with 20 dB difference in level. This tone should provide the following Peak-to-Average ratios vs. effective compression ratio.

Compression Ratio	Peak-to-Average Ratio
0dB	5.2dB
5dB	5.6dB
10dB	3.6dB
15dB	2.2dB
20dB	0dB

I plan more test tones with different characteristics in the future, which is why I decided to keep the display as Peak-to-Average as opposed to Compression, which would only be accurate with one test signal. I will provide additional tables such as the one above with the additional test signals.

# Circuit Description

## Screen Saver

The screen saver works a little differently than it did in the LP-100 due to the different requirements of the GVFD display. It is a three-step process. The first step only works in the Normal mode, while the other two work in all modes and screens. Step 1 is to dim the display to 25% when in Normal mode. Transmitting, even just a dit, will restore full brightness as preset in the Setup screen. One second after transmission it returns to 25%, unless you are in the Peak Hold mode. If you have the hold time set to 1 second or longer, the screen will dim at the end of the hold time for a smoother look. Step 2 scrolls a dimmed, full screen version of your callsign across the display after a preset amount of time that you set in Setup (1-10 minutes of inactivity). Step 3 is a "sleep" mode which turns the filaments to the GVFD display off to reduce current draw after a preset amount of time that you set in Setup (1-10 minutes of additional inactivity beyond the scrolling callsign). Transmitting will cancel all three steps. Tapping the Mode button will cancel the second two steps. If you are in the sleep mode, the display will "fade" up as the filaments warm, as opposed to popping back up.

The LP-100 is unique in its design in several regards. Refer to the following block diagram during this discussion.

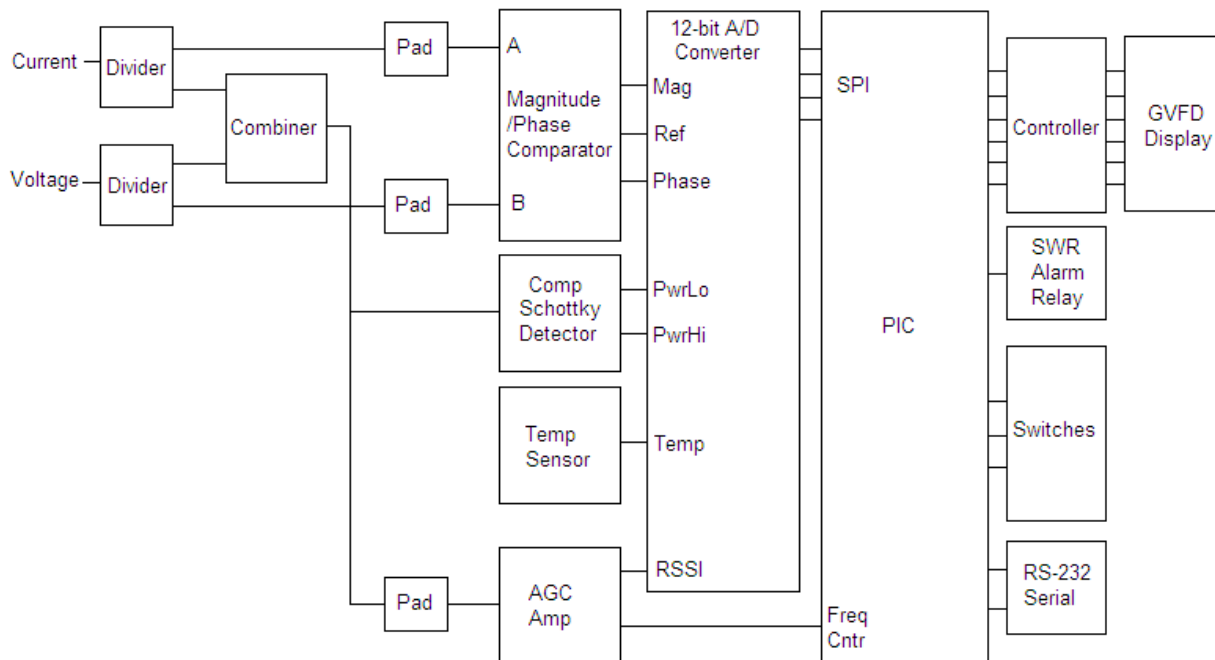

First, instead of using a coupler that produces forward and reflected voltage signals, the LP-100A uses a pair of transformers that sample current in the transmission line and voltage across the load. The samples are split into two paths, which provide signals to both the gain/phase comparator and the power detector.

With a 50 ohm non-reactive load, the levels of these two signals will be virtually identical, and the phase between them will be zero degrees. As the load varies from perfect, the relative magnitude and phase of the two samples varies, providing the meter with the information it needs to calculate the complex reflection coefficient, rho, from which SWR and impedance are derived.

The combiner adds these two samples vectorially, providing a maximum output of 2x the input power with a perfect load, and proportionately less with less perfect loads. The power sample is rectified in the Schottky diode detector, which uses a special dual diode package to eliminate errors associated with temperature tracking and forward / reverse voltage drop differences. The output of the detector is fed through precision voltage dividers to produce two power ranges, and in combination with a 12-bit A/D converter and precision 2.5V reference chip, provides an effective resolution 12 to 13.6 bits (higher resolution on the lower range).

The power sample also feeds an AGC amp which provides a constant, clean sine-wave output signal over a 50dB+ range of input power. This signal is sliced to create a square wave which feeds the frequency counter in the PIC to allow automatic frequency detection at all power levels. This allows for automatic per-band calibration of all calibration parameters in the LP-100A.

The AGC amp also provides a DC "Received Signal Strength Indicator" which is used for a number of level detection tasks within the PIC. The A/D converter also receives temperature information from the temp sensor to compensate for any residual temperature related effects in the power detection circuitry.

# Circuit Description Cont'd

The combiner also provides isolated signals to the gain/phase detector, providing 50dB of isolation between the signals, so that they can be accurately sampled at the input of the gain/phase comparator without affecting each other. The gain/phase comparator produces a DC voltage which is proportional to the log of the magnitude difference between its inputs, and another which is proportional to the phase difference between the inputs. (The sign of phase is not attainable using the present gain/phase detector, but is relatively easy to determine in operation by QSYing up a little and noting the direction of phase movement. I have developed a circuit for sign detection, but it would require a rather substantial change to the PCB. I may change to it in the future, but it wouldn't be for quite awhile). The phase/gain detector voltages are sampled by the A/D converter and the result is sent to the PIC over a Serial Peripheral Interface.

Remaining connections to the PIC include switch inputs for the three front panel switches, interfacing to the GVFD display processor and an SWR alarm relay which is used to kill the PTT to your amplifier to protect both the antenna and amplifier. The SWR alarm also lights a front panel LED, and optionally can be jumpered to sound a piezo transducer. The PIC uses all these signals to calculate all the various displayed parameters.

Finally, the PIC provides a standard RS-232 serial interface for remote control and monitoring of the LP-100A. Functions of the LP-100A can be controlled from a Windows® "Virtual Control Panel" program, either locally or over a network connection, including the internet. The PIC's firmware can also be updated through downloadable hex files which can be "flashed" into the PIC's memory. A program entitled MicroCode Loader (MCLoader), from Mecanique®, is provided to do this.

A Windows® charting program is also provided to allow graphing of any of the LP-100A's parameters including Z, R, X, SWR and phase angle vs. frequency. The Plot program also offers a Smith Chart display, and I plan to add a translation function to allow for automatic transformation of coupler load Z to antenna feedpoint Z. The programs will provide for inputting feedline length and type for popular types of feedline. More on this is Appendix A.

# Schematic Page 1

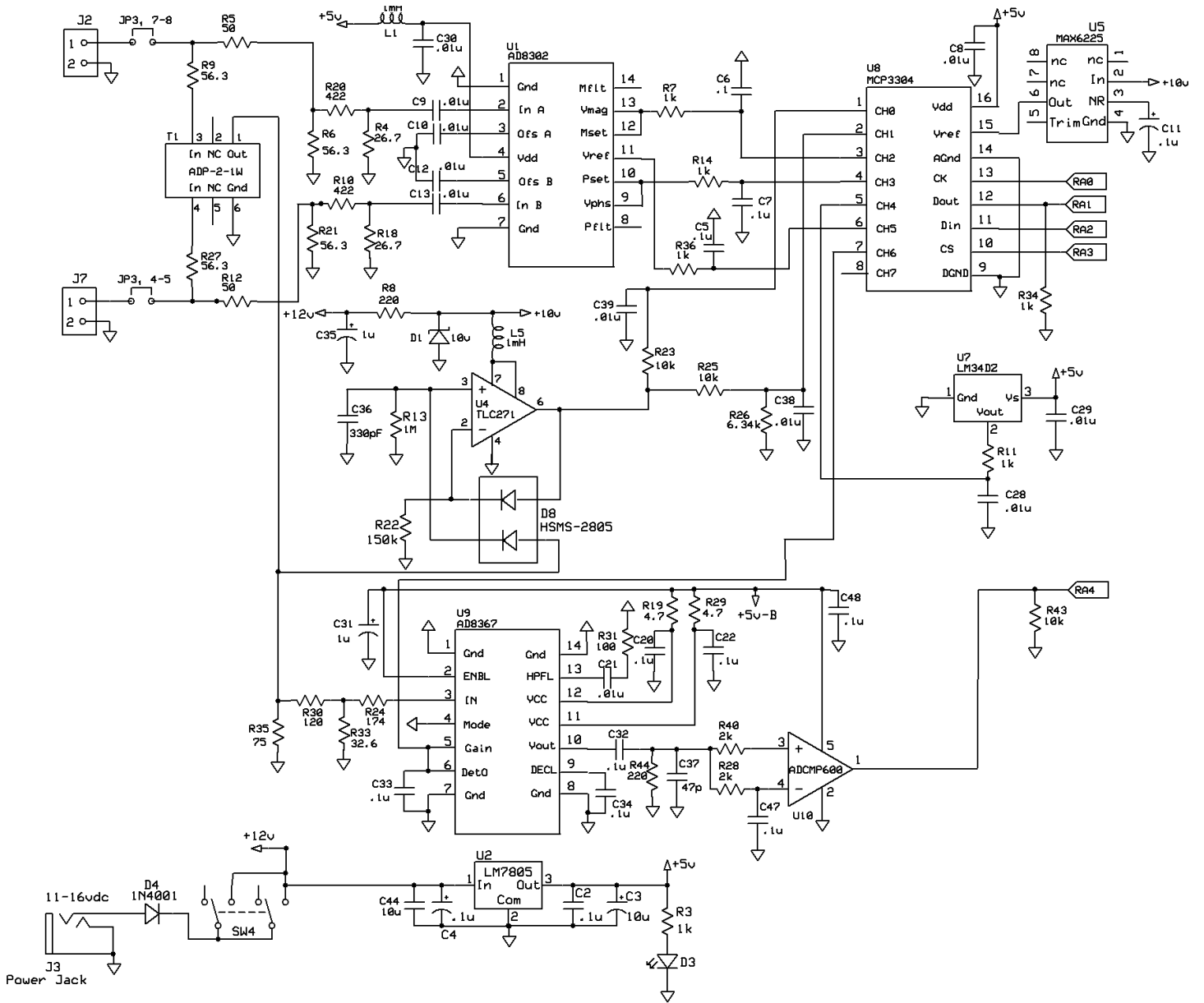

# Schematic Page 2

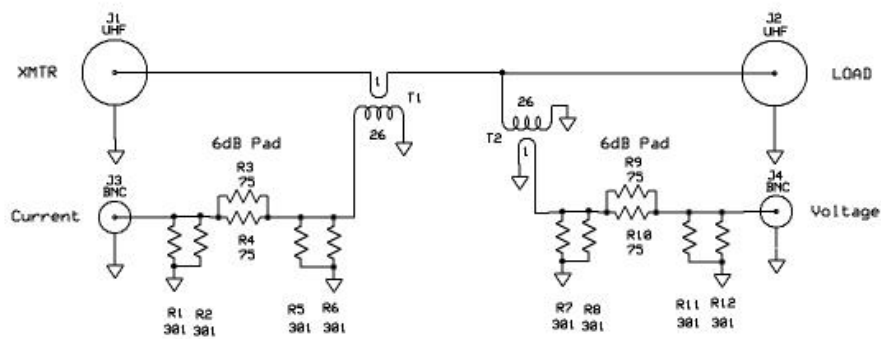
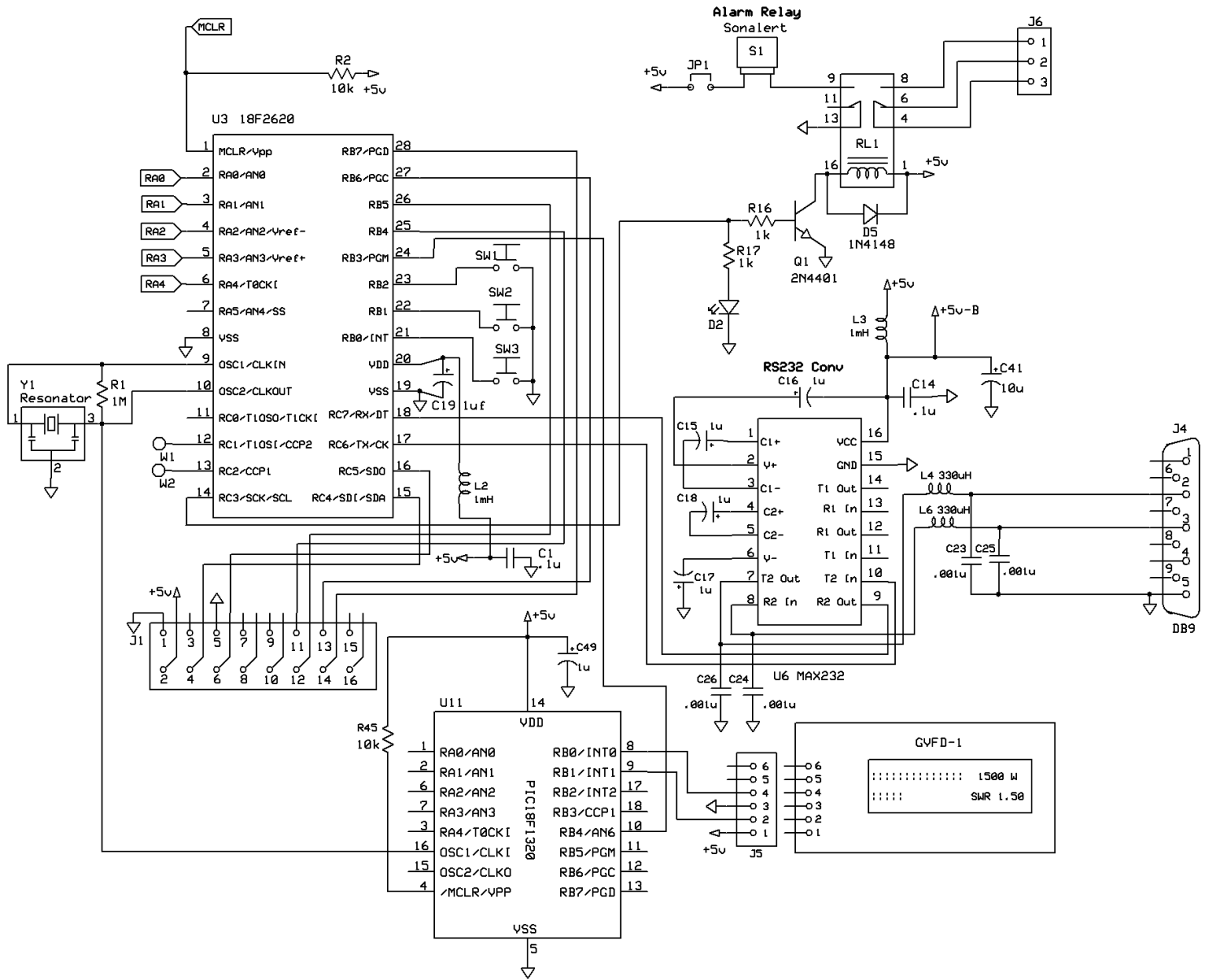

Coupler Schematic

# Troubleshooting

Below are some problems that have been reported and solutions. If you still have a problem, I am always available by email at [larry@telepostinc.com](mailto:larry@telepostinc.com) and the newly formed LP-100 Yahoo Group is available at <http://groups.yahoo.com/group/LP-100/>. For excessive current, always check for solder bridges and proper orientation of ICs first. If a step calls for more than one IC to be added and current is excessive, remove the ICs and re-install one-by-one until you narrow the source of the high current.

Problem	Suggested solution
No +5 VDC at Initial Checkout Step 1.	Check wiring of U2 and D5, and that the white-striped wire on the power cord is connected to the + lead of the supply.
Excessive current at Initial Checkout Step 1.	Check for proper polarity on D5.
Excessive current at Initial Checkout Step 2.	Check for proper placement of U7 and U3 (PIC).
Improper display at Initial Checkout Step 2.	Check that Y1 is soldered properly. Check that the GVFD cable is installed properly. If all this checks out, the PIC firmware or GVFD controller firmware may be bad. Try flashing with the latest firmware on the LP-100-Updates page.
Excessive current at Initial Checkout Step 3.	Check for proper placement of the added ICs.
Incorrect operation of buttons.	Check for good ground lead connection on three tactile switches.
Incorrect values for RSSI or Temp.	Check U5 & U8 for proper orientation. Check output voltage of U5 at pin 6. It should be very close to 2.500 V. Check for proper orientation of U7 for Temp. Check soldering around U9 for RSSI.
Excessive current at Initial Checkout Step 4.	Check R39 and C42 for proper wiring.
Frequency counter is not registering the correct band	Check U9 by looking at the RSSI voltage on the Reference CAL screen. It should vary with applied RF power. Normal voltages are ~0.400V at 5W, ~0.660V at 100W. Also check the wiring of parts in the vicinity of U10.
Temperature is not being displayed	Check that U7 is installed properly. Remember, the silk-screening is backwards for this part on serial #s 1-100.
Impedance display is backwards (ie., 25 ohms displays as 100 ohms and vice versa).	Current and Voltage cables are reversed.
SWR reads 9.98 at all power levels and loads	Make sure the jumper below DL1 & C46 is installed. Double check the soldering inside the coupler, especially around the attenuator board. The DC resistance at the two BNC connectors on the coupler should read about 30.2 ohms each.

# Software

## Connecting to the computer

The LP-100A provides a RS-232 serial port. The serial settings are 115,200 baud, 8 bits, no parity, 1 stop bit. The required cable is a straight through (not crossover or null modem), with a male DB9 at one end and a female DB9 at the other. With typical motherboard or bus card provided serial ports, there are no settings required in the computer or driver, just in the application which controls the LP-100. In the case of the provided software such VCP and Plot, these settings are automatic except for com port selection. Any free com port from 1-15 is acceptable.

If your computer doesn't have a serial port, which is becoming increasingly the case, there is a simple solution as long as the computer has a USB port, which is usually the case. A number of USB to serial adapters are available on the web or at computer/appliance stores. The LP-100 has been successfully used with a number of these. I can personally vouch for the Keyspan USA-19HS, although I don't know if they have a driver yet for the 64-bit version of Microsoft Vista. An inexpensive converter that some have reported good results with is the Y-105 from ByteRunner, [www.byterunner.com](http://www.byterunner.com). They cost \$8.69 plus shipping as of this date, and provide full handshaking (not needed for LP-100, but useful for some rigs and devices), but no obvious Vista support. This adapter uses the Prolific chipset, which may not be supported in the future. You may need to download a different driver than the one supplied with this unit when using XP. Search the internet for ICUSB232. ByteRunner also sells an adapter which uses the well supported FTDI chipset for about \$18, model USB-COM-CBL. Drivers for almost any platform should be downloadable from FTDI. I have been asked about a USB port for the LP-100, and it would be easy to do, but since all ham software has native RS-232 com support, and older machines don't have USB ports, I think a RS-232 port with an inexpensive USB adapter where needed is the most flexible choice.

The LP-100 has been used successfully over the Internet using serial device servers such as those offered by Lantronix and Digi. I have personally used several of the Lantronix models with no problems.

## Virtual Control Panel (VCP)

VCP is provided for computer or remote operation of your LP-100 wattmeter. VCP allows you to control the basic functions of the LP-100, and it also allows you to monitor the LP-100 parameters remotely.

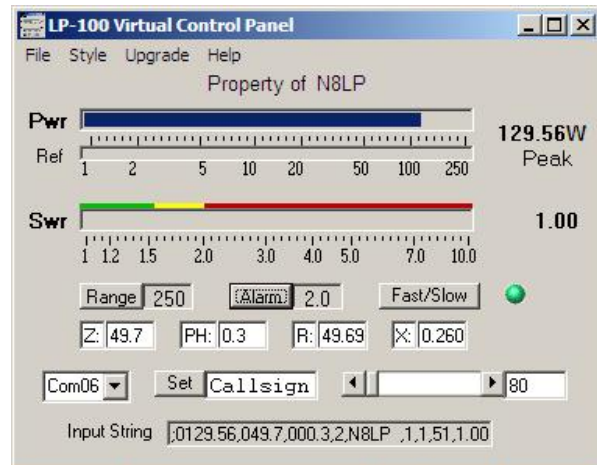

**Control...**  
Alarm Set  
Peak/Avg/Tune  
Call Sign Entry

**Monitoring...**  
Power  
Impedance  
Resistance  
Alarm Status  
SWR  
Phase  
Reactance

There are three views for the VCP, selectable under the Style pulldown. The two shown above, plus one which shows all but the setup info. The Menu choices provide the following functionality...

Style: Selects among the three views mentioned above

Upgrade: Launches the MCLoader program. This program can also be launched manually by adding a shortcut to the program.

Help: A work in progress.

The setup controls include Com port selection, callsign entry and a polling rate slider, adjustable from 50 msec to 5 sec. The normal setting is 80 msec, which gives an update rate of 12 samples per second. On slower computers, or over the internet, you can use a slower rate.



# Software Cont'd

The buttons on the VCP perform the following functions...

- \* Range: Allows switching the maximum power range of the display. Choices are 25, 250, 2500W and Auto for autoranging.
- \* Alarm: Sets the SWR Alarm set point. Choices are Off, 1.5, 2.0, 2.5, 3.0. If the alarm on the LP-100 trips, the Alarm button turns red.
- \* Peak/Avg/Tune: Switches between normal and peak-hold modes. The current mode is displayed under the power reading.

There are two other versions coming for use with TRX-Manager. The first, called LP-100 VCP Slave, allows the LP-100 to broadcast its data to TRX-Manager for display inside TRX-Manager, either locally or over the internet. The other, LP-100 VCP Master, allows the LP-100 to use TRX-Manager's remote telnet facility to make a remote connection between the LP-100 and the VCP. In addition to the LP-100 VCP, you can communicate with the LP-100 with a terminal program or your own software using the following commands...

- A Increments Alarm Set Point selection
- M Increments Mode selection
- F Toggles Power Peak/Avg/Tune selection
- P Poll for data. Example of response... ;1457.00,49.3,005.0,2,N8LP ,0,2,61.6,1.02

From left to right, the comma separated values represent...

Power, Z, Phase, SWR Alarm Set Point: 0=off, 1=1.5, 2=2.0, 3=2.5, 4=3.0, Callsign (6 digits with space padding), Power range: 0=High, 1=Mid, 2=Low, Peak Hold Mode: 0=Average, 1= Peak Hold, dBm, SWR

**Note:** The commands for firmware version 1.2.0.0 and above are different than those for earlier versions. I have added an option in the Setup section of VCP, Plot and TRX-Slave to allow use with versions of firmware that are earlier or later than 1.2.0.0. If you need to see the old protocol, or have developed software to work with the LP-100, you should refer to an older manual to see the differences.

The serial settings are 115,200 baud, 8 bits, no parity, 1 stop bit. **NOTE:** Firmware versions before 1.2.0.0 used a baud rate of 38,400, and before 1.0.3 used a baud rate of 19,200 and did not report dBm or SWR values.

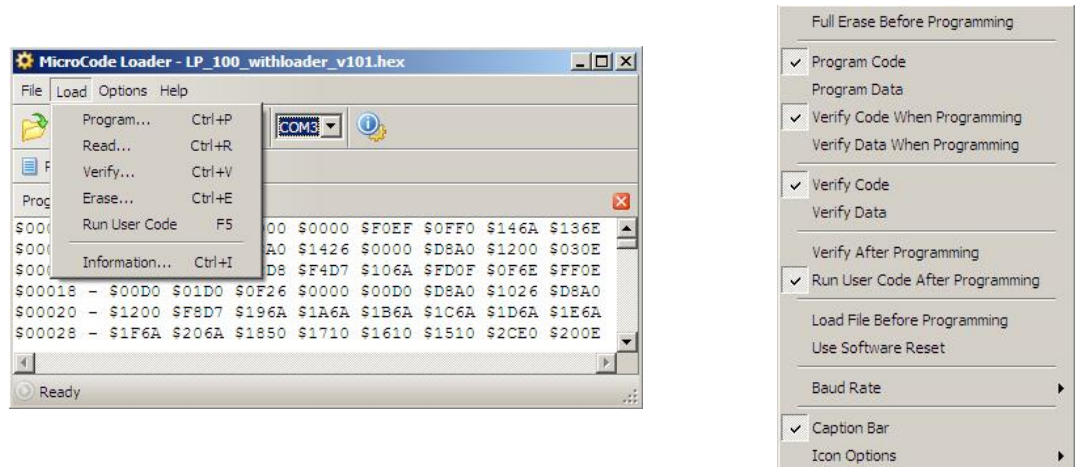

## MicroCode Loader

Before attempting to flash new firmware, make sure the connection between the LP-100 and PC is solid. You can do this by running the VCP program. MicroCode Loader works with the MCLoader bootstrap loader program installed on your PIC. It allows the user to easily update the firmware in the LP-100. The correct settings for MicroCode Loader, found under the Options pulldown, are as shown. **NOTE:** Make sure you settings match these before starting. If you select Program Data, the factory defaults will be loaded into your CAL constant table.

All that is required is to download the latest version of the firmware from my website, save it to a convenient folder, such as C:\Program Files\LP-100-VCPUpdates and then load the file into MCLoader using the File>Open menu. **Note:** It is important to open the file you want each time you launch MCLoader, or else it will start up with the last used file, and you may forget to open a new file and reprogram your LP-100 with an older version. It is even possible that you might have a file from another device loaded, since MCLoader is used by other manufacturers as well.

Once MCLoader is running, and you have the correct firmware file open, you need to set the correct LP-100 com port for the LP-100. The default baud rate of "Auto" should be fine, but if you experience problems, you may want to try setting baud rate to 19,200 (under Options). When all of this is done, click on Load>Program. You will see a message to Reset the PIC. This is done by cycling the power to the LP-100. A progress bar in MCLoader will show the progress of the programming, and the LP-100 will start again when programming is finished. The "Splash" screen will now indicate the new version at startup. During programming, the LP-100 displays "PIC Reset" if the software reset is used.

# Software Cont'd

## Plot

Plot version 1.01 is available for download on the LP-100 Current Software page at <http://www.telepostinc.com/LP-100-Update.html>.

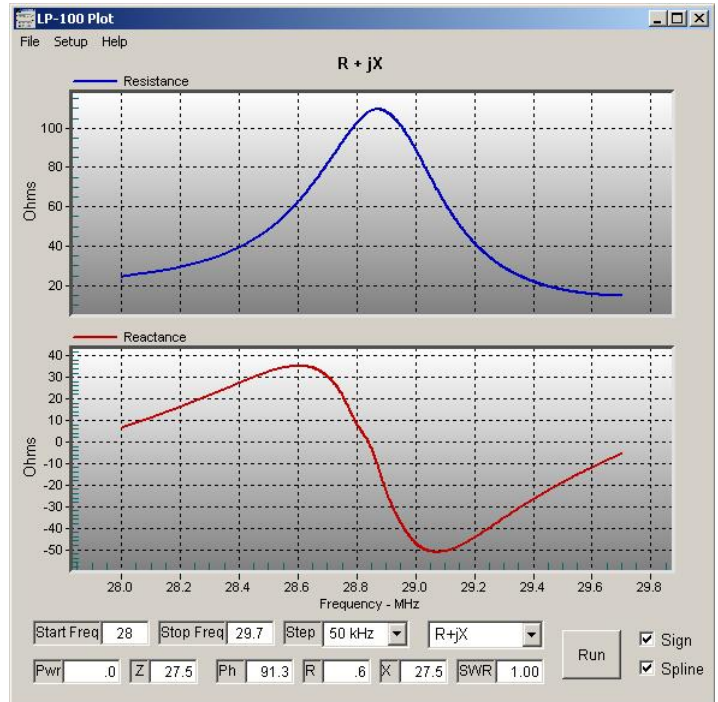
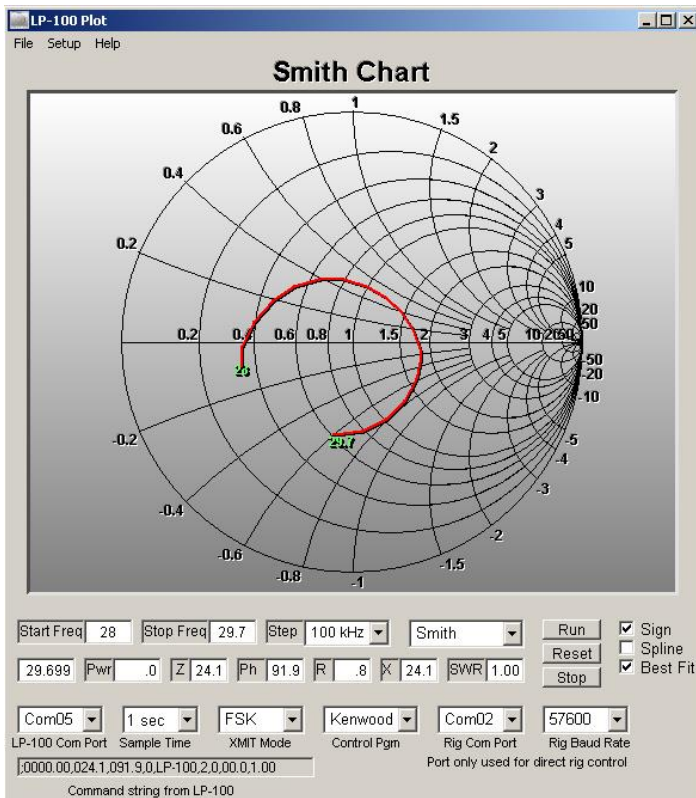

The Plot program is designed to interface between your rig and the LP-100A Digital vector Wattmeter, to enable scanning of antennas or other loads and displaying performance parameters versus frequency. The program is not limited in terms of the frequency range which can be scanned, but of course when an antenna is the load, you must limit the transmit frequencies to bands you are licensed for. The first second plot above is shown in Diagnostic display mode, and the second in Normal mode. These options are chosen in the Setup menu.

Control of the rig is provided in two ways. Kenwood and Elecraft radios can be directly controlled by the Plot program. Other rigs can be controlled with linking to several popular CAT/logging programs... TRX-Manager, DXLabs Commander and Ham Radio Deluxe (HRD). Transmit mode is also selectable. For most rigs, FSK is a good choice, but AM and CW are also available. To use CW, you will probably need an interface which uses the RTS or DTR handshaking pins of a serial port for keying, either homebrew or part of a rig interface like RigBlaster. In the case of the Elecraft K2, the "tune" mode is used, since the rig doesn't support FSK or AM modes.

### Display modes are...

R+jX... Resistance and Reactance  
 Impedance (Z)... Magnitude and phase angle  
 SWR  
 Reflection Coefficient  
 Return Loss  
 Smith Chart

### Display types are...

Linear... points are connected by straight lines  
 Spline... points are connected with a cubic spline function  
 Best Fit... Curve fitting using 4th order polynomial expression

### Scanning parameters...

Start Freq.  
 Stop Freq.  
 Step Size  
 Sample Time

The Plot program can display either raw data, or attempt to determine sign of reactance/phase based on impedance and phase slopes. This works quite well for most antennas, and in the cases where it fails, it's pretty easy to see the bad points. These points can be fixed by clicking on each bad point, which reverses the sign of that point.

# Software Cont'd

## Basic Operation

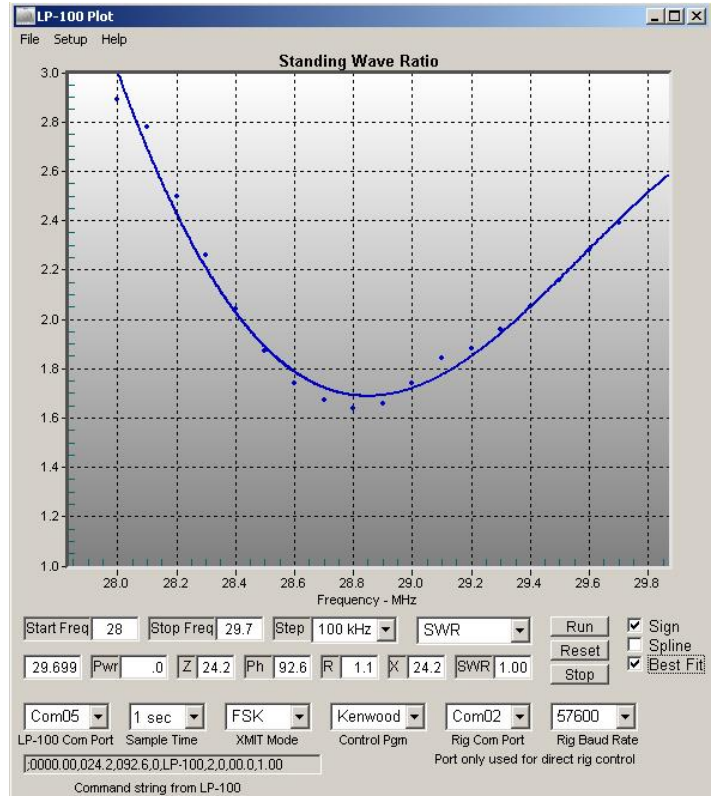
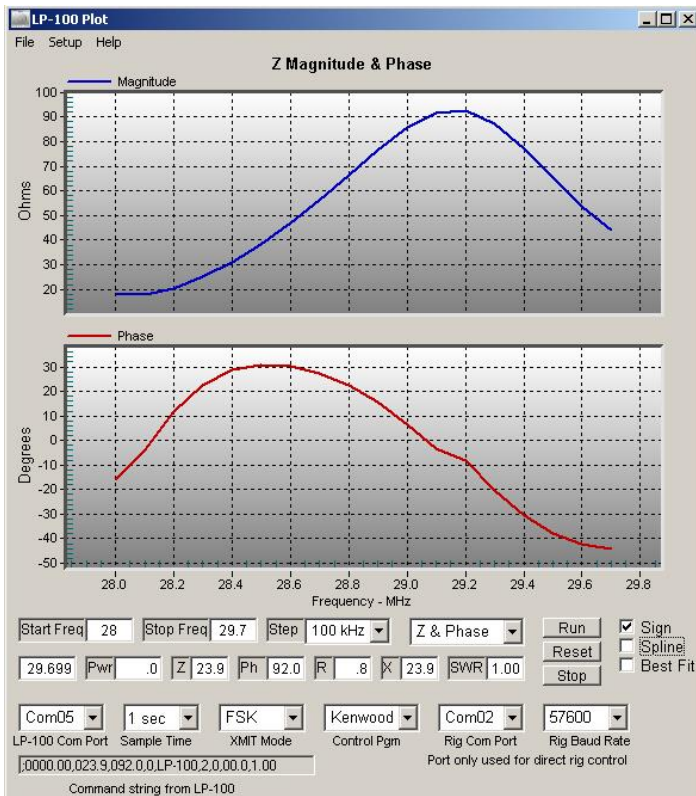

When you first launch Plot, you should see something similar to the above, although the default display is R+jX. If you don't see the setup info at the bottom, select Diag in the Setup menu. Select the LP-100 com port number in the far left com port selector, and the firmware range of your LP-100A. You should immediately see a Command string from the LP-100, similar to the above. The LP-100A must be in Average mode for sweeps.

Next, select your method of rig control. If you are using a Kenwood rig, you will be able to control the rig directly. Select Kenwood for Control Program, enter the rig's com port and baud rate in the indicated areas, and select a transmit mode. FSK generally works best for most rigs. If you are using a K2, select K2, select the correct com port and set baud rate to 4800. Mode doesn't matter for K2, as it is permanently set to "tune".

If you have another brand/model, you will need to select a CAT/logging program for control. The choices are TRX-Manager, DXLabs Commander and Ham Radio Deluxe (HRD). First make sure that your rig is being controlled by the CAT program. Once you have established that it is, simply select the proper program from the Control Program list. The com port and baud rate are set in the CAT program in this mode, not in Plot.

Next, set a start and stop frequency for the scan. Plot automatically adds 1 kHz to the start frequency and subtracts 1 kHz from the stop frequency. This is necessary because some rigs will not transmit at the band edges in all modes. Set a step size. For single band scans of most bands, 50 kHz is a good size. Sometimes larger steps with Spline or Best Fit will give a smoother curve.

Select the parameter you wish to display, and click Run. The program will step through the frequencies, and gather the data. The raw data will be displayed as it goes, and the frequency box under the Start Frequency will update. If you have "Sign" checked, at the end of the scan the program will correct the sign of X or phase based on the detection algorithm. If there are a few bad points, which can happen when Z is very flat, you can correct them by clicking on the bad points. They will flip sign. This can be done repeatedly to smooth up the curve. R+jX, Z/Phase and Smith can all be edited this way, and the results will be reflected in any of the other screens. You can change between parameters without affecting the data unless you start another scan or click Reset.

If you use a large step size, the curve can be smoothed further by selecting Spline or Best Fit. The Z screen above uses linear interpolation (none selected). The screen below uses Best Fit. Spline looks similar to linear for small step sizes, but is smoother for large step sizes. You can switch between curve types after scanning without affecting data. You can also zoom into the chart vertically. Just click and drag to expand a chart. Right clicking in the chart area cancels zoom.

For future operational input, see Recommended Procedures below.

# Software Cont'd

## SaveAs/Export/Print Dialog

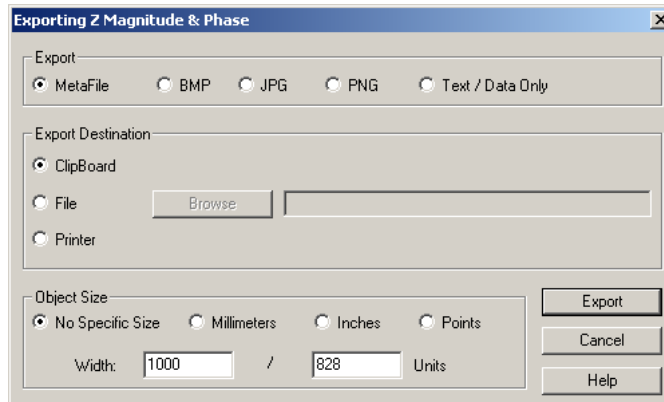

This screen is accessed under the File menu. It allows saving and printing of the plot results in a variety of formats. The basic procedure for its use is to select the file type at the top, select a destination and size, and then click export. If you select Text/Data and File as the destination, a standard Windows explorer type file dialog will appear, where you can navigate to the folder you want and name a file, etc. When you click Export, you be given more options for the file format. This is also the case for ClipBoard destination.

When saving pictures, JPG and PNG produce the smallest files. Also, changing the size to 500 x 414 will make smaller picture files. When Printer is selected, the first radio button under Object Size will change to Full Page. Click on Millimeters or Inches to produce a smaller picture. Initially the size will be half size on width and height. You can change dimensions, but you have to keep the ratio the same or the picture will be distorted. Full Page can be useful for Smith charts if you want to add other data manually to them. Generally, half size is better. When you click on Export, you will see a standard Windows Printer Dialog.

See Recommended Procedures for more info.

## Recommended Procedures

\* Select 1 sec for sampling unless you have a SteppIR antenna. Longer delays between samples allow a SteppIR to tune before samples are taken. 2-3 seconds are good. If your rig is sluggish when using a CAT program, a longer sample time is also necessary.

\* If you are plotting R+jX or Z/Phase, I suggest starting with Spline off and running a sweep. If there are any sign detection errors, correct by clicking on the bad points. It's easier to see these without Spline on. A "hand" will appear when you hover over the point. Clicking will reverse the sign. You can do this repeatedly to toggle the point. How can you tell the sign is "bad"? Generally speaking, X or Phase never "bounce" off of zero or swing radically through zero (like from +20 to -20) over a 50 kHz span. If this happens, reverse the first point after the bounce or error, and any others as necessary to make a smooth curve. With a little practice it will become easy to spot a problem. You can double-check your result by looking at the Smith Chart as well. The curve should be smooth and semi-circular. Reactance / phase will generally cross zero at a resonance point (peak or dip in Z or Resistance). Generally, a mistake will usually only happen when the resonance point is broad or ambiguous... or very narrow as in a screwdriver antenna. After fixing the curve, you can display other screens as you like, and save or print them. The data will remain until you run a new scan, press Reset or close the program.

\* To stop the program while in a sweep, press Stop. You may have to click it a few times for it to register.

\* When saving pictures, I recommend jpg or png. For a given size picture, png will produce the smallest file. The default size is 1000 x 828. It may be more convenient to save a quarter size picture, ie. 500 x 414. You can enter the values manually. For a text file I recommend List format, with Comma Separated Values. This can easily be imported into Excel. Printing will be faster by selecting a choice other than Full Page, which produces a picture size based on the screen resolution, but you can print full screen if desired. This may be useful for Smith Charts if you plan to develop a matching network from the plot. BTW, in the future I plan to offer this feature in the program, along with transmission line transformations based on feedline length.

\* Make sure any internal antenna tuner in your rig is off when making plots, or else the results will not be accurate.

\* It is recommended that the CAT program, if selected, be running before starting a sweep.

\* If results appear erratic, try a larger step time. I found no problem at 1 second with my K2 or TS-480S using either direct or CAT control, but other rigs may vary.

# Software Cont'd

## PolarPlot:

PolarPlot is a freeware program written by Bob Freeth, G4HFQ. It is designed mainly to create polar antenna plots from power samples, but it can also produce histograms of power over time. Combined with the nifty Field Strength feature of the LP-100, PolarPlot provides a slick way to plot beam patterns, calculate gain, etc. I have added support for PolarPlot in LP-100\_VCP ver. 1.0.7.

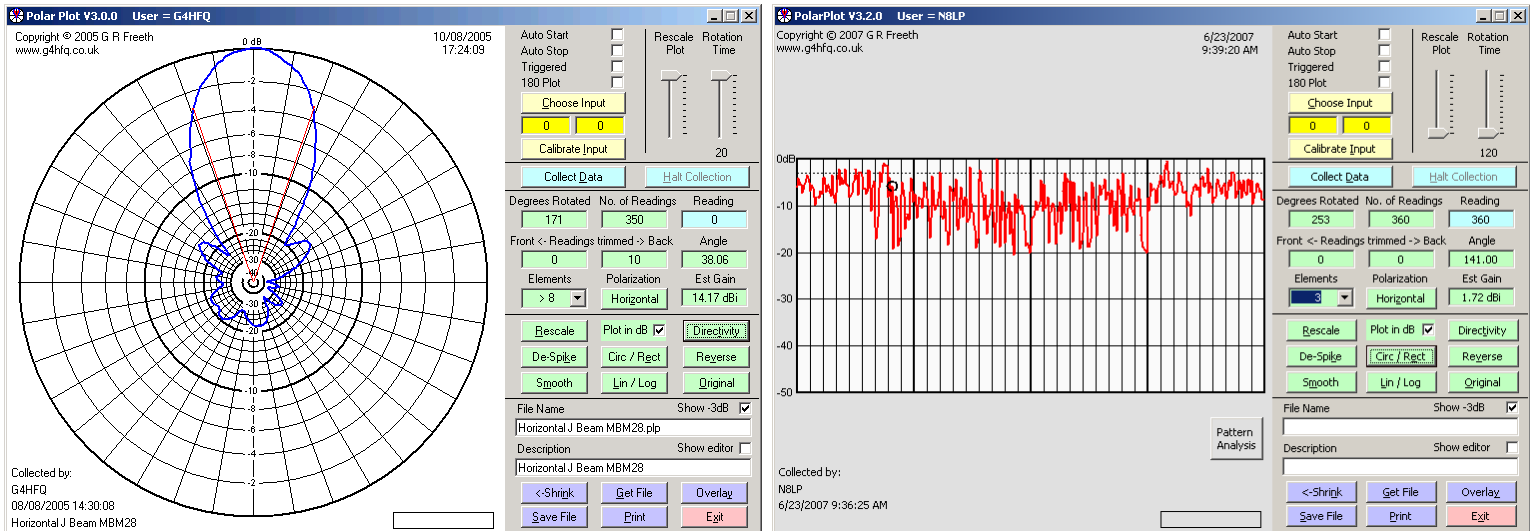

Here are some links to PolarPlot 3.2.0 for downloading the program and help file.

- <http://www.g4hfq.co.uk/> - Bob's main web page
- <http://www.g4hfq.co.uk/download.html> - download page
- <http://s4468.gridserver.com/g4hfq/PolarPlotSetup.exe> - direct link to installation file
- <http://www.g4hfq.co.uk/plphelp/plphelp.htm> - direct link to help file

I will not go into detail here on the use of PolarPlot, but I will briefly discuss the basic operation as it pertains to the LP-100. The basic setup would be to set the LP-100 up for operation in Field Strength mode (sampling antenna plugged into one of the ports on the back of the main LP-100A chassis). This will allow you to plot received levels in the -15 dBm to +33 dBm range. This range should work well for HF/6m antenna plotting. The sampling antenna can either be the beam under test, or a small dipole. In the case of the beam, a neighbor in the far field (~10 wavelengths away) or a remote transmitter of sufficient power supplies the signal. Alternatively, the sampling antenna can be a small dipole, with the transmitter connected to the beam. In this case, good isolation of the feedline to the remote antenna would be needed, or the LP-100A located remotely with a laptop computer which would allow remote control of the LP-100.

To use PolarPlot with the LP-100A, you just need to set the LP-100A up for Field Strength measurement, launch VCP and then launch PolarPlot. In PolarPlot, you select LP-100A by clicking on the Choose Input button, and clicking on the LP-100 entry. A "dB Meter" dialog box will pop up showing 9999 as the current signal level from the LP-100. Transmit with the beam pointed at 0 degrees (front), and double-click on Calibrate. You will see a new reading in the dB Meter window. Click on the wide button that says "Calibrate the current reading as 0dB". This will set the outer 0dB ring of the plot to maximum.

Next, set the Rotation Time slider for the time it takes your rotator to turn 360 degrees. All that is necessary now is to start the rotator at 0 degrees and click the "Collect Data" button at the same time. If your rotator is not consistent in its timing, you can set the time for a little longer than a rotation takes, and when the rotator reaches 360 degrees, click on the Halt Collection button, and then the Rescale button. This will rescale the plot both in amplitude and azimuth, spreading the collected data equally over 360 degrees. It also "fattens up" the dotted curve. There is no harm in using this button just to fatten up curves, even if your rotator is consistent.

Double clicking in the plot area will open a setup screen where you can change colors, etc. I find making the lines gray and the plots red provides better contrast, but you can play with it.

Refer to Bob's help file or email me for help. Bob and I are both interested in feedback on this.

# Specifications (w/ LPC1 Coupler & GVFD Display)

After factory calibration, preliminary data subject to change without notice.  
See other couplers below.

Useful Power Range:	0.05W to ~ 3,000W
Nominal Impedance:	50 ohms
Absolute Power Accuracy:	5% or better, 1W to 3KW... 3% or better typical
Band to band Power Variation:	1% or better from 1.8 to 54 MHz
SWR Range:	1.00 to 9.99
SWR Accuracy:	<.15, typically <.05 or below over 99% of power range
Directivity:	>30 dB over rated coupler frequency range (40 dB typical)
Insertion Loss	<0.05 dB
Impedance:	0-999.9 ohms Z, R and  X , <5% typical, 10-250 ohms
Phase:	0-180.0 degrees, <5 degrees (<3 degrees typical, 10-170 degrees)
Frequency counter:	1 MHz to >100 MHz, +15 to +23 dBm sensitivity (~0.1% accuracy)
Power handling:	LPC1 Coupler - 1,500W CCS, 3,000W ICAS – Others below
Bargraph response:	>50 Hz
Bargraph resolution:	90 steps
Direct Inputs:	-15 to +33 dBm, 50 ohms, 0.1 to 650 MHz +/-1.5 dB, 2W max
DC Power:	11-16 VDC @ 270-330 mA (depends on brightness setting).
Operating temp range:	0 to 50 degrees C
Clock:	40 mHz
Program memory:	64kB
Size:	Controller: 6.0" x 6.0" x 2.75" (15.24cm x 15.24cm x 6.99cm) Coupler: 2.25" x 2.40" x 5.00" (5.72cm x 6.1cm x 12.7cm)
Weight:	3 pounds (1.36 kg)

## Optional couplers:

LPC2	0.10W to 5,000W CCS, 1.8 to 30 MHz
LPC3	0.05W to 250W CCS, 10 KHz to 54 MHz
LPC4	0.10W to 5,000W ICAS, 1.8 to 54 MHz
LPC5	0.20W to 10,000W ICAS, 1.8 to 30 MHz
LPC6	0.20W to 1,000W ICAS, 100KHz to 20 MHz

## CAL Table

Description	Fine Power	Gain Zero	Phase Zero
160m			
80m			
60m			
40m			
30m			
20m			
17m			
15m			
12m			
10m			
6m			
Offset Trim			
Master Power Trim			
Gain Slope Trim			
Phase Slope Trim			
Lo/Hi Power Trim			
Frequency Counter Trim			

Log the initial CAL constants for your LP-100 in this table. If you ever make changes, you can log additional constants in the spaces provided.

# Warranty

Factory assembled LP-100s are warranted against failure due to defects in materials and workmanship for two years from the date of purchase from TelePost Inc. Warranty does not cover damage caused by abuse, accident, improper or abnormal usage, improper installation, alteration, lightning, other incidence of excessive voltage or current or improper assembly of a kit.

Units built from kit are only covered against failure due to defects in materials, with the further limitation that any parts damaged as a result of improper kit assembly are not warranted. Parts delivered damaged or missing will be replaced by TelePost Inc. at company's expense, including shipping.

If failure occurs within the warranty period, return the LP-100 to TelePost Inc. at your shipping expense. The device will be repaired or replaced, at our option, without charge, and returned to you at our shipping expense. Repaired or replaced items are warranted for the remainder of the original warranty period. You will be charged for repair or replacement of the LP-100 made after the expiration of the warranty period or where, in our reasonable opinion, the damage is due to abuse, accident, improper or abnormal usage, improper installation, alteration, lightning, other incidence of excessive voltage or current or improper assembly of a kit.

TelePost Inc. shall have no liability or responsibility to customer or any other person or entity with respect to any liability, loss or damage caused directly or indirectly by use or performance of the product or arising out of any breach of this warranty, including, but not limited to, any damages resulting from inconvenience, loss of time, data, property, revenue or profit, or any indirect, special incidental, or consequential damages, even if TelePost Inc. has been advised of such damages.

**Under no circumstances is TelePost Inc. liable for damage to your amateur radio equipment resulting from use of the LP-100, whether in accordance with the instructions in this Manual or otherwise.**

# Appendix A

## Powering the LP-100:

How should I power the LP-100? This is up to you, but the most common methods are...

Wall wart power supply capable of delivering 11-16 VDC @ 160 mA  
A RigRunner type power manifold powered by the main or accessory station power supply  
A battery pack capable of the required power

I recommend a linear power supply, although there are some good switching supplies available. In my case, I power my entire station from a deep cycle battery and charger so that it will operate uninterrupted in the case of a power failure. If you use a wall wart, it is a good idea to select one which will provide the required current and voltage, without soaring above 16 VDC with no load.

## Placement of LP-100 in the transmission line:

Where should I place the LP-100 in the transmission line between the rig and antenna?

The best place for the LP-100 coupler to be inserted is between the rig (including any amplifier) and the antenna tuner or antenna. The tuner should be considered part of the antenna system. Use of an internal tuner in the rig will result in inaccurate power and SWR readings on the LP-100 (or any other external wattmeter). The LP-100 is designed to work with a 50 ohm source impedance. When an internal antenna tuner is used, the output impedance of the rig will no longer be 50 ohms. You will also experience a power loss in the tuner of up to 20% or so, which will be seen on the LP-100. To measure an antenna's actual impedance requires that any internal tuner be bypassed, as well as any external tuner which follows the LP-100. With an external tuner following the LP-100, you can adjust the tuner while monitoring SWR or Return Loss on the LP-100 until a match is found. Switching the external tuner between operate and bypass will show the effect of the tuner.

## Power Measurement Accuracy:

This is a subject that's almost as controversial as antenna gain measurement. It seems like it should be much simpler, since it's a measurement that can be done in a controlled laboratory environment, but it is an insidiously complicated measurement to make. The process used by TelePost, and the ARRL lab is basically this...

Connect the wattmeter being calibrated to a lab quality digital wattmeter such as the HP438A that we use, which has a calibrated precision thermocouple sensor. These sensors are generally designed to operate in the 0.1 to 1W range. This necessitates the need for a precision power attenuator between the meter under test and the sensor. A convenient value for a 0.1W sensor is 30 dB, and for a 1W sensor it's 20 dB. This allows direct reading of the power in watts by viewing the milliwatt scale of the meter.

There are a number of error sources which need to be managed in this scenario...

- Actual attenuation vs. frequency for the attenuator
- Input and output Return Loss of the attenuator
- Input Return Loss of the sensor
- Sensor response vs. frequency
- Non-linearity of the sensor or meter with varying power levels
- Output impedance of the transmitter vs. frequency
- Calibration lab errors for the sensor vs. NIST standard

Some of these factors are small, but some can be significant. The sensor frequency response is specified by HP when the sensor is sent in for calibration, and a table of Cal Factors is supplied with the calibrated sensor. The actual attenuation of the attenuator vs. frequency can be characterized using a Vector Network Analyzer. This is what we do. We use a HP 8284A power sensor coupled with a JFW 50FH-030-100 attenuator. The attenuator is measured with our HP87510A VNA. The total measured error vs. frequency of this setup, including N type adapters, is just under 0.1 dB (~2%) before correction, but after applying the measured corrections, the residual error is about 0.02 dB (~0.5%). There other smaller errors, like temperature related ones, return loss related ones, etc. The absolute power accuracy of the HP meter/sensor, compared to NIST, is about 2%. To be conservative, we specify the overall accuracy of the LP-100(A) as better than 5% from 1W to 3KW, with a band-to-band peak error of 1% from 160 to 6 meters. We know of no other meter that can match this level of accuracy.

As you can see, it is very difficult to specify the accuracy relative to NIST as any better than this for any given band and power level, even with this level of test equipment. I have had a number of discussions with the lab staff at ARRL, who confirm this. They specify their measurement error for power as +/- 5%, and for PEP power, +/- 8%. Mike Tracy, KC1SX, of the ARRL lab wrote an interesting sidebar in the QST review of the Alpha 4510 power meter which discusses these issues. The sidebar appears in the July 2006 issue of QST.



# Appendix A Cont'd

## Peak Power Readings:

How should peak readings compare with steady state readings? Because of the speed and response of the LP-100, this is a loaded question, as you will see by reading on.

First of all, here's a little background on digital wattmeters. Almost all digital wattmeters use a diode peak detector to detect power. There are a few which use log detectors such as the Analog Devices AD8307. I know of none which use a true RMS detector, although Analog makes several of these chips. The Analog chips have advantages, but the biggest problem with them is accuracy, generally stated at about 0.3dB to 0.5 dB (6-10%). This error could be calibrated out, of course, but to do so at all power levels would be expensive, and not amenable to user adjustment.

A peak diode detector rectifies the RF envelope and charges a small filter cap to the peak voltage level of the applied signal. The response time of the detector is determined by the time constant of the cap and load resistance. In the case of the LP-100, this time is very small. To obtain a true "average" reading requires taking many samples over a period of time and calculating the arithmetic mean. This slows down the response of the meter to power changes in the average mode, of course. In the case of the LP-100, the sampling is adjustable, and can reach levels as high as 40,000 samples/second in the Peak-to-Average mode.

Getting back to the original question, there are several things that affect peak readings...

Where on the envelope the sample hits  
The response time of the rigs ALC  
The power supply regulation of the rig/amplifier

These items can all result in higher readings than steady state. All ALC circuits have overshoot... meaning that they can't respond instantly to set the requested power output level, especially at the leading edge of a CW character or voice syllable. This behavior also depends on the resting time between characters. The effect is exaggerated when the SWR is high, since the rig will try to back down the power due to high SWR, but can't respond quickly enough. Because the meter reads and holds the "highest" peak, it will usually be a value greater than the steady state reading for this reason. The same effect happens with a linear amplifier whose power supply is usually not regulated. There is more voltage available at the onset of power delivery than there is once the supply has stabilized. This is because the no load voltage will soar to a higher voltage than the voltage under load.

These phenomena only last for milliseconds, but the LP-100 will catch and display them until the next peak hold counter reset, which results in you seeing the transient peak power being delivered. It is up to the user to determine if this is important to you in the tuning of your amplifier.

Here are some examples of overshoot

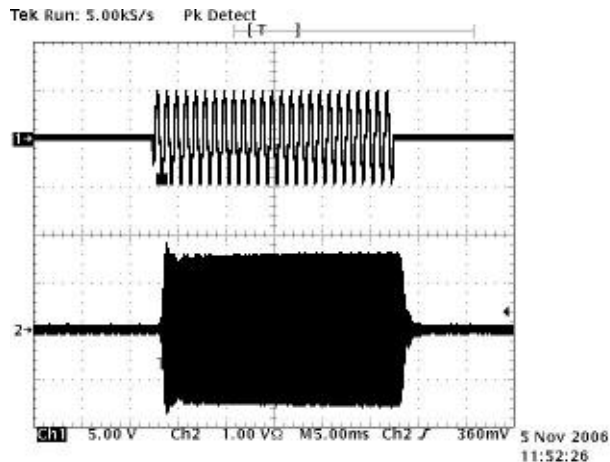
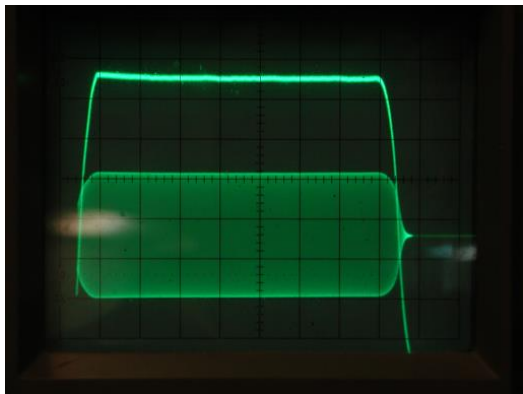

The first picture is my TS-480S in CW mode. This is in the middle of a string of dits. The effect is exaggerated if the character is the first one after a long pause. Not having a digital scope, I couldn't capture one of those. The second picture is from Jack, K8ZOA's Elecraft K2 and shows a tone burst in SSB, with the input signal on top and the RF output envelope on the bottom. It is taken from a digital scope, and illustrates the effect after a pause. **Note:** Since these are voltage displays, you would have to square them to get the effect on power overshoot. In Jack's photo, you can see that the voltage overshoot is about 12.5%, which represents a power overshoot of about 26% ( $1.125^2 = 1.265$ ). This is the value the LP-100 would grab and display if the sampling window caught the leading edge. Sampling is done at close to 100 samples/second, and the detector time constant is fast enough, that there is a good chance that peaks like this will periodically be displayed. This is normal and represents an actual event.

# Appendix A Cont'd

The peak modes should not be used for critical power measurements because of the chance for transients when initializing transmission. If critical *peak* power measurements are desired, you should use the T mode, or W mode with a hold setting 0.25 second, and take several readings to avoid random peaks. It also might make sense to start at a lower power and raise power up to the desired level.

When I developed the LP-100, I was at first confused by the occasional high peak readings, thinking there might be a problem with the meter. I built a test setup just to test this, consisting of my HP-8640B signal generator, RF Communications Model 805 10W instrumentation amp and a Totsu RF relay. This setup always produced the correct peak reading for either steady state or chopped signals, indicating that the occasional high peaks from my ham transmitters were in fact real.

## Transmission Line Z vs. Antenna Feedpoint Z:

The LP-100 measures the SWR/Z at the Load connector of the coupler. This relates to the actual antenna Z based on the type and length of transmission line. For a 50 ohm antenna load, the only difference will be determined by line loss. For a higher SWR load, the complex Z ( $R+jX$ ) of the antenna will be converted by the transformer action of the feedline to some other value, which could even reverse the sign of the reactance. I am planning to add entry screens for both the VCP and Plot programs to allow for this conversion to be done automatically for a number of user saved feedline/antenna combinations. I also plan to incorporate manipulation of the Smith Chart display to allow easy display of the effects of delay lines and matching stubs sometime in the future.

For a comprehensive review of the principles and math involved in transmission line theory, line transformations, etc., visit <http://www.cebik.com/trans/zcalc.html> This is copyrighted material published by L.B Cebik, W4RNL. He tackles a very complex subject and makes it as understandable as possible.

Another excellent source of reading is the site of Dan Maguire, AC6LA, <http://www.ac6la.com/> See particularly <http://www.ac6la.com/stss.html> for a treatment of the Smith Chart and other topics. Dan wrote one of my favorite antenna modeling programs, MultiNEC, unfortunately no longer available.

Many of the formulas used in impedance transformation are also included in the HamCalc collection by George Murphy, VE3ERP.

## Sign of X and Phase:

The LP-100 is not capable of determining the sign of X or Phase on its own. With a VNA this is possible because they use quadrature signals and multiple detectors to eliminate the phase ambiguity. There are one or two antenna analyzers which also do this in a similar or different way with good to excellent results. This is relatively easy if you are generating the signal internally, but in the case of the LP-100, the source is a high power signal out of the control of the LP-100. I have developed a circuit for sign detection, but it would require a rather substantial change to the PCB. I may change to it in the future, but it wouldn't be for quite awhile.

I have provided an automatic sign detection algorithm in the LP-100 Plot program which works quite well. It is based on detecting slope of both magnitude and phase. I also provide a means to easily reverse the displayed phase/reactance of errant datapoints before saving/printing. With a little practice, it will become easy to recognize and fix these points. The Plot program requires a serial interface between the PC and rig to allow control of the transmitter.