

Porch Railings by: Southeastern Ornamental Iron Co, Inc.

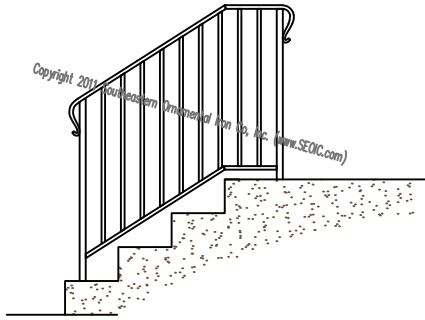

SEO-PR-01

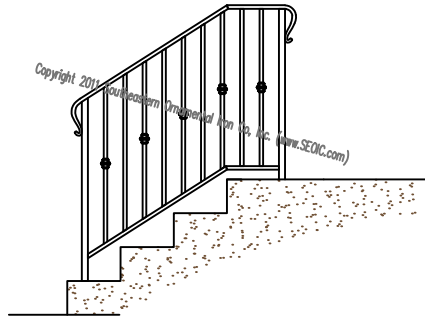

SEO-PR-01C

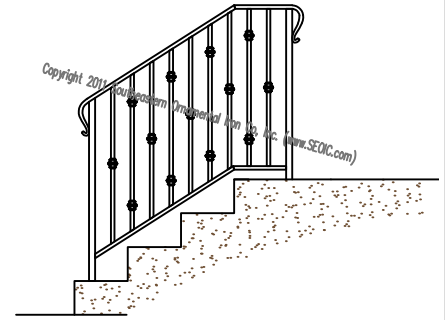

SEO-PR-01C2

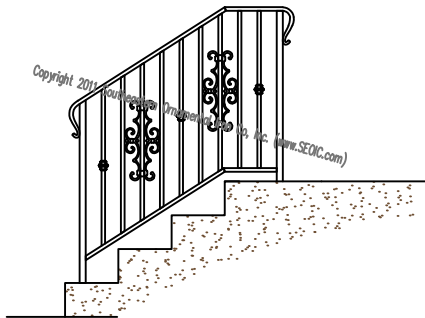

SEO-PR-02C

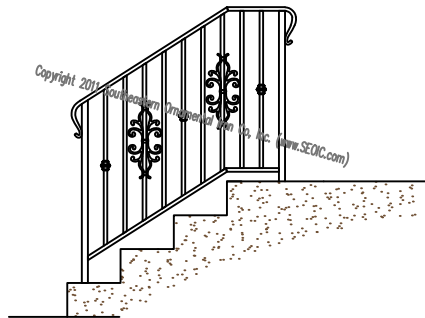

SEO-PR-020C

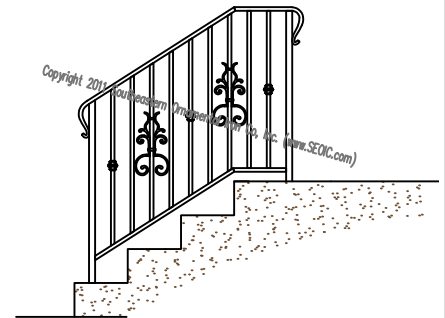

SEO-PR-03C

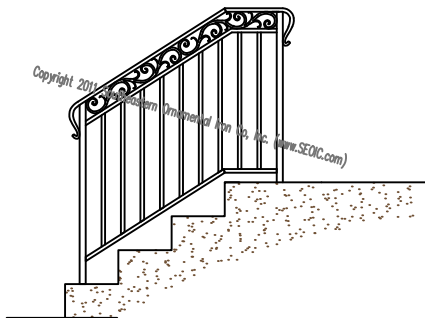

SEO-PR-04

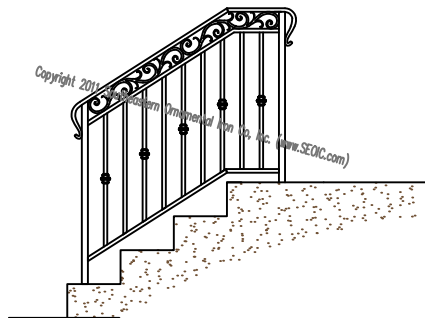

SEO-PR-04C

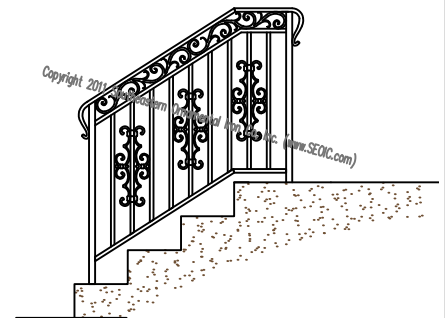

SEO-PR-04-2

Notes:

- 1). Custom sizes are available for all designs.
- 2). Porch Columns are available for all designs.(See Options Page)
- 3). All Railings are built to order.
- 4). Designs may be altered and or customized.
- 5). Standard residential height is 36". Rails can be built at any height.
- 6). All railings meet building code requirements.
- 7). All Rails are aluminum construction unless other materials are requested.
- 8). Please see options page for mounting details.

 Ph: 904-292-0933 Fx: 904-292-0588 www.SEOIC.com	Order Name and Address Porch - Patio Step Railings	Order Step Railings Date: 8/23/11 Note: AS NOTED	(01)
--	--	---	------

Porch Railings by: Southeastern Ornamental Iron Co, Inc.

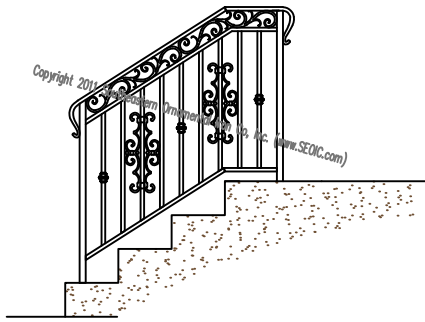

SEO-PR-04C2

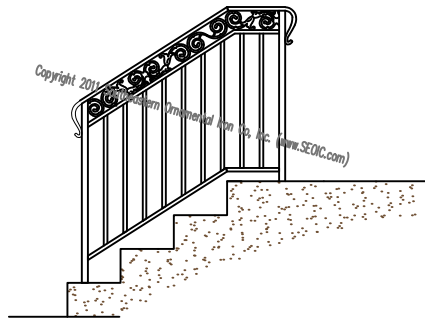

SEO-PR-63

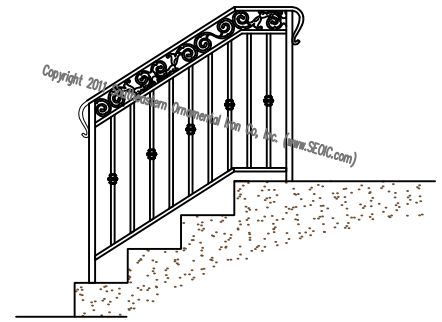

SEO-PR-63C

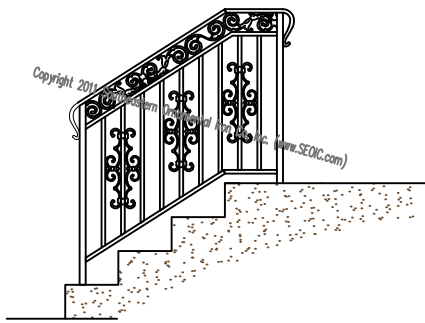

SEO-PR-63-2

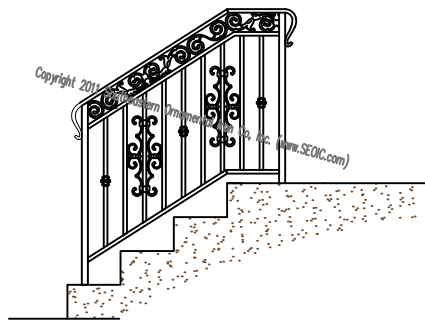

SEO-PR-63C2

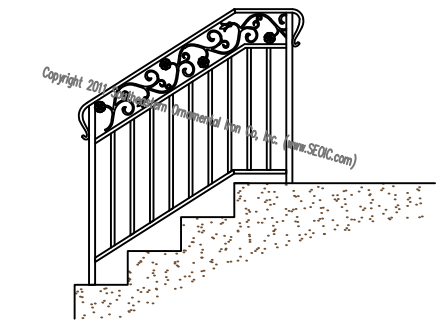

SEO-PR-08

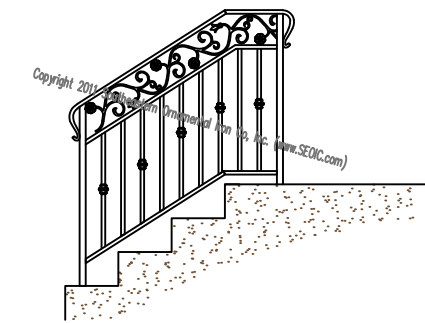

SEO-PR-08C

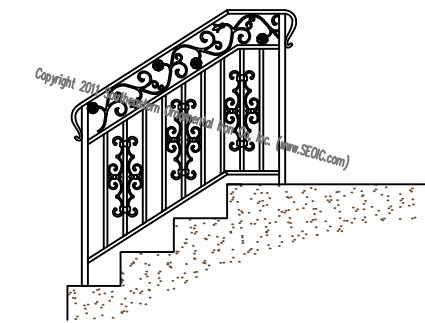

SEO-PR-08-2

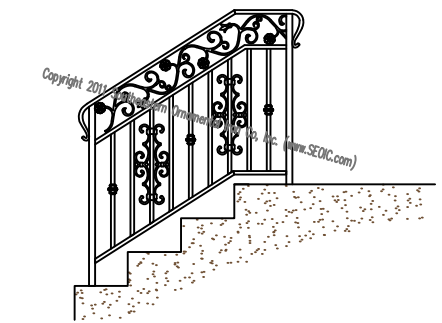

SEO-PR-08-2C

Notes:

- 1). Custom sizes are available for all designs.
- 2). Porch Columns are available for all designs.(See Options Page)
- 3). All Railings are built to order.
- 4). Designs may be altered and or customized.
- 5). Standard residential height is 36". Rails can be built at any height.
- 6). All railings meet building code requirements.
- 7). All Rails are aluminum construction unless other materials are requested.
- 8). Please see options page for mounting details.

 Ph: 904-292-0933 Fx: 904-292-0588 www.SEOIC.com	Order Name and Address Porch - Patio Step Railings	Step Railings Date: 8/23/11 Note: AS NOTED	(02)
--	--	--	------

Porch Railings by: Southeastern Ornamental Iron Co, Inc.

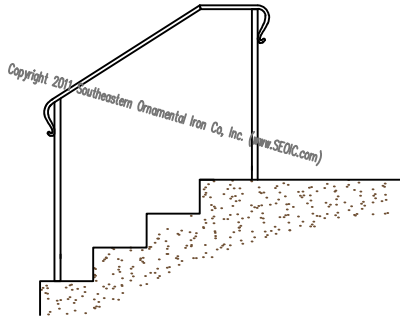

SEO-PR-SL1

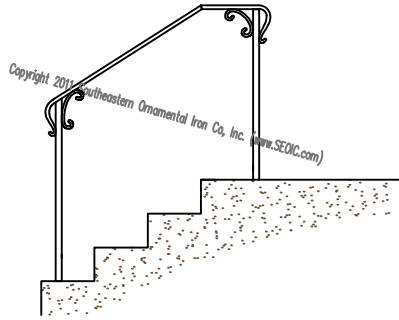

SEO-PR-SL2

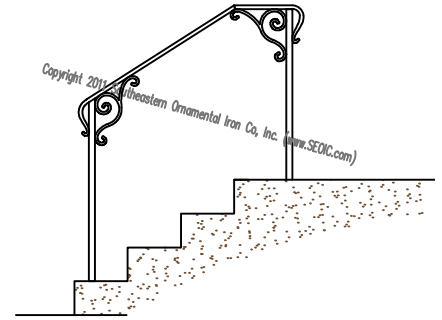

SEO-PR-SL3

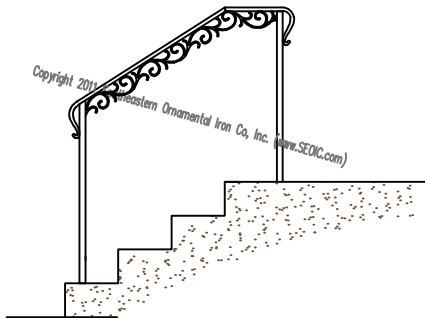

SEO-PR-SL4

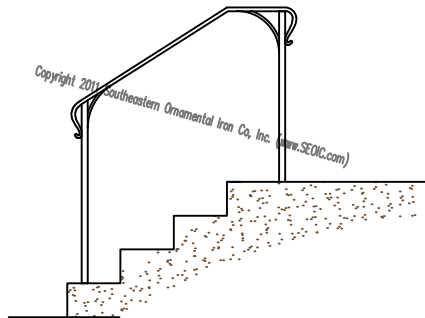

SEO-PR-SL5

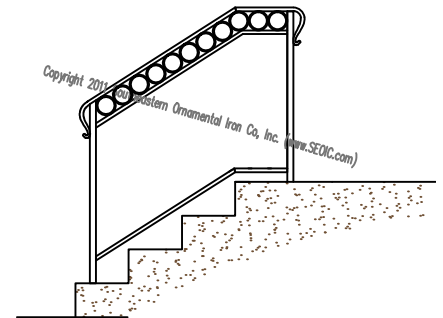

SEO-PR-SL6

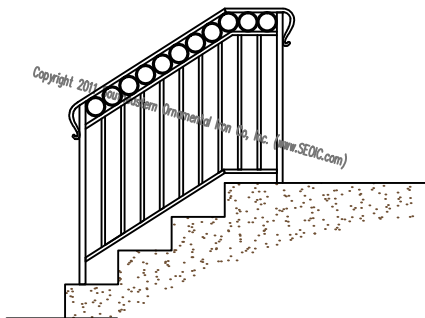

SEO-PR-13

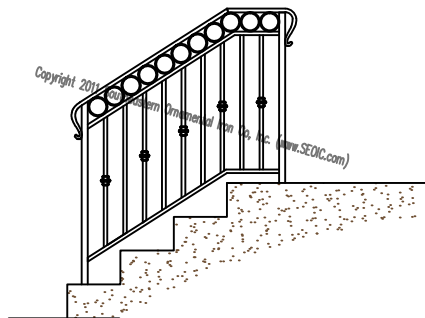

SEO-PR-13C

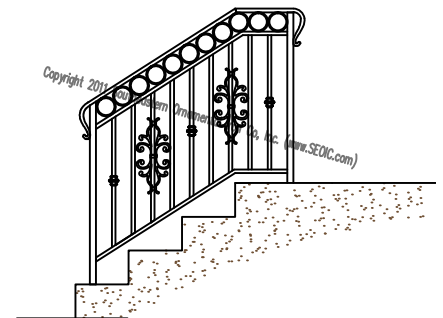

SEO-PR-SL9

<p>Ph: 904-292-0933 Fx: 904-292-0588 www.SEOIC.com</p>	Signet Name and Address Porch - Patio Step Railings	Section Step Railings	Sheet (03)
		Date 4/15/15	
		Note AS NOTED	

Porch Railings by: Southeastern Ornamental Iron Co, Inc.

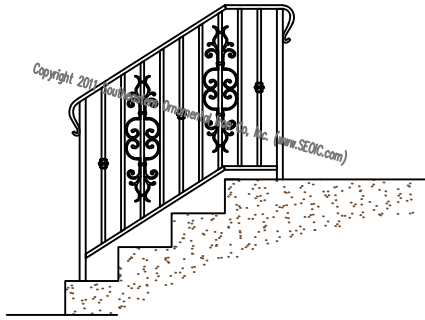

SEO-PR-032C

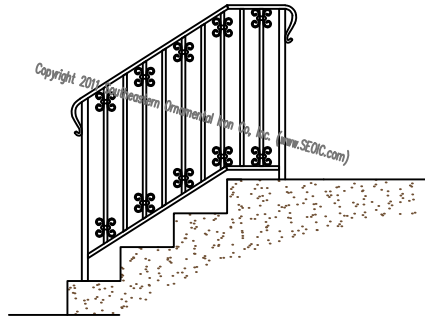

SEO-PR-10

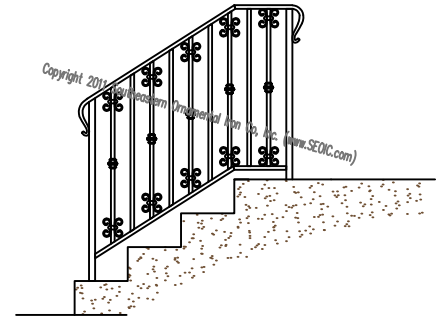

SEO-PR-10C

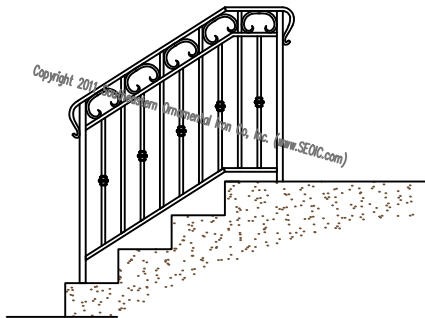

SEO-PR-24C

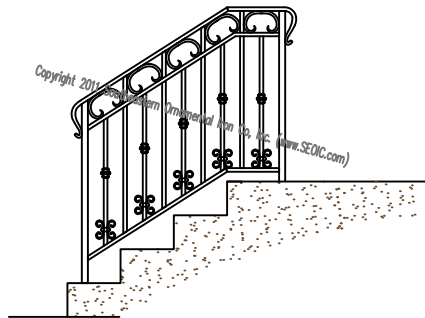

SEO-PR-24-10C

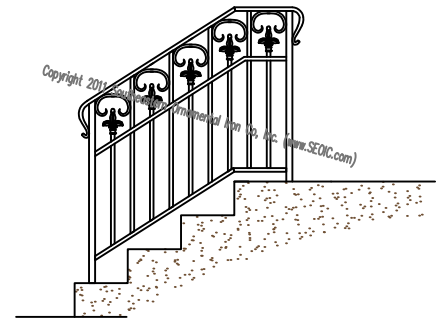

SEO-PR-25

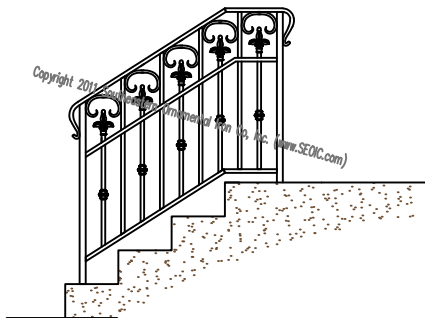

SEO-PR-25C

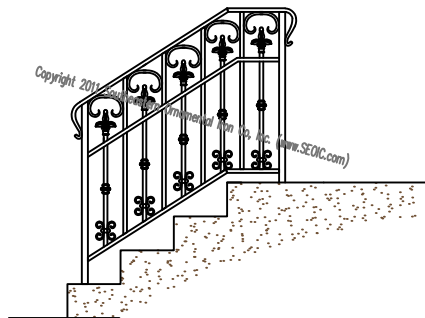

SEO-PR-26

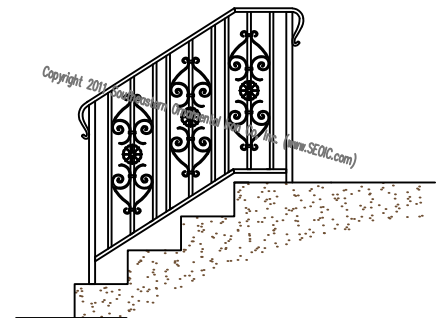

SEO-PR-21

Notes:

- 1). Custom sizes are available for all designs.
- 2). Porch Columns are available for all designs.(See Options Page)
- 3). All Railings are built to order.
- 4). Designs may be altered and or customized.
- 5). Standard residential height is 36". Rails can be built at any height.
- 6). All railings meet building code requirements.
- 7). All Rails are aluminum construction unless other materials are requested.
- 8). Please see options page for mounting details.

 Ph: 904-292-0933 Fx: 904-292-0588 www.SEOIC.com	Order Name and Address Porch - Patio Step Railings	Step Railings Date: 8/23/11 AS NOTED	(04)
--	--	--	------

Porch Railings by: Southeastern Ornamental Iron Co, Inc.

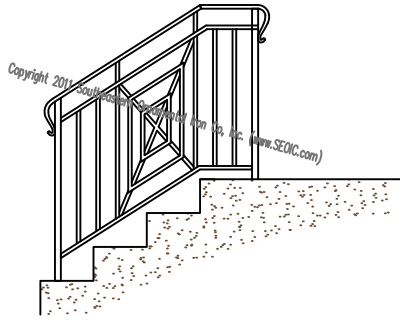

SEO-PR-35

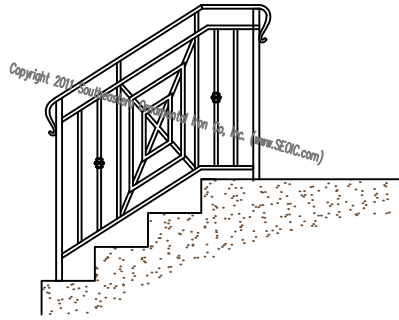

SEO-PR-35C

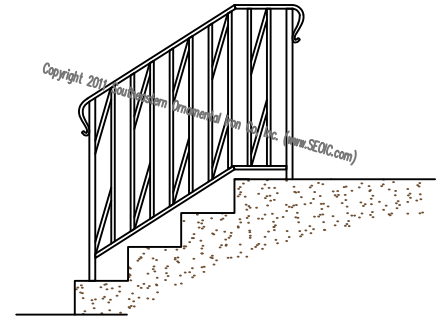

SEO-PR-36

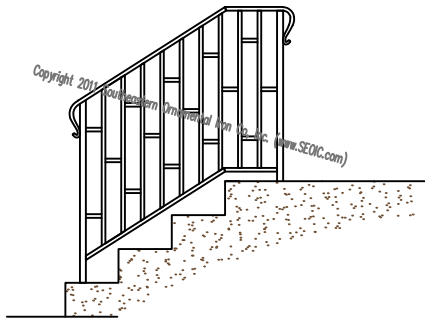

SEO-PR-37

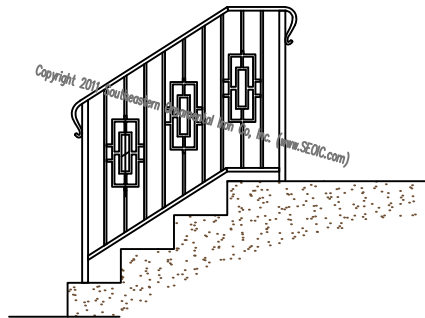

SEO-PR-38

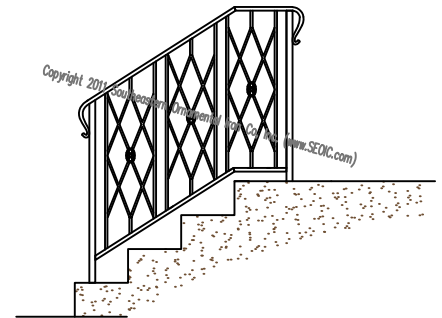

SEO-PR-81

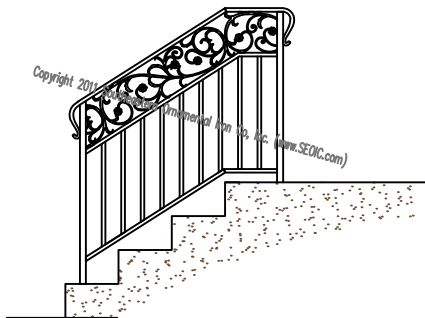

SEO-PR-14

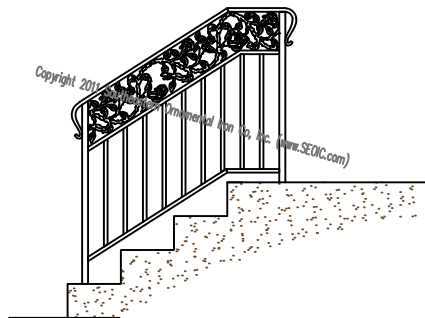

SEO-PR-101-Rose

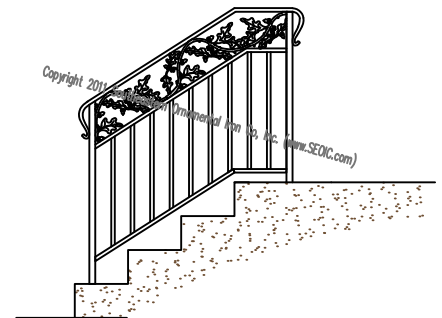

SEO-PR-07-Oak

Notes:

- 1). Custom sizes are available for all designs.
- 2). Porch Columns are available for all designs.(See Options Page)
- 3). All Railings are built to order.
- 4). Designs may be altered and or customized.
- 5). Standard residential height is 36". Rails can be built at any height.
- 6). All railings meet building code requirements.
- 7). All Rails are aluminum construction unless other materials are requested.
- 8). Please see options page for mounting details.

 <p>Ph: 904-292-0933 Fx: 904-292-0588 www.SEOIC.com</p>	<p>Order Name and Address</p> <p>Porch - Patio Step Railings</p>	<p>Step Railings</p> <p>8/23/11</p> <p>AS NOTED</p>	<p>(05)</p>
--	---	---	-------------

Measurement Guide (use as example only)

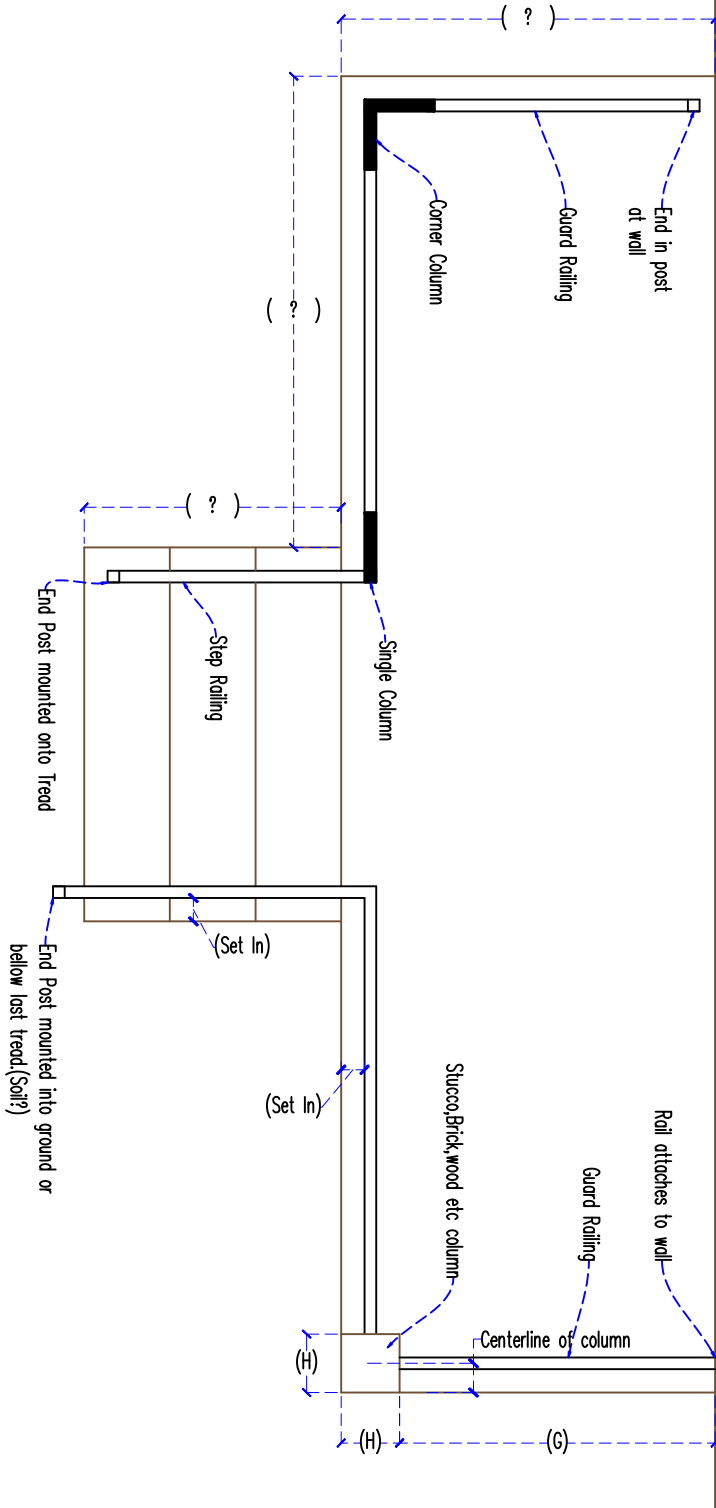

Notes:

- 1) If aluminum or iron columns are required, Provide measurement from floor to ceiling at each column location
- 2) Provide Tread and Riser measurements
- 3) Provide location of step rail End posts (mount into ground or onto tread)
- 4) Provide Set In from deck edge (Set In is Typically 2 1/2" to edge of post.)

 Ph: 904-292-0933 Fx: 904-292-0588 www.SEOIC.com	Dept Name and Address Porch - Patio Step Railings	Date 8/23/11 Note AS NOTED	Step Railings (06)
--	---	--	-----------------------

Measurement Guide & Options

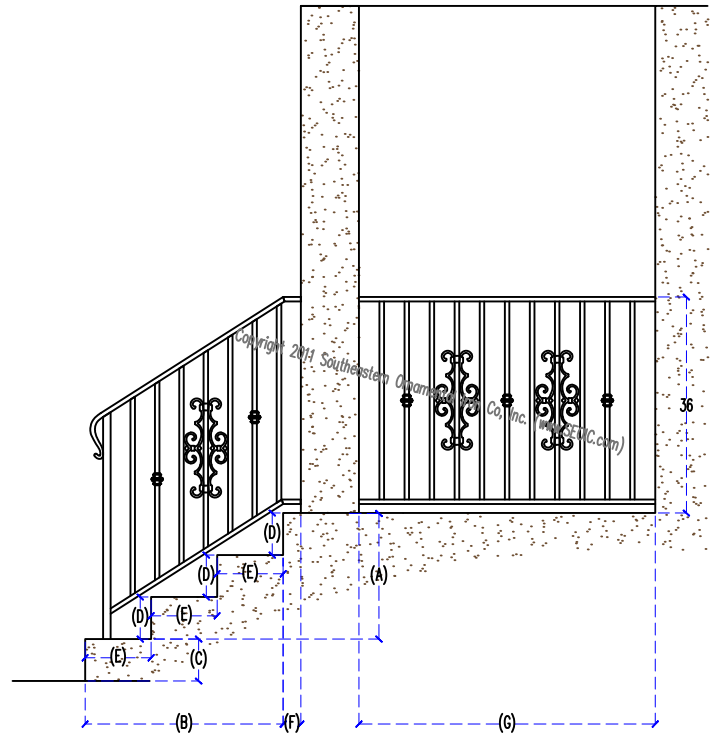
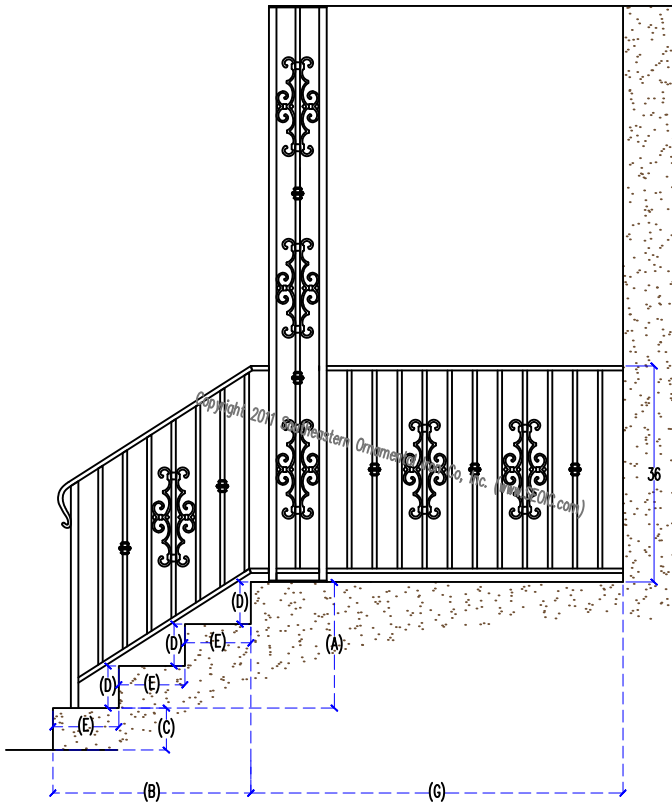
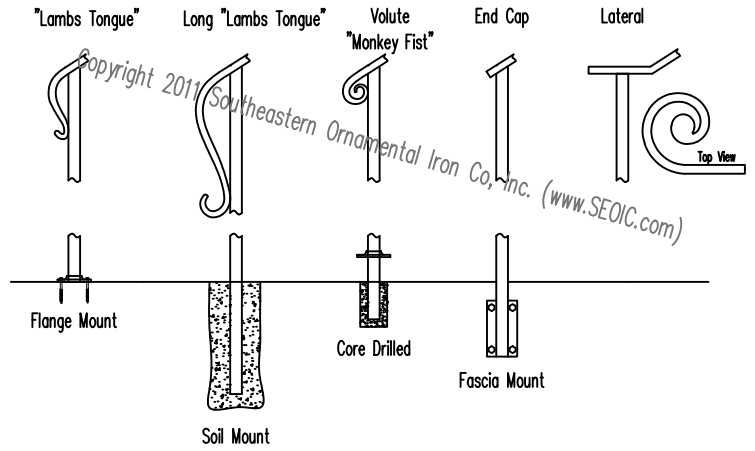
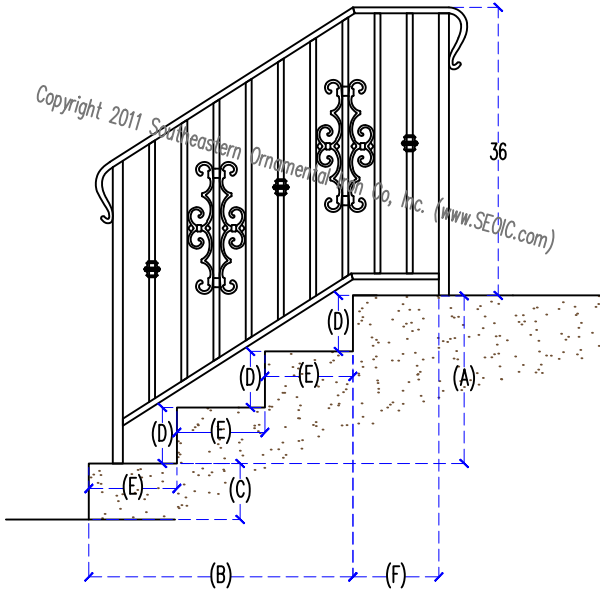

<p>Ph: 904-292-0933 Fc: 904-292-0588 www.SEOIC.com</p>	<p>Address</p> <p>Porch - Patio Step Railings</p>	<p>Product</p> <p>Step Railings (07)</p>	<p>Date</p> <p>8/23/11</p>
			<p>Notes</p> <p>AS NOTED</p>
			<p>Signature</p>

Use Chart Below to Sketch Your Steps and or Porch

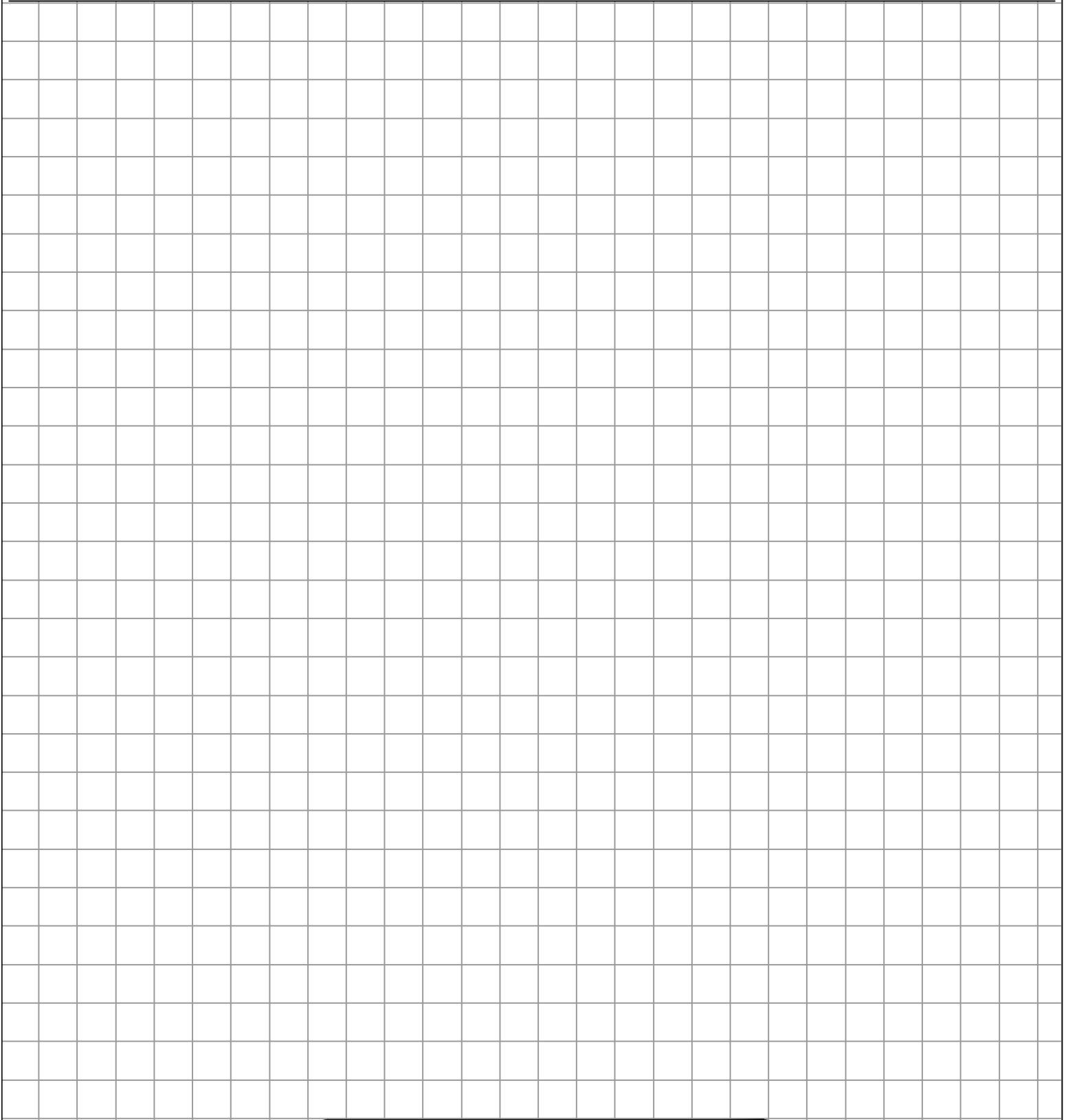

 <p>Ph: 904-292-0933 Fc: 904-292-0588 www.SEOIC.com</p>	<p>Product Name and Address</p> <p>Porch - Patio Step Railings</p>	<p>Quantity</p> <p>Step Railings</p> <p>Date</p> <p>8/18/11</p> <p>Notes</p> <p>AS NOTED</p>	<p>Price</p> <p>(08)</p>
--	--	--	--------------------------