

# Computational Aesthetic Evaluation: Automated Fitness Functions for Evolutionary Art, Design and Music

**Philip Galanter**  
Texas A&M University  
College Station, Texas, USA  
[galanter@viz.tamu.edu](mailto:galanter@viz.tamu.edu)  
<http://philipgalanter.com>

<http://www.sigevo.org/gecco-2013/>



Copyright is held by the author/owner(s).  
*GECCO'13 Companion*, July 6–10, 2013, Amsterdam, The Netherlands.  
ACM 978-1-4503-1964-5/13/07.

# Who Am I ?



- Philip Galanter (<http://philipgalanter.com>)
- Dept. of Visualization, Texas A&M University
- Coding since the early 70's + electronic music
- BA in philosophy, MFA School of Visual Arts
- Teach grad studios in generative art & PComp
- Make generative, sound, installation art
- Art theory, complexity science, related curation

# Genesis of This Tutorial



Seminar retreat In September 2009 at the Schloss Dagstuhl

*Computational Creativity: an interdisciplinary approach*

Leibniz-Zentrum fuer Informatik, Germany

(Margaret Boden, Mark D'Inverno, and Jon McCormack)

Galanter, P. (2012). *Computational Aesthetic Evaluation: Past and Future*. In J. McCormack & M. d'Inverno (Eds.), *Computers and Creativity*. (39 pages). Berlin: Springer.

papers from the seminar are available online at

<http://drops.dagstuhl.de/opus/portals/index.php?semnr=09291>

# Ground Rules



- Broad survey of paths already taken, and trailheads worth future exploration.
- Modest depth
- Please hold your questions until the end.
- I'll be happy to stay after the tutorial.
- Everything shown is also in the tutorial notes.
- Also additional info such as citations.

Any one of these topics could branch off into a discussion that would fill the session

# Computational Aesthetic Evaluation?



Computer systems capable of making normative judgments related to questions of beauty and taste in the arts

- Type 1 - Simulate, predict, or cater to human notions of beauty and taste.
- Type 2 - Meta-aesthetic exploration of all possible emergent machine aesthetics in a way disconnected from human experience.

This is not about aesthetics with regard to art, nature, and culture, or about higher order semantic content or meaning in art.

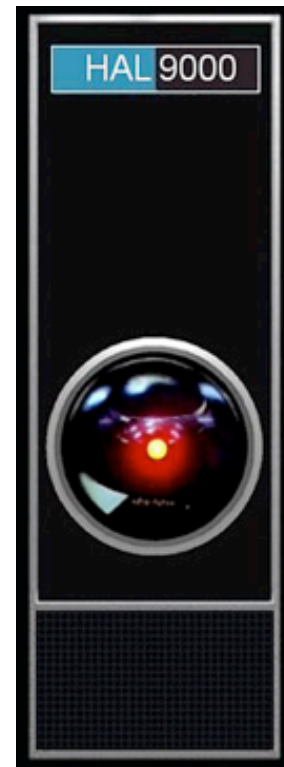

If beauty is in the eye of the beholder, what happens when the beholder is a computer?

Artistic creativity combines a generative impulse with a self-critical capacity that steers the overall process to a productive and satisfying end.

In computer art we have any number of generative systems:

- L-systems
- Cellular Automata
- Reaction-diffusion Systems
- Genetic Algorithms
- Artificial Life
- Diffusion Limited Aggregation
- Randomization
- Simulated Chaos
- Combinatorial Construction
- Data Mapping

10

What will it take to create computers that can said to be truly creative?

Why is CAE critical to computational creativity?

But we have essentially no computer methods of applying critical evaluation as artists do:

- When they exercise evaluation as they experience the work of other artists.
- As they execute countless micro-evaluations and aesthetic decisions for works-in-progress.
- As they evaluate the final product, gaining new insights for the making of the next piece.

# Computational Creativity?



- It's an almost entirely unsolved problem.
- How can we build digital systems that evaluate art, design, music, etc. with results consistent with human notions of beauty?
- It's also an exploration of meta-aesthetics. How do aesthetic responses to stimuli develop in other creatures and systems?





# CAE is really hard!



- Individual aesthetic responses likely form based on:
  - Genetic predisposition
  - Cultural assimilation
  - Individual specific experience and learning when they exercise evaluation as they experience the work of other artists.
  
- It evokes deep questions regarding:
  - Philosophy
  - Art Theory
  - Artificial Intelligence
  - Computability And Computational Complexity
  - Psychology, Neurology, Sociology
  - And More...

We WON'T be going into questions such as:

Would such a machine actually experience a sense of redness, brightness or other qualia?

How would we know?

Can machine evaluation be successful without such experience?

If a machine isn't conscious does that mean human aesthetic judgement and computational aesthetic evaluation can never converge?

But isn't the brain is itself a machine?

But even if it is, is human embodiment a requirement for human aesthetic evaluation?

## The Bad News

This will not be a “how to” tutorial.

## The Good News

If you’ve ever dreamed of making fundamental discoveries and having your articles cited for decades to come...

Here is your opportunity!

- Formulaic, Geometric, and Design Aesthetic Theories
  - Birkhoff and the Aesthetic Measure
  - The Golden Ratio
  - Zipf's Law
  - Fractal Dimension
  - Gestalt Principles
  - The Rule of Thirds
- Artificial Neural Networks and Connectionist Models

Keep in mind that this is about the CAE Problem not just in genetic algorithms used in generative art

- Evolutionary Systems
  - Overview Of Generic Operation
  - Interactive Evolutionary Computation
  - Automated Fitness Functions
    - Performance Goals Where Form Follows Function
    - Error Relative To Exemplars
    - Complexity Measures
    - Multi-objective Fitness Functions And Pareto Optimization

- Biologically Inspired Emergent Fitness Functions
  - Coevolution
  - Curious Agents
  - Niche Construction By Agents
  - Agent Swarm Behavior
- Complexity Based Models Of Aesthetics
  - Information And Computational Complexity
  - Effective Complexity
- The Origins Of Art And The Art Instinct
  - Psychological Models Of Human Aesthetics
  - Arnheim – Gestalt And Aesthetics
  - Berlyne – Arousal Potential And Preferences
  - Martindale – Prototypicality And Neural Networks

# Tutorial Outline



- Findings In Empirical Studies
  - Empirical Studies Of Viewers
  - Empirical Studies Of Artists
  - Empirical Studies Of Objects
- Neuroaesthetics
- Conclusion
- Q&A

# A Brief History of CAE

Formulas, Biological Inspiration, and Complexity



# Birkhoff's Aesthetic Measure



$$M = O / C$$

M = aesthetic effectiveness

O = degree of order

C = degree of complexity

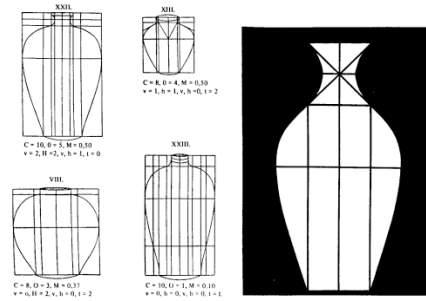

Birkhoff's psycho-neurological hypothesis:

C = as the degree to which unconscious psychological and physiological effort must be made in perceiving the object.

O = is the degree of unconscious tension released as the perception is realized. This release mostly comes from the consonance of perceived features such as “repetition, similarity, contrast, equality, symmetry, balance, and sequence.”

15

George Birkhoff notes he is only addressing formal issues and not connotative (i.e. symbolic) meaning. Also the measure is only valid within a group of similar works.

Birkhoff, G. D. (1933). Aesthetic measure. Cambridge, Mass.,: Harvard University Press.



# Birkhoff's Aesthetic Measure

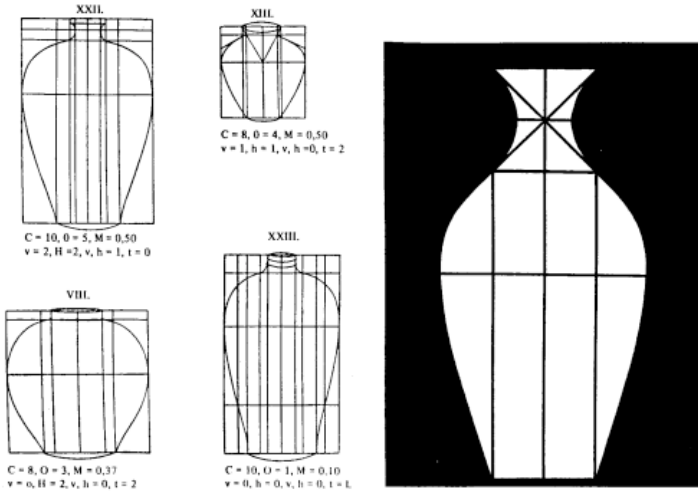

$$M = O / C$$





















M = aesthetic effectiveness  
O = degree of order  
C = degree of complexity

“The well known aesthetic demand for ‘unity in variety’ is evidently closely connected with this formula.” G. D. Birkhoff (1933)

# Birkhoff's Aesthetic Measure



$$M = O / C$$

a  1,50	b  1,25	c  1,16	d  0,90
e  0,83	f  0,83	g  0,75	h  0,75
i  0,50	j  0,50	k  0,50	l  0,40
m  0,37	n  0,37	o  0,33	p  0,33
q  0,33	r  0,33	s  0,33	t  0,33

C = number of extended lines

$O = V + E + R + HV - F$

V = vertical symmetry

E = equilibrium

R = rotational symmetry

HV = relation to horizontal /  
vertical network

F = unsatisfactory form

Birkhoff's measure relies on subjective judgements as well as "cheats" such as his "F" factor.

Empirical studies almost immediately called his work into question.

# Birkhoff's Aesthetic Measure



Douglas Wilson (1939)

“The results of this investigation do not support the hypothesis of Birkhoff that his a priori measure is a true measure of aesthetic value as far as polygons and geometrical figures are concerned.”

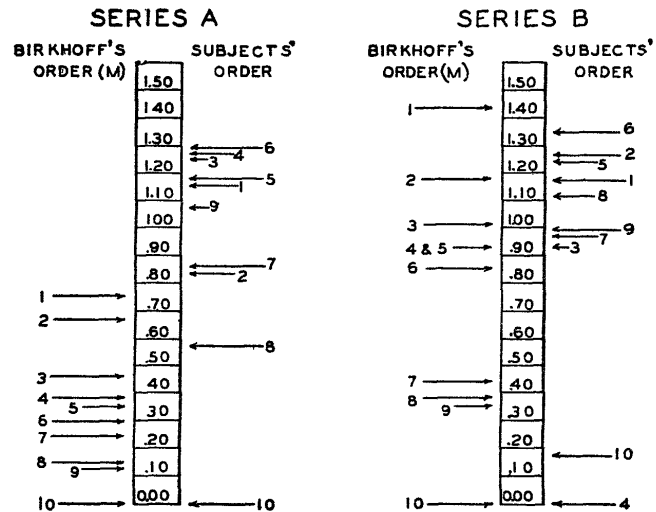

FIG 2 GRAPHIC REPRESENTATION OF ORDER OF STIMULI ACCORDING TO BIRKHOFF'S MEASURE "M," AND THAT OF SCALE VALUES OBTAINED FROM CLASS OF 95 SUBJECTS BY METHOD OF PAIRED COMPARISONS  
Note that Birkhoff's values have been corrected by eliminating all minus values and setting the lowest one at zero

Only the order matters, not the quantitative differences

n = 95 student subjects responding to paired tests

Low correlation measure Series A = .44 and Series B = .38

Wilson, D. J. (1939). An experimental investigation of Birkhoff's aesthetic measure.

The Journal of Abnormal and Social Psychology, 34(3), 390-394.

Many have noted that Birkhoff's is more a measure of orderliness than beauty.

But he made two lasting contributions:

He suggests that complexity and order relationships are key.

He suggests an underlying neurological basis for aesthetics.



- Pythagoras - strings in simple integer ratios create harmonic tones. ( 1:2, 2:3, 3:4, etc.)
- Fibonacci sequences seem to appear in nature such as spiral patterns in plants. ( 1, 1, 2, 3, 5, 8, 13, ...)

# The Golden Ratio



Related to the Fibonacci series, the Golden Ratio is also uniquely related to its own reciprocal. This results in a rectangular shape that reappears when a square is cut off.

$$\phi = 1 + (1/\phi) = \frac{1 + \sqrt{5}}{2} = 1.618\dots$$

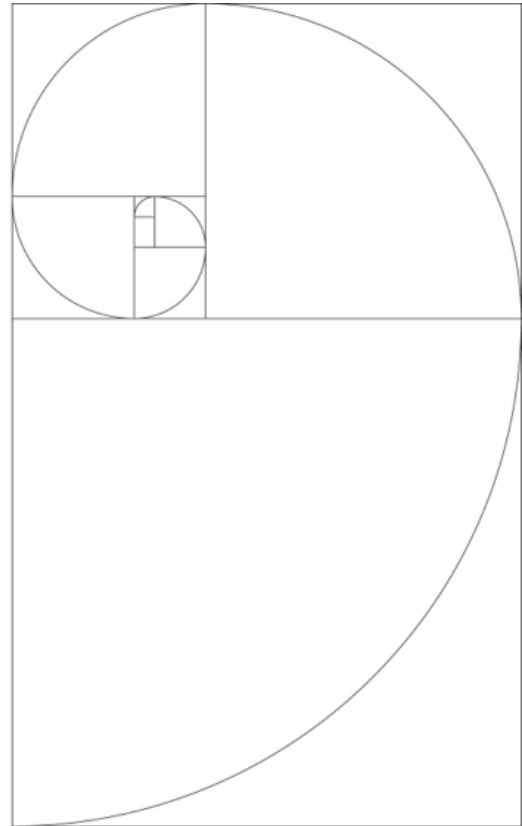

# The Golden Ratio



Psychologist Gustav Fechner is credited with conducting the first empirical studies of human aesthetic response in the 1860s. His experiments seemed to show that golden rectangles had the greatest appeal relative to other aspect ratios. But subsequent studies have cast strong doubt on those results.

Some have “discovered” the use of the Golden Ratio throughout history, but Livio (2003) has credibly debunked supposed Golden Ratio use in works by artists including:

- the Great Pyramids
- Leonardo da Vinci
- the Mona Lisa
- Mozart
- Mondrian
- Seurat

Holger, H. (1997). Why a special issue on the golden section hypothesis?: An introduction. *Empirical Studies of the Arts*, 15.

Livio, M. (2003). *The golden ratio : the story of phi, the world's most astonishing number* (1st trade pbk. ed.). New York: Broadway Books.

# The Golden Ratio

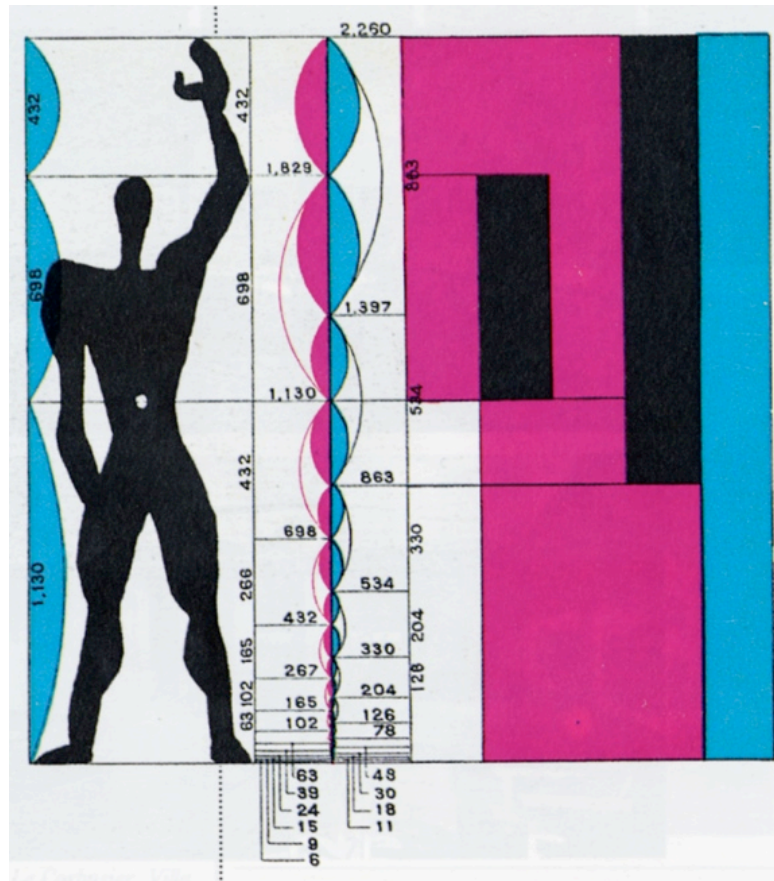

However, based on legend the Golden Ratio has been intentionally used by later artists. It has become a “self-fulfilling proportionality.”

For example Le Corbusier based his modular, a tool for design, on the Golden Ratio.

Describes the relative frequency of types in large collections.

For example, given a large text:

- Tally every word counting each occurrence.
- List each word from the most to least frequent.
- The frequency  $P$  for a given word with rank  $i$  is:

$$P_i \approx \frac{1}{i^a}$$

where the exponent  $a$  is near 1.

35

So relative to the most frequent word, the second most frequent word will occur 1/2 as often, the third most frequent word 1/3 as often, and so on...



# Zipf's Law



Manaris et al. (2005, 2003) note that this power law relationship has not only been verified in various bodies of musical composition, but also:

“colors in images, city sizes, incomes, music, earthquake magnitudes, thickness of sediment depositions, extinctions of species, traffic jams, and visits of websites, among others.”

Application in CAE has included:

- Manaris et al. (2003) classify specific musical compositions as to composer, style, and an aesthetic sense of “pleasantness.”
- Machado et al. (2007) have used Zipf's law in the creation of artificial art critics.
- Much earlier (1975) Voss and Clarke suggested using  $1/f$  distributions in generative music.

Manaris, B., Vaughan, D., Wagner, C., Romero, J., & Davis, R. B. (2003). Evolutionary music and the Zipf-Mandelbrot law: Developing fitness functions for pleasant music. *Applications of Evolutionary Computing*, 2611, 522-534.

Manaris, B., Machado, P., McCauley, C., Romero, J., & Krehbiel, D. (2005). Developing fitness functions for pleasant music: Zipf's law and interactive evolution systems. *Applications of Evolutionary Computing, Proceedings*, 3449, 498-507.

Machado, P., Romero, J., Santos, A., Cardoso, A., & Pazos, A. (2007). On the development of evolutionary artificial artists. [doi: DOI: 10.1016/j.cag.2007.08.010]. *Computers & Graphics*, 31(6), 818-826.

Voss, R. F., & Clarke, J. (1975). 1-F-Noise in Music and Speech. [Article]. *Nature*, 258(5533), 317-318.

# Fractal Dimension



- Fractals are geometric objects that exhibit self-similarity at all scales.
- The fractal dimension measures the ability of the fractal to fill the space it is in.
- An object with a fractal dimension of 1 has the space filling capacity of a line.
- An object with a fractal dimension of 2 can fill the planar space it is in.
- An object with a fractal with a dimension of 1.3 would only partially fill the plane it is in.

Peitgen, H.-O., Jürgens, H., & Saupe, D. (1992). Chaos and fractals : new frontiers of science. New York: Springer-Verlag.

Taylor, R. P. (2006). Chaos, Fractals, Nature: a new look at Jackson Pollock. Eugene, USA: Fractals Research.

# Fractal Dimension



Studies by Taylor (2006) have shown that late period “drip” paintings by Jackson Pollock are fractal-like.



The box counting method used to empirically measure the fractal dimension of Pollock paintings. Measured empirically the fractal dimension of his paintings increases over time from 1.12 in 1945 to 1.72 in 1952.

If we assume that Pollock’s technique improved over time we can say that when it comes to this body of work fractal dimension is a possible measure for computational aesthetic evaluation.

This might also (or just) be a case of the peak shift phenomenon.

# Design Principles as Informal Formulas



# Unity in Variety



The old definition of beauty in the Roman school of painting was *il più nell' uno* - multitude in unity; and there is no doubt that such is the principle of beauty.

Samuel Taylor Coleridge (Dec. 27, 1831)

The standard of beauty is the entire circuit of natural forms, — the totality of nature; which the Italians expressed by defining beauty "*il più nell' uno*."

Ralph Waldo Emerson (1849)

This idea resonates with various cognitive theories of aesthetics where high degrees of stimulation being successfully abstracted is experienced as being pleasurable.

25

Is it possible that computer vision techniques can be adapted to analyze along the lines of traditional design rules of thumb?

Emerson, R. W. (1979). *Nature, addresses, and lectures* (2d ed.). New York: AMS Press.

Coleridge, S. T., Coleridge, H. N., Coleridge, J. T., & Woodring, C. (1990). *Table talk*. Princeton, N.J.: Princeton University Press

## ■ Weight

– value, filled versus outlined, size, quantity

## ■ Placement

– imagine placement relative to a fulcrum

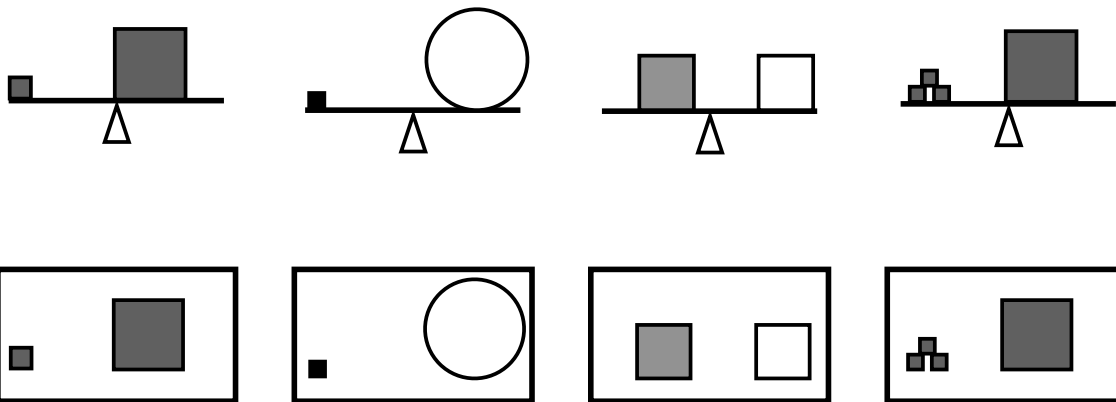

Design principles around balance often reflect our learned expectations from the physical world where we seek to avoid instability.

Stewart, M. (2008). *Launching the imagination : a comprehensive guide to basic design* (3rd ed.). Boston: McGraw-Hill Higher Education.

- Law of Prägnanz
- Perceptual grouping
- Grouping impacts balance

Our perceptual cognition seeks to abstract simplicity of structure.

- Proportion - relative size within the image
- Scale - absolute size relative to the body
  - Often overlooked by those who work with virtual media
- Color harmony
- Color contributes to weight
- Value can be more important than color
  - higher resolution
  - broader range of signal strength



# The Rule of Thirds



Peter Paul Rubens, Tiger Hunt, c. 1616.

# The Rule of Thirds

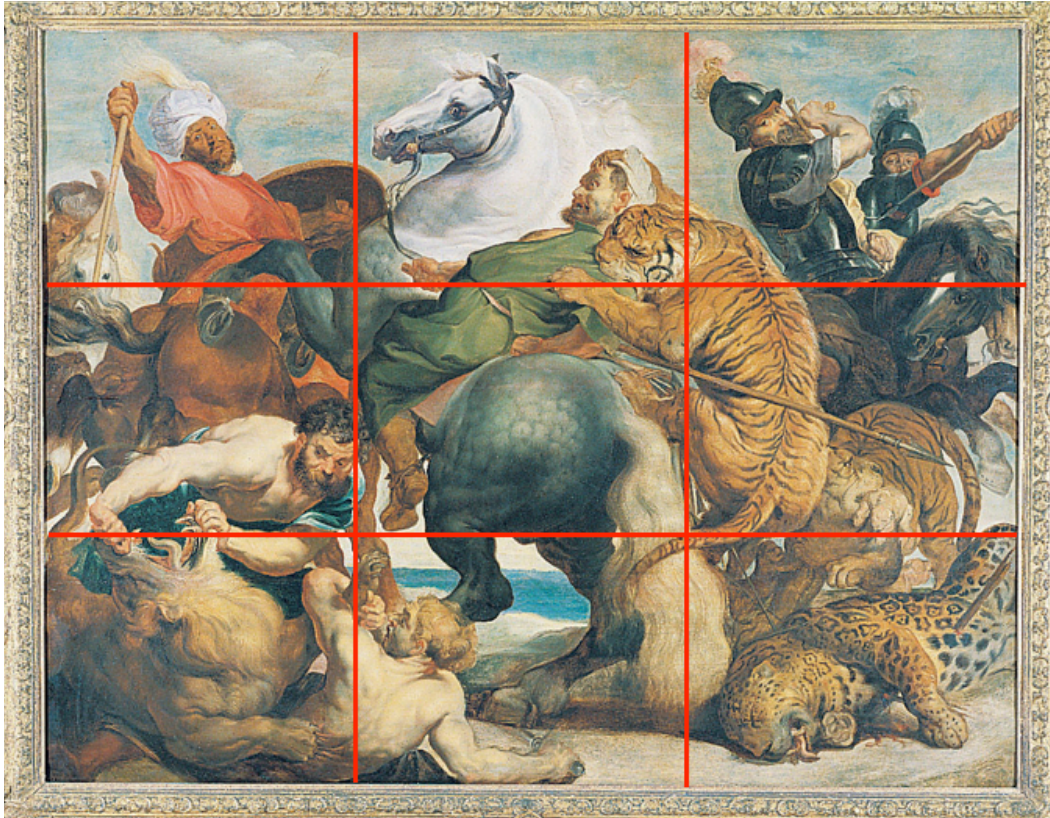

Intuitive use of rule of thirds / Note focal points

Rule of thirds not discussed until the end of the 18th century

Discussed most frequently with regard to photography

Can computer vision do this kind of analysis? Requires high level of abstraction.

# Artificial Neural Networks



# Artificial Neural Networks



Input Layer    Hidden Layer    Output Layer

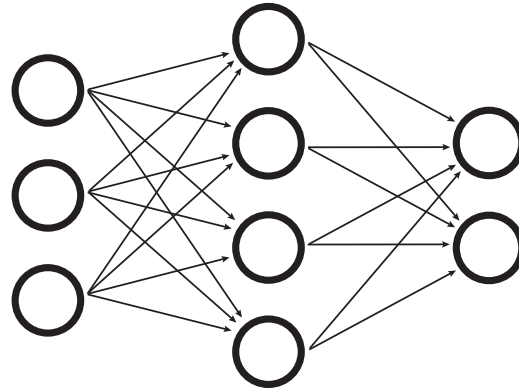

- Input nodes are exposed to input data. Each connection has a weight representing the strength of the connection.
- Each hidden node sums each input scaled by its weight. Each output node does the same applying weights.
- With each exposure to data the weights are adjusted either based on feedback from a training set or reoccurring input patterns (SOM or self-organizing map).
- In order to create nonlinear models the input summation commonly uses a sigmoid transfer function.

30

Inspired by biological neurology, but simplified by many orders of magnitude.

# Artificial Neural Networks

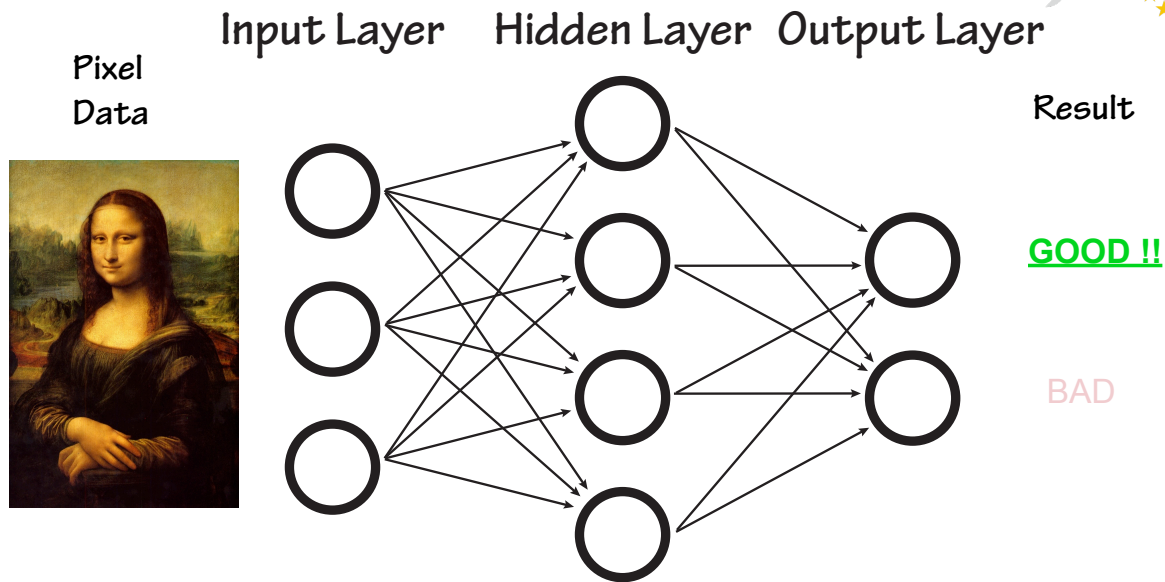

So what if we assign pixels to input nodes and output nodes to possible results?

**If only it was this easy!**

Millions of input nodes is computationally unworkable.

ANN use currently requires careful preprocessing & presentation of input data.

# Artificial Neural Networks

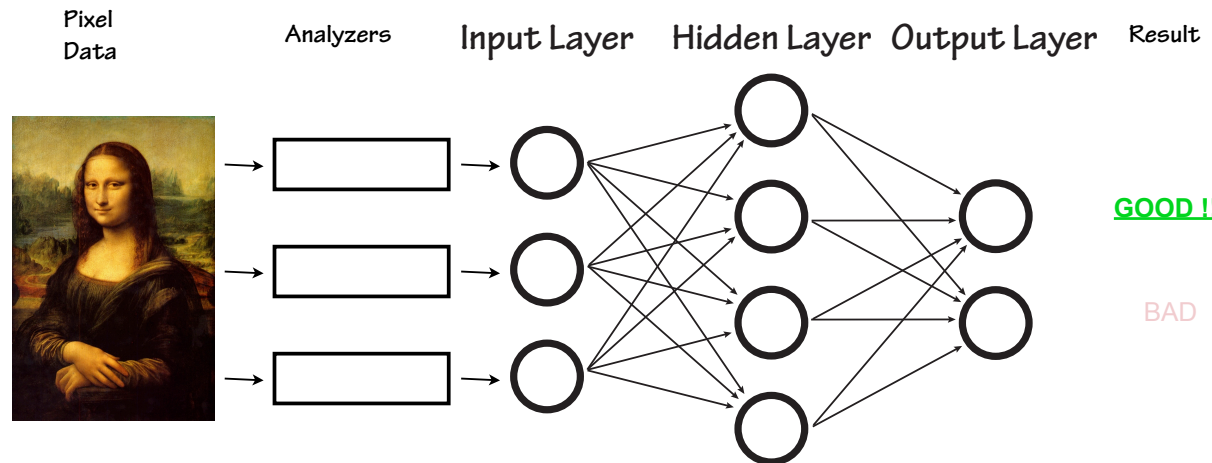

- One possibility is to process the pixel data with various analyzers, and then present the results to a neural network.
- This is potentially more robust to complex nonlinear relationships than statistical regression methods.

## Example - Photography Evaluation



- Datta et al. (2006, 2007)
- 3581 photos from a photography oriented social networking site.
- Each photo was rated by the membership.
- Image processing extracts 56 simple measures.
  - e.g. exposure, color distribution and saturation, adherence to the “rule of thirds,” size and aspect ratio, depth of field, etc.
- The ratings and extracted features were then processed using both regression analysis and classifier software.
- This resulted in a computational model using 15 key features.
- A software system was then able to classify photo quality as “high” and “low” in a way that correlated well with the human ratings.

There have been few attempts to apply standard design principles in CAE.

Datta, R., Joshi, D., Li, J., & Wang, J. Z. (2006). Studying aesthetics in photographic images using a computational approach. *Computer Vision - Eccv 2006, Pt 3, Proceedings*, 3953, 288-301.

- Among others Todd (1989) created sequential networks trained with scores, and then used to compose in a similar style.
  - Like similar attempts using higher-order Markov chains decades earlier, the system showed some short term coherence, but no real ability to create overall structure.
  - This is a generative system not really an aesthetic evaluation system. But it is an attempt to capture and model an aesthetic style

This is a generative system not really an aesthetic evaluation system. But it is an attempt to capture and model an aesthetic style.

Todd, P. M. (1989). A Connectionist Approach to Algorithmic Composition. *Computer Music Journal*, 13(4), 27-43.

Brooks, Hopkins, Neumann & Wright. "An experiment in musical composition." *IRE Transactions on Electronic Computers*, Vol. 6, No. 1 (1957).



- Phon-Amnuaisuk (2007) Used self-organizing maps to extract structure from existing music, and then act as a critic for an evolutionary composition system.
  - He found a lack of global structure and with Law (2008) created hierarchical SOMs for higher level abstraction. This approach shows some promise.

Self Organizing Maps clusters arbitrary data presented to the input layer without feedback.

Phon-Amnuaisuk, S. (2007). Evolving music generation with SOM-fitness genetic programming. Lecture Notes in Computer Science, 4448 LNCS, 557-566.

Law, E., & Phon-Amnuaisuk, S. (2008). Towards Music Fitness Evaluation with the Hierarchical SOM Applications of Evolutionary Computing (pp. 443-452): Springer.

- Gedeon (2008) created an experimental system that created “Mondrian-like” images and based on learning from a training set (of 1000!) was capable of predicting a single viewer’s preferences for new images.

This system was only demonstrated for a single person!

Gedeon, T. s. (2008). Neural network for modeling esthetic selection. Lecture Notes in Computer Science, 4985 LNCS(PART 2), 666-674.

# Evolutionary Systems



One of the most important generative art systems.

One where computational aesthetic evaluation is key

Fogel, L. J. (1999). Intelligence through simulated evolution : forty years of evolutionary programming. New York: Wiley.

# Evolutionary Systems

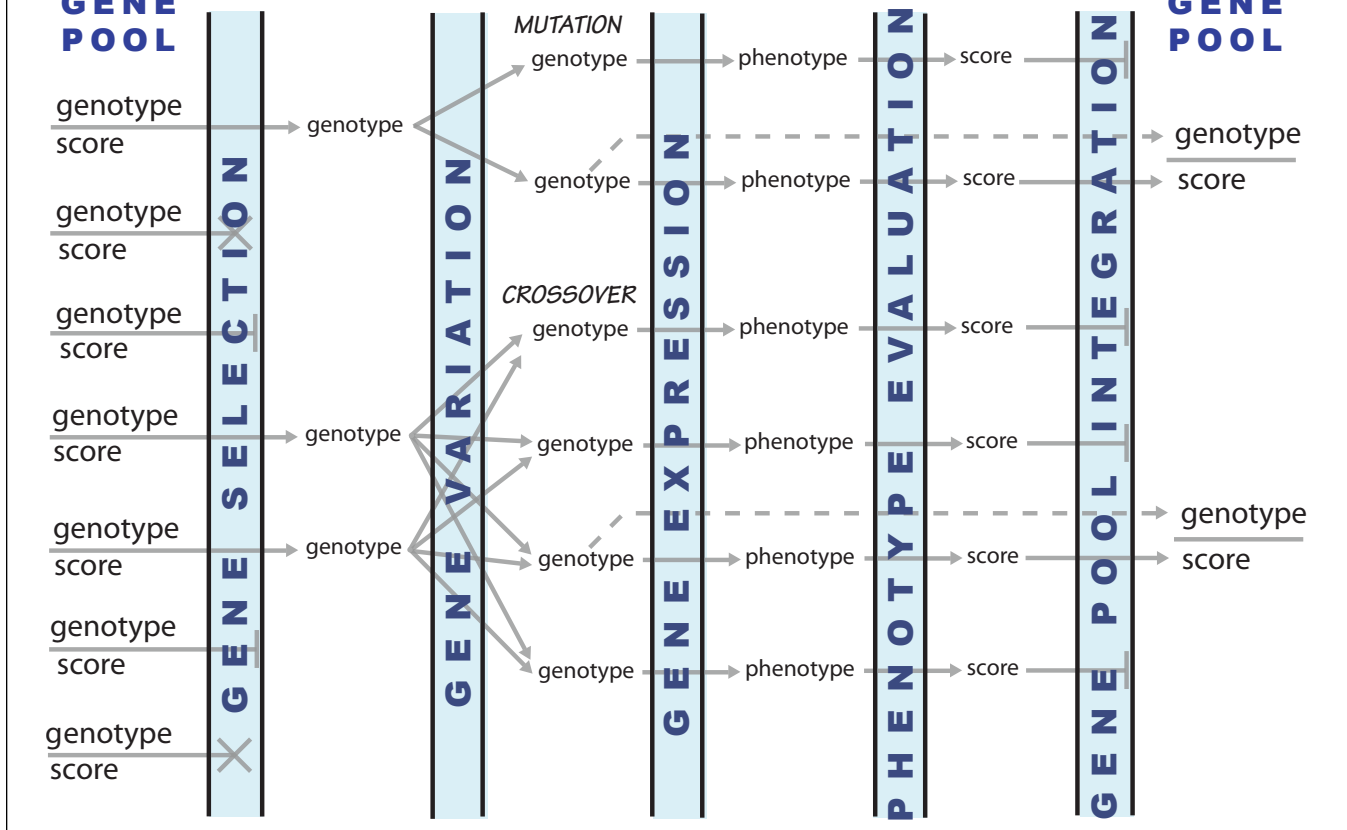

40

**Selection** - genotypes with better fitness scores are selected more often than others, and genotypes with low fitness scores may be removed from the gene pool.

**Variations** - a single genotype can be mutated, or two genotypes may be recombined.

**Expression** - use the genotype to create a corresponding phenotype.

**Evaluation** - use a fitness function to measure the phenotype competitiveness.

**Integration** - genotypes of sufficient quality are added to the gene pool.

# Evolutionary Systems

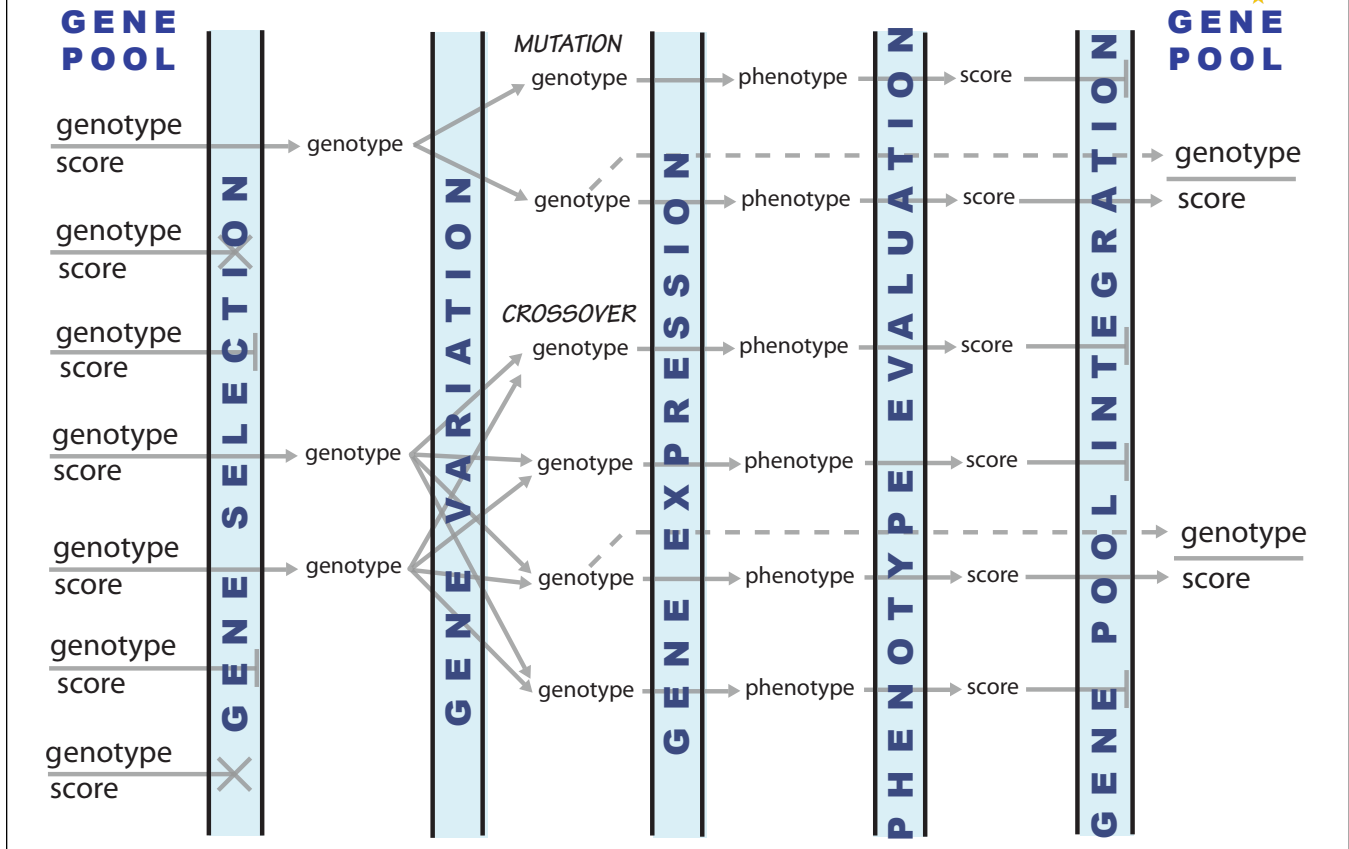

There are many variations:

Only mutation or only crossover, and variable rates high to low.

Select and/or remove genotypes on a statistical basis.

Protect genotypes with a score above a certain threshold.

Simulated annealing adjusting variation rate from high to low in later generations

Note that design of the genotype data structure requires creativity and innovation

There are many generative art systems:

- L-systems
- cellular automata
- reaction-diffusion systems
- artificial life
- diffusion limited aggregation
- randomization
- simulated chaos
- combinatorial construction
- data mapping
- tiling and symmetry
- fractals

These can be parameterized as a genotype. Evolutionary techniques can then be used to explore all of these generative systems and more.

Bentley, P. and Corne, D. (2002). An introduction to creative evolutionary systems, in P. Bentley and D. Corne (eds), *Creative Evolutionary Systems*, Morgan Kaufmann, Academic Press, San Francisco, CA, San Diego, CA, pp. 1 – 75.

# Evolutionary Art Systems



Typical applications have objective fitness functions:

- automotive and aeronautic design
- circuit design
- routing optimization
- modeling markets for investment
- computer aided molecular modeling
- encryption and code breaking
- chemical process optimization

But what kind of fitness function can measure aesthetic fitness? There are two approaches:

Interactive Evolutionary Computing (IEC)  
manual selection with small populations & few generations

Automated fitness function  
requires Computational Aesthetic Evaluation (CAE)

McCormack, J. (2005). Open problems in evolutionary music and art, APPLICATIONS OF EVOLUTIONARY COMPUTING, PROCEEDINGS 3449: 428–436.

Galanter, P. (2010). The problem with evolutionary art is..., in C. DiChio, A. Brabazon, et al (eds), Applications of Evolutionary Computation, Pt II, Proceedings, Vol. 6025 of Lecture Notes in Computer Science, Springer-Verlag Berlin, Berlin, pp. 321–330.

(see <http://philipgalanter.com> for a copy)

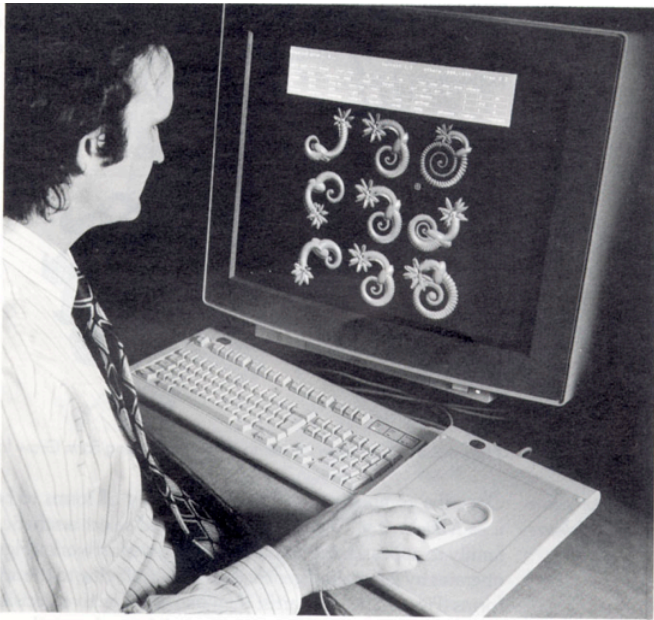

At each iteration the artist/operator selects phenotypes corresponding to recently mutated genotypes.

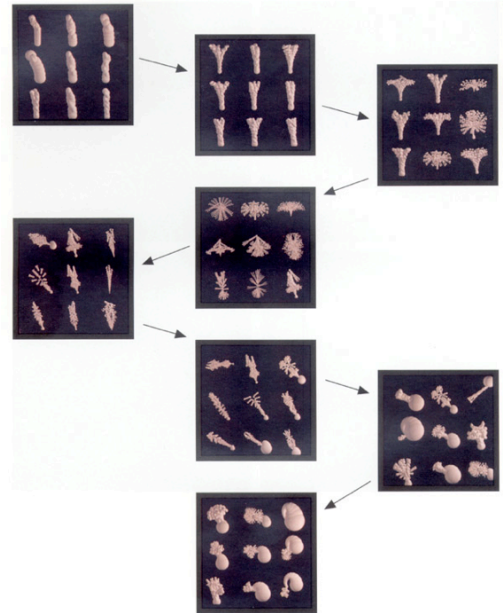

William Latham and Stephen Todd (1992) developed the Mutator system for evolving biomorphic forms.

45

Todd, S., & Latham, W. (1992). Evolutionary art and computers. London ; San Diego: Academic Press.

The artist/operator essentially navigates through a very large multi-dimensional solution space in search of a satisfying form. How could the evaluation of these images be automated?





Todd, S., & Latham, W. (1992). Evolutionary art and computers. London ; San Diego: Academic Press.

# IEC Example - Karl Sims



Karl Sims (1991) published a SIGGRAPH paper explaining his IEC system using evolving expressions.

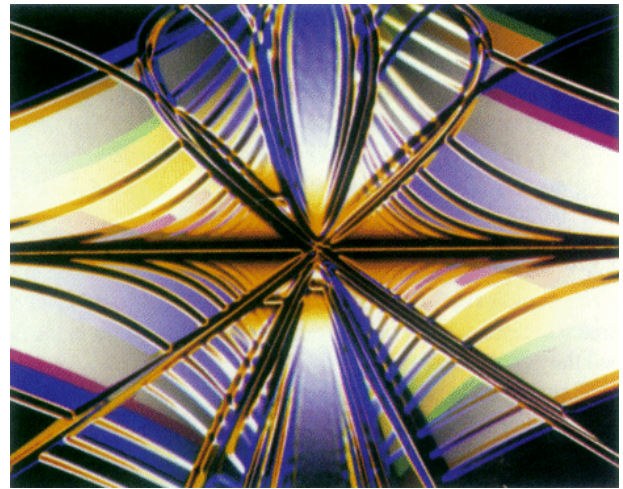

```
(round (log (+ y (color-grad  
(round (+ (abs (round (log (+  
y (color-grad (round (+ y (log  
(invert y) 15.5)) x) 3.1 1.86  
#(0.95 0.7 0.59) 1.35)) 0.19)  
x)) (log (invert y) 15.5)) x)  
3.1 1.9 #(0.95 0.7 0.35)  
1.35)) 0.19) x)
```

The phenotype is generated by plugging each pixel location X and Y into the expression. The expression is treated as a genotype by storing it as a parsed data structure that allows simple substitutions for mutations and crossover.

Again, how could the evaluation of these images be automated?

Sims, K. (1991). Artificial Evolution For Computer-Graphics. Siggraph 91 Conference Proceedings, 25, 319-328.

From the earliest efforts interactive assignment of fitness scores has dominated evolutionary art practice.

There was also early recognition that the human artist/operator creates what Todd and Werner (1998) called a “fitness bottleneck.” IEC systems typically allow only dozens of generations rather than hundreds or thousands, and are restricted to much smaller gene pools.

Todd, P. M., & Werner, G. M. (1998). Frankensteinian Methods for Evolutionary Music Composition. In N. Griffith & P. M. Todd (Eds.), *Musical networks: Parallel distributed perception and performance*. Cambridge, MA: MIT Press/Bradford Books.

# Crowd Sourced Evaluation



In Galapagos Karl Sims (1997) allows the audience to express a preference via sense pads where they stand.

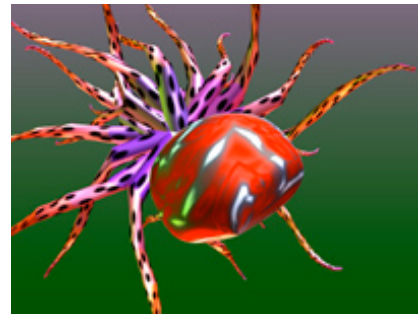

One can imagine now making this even more passive with video based crowd analysis and extracting viewing times.

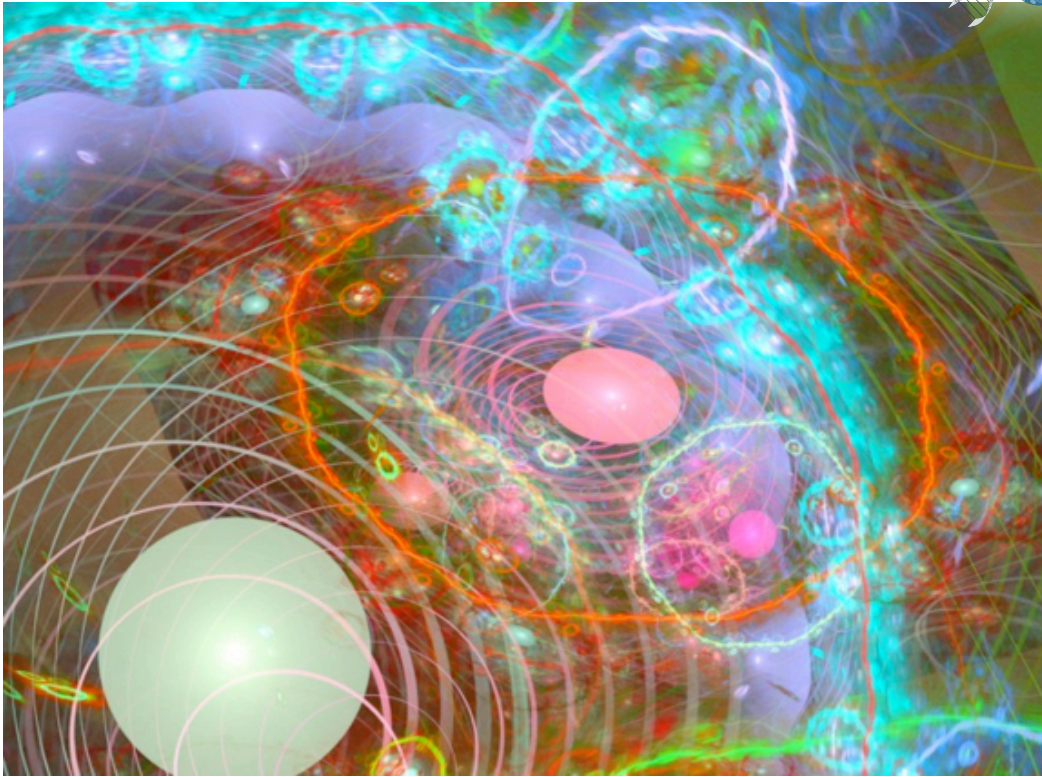

Scott Draves' (2005) Electric Sheep system allows his genetic screen saver users around the world to approve or disapprove of phenotypes via the Internet.

Draves, S. (2005). The electric sheep screen-saver: A case study in aesthetic evolution. *Applications of Evolutionary Computing, Proceedings*, 3449, 458-467.

# Crowd Sourced Evaluation



Komar and Melamid's "America's Most Wanted" (1997)



The People's Choice project polled the public about their preferences in paintings.

Based on the results regarding subject matter, color, and so on they created this painting.

Komar, V., Melamid, A., & Wypijewski, J. (1997). *Painting by numbers : Komar and Melamid's scientific guide to art* (1st ed.). New York: Farrar Straus Giroux.

# Crowd Sourced Evaluation

Komar and Melamid's "America's Most Wanted" (1997)

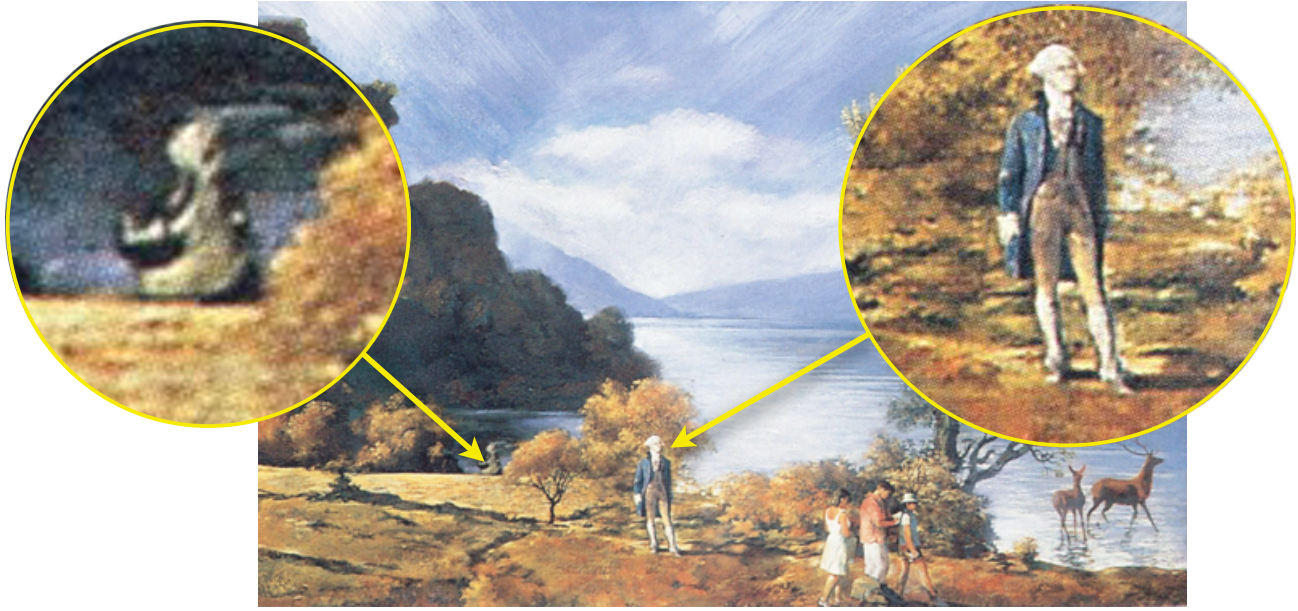

Corresponding to the public's like for historical figures and exotic animals they included these features. But also the popular blue lake, family, moderate vegetation, game animals.

Of course this isn't serious science. Komar and Melamid's critique was of the politics of public relations and institutions that wield statistics as a weapon. But clearly trending towards the mean is not a way to create the unique vision most expect of contemporary artists.

- Performance Goals
  - Form Follows Function
- Error Relative to Exemplars
- Complexity Measures
- Weighted Multi-Objective Fitness
- Pareto Optimality
- Emergent Aesthetics
  - Coevolution
  - Curious Agents
  - Agent Swarms
  - Niche Construction



# Performance Goals

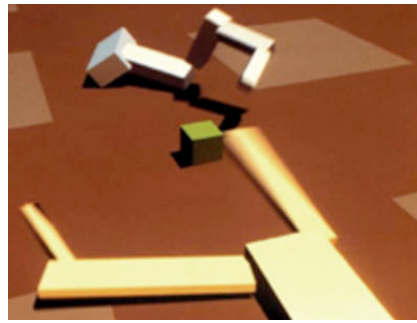
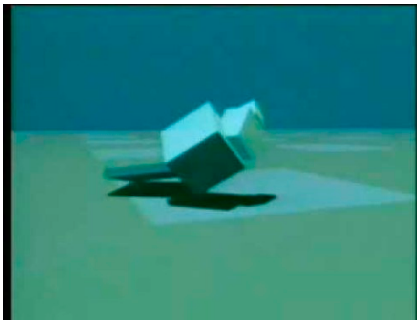

Karl Sims (1994) was able to evolve and animate virtual creatures based on performance goals.

The genotype describes a system of sensors, neurons, effectors, and .

A fitness function rewarding walking, jumping, swimming, and game playing is used.

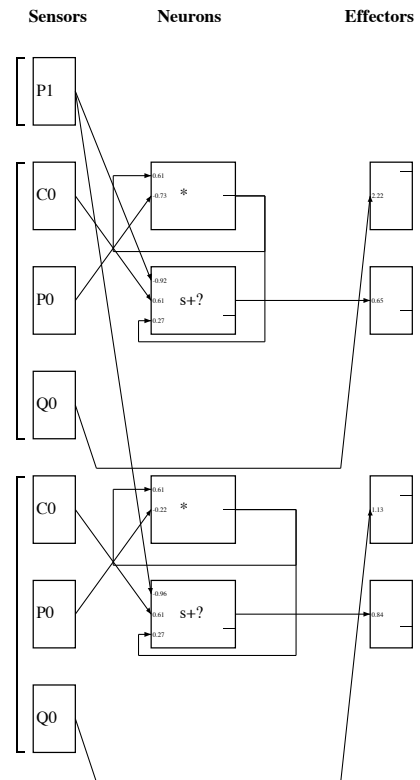

This postpones the question to some extent...what kind of performance yields high aesthetic quality?

Sims, K. (1994). Evolving Virtual Creatures. Siggraph '94 Proceedings, 28, 15-22.

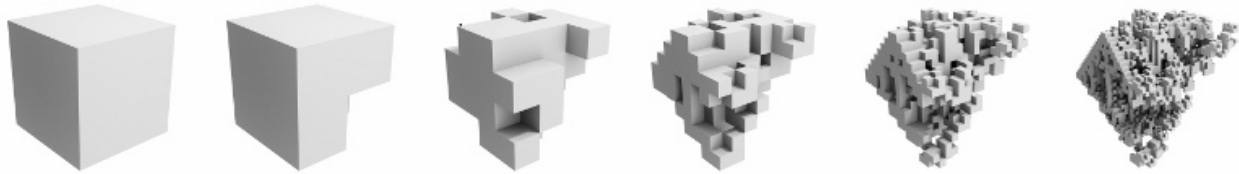

Driessens and Verstappen (2007) created an evolutionary subtractive sculpture system. Each sculpture is started as a single cube or cell. Cells are iteratively subdivided into 8 smaller sub-cells. The genotype is cellular automata-like rule sets determining whether or not a given subcell is removed. The fitness function is the number of pieces produced. The goal is a result yielding one large single piece.

A rather minimal aesthetic standard...an existential or size rule.

<http://notnot.home.xs4all.nl/breed/BREEDinfo.html>

# Performance Goals



The results are manufactured using various rapid prototyping or 3D printer technologies. Saying “the performance goal is ‘make it beautiful’” doesn’t really help.

- With the invention of photography pure representation became of diminishing importance in visual art.
- A difference or error measure comparing a phenotype to a real-world example is not typically useful as an aesthetic fitness function.
- However, intermediate results as an evolved image approaches an exemplar can be of interest as a kind of abstract art.

# Error Relative to Exemplars

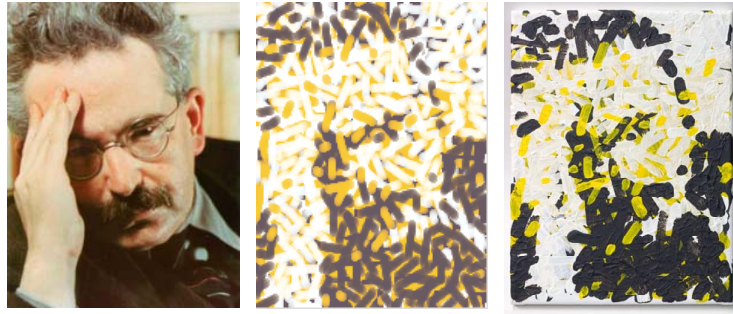

- Aguilar and Lipson (2008) constructed a physical painting machine driven by an evolutionary system.
- The fitness function compared simulated brush strokes against a photograph.

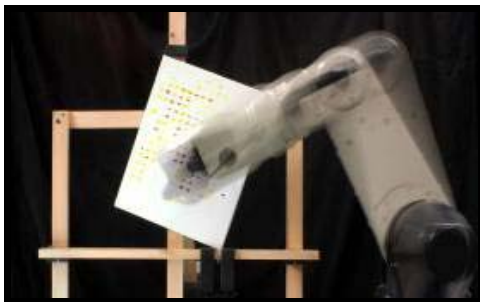

Once the error measure was sufficiently minimized the winning genes were then used to drive a robotic painting arm.

(pictured is Walter Benjamin author of “The Work of Art in the Age of Mechanical Reproduction”)

Aguilar, C., & Lipson, H. (2008). A robotic system for interpreting images into painted artwork. Paper presented at the International Conference on Generative Art.

# Error Relative to Exemplars

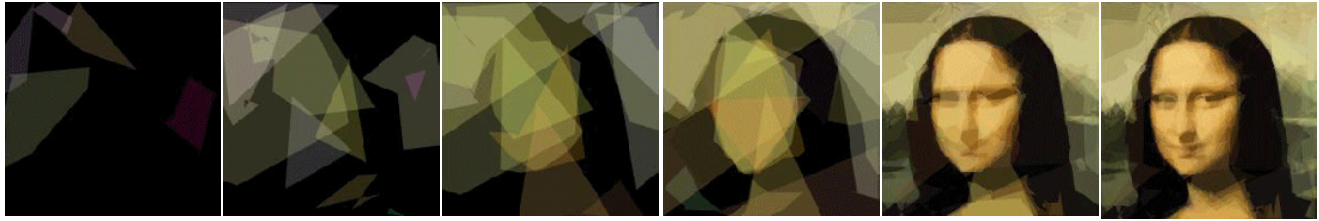

Alsing (2008) helped to popularize the error minimization approach to mimetic rendering with a project that evolved a version of the “Mona Lisa” using 50 overlapping semi-transparent polygons.

<http://rogersaling.com/2008/12/07/genetic-programming-evolution-of-mona-lisa/>.

# Error Relative to Exemplars



- The use of relative error can work well when programming music synthesizers to mimic other sounds.
- Comparisons with recordings of traditional acoustic instruments can be used as a fitness function.
- And while the evolutionary system converges on an optimal mimesis interesting timbres can be discovered along the way
- Magnus (2006) and Fornari (2007) independently recombining short sound files using an existent sound file as a target, but using evolving intermediate results.
- Hazan et al. (2006) used evolutionary methods to develop regression trees for expressive musical performance. Using jazz standards as a training set, the resulting regression trees could transform arbitrary flat performances into expressive ones.

McDermott, J., Griffith, N. J. L., & O'Neill, M. (2005). Toward User-Directed Evolution of Sound Synthesis Parameters. *Applications of Evolutionary Computing, Proceedings*, 3449, 517-526.

Mitchell, T. J., & Pipe, A. G. (2005). Convergence Synthesis of Dynamic Frequency Modulation Tones Using an Evolution Strategy *Applications on Evolutionary Computing* (pp. 533-538).

Magnus, C. (2006). Evolutionary Musique Concrète. In F. Rothlauf & J. Branke (Eds.), *Applications of Evolutionary Computing, EvoWorkshops 2006* (pp. 688-695). Berlin: Springer.

Fornari, J. (2007). Creating soundscapes using evolutionary spatial control. *Lecture Notes in Computer Science*, 4448 LNCS, 517-526.

Hazan, A., Ramirez, R., Maestre, E., Perez, A., & Pertusa, A. (2006). Modelling Expressive Performance: A Regression Tree Approach Based on Strongly Typed Genetic Programming *Applications of Evolutionary Computing* (pp. 676-687).

# Complexity Measures



Machado and Cardoso's (2002, 2003) NEvAr system uses computational evaluation methods with Sims-like evolving expressions. Their fitness function is related to Birkhoff's aesthetic measure:

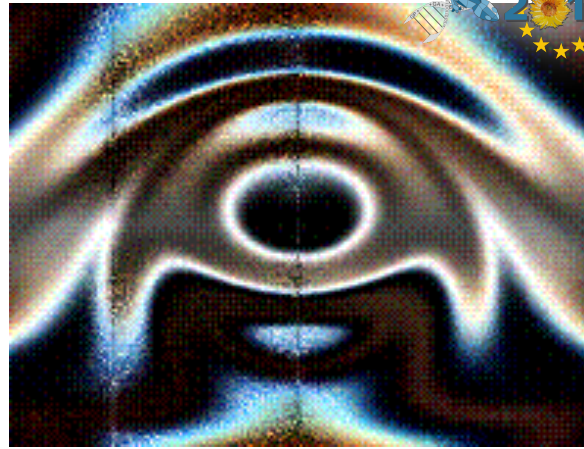

“...the aesthetic value is, to some extent, linked with the complexity of the image and with the mental work necessary to its perception.”

- Unity in Variety
- According to the authors “...pleasure experienced when finding a compact percept (i.e., internal representation) of a complex visual stimulus...”.

60

Machado, P., & Cardoso, A. (2002). All the Truth About NEvAr. [10.1023/A:1013662402341]. *Applied Intelligence*, 16(2), 101-118.

Machado, P., & Cardoso, A. I. (2003). NEvAr – System Overview. Paper presented at the International Conference on Generative Art.



# Complexity Measures



- Resistance to jpeg compression is a proxy for the “complexity of the visual stimulus” (CV).
- Resistance to fractal compression is a proxy for the “complexity of the percept” (CP), i.e. perceptual effort.

$$\text{aesthetic value} = \frac{CV^a}{(CP(t_1) \times CP(t_0))^b} \times \frac{1}{\left(\frac{CP(t_1) - CP(t_0)}{CP(t_1)}\right)^c}$$

“The left side of the formula rewards those images which have high CV and low CP estimates at the same time, while the right side rewards those images with a stable CP across time.”

Aesthetic Quality related to the ratio of visual stimulus complexity to percept complexity is a sophistication of degree of order / degree of complexity ratio of Birkhoff, especially when you recall Birkhoff’s underlying cognitive model.

# Multi-Objective Fitness



Aesthetic judgments are typically multidimensional. For example, evaluating a traditional painting might generate a set of scores regarding color, balance, value, and so on. A typical multi-objective fitness function might involve a weighted sum of factors.

$$Fitness = (w_0 * color) + (w_1 * balance) + (w_2 * value)$$

Can each score in the set be independently measured?

How are the weights determined?

Why assume there are no non-linear relationships?

Preservation in the gene pool of otherwise weak individuals with a particular strength in one aspect?

- Pareto Optimality is a method of comparing score sets without a weighted summation.
- Set A is said to **dominate** set B if
  - each score in A is at least as good as in B, and
  - at least one score in A is better than B
- A set of scores is said to be **rank 1** or **Pareto Optimal** if it isn't dominated by any other set.
- The sets of scores that are rank 1 constitute the **Pareto Set** or the **Pareto Front**.
- For crossover, selecting rank 1 genotypes or ignoring dominated genotypes can help to combine differing strengths of parents into a single individual.

Neufeld, C., Ross, B. J., & Ralph, W. (2008). The Evolution of Artistic Filters. In J. Romero & P. Machado (Eds.), *The art of artificial evolution : a handbook on evolutionary art and music* (pp. 335-356). Berlin: Springer.

Ross, B. J., & Zhu, H. (2004). Procedural texture evolution using multi-objective optimization. *New Generation Computing*, 22(3), 271-293.

Greenfeld, G. R. (2003). Evolving aesthetic images using multiobjective optimization. *Cec: 2003 Congress On Evolutionary Computation, Vols 1-4, Proceedings, 1903-1909*.

Dorin (2005)

“the ‘eco-systemic’ approach permits simultaneous, multidirectional and automatic exploration of a space of virtual agent traits without any need for a pre-specified fitness function. Instead, the fitness function is implicit in the design of the agents, their virtual environment, and its physics and chemistry.”

Dorin, A. (2005). Enriching Aesthetics with Artificial Life. In A. Adamatzky & M. Komosinski (Eds.), *Artificial life models in software* (pp. 415-431). London: Springer-Verlag.

- In evolution there is no absolute “correct answer.”
- An adaptation’s value is relative to its environment.
- Part of that environment is other living things.
- Coevolution is a sort of “arms race” of adaptation.
- But it can also be a process of ongoing symbiosis.

## Todd and Werner (1998)

- (Virtual) composers produce songs.
- Female critics judge the songs for mate selection based on a probability table of note transitions.
- Males are rewarded for surprising females.
- Transition tables coevolve and slowly vary with each new generation of females.

“One of the biggest problems with our coevolutionary approach is that, by removing the human influence from the critics (aside from those in the initial generation of folk-song derived transition tables), the system can rapidly evolve its own unconstrained aesthetics. After a few generations of coevolving songs and preferences, the female critics may be pleased only by musical sequences that the human user would find worthless.”

Coevolution here creates aesthetics effective in the virtual environment but unlistenable to human ears.

Todd, P. M., & Werner, G. M. (1998). Frankensteinian Methods for Evolutionary Music Composition. In N. Griffith & P. M. Todd (Eds.), *Musical networks: Parallel distributed perception and performance*. Cambridge, MA: MIT Press/Bradford Books.

## Saunders & Gero (2004)

- Reynolds established flocking via local behavior of agents.
- Helbing and Molnár developed the related social force model to simulate crowd behavior and compare with empirical results.
- Saunders and Gero add a new force they call “curiosity.” Agents move towards potentially interesting (novel) areas.

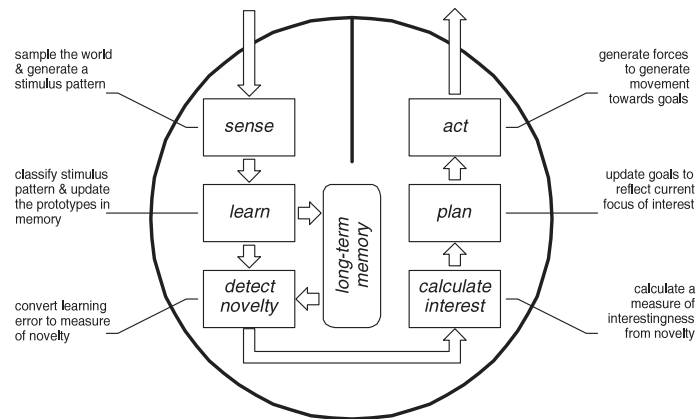
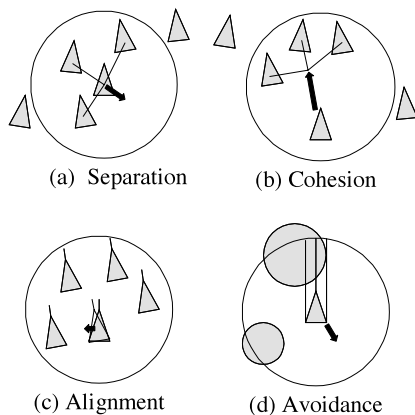

Saunders, R., & Gero, J. S. (2004). Curious agents and situated design evaluations. *Ai Edam-Artificial Intelligence for Engineering Design Analysis and Manufacturing*, 18(2), 153-161.

Reynolds, C. W. (1987). Flocks, herds, and schools: A distributed behavioural model. *Computer Graphics*, 21(4), 25–34.

Helbing, D., & Molnár, P. (1997). Self-organization phenomena in pedestrian crowds. In *Self-Organization of Complex Structures: From Individual to Collective Dynamics* Schweitzer, F., Ed., pp. 569–577. London: Gordon & Breach.

Saunders & Gero (2004)

## Curious agents in a gallery of monochrome paintings

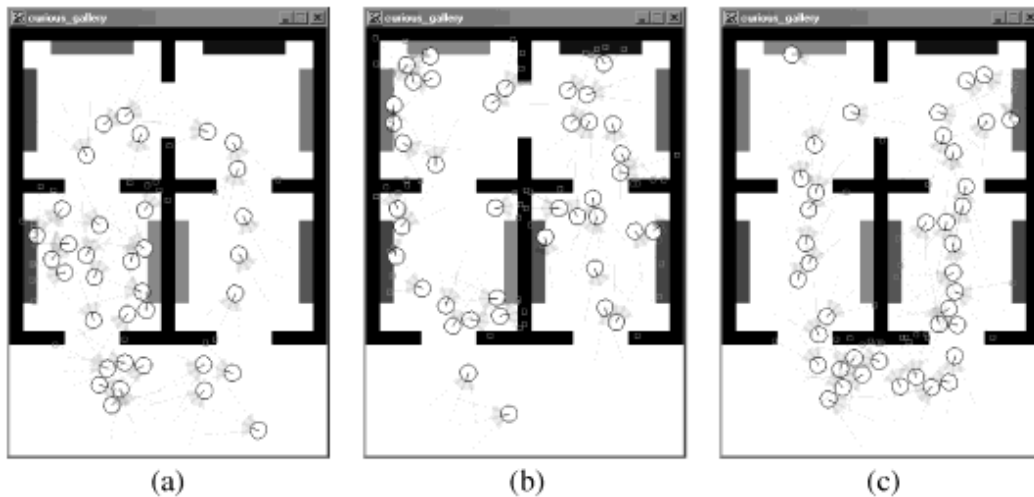

- (a) Poorly arranged gallery for single visit agents
- (b) Well arranged gallery for single visit agents
- (c) Well arranged gallery for multiple visit agents

(a) the paintings are not sequenced to present incremental novelty, so visitors bunch up in the first room (entering in the left door), and then leave quickly.

(b) the paintings are sequenced with novelty that is neither great nor small. The result is even traffic flow.

(c) after several visits the agents walk through the gallery rather quickly and efficiently.



## Urbano (2006)

- Various artists have applied fixed aesthetics using flocking agents (a la Reynolds) that lay down virtual paint.
- Urbano's "Gaugants" have one-to-one transactions.
- Each forms consent or dissidence regarding paint color.
- The dynamics are somewhat reminiscent of scenarios studied in game theory (e.g. the Prisoner's Dilemma).
- Although there is no overt evaluation there is an emergent aesthetic based on negotiations among the agents.

Urbano, P. (2006). Consensual paintings. Applications Of Evolutionary Computing, Proceedings, 3907, 622-632.

# Emergent Aesthetics - Agent Swarms

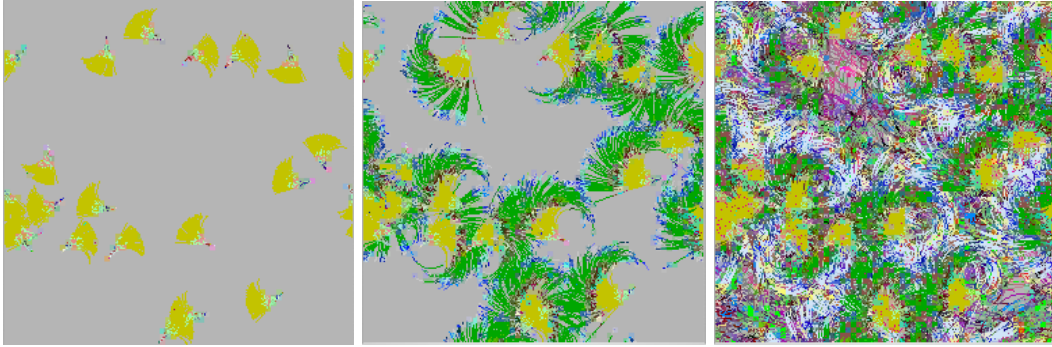

2000 agents mutating and globally negotiating color

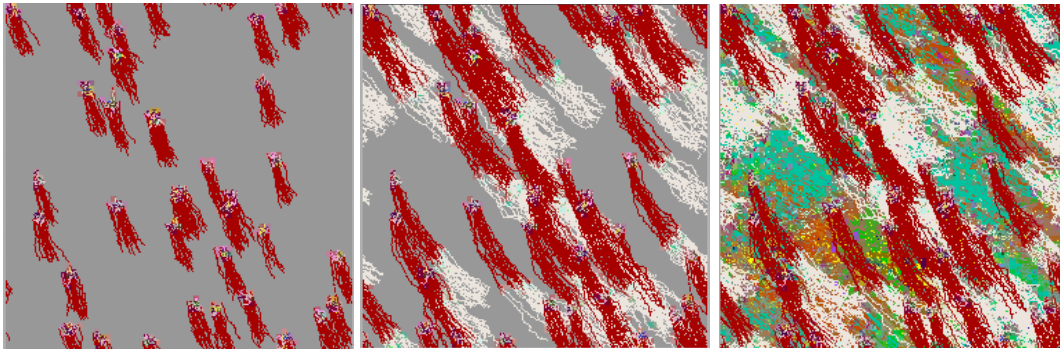

2000 agents globally negotiating color and direction

- Niche construction as agent / environment coevolution.
- Agents have a preferred environment.
- Agents can alter their environment to preference.
- As a more preferred environment is created those with the strongest preference are most encouraged.
- This creates a feedback loop creating an ever deepening evolutionary niche.

## McCormack and Bown (2009)

- Drawing agents move leaving marks and spawning offspring.
- They stop when they intersect already existing marks.
- They sense the local density of already existing marks.
- Each agent also has a genetic density preference.
- Initially agents that prefer low density will succeed.
- Agents will then encounter higher densities of marks.
- High density agents will draw more and reproduce.
- This reinforcing feedback deepens the niche and preference.

McCormack, J., & Bown, O. (2009). Life's What You Make: Niche Construction and Evolutionary Art. Paper presented at the Proceedings of the EvoWorkshops 2009 on Applications of Evolutionary Computing.

## McCormack and Bown (2009)

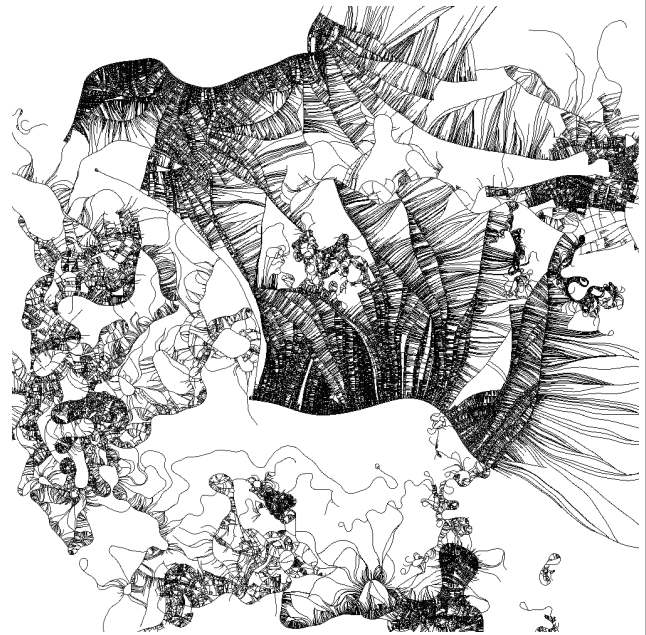
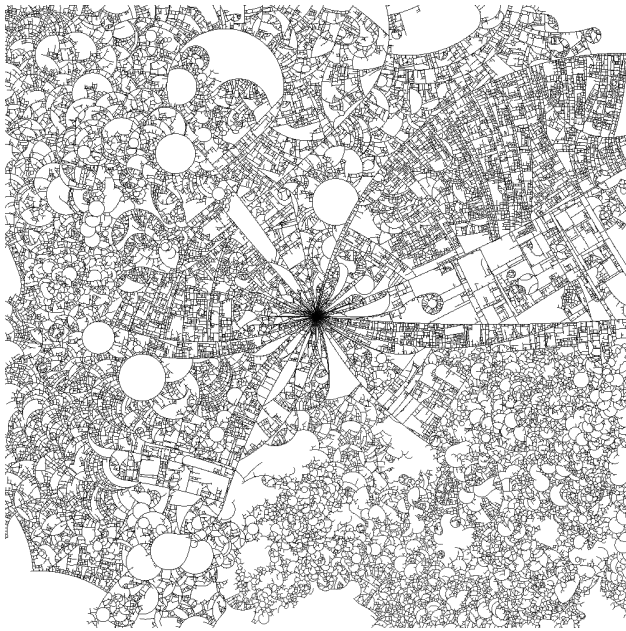

Drawing on the left (reminiscent of Jared Tarbell's work) is without niche construction, with niche construction on the right.

The aesthetics of the drawing develop over time as it is drawn.

### Galanter (2012)

Results to date lead to a conclusion regarding Type 2 computational aesthetic evaluation:

“If the goal is the creation of robust systems for meta-aesthetic exploration these evolutionary system extensions seem to be quite beneficial.

However, if the goal is to evolve results that appeal to our human sense of aesthetics there is no reason to think that will happen.”

70

Galanter, P. (2012). Computational Aesthetic Evaluation: Past and Future. In J. McCormack & M. d'Inverno (Eds.), *Computers and Creativity*. Berlin: Springer.

# Complexity-based Models of Aesthetics



# Complexity Measures



Bense (1965) and Moles (1966)  
Information Aesthetics after  
Shannon's Information Theory

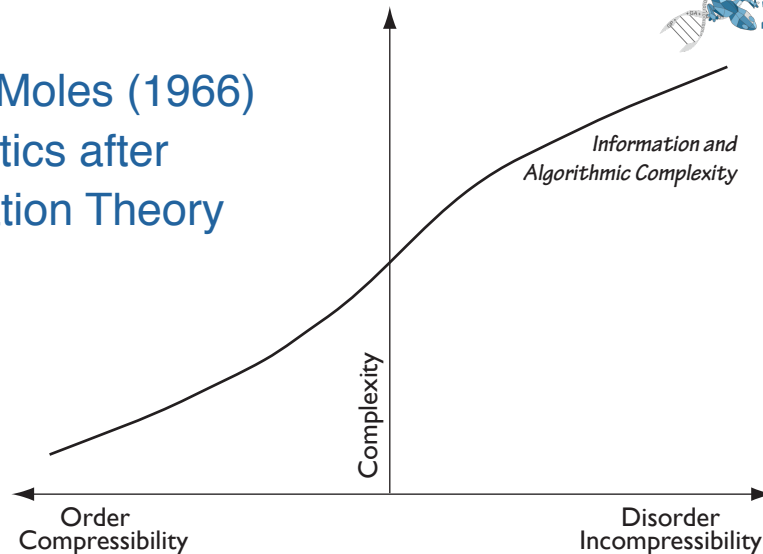

- Shannon's information theory describes the information capacity of a channel.
- The more disordered the signal, the less compressible it is, the more information it carries.
- Bense and Moles adapted these ideas in Information Aesthetics.

Shannon, C. E. (1948). A mathematical theory of communication. The Bell System Technical Journal, 27(3), 379--423.

Bense, M. (1965). Aesthetica; Einführung in die neue Aesthetik. Baden-Baden,,: Agis-Verlag.

Moles, A. A. (1966). Information theory and esthetic perception. Urbana,,: University of Illinois Press.



# Complexity Measures



Kolmogorov's (1965)  
Algorithmic Information Content  
adapted by Schmidhuber's  
(2012) Formal Theory of  
Creativity

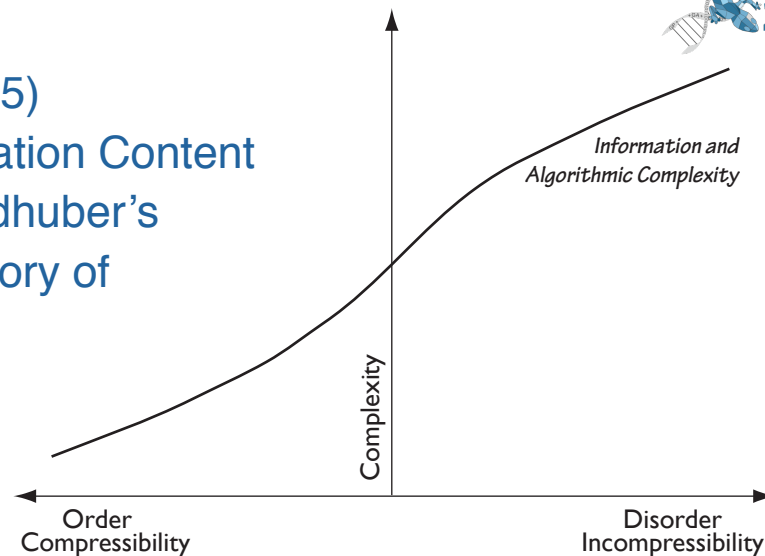

- Kolmogorov has a similar notion of algorithmic complexity. Again relative incompressibility (this time of the code used to implement the algorithm in question) is equated with complexity.
- This is adapted in Schmidhuber's Formal Theory of Creativity.

Schmidhuber, J. (2012 in press). A Formal Theory of Creativity to Model the Creation of Art. In J. McCormack & M. d'Inverno (Eds.), *Computers and Creativity*. Berlin: Springer.

Kolmogorov, A. N. (1965). Three approaches to the quantitative definition of information. *Problems in Information Transmission*, 1, 1-7.

# Complexity Measures



Gell-Mann and Lloyd's (1996) Effective Complexity offers a notion of complexity more consistent with our experience.

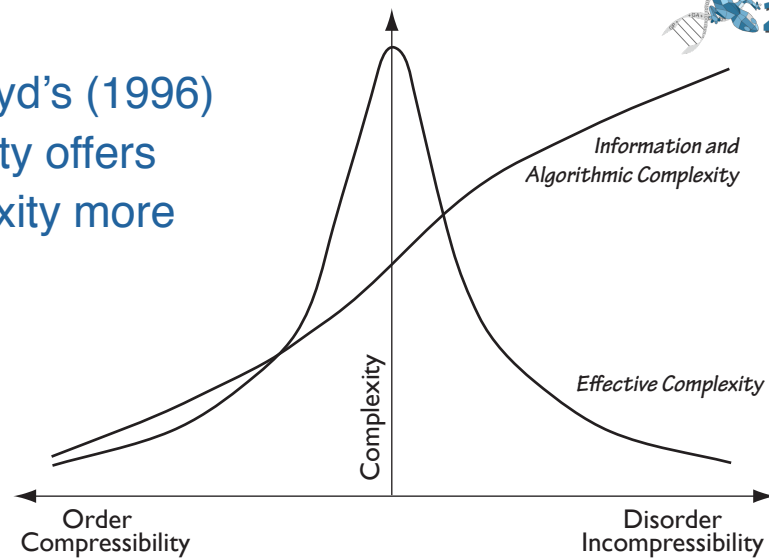

- According to Gell-Mann and Lloyd complexity is a balance of order and disorder.

Gell-Mann, M., & Lloyd, S. (1996). Information measures, effective complexity, and total information. *Complexity*, 2(1), 44-52.

# Complexity Measures

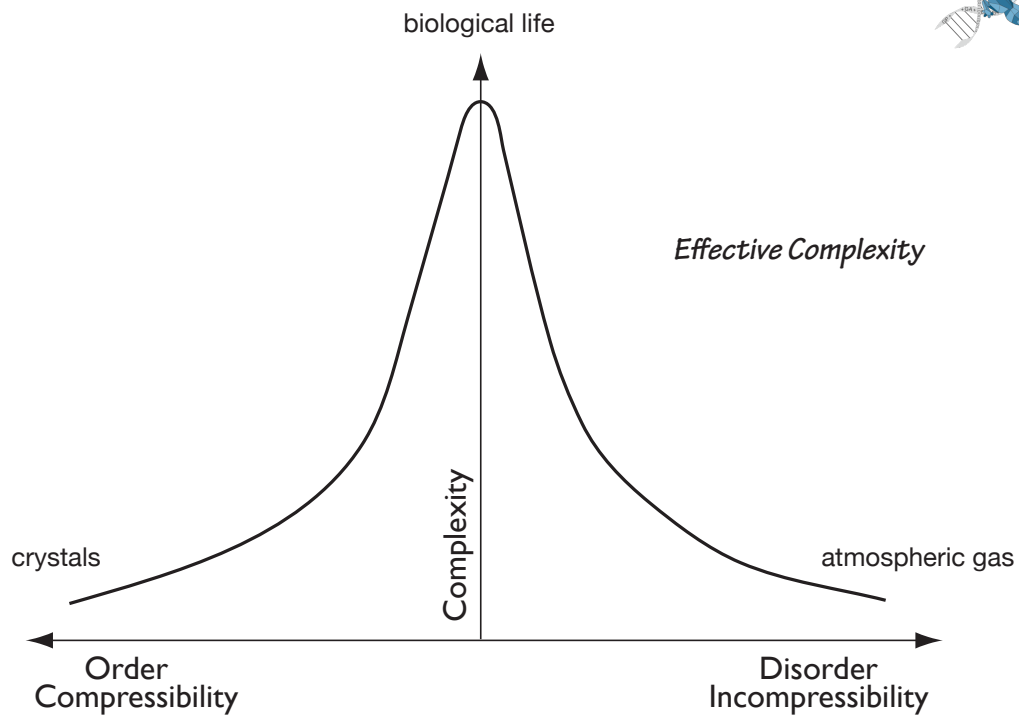

We find the balance of order and disorder in biological life more complex than either highly ordered or disordered systems.

Gell-Mann, M., & Lloyd, S. (1996). Information measures, effective complexity, and total information. *Complexity*, 2(1), 44-52.

# Complexity Measures

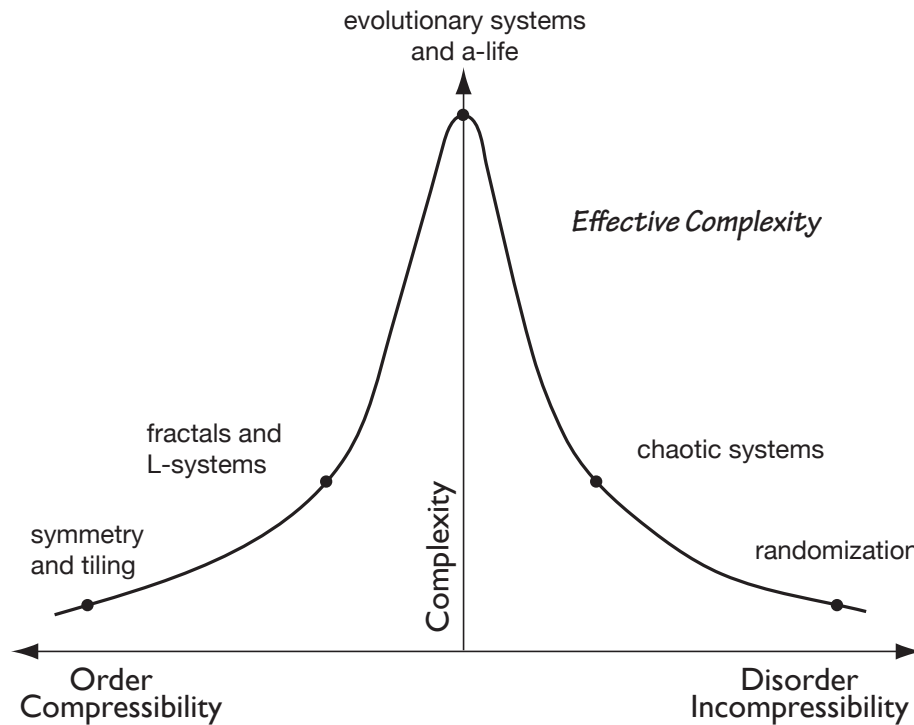

Effective complexity gives us a way to order our generative art systems, and it may be a more effective way to apply notions of complexity in aesthetic evaluation.

Galanter, P. (2003). What is Generative Art? Complexity theory as a context for art theory. Paper presented at the International Conference on Generative Art, Milan, Italy.

Galanter, P. (2012 in press). Computational Aesthetic Evaluation: Past and Future. In J. McCormack & M. d'Inverno (Eds.), *Computers and Creativity*. Berlin: Springer.  
(see <http://philipgalanter.com> for a copy)

# The Future of CAE

Psychological Models, Empirical Studies,  
and Neuroaesthetics



## Greenfield (2008)

“...it was difficult to find an evaluation scheme that made artistic sense. Much of the problem with the latter arises as a consequence of the fact that there is very little data available to suggest algorithms for evaluating aesthetic fitness. ...It would be desirable to have better cognitive science arguments for justifying measurements of aesthetic content.”

75

“Black box” techniques such as statistical methods and artificial neural networks have had limited success, but may not contribute understanding.

Greenfield, G. R. (2008). Co-evolutionary Methods in Evolutionary Art. In J. Romero & P. Machado (Eds.), *The Art Of Artificial Evolution* (pp. 357-380): Springer Berlin Heidelberg.

# Brain Complexity



- The human brain has about  $10^{15}$  connections.
- Individual neurons are informationally more complex than bits (analog, nonlinear summation, irregular synapses, etc.)
- Glial cells make up 90% of the brain and new studies suggest they actively participate in processing
- Digital circuits have a  $10^7$  advantage in switching speed, but that isn't enough to compensate.
- But much simpler brains exercise a kind of aesthetic judgement in mate selection.
- Watanabe (2009) demonstrated that pigeons could be trained to reliably categorize paintings made by children as “good” and “bad.”
- His prior studies (2001) had demonstrated that pigeons could learn to discriminate between artists, e.g. Monet vs. Picasso.

No wonder CAE is so difficult. Note the hardware nature requires for human aesthetics. Using operant conditioning pigeons were trained using a set of paintings categorized by adults. Note that pigeon neurology is heavily invested in visual processing.

Koob, A. (2009). The Root of Thought: What Do Glial Cells Do? Mind Matters Retrieved 11/29/09, 2009, from <http://www.scientificamerican.com/article.cfm?id=the-root-of-thought-what>

Watanabe , S. (2009). Pigeons can discriminate “good” and “bad” paintings by children. [10.1007/s10071-009-0246-8]. *Animal Cognition*, 13(1).

Watanabe S (2001) Van Gogh, Chagall and pigeons. *Animal Cognition* 4:147–151

# The Origins of Art and the Art Instinct





# The Art Instinct



- Stephen Jay Gould claimed that art is a “spandrel,” a nonadaptive side effect leveraging excess cognitive resources.
- Steven Pinker (1994) has put forward the theory there is a “language instinct”, and that it developed when fluency became a mate selection marker.
- Dutton (2009) speculates there is an “art instinct” that similarly developed when the creation of aesthetic objects became a mate selection marker.
- Such a behavior provides evidence of an excess of material means.

It is suggested that this is behind the practice of men bringing women flowers, jewelry, etc.  
\*Impractical\* gifts are the most romantic of all...and best evidence of material wealth.

Pinker, S. (1994). *The language instinct* (1st ed.). New York, NY: W. Morrow and Co.

Dutton, D. (2009). *The art instinct : beauty, pleasure, & human evolution* (1st U.S. ed.). New York: Bloomsbury Press.

# The Art Instinct



Note that art:

- often requires rare or expensive materials.
- requires time for learning and making.
- requires intelligence and creativity.
- typically has a lack of utility.
- sometimes has an ephemeral nature.

Dutton also speculates about the near universal preference for landscape pictures rich with survival cues from the African savannah:

- open green spaces with trees.
- ample bodies of water near by.
- an unimpeded view of the horizon.
- animal life.
- a diversity of flowering and fruiting plants.

Every culture has art, music, dance, story telling, etc.

That suggests, but doesn't prove, that there is some instinctual force behind it.

## Alexander Melamid

“...this blue landscape is more serious than we first believed...almost everyone you talk to...and we’ve already talked to hundreds of people...they have this blue landscape in their head...maybe the blue landscape is genetically imprinted in us, that it’s the paradise within, that we came from the blue landscape and we want it... China, Kenya, Iceland, and so on...the results are strikingly similar”

Remember, Melamid is one of the artists behind the “America’s most wanted” painting and project.

This isn’t hard science...but it sure is interesting...

# Psychological Models of Human Aesthetics



- Established Gestalt principles in aesthetics
- Perception is active cognition, not passive
- Law of Prägnanz - The brain orders experience into wholes that maximize clarity of structure
- Vague on the neurological specifics, but embraced the physical nature of his “forces and fields” in the brain

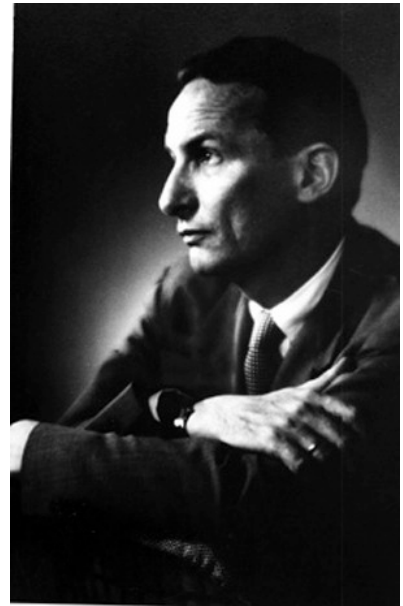

80

Arnheim, R. (1974). *Art and visual perception: a psychology of the creative eye* (New, expanded and revised ed.). Berkeley: University of California Press.

# Gestalt - Grouping

Creating sets of objects based on location, orientation, shape, etc.

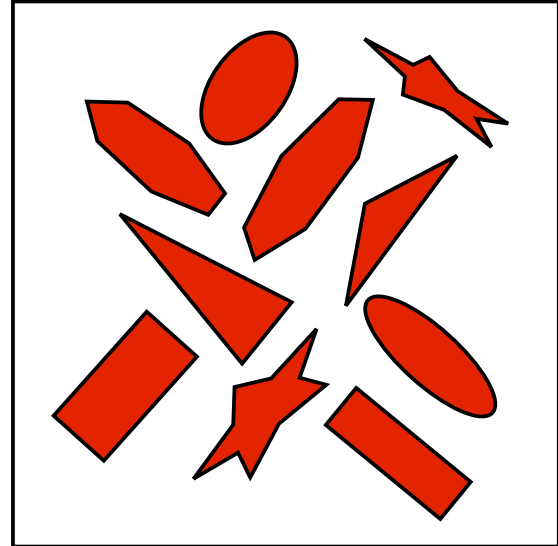
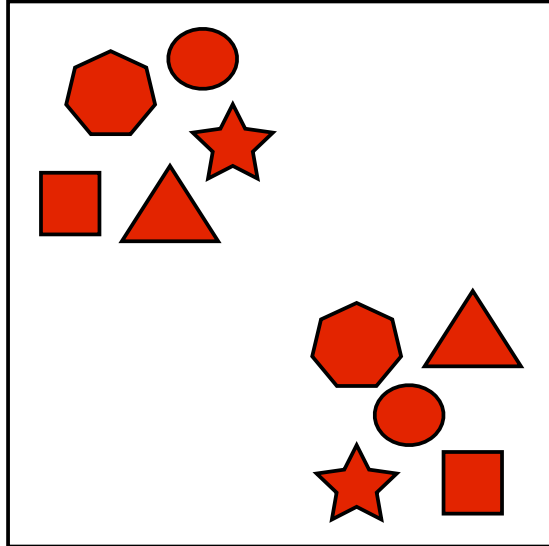

Various attributes can group objects.

# Gestalt - Grouping



Creating sets of objects based on location, orientation, shape, etc.

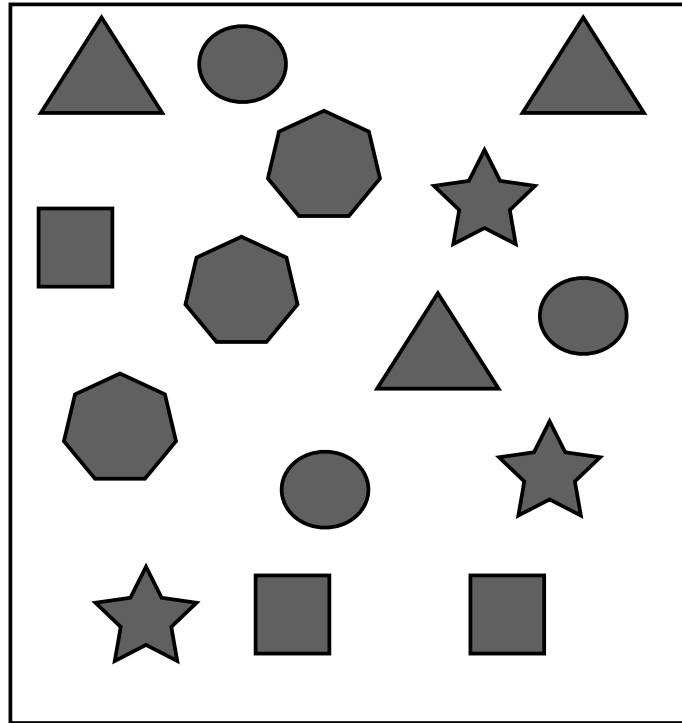

Without color the objects tend to group by shape.

# Gestalt - Grouping

Creating sets of objects based on location, orientation, shape, etc.

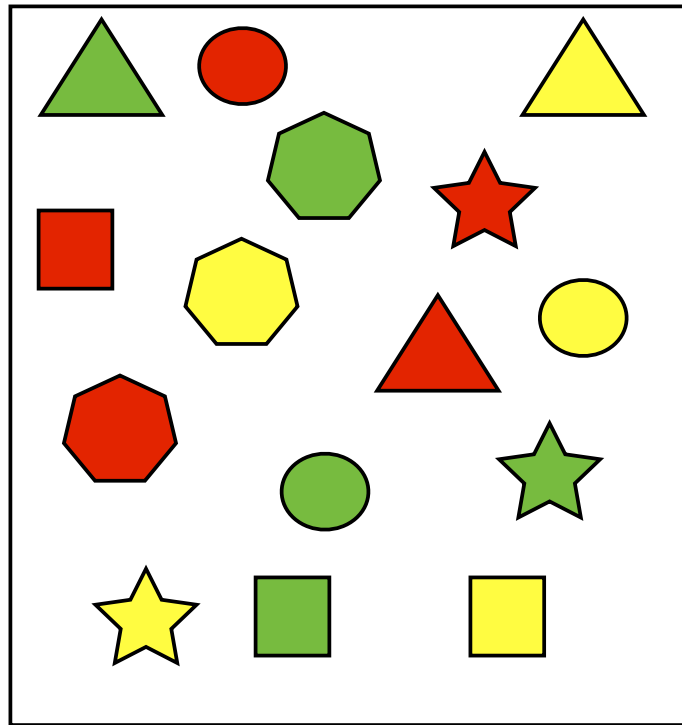

With color your attention can shift from color to color creating groups of objects.



Creating sets of objects based on borders

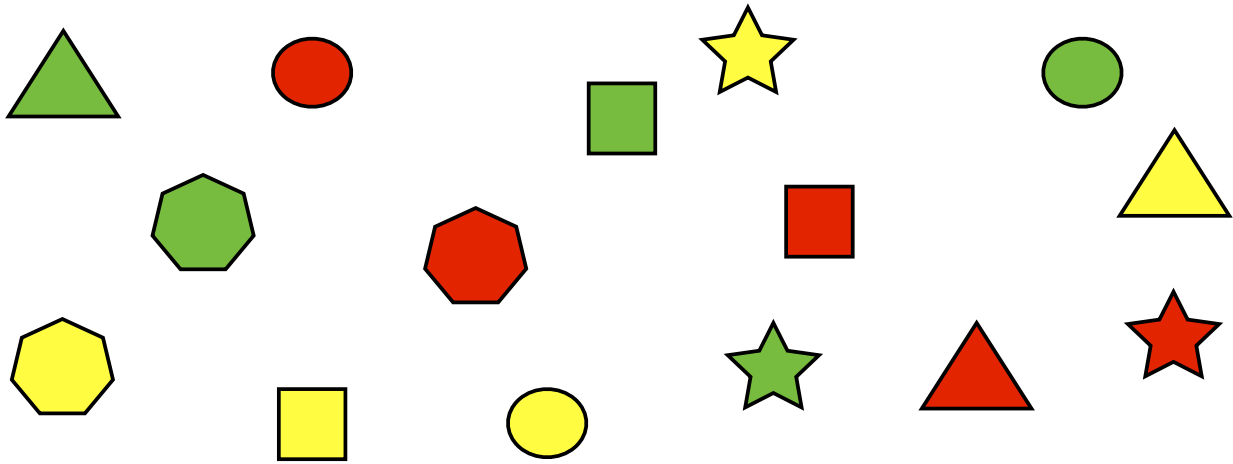

Here the objects group by color or not at all.

# Gestalt - Containment

Creating sets of objects based on borders

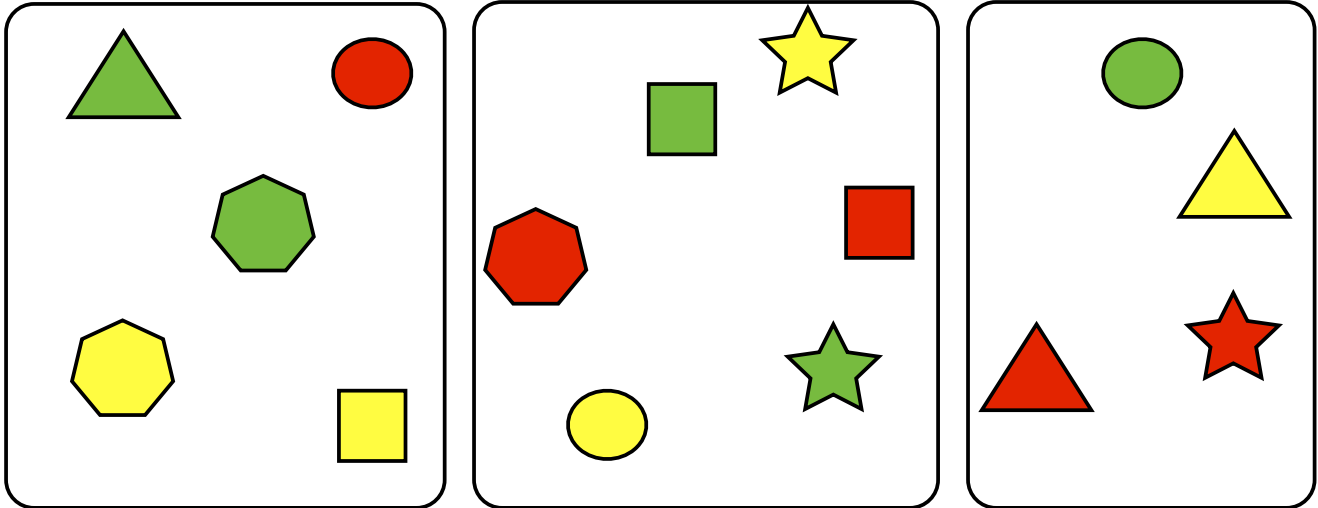

But borders decisively redefine the groups.

# Gestalt - Repetition



Creating sets of objects based on serial instantiation of a concept

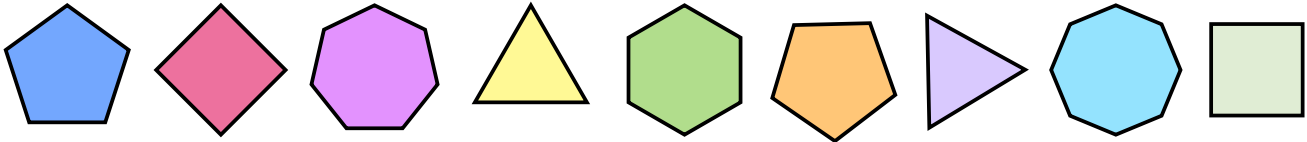

Note how alignment, spacing, color, and abstract notion of simple geometric shapes establish repetition.

# Gestalt - Proximity and Fusion



The red and blue ovals group together, the yellow circles fuse

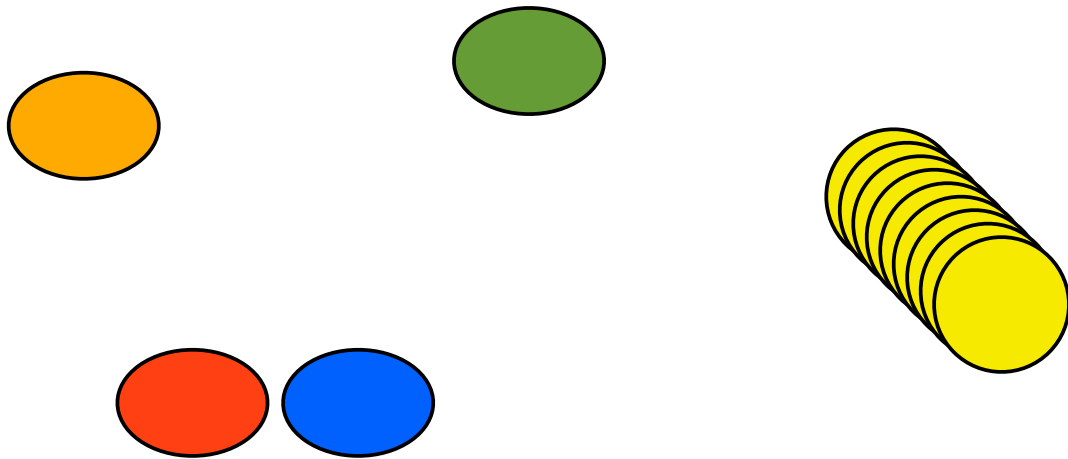

Proximity can group objects and overlap can fuse them.

The creation of apparent shapes despite missing information

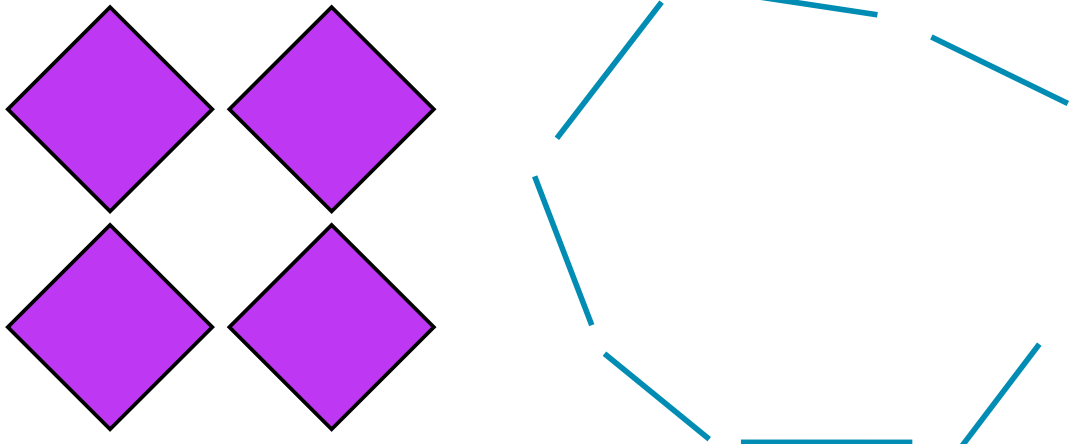

We tend to see shapes even if they are not entirely enclosed. Our cognitive perception “fills in” missing information.

Implied motion guides the eye and fuses objects

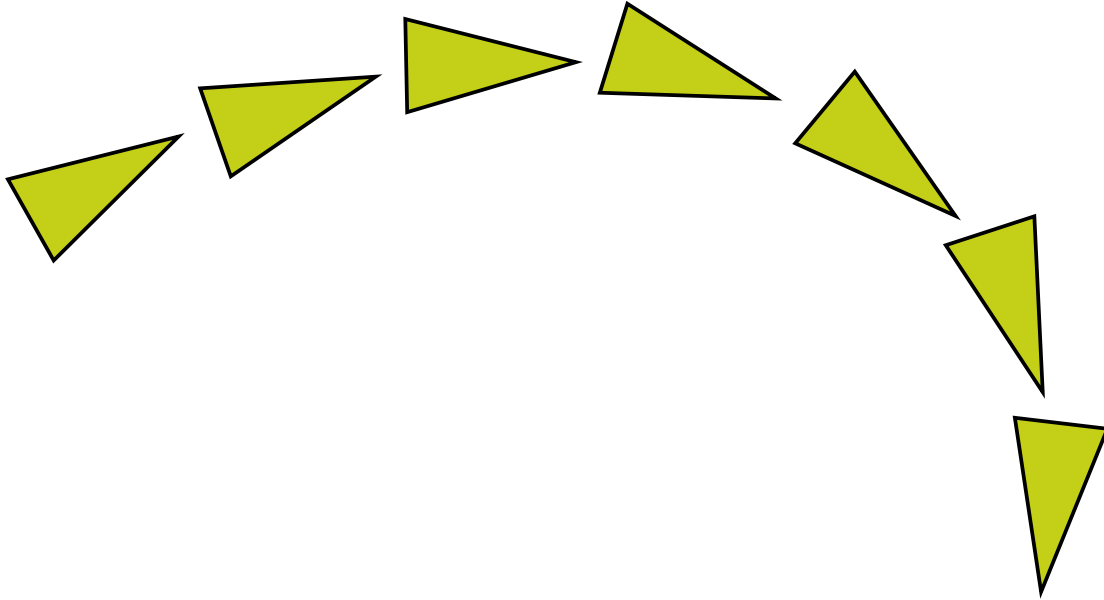

Our cognitive perception will also follow motion cues and unify otherwise separate objects. Arnheim showed us that perception is cognition.

# Daniel Berlyne “Arousal Potential”



- Arousal potential is the capacity a stimulus has to arouse the nervous system. Berlyne noted three types:
  - Psychophysical properties (e.g. loud sounds)
  - Ecological (e.g. pain or predator sightings)
  - Collative (e.g. surprise, complexity, ambiguity)



85

Berlyne was particularly interested in collative effects that bring together experiences in a comparative manner.

He noted explicitly the correspondence between collative effects and notions of surprise and novelty in information theory.

Berlyne, D. E. (1960). Conflict, arousal, and curiosity. New York,: McGraw-Hill.

Berlyne, D. E. (1971). Aesthetics and psychobiology. New York,: Appleton-Century-Crofts.

# Daniel Berlyne "Arousal Potential"

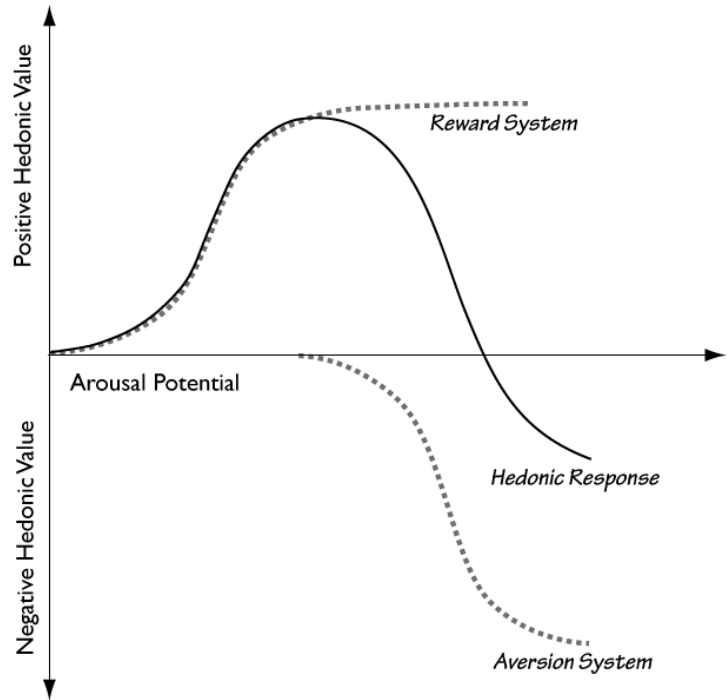
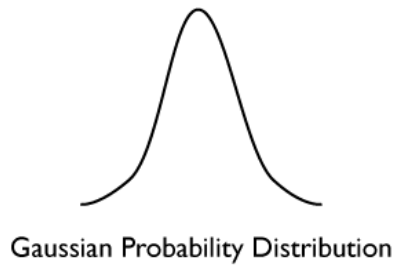

Neurological activation of the reward and aversion systems combine to produce a positive or negative hedonic response.



# Daniel Berlyne "Arousal Potential"

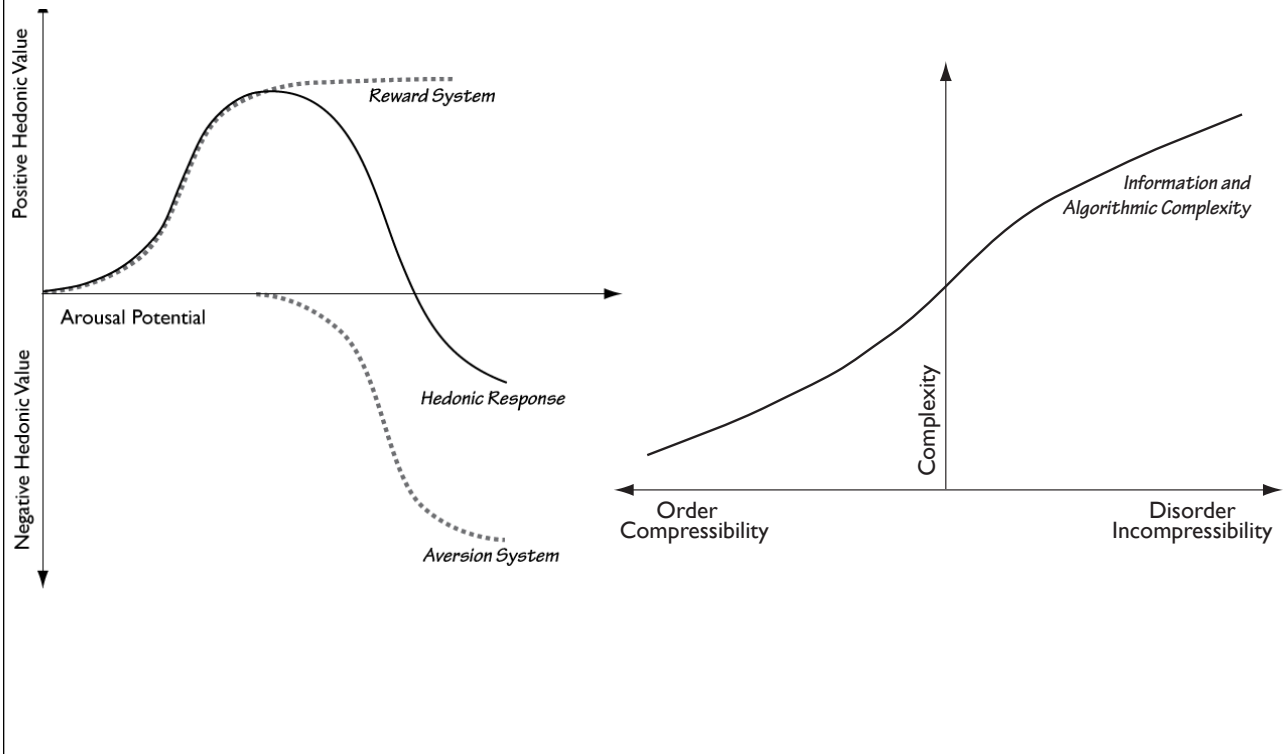

Despite his interest in information theory and related notions of complexity, his proposed hedonic response to arousal potential is not proportional to the amount of information carried. Put another way, Berlyne's notion of complexity is not proportional to positive aesthetic response.

# Daniel Berlyne “Arousal Potential”

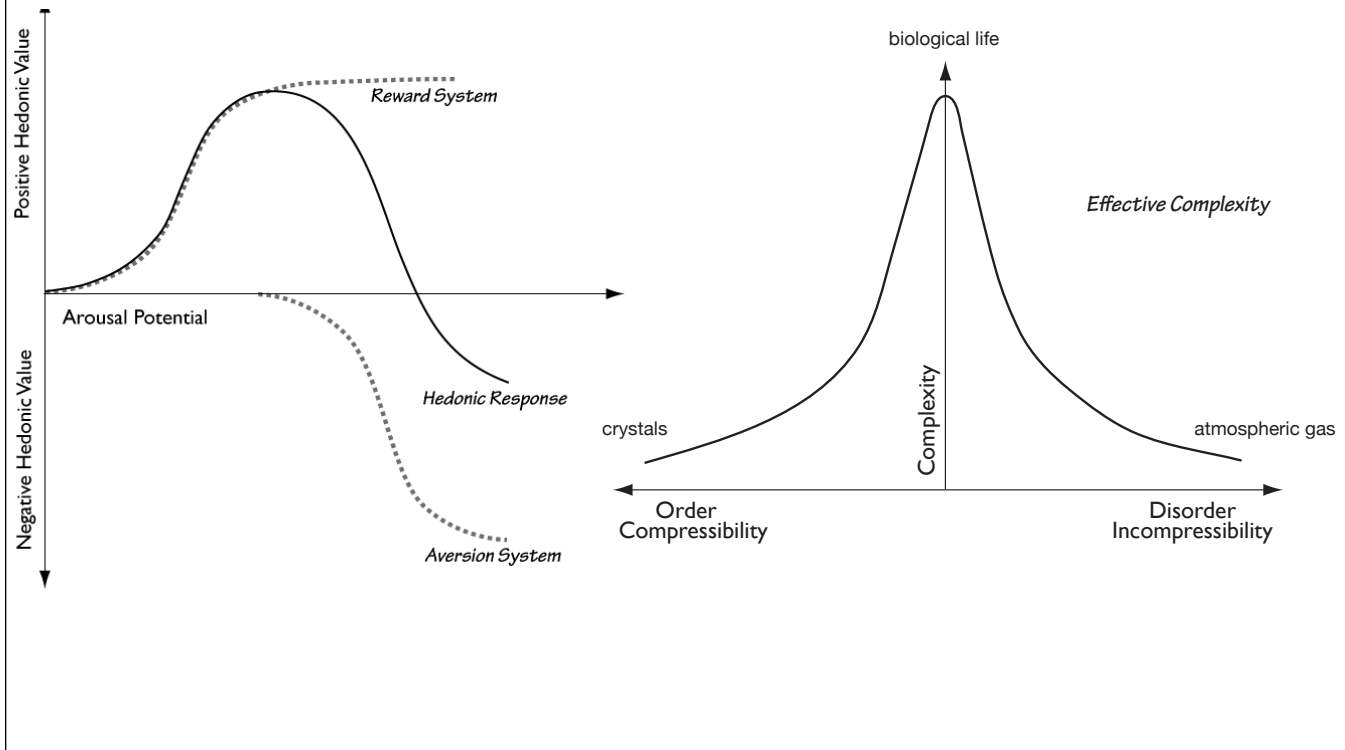

Effective complexity is roughly proportional to Berlyne’s hedonic response curve. Might this be a clue that our aesthetic response is tuned to effective complexity? In other words tuned to the complexity of the biological world?

Galanter, P. (2012). Computational Aesthetic Evaluation: Past and Future. In J. McCormack & M. d’Inverno (Eds.), *Computers and Creativity*. Berlin: Springer.

Galanter, P. (2010). Complexity, Neuroaesthetics, and Computational Aesthetic Evaluation. Paper presented at the International Conference on Generative Art, Milan, Italy.

## Colin Martindale “Prototypicality”



- Conducted a series of confirmatory experiments that, in fact, produced data contradicting Berlyne’s model.
- Developed a neural network theory that better predicted and explained the experimental data.
- Tends to speak about aesthetic preferences more than aesthetic pleasure.



90

Martindale, C., Moore, K. and Borkum, J. (1990). Aesthetic preference: Anomalous findings for berlyne’s psychobiological theory, *The American Journal of Psychology* 103(1): 53–80.

Martindale, C. (1991). *Cognitive psychology : a neural-network approach*, Brooks/Cole Publishing Company, Pacific Grove, California.

Martindale, C. (2007). A neural-network theory of beauty, in C. Martindale, P. Locher and V. Petrov (eds), *Evolutionary and neurocognitive approaches to aesthetics, creativity, and the arts*, Bay- wood, Amityville, N.Y., pp. 181–194.

# Colin Martindale “Prototypicality”



- The nervous system is arranged hierarchically.
- Low level neural processing tends to be ignored.
- Higher levels of cognition, deeper semantic nodes, dominate.
- Nodes are excitatory upward and inhibitory laterally.
- So similar nodes are physically closer than others.
- This creates semantic fields that exhibit prototypicality.

The nervous system is more strongly activated when presented with a stimulus that is typical of its class.

According to Martindale’s model regarding aesthetic preference...

## Problems with prototypicality:

- It doesn't seem to fully address our attraction to novelty. (Meaning novelty other than incremental peak-shift phenomena).
- More generally it seems to ignore the careful balance of order and disorder, of expectation and surprise, in the arts.
- The linkage to aesthetic pleasure seems tenuous.

See Martindale's "the clockwork muse" for a more developed theory of stylistic change in the arts.

Martindale, C. (1990). *The clockwork muse : the predictability of artistic change*. New York, N.Y.: BasicBooks.

# Empirical Studies of Human Aesthetics



Ernest Rutherford (likely paraphrased):

“In science there is only physics.  
Everything else is stamp collecting.”

In the past couple of decades activity in the area of empirical studies of human aesthetics has been on the increase.

Such studies are difficult because of the complexity of human perception and cognition, the challenges in using human subjects, the limited sample sizes, the need to control all manner of experiential and context variables, etc.

And then taking these highly individual results and trying to find a unifying theory or model is even more difficult.

But the individual “stamps” collected are intriguing nevertheless.

- Subjects first asked to think about the distant future are more likely to accept unconventional works as art than those who first think about their near future.
- The same music will be evaluated more positively if preceded by bad music, and less positively if preceded by good music.
- The presence or lack of title labels has no effect on the aesthetic evaluation of paintings. Similarly the amount of viewing time has no effect.

### 95

Schimmel, K. and J. Forster, How temporal distance changes novices' attitudes towards unconventional arts. *Psychology of Aesthetics, Creativity, and the Arts*, 2008. 2(1): p. 53-60.

Parker, S., et al., Positive and negative hedonic contrast with musical stimuli. *Psychology of Aesthetics, Creativity, and the Arts*, 2008. 2(3): p. 171-174.

Smith, L.F., et al., Effects Of Time And Information On Perception Of Art\*. *Empirical Studies of the Arts*, 2006. 24(2): p. 229-242.



## Studies of Viewers and Emotions



- Not all emotions lend themselves to musical expression. Those that do tend to be general, mood based, and don't require causal understanding.
- Subjects with high scores when evaluated for right-wing authoritarianism are more likely to be angered and disgusted by controversial art photography.
- The most genuine musically induced emotions are thrills, a sense of being moved, and especially aesthetic awe.

Collier , G.L., Why Does Music Express Only Some Emotions? A Test Of A Philosophical Theory. *Empirical Studies of the Arts*, 2002. 20(1): p. 21-31.

Cooper, J.M. and P.J. Silvia Opposing Art: Rejection As An Action Tendency Of Hostile Aesthetic Emotions. *Empirical Studies of the Arts*, 2009. 27(1): p. 109-126.

Koneni, V.J., Does music induce emotion? A theoretical and methodological analysis. *Psychology of Aesthetics, Creativity, and the Arts*, 2008. 2(2): p. 115-129.

- It was concluded that descriptive symmetry judgment and evaluative aesthetic judgment processes differ dramatically and recruit, at least in part, different neural machinery.
- The right visual field preference was found to apply only to abstract art.
- A model where the perceived color of an area is influenced by the surrounding colors is proposed. It is based on double opponent cells responding preferentially to one of the opponent colors, blue, yellow, red, and green.

Jacobsen , T., & Höfel, L. (2001). Aesthetics Electrified: An Analysis Of Descriptive Symmetry And Evaluative Aesthetic Judgment Processes Using Event-Related Brain Potentials. *Empirical Studies of the Arts*, 19(2), 14.

Coney , J. and C. Bruce Hemispheric Processes In The Perception Of Art. *Empirical Studies of the Arts*, 2004. 22(2): p. 181-200.

Katz, B.F., Color Contrast And Color Preference. *Empirical Studies of the Arts*, 1999. 17(1): p. 1-24.

- Open participants prefer more forms of art. This difference increases as the art became more abstract. Those with attitudes more tolerant of political liberalism and drug use prefer abstract art the most.
- Altruists reject aggressive images, and there is attraction for such images in aggressive types. The latter, however, have a greater liking for incongruous images that more indirectly and symbolically correspond to destructive drives.

Feist , G.J. and T.R. Brady Openness To Experience, Non-Conformity, And The Preference For Abstract Art. *Empirical Studies of the Arts*, 2004. 22(1): p. 77-89.

Giannini, A.M. and P. Bonaiuto, Special Image Contents, Personality Features, And Aesthetic Preferences. *Empirical Studies of the Arts*, 2003. 21(2): p. 143-154.

- Artists and non-artists were presented with 22 work-in-process images leading to Matisse's 1935 painting Large Reclining Nude. Non-artists judged the painting as getting worse over time with increasing abstraction. Art students showed a jagged trajectory with several peaks suggesting an interactive hypothesis-testing process
- Balance influences the way adults trained in the visual arts create visual displays.
- Image making is consistent with personality test results.

Kozbelt, A., Dynamic Evaluation Of Matisse's 1935 Large Reclining Nude. *Empirical Studies of the Arts*, 2006. 24(2): p. 119-137.

Locher, P., et al., Artists' Use Of Compositional Balance For Creating Visual Displays. *Empirical Studies of the Arts*, 2001. 19(2): p. 213-227.

Machotka, P., Artistic Styles And Personalities: A Close View And A More Distant View. *Empirical Studies of the Arts*, 2006. 24(1): p. 71-80.

- The selection of a color palette, and the spatial control of color within a composition, results in the colorimetric barycenter of a painting being close to the geometric center in both representational and abstract paintings.
- Stimuli like horizontal and vertical lines, which are preferentially processed by the visual system, are also aesthetically more powerful.
- Removing color from portraits increased pleasantness and beauty and reduced tension. Removing color from landscapes reduced their perceived beauty.

Firstov, V., et al., The Colorimetric Barycenter Of Paintings. *Empirical Studies of the Arts*, 2007. 25(2): p. 209-217.

Latto, R. and K. Russell-Duff, An Oblique Effect In The Selection Of Line Orientation By Twentieth Century Painters. *Empirical Studies of the Arts*, 2002. 20(1): p. 49-60.

Polzella, D.J., S.H. Hammar, and C.W. Hinkle, The Effect Of Color On Viewers' Ratings Of Paintings. *Empirical Studies of the Arts*, 2005. 23(2): p. 153-163.

- In film awards winning best song has no relation to film success, but winning best score is positively associated with the film success as measured by best-picture nominations and awards.
- There is some support for the idea that meaning attributed to single musical intervals may be a universal human trait. Specifically, Norwegian participants reported emotions that were remarkably consistent with the emotions reported for the very different musical tradition of medieval classical Indian raga music.

Simonton, D.K., Film music: Are award-winning scores and songs heard in successful motion pictures? *Psychology of Aesthetics, Creativity, and the Arts*, 2007. 1(2): p. 53-60.

Oelmann, H. and B. Laeng, The emotional meaning of harmonic intervals. *Cognitive Processing*, 2009. 10(2): p. 113-131.

# Neuroaesthetics and Connectionist Computing



- Neuroaesthetics is a nascent bottom up scientific study of aesthetic perception that begins at the level of the neuron and neurology.
- It is made possible in part thanks to brain imaging technologies such as:
  - fMRI (functional magnetic resonance imaging)
  - PET (positron emission tomography scanning)
  - fNIR (functional near-infrared imaging)

105

But would a heat map movie of a CPU allow us to infer much about the algorithm being executed?

(Note: I am told there are cryptography methods that use heat map analysis of CPUs to capture encryption keys)





### Peak Shift

for a given stimulus a “super-stimulus” will generate an exaggerated response.

In the Herring Gull the red spot on the beak of the parent acts as a stimulus causing the chicks to peck at it, and that in turn stimulates feeding behavior by the adult.

Oddly, the herring gull chicks will also peck at any red dots, such as those painted on a stick, and a greater number of red dots will stimulate a stronger pecking response.

This kind of behavior has been posited as a neurological precursor to caricature and other artistic techniques which exaggerate visual features.

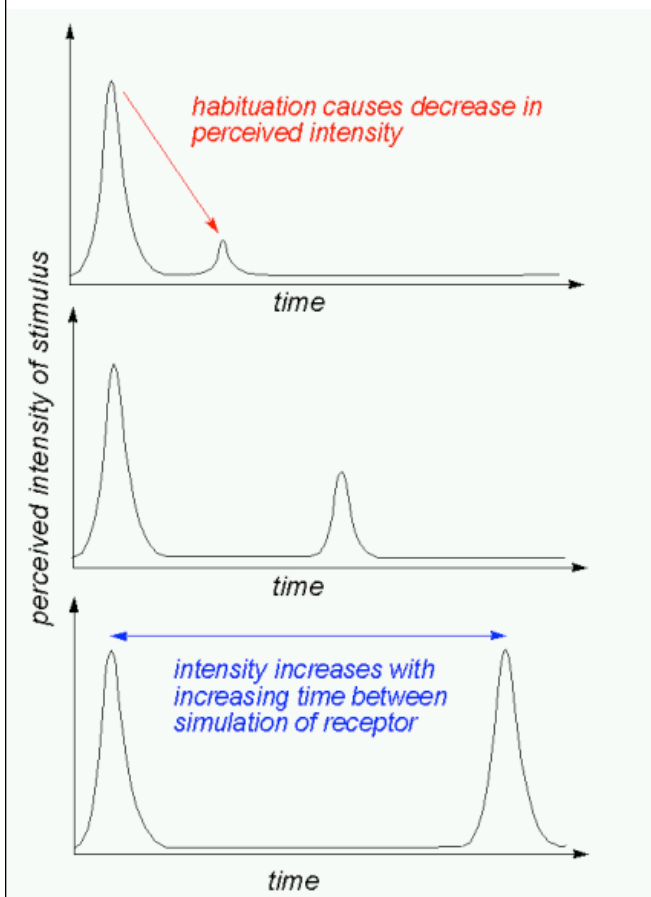

## Habituation

repeated exposure to the same stimulus, especially without recovery time, lessens the perceived intensity.

The combined effects of peak shift and habituation have been suggested as a neurological engine behind the tendency in art to move to increasingly extreme styles over time.

See Martindale's "the clockwork muse" for a more developed theory of stylistic change in the arts.

Martindale, C. (1990). *The clockwork muse : the predictability of artistic change*. New York, N.Y.: BasicBooks.

# Heirarchical Temporal Memory



- HTM is essentially a neural network design invented by Jeff Hawkins inspired by his model of neocortex function.
- The model suggests a hierarchical associative memory system that exploits the passage of time by creating local prediction feedback loops for constant training.
- It's a single mechanism for all manner of higher brain function including perception, language, creativity.
- Lower levels aggregate inputs and pass the results up to higher levels of abstraction.
- Neurologists know that the neocortex consists of a repeating structure of six layers of cells.

Hawkins suggests within a given level higher layers constantly make local predictions as to what the next signals passed upward will be. Correct predictions strengthen connections within that level.

Hawkins, J. and Blakeslee, S. (2004). On intelligence, 1st edn, Times Books, New York.

- Evolvable hardware exploits firmware as genotype using devices such as field programmable gate arrays (FPGAs).
- The system behavior is the phenotype, and given an appropriate fitness function such a system can exhibit emergent learning.
- Glette et al (2007) described a proposed evolvable hardware system simulated in software. Used as a pattern recognition system for facial recognition it achieved an experimental accuracy of 96.25%.

Glette, K., Torresen, J., & Yasunaga, M. (2007). An Online EHW Pattern Recognition System Applied to Face Image Recognition Applications of Evolutionary Computing (pp. 271-280): Springer.

# Conclusion



## Concluding Summary



- To build truly creative systems we not only need generative systems, we also need systems capable of critical judgement.
- We don't know yet how to build robust CAE systems although there have been some notable niche applications of merit.
- Emergent machine aesthetics are interesting in their own right, but to date emergent aesthetics have not been effective in simulating predicting or catering to human notions of beauty and taste.

# Concluding Summary



- It seems unlikely that simple formulaic or geometric theories will yield robust CAE.
- Traditional design theory might be of help if we can build computer vision systems capable of high level semantic abstraction.
- Would-be creative evolutionary systems suffer from the lack of CAE as a lack of automated fitness functions.

## Concluding Summary



- CAE systems that seem to be mathematical or algorithmic are typically built on a foundation of neurological assumptions or models. We need better cognitive models of aesthetics.
- While "complexity" is often cited as an important variable in CAE, there are differing views as to how complexity should be conceptualized, defined, and operationally measured.



- Solving the CAE puzzle seems to be a long way off, but the solution may turn out to be the result of breakthroughs in cognitive science, connectionist computing, and hardware design.

# Computational Aesthetic Evaluation: Automated Fitness Functions for Evolutionary Art, Design and Music

**Philip Galanter**  
Texas A&M University  
College Station, Texas, USA  
[galanter@viz.tamu.edu](mailto:galanter@viz.tamu.edu)  
<http://philipgalanter.com>

<http://www.sigevo.org/gecco-2013/>



Copyright is held by the author/owner(s).  
*GECCO'13 Companion*, July 6–10, 2013, Amsterdam, The Netherlands.  
ACM 978-1-4503-1964-5/13/07.