



# POOL ASSEMBLY AND INSTALLATION INSTRUCTIONS OVAL POOLS

## THINK "SAFETY FIRST"

Safe and correct use of your new Lomart pool means swimming and wading only. DO NOT DIVE OR JUMP! The above-ground pool is not designed for these activities!

### INSTALLATION

Installation of a Lomart pool is not very hard, but it is a big job. The job will be easier if two or three friends help with the installation. Follow all instructions exactly. Your pool warranty is void if pool assembly and installation instructions are not followed 100%. Read all instructions provided with accessories such as filter, pump, skimmer, etc. prior to starting. Plan 3-5 days for pool assembly and installation. Avoid windy days. Before you start, check to see that you have the correct number of parts. Use your Parts List, which is broken down by carton. Do not throw away any of the inspection slips or cartons until you are sure you have all the parts. Your dealer will promptly replace any missing parts. The warranty is void if the design of the pool is altered in any way. No changes may be made to any of the parts. The pool must be assembled according to Lomart's instructions. You must be completely satisfied with the completed pool installation, whether self-installed or professionally installed, before proceeding with additional landscaping.

### CONTRACT INSTALLATION

Lomart is in no way affiliated with any professional pool installer. Therefore, Lomart can assume no responsibility for errors in installation by the homeowner or said professional installer. If you have the pool installed by others, please supervise to be sure they comply with proper installation techniques as shown.

### LOCAL CODES

Check to see if building permits or utility clearances are required (for example - National BOCA Code requires the pool to be a minimum of six feet from the property line and a minimum of ten feet from the street). Obey all safety codes for fencing and all electrical codes.

### SPECIAL CARE

Lomart pools are designed to exceed industry recommended safety factors. However, special care must be taken with certain installation procedures that the installer performs and controls.

- 1) Framework must be level.** - Referring to "Installation Cautions" shown at right, six pool installations illustrate improper methods of installation or errors during the leveling of the ground (Step 2) or positioning of the patio blocks (Steps 4 and 5). The entire pool framework must sit on flat (level) ground. An out-of-level condition will produce stresses in the pool structure and/or deformities in the wall that could cause pool wall failure.
- 2) Cove.** - The cove keeps the liner from creeping out from under the pool wall. Follow instructions carefully. Don't shortcut or substitute materials. Do not use materials that will shift. Improperly installed pools can rupture, allowing thousands of gallons of water to rush out and cause extensive property damage and personal injury.
- 3) Set up pool on soil surface.** Lomart pools are not designed to be buried. Outside ground forces can collapse the pool wall.
- 4) Deep Swim Area Pools.** The excavation and use of 8" x 8" x 16" concrete blocks (Steps A through E) to reinforce the side supports is a critical structural detail which cannot be varied from instruction. These blocks and the firm undisturbed soil under and around them become the load bearing components for the forces on the pool sides. DO NOT substitute other building materials for the concrete blocks.

### HOW TO USE THESE INSTRUCTIONS

These installation instructions are used in conjunction with your pool parts list for identifying parts as referred to in each step. Your pool can be excavated for a deep swimming area if the liner carton is labeled Variable Depth (see reverse side for "Optional Special Purpose Deep Swim Area").

### PRELIMINARY PLANNING

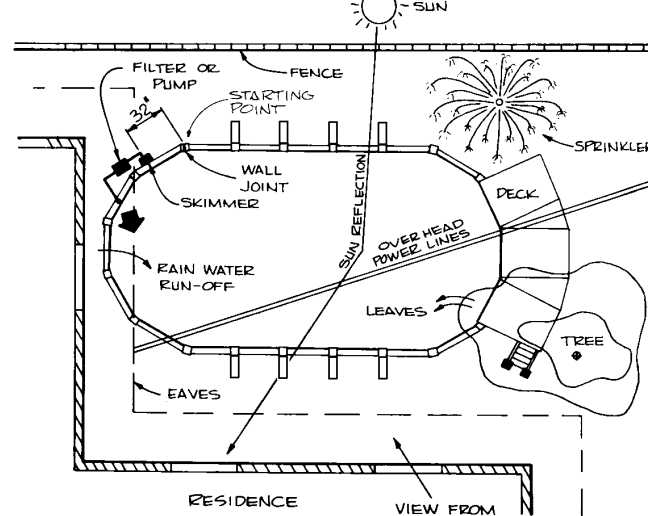

### IMPORTANT: Before beginning your pool installation, take a few minutes to consider the following points:

- Check wall clearances to allow enough working area for your pool installation.
- Check for easements.
- Avoid trees and roots; do not allow leaves to fall into the pool.
- Avoid overhead power lines.
- Avoid underground piping and cables.
- Keep sprinklers away from pool sides.
- Select a pool site that allows for the proper supervision of swimmers as well as viewing children near the pool.
- Position the pump and filter near convenient electrical outlets.
- Avoid overhanging eaves to prevent water and debris runoff from your roof.
- Allow 12 inches of undisturbed soil around your pool (clearance radius).
- No sudden slopes within 6 feet of your pool.
- Do not install your pool on any abrasive area such as concrete, asphalt, peat moss, tar paper, gravel, wood, top of grass or on soil which has recently undergone petroleum based chemical treatments.
- Treat the ground inside the pool area with a non-petroleum based fungicide (available at garden supply shops). This may help prevent fungus stains on the liner. Consult your Doughboy pool dealer.
- Do not install liner on nut grass or Bermuda grass. See your dealer for special instructions.
- Rid pool area of burrowing pests and insects such as gophers and termites.
- Avoid windy days during installation.
- Have 2 or 3 helpers to assist you during pool assembly (clearance radius).

### TOOLS AND MATERIALS REQUIRED

- Materials Needed -**
- Nails - 2 1/2" Long (1 Doz.)
  - Concrete Block (4) Patio Blocks
- FLAT BOTTOM POOLS**
- (12"x12"x2" Patio Blocks Only):
- | Pool Size | Sides (Mandatory) | Ends (Optional) |
|-----------|-------------------|-----------------|
| 12 x 24   | 16                | 10              |
| 15 x 24   | 12                | 12              |
| 15 x 30   | 20                | 12              |
| 15 x 33   | 24                | 12              |
| 18 x 33   | 20                | 14              |
| 18 x 36   | 24                | 14              |
| 18 x 39   | 28                | 14              |
- DEEP EXCAVATED POOLS (Optional)**
- ALL POOLS**
- 4 - 8" x 8" x 16" Concrete Blocks
  - 4 - 8" x 8" x 8" Concrete Half Blocks
- PATIO BLOCKS (12" x 12" x 2")**
- | Pool Size | Sides (Mandatory) | Ends (Optional) |
|-----------|-------------------|-----------------|
| 12 x 24   | 12                | 10              |
| 15 x 24   | 8                 | 12              |
| 15 x 30   | 16                | 12              |
| 15 x 33   | 20                | 12              |
| 18 x 33   | 16                | 14              |
| 18 x 36   | 20                | 14              |
| 18 x 39   | 24                | 14              |
- Tools Required**
- 2" x 4" board (See Step 2 for length)
  - Duct tape (2" wide)
  - Wood stakes - 2" x 2" x 18" (approx. 12)
  - Enamel, fast drying (Not lacquer) (Step 13)
  - Pool covering (See Step 18)
  - 2" Carpenter's level (Transit recommended)
  - Hammer
  - Flat end shovel
  - 5/16" Hex nut driver
  - 25" Tape measure
  - Garden rake
  - Tamping tool
  - Roller (if available)
  - Screwdriver, flat end (Large)
  - 2 or 3 Garden hoses (Fill pool)
  - Two 7/16" wrenches
  - Felt tip marking pen
  - Carpenter's saw
  - Sifting screen - 2" (to remove 1/8" pebbles and larger)
  - Sharp knife or single edge razor blade
  - Pliers
  - Drill/Bit (See Step 2)
  - Small paint applicator (Q-Tip or brush)

### POOL FASTENER IDENTIFICATION

Your pool assembly may not require all the fasteners shown below. Refer to your Pool Parts List for the fasteners required to assemble your pool.

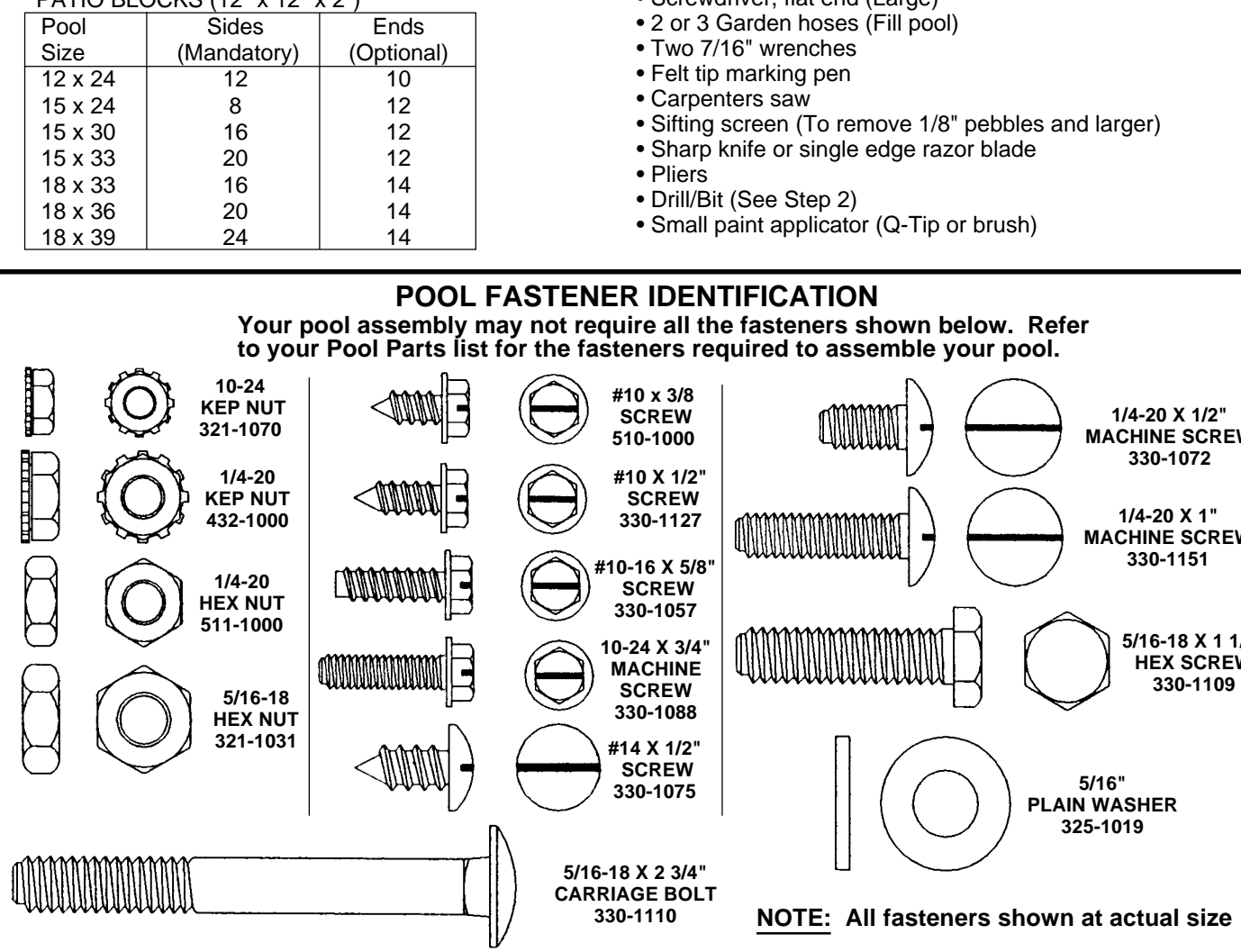

# POOL LAYOUT DIMENSIONS

Numbers across the top represent the various sizes of Lomart above-ground family pools. Below each size is a layout of that pool showing the dimensions, indicated by a solid line, and clearance radius (see Step 1) which is required for external pool parts. If deep end excavation is desired, additional layout dimensions are given in "Optional - Special Purpose Deep Swim Area" on reverse side. Be sure to read "Preliminary Planning" before starting installation.

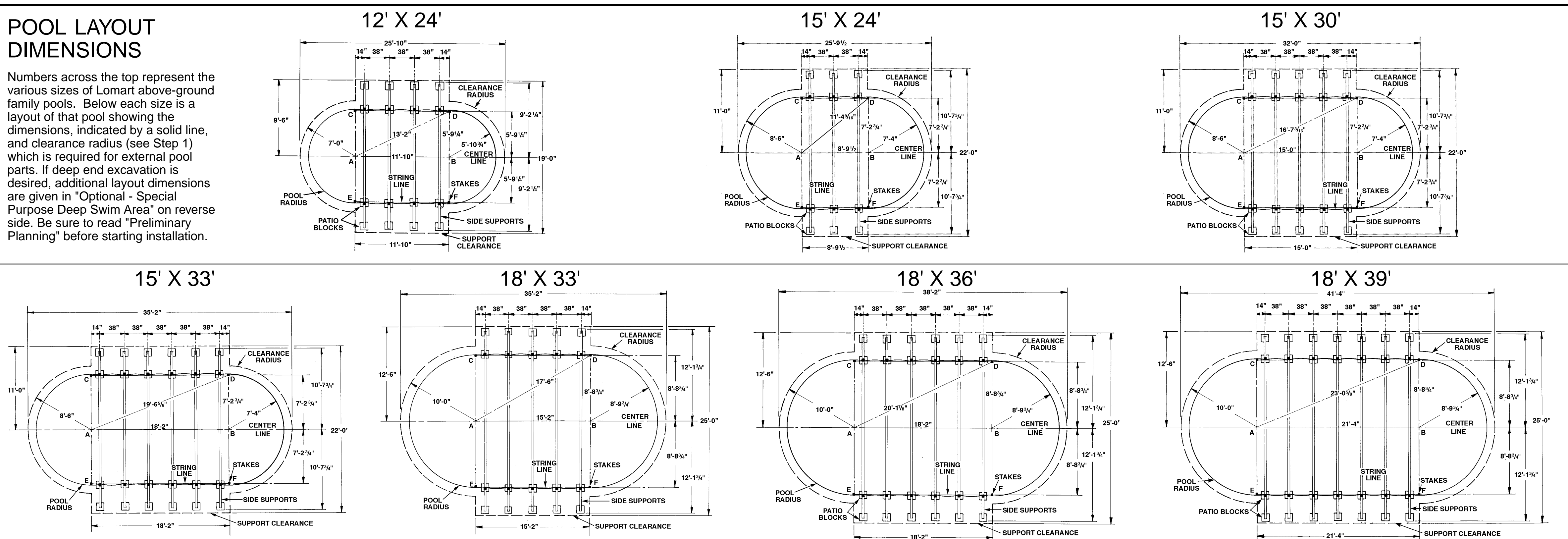

# INSTALLATION CAUTIONS

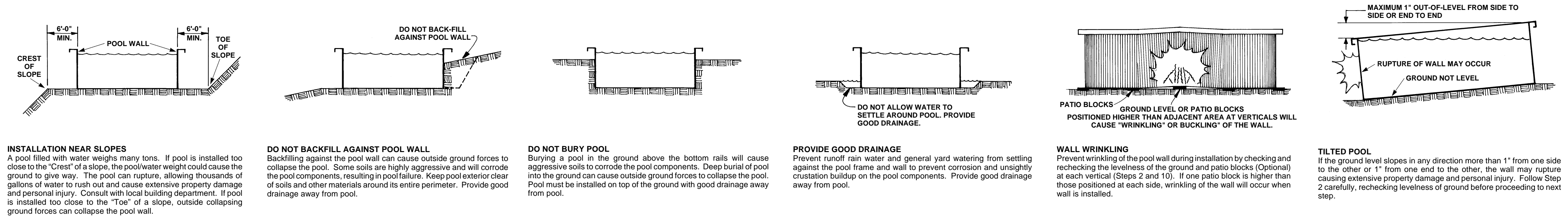

## 1 POOL LAYOUT

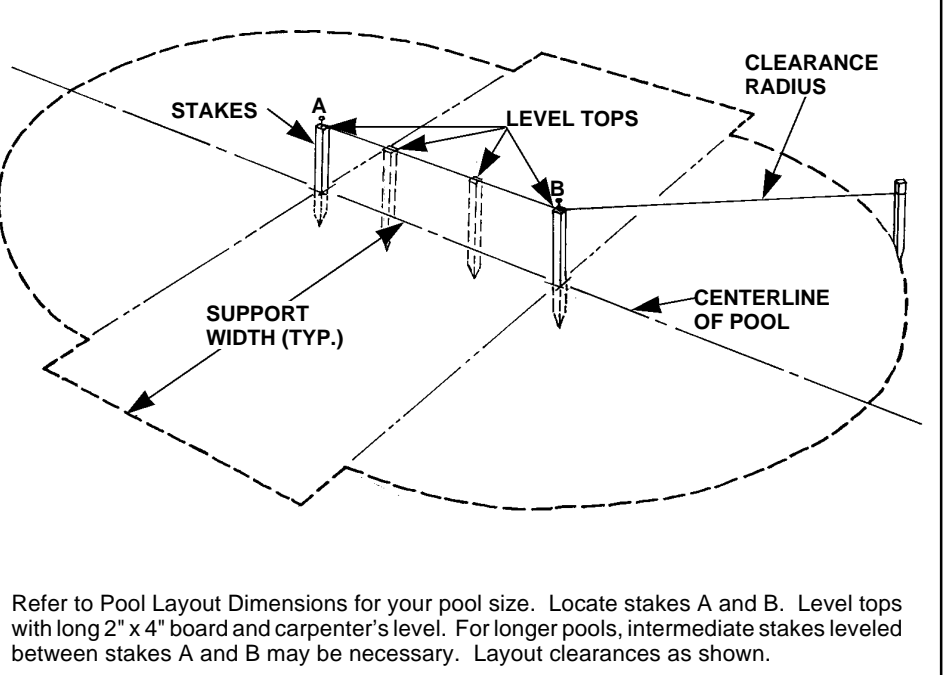

## 2 GROUND LEVELING

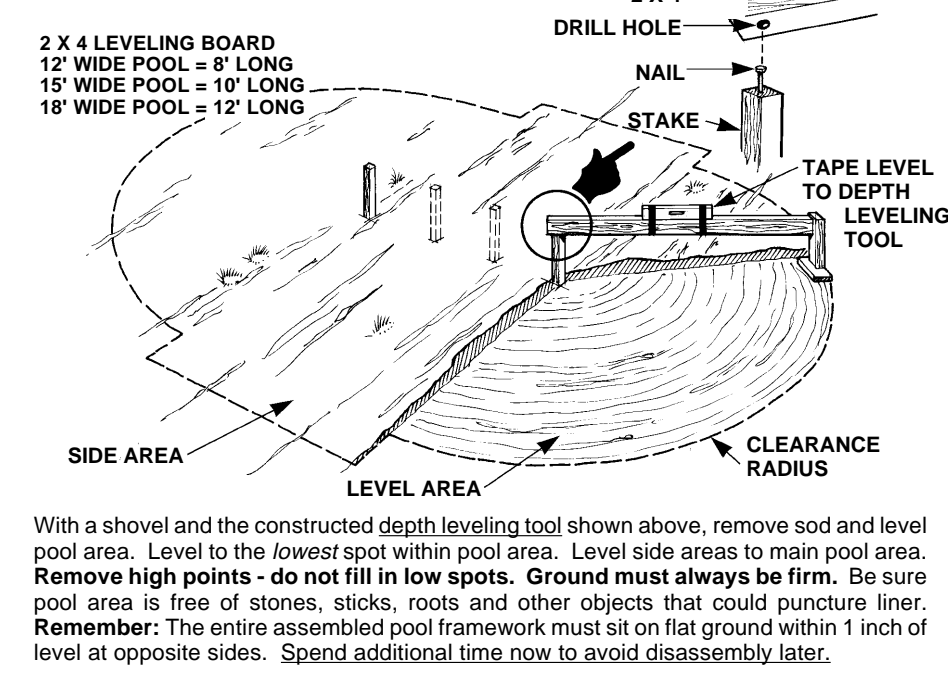

## 3 STAKES & STRING LINES

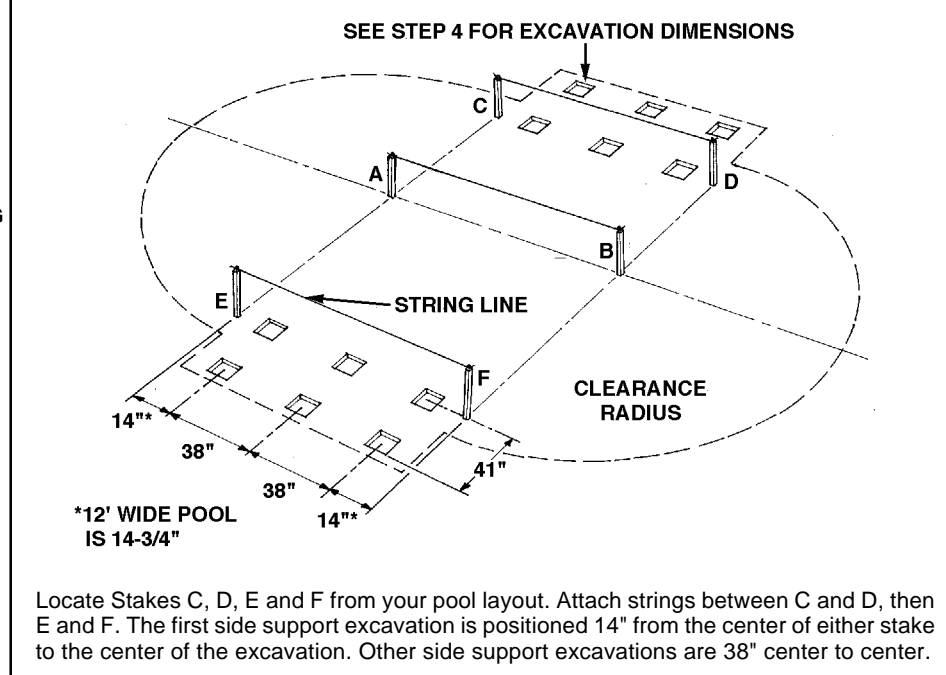

## 4 PATIO BLOCK EXCAVATION

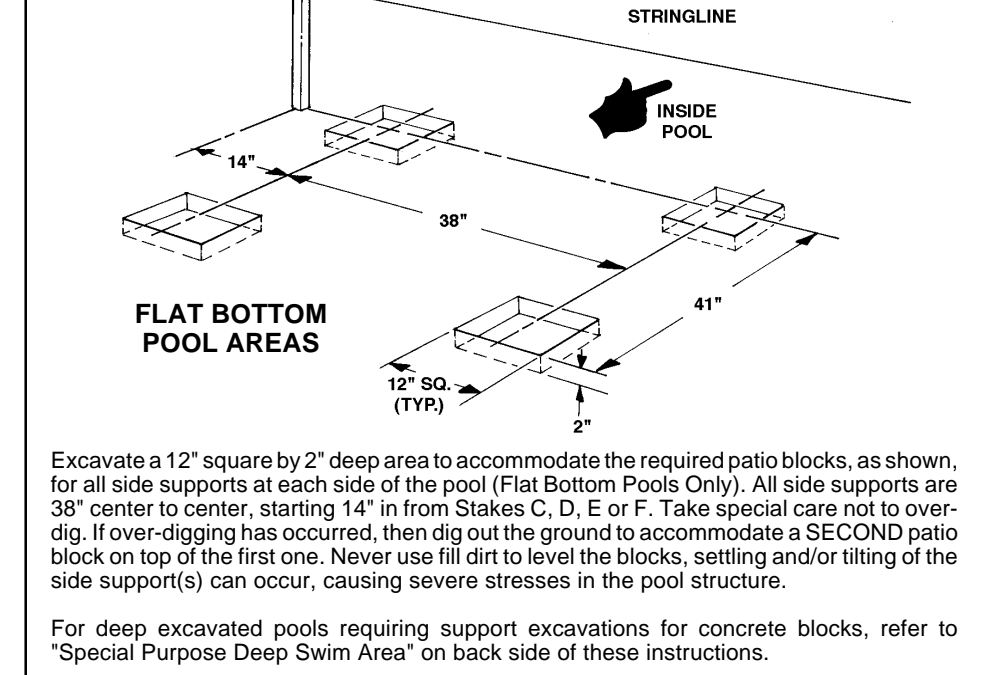

## 5 INSTALL PATIO BLOCKS

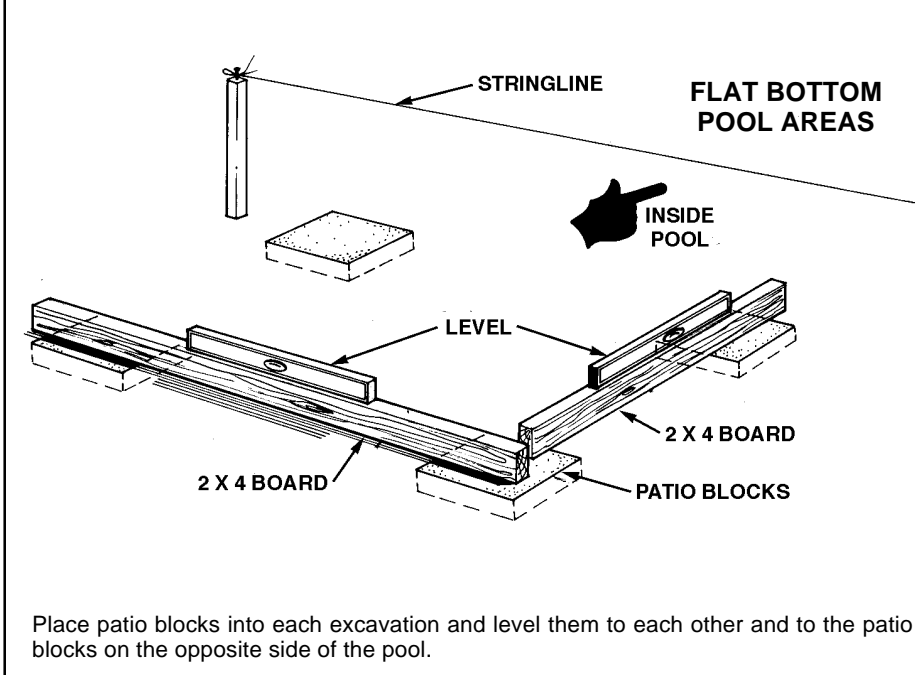

## 6 ASSEMBLE SIDE SUPPORTS

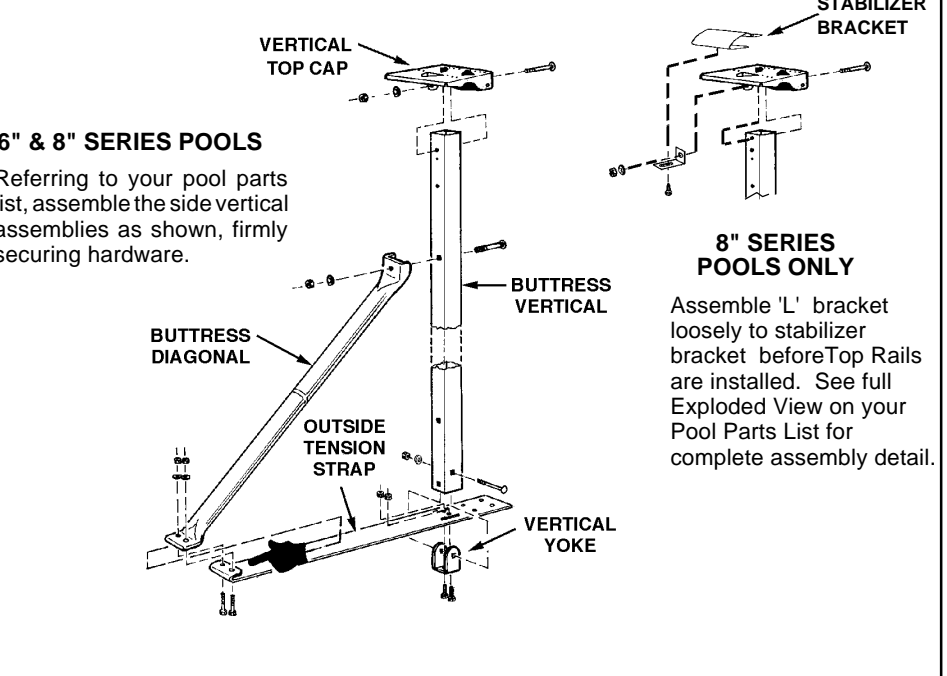

## 7 INSTALL BOTTOM RAIL LOCATORS

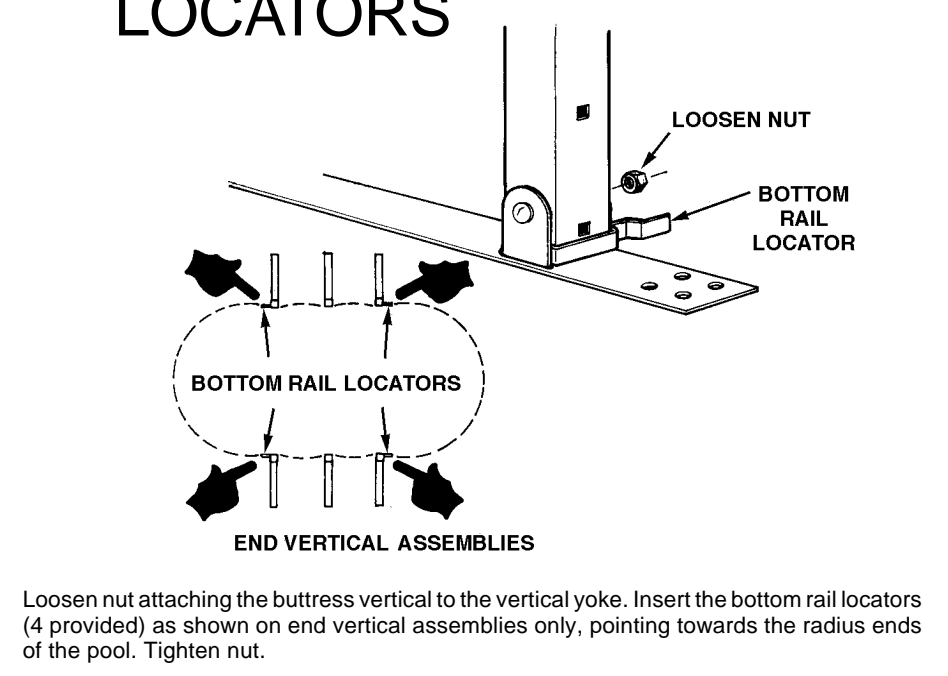

## 8 INSTALL STRAPS

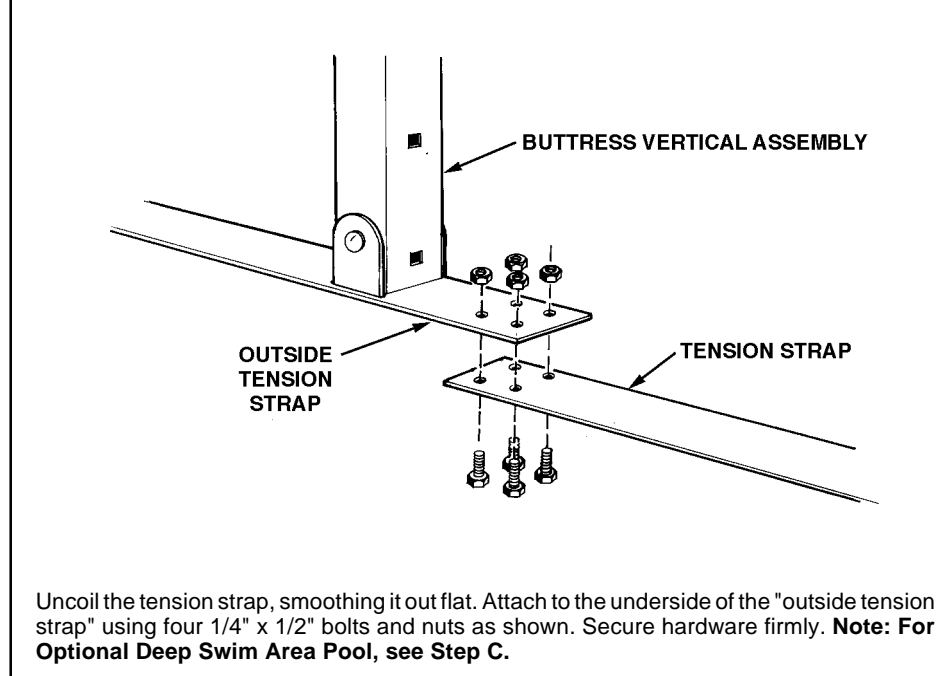

## 9 HOLD DOWN PLATE ASSEMBLY

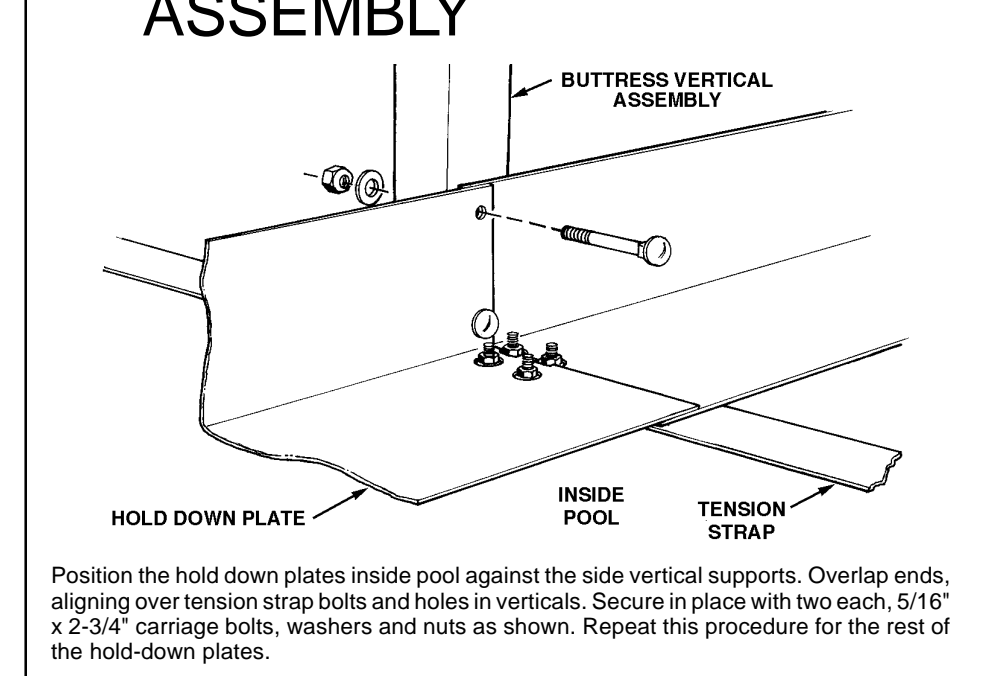

## 10 INSTALL BOTTOM RAILS

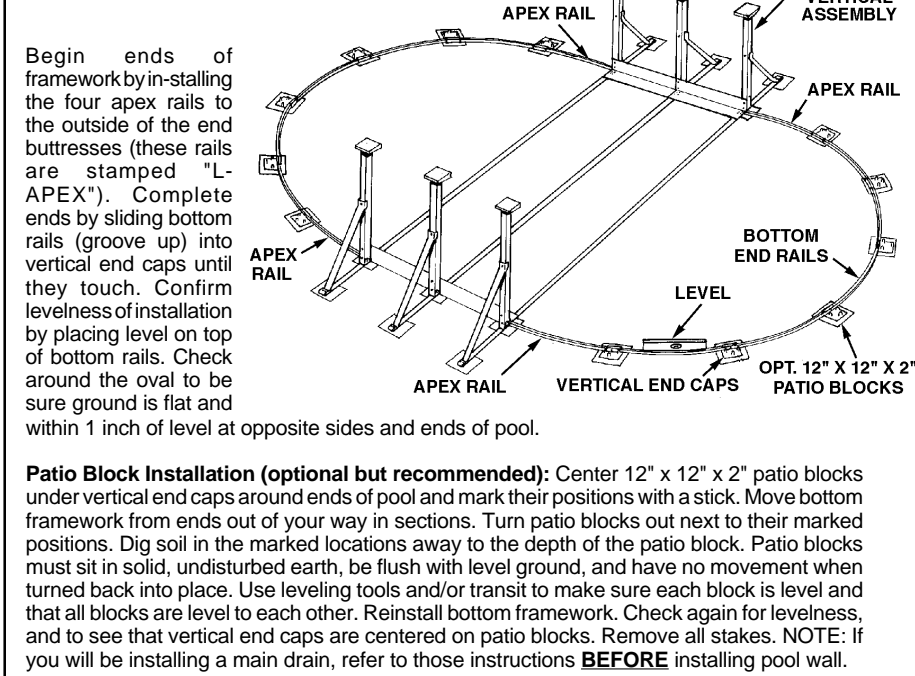

### 11 INSTALL WALL

**NOTE:** Place enough sifted earth into the pool area to cover the hold-down plates and straps (see Step 17) and to form the cove (see Step 18).

Remove pool wall from carton. Note "Up" arrow on wall. Keep hands and feet under wall during installation. Determine starting point of wall from PRELIMINARY PLANNING. The skimmer opening will be at the inside end of the wall cap. For improved skimmer operation, position skimmer knockout downwind of prevailing winds. Always start wall at center of a vertical end cap. Uncoll about 6 to 10 feet of wall and insert bottom edge into groove in bottom rails. To help stabilize the wall, place stabilizer rails on top edge of pool wall, working around top of pool as wall is inserted into bottom rails. Telescope small diameter rail into large diameter rail about 6 inches. Secure stabilizer rails to wall with duct tape between vertical end caps. **NOTE:** The stabilizer rails telescope only on the ends of the pool. Use only the large diameter stabilizer rails between the side supports (these do not telescope).

### 12 ASSEMBLE WALL JOINT

Interlock ends of wall as shown in "A". Insert bolts through holes (B) from inside of pool (threads extending outside of pool). Loosely assemble all nuts, then tighten all nuts and bolts securely. Place the protective vinyl strip over the bolt head (inside pool) and tape into place.

### 13 COAT OPENINGS

Matching pool wall cover plates are provided with pools that have two skimmer openings. Tape over the extra skimmer and return opening in the event you are only using one skimmer. Use a "Q-Tip" or cotton ball dipped in fast drying enamel to coat all bare metal edges of skimmer opening, return opening and mounting holes. This coating protects edges against corrosion. **DO NOT** use fingers as sharp edges may cause serious cuts. Enamel must dry prior to installing liner to prevent damage to liner in contact with freshly painted surfaces.

### 14 INSTALL END VERTICALS

Referring to your pool parts list, assemble the end verticals as shown using all necessary hardware. Attach to bottom connector with tabs located inside verticals. **6" Series:** Assemble the three piece vertical sections by sliding the center section down into the grooves formed on each vertical side section. Attach vertical assembly to bottom connector. Then, hook vertical top cap over wall stabilizer and secure to vertical.

### 15 TOP RAIL JOINTS

There are two top rails for each pool size. There are two different joints where the top rails meet as shown. Refer to Step 16 for attachment.

### 16 INSTALL TOP RAILS

Each pool size has a specific hole pattern for mounting the top rails to the vertical top caps. Use the figure that matches your pool series and size and the accompanying chart to locate the correct mounting holes.

**HELPFUL SUGGESTION:** Use a felt pen to mark the proper holes before you assemble the top rails to the vertical top caps.

Use four #10 x 3/8" screws to attach the top rails to each vertical top cap. From the chart, select the proper holes in the vertical top caps and top rails (stamped into the top rails and top caps). Insert screws through the correct holes in the top rails and screw into the proper holes in the vertical top caps. The holes in the end of the top rails are numbered and the holes in the top caps are lettered. Joint "A" is used for the side junctions and Joint "B" is used for the end and transition junctions (refer to Step 15).

**Example** — 18' x 36' pool with 8" deluxe top rails:

Joint "A" — Insert a screw through top rail hole numbered "22" and screw into top cap hole lettered "M". Insert another screw through top rail hole numbered "3" and screw through stabilizer bracket into top cap hole lettered "N".

Joint "B" — Insert a screw through top rail hole numbered "11" and screw into top cap hole lettered "B". Insert another screw through top rail hole numbered "14" and screw into top cap hole lettered "G".

| POOL SERIES                | JOINT | POOL WIDTH    | TOP RAIL HOLES | TOP CAP HOLES |
|----------------------------|-------|---------------|----------------|---------------|
| 6" TOP RAIL POOLS          | B     | 12'           | 2 & 4          | D & J         |
|                            |       | 15'           | 2 & 4          | B & G         |
| 8" TOP RAIL POOLS (DELUXE) | A     | STRAIGHT SIDE | 2 & 4          | A & H         |
|                            |       | B             | 12'            | 2 & 3         |
|                            |       | 15'           | 2 & 4          | D & H         |
|                            |       | 18'           | 1 & 4          | B & G         |
|                            | A     | STRAIGHT SIDE | 2 & 3          | M & N         |

### 16 cont.

**6" SERIES TOP RAIL CONNECTIONS**

**8" SERIES TOP RAIL CONNECTIONS**

### 17 CHECK WALL RADIUS

**Important Step:** At this time, fill in all excavations on outside of pool. Cover inside hold-down plates and straps with approximately 1" of damp sifted earth; tamp and blend to bottom of pool. Check pool framework to assure level installation. Place the level on each top rail, working gradually around pool, to assure framework is on flat ground with opposite sides no more than 1 inch out of level. **Remember: Always remove dirt to adjust framework - never fill in!** Use level to check straightness of verticals. Using Stake A as center point, measure from stake to pool wall to assure roundness of ends. Measure to the wall at each connector at pool end as shown above. Distance should be equal at all points. Follow same procedure using Stake B as center point for opposite end. Refer to parts list to attach top connectors.

### 18 COVE

**Important Step:** The cove is a vital structural element that prevents water pressure from forcing the pool liner out under the bottom rail. The manufacturer will not assume responsibility should the cove be omitted. **EARTH COVE:** Use screened damp earth to form a cove around the inside base of pool wall. Shape and compact firmly. **PRE-FORMED:** Specifically designed pre-formed pool cove is available from your dealer. Follow cove manufacturer's instructions. **Recheck pool for roundness after installing cove.**

### 19 LINER SEAM POSITIONING

Remove all stakes. Check floor pool (area inside pool wall) for levelness. For excavated pools, check flatness of sloping areas with 2' x 4' board. Fill in all slight depressions with sifted earth and tamp. Remove all stones and sharp objects. Fill in all footprints on pool floor. Place liner on top of top rail (at shallow end if excavated pool). The loose end should overhang outside of pool by about 12 inches. Hold end and unroll liner down middle of pool as you would a carpet. The center seam of the liner must be positioned at the center line of the pool. For excavated pools, the center of the liner must begin at the shallow end and run along the center line of the pool to the deep end. **Note:** The embossed side or the printed side of the liner will be the water side.

### 20 INSTALL LINER - FLAT BOTTOM POOLS ONLY (FOR DEEP EXCAVATION LINER INSTALLATION, SEE STEP "F").

Work in both directions from the point where the liner is overhanging. Unfold liner, drape over the top rail and down the sides approximately 24 inches. The liner should be barely above the pool floor in the center ONLY. Remember that the center seam of the liner must be positioned at the center line of the pool. The bottom edge seam of the liner should be inside the pool about 12 inches from the top rails. Correct any bunching or pleating conditions in the liner wall. Inspect liner for open seams. If found, return to dealer for prompt replacement of liner. For deep excavated pools, refer to Step F.

### 21 FILL POOL

With the liner in position, hold in place by attaching two binder clips over folded cardboard on the underside of each top rail. Carefully cover the end of a garden hose with a sock and tape securely as shown, place it in the pool and begin to fill. As pool fills, the liner will stretch as the water begins to cover the bottom. At this time, check the liner sidewall for extreme tautness. **Binder clips do not self-release.** Any area that feels tight should be relieved by releasing the binder clips and allowing the liner to feed back into the pool until the desired tautness is achieved. Re-clamp binder clips before you proceed around the pool checking and re-clamping. Remember that you are monitoring a minimum tightness of liner over the top rail that will control the liner seating itself against the pool floor and up the side wall virtually without wrinkles. Continue monitoring the liner tension as the water is approaching and covering the cove area of the pool.

Be sure the liner is evenly distributed over the top rail without any bunching or pleating. If this occurs, correct as you are adjusting the liner tension. To correct, grasp the liner wall nearest the wrinkled area. Pull and lift the liner wall just enough to stretch out wrinkles or pleats. It is easier if you wait until there is 1 to 2 inches of water over the wrinkled area before you try to remove it. This allows the weight of the water to hold liner flat on the ground, keeping out wrinkles after you remove them. Pull any excess liner over the top rail and reclamp in position so that a minimum tautness prevents further wrinkling. Double check around the pool so that you have an even tension on the liner wall down to the liner floor. Do not attempt to lift and pull the liner with more than 4 inches of water in the wrinkled area. Damage to the liner may occur.

**Cleaning Liner:** If you decide to drain the pool to clean the liner at any time in the future, you must leave at least 1 foot (12 inches) of water, measured from ground level up the metal sidewall, in the pool. Failure to comply with this warning may void the warranty.

**Liner Replacement:** If you decide to replace the liner, you must have the replacement liner at the pool site and ready for immediate installation. **DO NOT** leave the pool standing without a liner. Do not attempt to install the replacement liner on a windy day. Severe wind damage to your pool may result.

Continue filling pool. **Never allow liner to fall back into pool.** Water between the liner and wall can cause pool failure. When pool has approximately 24 inches of water, stop filling. Do not resume until Steps 23, 24 and 25 are completed. **CAUTION:** Do not cut any openings into liner at this time.

### 22 CONTINUE FILLING POOL

Continue filling pool. **Never allow liner to fall back into pool.** Water between the liner and wall can cause pool failure. When pool has approximately 24 inches of water, stop filling. Do not resume until Steps 23, 24 and 25 are completed. **CAUTION:** Do not cut any openings into liner at this time.

### 23 ATTACH LINER

With the help of two or three people, raise and hold the liner up from any three top rail sections. Remove four top caps, three top rails and stabilizer rails. **Note:** For 8" deluxe pools, remove two vertical top connectors in addition to the above. **REMEMBER, NEVER ALLOW LINER TO FALL BACK INTO POOL.**

### 24 INSTALL COPING AND STABILIZER RAILS

Make a return hem as illustrated. **DO NOT** cut up excess liner material as the liner will "slip" from under the plastic coping, causing liner to fall back into the pool. Smooth liner against wall and secure to top of wall with plastic coping. Place stabilizer rails over coping, alternately telescoping small diameter into large diameter about 6 inches as before. One large diameter stabilizer rail fits between each pair of side supports. They **DO NOT** telescope.

Reinstall the center top rail of the three removed in Step 23. Working your way around pool, remove the next top cap, top rail and stabilizer rails (and vertical top connector for 8" deluxe pools). Pull liner over the pool wall in new working area. Reinstall coping and stabilizer rails. For 8" deluxe pools, reinstall the vertical top connector, hooking it over the stabilizer rails on the pool wall. Then, reinstall a top rail next to the previously reinstalled top rail. Continue working your way completely around pool. In some pools you may find the last piece of plastic coping is too long. If so, cut to fit. **DO NOT** overlap ends. Be careful not to cut liner. Reinstall last top rail and all top caps referring to your pool parts list.

### 25 FINISH POOL

At the skimmer and return openings only, the return hem must be cut away between the steel side wall and the liner side wall. This will insure that there is only one thickness of liner material covering the skimmer and return openings to affect a positive gasket seal. **DO NOT** CUT the liner side wall at any other location. Replace all parts removed in Step 23. Repeat same steps for entire pool perimeter, working just three top rail sections at a time. **DO NOT** allow liner to fall back into pool.

### OPTIONAL - SPECIAL PURPOSE DEEP SWIM AREA

The optional special purpose deep swim area is for underwater swimming only. **NO DIVING OR JUMPING IS PERMISSIBLE.**

This special purpose deep swim area must be used with a variable depth liner and optional drag plate kit.

**12' WIDE**

**15' WIDE**

**18' WIDE**

### A SIDE SUPPORT EXCAVATION - FOR DEEP END EXCAVATION

Special drag plate supports are required adjacent to the deep swimming area on both sides of your pool, replacing the tension straps normally used on Flat Bottom Pools. The first two side supports on each side of the pool at the excavated end will require an excavated area for placement of concrete blocks for the drag plate supports. Excavate for the concrete and patio blocks to the dimensions as shown. Take special care not to over-dig. If over-digging has occurred, then dig out the ground to accommodate a SECOND block on top of the first one. Never use fill dirt to level the blocks, setting and/ or tilting of the side support(s) can occur, causing severe stresses in the pool structure.

### B INSTALL CONCRETE BLOCKS

Each side of the excavated end of the pool will require seven (7) concrete blocks. 7-5/8" x 7-5/8" x 15-3/4", and two (2) concrete blocks, 7-5/8" x 7-5/8" x 7-5/8". Carefully, place four (4) of the large blocks into the excavated area as shown towards inside of pool. Place the remaining three (3) large blocks and two (2) small blocks behind the first blocks. Place the patio blocks into the excavated area. Level all blocks to each other end to the blocks on the opposite side of the pool. **Caution:** Do not fill in the openings in the concrete blocks at this time.

### C ASSEMBLE SIDE SUPPORT WITH DRAG PLATE

Assemble drag plates to each of the two side vertical assemblies on either side of the pool at the excavated end. Attach the drag plate to the outside tension strap, using 1/4-20 x 1 1/2" slotted screws and 1/4-20 nuts. Install the screws so the head is facing down. Tighten all screws securely. Refer back to Step 8 for tension strap assembly to the remaining buttress vertical assemblies.

### D INSERT CONCRETE BLOCK INTO DRAG PLATE

Carefully remove the concrete block from the inside row nearest the stake and the block at the opposite end in the same row. Insert the concrete block into each drag plate as shown (both sides of pool).

### E INSTALL SIDE SUPPORTS

Lower the buttress vertical assembly with the concrete block into the excavated area. Gently tap the buttress vertical until the 14-inch centerline dimension from the stake is achieved. Repeat this procedure for the second buttress vertical until the 38-inch centerline dimension from the first buttress vertical is achieved. Recheck the level of the blocks. Fill all the openings in the cement blocks with dirt and pack firmly. Refer back to your assembly instructions at Step 7.

### F INSTALL LINER

Refer to above notes and general installation data that applies to flat bottom pools. **EXCEPTION:** Proper installation of the Lomart Variable Depth Liner in a Deep Excavated Pool may result in some wrinkles at the deep end of your pool. This is not the result of installation or liner quality, but is inherent in a Variable Depth Type Liner. Adjust the amount of liner over the top rails so that more is released to drape into the deep end than will be required at the shallow end. Liner should not touch floor for the length of pool. Refer back to Steps 21 through 25 to continue with filling the pool and finishing the installation.

### WARNINGS • LABELS • SIGNS • BOOKLETS

With pool completely assembled, install skimmer, filter, etc. using instructions provided with units.

Now that you have installed your new pool, Lomart Industries would like you to know we are very concerned about your family's safety, so we have provided an assortment of safety literature with your new pool. You will have years of fun and enjoyment with your new pool, but it is also a big responsibility. Please take the time to read, and understand all the safety literature provided.

We have also provided you with an assortment of signs and decals. It is mandatory that you use these signs and decals. We have provided you with a booklet titled "Read Me First", which will give you a detailed description of where and how to apply them. Remember, warnings only help if you put them up. Please help us protect the good health and safety of your family and friends! Read the "Read Me First" booklet thoroughly and follow the directions in it. Don't forget to write the number of a rescue agency on the signs and on the back of your "Read Me First" booklet.

If any of your safety literature, signs or decals become lost or damaged, you can get more free by contacting Lomart's Customer Service Department: Lomart Industries • 10959 Jersey Blvd. • Rancho Cucamonga, CA 91730-5194.

**Important!** Above-ground pools are designed for swimming and wading only. Do not Dive or Jump! Misuse of your pool may result in crippling injury and/or other dangerous to life and health. Do not use slides, diving boards, or any other platform or object which can be used for improper pool entry. Use only an above-ground swimming pool ladder to enter or exit your pool. It is the pool owner's responsibility to secure the pool against unauthorized, unsupervised or unintentional entry. It is also the pool owners responsibility to warn all pool users of the hazards of diving into shallow water: paralyzing injury may result. Always obey all safety rules. Remember, pool safety is everybody's responsibility.

Change of Design: Lomart Industries expressly reserves the right to change or modify the design and construction of any product in due course of our manufacturing procedures, without incurring any obligation or liability to furnish or install such changes or modifications on products previously or subsequently sold.