

Business & Market Outlook

August, 2013



Disclaimer

From the first quarter of 2012, this material shows business results and related substances by 3 divisions(Petrochemicals, I&E Materials and Energy Solution) and thus past figures are revised to a same basis.

The business results are subject to the IFRS(International Financial Reporting Standards) from 2010. In addition, operating profits for 2011 and 2012 are amended to reflect revisions of “K-IFRS, No. 1001” decided on 19th regular Financial Services Commission’s meeting on October 17th, 2012.

Forecasts and projections contained in this material are based on current business environments and management’s strategies, and they may differ from the actual results upon changes and unaccounted variables.

Table of Contents

LG Chem at Glance	1
2Q 2013 Business Results	3
Divisional Results & Outlook	5
Appendix	7

LG Chem at a Glance

- LG Chem was started in 1947 and is Korea's first and largest chemical company with an established track of over 60 years and annual revenues of KRW 23.3 trillion in 2012.
- LG Chem boasts multiple production facilities and an extensive distribution network that spans 15 countries worldwide in Asia, Europe, North and South America.
- LG Chem currently holds the largest vertically integrated petrochemical production platform in Korea.
- LG Chem was reborn as a specialized and diversified chemical company that focuses on petrochemical goods, rechargeable batteries including HEV/EV purpose, OLED materials, and 3D FPR.
- LG Chem will seek operational excellence in its core business and centralize its resources with new business such as HEV/EV batteries and LCD glass substrates to reinforce the necessary momentum for future growth.
- Despite high uncertainties remaining in the business environment such as a delayed recovery in the global economy, LG Chem recorded historically the highest sales in 2012.

Impressive Revenue Scale*

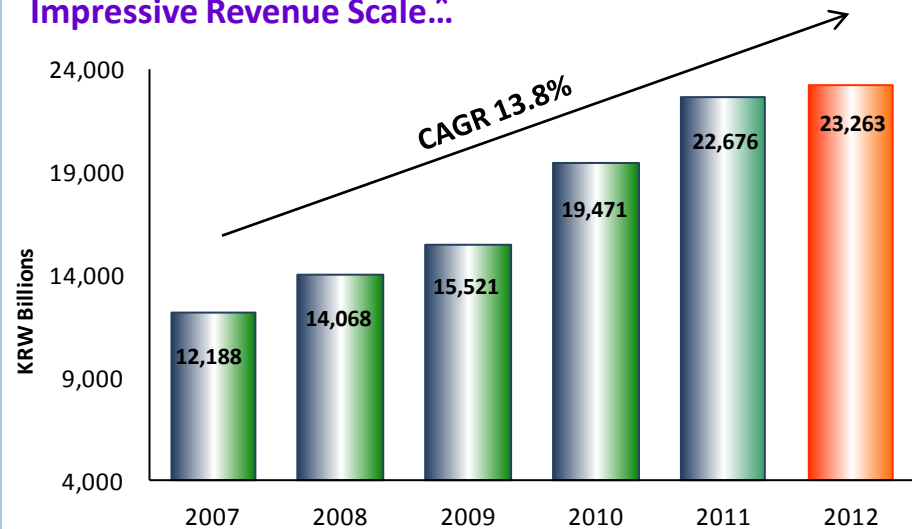

...with Strong EBIT & EBIT Margins*

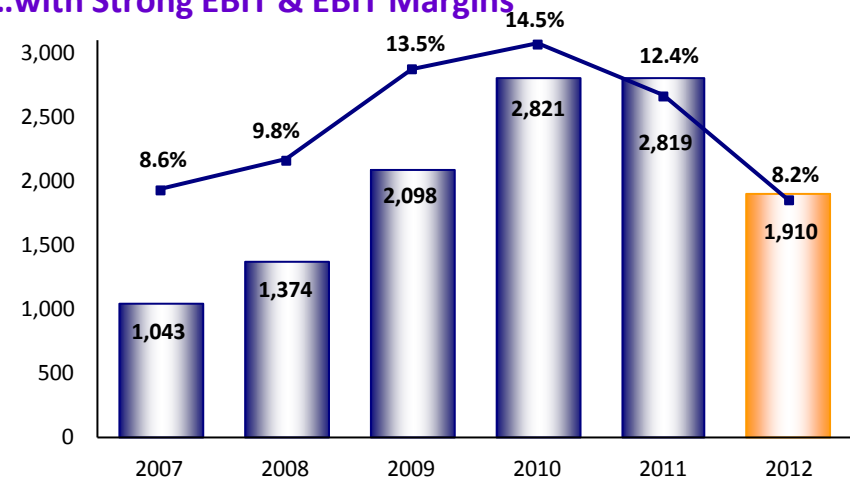

* Sales and EBIT are subject to IFRS from 2009. Those prior to 2009 are subject to K-GAAP(consolidated base).

Differentiated Competitiveness

Vertical Integration Structure

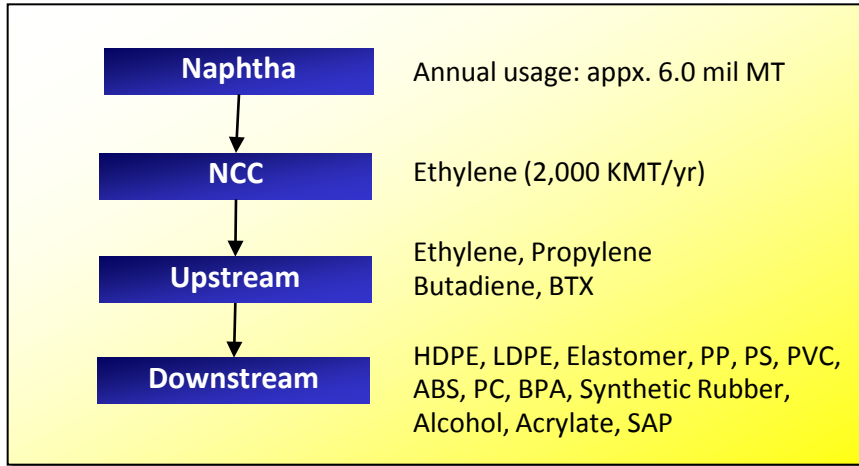

Co-existence of upstream and downstream products

- One of few petrochemical companies around the globe with vertical integration structure, featuring both upstream and downstream production capability.
- This structural characteristic delivers stable business performance against industry cyclicality.

Comprehensive downstream product lines

LG Chem's comprehensive downstream product lines of PO, ABS, PVC and other various products have complementary business cycles, enabling the Company to generate stable revenue



Stabilized revenue generating capability under any market conditions

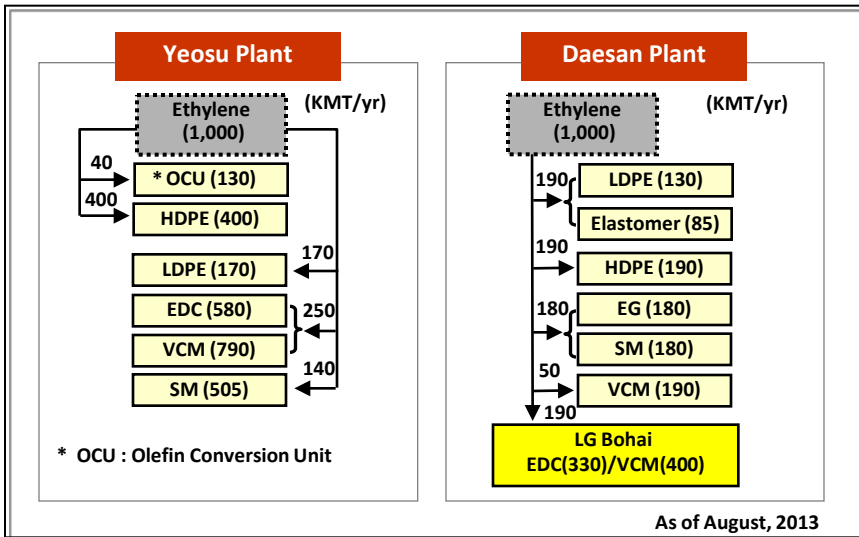

(Unit: KRW bn)

Classification	'12.2Q	'13.1Q	'13.2Q	YoY	QoQ
Sales	5,996	5,721	5,917	-1.3%	3.4%
Operating Profit	499	409	502	0.5%	22.6%
(%)	(8.3)	(7.1)	(8.5)		
Pre-tax Income	480	415	510	6.2%	22.9%
(%)	(8.0)	(7.2)	(8.6)		
Net Income	374	340	401	7.2%	17.8%

Financial Position

(Unit: KRW bn)

Classification	'12	'13.2Q	Change
Asset	16,581	17,959	8.3%
Cash and equivalents	1,341	2,033	51.6%
Liabilities	5,816	6,646	14.3%
Borrowings	2,947	3,307	12.2%
Shareholder's Equity	10,765	11,313	5.1%
EBITDA	2,784	1,412	

Financial Ratios

Classification	'12	'13.2Q	Change
Total Liabilities/ Equity (%)	54.0	58.7	4.7%p
Borrowings / Equity (%)	27.4	29.2	1.8%p
Interest Coverage Ratio (x)	26.2	29.7	3.5
ROE (%)	14.7	13.4	-1.3%p
ROA (%)	9.5	8.6	-0.9%p

Business results

(Unit: KRW bn)

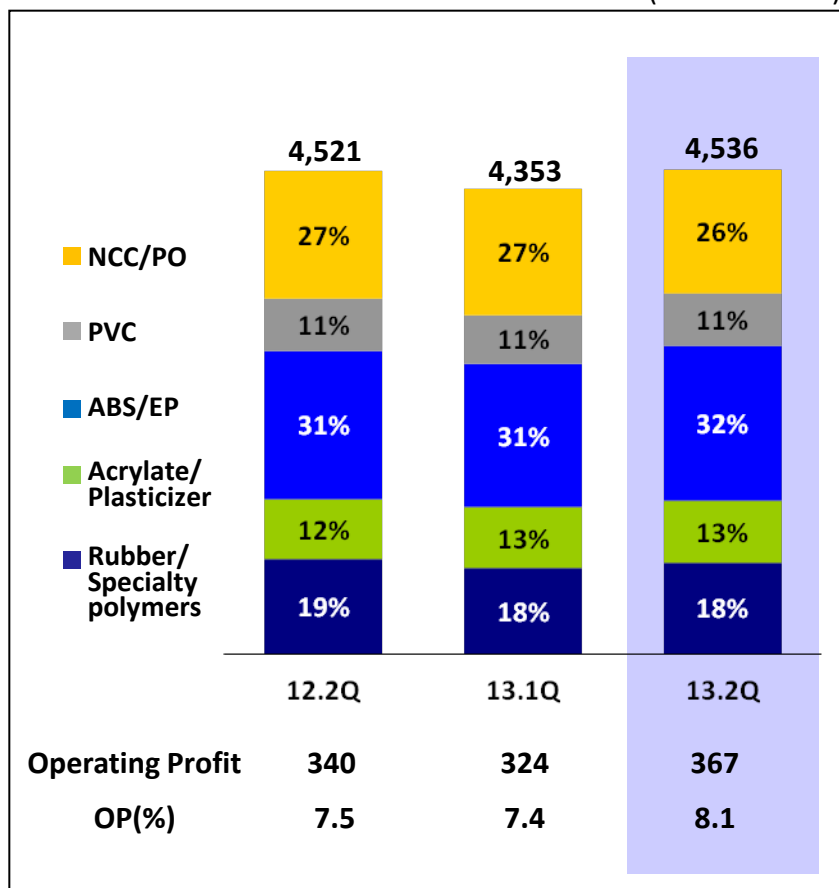

Analysis

• Analysis

■ Earnings improved based on stabilized feedstock costs and differentiated product mix

- NCC/PO : Increased profits with spread recovery by stabilized naphtha costs and increased premium PO sales
- PVC : Improved margin due to decreased ethylene costs and recovery of caustic soda price
- ABS/EP : Maintained profitability by extending sales in European market and premium product shipment increases
- Acrylate/Plasticizer : Maintained favorable business results by stable supply-demand balance
- Rubber/Specialty Polymers : Profit increased through expanding market share of non-Chinese areas despite weak tire demand continued

• Outlook

- Expect gradual market recovery with seasonal demand growth and favorable business environment
- Solid profits continue with margin improvement by reflecting low feedstock costs and differentiated product portfolio

Business results

Analysis

(Unit: KRW bn)

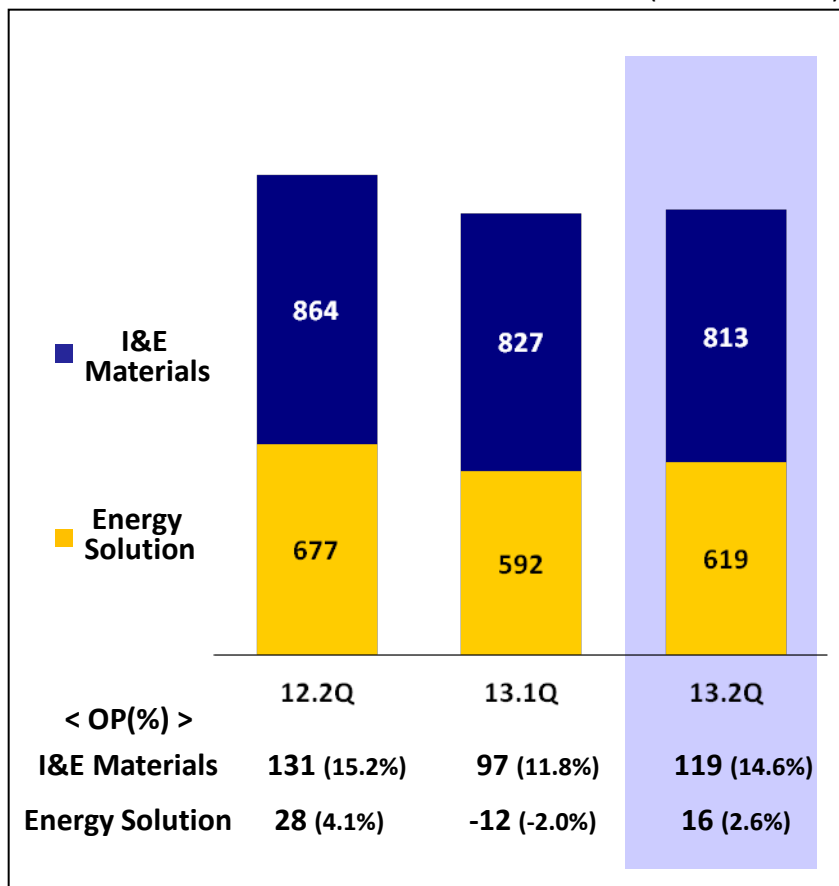

• Analysis

■ Despite limited seasonal demand increase, earnings improved thanks to sales increase of strategic products & cost reduction stemming from weak JPY

- **I&E Materials** : Recorded improved profitability based on stable LCD industry, profitable product sales increase such as FPR, ITO film and cost reduction
- **Energy Solution** : Earnings improvement due to polymer capacity additions

• Outlook

■ Strengthen global market position through diversifying customers and applications & increasing profitable product sales

- **I&E Materials** : Maintain sound profitability with high margin product sales such as ITO film
- **Energy Solution** : Expect polymer shipments increase thanks to customers' new product releases & rise in automotive battery sales

(Unit: KRW bn)

Classification	2012					2013				
	1Q	2Q	3Q	4Q	Total	1Q	2Q	3Q	4Q	Total
Sales	5,753	5,996	5,834	5,681	23,263	5,721	5,917			11,638
Operating Profit	447	499	601	364	1,910	409	502			910
Petrochemicals	4,491	4,521	4,366	4,201	17,579	4,353	4,536			8,889
NCC/PO	1,249	1,200	1,174	1,163	4,786	1,178	1,165			2,342
PVC	478	485	449	450	1,862	463	489			953
ABS	1,104	1,115	1,111	1,032	4,361	1,082	1,165			2,246
EP	267	281	262	257	1,067	265	282			547
Acrylate / Plasticizer	530	556	551	557	2,195	570	591			1,161
Synthetic Rubber / Specialty Resin	864	883	819	743	3,310	795	845			1,640
Operating Profit	366	340	436	294	1,436	324	367			691
I&E Materials	761	864	923	903	3,452	827	813			1,641
Operating Profit	69	131	150	85	436	97	119			216
Energy Solution	562	677	611	628	2,479	592	619			1,210
Operating Profit	12	28	14	-15	39	-12	16			4

※ ABS/EP business are divided into two parts from 2013. So business results for ABS and EP are amended to reflect the partition of business.

Borrowings

(Unit : KRW bn)

Classification	'12	'13.2Q
Total (Overseas Subsidiaries)	2,947 (1,024) 100%	3,307 (1,245) 100%
KRW Currency	812 28%	807 24%
C P	598	598
Others	214	208
Foreign Currency	2,135 72%	2,501 76%
Loan	1,140	1,355
Negotiation Borrowings	994	1,145
Short-term (Overseas Subsidiaries)	1,752 (739) 59%	2,106 (961) 64%
Long-term (Overseas Subsidiaries)	1,195 (286) 41%	1,201 (285) 36%

* The % is calculated to total borrowings.

Cash Flow

(Unit: KRW bn)

Classification	'12	'13.2Q
Beginning Cash	1,379	1,341
Operating/Investing	-143	627
Net Income	1,506	741
Depreciation	874	502
Working Capital	-147	-156
CAPEX	-2,075	-721
Others	-300	260
Financing	104	66
Borrowings	420	360
Dividends	-316	-295
Ending	1,341	2,033

(Unit: KRW bn)

Classification		'11	'12	'13 Plan	'13.1H
Petrochemicals	New / Expansion	664	784	549	247
	Maintenance	296	226	245	105
	Total	960	1,009	795	352
I & E Materials	New / Expansion	332	242	744	137
	Maintenance	103	90	135	50
	Total	434	332	878	187
Energy Solution	New / Expansion	660	395	70	58
	Maintenance	176	138	202	64
	Total	836	533	272	122
Common Expenses	New / Expansion	-	16	-	-
	Maintenance	91	185	179	60
	Total	91	201	179	60
Total	New / Expansion	1,655	1,436	1,363	442
	Maintenance	665	639	761	279
	Total	2,321	2,075	2,124	721

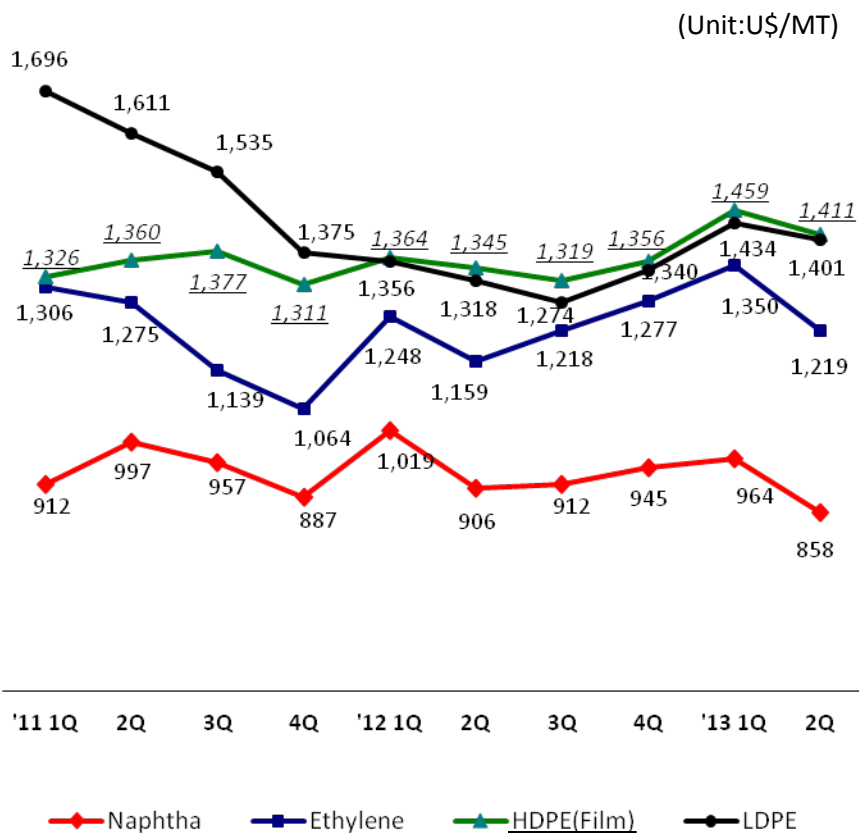

NCC/PO

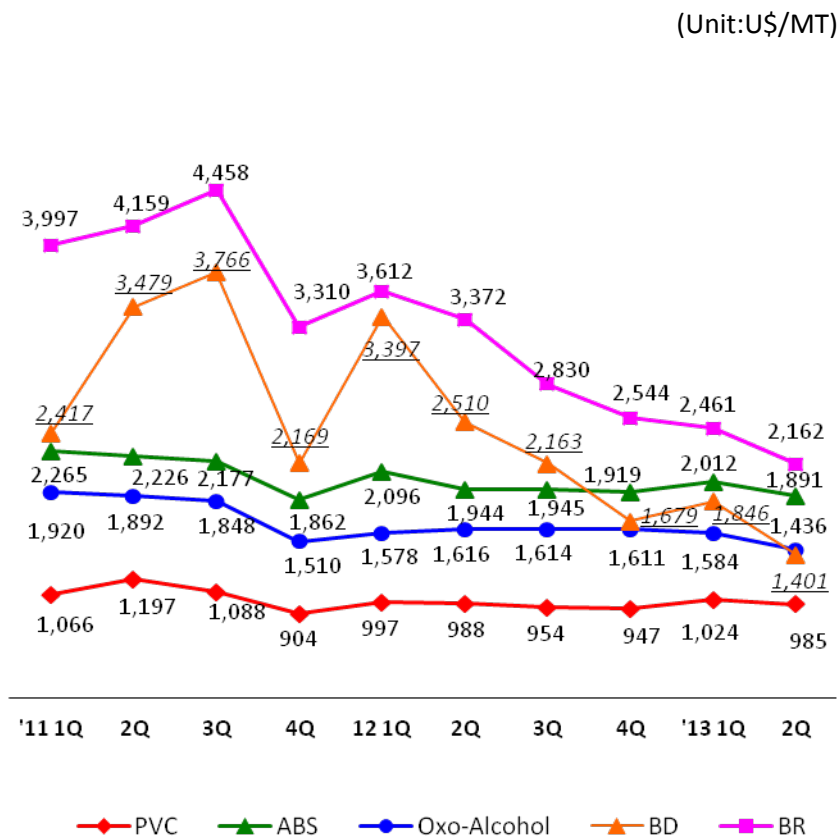

PVC

ABS/EP

Acrylate/
Plasticizer

Rubber/
Specialty Polymers

• The prices are average price of CFR FE Asia for general grade in each product group.

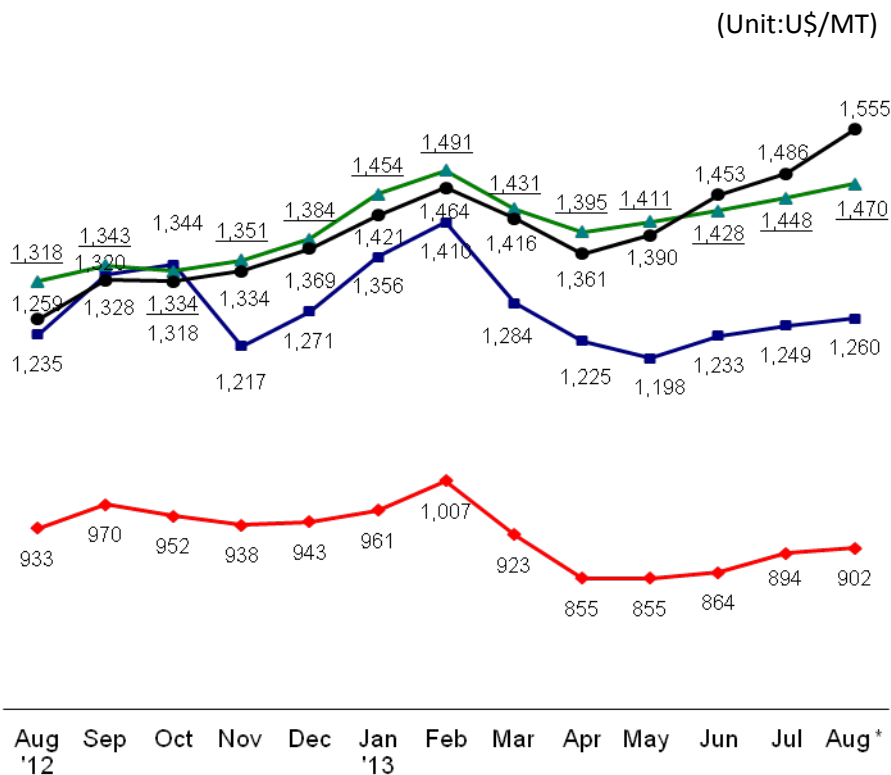

—●— Naphtha
 —■— Ethylene
 —▲— HDPE(Film)
 —●— LDPE

NCC/PO

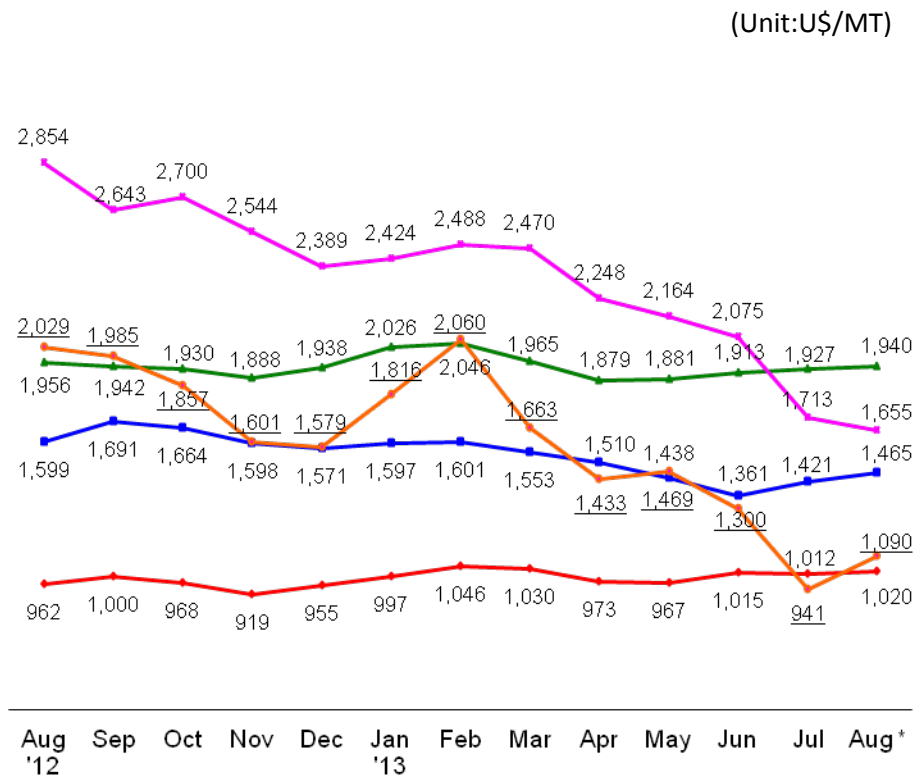

—●— PVC
 —▲— ABS
 —■— Oxo-Alcohol
 —■— BD
 —■— BR

PVC

ABS/EP

**Acrylate/
Plasticizer**

**Rubber/
Specialty Polymers**

• The prices are average price of CFR FE Asia for general grade in each product group.

* Shows the prices on August 9, 2013

As of 2nd quarter of 2013

	Item	Location	Capa	Global Rank	Capa Additions('13)
Petro-Chemicals	ABS (Acrylonitrile-Butadiene-Styrene)	Korea, China	1,390 KMT/Yr	1st*	
	PVC (Polyvinyl Chloride)	Korea, China	1,270 KMT/Yr	6th	
	Oxo-Alcohol	Korea (Yeosu, Naju)	299 KMT/Yr	10th	
	AA (Acrylic Acid)	Korea (Yeosu, Naju)	353 KMT/Yr	6th	
	PC (Polycarbonate)	Korea (Yeosu)	170 KMT/Yr	6th	
	BR (Butadiene Rubber)	Korea (Daesan)	180 KMT/Yr	7th	
	Elastomer	Korea (Daesan)	85 KMT/Yr	4th	
	SAP (Super Absorbent Polymer)	Korea (Gimcheon, Yeosu)	180 KMT/Yr	6th	
	MBS (Methacrylate-Butadiene-Styrene)	Korea (Yeosu)	50 KMT/Yr	4th	
	NBL (Acrylonitrile-Butadiene-Latex)	Korea (Yeosu)	100 KMT/Yr	2nd	
I & E Materials / Energy Solution	BPA (Bisphenol A)	Korea (Yeosu)	450 KMT/Yr	5th	[150 KMT/Yr added on Jan]
	Polarizer	Korea (Ochang)	117 mn m ² /Yr	1st	[20mn m ² /Yr add on '13]
	Consumer Battery (Lithium-ion)	Korea (Ochang)	93 mn cells/Month**	2nd	[5mn of Polymer add on 3Q]
	EV/HEV Battery (Lithium-ion)	Korea (Ochang)	130K Units/Yr***	1st	
	Color Filter Photoresists	Korea (Ochang)	-	2nd	
	3D FPR	Korea (Ochang)	-	1st	

* Actual Sales Base

** Cylindrical : 41 mn, Prismatic : 30 mn, Polymer : 22 mn

*** Convert to GM 'VOLT' base. U.S. Plant will start operating from 3Q.

Shareholders & Market Cap

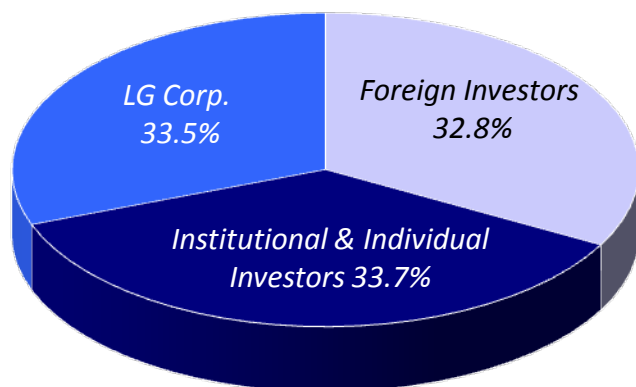

Common Stock as of Aug 12, 2013

(Unit : KRW)

	No. of Shares	Aug 12, '13	
		Price	Market Cap
Common	66,271,100	287,500	19.1 tn
Preferred	7,628,921	135,500	1.0 tn
Total	73,900,021		20.1 tn

Par value : KRW 5,000

Dividends

(Unit: KRW bn)

Classification	'11	'12	Change
Net Income	2,170	1,510	-30.41%
EPS(KRW)	29,360	20,384	-30.57%
Total Dividends	295*	295*	0
Dividend Payout Ratio	14.5%	20.4%	+5.9%p
Common Stock Price at year-end(KRW)	317,500	330,000	+12,500
Dividend Yield Ratio	1.3%	1.2%	-0.1%p

* Dividend of KRW 4,000 per common share