

IBM AIX Version 6.1 Differences Guide

**AIX - The industrial strength UNIX
operating system**

**AIX Version 6.1 enhancements
explained**

**An expert's guide to the
new release**

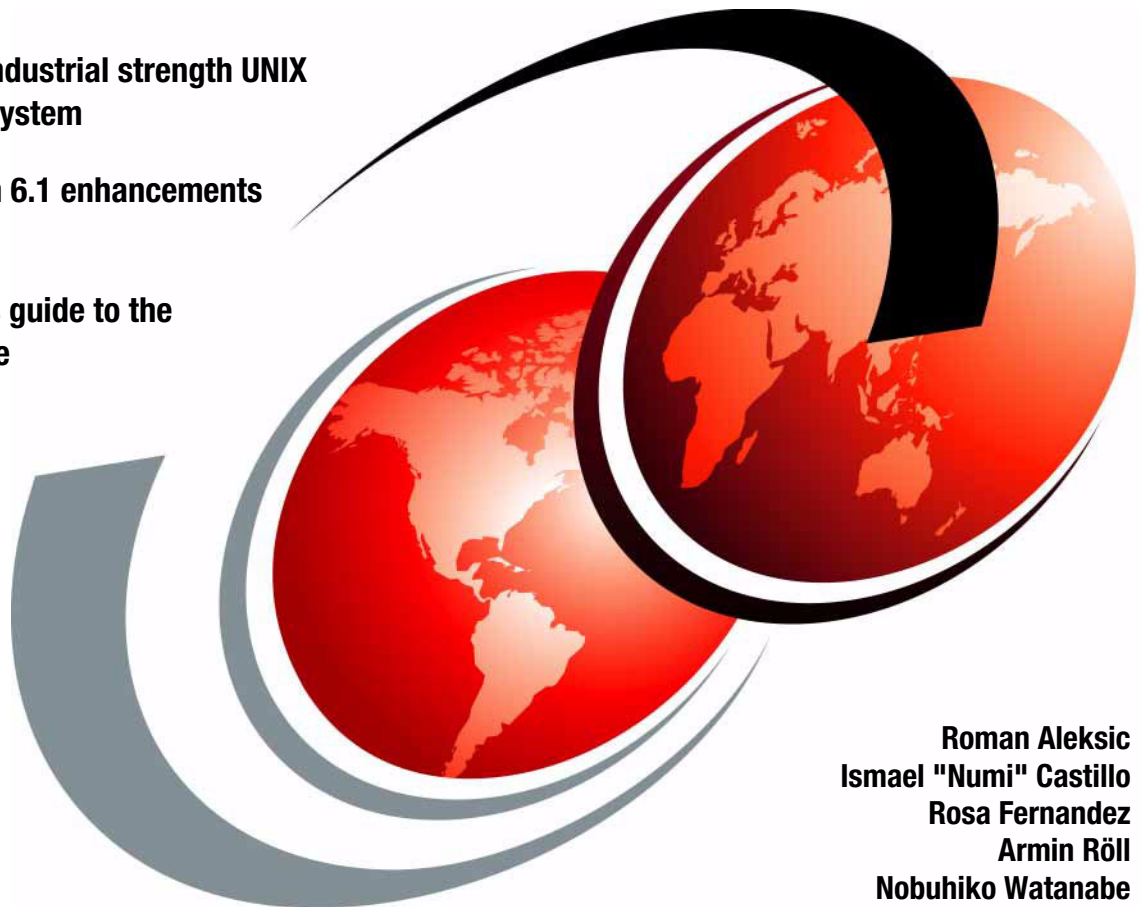

**Roman Aleksic
Ismael "Numi" Castillo
Rosa Fernandez
Armin Röhl
Nobuhiko Watanabe**



International Technical Support Organization

IBM AIX Version 6.1 Differences Guide

November 2007

Note: Before using this information and the product it supports, read the information in “Notices” on page xvii.

First Edition (November 2007)

This edition applies to AIX Version 6.1, program number 5765-G62.

© Copyright International Business Machines Corporation 2007. All rights reserved.

Note to U.S. Government Users Restricted Rights -- Use, duplication or disclosure restricted by GSA ADP Schedule Contract with IBM Corp.

Contents

Figures	xi
Tables	xiii
Notices	xvii
Trademarks	xviii
Preface	xix
The team that wrote this book	xix
Become a published author	xxi
Comments welcome	xxi
Chapter 1. Application development and system debug	1
1.1 Transport independent RPC library	2
1.2 AIX tracing facilities review	3
1.3 POSIX threads tracing	4
1.3.1 POSIX tracing overview	5
1.3.2 Trace event definition	7
1.3.3 Trace stream definition	13
1.3.4 AIX implementation overview	20
1.4 ProbeVue	21
1.4.1 ProbeVue terminology	23
1.4.2 Vue programming language	24
1.4.3 Probevue command	25
1.4.4 The probevctrl command	25
1.4.5 Vue: an overview	25
1.4.6 ProbeVue dynamic tracing example	31
Chapter 2. File systems and storage	35
2.1 Disabling JFS2 logging	36
2.2 JFS2 internal snapshot	36
2.2.1 Managing internal snapshots	37
2.2.2 Error handling	38
2.2.3 Considerations	39
2.3 Encrypted File System	40
2.3.1 Encryption	40
2.3.2 Keystore modes	41
2.3.3 File access permissions	42
2.3.4 Installation	42

2.3.5	Enable and create EFS file systems	44
2.3.6	File encryption and de-encryption	45
2.3.7	Encryption inheritance	48
2.3.8	Considerations	49
2.4	iSCSI target mode software solution	50
2.4.1	iSCSI software target considerations	50
2.4.2	SMIT interface	50
Chapter 3. Workload Partitions overview and resource management . . .		53
3.1	Overview	54
3.2	WPAR based system virtualization	55
3.3	Management tools	55
3.3.1	Packaging	56
3.4	System trace support	57
3.4.1	Overview	57
3.4.2	WPAR tracing capabilities	57
3.4.3	Trace WPAR filtering from the global environment	58
3.4.4	Trace report filtering from the Global environment	60
3.4.5	Tracing from within a WPAR	62
3.5	File system metrics support	63
3.6	Network metrics support	64
3.7	Performance tools updates for WPAR support	64
3.7.1	Updates for the curt command	65
3.7.2	Updates for the filemon command	67
3.7.3	Updates for the iostat command	70
3.7.4	Updates for the netpmn command	73
3.7.5	Updates for the pprof command	76
3.7.6	Updates for the procmon plug-in	78
3.7.7	Updates for the proctree command	79
3.7.8	Updates for the svmon command	81
3.7.9	Updates for the topas command	82
3.7.10	Updates for the tprof command	85
3.7.11	Updates for the vmstat command	87
3.8	Standard command updates for WPAR support	90
3.9	Network file system support for WPARs	94
3.9.1	Overview	94
3.9.2	NFS user interface	95
3.9.3	AutoFS user interface	96
3.9.4	CacheFS user interface	96
3.9.5	Continuous availability enhancements for NFS	97

Chapter 4. Continuous availability	99
4.1 Storage protection keys	100
4.2 Component trace and RTEC adoption	101
4.2.1 VMM component trace and RTEC adoption	105
4.2.2 AIX storage device driver component trace and RTEC support	109
4.2.3 Virtual SCSI device driver component trace and RTEC adoption	110
4.2.4 MPIO and RAS component framework integration	111
4.2.5 InfiniBand device driver component trace and RTEC support	112
4.2.6 LAN device driver component trace and RTEC support	114
4.2.7 Error level checking for TCP kernel and kernel extension	118
4.2.8 IPsec component trace exploitation	120
4.2.9 PCI device driver component trace adoption	120
4.2.10 Virtual bus device driver component trace adoption	122
4.2.11 Component trace for USB system driver	123
4.2.12 Component trace for USB audio	123
4.2.13 Component trace for 2D graphics device drivers	124
4.2.14 System loader run-time error checking	125
4.2.15 NFS and CacheFS run-time error checking	126
4.2.16 Run-time error checking for watchdog timer	128
4.2.17 System memory allocator adoption of run-time error checking	128
4.3 Dump Facilities	141
4.3.1 The dumpctrl command	143
4.3.2 Component Dump Facility	144
4.3.3 Live Dump Facility	148
4.3.4 System dump facility	155
4.4 Performing a live dump	163
4.5 Kernel error recovery	164
4.5.1 Recovery concepts	165
4.5.2 Kernel error recovery management	166
4.6 Concurrent update	169
4.6.1 Concurrent update method	170
4.6.2 The emgr command concurrent update operations	171
4.7 Core dump enhancements	174
4.8 I/O request tracking	175
4.9 Trace hook range expansion	176
4.10 LVM configuration and trace logs	177
4.10.1 LVM configuration log	178
4.10.2 LVM detailed trace configuration log	180
4.10.3 The gsvlmd daemon log	182

4.11	Group Services Concurrent LVM enhancements	184
4.12	Paging Space Verification	188
Chapter 5. System management		193
5.1	Web-based System Manager enhancements	194
5.1.1	The mknfsproxy and rmnfsproxy interfaces	194
5.1.2	Modified Web-based System Manager menus	198
5.2	AIX Print spooler redesign.	200
5.2.1	Spooler command changes	200
5.3	Increase default size of argument area.	201
5.4	Limit threads per process	203
5.4.1	Background	204
5.4.2	Implemented mechanisms	204
5.4.3	Implemented functions	204
5.4.4	Implemented changes.	205
5.4.5	How to configure these limits	206
5.5	Threading pthread default 1:1	209
5.6	RFC 2790 SNMP host resource groups	209
5.6.1	Running Software information group.	210
5.6.2	Running Software Performance information group.	211
5.7	IBM Systems Director Console for AIX	212
5.7.1	Packaging and requirements	212
5.7.2	The Layout of IBM Systems Director Console	215
5.7.3	My Start Pages (customization)	218
5.7.4	Health Summary plug-in	218
5.7.5	OS management.	218
5.7.6	Managing Workload Partitions	226
5.7.7	Settings	227
5.7.8	AIX security	228
5.7.9	Configuration and management	231
5.8	VMM dynamic variable page size	231
5.8.1	Variable page size concept	232
5.8.2	Page size promotion	233
5.8.3	The vmo command tunables.	234
5.8.4	The svmon command enhancements.	235
Chapter 6. Performance Management		239
6.1	Unique tunable documentation	240
6.2	Restricted tunables	241
6.2.1	New warning message for restricted tunables	242
6.2.2	New error log entry for restricted tunables	244
6.2.3	AIX V6 tunables lists	245

6.3	AIX V6 out-of-the-box performance	254
6.3.1	Virtual Memory Manager default tunables	255
6.3.2	AIX V6 enables I/O Pacing by default	257
6.3.3	AIX V6 new AIO dynamic tunables	257
6.3.4	NFS default tunables	263
6.4	Hardware performance monitors	263
6.4.1	Performance Monitor (PM)	264
6.4.2	Hardware Performance Monitor (HPM)	265
6.4.3	AIX V6.1 PM and HPM enhancements	266
	Chapter 7. Networking	271
7.1	Internet Group Management Protocol Version 3	272
7.2	Network Data Administration Facility enhancements	274
7.2.1	Integration of NDAF to the base AIX V6.1 distribution	275
7.2.2	NDAF commands	276
7.2.3	NDAF SMIT fastpaths	276
7.2.4	NDAF logs online information	276
7.2.5	NDAF data transfer methods	276
7.2.6	NDAF case study	277
7.3	Enabling SSL support for FTP	277
7.4	NFS proxy serving enhancements	278
7.4.1	NFS server proxy prerequisites	279
7.4.2	Comprehensive RPCSEC_GSS Kerberos support	280
7.4.3	NFSv3 exports for back-end NFSv4 exports	282
7.4.4	NFSv4 global namespace	283
7.4.5	Cachefs improvements	284
7.5	Network caching daemon	284
7.5.1	The netcd architecture	284
7.5.2	netcd AIX integration	286
7.5.3	netcd configuration	287
7.5.4	Managing netcd	289
7.6	IPv6 RFC compliances	291
7.6.1	RFC 4007 - IPv6 Scoped Address Architecture	292
7.6.2	RFC 4443 - Internet Control Message Protocol ICMPv6	292
	Chapter 8. Security, authentication, and authorization	293
8.1	/admin/tmp system directory	294
8.2	AIX Security Expert enhancements	296
8.2.1	Centralized policy distribution through ldap	296
8.2.2	User-defined policies	297
8.2.3	More stringent check for weak root passwords	297
8.2.4	Enabling Stack Execution Disable (SED)	300
8.2.5	File permission Manager (fpm) for managing SUID programs	300

8.2.6	Secure by Default	302
8.2.7	SOX-COBIT assistant	303
8.2.8	Performance enhancements for the graphical interface	305
8.3	Enhanced Role Based Access Control	305
8.3.1	Authorizations	307
8.3.2	Privileges	311
8.3.3	Roles	313
8.3.4	Summary of differences	315
8.4	Web-based GUI for RBAC	316
8.4.1	Tasks and roles	317
8.5	LDAP support enablement	319
8.6	RBAC and Workload Partition environments	321
8.7	Enhanced and existing mode switch	323
8.8	Trusted AIX	324
8.8.1	Introduction	325
8.8.2	Considerations	327
8.8.3	Identification and authentication	328
8.8.4	Discretionary access control	329
8.8.5	Role Based Access Control elements	331
8.8.6	Trusted AIX packages	335
8.8.7	Trusted AIX commands	336
8.9	Trusted Execution Environment	337
8.9.1	Trusted Signature Database	339
8.9.2	Trusted Execution	340
8.9.3	Trusted Execution Path, Trusted Library Path	342
8.10	Password length and encryption algorithms	343
8.10.1	Existing crypt()	343
8.10.2	Password hashing algorithms	344
8.10.3	Loadable Password Algorithm	344
8.10.4	Support greater than 8 character password	345
8.10.5	LPA configuration file	345
8.10.6	System password algorithm	345
8.10.7	Support more valid characters in passwords	347
8.10.8	Setup system password algorithm	347
8.10.9	Changes to support long password	348
	Chapter 9. Installation, backup, and recovery	353
9.1	AIX graphical installer	354
9.2	Network Install Manager NFSv4 support	357
9.2.1	NFSv4 NIM integration	358
9.2.2	NFSv4 Security Overview	360
9.2.3	RPCSEC_GSS Kerberos sample scripts	361
9.2.4	Considerations	364

Chapter 10. National language support	367
10.1 Azerbaijani locale support	368
10.1.1 Packaging and installation	368
10.1.2 Locale definitions, keyboard definition and input methods	371
10.2 Euro symbol support	374
10.3 Maltese locale support	377
10.3.1 Packaging and installation	378
10.3.2 Locale definitions, keyboard definition and input methods	380
10.4 Urdu India and Urdu Pakistan locale support	383
10.4.1 Packaging and installation	384
10.4.2 Locale definitions, keyboard definition and input methods	386
10.5 Welsh locale support	389
10.5.1 Packaging and installation	391
10.5.2 Locale definitions, keyboard definition and input methods	393
10.6 Olson time zone support	395
10.7 Unicode 5.0 support	399
10.8 International Components for Unicode	400
Chapter 11. Hardware and graphics support	403
11.1 Hardware support	404
11.2 Universal Font Scaling Technology Version 5	404
11.3 X Window System Version 11 Release 7.1	405
11.3.1 X11R5 / X11R6.1 / X11R7.1 compatibility issues	405
11.3.2 AIX V6.1 X Client enhancements	406
11.3.3 X11R5, X11R6 and X11R7.1 coexistence	406
11.4 32 TB physical memory support	407
11.5 Withdrawal of the 32-bit kernel	407
Appendix A. Transport-independent RPC	409
Appendix B. Sample script for tunables	419
Abbreviations and acronyms	423
Related publications	429
IBM Redbooks	429
Other publications	430
How to get Redbooks	430
Help from IBM	430
Index	433

Figures

1-1	POSIX trace system overview: online analysis	7
1-2	POSIX trace system overview: offline analysis	7
1-3	Structure of a Vue script	26
3-1	Multiple WPAR execution environments	55
3-2	SMIT trcstart fastpath menu options	59
3-3	SMIT panel for smitty trcrpt panel fast path option	61
3-4	Performance Workbench - Processes tab view	79
3-5	The topas command output in a WPAR environment	85
4-1	Component RAS Framework overview	101
4-2	Two dump frameworks, a unified user-interface: dumpctrl	143
4-3	Problem Determination SMIT panel	144
4-4	SMIT Panel to request change/show the dump component attributes	147
4-5	SMIT Panel to change/display Dump attribute for a component	148
4-6	SMIT Live dump panel: smitty ldmp	149
4-7	The freespc parameter and error log	152
4-8	SMIT Panel to change live dump attributes	153
4-9	Overview of all dump capabilities	159
4-10	SMIT panel: type of System Dump	160
4-11	SMIT panel : Traditional or Firmware-assisted dump	160
4-12	SMIT panel: Change the Full Memory Mode	161
4-13	SMIT panel: Types of memory dump mode	162
4-14	SMIT Panel: Starting a live dump	164
4-15	Kernel recovery process	165
4-16	Concurrent in memory update high level overview	171
4-17	Core dump UID / GID dependencies	174
5-1	Proxy Server menus	195
5-2	Create Proxy Server dialog	197
5-3	Remove Proxy Server dialog	198
5-4	Example of Show Restricted Parameters	199
5-5	IBM Systems Director Console for AIX Welcome page	214
5-6	Console toolbar	215
5-7	Navigation area	216
5-8	Page bar	216
5-9	Portlets	217
5-10	Distributed Command Execution Manager menu	222
5-11	Target Specification Tab	224
5-12	Option Tab	225
5-13	System Management Interface Tools Menu	226

5-14	Mixed page size memory segment used by VPSS	233
6-1	SMIT panel for AIX Version 6.1 Restricted Tunables	242
7-1	NFS proxy serving enhancements	279
8-1	Management environment tasks	298
8-2	Root Password Integrity Check interface	299
8-3	Enable SED Feature Interface	300
8-4	File Permissions Manager Interface on AIX Security Expert	301
8-5	Sox-Cobit Rules Interface	304
8-6	Enhanced RBAC Framework on AIX V6.1.	307
8-7	Authorizations concept	307
8-8	Authorization hierarchy	310
8-9	Concept of privileges.	311
8-10	Concept of roles	314
8-11	IBM Systems Director Console for AIX and RBAC modules.	316
8-12	Web-Base GUI Component with RBAC	317
8-13	RBAC and Workload Partition Framework	322
8-14	Kernel Authorization Tables mapping for Workload Partitions	323
8-15	System integrity check	341
8-16	Runtime integrity check.	342
9-1	AIX graphical installer welcome and installation language selection	355
9-2	AIX graphical installer installation type selection screen.	356
9-3	AIX graphical installer summary and AIX language selection screen.	357
10-1	The flag of the Republic of Azerbaijan	368
10-2	Azerbaijani letters	368
10-3	Set Primary Language Environment® installation menu.	370
10-4	The flag of the European Union	374
10-5	The flag of the Republic of Malta	377
10-6	Maltese letters	378
10-7	Set Primary Language Environment installation menu	379
10-8	Republic of India and Islamic Republic of Pakistan flags	383
10-9	Some examples of Urdu characters	383
10-10	SMIT menu to add Urdu national language support for India	386
10-11	The Welsh flag	389
10-12	Welsh alphabet	390
10-13	Set Primary Language Environment installation menu	392
10-14	SMIT menu to select country or region for Olson time zone	398
10-15	SMIT menu to select the time zone for a given country or region.	399

Tables

1-1	User trace event routines used by the instrumented code	8
1-2	Defined User trace event	9
1-3	System trace events names	10
1-4	Trace event sets routines used by instrumented code	11
1-5	Predefined system trace event sets	11
1-6	Filter management routines on trace stream	12
1-7	Management trace events routines used by controller and analyzer	12
1-8	Retrieval trace events routines used by the analyzer process	13
1-9	Default values for trace stream attributes	17
1-10	Setting trace stream attribute routines used by the controller process	17
1-11	Retrieval trace stream attribute routines used by controller and analyzer	18
1-12	Trace stream attributes and state routines	19
1-13	Trace stream control routines used by the trace controller process	19
1-14	Trace stream control routines used by the trace analyzer process	20
2-1	Comparison of external and internal snapshots	37
2-2	New EFS commands	43
2-3	Commands modified for EFS	43
3-1	WPAR management options	56
3-2	New trace command WPAR filtering options	58
3-3	New trace fields for WPAR smitty trcstart panel	60
3-4	New trcrpt command WPAR filtering options	60
3-5	New trace report filtering fields for WPAR in the smitty trcrpt panel	62
3-6	Option changes for curt command	66
3-7	Option changes for filemon command	67
3-8	Option changes for iostat command	70
3-9	Option changes for netpmon command	74
3-10	Option changes for pprof command	77
3-11	Option changes for proctree command	80
3-12	Option changes for svmon command	81
3-13	Option changes for topas command	83
3-14	Option changes for tprof command	86
3-15	Option changes for vmstat command	88
3-16	Command updates for WPAR support	90
4-1	AIX storage device driver base component names	109
4-2	System loader RAS components	126
4-3	Dump detail level and component dump data size limit	150
4-4	Live dump heap size limits	151
4-5	Live dump attributes and defaults	154

4-6	Live dump attributes and persistence	154
4-7	System dump attributes and defaults	156
4-8	System dump attributes and persistence	157
4-9	Kernel error recovery error log entries	166
4-10	raso tunables for kernel error recovery	168
4-11	New interim fix states displayed with the emgr command	173
4-12	gsclvmd error labels	185
4-13	:Maximum paging space size	188
5-1	Create Proxy Server dialog	196
5-2	Remove Proxy Server dialog	197
5-3	list of resource names and task names and menus	199
5-4	AIX Thread environment valuables	209
5-5	OS management tasks	218
5-6	Distributed command execution manager helloworld example	221
5-7	Target specification input	223
5-8	AIX and POWER page size support	231
5-9	vmo vmm_mpsize_support tunable	235
6-1	Default tunable values for the vmo command	256
6-2	minpout/maxpout values within AIX releases	257
6-3	Values range for each AIO subsystem tunables	262
7-1	NFS protocol support for NFS proxy serving	282
7-2	New netcd files	286
7-3	Caching settings in /etc/netcd.conf	288
7-4	netcd daemon settings	289
7-5	netcd logging levels	291
8-1	File lists for enhanced RBAC facility	305
8-2	Authorization on AIX V5.3	307
8-3	Top Level authorization on AIX V6.1	309
8-4	Maps for authorization from AIX V5.3 to AIX V6.1	310
8-5	List of roles provided by default on AIX V5.3	314
8-6	List of roles provided by default on AIX V6.1	315
8-7	Differences summary between AIX V5.3 and AIX V6.1	315
8-8	Task Console Role, and Authorization map	318
8-9	Trusted AIX Authorizations	332
8-10	Relations between Authorizations and Roles	333
8-11	Filesets installed in Trusted AIX environment	336
8-12	Algorithms and their characteristics	346
8-13	Summary of changes to userpw.h	348
8-14	Maximum size in the current configuration of the system	349
8-15	Password policy attributes	350
9-1	New NIM NFS attributes	358
9-2	AUTH_SYS and RPCSEG_GSS Kerberos differences	361
10-1	New and enhanced AIX V6.1 locales in support of the Euro currency	375

10-2	New and modified AIX keyboards for Euro symbol support	376
11-1	TI-RPC client and server interfaces	410

Notices

This information was developed for products and services offered in the U.S.A.

IBM may not offer the products, services, or features discussed in this document in other countries. Consult your local IBM representative for information on the products and services currently available in your area. Any reference to an IBM product, program, or service is not intended to state or imply that only that IBM product, program, or service may be used. Any functionally equivalent product, program, or service that does not infringe any IBM intellectual property right may be used instead. However, it is the user's responsibility to evaluate and verify the operation of any non-IBM product, program, or service.

IBM may have patents or pending patent applications covering subject matter described in this document. The furnishing of this document does not give you any license to these patents. You can send license inquiries, in writing, to:
IBM Director of Licensing, IBM Corporation, North Castle Drive, Armonk, NY 10504-1785 U.S.A.

The following paragraph does not apply to the United Kingdom or any other country where such provisions are inconsistent with local law: INTERNATIONAL BUSINESS MACHINES CORPORATION PROVIDES THIS PUBLICATION "AS IS" WITHOUT WARRANTY OF ANY KIND, EITHER EXPRESS OR IMPLIED, INCLUDING, BUT NOT LIMITED TO, THE IMPLIED WARRANTIES OF NON-INFRINGEMENT, MERCHANTABILITY OR FITNESS FOR A PARTICULAR PURPOSE. Some states do not allow disclaimer of express or implied warranties in certain transactions, therefore, this statement may not apply to you.

This information could include technical inaccuracies or typographical errors. Changes are periodically made to the information herein; these changes will be incorporated in new editions of the publication. IBM may make improvements and/or changes in the product(s) and/or the program(s) described in this publication at any time without notice.

Any references in this information to non-IBM Web sites are provided for convenience only and do not in any manner serve as an endorsement of those Web sites. The materials at those Web sites are not part of the materials for this IBM product and use of those Web sites is at your own risk.

IBM may use or distribute any of the information you supply in any way it believes appropriate without incurring any obligation to you.

Any performance data contained herein was determined in a controlled environment. Therefore, the results obtained in other operating environments may vary significantly. Some measurements may have been made on development-level systems and there is no guarantee that these measurements will be the same on generally available systems. Furthermore, some measurement may have been estimated through extrapolation. Actual results may vary. Users of this document should verify the applicable data for their specific environment.

Information concerning non-IBM products was obtained from the suppliers of those products, their published announcements or other publicly available sources. IBM has not tested those products and cannot confirm the accuracy of performance, compatibility or any other claims related to non-IBM products. Questions on the capabilities of non-IBM products should be addressed to the suppliers of those products.

This information contains examples of data and reports used in daily business operations. To illustrate them as completely as possible, the examples include the names of individuals, companies, brands, and products. All of these names are fictitious and any similarity to the names and addresses used by an actual business enterprise is entirely coincidental.

COPYRIGHT LICENSE:

This information contains sample application programs in source language, which illustrate programming

techniques on various operating platforms. You may copy, modify, and distribute these sample programs in any form without payment to IBM, for the purposes of developing, using, marketing or distributing application programs conforming to the application programming interface for the operating platform for which the sample programs are written. These examples have not been thoroughly tested under all conditions. IBM, therefore, cannot guarantee or imply reliability, serviceability, or function of these programs.

Trademarks

The following terms are trademarks of the International Business Machines Corporation in the United States, other countries, or both:

Redbooks (logo) ®

AIX 5L™

AIX®

Blue Gene®

DPI®

Enterprise Storage Server®

Everyplace®

General Parallel File System™

Geographically Dispersed

Parallel Sysplex™

GDPS®

GPFS™

HACMP™

IBM®

Language Environment®

OS/2®

Parallel Sysplex®

PowerPC®

POWER™

POWER3™

POWER4™

POWER5™

POWER5+™

POWER6™

PTX®

Redbooks®

System p™

System x™

System Storage™

Tivoli®

WebSphere®

Workload Partitions Manager™

The following terms are trademarks of other companies:

Oracle, JD Edwards, PeopleSoft, Siebel, and TopLink are registered trademarks of Oracle Corporation and/or its affiliates.

CacheFS, Java, ONC+, Solaris, and all Java-based trademarks are trademarks of Sun Microsystems, Inc. in the United States, other countries, or both.

Internet Explorer, Windows, and the Windows logo are trademarks of Microsoft Corporation in the United States, other countries, or both.

UNIX is a registered trademark of The Open Group in the United States and other countries.

Linux is a trademark of Linus Torvalds in the United States, other countries, or both.

Other company, product, or service names may be trademarks or service marks of others.

Preface

This IBM® Redbook focuses on the differences introduced in IBM AIX® Version 6.1 when compared to AIX 5L™ Version 5.3. It is intended to help system administrators, developers, and users understand these enhancements and evaluate potential benefits in their own environments.

AIX Version 6.1 introduces many new features, including workload partitions, advanced security, continuous availability and managing and monitoring enhancements. There are many other new features available with AIX Version 6.1, and you can explore them all in this publication.

For clients who are not familiar with the enhancements of AIX through Version 5.3, a companion publication, AIX 5L Differences Guide Version 5.3 Edition, SG24-7463 is available, along with an addendum SG24-7414 that includes between release enhancements available through applying service updates.

The team that wrote this book

This book was produced by a team of specialists from around the world working at the International Technical Support Organization, Austin Center.

Roman Aleksic is a System Engineer working for Zürcher Kantonalbank, a major bank in Switzerland. He has seven years of experience with IBM System p and AIX in the fields of application integration, performance management, TCP/IP networking, logical partitioning, and advanced shell scripting. He also implements and supports large HACMP™ and NIM environments.

Ismael "Numi" Castillo is an IBM Senior IT Specialist and Technical Consultant for the IBM ISV Business Strategy and Enablement organization. He has 3 years of experience in AIX performance tuning and benchmarks. He has 19 years of professional experience in IT with a background in software development, consulting, system performance measurement and tuning, benchmarking, problem determination, and sizing. He is also the team leader for the IBM ISV BSE technical collateral team. Numi completed studies for a Bachelor Degree in Computer Science at the Catholic University of Santo Domingo in Dominican Republic. He also holds several advanced levels industry certifications..

Rosa Fernandez is a Certified Advanced AIX Expert, and an IBM IT Certified professional who joined IBM France in 1990. She holds a Masters degree in

Computer Science from Tours University (1985) and is an AIX pre-sales leader since 1996. She is recognized for the management of customer satisfaction, AIX performance delivery, UNIX® software migration, and is incremental in creating and supporting the AIX French User Group. She co-authored the *AIX 64-bit Performance in Focus*, SG24-5103 publication.

Armin Röhl works as a System p™ IT specialist in Germany. He has twelve years of experience in System p and AIX pre-sales technical support and, as a teamleader, he fosters the AIX skills community. He holds a degree in experimental physics from the University of Hamburg, Germany. He co-authored the AIX Version 4.3.3, the AIX 5L Version 5.0, and the AIX 5L Version 5.3 Differences Guide IBM Redbooks®.

Nobuhiko Watanabe is an advisory IT specialist and team leader of the System p and AIX division of IBM Japan Systems Engineering that provides the ATS function in Japan. He has 16 years of experience in the AIX and Linux® fields. He holds a Bachelor degree in Library and Information science from the Kieo University. His areas of expertise also include Solaris™ and HP-UX.

The project that produced this publication was managed by:
Scott Vetter, PMP

Thanks to the following people for their contributions to this project:

Janet Adkins, Dwip N Banerjee, Paul Bostrom, David Bradford, Carl Burnett, David Clissold, Julie Craft, Matthew Cronk, Prakash Desai, Saurabh Desai, Frank Feuerbacher, Matthew Fleming, Arnold Flores, Kevin Fought, Eric P Fried, Jan Harris, David A. Hepkin, Duen-wen Hsiao, Praveen Kalamegham, Jay Kruemcke, Ashley D. Lai, Su Liu, Yantian Lu, Michael Lyons, Marshall McMullen, Dan McNichol, Camilla McWilliams, Bruce Mealey, Dirk Michel, Grover Neuman, Frank L Nichols, Frank O'Connell, Michael Panico, Lance Russell, Jim Shaffer, Ravi A. Shankar, David Sheffield, Luc Smolders, Donald Stence, Marc Stephenson, Marvin Toungate, Murali Vaddagiri, Venkat Venkatsubra, Xinya Wang, Suresh Warriar, Ken Whitmarsh, Jonathan A Wildstrom

IBM AIX Development, Austin TX

Arun P Anbalagan, Tejas N Bhise, Abhidnya P Chirmule, Madhusudanan Kandasamy, Neeraj Kumar Kashyap, Manoj Kumar, Mallesh Lepakshaiah, Pruthvi Panyam Nataraj, G Shantala

IBM AIX Development, India

David Larson

IBM Hypervisor Development, Rochester MN

Francoise Boudier, Bernard Cahen, Damien Faure, Matthieu Isoard, Jez Wain
Bull, France

Bruno Blanchard, Thierry Fauck, Philippe Hermes, Emmanuel Tetreau
IBM France

Bernhard Buehler
IBM Germany

Liviu Rosca
IBM Romania

Become a published author

Join us for a two- to six-week residency program! Help write a book dealing with specific products or solutions, while getting hands-on experience with leading-edge technologies. You will have the opportunity to team with IBM technical professionals, Business Partners, and Clients.

Your efforts will help increase product acceptance and customer satisfaction. As a bonus, you will develop a network of contacts in IBM development labs, and increase your productivity and marketability.

Find out more about the residency program, browse the residency index, and apply online at:

ibm.com/redbooks/residencies.html

Comments welcome

Your comments are important to us!

We want our books to be as helpful as possible. Send us your comments about this book or other IBM Redbooks in one of the following ways:

- ▶ Use the online **Contact us** review Redbooks form found at:

ibm.com/redbooks

- ▶ Send your comments in an e-mail to:

redbooks@us.ibm.com

- ▶ Mail your comments to:

IBM Corporation, International Technical Support Organization
Dept. HYTD Mail Station P099
2455 South Road
Poughkeepsie, NY 12601-5400



1

Application development and system debug

This chapter contains the major AIX Version 6.1 enhancements that are part of the application development and system debug category, including:

- ▶ “Transport independent RPC library” on page 2
- ▶ “AIX tracing facilities review” on page 3
- ▶ “POSIX threads tracing” on page 4
- ▶ “ProbeVue” on page 21

1.1 Transport independent RPC library

The Open Network Computing Plus (ONC+™) distributed computing environment consists of a family of technologies, services, and tools including the transport-independent remote procedure call (TI-RPC) API library that provides a distributed application development environment by isolating applications from any specific transport feature. The TI-RPC implementation supports threaded applications and utilizes streams as an interface to the network layer.

Previous AIX releases internally use a comprehensive subset of the TI-RPC API to provide base operating system features, namely the Network File System (NFS) services. In that context, but not limited to it, the AIX operating system also facilitates the RPCSEC_GSS security version of the General Security Services (GSS) API to enable advanced security services. For example, the RPCSEC_GSS routines are used by the AIX Network Data Administration Facility (NDAF).

AIX V6.1 now formally supports the AIX base operating system related subset of the TI-RPC routines as ported from the ONC+ 2.2 source distribution. The code is exported by the network services library (libnsl.a) which is installed by default on any AIX V6.1 system through the bos.net.tcp.client fileset. Additionally, the RPCSEC-GSS security services interface routines are now formally supported and documented in the AIX V6.1 product documentation.

TI-RPC APIs are classified into different levels. These levels provide different degrees of control balanced with different amounts of interface code to implement, in order of increasing control and complexity. The top level classification defines two distinct routine classes:

- ▶ Simplified interface routines
- ▶ Standard interface routines

The simplified interface routines specify the type of transport to use. Applications using this level do not have to explicitly create handles.

The standard interface routines give a programmer much greater control over communication parameters such as the transport being used, how long to wait before responding to errors and retransmitting requests, and so on.

The standard interface routines are further classified as follows:

Top-level routines These APIs allow the application to specify the type of transport.

Intermediate-level routines	These APIs are similar to the top-level APIs, but the user applications select the transport specific information using network selection APIs.
Expert-level routines	These APIs allow the application to select which transport to use. These APIs are similar to the intermediate-level APIs with an additional control that is provided by using the name-to-address translation APIs.
Bottom-level routines	The bottom level contains routines used for full control of transport options.
Other routines	These APIs allow the various applications to work in coordination with the simplified, top-level, intermediate-level, and expert-level APIs.

The AIX v6.1 TI-RPC interface routines listed by classification level are documented in the Transport Independent Remote Procedure Call section of Chapter 8, “Remote Procedure Calls” in *AIX Version 6.1 Communication Programming Concepts*, SC23-5258.

1.2 AIX tracing facilities review

AIX Version 6 has several tracing facilities available:

AIX system trace This is the main trace facility on AIX. It supports tracing both applications and the kernel.

The AIX system trace facility is designed for tracing inside the kernel and kernel extensions. However, it also supports user-defined tracing in application code. It is based on compiled-in static trace hooks and is only enabled when needed. By default, all trace hooks are enabled when tracing is turned on. However, there are options to enable only a set of trace hooks or to disable some specific trace hooks. Both user and kernel tracing share the same system buffers. So, the application-level trace data is copied to the system buffer.

Lightweight memory trace

Lightweight memory trace (LMT) traces only key AIX kernel events and is not available in user mode. LMT is also based on compiled-in static trace hooks. It is enabled by default, but it uses a lightweight mechanism to record trace data, so the performance impacts are minimal. The trace data is sent to per-CPU buffers and stays in memory

until overwritten. There are commands to extract the traced data, and it is displayed using the same tools as AIX system trace. Alternatively, it can also be displayed with the **kdb** command or extracted from a system dump.

truss

Truss is a tracing mechanism that allows tracing of all system calls and optionally all library calls executed by a specific process. So, traced events are limited to system subroutines calls. Trace output consists of the parameters passed into and the values returned from each system (and library) call. This is directly sent to standard error of that process. There is no mechanism to save the trace data and there are no system-wide buffers.

Component trace facility

Component trace (CT) is a new tracing facility that became available in AIX starting AIX 5.3 TL06. The component tracing facility can be used as an additional filter on AIX system trace. It can also be used to provide exclusively in-memory tracing, directed to use either system-wide LMT buffers, or component-specific buffers to save the trace data. Its primary purpose, similar to LMT, is for collecting First Failure Data Capture data for debugging purposes.

POSIX trace

AIX Version 6 implements the POSIX trace system that support tracing of user applications. The POSIX tracing facilities allow a process to select a set of trace event types to activate a trace stream of the selected trace events as they occur in the flow of execution and to retrieve the recorded trace events. Similar to system trace, POSIX trace is also dependent upon precompiled-in trace hooks in the application being instrumented.

1.3 POSIX threads tracing

POSIX (Portable Operating System Interface) is a registered trademark of the IEEE (Institute of Electrical and Electronics Engineers). POSIX is simultaneously an IEEE standard, an ISO/IEC Standard, and an Open Group Technical standard.

All standards are subject to revision. For the most accurate information about this standard, visit the following Web site:

<http://www.opengroup.org/onlinepubs/009695399/mindex.html>

POSIX defines a standard operating system interface and environment and it is also referenced as IEEE Std 1003.1-2001 that has been approved by the Open Group under the name of "Single UNIX¹ Specification (version 3)". POSIX is drawn from the base documents:

- ▶ The IEEE Std 1003.1-1996 (POSIX-1) incorporating IEEE standards 1003.1-1990, 1003.1b-1993, 1003.1c-1995, and 1003.1i-1995
- ▶ The following amendments to the POSIX.1-1990 standard:
 - IEEE P1003.1a draft standard (additional system services)
 - IEEE Std 1003.1d.1999 (additional Real-time extensions)
 - IEEE Std 1003.1g.2000 (Protocol Independent Interface (PII))
 - IEEE Std 1003.1j.2000 (advanced Real-time Extensions)
 - IEEE Std 1003.1q.2000 (Tracing)
- ▶ The IEEE Std 1003.2-1992 (POSIX-2) incorporating IEEE standards 1003.2a-1992
- ▶ The following amendment to the POSIX-2:1993 standard:
 - IEEE P1003.2b draft standard (additional utilities)
 - IEEE Std 1003.2d.1994 (batch environment)
- ▶ The Open Group Technical Standard, February 1997, the Base Specification (XBD5, XCU5 and XSH5 sections)
- ▶ The Open Group Technical Standard, January 2000, Networking Services (section XNS5.2)
- ▶ The ISO/IEC 9899:1999, Programming Languages - C

AIX Version 6 implements the Tracing Option Group, which is an optional function, defined within IEEE Std 1003.1-2001.

1.3.1 POSIX tracing overview

This section provides an overview of the POSIX tracing facilities as implemented within AIX in the newly POSIX trace library (libposixtrace.a).

The main purposes of tracing are:

- ▶ Application debugging during the development stage if the source code is pre-instrumented

¹ UNIX is a registered trademark of The Open Group

- ▶ Fault analysis to discover a problem afterwards based on flight recorded data
- ▶ A performance measurement tool to check code efficiency

The POSIX trace model is based on two main data types:

trace event	The execution flow of the traced process generates information relative to the program step or action being executed. This program step or action is named a <i>trace point</i> , and the traced information a <i>trace event</i> . The recorded trace event is contained in the <code>posix_trace_event_info</code> structure, defined in the <code>/usr/include/trace.h</code> include file.
trace stream	The collection of traced information must be kept, in order to be analyzed, in a place named a <i>trace stream</i> that is created for this traced process. It is not mandatory that the traced process creates itself its associated trace stream. A <i>trace stream identifier</i> is returned by the trace stream creation routines and is valid only for the process that made the creation subroutine call. The <i>trace stream identifier</i> (<code>trid</code>) is a <code>trace_id_t</code> type defined in the <code>/usr/include/sys/types.h</code> include file. When an offline analysis is required, a <i>trace log</i> can be associated with the trace stream.

The POSIX tracing operation relies on three logically different entities:

traced process	The process for which trace events are recorded is named the <i>traced process</i> . It is the instrumented code.
controller process	The controller process controls the recording of the trace events into the trace stream. Thus, the controller is in charge to initialize and create the stream, start and stop the tracing, manage the mapping between trace streams and traced processes, and to shut the trace stream down.
analyzer process	The analyzer process retrieves the traced events either at runtime from the trace stream, or at the end of execution as an analysis from a <i>trace pre-recorded stream</i> whose content has been obtained reloading the trace stream log.

The Figure 1-1 on page 7 shows the POSIX trace system overview for online analysis.

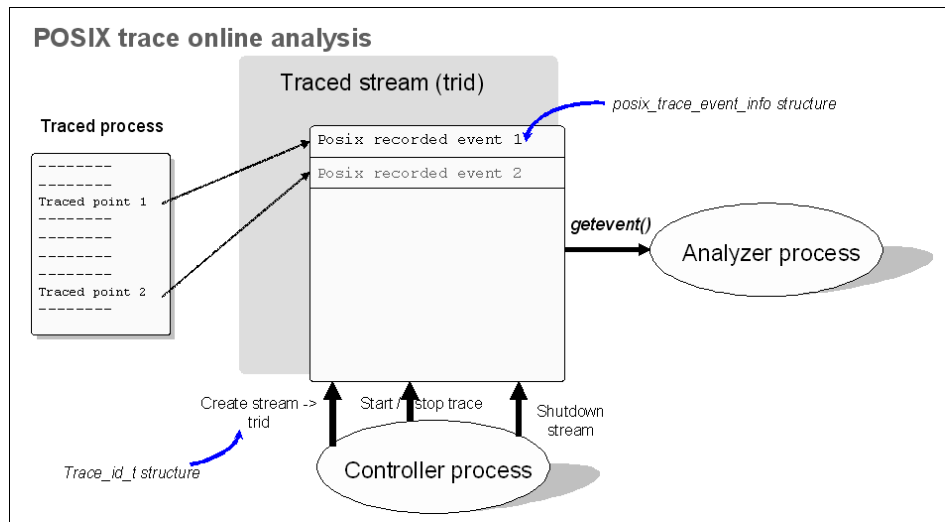

Figure 1-1 POSIX trace system overview: online analysis

Figure 1-2 shows the POSIX trace system overview for offline analysis.

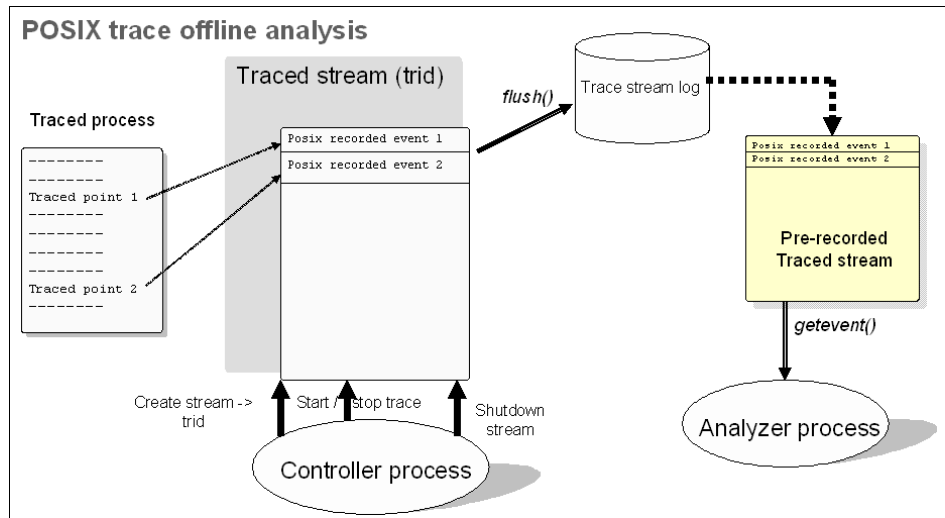

Figure 1-2 POSIX trace system overview: offline analysis

1.3.2 Trace event definition

Each event is identified by a *trace name* and a *trace event identifier* (an internal reference), defined as the `trace_event_id_t` type in the `/usr/include/sys/types.h`

header file. It has also an associated name returned by the subroutine `posix_trace_eventid_get_name()`.

The event name length in number of characters must be less than `TRACE_EVENT_NAME_MAX` (defined in the `/usr/include/sys/types.h` header file).

Trace events belong to two classes, namely:

user trace events Defined and generated by the traced process.

system trace events Defined and generated by the operating system.

User trace events

Each traced process has to define the mapping of the trace event names to trace event identifiers, achieved by calling the `posix_trace_eventid_open()` subroutine. This subroutine returns a unique trace event identifier to be used on the trace stream. Therefore, the mapping between user event types and user event names are private to the instrumented code and they last only during execution time.

The instrumented code uses this user trace identifier to set a traced point calling the `posix_trace_event()` subroutine. The execution of a traced point generates a trace event if the trace stream is created, started, and if this traced event identifier is not ignored by filtering (see section “Trace stream filtering” on page 11).

Table 1-1 lists the subroutines to define a user trace event and to implement a trace point by an instrumented code.

Table 1-1 User trace event routines used by the instrumented code

Purpose	Subroutine name
Trace subroutine for instrumenting application code	<code>posix_trace_eventid_open()</code>
Trace subroutines for implementing a trace point	<code>posix_trace_event()</code>

A predefined user trace event exists if the limit of per-process user trace event names (`TRACE_USER_EVENT_MAX` constant) has been reached. Then this user trace event is returned indicating that the instrumented application is registering more events than allowed.

Note: By default, the instrumented code can define a number of user trace events up to the value of `_POSIX_TRACE_USER_EVENT_MAX`, constant defined in the file `/usr/include/sys/limits.h`.

If the limit of the per-process user trace event defined in `TRACE_USER_EVENT_MAX` (`/usr/include/sys/limits.h`) has been reached, the `POSIX_TRACE_UNNAMED_USEREVENT` (`/usr/include/trace.h`) trace event identifier is returned indicating that no more event mapping is available for the instrumented application.

Table 1-2 provides the predefined user trace event, defined in the `/usr/include/trace.h` include file.

Table 1-2 Defined User trace event

Event ID-Constant	Event name
<code>POSIX_TRACE_UNNAMED_USEREVENT</code>	<code>posix_trace_unnamed_userevent</code>

The following program abstract demonstrates two user trace events names (EV001: snow call, EV002: white call) mapped with two trace event type identifiers to trace snow and white subroutine calls. Trace points use the user trace event data to differentiate the different calls done to the same subroutine.

```
#include /usr/include/sys/types.h
#include /usr/include/trace.h
{
    int ret;
    trace_event_id_t eventid1, eventid2;
    char * data_ptr;
    size_t data_len;
    ... lines omitted for clarity
    /* Definition of user trace events */
    ret=posix_trace_eventid_open("EV001: snow call",&eventid1);
    ret=posix_trace_eventid_open("EV002: white call",&eventid2);
    ... lines omitted for clarity
    /* Trace point EV001: snow call */
    data_ptr="waking up";
    data_len=strlen(data_ptr);
    ret=posix_trace_event(eventid1,data_ptr,data_len);
    ret=snow(1);
    ... lines omitted for clarity
    /* Trace point EV002: white call*/
    data_ptr="laundry white";
    data_len=strlen(data_ptr);
```

```

        ret=posix_trace_event(eventid2,data_ptr,data_len);
        ret=white(3);
... lines omitted for clarity
/* Trace point EV001: snow call */
        data_ptr="sleeping well";
        data_len=strlen(data_ptr);
        ret=posix_trace_event(eventid1,data_ptr,data_len);
        ret=snow(0);
... lines omitted for clarity
return 0;
}

```

System trace events

The system trace events include a small set of events to correctly interpret the trace event information present in the stream.

Table 1-3 provides the names of defined system trace events.

Table 1-3 System trace events names

Event ID-Constant	Event name
POSIX_TRACE_ERROR	posix_trace_error
POSIX_TRACE_START	posix_trace_start
POSIX_TRACE_STOP	posix_trace_stop
POSIX_TRACE_FILTER	posix_trace_filter
POSIX_TRACE_OVERFLOW	posix_trace_overflow
POSIX_RESUME	posix_trace_resume
POSIX_TRACE_FLUSH_START	posix_trace_flush_start
POSIX_TRACE_FLUSH_STOP	posix_trace_flush_stop

Note: All system trace events identifiers are defined in the `/usr/include/trace.h` include file.

Trace event sets

The events can be gathered in a set. A set allows you to define which events may be ignored during tracing.

The event set is a `trace_event_set_t` object. This object must be initialized either by the `posix_trace_eventset_empty()` or `posix_trace_eventset_fill()` subroutine.

This event set, as an object, can be only manipulated by specific routines, as described in Table 1-4.

Table 1-4 Trace event sets routines used by instrumented code

Purpose	Subroutine name
Add a trace event type in a trace event type set	posix_trace_eventset_add()
Delete a trace event type from a trace event type set	posix_trace_eventset_del()
Empty a trace event type set	posix_trace_eventset_empty()
Fill in a trace event type set	posix_trace_eventset_fill()
Test if the trace event type is included in the trace event type set	posix_trace_eventset_ismember()

There are predefined sets of system trace events as described in Table 1-5.

Table 1-5 Predefined system trace event sets

Event Set ID	Description
POSIX_TRACE_WOPID_EVENTS	It includes all process independent trace event types.
POSIX_TRACE_SYSTEM_EVENTS	It includes all system trace events but no AIX kernel events can be traced. It is limited to the available POSIX system trace events.
POSIX_TRACE_ALL_EVENTS	It includes all trace events: user and system.

Trace stream filtering

Traced events may be filtered. Filtering a trace event means to filter out (ignore) this selected trace event. Each traced stream is created without filtering any event type: all events are traced.

Note: By default, no trace events are filtered.

Filtering non-relevant information maintains the performance of the tracing subsystem. It prevents the tracing subsystem from processing a large number of events while the trace collection is generated or while the trace is analyzed.

The filtered events are gathered in a set of events (see “Trace event sets” on page 10). The set of events to be filtered out is attached to a stream: it has to be defined after the creation of the stream but the stream may be either started or not.

With the `posix_trace_set_filter()` subroutine, the filtering set can be changed accordingly to the following values of the `how` parameter:

POSIX_TRACE_SET_EVENTSET

The set of trace event types to be filtered is the trace event type set that the *set* parameter points to.

POSIX_TRACE_ADD_EVENTSET

The set of trace event types to be filtered is the union of the current set and the trace event type set that the *set* parameter points to.

POSIX_TRACE_SUB_EVENTSET

The set of trace event types to be filtered is the current trace event type set less each element of the specified set.

The system trace event `POSIX_TRACE_FILTER` indicates that the trace event filter set has changed while the trace stream was running. The trace event filter is managed by the controller process.

Table 1-6 lists the subroutines used to manage the filter set on the trace stream:

Table 1-6 Filter management routines on trace stream

Purpose	Subroutine name
Retrieve the filter of an initialized trace stream	<code>posix_trace_get_filter()</code>
Set the filter of an initialized trace stream	<code>posix_trace_set_filter()</code>

Managing trace events

The results of the tracing operations are monitored and analyzed by the controller process and the analyzer process.

Table 1-7 lists the subroutines to manage trace events from a trace stream used by the trace controller and analyzer process:

Table 1-7 Management trace events routines used by controller and analyzer

Purpose	Subroutine name
Compare two trace event type identifiers	<code>posix_trace_eventid_equal()</code>

Purpose	Subroutine name
Retrieve the trace event name from a trace event type identifier	posix_trace_eventid_get_name()
Iterate over the list of trace event type	posix_trace_eventtypelist_getnext_id()
Rewind the list of event types	posix_trace_eventtypelist_rewind()

Table 1-8 lists the subroutines to retrieve *trace events* from a trace stream used by the trace analyzer process.

Table 1-8 Retrieval trace events routines used by the analyzer process

Purpose	Subroutine name
Retrieve a trace event and block until available	posix_trace_getnext_event()
Retrieve a trace event and block until the time-out expires	posix_trace_timedgetnext_event()
Retrieve a trace event and return if not available	posix_trace_trygetnext_event()

1.3.3 Trace stream definition

A trace stream is the location where trace events are recorded. the following are the types of streams and objects as noted by the POSIX standard:

The *active* stream

The active stream is an initialized and created trace stream which is still not shutdown. The trace stream can still store trace events. As a trace stream can be located only in memory, if an analysis must be done after process execution, a log file has to be defined at the creation time of the trace stream.

The *Log* file

The log file is a persistent location where the in-memory trace stream is written by a flush operation initiated by the controller process. No stored events can be retrieved directly from a log file. A log file is available for analysis only after the corresponding trace stream has been shut down.

Without a *Log* file

Without a log file, a trace stream allows only online analysis.

The *pre-recorded* stream

As stored events in a log file cannot be directly retrieved, they have to be re-loaded in a trace stream. This trace stream is named *pre-recorded stream*. Then, the analyzer process, doing the analysis can retrieve the traced events from this pre-recorded stream.

The *Event recording*

The events are recorded in the stream as soon as the stream is started. The stream may be associated with a log file if any offline analysis is needed. The association of the stream with the log file is made at the stream creation. The log file is a persistent location where the in-memory trace is flushed by the controller process.

The *Event analysis*

When the stream is not associated to a log file, the stream allows only online analysis. The log file is ready for an analysis as soon as the stream associated with a log file has been shutdown. That means that no stored events can be retrieved for the analysis during the event recording. The stored events are re-loaded from the log file into a trace stream. Events are then retrieved as during online analysis.

Traced events have to be retrieved one by one from the traced stream (*active* or *pre-recorded*) with the oldest event being retrieved first. With AIX, trace stream is an in-memory area where trace events are recorded.

Note: Trace analysis can be done concurrently while tracing the instrumented code or can be done off-line. Log files are not directly eligible for trace analysis: they must be reloaded into a stream.

Whatever it is, a trace stream or a trace log, an action policy has to be defined when the trace stream or the trace log will be full of traced events. These *full* policies are named respectively *trace stream policy* (see “Trace stream policy” on page 15) and *trace Log policy* (see “Trace log policy” on page 15).

A trace stream or trace log capacity to record events depends on numerous criteria as the size of stream/Log, the size of the recorded events, the number of the recorded events named *inheritance*: either only the process events or the process and its child processes events are recorded. All these criteria, jointly with the full policies, are gathered into the attributes definition of a traced stream (see “Trace stream attributes” on page 16).

Selecting the types of events to be recorded also determines how fast the traced stream/log will be full (see “Trace stream filtering” on page 11).

Trace stream policy

The *stream policy* is one of the trace stream attributes. The stream attributes are described in “Trace stream attributes” on page 16.

The stream policy, also named *stream full policy*, defines the policy followed when the trace stream is full and has the following values:

POSIX_TRACE_LOOP

This policy permits automatic overwrite of the oldest events until the trace is stopped by the subroutines `posix_trace_stop()` or `posix_trace_shutdown()`.

POSIX_TRACE_UNTIL_FULL

This policy requires the system to stop tracing when the trace stream is full. If the stream that is full is emptied by a call to `posix_trace_flush()` or partially emptied by calls to `posix_trace_getnext_event()`, the trace activity is resumed.

POSIX_TRACE_FLUSH

This policy is an extension of the previous policy `POSIX_TRACE_UNTIL_FULL` for trace stream associated to a log file. There is an automatic flush operation when the stream is full.

Trace log policy

The *log policy* is one of the trace stream attributes. The stream attributes are described in “Trace stream attributes” on page 16.

The log policy, also named *log full policy*, defines the policy followed when the trace log is full and has the following values:

POSIX_TRACE_LOOP

The trace log loops until the trace stream is stopped by the subroutines `posix_trace_stop()` or `posix_trace_shutdown()`. This policy permits automatic overwrite of the oldest events.

POSIX_TRACE_UNTIL_FULL

The trace stream is flushed to the trace log until the trace log is full. The last recorded trace event is the `POSIX_TRACE_STOP` trace event (see “System trace events” on page 10). The event collection stops when the trace stream or the trace log file becomes full.

POSIX_TRACE_APPEND

The trace stream is flushed to the trace log without log size limitation.

Trace stream attributes

A trace stream has the following *trace stream attributes*:

Version of the trace system

The generation-version attribute identifies the origin and version of the trace system. It is generated automatically by the trace system.

Name of the trace stream

A character string to identify the trace stream, defined by the trace controller.

Creation time

The time of creation of the trace stream . It is generated automatically by the trace system.

Clock resolution

The clock resolution of the clock used to generate timestamps. It is generated automatically by the trace system.

Stream_minsize

The minimal size in bytes of the trace stream strictly reserved for the trace events. The maximum size has been set to a segment size.

Stream_fullpolicy

The policy followed when the trace stream is full; it could be either loop at the beginning of the stream or to stop tracing or to flush in a log file when it is full.

Max_datasize

The maximum record size in bytes for a trace event. Traced data exceeding that limit will be recorded up to that limit.

Inheritance

It specifies whether a newly created trace stream inherit tracing in its parent's process trace stream or not. it specifies either if the parent is being traced or if its child is concurrently traced using the same stream (POSIX_TRACE_INHERITED) or not (POSIX_CLOSE_FOR_CHILD).

Log_maxsize

The maximum size in bytes of trace log associated with an active stream.

Log_fullpolicy It defines the policy of a trace log associated with an active trace stream; it could be either loop, tracing until the log is full or tracing until the maximum size defined for a file system is reached.

Before the trace stream is created, the *trace stream attributes*, contained in the `trace_attr_t` object, must be initialized by the `posix_trace_attr_init()` subroutine.

This `posix_trace_attr_init()` subroutine initializes the trace stream attributes with the default values described in Table 1-9.

Table 1-9 Default values for trace stream attributes

Attribute field	Default value
<code>stream_minsize</code>	8192 bytes. Smallest aix trace buffer size
<code>stream_fullpolicy</code>	POSIX_TRACE_LOOP for a stream without log POSIX_TRACE_FLUSH for a stream with a log
<code>max_datasize</code>	16 bytes
<code>inheritance</code>	POSIX_TRACE_CLOSE_FOR_CHILD
<code>log_maxsize</code>	1 MB
<code>log_fullpolicy</code>	POSIX_TRACE_LOOP
<code>version</code>	0.1
<code>clock resolution</code>	Clock resolution used to generate timestamps

The value of each attribute is set by calling `posix_trace_attr_set...()` subroutines that explicitly set the value of these attributes (see Table 1-10).

The value of each attribute is retrieved from this `trace_attr_t` object using the `posix_trace_attr_get...()` subroutines (see Table 1-11 on page 18).

Table 1-10 lists the subroutines used to set up and manage the *trace stream attributes* object by the controller process:

Table 1-10 Setting trace stream attribute routines used by the controller process

Purpose	Subroutine name
Initializes a trace stream attributes object	<code>posix_trace_attr_init()</code>
Destroys a trace stream attribute object	<code>posix_trace_attr_destroy()</code>
Set the trace name	<code>posix_trace_attr_setname()</code>

Purpose	Subroutine name
Set the inheritance policy of a trace stream	posix_trace_attr_setinherited()
Set the stream full policy	posix_trace_attr_setstreamfullpolicy()
Set the maximum user trace event data size	posix_trace_attr_setmaxdatasize()
Set the trace stream size	posix_trace_attr_setstreamsize()
Sets the size of the log of a trace stream	posix_trace_attr_setlogsize()
Sets the log full policy of a trace stream	posix_trace_attr_setlogfullpolicy()

Table 1-11 lists the subroutines used to retrieve the trace stream attributes used by the trace controller and analyzer process:

Table 1-11 Retrieval trace stream attribute routines used by controller and analyzer

Purpose	Subroutine name
Retrieve the timestamping clock resolution	posix_trace_attr_getclockres()
Retrieve the creation time of a trace stream	posix_trace_attr_getcreatetime()
Retrieve the version of a trace stream	posix_trace_attr_getgenversion()
Retrieve the inheritance policy of a trace stream	posix_trace_attr_getinherited()
Retrieve the log full policy of trace stream	posix_trace_attr_getlogfullpolicy()
Retrieve the size of the log of a trace stream	posix_trace_attr_getlogsize()
Retrieve the maximum user trace event data size	posix_trace_attr_getmaxdatasize()
Retrieve the maximum size of a system trace event	posix_trace_attr_getmaxsystemeventsize()
Retrieve the maximum size of an user event for a given length	posix_trace_attr_getmaxusereventsize()
Retrieve the trace stream name	posix_trace_attr_getname()
Retrieve the stream full policy	posix_trace_attr_getstreamfullpolicy()

Purpose	Subroutine name
Retrieve the trace stream size	posix_trace_attr_getstreamsize()

Trace stream management

The trace stream is created for the traced process with the `posix_trace_create()` or `posix_trace_create_withlog()` subroutine by the controller process depending if a log is associated with the active stream or with `posix_trace_open()` by the analyzer process.

These trace stream creation subroutines use the process identifier (`pid_t` type) of the traced process as an argument: a zero indicates the traced process is the caller itself.

A *trace stream identifier* is returned by the trace stream creation routines and is valid only for the process that made these calls. The *trace stream identifier* is defined as the `trace_id_t` type in the `/usr/include/sys/types.h` include file.

Table 1-12 lists the subroutines to retrieve the attribute and state of the trace stream used by the trace controller and analyzer process:

Table 1-12 Trace stream attributes and state routines

Purpose	Subroutine name
Retrieve trace attributes	posix_trace_get_attr()
Retrieve trace status	posix_trace_get_status()

Table 1-13 lists the subroutines to control the *trace stream* used by the trace controller process:

Table 1-13 Trace stream control routines used by the trace controller process

Purpose	Subroutine name
Create an active trace stream	posix_trace_create()
Create an active trace stream and associates it with a trace log	posix_trace_create_withlog()
Initiate a flush on the trace stream	posix_trace_flush()
Shut down a trace stream	posix_trace_shutdown()
Clear trace stream and trace log	posix_trace_clear()
Start a trace	posix_trace_start()

Purpose	Subroutine name
Stop a trace	posix_trace_stop()

Table 1-14 lists the subroutines to control the *trace stream* used by the trace analyzer process:

Table 1-14 Trace stream control routines used by the trace analyzer process

Purpose	Subroutine name
Open a trace log	posix_trace_open()
Re-initialize a trace log for the reading	posix_trace_rewind()
Close a trace log	posix_trace_close()

1.3.4 AIX implementation overview

With AIX Version 6, the process to manage stream and events is a daemon named *posixtrace*. It is the only process the operating system has to implement.

As *posixtrace* creates a trace stream for all processes and records all events, *posixtrace* belongs to the root user. The *posixtrace* daemon is run as root (owner: root group:bin mode -r-sr-xr-x).

The *posixtrace* daemon is started by the first library load through the associated library initialization routine mechanism. This mechanism is implemented through the *binitfini* binder option. Thus, the *libposixtrace.a* library has been linked with the option `-binitfini:posix_trace_libinit`.

This `posix_trace_libinit` routine binds a dedicated socket to the file named `/var/adm/ras/.pxt_sock` and listens for one connection coming from the instrumented code linked with the *libposixtrace* library.

Another file named `/var/adm/ras/.start_lock` is used as a lock file in order to prevent several starts of the *posixtrace* daemon.

When the main daemon thread checks that there is no thread left, it closes the socket, unlocks, and unlinks `/var/adm/ras/.pxt_sock`, then exits.

1.4 ProbeVue

The first *dynamic* tracing facility, named *ProbeVue* is introduced within AIX with the Version 6.

A tracing facility is *dynamic* because it is able to gather execution data from applications without any modification of their binaries or their source code. *Dynamic* refers to this capability to insert trace points at run-time without the need to prepare the source code in advance. Inserting specific tracing calls and defining specific tracing events into the source code which require you to re-compile the software and generate new executable is referred as a *static* tracing facility.

The name *ProbeVue* is given by historical reference to the first dynamic tracing facility introduced by IBM within the OS/2® operating system in 1994 (OS/2 *dtrace* command). This dynamic tracing facility was ported to Linux and expanded under the DProbes name. There is no other similarity between these two dynamic tracing tools: they remain two different and distinct tracing frameworks, however from a similar background.

Interestingly, there are no standards in the area of dynamic tracing. POSIX has defined a tracing standard for static tracing software only as described in 1.3.1, “POSIX tracing overview” on page 5.

Dynamic tracing benefits and considerations

Software debugging is often considered as a dedicated task running on development systems or test systems trying to mimic real customer production systems.

However, this general statement is currently evolving due to the recent advances in hardware capabilities and software engineering creating complex environments:

- ▶ The processing and memory capabilities of high-end servers with associated storage technologies have lead to huge systems into production.
- ▶ Dedicated solutions developed by system integrators based on ERP software, for example, implement numerous middleware and several application layers and lead also to complex software solutions.
- ▶ Mostly software are now multi-threaded and running on many processors. Thus, two executions can behave differently depending on the order of thread execution: multi-threaded applications are generally non deterministic. Erroneous behaviors are more difficult to reproduce and debug for such software.

Thus, to determine the root cause of a trouble in today's IT infrastructure, it has become a prohibitive high expense and a significant burden if the troubleshooting is not achieved on the real production system.

With ProbeVue dynamic tracing facility, a production system can be investigated: ProbeVue captures the execution data without installing dedicated instrumented versions of applications or kernel which require to interrupt the service for the application relaunch or server reboot.

Additionally, ProbeVue helps to find the root cause of troubles happening only on long running jobs where unexpected accumulated data, queues overflows, and others defects of the application or kernel are revealed only after many days or months of execution.

As ProbeVue is able to investigate any kind of applications as far as a Probe Manager is available (see "Probe Manager" on page 28), it is a privileged tracing tool to analyze a complex trouble as a cascading failure between multiple sub-systems: with only one unique tracing tool, ProbeVue allows an unified instrumentation of a production system.

Of note, ProbeVue has the following considerations:

- ▶ To trace an executable without modifying it requires you to encapsulate the binary code with a control execution layer. This control layer will start and interrupt the binary execution to allow the context tracing. Due to the dynamic tracing aspect, it can only be an interpreted layer. Interpreter languages are known to be slower than compiled language: the dynamic interpreted tracing points are potentially slower than the static compiled ones.
- ▶ If system administrators, system integrators are expected to use a tool to investigate the software execution, the tool must give them the necessary knowledge of the application architecture to do an efficient investigation of its critical components involved in a trouble. On the other hand, developers know where to set effective tracing points on the strategic data manipulated by the application on the earlier development stage - so this is a more effective.

For these reasons, ProbeVue is a complimentary tracing tool to the static tracing methods, adding a new innovative tracing capabilities to running production systems.

ProbeVue dynamic tracing benefits

As a dynamic tracing facility, ProbeVue has the following main benefits:

- ▶ Trace hooks do not have to be pre-compiled. ProbeVue works on unmodified kernel or user applications.

- ▶ The trace points or probes have no effect (do not exist) until they are dynamically enabled.
- ▶ Actions (specified by the instrumentation code) to be executed at a probe point or the probe actions are provided dynamically at the time the probe is enabled.
- ▶ Trace data captured as part of the probe actions are available for viewing immediately and can be displayed as terminal output or saved to a file for later viewing.

ProbeVue can be used for performance analysis as well as for debugging problems. It is designed to be safe to run on production systems and provides protection against errors in the instrumentation code.

The section defines some of the terminology used. The subsequent sections introduce Vue, the programming language used by ProbeVue and the **probevue** command that is used to start a tracing session.

1.4.1 ProbeVue terminology

ProbeVue introduces a terminology relative to the concepts used in dynamic tracing. The following is the description of the terms used with ProbeVue:

A probe Is a software mechanism that interrupts normal system action to investigate and obtain information about current context and system state. This is also commonly referred to as *tracing*.

Tracing actions or probe actions

Refers to the actions performed by the probe. Typically, they include the capturing of information by dumping the current values of global and context-specific information to a trace buffer. The obtained information, thus captured in the trace buffer, is called *trace data*. The system usually provides facilities to consume the trace, that is, read the data out of the trace buffer and make it available to the users of the system.

A probe point Identifies the points during normal system activity that are capable of being probed. With dynamic tracing, probe points do not have any probes installed in them unless they are being probed.

Enabling a probe is the operation of adding a probe to a probe point.

Disabling a probe is the operation of removing a probe from a probe point.

Triggering or firing of a probe refers to the condition where a probe is entered and the tracing actions are performed.

ProbeVue supports two kinds of probe points.

A probe location This is a location in user or kernel code where some tracing action like the capture of trace data is to be performed. Enabled probes at a probe location fire when any thread executing code reaches that location.

A probe event This is an abstract event at whose occurrence some tracing action is to be performed. Probe events do not easily map to a specific code location. Enabled probes that indicate a probe event fire when the abstract event occurs.

ProbeVue also distinguishes probe points by their type.

A probe type Identifies a set of probe points that share some common characteristics, for instance probes that when enabled fire at the entry and exit of system calls, or probes that when enabled fire when system statistics are updated.

Distinguishing probes by probe types induce a structure to the wide variety of probe points. So, ProbeVue requires a probe manager to be associated with each probe type.

A probe manager Is the software code that defines and provides a set of probe points of the same probe type. For instance, “*the system calls*” probe manager.

1.4.2 Vue programming language

The Vue programming language is used to provide your tracing specifications to ProbeVue. The Vue programming language is often abbreviated to the *Vue language* or just to *Vue*.

A Vue script or Vue program is a program written in Vue. You can use a Vue script to:

- ▶ Identify the probe points where a probe is to be dynamically enabled.
- ▶ Identify the conditions, if any, which must be satisfied for the actions to be executed when a probe fires.
- ▶ Identify the actions to be executed including what trace data to capture.
- ▶ Associate the same set of actions for multiple probe points.

In short, a Vue script tells ProbeVue where to trace, when to trace and what to trace.

It is recommended that Vue scripts have a file suffix of *.e* to distinguish them from other file types, although this is not a requirement.

1.4.3 Probevue command

The **probevue** command is used to start a dynamic tracing session or a ProbeVue session. The **probevue** command takes a Vue script as input reading from a file or from the command-line and activates a ProbeVue session. Any trace data that is captured by the ProbeVue session can be printed to the terminal or saved to a user-specified file as per options passed in the command line.

The ProbeVue session stays active until a Ctrl-C is typed on the terminal or an exit action is executed from within the Vue script.

Each invocation of the **probevue** command activates a separate dynamic tracing session. Multiple tracing sessions may be active at one time, but each session presents only the trace data that is captured in that session.

Running the **probevue** command is considered a privileged operation and privileges are required for non-root users who wish to initiate a dynamic tracing session.

1.4.4 The probevctrl command

The **probevctrl** command changes and displays the ProbeVue dynamic tracing parameters, the per-processor trace buffer size, the consumed pinned memory, the user owning the session, the identifier of the process that started the session, and the information about whether the session has kernel probes for the ProbeVue sessions.

1.4.5 Vue: an overview

Vue is both a programming and a script language. It is not an extension of C or a simple mix of C and **awk**. It has been specifically designed as a dedicated dynamic tracing language. Vue supports a subset of C and scripting syntax that is most beneficial for dynamic tracing purposes.

This section describes the structure of a Vue script.

Structure of a Vue Script

A Vue script consists of one or more clauses. The clauses in a Vue script can be specified in any order. Figure 1-3 is a typical layout of a Vue script.

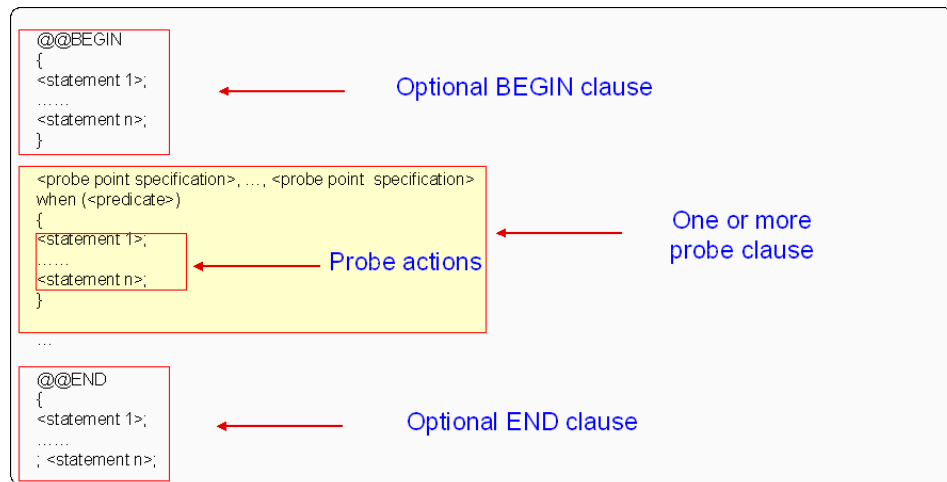

Figure 1-3 Structure of a Vue script

The following are two Vue scripts examples:

1. The following canonical Hello World program prints "Hello World" into the trace buffer and exits.

```

#!/usr/bin/probevue

/* Hello World in probevue */
/* Program name: hello.e */

@@BEGIN
{
    printf("Hello World\n");
    exit();
}

```

2. The following Hello World program prints "Hello World" when Ctrl-C is typed on the keyboard.

```

#!/usr/bin/probevue

/* Hello World 2 in probevue */
/* Program name: hello2.e */

@@END

```

```

{
    printf("Hello World\n");
}

```

Each clause of a Vue script consists of the following three elements:

► **Probe point specification**

The probe point specification identifies the probe points to be dynamically enabled.

► **Action Block**

The action block is used to identify the set of probe actions to be performed when the probe fires.

► **An optional predicate**

The predicate, if present, identifies a condition that is to be checked at the time the probe is triggered. The predicate must evaluate to TRUE for the probe actions of the clause to be executed.

Probe point specification

A probe point specification identifies the code location whose execution or the event whose occurrence that should trigger the probe actions. Multiple probe points can be associated with the same set of probe actions and the predicate, if any, by providing a comma-separated list of probe specifications at the top of the Vue clause.

The format for a probe specification is probe-type specific. The probe specification is a tuple (a type of programming structure) of ordered list of fields separated by colons. It has the following general format:

```
@@<probetype>:<probetype field1>:...:<probetype fieldn>:<location>
```

AIX Version 6.1 supports the following probe types:

► **User Function Entry probes (or uft probes)**

For example, a uft probe at entry into any function called foo() (in the main executable or any of the loaded modules including libraries) in process with ID = 34568:

```
@@uft:34568*:foo:entry
```

► **System Call Entry/Exit probes (or syscall probes)**

For example, a syscall probe at exit of read system call

```
@@syscall*:read:exit
```

► **Probes that fire at specific time intervals (or interval probes)**

For example, an interval probe to fire every 500 milliseconds (wall clock time).

```
@@interval:*:clock:500
```

An action block

The action block identifies the set of actions to be performed when a thread hits the probe point. Supported actions are not restricted to the basic capturing and formatting of trace data but the full power of Vue can be employed.

An action block in Vue is similar to a procedure in procedural languages. It consists of a sequence of statements that are executed in order. The flow of execution is essentially sequential. The only exceptions are that conditional execution is possible using the if-else statement and control may be returned from within the action block using the return statement.

Unlike procedures in procedural languages, an action block in Vue does not have an output or return value. Neither does it have inherent support for a set of input parameters. On the other hand, the context data at the point where a probe is entered can be accessed within the action block to parameterize the actions to be performed.

A predicate

Predicates should be used when execution of clauses at probe points must be performed conditionally.

The predicate section is identified by the presence of the when keyword immediately after the probe specification section. The predicate itself consists of regular C-style conditional expressions with the enclosing parentheses.

A predicate has the following format:

```
when ( <condition> )
```

For example, this is a predicate indicating that probe points should be executed for process ID = 1678:

```
when ( __pid == 1678 )
```

Probe Manager

The probe manager is an essential component of dynamic tracing. Probe Managers are the providers of the probe points that can be instrumented by ProbeVue.

Probe managers generally support a set of probe points that belong to some common domain and share some common feature or attribute that distinguishes them from other probe points. Probe points are useful at points where control flow changes significantly, at points of state change or other similar points that of

significant interest. Probe managers are careful to select probe points only in locations that are safe to instrument.

ProbeVue currently supports the following three probe managers:

► **System Call probe manager**

The syscall probe manager supports probes at the entry and exit of well-defined and documented base AIX system calls. The syscall probe manager accepts a 4-tuple probe specification in one of the following formats where the `<system_call_name>` field is to be substituted by the actual system call name:

```
* syscall:*:<system_call_name>:entry
* syscall:*:<system_call_name>:exit
```

These indicate that a probe is to be placed at the entry and exit of system calls. Assigning the "*" to the second field indicates that the probe will be fired for all processes. Additionally, a process ID can be specified as the second field of the probe specification to support probing of specific processes.

```
* syscall:<process_ID>:<system_call_name>:entry
* syscall:<process_ID>:<system_call_name>:exit
```

► **User function probe manager**

The user function tracing (uft) probe manager supports probing user space functions that are visible in the XCOFF symbol table of a process. These entry points, usable as probe points, are currently restricted to those written in C language text file. The uft probe manager currently accepts a 5-tuple probe specification only in the following format:

```
uft:<processID>:*:<function_name>:entry
```

Note that the uft probe manager requires the process ID for the process to be traced and the complete function name of the function at whose entry point the probe is to be placed. Further, the uft probe manager currently requires that the third field be set to "*" to indicate that the function name is to be searched in any of the modules loaded into the process address space including the main executable and shared modules

► **Interval probe manager**

The interval probe manager supports probe points that fire at a user-defined time-interval. The probe points are not located in kernel or application code, but instead are based on wall clock time interval based probe events. The interval probe manager accepts a 4-tuple probe specification in the following format:

```
@@interval:*:clock:<# milliseconds>
```

The second field is * indicating that the probe can be fired in any process. Currently, the interval probe manager does not filter probe events by process IDs. For the third field, the only value supported is currently the clock keyword that identifies the probe specification as being for a wall clock probe. The fourth or last field, that is, the <# milliseconds> field identifies the number of milliseconds between firings of the probe. Currently, the interval probe manager requires that the value for this field be exactly divisible by 100 and consist only of digits 0-9. Thus, probe events that are apart by 100 ms, 200 ms, 300 ms, and so on, are allowed.

Vue functions

Unlike programs written in the C or in FORTRAN programming languages or in a native language, scripts written in Vue do not have access to the routines provided by the AIX system libraries or any user libraries. However, Vue supports its own special library of functions useful for dynamic tracing programs. Functions include:

- ▶ Tracing-specific functions:

get_function	Returns the name of the function that encloses the current probe
timestamp	Returns the current time stamp.
diff_time	Finds the difference between two time stamps

- ▶ Trace capture functions

printf	Formats and prints values of variables and expressions
trace	Prints data without formatting.
stktrace	Prints and formats the stack trace

- ▶ List functions

list	Instantiate a list variable.
append	Append a new item to list.
sum, max, min, avg, count	Aggregation functions that can be applied on a list variable

- ▶ C-library functions

atoi, strstr	Standard string functions
--------------	---------------------------

- ▶ Functions to support tentative tracing

start_tentative, end_tentative	Indicators for start and end of tentative tracing.
--------------------------------	--

commit_tentative, discard_tentative
Commit or discard data in tentative buffer

► Miscellaneous functions

exit Terminates the E-program.

get_userstring Read string from user memory

The Vue string functions can be applied only on variables of string type and not on a pointer variable. Standard string functions like strcpy(), strcat(), and so on, are not necessary in Vue, because they are supported through the language syntax itself.

1.4.6 ProbeVue dynamic tracing example

This is a basic ProbeVue example to show how ProbeVue works and how to use ProbeVue on a running executable without restarting or recompiling it.

The following steps must be performed:

1. The following C program, named *pvue* is going to be traced dynamically:

Example 1-1 Basic C program to be dynamically traced: pvue.c

```
#include <fcntl.h>
main()
{
  int x, rc;
  int buff[100];

  for (x=0; x<5; x++){
    sleep(3);
    printf("x=%d\n",x);
  }
  sleep (3);
  fd=open("./pvue.c",O_RDWR,0);
  x =read(fd,buff,100);
  printf("[%s]\n",buff);
}
```

2. Compile and execute the program in background for instance:

```
# cc -q64 -o pvue pvue.c
# ./pvue &
[1] 262272
```

3. In order to trace dynamically the number of calls executed by the *pvue* process to the subroutines: `printf()`, `sleep()`, entry of `read()`, exit of `read()`, the following *probevue* script, named *pvue.e* is developed which uses the process ID as an entry parameter ('\$1'):

Example 1-2 Sample Vue script, named pvue.e

```
#!/usr/bin/probevue
@@BEGIN
{
    printf("Tracing starts now\n");
}
@@uft:$1:*:printf:entry
{
    int count;
    count = count +1;
    printf("printf called %d times\n",count);
}
@@uft:$1:*:sleep:entry
{
    int count1;
    count1 = count1 +1;
    printf("sleep called %d times\n",count1);
}
@@syscall:*:read:exit
    when (__pid == $1)
{
    printf("read entered\n");
}
@@syscall:*:read:entry
    when (__pid == $1)
{
    printf("read exited\n");
}
@@END
{
    printf("Tracing ends now\n");
}
```

4. Executed with the **probevue** command, the Vue script named *pvue.e* with the process ID to be traced as parameter is used:

```
# probevue ./pvue.e 262272
```

The following tracing output is obtained after completion of these steps:

Example 1-3 Start Vue script providing pid

```
# ./pvue.e 262272
Tracing starts now
printf called 1 times
sleep called 1 times
printf called 2 times
sleep called 2 times
printf called 3 times
sleep called 3 times
printf called 4 times
sleep called 4 times
printf called 5 times
sleep called 5 times
read exited
read entered
printf called 6 times
^CTracing ends now
#
```



File systems and storage

This chapter contains the major AIX Version 6.1 enhancements that are part of the file system and connected storage including:

- ▶ “Disabling JFS2 logging” on page 36
- ▶ “JFS2 internal snapshot” on page 36
- ▶ “Encrypted File System” on page 40
- ▶ “iSCSI target mode software solution” on page 50

2.1 Disabling JFS2 logging

AIX V6.1 allows you to mount a JFS2 file system with logging turned off. Disabling JFS2 logging can increase I/O performance. The following examples are typical situations where disabled logging may be helpful:

- ▶ While restoring a backup
- ▶ For a compiler scratch space
- ▶ During a non-migration installation

Improved performance is also found in situations where a series of I/O operations modify JFS2 metadata. Note that non-representative tests in a lab environment showed up to a ten percent performance improvement for a series of operations which *only* changed JFS2 metadata.

Keep in mind to balance the benefit of a performance advantage with the possible data exposures of a disabled file system log.

Important: If a system abnormally stops during a JFS2 metadata operation with logging disabled, the **fsck** command might not be able to recover the file system into a consistent state. In such cases, the file system has to be recreated, there and all the data will be lost.

You can disable JFS2 logging with the **mount** command. There is no SMIT or Web-based System Manager panel, since this feature is used only in rare cases. You cannot disable the logging while creating a file system. Every file system has to be created with a valid JFS2 log device or an inline log.

Use the following flag with the **mount** command to mount a JFS2 file system with logging disabled:

```
mount -o log=NULL /aix61diff
```

In order to make the mount setting persistent, modify the log attribute of the corresponding `/etc/filesystems` stanza to `log=NULL`.

2.2 JFS2 internal snapshot

With AIX V5.2, the JFS2 snapshot was introduced. Snapshots had to be created into separate logical volumes. AIX V6.1 offers the ability to create snapshots within the source file system.

Therefore, starting with AIX V6.1, there are two types of snapshots:

- ▶ External snapshot
- ▶ Internal snapshot

Table 2-1 provides an overview of the differences between the two types of snapshots.

Table 2-1 Comparison of external and internal snapshots

	External snapshot	Internal snapshot
Location	Separate logical volume	Within the same logical volume
Access	Must be mounted separately	/fsmountpoint/.snapshot/snapshotname
Maximum generations	15	64
AIX compatibility	>= AIX V5.2	>= AIX V6.1

Both the internal and the external snapshots keep track of the changes to the snapped file system by saving the modified or deleted file blocks. Snapshots provide point-in-time (PIT) images of the source file system. Often, snapshots are used to be able to create a consistent PIT backup while the workload on the snapped file system continues.

The internal snapshot introduces the following enhancements:

- ▶ No super user permissions are necessary to access data from a snapshot, since no initial mount operation is required.
- ▶ No additional file system or logical volume needs to be maintained and monitored.
- ▶ Snapshots are easily NFS exported since they are held in the same file system.

2.2.1 Managing internal snapshots

A JFS2 file system must be created with the new `-a isnapshot=yes` option. Internal snapshots require the use of the extended attributes `v2` and therefore the `crfs` command will automatically create a `v2` file system.

Existing file systems created without the `isnapshot` option cannot be used for internal snapshots. They have to be recreated or have to use external snapshots.

There are no new commands introduced with internal snapshots. Use the **snapshot**, **rollback**, and **backsnap** commands to perform operations. Use the new `-n snapshotname` option to specify internal snapshots. There are corresponding SMIT and Web-based System Manager panels available.

To create an internal snapshot:

```
# snapshot -o snapfrom=/aix61diff -n snap01
Snapshot for file system /aix61diff created on snap01
```

To list all snapshots for a file system:

```
# snapshot -q /aix61diff
Snapshots for /aix61diff
Current Name      Time
*          snap01  Tue Sep 25 11:17:51 CDT 2007
```

To list the structure on the file system:

```
# ls -l /aix61diff/.snapshot/snap01
total 227328
-rw-r--r--  1 root    system    10485760 Sep 25 11:33 file1
-rw-r--r--  1 scott  staff     1048576 Sep 25 11:33 file2
-rw-r--r--  1 jenny  staff    10485760 Sep 25 11:33 file3
drwxr-xr-x  2 root    system         256 Sep 24 17:57 lost+found
```

The previous output shows:

- ▶ All snapshots are accessible in the `/fsmountpoint/.snapshot/` directory
- ▶ The data in the snapshot directories are displayed with their original file permission and ownership. The files are read only, no modifications are allowed.

Note: The `.snapshot` directory in the root path of every snapped file system is not visible to the `ls` and `find` command. If the `.snapshot` directory is explicitly specified as an argument they are able to display the content.

To delete an internal snapshot:

```
# snapshot -d -n snap01 /aix61diff
```

2.2.2 Error handling

There are two known conditions where a snapshot is unable to preserve the file system data:

- ▶ The file system runs out of space (for internal snapshots) or the logical volume is full (for external snapshots).
- ▶ Write operations to the snapshot are failing, for example due to a disk failure.

In both cases, all snapshots are aborted and marked as INVALID. In order to recover from this state, the snapshots have to be deleted and a new one can be created. It is, therefore, important that you monitor the usage of the file system or logical volume.

- ▶ You can use the **snapshot -q** command and monitor the Free field for logical volumes of external snapshots that are not mounted.
- ▶ For internal snapshots use the **df** command to monitor the free space in the file system.

If an error occurs while reading data from a snapshot a error message is returned to the running command. The snapshot is still valid and continues to track changes to the snapped file system.

2.2.3 Considerations

The following applies for internal snapshots:

- ▶ A snapped file system can be mounted read only on previous AIX 5L versions. The snapshot itself cannot be accessed. The file system must be in a clean state, run the **fsck** command to insure this.
- ▶ A file system created with the ability for internal snapshots can still have external snapshots.
- ▶ Once a file system has been enabled to use internal snapshots, this cannot be undone.
- ▶ If the **fsck** command has to modify the file system, any internal snapshots for the file system will be deleted by **fsck**.
- ▶ Snapped file systems cannot be shrunk.
- ▶ The **defragfs** command cannot be run on a file system with internal snapshots.
- ▶ Existing snapshot Web-based System Manager and SMIT panels are updated to support internal snapshots.

The following applies to both internal and external snapshots:

- ▶ A file system can use exclusively one type of snapshot at the same time.
- ▶ Typically, a snapshot will need two to six percent of the space needed for the snapped file system. For highly active file system 15 percent is estimated.

- ▶ External snapshots are persistent across a system reboot.
- ▶ During the creation of a snapshots, only read access to the snapped file system is allowed.
- ▶ There is reduced performance for write operations to a snapped file system. Read operations are not affected.
- ▶ Snapshots are not replacement for backups. A snapshot depends always on the snapped file system, whereas backups have no dependencies to the source.
- ▶ Neither the `mksysb` nor `alt_disk_install` commands will preserve snapshots.
- ▶ A file system with snapshots cannot be managed by DMAPI. A file system being managed by DMAPI cannot create a snapshot.

2.3 Encrypted File System

AIX V6.1 introduces the ability to encrypt files on a per file basis without the need of third-party tools. EFS should be used in environments where sensitive data requires additional protection.

AIX EFS has the following advantages over other encrypted file systems:

- ▶ Increased file level encryption granularity:
Data is encrypted on a user/group level, compared to other implementations where all users use the same keys. This is a useful protection on a per file system/disk level, but does not protect the data from being read by others in the same file system/disk.
- ▶ Seamless integration into traditional user administration commands and therefore transparent to users and administrators.
- ▶ Provides a unique mode that can protect against a compromised or malicious root user.

Additional information and extensive examples can be found in Chapter 2 of the *AIX 6 Advanced Security Features: Introduction and Configuration*, SG24-7430.

<http://www.redbooks.ibm.com/abstracts/sg247430.html?open>

2.3.1 Encryption

You can encrypt files on a per-file basis. Data is encrypted before its written back to disk and decrypted after its read from disk. Data held in memory is not

encrypted but the EFS access control is still in place. AIX uses a combination of symmetric and asymmetric encryption algorithms to protect the data.

A unique AES symmetric key is used to encrypt and decrypt every file. This symmetric key is encrypted with an RSA public key of the user and group and then added to the extended attributes of the file.

EFS uses an RSA private/public keypair to protect each symmetric key. These keys are stored in containers named *keystores*. The user keystores are password protected. The initial password of a user keystore is the user login password. Group keystores and admin keystores are not protected with a password, instead they have access key protection. Access keys are stored inside all user keystores that belong to this group.

The users keystore is loaded into the AIX kernel upon user login (associated with the login shell) or with invoking the new **efskeymgr** command and providing an argument to specify to which process the keys should be associated with. All child processes of the associated process will have access to the keys.

2.3.2 Keystore modes

User keystores have two modes of operation, discussed in the following sections.

Root admin mode

In root admin mode, the root user can:

- ▶ Get access to the user keystore
- ▶ Get access to the group keystore
- ▶ Reset the user keystore password
- ▶ Reset the group access key

Root admin mode is the default mode of operation. A consequence of root being able to get access to user keystore is that root can get access to *all* encrypted files.

Root guard mode

All the privileges granted to root in the root admin mode are not valid in this mode.

This mode of operation offers protection against a malicious root user. It means that if the system is hacked and the hacker somehow manages to obtain root privilege, the hacker cannot have access to user or group keystores and therefore cannot have access to user encrypted files.

Important: If a user loses their keystore password, root cannot reset it. It means that *no one* can get access to that keystore anymore and the encrypted files owned by this user can no longer be decrypted.

2.3.3 File access permissions

It is important to understand that the traditional AIX file permissions do not overlap with the EFS mechanisms. EFS introduces another level of file access checking. The following steps are used when an encrypted file is being accessed:

1. The traditional file permissions are checked first.
2. Only if the check is passed, AIX will continue to verify that only a user that has a private key that matches one of the public keys can gain access to the encrypted data.

If the traditional file permissions allow the user to read the file, but the user has no proper private key in his keystore, access is denied.

Note: Even the root user will not have access to all files as long as other users do not grant access to encrypted files with the following command: `efsmgr -a ./filename -u root`

If the keystores are operated in root admin mode, the root user can load the private keys of other users to get access to all files.

2.3.4 Installation

This section discusses the prerequisites and commands used for the installation of EFS.

Prerequisites

In order to use EFS you must meet the following requisites:

- ▶ Installed Crypto Library (CLIC) package `cl ic . rte` from the AIX V6.1 expansion pack
- ▶ Role Based Access Control (RBAC) must be enabled
- ▶ A JFS2 file system with the `efs=yes` option
- ▶ A JFS2 file system with the `ea=v2` option

If necessary, use the **chfs** command to change the **efs** and **ea** options on previously created file systems. If you specify the **efs** option with the **crfs** or **chfs** command, it will automatically create/change the file system to use v2 extended attributes.

Commands

There are new commands introduced with EFS. All are part of the **bos.rte.security** package which is installed by default in AIX. They are provided in Table 2-2.

Table 2-2 *New EFS commands*

Command	Description
/usr/sbin/efsenable	Prepares the system to use EFS. It creates the EFS administration keystore, the user keystore of the current user (root or an user with RBAC role aix.security.efs), and the security group keystore in the /var/efs directory. This command needs to be executed only once on every AIX installation in order to use EFS.
/usr/sbin/efskeymgr	Dedicated to all key management operations needed by EFS.
/usr/sbin/efsmgr	Manages the file encryption and de-encryption.

Traditional commands have been modified to support EFS, provided in Table 2-3.

Table 2-3 *Commands modified for EFS*

Commands	Enhancement
cp, mv	Moves/copies files from EFS <-> EFS and EFS <-> non-EFS file systems.
ls, find	Enabled to handle encrypted files.
backup, restore, tar, pax, cpio	Supports raw modes for EFS encrypted files. Files can be accessed in the encrypted form without the need of the private keys.
mkdir	Handles EFS inheritance.
mkuser, chuser, mkgroup, chgroup, rmuser, rmggroup	Enabled to modify the keystores and EFS user attributes.
chown, chgrp, chmod	Enabled to modify the EFS extended attributes.
passwd	Updates the key store password if it is the same as the login password.

For the new command options, refer to the man pages or the AIX product documentation.

2.3.5 Enable and create EFS file systems

This section describes the necessary steps to activate EFS. Example 2-1 shows the following tasks:

1. Enable EFS
2. Create an EFS file system
3. Shows the directory structure for the keystores
4. Mount the file system

All commands have to be run from the root user or a user with the appropriate RBAC roles assigned.

Example 2-1 Enabling EFS and creating an EFS file system

```
# efsenable -a
Enter password to protect your initial keystore:
Enter the same password again:

# crfs -v jfs2 -g rootvg -m /efs -A yes -a size=256M -a efs=yes
File system created successfully.
261932 kilobytes total disk space.
New File System size is 524288

# find /var/efs
/var/efs
/var/efs/users
/var/efs/users/.lock
/var/efs/users/root
/var/efs/users/root/.lock
/var/efs/users/root/keystore
/var/efs/groups
/var/efs/groups/.lock
/var/efs/groups/security
/var/efs/groups/security/.lock
/var/efs/groups/security/keystore
/var/efs/efs_admin
/var/efs/efs_admin/.lock
/var/efs/efs_admin/keystore
/var/efs/efsenabled
```

```
# mount /efs
```

2.3.6 File encryption and de-encryption

This section provides you an example of encrypting and decrypting files. Example 2-2 shows the following:

1. Display the loaded keys associated to the current login shell
2. Create three test files
3. Encrypt file2
4. The **ls -U** command now indicates that the file is encrypted
5. Use the **efskeymgr -l** command to verify which keys are need to access the file
6. Verify that user *guest* cannot read the file content even the traditional file permissions would allow him
7. Use the **ls**, **istat** and **fsdb** commands to verify that the file is stored encrypted in the file system
8. Decrypt file2

Example 2-2 Encryption and de-encryption of files

```
# efskeymgr -V
List of keys loaded in the current process:
Key #0:
      Kind ..... User key
      Id  (uid / gid) ..... 0
      Type ..... Private key
      Algorithm ..... RSA_1024
      Validity ..... Key is valid
      Fingerprint .....
e34acd99:b1f22cdc:85f638e0:3fd56e78:e3c5a3a7
Key #1:
      Kind ..... Group key
      Id  (uid / gid) ..... 7
      Type ..... Private key
      Algorithm ..... RSA_1024
      Validity ..... Key is valid
      Fingerprint .....
5e3e7305:203fce04:0e5a7339:4d688643:1e16beba
Key #2:
      Kind ..... Admin key
      Id  (uid / gid) ..... 0
      Type ..... Private key
```

```

Algorithm ..... RSA_1024
Validity ..... Key is valid
Fingerprint .....
fffa123f:cc615f5f:41b4dc2a:80e98a22:e50667a8

# cd /efs
# touch file1 file2 file3
# for i in file[1-3]
> do
> echo "content of $i" > $i
> done

# ls -U
total 24
-rw-r--r---   1 root    system      17 Sep 20 10:54 file1
-rw-r--r---   1 root    system      17 Sep 20 10:54 file2
-rw-r--r---   1 root    system      17 Sep 20 10:54 file3
drwxr-xr-x-   2 root    system     256 Sep 20 10:30 lost+found

# efsmgr -e file2

# ls -U
total 32
-rw-r--r---   1 root    system      17 Sep 20 10:54 file1
-rw-r--r--e   1 root    system      17 Sep 20 11:07 file2
-rw-r--r---   1 root    system      17 Sep 20 10:54 file3
drwxr-xr-x-   2 root    system     256 Sep 20 10:30 lost+found

# efsmgr -l file2
EFS File information:
Algorithm: AES_128_CBC
List of keys that can open the file:
Key #1:
Algorithm      : RSA_1024
Who            : uid 0
Key fingerprint : e34acd99:b1f22cdc:85f638e0:3fd56e78:e3c5a3a7

# su - guest -c cat /efs/file[1-3]
content of file1
cat: 0652-050 Cannot open /efs/file2.
content of file3

# ls -iU file2
 7 -rw-r--r--e   1 root    system      17 Sep 20 11:07 file2

```

```
# istat 7 /dev/fslv00
Inode 7 on device 10/11 File
Protection: rw-r--r--
Owner: 0(root)          Group: 0(system)
Link count: 1          Length 17 bytes

Last updated: Thu Sep 20 11:07:09 CDT 2007
Last modified: Thu Sep 20 11:07:09 CDT 2007
Last accessed: Thu Sep 20 11:31:33 CDT 2007
```

```
Block pointers (hexadecimal):
```

```
2b
```

```
# fsdb /dev/fslv00
Filesystem /dev/fslv00 is mounted. Modification is not permitted.
```

```
File System:                /dev/fslv00

File System Size:           523864 (512 byte blocks)
Aggregate Block Size:      4096
Allocation Group Size:     8192 (aggregate blocks)
```

```
> display 0x2b
```

```
Block: 43      Real Address 0x2b000
00000000: 023173CC 00521DBD FDE0A433 556504CE |.1s..R.....3Ue..|
00000010: 069AE78F 13610D78 7ECCB975 EDD9A258 |.....a.x~...u...X|
00000020: F5E2DE6D AE16DEB9 4C9DF533 01F68EC1 |...m....L..3....|
00000030: 4A942ADA DD08A62D 86B3D4FF 0D7BA079 |J.*.....-.....{.y|
00000040: 8A4A4D4E 3330F8B3 82640172 A830F7A4 |.JMN30...d.r.0..|
00000050: 85369398 10165D90 F57E1C90 023DD6E6 |.6....]..~...=..|
00000060: 9BAC97F3 AB308BA9 751AAA31 67167FFD |.....0..u..1g...|
00000070: 11CDA7F1 BE590C7F D9E2C144 A0DFECE3 |.....Y.....D....|
00000080: 46B83CD8 01EB3133 1F1F2FAC 0E016BB0 |F.<...13../...k.|
00000090: ED4055BA AA16D0F0 6BD1DEEA DE1D97ED |.@U.....k.....|
000000a0: BAC172E5 F4A0B05F 6DA06952 CC43D1F5 |..r...._m.iR.C..|
000000b0: E023B89D E7F78E05 AB94246B 6602B394 |.#.....$kf...|
000000c0: 3171B246 5C2AB5C7 B96CCF1E A78DE2BD |1q.F\*...l.....|
000000d0: 019C5735 AB71D7E8 12FB70F5 747F3DCA |..W5.q....p.t.=.|
000000e0: D1EA73FF 63746CE9 C4E5EAEB 7E2DD5A2 |..s.ctl.....~-.|
000000f0: 1FE58E32 AA82EB4F 104E72E4 EB69D87E |...2...0.Nr..i.~|
-hit enter for more-
```

```
# efsmgr -d file2
```

```
# ls -iU file2
```

```
5 -rw-r--r--- 1 root system 17 Sep 20 11:53 file2
```

Important: Encryption and de-encryption changes the position of the files on a file system. Files are copied during these operations and therefore inode numbers will change.

2.3.7 Encryption inheritance

An EFS enabled file system does not imply that every file in it is encrypted. To achieve this, the you must enable encryption inheritance. There are two levels of inheritance:

- ▶ Activated on file system level
- ▶ Activated on directory level

All new files and subdirectories will inherit the encryption settings of the parent directory. Directories themselves are never encrypted, they only inherit encryption.

Example 2-3 Encryption Inheritance

```
# ls -U
total 24
-rw-r--r--- 1 root system 17 Sep 20 13:49 file1
-rw-r--r--- 1 root system 17 Sep 20 11:53 file2
-rw-r--r--- 1 root system 17 Sep 20 10:54 file3
drwxr-xr-x- 2 root system 256 Sep 20 10:30 lost+found

# mkdir inh_dir
# efsmgr -E inh_dir
# mv file[1-3] inh_dir/

# ls -U inh_dir/
total 48
-rw-r--r--e 1 root system 17 Sep 20 13:49 file1
-rw-r--r--e 1 root system 17 Sep 20 11:53 file2
-rw-r--r--e 1 root system 17 Sep 20 10:54 file3
```

Of special note are the following:

- ▶ Inheritance can be deactivated with the `efsmgr -D /path/directory` command.

- ▶ Use the **efsmgr -s -E /fsmountpoint** command and the **efsmgr -s -D /fsmountpoint** command to set or unset inheritance on file system level.

Note: Enabling or disabling inheritance has no effect to already existing files in the directory or file system. You must use the **efsmgr** command to change the encryption settings.

2.3.8 Considerations

The following are general considerations:

- ▶ Make backups of your keystores.
- ▶ The RSA keys of the users keystore are automatically loaded into the kernel on login as long as the user login and keystore password are identical. If this is not the case, user must run the **efskeymgr -o ksh** command and enter the user password. You can exchange the ksh shell with another shell if needed.
- ▶ In order to successfully encrypt or decrypt a file, there must be enough free space in the file system where free space \geq filesize.
- ▶ An encrypted file does not occupy more file system space. Note that 4 KB is added to size because of the encrypted metadata in the extended attributes per file. In environments with large numbers of files, this might be relevant.
- ▶ Once a JFS2 file system is EFS enabled, it cannot be undone.
- ▶ DIO/CIO modes on encrypted files will not perform as well as on regular files.
- ▶ Performance of encryption should be verified in advance before activating EFS on a productive environment to ensure it meets your requirements.
- ▶ System workload partitions (WPARs) are supported. After executing the **efsenable** command in the global environment, all system WPARs can use EFS.
- ▶ The file systems `/`, `/usr`, `/var`, and `/opt` cannot be EFS enabled.
- ▶ With AIX Version 6.1, you cannot store the RSA Keys on an LDAP server.
- ▶ NFS exports of a EFS file system are not supported.
- ▶ EFS is an AIX V6.1 or later feature and can be used only with JFS2. Previous AIX versions are not supported.
- ▶ To be able to do backups of encrypted data, the manufacturer of your backup software must provide support for EFS. Note that the AIX commands **backup**, **tar** and **cpio** are already enabled to handle encrypted files.

2.4 iSCSI target mode software solution

As an enhancement of AIX V6.1, the iSCSI target software device driver can be used over a Gigabit (or higher speed) Ethernet adapter and host-located TCP/IP stack enabling AIX to act as one iSCSI target device or as several iSCSI target devices. The iSCSI target driver exports local disks or logical volumes to iSCSI initiators that connect to AIX using the iSCSI protocol that is defined in the RFC 3720 and TCP/IP.

Each target device has an iSCSI Qualified Name and a set of logical unit numbers (LUNs) that are available to initiators that connect to the virtual iSCSI target. For each target device, you can specify which network interface and which TCP/IP port numbers the target driver can use to accept incoming connections.

Note: The iSCSI target mode software solution is available in the AIX V6.1 Expansion Pack . Please refer to your AIX V6.1 release notes for more detailed information.

2.4.1 iSCSI software target considerations

The name for each virtual iSCSI virtual target is specified through the SMIT menus. It is recommended to use iSCSI Qualified Name (IQN) convention to specify this name. There is no restriction as to the name convention, but not using an IQN name might prevent initiators from logging to the defined target.

To display the current name of an iSCSI target device and verify if it uses the proper name convention issue the following command and look for the `iscsi_name` field value:

```
# lsattr -E -l target0
```

In the previous example, `target0` represents the name of the iSCSI software target device.

2.4.2 SMIT interface

iSCSI configuration is done using SMIT menus. To configure iSCSI target mode software driver you use the following SMIT path.

Devices → iSCSI → iSCSI Target Device

You can also use the SMIT menu shortcut `smit tmiscsi` to access the iSCSI software target menu.

Note: For detailed configuration on the iSCSI software target driver refer to the AIX V6 Information Center and man pages.

In addition to the SMIT menus, the `lsdev` and `rmdev` commands can be used for listing and removal of iSCSI target mode software devices.



Workload Partitions overview and resource management

This chapter discusses Workload Partitions (WPARs). WPARs are virtualized software-based partitions running within one AIX V6.1 operating system instance. This chapter contains the following sections:

- 3.1, “Overview” on page 54
- 3.2, “WPAR based system virtualization” on page 55
- 3.3, “Management tools” on page 55
- 3.4, “System trace support” on page 57
- 3.5, “File system metrics support” on page 63
- 3.6, “Network metrics support” on page 64
- 3.7, “Performance tools updates for WPAR support” on page 64
- 3.8, “Standard command updates for WPAR support” on page 90

3.9, “Network file system support for WPARs” on page 94

3.1 Overview

WPARs are virtualized software based partitions running within one AIX V6.1 operating system instance.

WPAR virtualized hardware resources, such as memory and disk space, are partitioned by the operating system for the purpose of isolating specific applications or AIX workload environments. In contrast to LPARs, multiple WPARs can be created within a single OS copy, therefore a single LPAR running AIX V6.1 can contain multiple WPARs.

In general, LPARs are used to virtualize a system at the hardware level, while WPARs are used to virtualize a running AIX V6.1 system running at the software level.

There are two forms of workload partitions:

System WPAR Presents an environment most similar to a standalone AIX system. This WPAR type runs most of the system services that would be found in a standalone system and does not share writable file systems with any other WPAR or the global system.

Application WPAR Has all the process isolation that a system WPAR provides, except that it shares file system name space with the global system and any other application WPAR defined within the system. Other than the application itself, a typical Application WPAR only runs an additional light weight init process within the WPAR.

In this publication, we do not intent to cover all details of WPAR concepts, capabilities, and planning, but rather discuss specific AIX V6.1 features enabled for support of WPAR environment.

Note: For a detailed list of WPARs concepts and functionality, refer to *Introduction to Workload Partition Management in IBM AIX Version 6*, SG24-7431.

3.2 WPAR based system virtualization

WPAR provides a solution for partitioning one AIX operating instance in multiple encapsulated environments: each environment, called a workload partition, can host applications and execute them isolated from applications running within other WPARs.

Figure 3-1 illustrates how WPARs can be implemented within multiple AIX instances of the same physical server, whether they execute in dedicated LPARs or micro partitions.

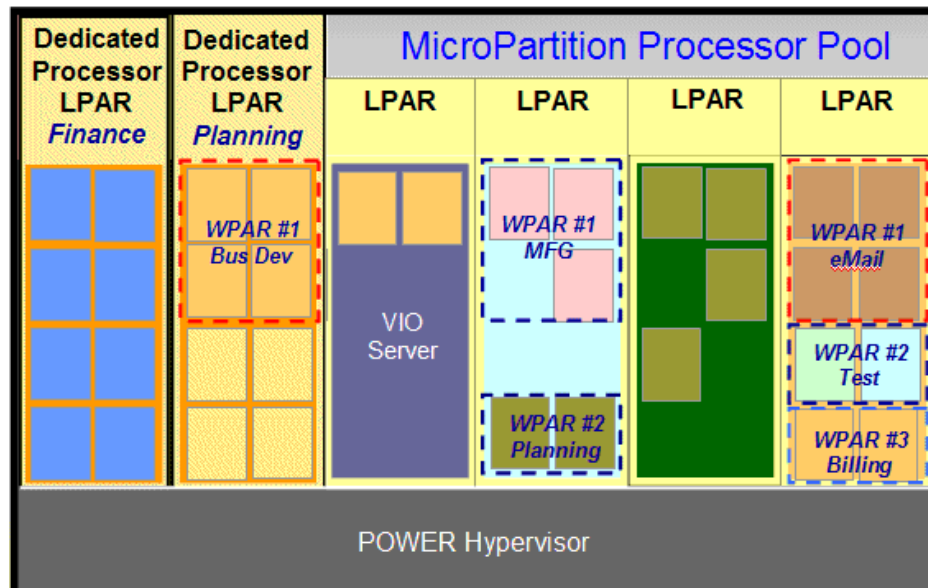

Figure 3-1 Multiple WPAR execution environments

The example above shows how a WPAR can be implemented across a fully virtualized IBM System p server environment. Each process running on a WPAR is isolated from the rest of the environment.

3.3 Management tools

Table 3-1 on page 56 lists the different AIX V6.1 WPAR management tools. For more details about each individual management tool listed in this publication please refer to the *Introduction to Workload Partition Management in IBM AIX Version 6*, SG24-7431, Chapter 3. *Overview of WPAR Management Tools*.

Table 3-1 WPAR management options

Tool or function	Part of	Usage
AIX Command line interface	AIX Base	Creation, activation, modification and deletion of WPARs
SMIT/smitty	AIX Base	Identical to CLI usage
WLM	AIX Base	WLM provides the underlying technology for WPAR resource management, but is not directly used by system administrators to manage WPARs.
WPAR checkpoint and relocation command line interface	IBM Workload Partitions Manager™ for AIX	A checkpoint of the runtime status of a WPAR, that can be used to resume a workload at a specific point of its execution, and optionally to move it to a different server.
WPAR Manager GUI	IBM Workload Partitions Manager for AIX	Automation of WPAR relocation, load balancing, metering, inventory, performance data collection, policy based mobility.

3.3.1 Packaging

The WPAR management tools features provided in Table 3-1 listed as AIX Base are part of the AIX built-in operating system features.

The WPAR built-in AIX features are provided by the bos.wpars filesets.

The WPAR Manager, an additional program, consists of the filesets:

mcr.rte	The support for WPAR mobility
wparmgt.agent.rte	The WPAR agent executing in all LPARs containing managed WPARs
wparmgt.mgr.rte	The WPAR manager, executing in the management LPAR.

wparmgt.cas.agent	The Common Access Service agent executing in all LPARs containing managed WPARs
wparmgt.cas.agentmgr	The Common Access Service agent executing in the management LPAR.
tivoli.tivguid	The Graphical User Interface
lwi.rte	Eclipse based LightWeight Infrastructure (LWI) runtime.

There is no fileset providing the WPAR Agent Console role. The console can be accessed by any web browser running on a workstation with an IP connection to the WPAR manager.

3.4 System trace support

This section discusses WPAR metrics support for system trace and disk Input/Output metrics.

3.4.1 Overview

The trace facility helps in isolating system problems by monitoring selected system events. Events that can be monitored include: entry and exit to selected subroutines, kernel routines, kernel extension routines, and interrupt handlers. When the trace facility is active, information about these events is recorded in a system trace log file.

The trace facility includes commands for activating and controlling traces and generating trace reports.

Applications and kernel extensions can use several subroutines to record additional events. These trace reports can then be used by performance tools to make evaluations of system performance and activity.

3.4.2 WPAR tracing capabilities

In AIX Version 6.1, system trace is WPAR aware. Trace entries are able to be correlated to the WPAR that the trace belongs to. This allows administrators and performance tools to determine usage based on WPARs.

The following functions have been added in AIX V6.1 for WPAR support of trace capabilities.

- ▶ Launch a trace from within a WPAR

- ▶ Ability to correlating a trace entry to a WPAR
- ▶ Filtering which WPARs trace entries to log (global only)
- ▶ Filtering which WPARs entries to report (global only)
- ▶ Running more than one kernel trace at the same time
- ▶ Additional trace utility hooks
- ▶ Ability to run more than one kernel trace at the same time

Both the **trace** and **trcrpt** commands support filtering based on WPARs. This helps the global system from collecting unnecessary trace entries for WPARs, and the opposite, which helps reducing the amount of trace entries in the trace buffer. Also, when displaying a report the user is now able to only display trace entries for desired WPARs.

3.4.3 Trace WPAR filtering from the global environment

The **trace** command now supports the parameters for filtering WPAR specific system traces provided in Table 3-2.

Table 3-2 New trace command WPAR filtering options

Filtering option	Description
-W	Includes the workload partition's configured ID (CID) for the current process with each hook. This flag is only valid in the Global system in a workload partition environment
-@ WPARName [,WPARName]	Traces on the listed workload partitions. Multiple WPAR names can be separated by commas or enclosed in quotes and separated by spaces. Specify <i>Global</i> to include the current Global system into the trace. This flag is only valid in the Global system in a workload partition environment.

Note: The **trcrpt** command can report the WPAR's CID whether or not the W option is specified as long as the following events are being traced: 134, 139, 210, 465, 5D8 or the hooks group wpar (-J wpar).

SMIT trace fastpath

The SMIT panel to start a trace is now updated to include the additional options for tracing only certain WPARs and including the WPAR CID in the trace entries. Figure 3-2 on page 59 shows the SMIT panel changes. New in this version are

the last two fields. To access this SMIT panel you must issue the following command:

```
# smitty trcstart
```

```

START Trace
-----
Type or select values in entry fields.
Press Enter AFTER making all desired changes.

                                [Entry Fields]
EVENT GROUPS to trace                []                +
ADDITIONAL event IDs to trace         []                +
Event Groups to EXCLUDE from trace    []                +
Event IDs to EXCLUDE from trace       []                +
Process IDs to Trace                  []                +
Program to Trace                      []                +
Propagate Tracing to                  [new processes and thr> +
Trace MODE                            [alternate]        +
STOP When Logfile full?               [no]               +
LOG FILE                              [/var/adm/ras/trcfile]
SAVE PREVIOUS logfile?                [no]               +
Omit PS/NM/LOCK HEADER to log file?   [yes]              +
Omit DATE-SYSTEM HEADER to log file?  [no]               +
Run in INTERACTIVE mode?              [no]               +
Trace BUFFER SIZE in bytes            [262144]           #
LOG FILE SIZE in bytes                [2621440]          #
Buffer Allocation                     [automatic]        +
WPAR names to Trace                   []                +
Save WPAR's CID in trace entries?     [no]               +

F1=Help          F2=Refresh      F3=Cancel      F4=List
F5=Reset         F6=Command     F7=Edit        F8=Image
F9=Shell         F10=Exit       Enter=Do

```

Figure 3-2 SMIT trcstart fastpath menu options

SMIT trace panel field details

These fields are not valid if ran within a WPAR. If values are specified from within a WPAR then the command will fail. Table 3-3 on page 60 describes the new added fields.

Table 3-3 New trace fields for WPAR smitty trcstart panel

Field name	Description	Values
WPAR names to Trace	Specify the WPAR names of the currently running WPARs to be traced. Specify keyword Global, to include this system in the trace. If you do not specify a value, all WPARs and the Global will be traced.	A list of WPAR names to be included in the trace. Global should be used to indicate this system. If no value is specified then all WPARs and the Global will be traced. If just WPAR names are specified then only those WPARs will be traced and the Global will not.
Save WPAR's CID in trace entries?	Select yes to save the WPAR's configuration ID (CID) in each trace entry. These CIDs can then be displayed and used in filtering in the trcrpt command.	Default value of no, means do not include WPAR's CID in trace. Field can be toggled between no and yes, using the tab key.

3.4.4 Trace report filtering from the Global environment

Similar to the **trace** command filtering, the **trcrpt** command is able to filter which WPARs it is interested in. This requires trace entries that are placed in the trace log to be able to be correlated to the appropriate WPAR and reducing the amount of data reported. Additionally there is also an option to display the CID or the WPAR name for each trace entry in the report.

The **trcrpt** command now supports a new **-@ <WPARList>** as well as new **-O** options for filtering WPAR specific system traces. Table 3-4 contains detailed description of these new parameters.

Table 3-4 New trcrpt command WPAR filtering options

Filtering option	Description
-@ <WPARList>	Will only display trace entries that were collected for the indicated WPARs. The WPARList can contain either WPAR names or WPAR IDs. A WPAR ID of '0' or WPAR name of 'Global' will display the trace entries for the Global system.
-O wparname=[on off]	The new -O option displays the workload partition names in the trace report. The default value is off.

Filtering option	Description
-O cid=[on off]	The new -O option displays the workload partition's configured ID (CID) in the trace report. The default value is off.

SMIT trace report fastpath

The SMIT panel for trace reports is now updated to include the additional options of filtering on WPARs and displaying the WPAR name or the WPAR CID in the report. Figure 3-3 shows the SMIT panel display changes for the new panel that include these new options (*highlighted*). To access this SMIT panel you must issue the following command:

```
# smitty trcrpt
```

Generate a Trace Report

Type or select values in entry fields.
Press Enter AFTER making all desired changes.

[Entry Fields]		
Show exec PATHNAMES for each event?	[yes]	+
Show PROCESS IDs for each event?	[no]	+
Show THREAD IDs for each event?	[no]	+
Show WPAR Names for each event?	[no]	+
Show WPAR CIDs for each event?	[no]	+
Show CURRENT SYSTEM CALL for each event?	[yes]	+
Time INCREMENTS for report	[elapsed only]	+
Event Groups to INCLUDE in report	[]	+
IDs of events to INCLUDE in report	[]	+X
Event Groups to EXCLUDE from report	[]	+
IDs of events to EXCLUDE from report	[]	+X
WPARs to include in report	[]	
STARTING time	[]	
ENDING time	[]	
LOG FILE to create report from	[/var/adm/ras/trcfile]	
FILE NAME for trace report (default is stdout)	[]	

F1=Help	F2=Refresh	F3=Cancel	F4=List
F5=Reset	F6=Command	F7=Edit	F8=Image
F9=Shell	F10=Exit	Enter=Do	

Figure 3-3 SMIT panel for smitty trcrpt panel fast path option

SMIT trace report panel field details

The highlighted fields are not valid if run within a WPAR. If values are specified from within a WPAR then the command will fail. Table 3-5 on page 62 below describes the new added fields.

Table 3-5 New trace report filtering fields for WPAR in the `smitty trcrpt` panel

Field name	Description	Values
Show WPAR Names for each event?	Select whether you wish the WPAR Names to be displayed (or printed) in the trace report. The default is no.	Default value of no , means do not show WPAR Names in report. Field can be toggled between no and yes, using the tab key.
Show WPAR CIDs for each event?	Select whether you wish the WPAR configured IDs (CID) to be displayed (or printed) in the trace report. The default is no.	Default value of no, means do not show WPAR CIDs in report. Field can be toggled between no and yes, using the tab key.
WPARs to INCLUDE in report	Specify a list of WPARs to be included in the trace report.	A list of WPAR names or configured IDs (CID) that the trace report should use for filtering. If not specified trace entries for all WPARs will be reported. Use Global or 0, if filtering on WPARs and you want the Global's trace entries.

3.4.5 Tracing from within a WPAR

The ability to filter and trace based on a WPAR is beneficial to the administrator of the Global system. However it is also very beneficial for the administrator of the WPAR itself to run trace and collect trace reports based on its WPAR activities

The ability to trace from within a WPAR is an AIX V6.1 supported feature. The **trace** and **trcrpt** commands work the same as in the Global environment with the exception to the WPAR specific options available for WPAR filtering from the Global. Those are not required or valid from within a WPAR.

Enabling trace

In order to be able to start trace from within a WPAR this privilege needs to be enabled since it is not enabled by default. The trace facility can be enabled during and after the creation of a WPAR using both the command line and the SMIT panels:

To enable trace using the command line interface, use the **mkwpar** or **chwpar** commands with the following syntax:

```
# chwpar -n WPARname -S privs+=PV_KER_RAS
```

In the example, WPARname is the name of your existing WPAR.

To enable trace using the SMIT panel menus, you can use the following sequence; For this example we use a System WPAR:

```
# smitty wpar
```

Administer SYSTEM Workload Partitions → Change / Show System Workload Partition Characteristics → Change / Show General Characteristics

Select the WPAR to change and include the PV_KER_RAS privilege in the Privileges field.

Multi-session trace support

Due the nature of WPARs, administrators for multiple WPARs may want to run a trace based performance tool at the same time or at the same time as the Global.

Important: The current implementation of system trace allows one instance of trace to be run in the Global environment and seven for WPARs concurrently.

Tracing capabilities are not available for Application type WPARs . The **trace** command system services are not extended to it. The same is true for trace based commands such as **filemon**, **netpmon**, **pprof**, **tprof**, and **curt**.

3.5 File system metrics support

I/O statistics are heavily used by system administrators to determine if excess I/O is causing system performance issues. This data is then used by the administrators to reorganize their activities to increase their systems utilization.

To provide meaningful I/O file system metrics for users of WPAR and AIX V6.1 systems in general, file system metrics are collected at the logical file system (LFS) layer. Since System WPARs have a separate mount for each file system that it has, even if shared from the Global (namefs), each mounted file system has its metrics specific to that mounted file system. In addition to that, there are also metrics information for remotely mounted file systems to give a logical view of the clients activity on that file system.

For WPAR specific usage, a given WPAR only collect metrics for the file systems that belong to it.

For more information about collecting I/O related statistics for WPARs see 3.7.3, “Updates for the iostat command” on page 70, and 3.7.9, “Updates for the topas command” on page 82.

3.6 Network metrics support

Network metrics are very important statistical data gathered and analyzed by AIX administrators. This metric data is also consumed by user applications to make decisions based in the network performance of the system.

Existing network statistics are gathered from the network adapter all the way up to the UDP/TCP layer. WPARs, however, do not have access to the physical devices. Network activity for a WPAR is managed by utilizing alias in the Global environment to attach the WPAR's IP to an existing Global environment interface. These alias based IPs are attached to the appropriate WPAR's socket, thus enabling a WPAR to access its packets in the network.

To display and monitor the network statistics for WPARs the **netstat** command has been updated with the following capabilities:

- ▶ Ability to display network statistics for a given WPAR from the Global environment through the new **-@ WPARname** flag.
- ▶ Ability to run the command from within a WPAR and display statistics relevant to its isolated environment.

The following is a list the supported **netstat** flags from the WPAR environment:

```
netstat [-Aaon] [-f address_family]
          [-inrsu] [-f address_family] [-p proto]
          [-n] [-I interface] [interval]
```

Flags not included in the list are not supported from the Global environment with the **-@** flag.

3.7 Performance tools updates for WPAR support

Performance monitoring is an important task for AIX system administrators. The addition of WPAR in this version of the operating system facilitates the gathering and filtering of performance related statistic of selective applications and workloads isolated in both the Global environment, and WPARs.

This section discusses the following AIX V6.1 performance tools updates to support proper tracking and filtering of system performance data for WPARs, listed in alphabetical order:

- ▶ 3.7.1, “Updates for the `curt` command” on page 65
- ▶ 3.7.2, “Updates for the `filemon` command” on page 67
- ▶ 3.7.3, “Updates for the `iostat` command” on page 70
- ▶ 3.7.4, “Updates for the `netpmn` command” on page 73
- ▶ 3.7.5, “Updates for the `pprof` command” on page 76
- ▶ 3.7.6, “Updates for the `procmon` plug-in” on page 78
- ▶ 3.7.7, “Updates for the `proctree` command” on page 79
- ▶ 3.7.8, “Updates for the `svmon` command” on page 81
- ▶ 3.7.9, “Updates for the `topas` command” on page 82
- ▶ 3.7.10, “Updates for the `tprof` command” on page 85
- ▶ 3.7.11, “Updates for the `vmstat` command” on page 87

Due to the extensive amount of information contained on each one of the commands, this publication does not describe all the details of the changes, but rather provides a few examples the authors considered useful.

For a detailed list of changes on a specific AIX updated command, refer to the man pages or the AIX V6.1 product documentation.

3.7.1 Updates for the `curt` command

The `curt` command is used to convert an AIX trace file into a number of statistics related to CPU utilization (application, kernel, NFS, Flih, Slih, Wait), and either process, thread or pthread activity.

The following enhancements have been made to this performance tool to support WPAR specific metrics:

- ▶ Ability to filter statistics for a given WPAR, or WPAR list from the Global environment.
- ▶ Ability to display organized statistics for all active WPARs from the global environment.
- ▶ Ability to run the command from within a WPAR and display statistics relevant to its isolated environment.

Important: In order to use this command within a WPAR, trace privileges must be enabled in the WPAR. Rrefer to the “Enabling trace” on page 62 topic.

Table 3-6 describes the updates made to this command for support of WPARs:

Table 3-6 Option changes for *curt* command

Flag/ Argument	Behavior in WPAR	Behavior in Global
“-@ Wparlist”	Fails with usage message as -@ Wparlist option is made illegal inside the WPAR.	Prints relevant information for given WPAR only. If the specified WPAR does not exist, or is not active, or the trace have been taken in a non-WPAR system then it fails with workload partition not found message unless workload partition name is Global.
“-@ ALL”	Fails with usage message as -@ ALL option is made illegal inside the WPAR.	Executes normally and prints the summary of all WPARs. A workload partition name is displayed for each record.
“-@”	Fails with usage message as -@ option is made illegal inside the WPAR.	Executes normally and prints process tree with related WPARs and Global dependency. A workload partition name is displayed for each record. If trace have been taken in a non-WPAR system then it fails with trace file contains no WPAR error.
“-b”	Fails with usage message as -b option is made illegal inside the WPAR.	Will print the WPAR id of each process in the processes table, and an additional WPAR table associating active wpars to their cids.

When using **curt**, be aware fo the following details in the reports:

- ▶ Kproc Summary (by Tid), shows no indication of WPAR name because all kernel processes are branded to the Global environment.

- ▶ The **curt** command reports summaries of all the WPARs that were existing on the system during the time of a trace collection and their CPU consumption (one line per WPAR).

For each category (application, syscall, hcall, kproc, nfs, flih, slih) the amount of CPU time is expressed as a percentage of total processing time

The total amount of CPU time is expressed as percentage of the total processing time (of the system) in milliseconds.

3.7.2 Updates for the filemon command

The **filemon** command monitors the performance of the file system, and reports the I/O activity on behalf of logical files, virtual memory segments, logical volumes, and physical volumes. The command will always behave the same way in post-processing mode, regardless of whether it runs inside a WPAR or not.

The following enhancements have been made to this command to support WPAR specific metrics:

- ▶ The ability to filter I/O traced statistics for a given WPAR from the Global environment.
- ▶ The ability to display organized statistics for all active WPARs from the global environment.
- ▶ The ability to run the command from within a WPAR and display statistics relevant to its isolated environment.

Important: In order to use this command within a WPAR, trace privileges must be enabled in the WPAR. Refer to the “Enabling trace” on page 62 topic.

Table 3-7 describes the updates made to the **filemon** command for support of WPARs:

Table 3-7 Option changes for filemon command

Flag/ Argument	Behavior in WPAR	Behavior in Global
none	Executes the default report and displays information specific to the WPAR	Executes normally with no changes from previous versions of AIX.

Flag/ Argument	Behavior in WPAR	Behavior in Global
"-@ Wparlist"	Fails with usage message as -@ Wparlist option is made illegal inside the WPAR.	Prints relevant information for given WPAR only. If the specified WPAR does not exist or is not active then it fails with workload partition not found message unless workload partition name is Global.
"-@ ALL"	Fails with usage message as -@ ALL option is made illegal inside the WPAR.	Executes normally and prints the summary of all WPARs. A workload partition name is displayed for each record.
"-@"	Fails with usage message as -@ option is made illegal inside the WPAR.	Executes normally and prints additional WPAR information. A workload partition name is displayed for each record.

Important: When running the **filemon** command from the Global environment with any of the -@ options, always use the -O lf option. This is due WPARs restrictions. For example:

```
# filemon -O lf -@ mywpar1
```

Example 3-1 demonstrates the output of the **filemon** command ran without any parameters within the mywpar1 WPAR:

Example 3-1 The filemon command example

```
Cpu utilization: 100.0%
Cpu allocation: 75.5%
[filemon: Reporting started]
```

Most Active Files

```
-----
#MBs #opns #rds #wrs file volume:inode
-----
0.4 1 91 0 unix <major=10,minor=5>:9565
0.0 1 2 0 ksh.cat <major=10,minor=5>:17456
0.0 1 2 0 cmdtrace.cat <major=10,minor=5>:17280
0.0 9 2 0 SWservAt <major=10,minor=11>:123
0.0 9 2 0 SWservAt.vc <major=10,minor=11>:124
```

```
-----
Detailed File Stats
-----
```

```
FILE: /unix volume: <major=10,minor=5> inode: 9565
opens: 1
total bytes xfrd: 372736
reads: 91 (0 errs)
  read sizes (bytes): avg 4096.0 min 4096 max 4096 sdev 0.0
  read times (msec): avg 0.004 min 0.004 max 0.006 sdev 0.000
lseeks: 172

FILE: /usr/lib/nls/msg/en_US/ksh.cat volume: <major=10,minor=5> inode: 17456
opens: 1
total bytes xfrd: 8192
reads: 2 (0 errs)
  read sizes (bytes): avg 4096.0 min 4096 max 4096 sdev 0.0
  read times (msec): avg 0.005 min 0.004 max 0.006 sdev 0.001
lseeks: 5

FILE: /usr/lib/nls/msg/en_US/cmdtrace.cat volume: <major=10,minor=5> inode:
17280
opens: 1
total bytes xfrd: 8192
reads: 2 (0 errs)
  read sizes (bytes): avg 4096.0 min 4096 max 4096 sdev 0.0
  read times (msec): avg 0.005 min 0.005 max 0.005 sdev 0.000
lseeks: 8

FILE: /etc/objrepos/SWservAt volume: <major=10,minor=11> inode: 123
opens: 9
total bytes xfrd: 796
reads: 2 (0 errs)
  read sizes (bytes): avg 398.0 min 328 max 468 sdev 70.0
  read times (msec): avg 0.003 min 0.003 max 0.004 sdev 0.001
lseeks: 1

FILE: /etc/objrepos/SWservAt.vc volume: <major=10,minor=11> inode: 124
opens: 9
total bytes xfrd: 80
# reads: 2 (0 errs)
  read sizes (bytes): avg 40.0 min 40 max 40 sdev 0.0
  read times (msec): avg 0.003 min 0.002 max 0.003 sdev 0.000
lseeks: 1
[filemon: Reporting completed]
```

[filemon: 6.999 secs in measured interval]

As shown in the previous example, the `filemon` command now is WPAR aware and reports I/O statistics relevant to the WPAR where it is being run.

3.7.3 Updates for the `iostat` command

The `iostat` command is used to display and monitor I/O statistics. Such statistics are frequently used by system administrators to analyze system I/O throughput and potential bottlenecks.

The following enhancements have been made to this command to support WPAR specific metrics:

- ▶ The ability to filter I/O activities for a given WPAR from the Global environment.
- ▶ The ability to display organized statistics for all active WPARs from the global environment.
- ▶ The ability to run the command from within a WPAR and display statistics relevant to its isolated environment.
- ▶ A new command line option `-f`, that will display file systems utilization report.
- ▶ A new command line option `-F`, that displays file systems utilization report, and turns off other utilization reports.
- ▶ Support for the `-s`, `-T`, `-l`, `-V`, `-f`, `-F` options within a WPAR.

Table 3-8 describes the updates made to the `iostat` command for support of WPARs:

Table 3-8 Option changes for `iostat` command

Flag/ Argument	Behavior in WPAR	Behavior in Global
none	Executes the default report and displays an @ above the metrics specific to the WPAR	Executes normally with no changes from previous versions of AIX.
"-@ Wpname"	Fails with usage message as <code>-@ Wpname</code> option is made illegal inside the WPAR.	Prints relevant information for given WPAR only. If the specified WPAR does not exist or is not active then it fails with workload partition not found message unless workload partition name is Global.

Flag/ Argument	Behavior in WPAR	Behavior in Global
"-@ ALL"	Fails with usage message as -@ ALL option is made illegal inside the WPAR.	Executes normally and prints the summary of all WPARs. A workload partition name is displayed for each record.
"-a"	Fails with usage message as -a option is illegal inside the WPAR.	Executes normally and prints adapter throughput information associated to Global. This option cannot be used with the -@ option.
"-A"	Fails with usage message as -A option is illegal inside the WPAR.	Executes normally and prints asynchronous IO utilization information associated to Global. This option cannot be used with the -@ option.
"-d"	Fails with usage message as -d option is illegal inside the WPAR.	Executes normally turning off the display of TTY utilization report or CPU utilization report associated to Global. This option cannot be used with the -@ option.
"-D"	Fails with usage message as -D option is illegal inside the WPAR.	Executes normally and prints extended tape/drive utilization information associated to Global. This option cannot be used with the -@ option.
"-f"	Displays file system report, appended to default O/P.	Displays File system report only along with System configuration.
"-F"	Displays file system report only along with System configuration.	Displays File system report only along with System configuration.
"-m"	Fails with usage message as -m option is illegal inside the WPAR.	Executes normally and prints path utilization information associated to Global. This option cannot be used with the -@ option.

Flag/ Argument	Behavior in WPAR	Behavior in Global
"-P"	Fails with usage message as -P option is illegal inside the WPAR.	Executes normally and prints tape utilization information associated to Global. This option cannot be used with the -@ option.
"-q"	Fails with usage message as -q option is illegal inside the WPAR.	Executes normally and prints AIO queues and their request count information associated to Global. This option cannot be used with the -@ option.
"-Q"	Fails with usage message as -Q option is illegal inside the WPAR.	Executes normally and prints a list of all the mounted file systems and the associated queue numbers with their request counts associated to Global. This option cannot be used with the -@ option.
"-s"	Displays system throughput report.	Displays only TTY and CPU.
"-t"	Fails with usage message as -t option is illegal inside the WPAR.	Executes normally turning off the display of disk utilization report associated to Global. This option cannot be used with the -@ option.
"-z"	Fails with usage message as -z option is illegal inside the WPAR.	Executes normally resetting the disk input/output statistics associated to Global. Only root users can use this option. This option cannot be used with the -@ option.

The following example shows the output of the -@ ALL option when used in the Global environment:

```
# iostat -@ ALL
```

```
System configuration: lcpu=2 ent=0.30
```

```
tty:      tin      tout  avg-cpu: % user % sys % idle % iowait phisc % entc
          1.5      6.6           11.9  57.0  31.1    0.1  0.0  0.0
```



```

Disks:      % tm_act   Kbps    tps    Kb_read  Kb_wrtn
hdisk0      0.2          3.3     0.6     70685    100556
cd0         0.0          0.0     0.0         0         0
-----mywpar1-----
tty:      tin          tout    avg-cpu: % user % sys % idle % iowait physc % entc
          -          -                29.9 70.1  0.0    0.0  0.0  0.0
-----mywpar2-----
tty:      tin          tout    avg-cpu: % user % sys % idle % iowait physc % entc
          -          -                30.3 69.7  0.0    0.0  0.0  0.0
=====
#

```

As shown in the previous example, the **iostat** command now is WPAR aware and reports WPAR I/O relevant information from the Global environment.

3.7.4 Updates for the netpmon command

The **netpmon** command monitors a trace of system events, and reports on network activity and performance during the monitored interval such as CPU utilization, network device-driver I/O, Internet sockets calls, and NFS I/O. The command will always behave the same way in post-processing mode, regardless of whether it runs inside a WPAR or not.

The following enhancements have been made to this command to support WPAR specific metrics:

- ▶ The ability to filter network traced statistics for a given WPAR from the Global environment.
- ▶ The ability to display organized statistics for all active WPARs from the global environment.
- ▶ The ability to run the command from within a WPAR and display statistics relevant to its isolated environment.

Important: In order to use this command within a WPAR, trace privileges must be enabled in the WPAR. Refer to the “Enabling trace” on page 62 topic.

Table 3-9 on page 74 describes the updates made to the **netpmon** command for support of WPARs:

Table 3-9 Option changes for netpmon command

Flag/ Argument	Behavior in WPAR	Behavior in Global
none	Executes the default report and displays information specific to the WPAR	Executes normally with no changes from previous versions of AIX.
"-@ Wparname"	Fails with usage message as -@ Wparlist option is made illegal inside the WPAR.	Prints relevant information for given WPAR only. If the specified WPAR does not exist or is not active then it fails with workload partition not found message unless workload partition name is Global"
"-@ ALL"	Fails with usage message as -@ ALL option is made illegal inside the WPAR.	Executes normally and prints the summary of all WPARs. A workload partition name is displayed for each record.
"-@"	Fails with usage message as -@ option is made illegal inside the WPAR.	Executes normally and prints additional WPAR information. A workload partition name is displayed for each record.

Example 3-2 demonstrates the output of the **netpmon -@** command when ran within the Global environment:

Example 3-2 The netpmon command in a global environment

```
Fri Oct 5 15:05:21 2007
System: AIX 6.1 Node: server5 Machine: 00C0F6A04C00
```

```
=====
=
```

Process CPU Usage Statistics:

```
-----
```

Process (top 20)	PID	CPU Time	Network		WPAR
			CPU %	CPU %	
trcstop	454690	0.0029	9.182	0.000	Global
getty	303290	0.0014	4.419	0.000	Global
wlmsched	65568	0.0012	3.725	0.000	Global

```
-----
```

ksh	381130	0.0009	2.739	0.439	Global
xmgc	49176	0.0008	2.632	0.000	Global
gil	61470	0.0008	2.356	2.356	Global
swapper	0	0.0007	2.125	0.000	Global
java	270528	0.0005	1.491	0.000	Global
netpmon	393260	0.0005	1.418	0.000	Global
sched	12294	0.0003	0.977	0.000	Global
netpmon	454688	0.0002	0.779	0.000	Global
lockd-1	426196	0.0002	0.741	0.000	Global
rpc.lockd	139406	0.0001	0.465	0.000	Global
sendmail:	332014	0.0001	0.204	0.000	mywpar1
init	368830	0.0001	0.189	0.000	mywpar1
sendmail:	204900	0.0001	0.182	0.000	Global
pilegc	45078	0.0000	0.079	0.000	Global
aixmibd	123008	0.0000	0.069	0.000	Global
rmcd	266378	0.0000	0.052	0.000	Global
netm	57372	0.0000	0.046	0.046	Global

Total (all processes)		0.0108	33.871	2.841	
Idle time		0.0083	25.906		

=====
=

First Level Interrupt Handler CPU Usage Statistics:

FLIH	CPU Time	CPU %	Network CPU %

PPC decremter	0.0089	27.944	0.000
data page fault	0.0016	5.026	0.000
external device	0.0003	1.086	0.011
queued interrupt	0.0000	0.055	0.000

Total (all FLIHs)	0.0109	34.112	0.011

=====
=

Second Level Interrupt Handler CPU Usage Statistics:

SLIH	CPU Time	CPU %	Network CPU %

<addr= 0x40cf618>	0.0006	1.740	0.077

```

-----
Total (all SLIHs)                0.0006  1.740  0.077
=====
=

Detailed Second Level Interrupt Handler CPU Usage Statistics:
-----

SLIH: <addr=          0x40cf618>
count:                42
  cpu time (msec):    avg 0.013  min 0.009  max 0.035  sdev 0.005

COMBINED (All SLIHs)
count:                42
  cpu time (msec):    avg 0.013  min 0.009  max 0.035  sdev 0.005

```

As shown in the previous example, the **netpmn** command now is WPAR aware and displays CPU and network related statistics relevant to the Global and WPAR environments.

3.7.5 Updates for the pprof command

The **pprof** command is used to report CPU usage of all kernel threads over a period of time. This tool uses the trace facility, allowing for the generation of reports for previously ran traces. The command will always behave the same way in post-processing mode, regardless of whether it runs inside a WPAR or not.

The following enhancements have been made to this command to support WPAR specific metrics:

- ▶ The ability to filter processes for a given WPAR, or WPAR list from the Global environment.
- ▶ The ability to display organized statistics for all active WPARs from the global environment.
- ▶ The ability to run the command from within a WPAR and display statistics relevant to its isolated environment.

Important: In order to use this command within a WPAR, trace privileges must be enabled in the WPAR. Refer to the “Enabling trace” on page 62 topic.

Table 3-10 on page 77 provides the updates made to this command for support of WPARs.

Table 3-10 Option changes for pprof command

Flag/ Argument	Behavior in WPAR	Behavior in Global
"-@ Wparlist"	Fails with usage message as -@ Wparlist option is made illegal inside the WPAR.	Prints relevant information for given WPAR only. If the specified WPAR does not exist or is not active then it fails with workload partition not found message unless workload partition name is Global.
"-@ ALL"	Fails with usage message as -@ ALL option is made illegal inside the WPAR.	Executes normally and prints the summary of all WPARs. A workload partition name is displayed for each record.
"-@"	Fails with usage message as -@ option is made illegal inside the WPAR.	Executes normally and prints process tree with related WPARs and Global dependency. A workload partition name is displayed for each record.

Example 3-3 demonstrates the pprof.cpu file output of the **pprof 2 -@** command:

Example 3-3 pprof.cpu output file sample

```

Pprof CPU Report

Sorted by Actual CPU Time

From: Fri Oct 5 07:34:38 2007
To:   Fri Oct 5 07:34:40 2007

E = Exec'dF = Forked
X = ExitedA = Alive (when traced started or stopped)
C = Thread Created

Pname      PID      PPID BE      TID      PTID  ACC_time STT_time STP_time STP-STT  WPARs
-----
syncd     102564      1 AA    209013    0      0.010   1.015   1.126   0.111 Global
wait      8196        0 AA     8197     0      0.006   0.009   2.020   2.011 Global
pprof     430170     491578 AA    1831047    0      0.001   0.009   2.028   2.019 Global
sh        524344     430170 EE    1315027  1831047 0.001   0.018   0.019   0.001 Global
nfsd     278674      1 AA    364727    0      0.001   1.737   1.737   0.001 Global
xmgc     49176       0 AA    61471    0      0.001   1.027   1.028   0.001 Global
wlmsched 65568       0 AA    98353    0      0.001   0.048   1.952   1.903 Global
getty    315560      1 AA    577593    0      0.001   0.028   2.012   1.984 Global
swapper   0           0 AA     3         0      0.001   0.078   1.979   1.901 Global
pprof     377082     491578 AX    1622045    0      0.000   0.009   0.009   0.000 Global
pprof     524346     430170 FE    1315029  1831047 0.000   2.020   2.021   0.000 Global
pprof     524344     430170 FE    1315027  1831047 0.000   0.010   0.010   0.000 Global
java     290966     311468 AA    983265    0      0.000   0.908   1.128   0.220 Global

```

```

/usr/bin/sleep 524344 430170 EX 1315027 1831047 0.000 0.020 2.020 2.000 Global
rmcd 327764 303290 AA 1188057 0 0.000 1.387 1.387 0.000 mywpar1
wait 53274 0 AA 65569 0 0.000 0.009 0.178 0.169 Global
gil 61470 0 AA 90157 0 0.000 0.105 1.938 1.833 Global
gil 61470 0 AA 86059 0 0.000 0.298 1.605 1.307 Global
rmcd 262334 213132 AA 552979 0 0.000 0.072 0.072 0.000 Global
sched 12294 0 AA 12295 0 0.000 0.978 0.978 0.000 Global
sendmail: 122980 213132 AA 274587 0 0.000 0.077 0.077 0.000 Global
java 290966 311468 AA 532489 0 0.000 0.736 1.737 1.001 Global
nfsd 278674 1 AA 368827 0 0.000 0.038 1.841 1.803 Global
java 290966 311468 AA 975069 0 0.000 0.737 1.737 1.001 Global
gil 61470 0 AA 81961 0 0.000 0.098 1.898 1.800 Global
rpc.lockd 266418 1 AA 389365 0 0.000 0.038 1.841 1.803 Global
lockd-1 401640 1 AA 708773 0 0.000 0.038 1.841 1.803 Global
lockd-2 364698 1 AA 1269907 0 0.000 0.038 1.841 1.803 Global
gil 61470 0 AA 94255 0 0.000 0.411 1.698 1.288 Global
nfsd 278674 1 AA 405711 0 0.000 0.479 1.681 1.202 Global
lockd-2 364698 1 AA 1351829 0 0.000 0.429 1.631 1.202 Global
lockd-1 401640 1 AA 1056843 0 0.000 0.248 1.451 1.203 Global
rpc.lockd 266418 1 AA 422099 0 0.000 0.411 1.618 1.207 Global
java 290966 311468 AA 634935 0 0.000 0.737 1.737 1.001 Global
pilegc 45078 0 AA 69667 0 0.000 1.090 1.090 0.000 Global
pilegc 45078 0 AA 45079 0 0.000 1.090 1.090 0.000 Global
netm 57372 0 AA 73765 0 0.000 1.153 1.153 0.000 Global
lockd-2 364698 1 AA 1335445 0 0.000 1.972 1.972 0.000 Global
/usr/bin/trcstop 524346 430170 EA 1315029 1831047 0.000 2.028 2.028 0.000 Global
sh 524346 430170 EE 1315029 1831047 0.000 2.023 2.023 0.000 Global
=====
0.024

```

As shown in the previous example, the **pprof** command is now WPAR aware and reports individual processes relevant to WPARs.

3.7.6 Updates for the procmon plug-in

The procmon plug-in is part of the Performance WorkBench graphical user interface. This plug-in helps to monitor the processes running on the AIX system and displays information such as CPU, memory, and entitlement on the current partition.

The following enhancements have been made to this command to support WPAR specific metrics:

- ▶ The partition performance tab has been updated to display the number of WPARs and their state in the current LPAR.
- ▶ There is a new tab displaying existing WPARs on the current LPAR with more detailed estate information such as name, host name, and type.
- ▶ The processes tab now indicates processes and their relationship to the Global or WPAR environments.

Figure 3-4 on page 79 shows processes in the virtual environment they belong to under displayed in the WPAR column. If a process belongs to the Global environment the field will read Global. If the process belongs to a WPAR then it will display the WPAR name.

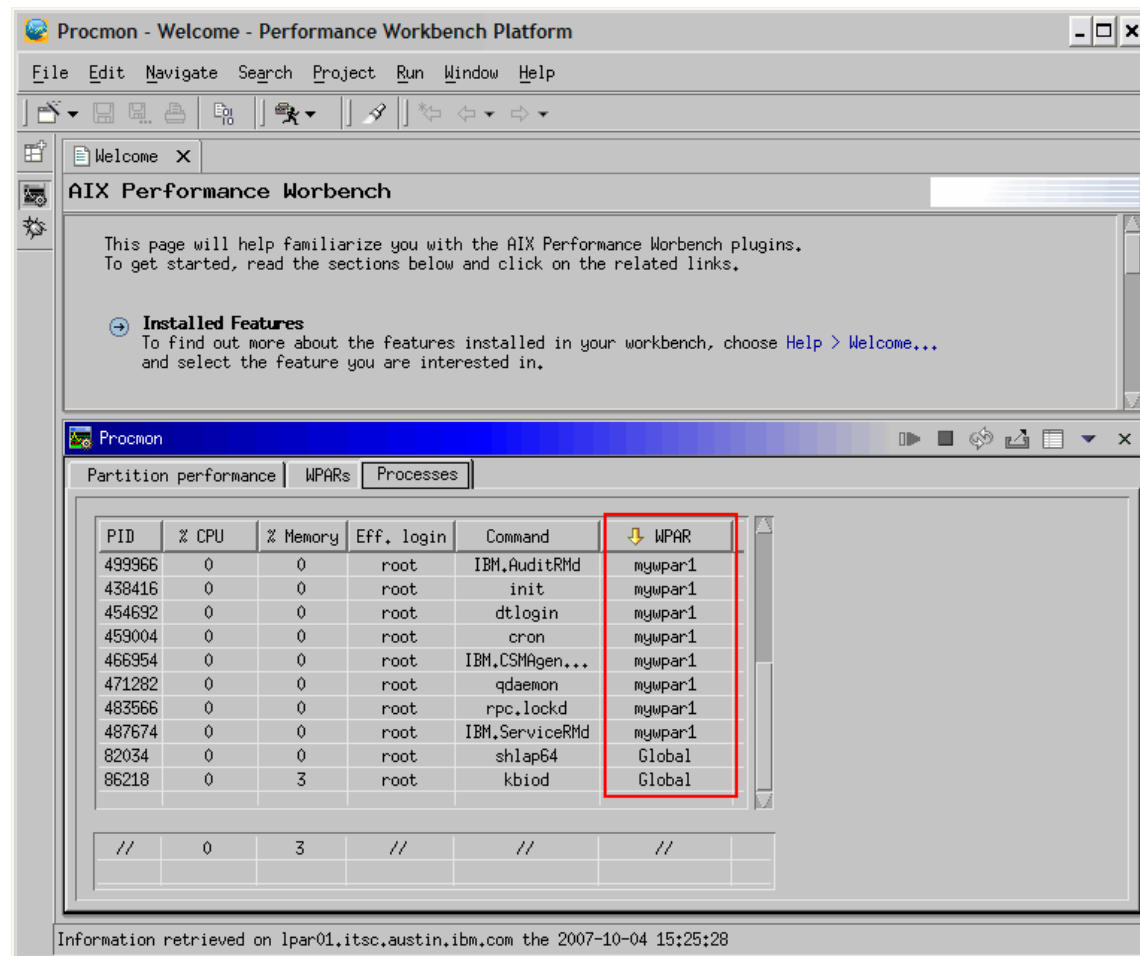

Figure 3-4 Performance Workbench - Processes tab view

The new WPAR column (*highlighted*) as shown in Figure 3-4 allows the user to sort the processes by WPAR if desired.

3.7.7 Updates for the proctree command

The **proctree** command is used to print the process tree contained in a hierarchy specified by a given process or user ID. The output shows children processes indented from their respective parent processes. An argument of all digits is taken to be a process ID, otherwise it is assumed to be a user login name.

The following enhancements have been made to this command to support WPAR specific metrics:

- ▶ The ability to filter processes for a given WPAR from the Global environment.
- ▶ The ability to display organized statistics for all active WPARs from the global environment.
- ▶ The ability to run the command from within a WPAR and display statistics relevant to its isolated environment.

Table 3-11 describes the updates made to this command for support of WPARs:

Table 3-11 Option changes for proctree command

Flag/ Argument	Behavior in WPAR	Behavior in Global
none	Executes the default report and displays only the process tree specific to the WPAR	Executes normally with no changes from previous versions of AIX.
"-@ Wparname"	Fails with usage message as -@ Wparname option is made illegal inside the WPAR.	Prints relevant information for given WPAR only. If the specified WPAR does not exist or is not active then it fails with workload partition not found message unless workload partition name is Global.
"-@"	Fails with usage message as -@ option is made illegal inside the WPAR.	Executes normally and prints process tree with related WPARs and Global dependency. A workload partition name is displayed for each record.

The following example demonstrates the output of the -@ option when used in the Global environment:

```
# proctree -@ mywpar1
mywpar1  438416  /etc/init
mywpar1  348294  /usr/sbin/srcmstr
mywpar1  188466  /usr/sbin/biod 6
mywpar1  299142  /usr/sbin/syslogd
mywpar1  356354  sendmail: accepting connections  nnections
mywpar1  372776  /usr/sbin/portmap
mywpar1  389218  /usr/sbin/rsct/bin/rmcd -a IBM.LPCommands -r
mywpar1  393216  /usr/sbin/writesrv
```



```

mywpar1      409616   /usr/sbin/inetd
mywpar1      413718   /usr/sbin/nfsrgyd
mywpar1      454692   /usr/dt/bin/dtlogin
mywpar1      466954   /usr/sbin/rsct/bin/IBM.CSMAgentRMd
mywpar1      471282   /usr/sbin/qdaemon
mywpar1      483566   /usr/sbin/rpc.lockd -d 0
mywpar1      487674   /usr/sbin/rsct/bin/IBM.ServiceRMd
mywpar1      499966   /usr/sbin/rsct/bin/IBM.AuditRMd
mywpar1      217218   /usr/lib/errdemon
mywpar1      459004   /usr/sbin/cron
#

```

As shown in the previous example, the **proctree** command now is WPAR aware and reports processes tree relevant to the specified WPAR.

3.7.8 Updates for the svmon command

The **svmon** command is used to reports in-depth memory state information from the kernel in terms of pages.

The following enhancements have been made to this command to support WPAR specific metrics:

- ▶ The ability to filter memory information for a given WPAR, or WPAR list from the Global environment.
- ▶ The ability to display organized statistics for all active WPARs from the global environment.
- ▶ The ability to run the command from within a WPAR and display statistics relevant to its isolated environment.

Table 3-12 describes the updates made to this command for support of WPARs:

Table 3-12 Option changes for svmon command

Flag/ Argument	Behavior in WPAR	Behavior in Global
none	Executes the default report and displays an @ with information specific to the WPAR	Executes normally with no changes from previous versions of AIX.

Flag/ Argument	Behavior in WPAR	Behavior in Global
"-@ Wparlist"	Fails with usage message as -@ Wparlist option is made illegal inside the WPAR.	Prints relevant information for given WPAR only. If the specified WPAR does not exist or is not active then it fails with workload partition not found message unless workload partition name is Global.
"-@ ALL"	Fails with usage message as -@ ALL option is made illegal inside the WPAR.	Executes normally and prints the summary of all WPARs. A workload partition name is displayed for each record.

The following example demonstrates the output of the `svmon -@ mywpar1` command ran from the Global environment:

```
# svmon -@ mywpar1

#####
##### WPAR : mywpar1
#####

      size      inuse      free      pin      virtual
memory    262144    31899    52482    31899    148643
pg space   131072     2656

      work      pers      clnt      other
pin        144         0         0        10322
in use     3671         0        28228

PageSize  PoolSize      inuse      pgsp      pin      virtual
s   4 KB      -        31819    2656      80      67091
m   64 KB     -         5         0         4       5097
#
```

As shown in the previous example, the `svmon` command is now WPAR aware and reports memory information relevant to WPARs.

3.7.9 Updates for the `topas` command

The `topas` command is used to monitor and reports system wide metrics about the state of the local system. The command displays its output in a 80x25 character-based display format or in a window of at least the same size on a

graphical display. The **topas** command requires the `bos.perf.tools` and `perfgent.tools` filesets to be installed on the system.

The following enhancements have been made to this command to support WPAR specific metrics:

- ▶ The ability to display statistics for a given WPAR, or WPAR list from the Global environment.
- ▶ The ability to display organized statistics for all active WPARs from the Global environment.
- ▶ The ability to run the command from within a WPAR and display statistics relevant to its isolated environment.

Table 3-13 describes the updates made to this command for support of WPARs:

Table 3-13 Option changes for topas command

Flag/ Argument	Behavior in WPAR	Behavior in Global
none	Executes the default display specific to the WPAR. Main Panel: Replace disk statistics by file systems, Network statistics are provided per WPAR.	Executes normally with no changes from previous versions of AIX.
"-@ WPARname"	Fails with usage message as -@ WPARname option is made illegal inside the WPAR.	Executes the default display specific to the WPAR. Main Panel: Replace disk statistics by file systems, Network statistics are provided per WPAR.
"-P" Processes Screen	Executes normally displaying the processes display screen for the WPAR.	Executes normally with no changes from previous versions of AIX.
"-D" Disk Screen	Fails with usage message as -D option is made illegal inside the WPAR.	Executes normally with no changes from previous versions of AIX.
"-C" CEC Screen	Fails with usage message as -C option is made illegal inside the WPAR.	Executes normally with no changes from previous versions of AIX.

Flag/ Argument	Behavior in WPAR	Behavior in Global
"-L" Partition Screen	Fails with usage message as -L option is made illegal inside the WPAR.	Executes normally with no changes from previous versions of AIX.
"-W" WLM Screen	Fails with usage message as -W option is made illegal inside the WPAR.	Executes normally displaying WLM classes and active WPARs along with sub-process panel.
"-F" Filesystem Screen	Displays statistics about the file systems belonging to the WPAR.	Executes normally displaying the statistics for file system that belongs to the Global environment and all WPARs, running in the system, tagged with their respective names.
"-R" CEC-Recording	Fails with usage message as -R option is made illegal inside the WPAR.	Executes normally with no changes from previous versions of AIX.

Figure 3-5 on page 85 demonstrates the output of the **topas** command ran from the Global environment:

```

Topas Monitor for host: server5
Fri Oct 5 01:31:54 2007 Interval: 2
Kernel 0.8 |#
User 0.1 |#
Wait 0.0 |
Idle 99.1 |#####|
Physc = 0.00 |#####| %Entc= 1.4

Network KBPS I-Pack O-Pack KB-In KB-Out
Total 0.7 6.5 2.0 0.4 0.4

Disk Busy% KBPS TPS KB-Read KB-Writ
Total 0.0 0.0 0.0 0.0 0.0

FileSystem KBPS TPS KB-Read KB-Writ
Total 0.0 0.0 0.0 0.0

WPAR CPU% Mem% Blk-I/O%
mywpar1 0 3 0

EVENTS/QUEUES FILE/TTY
Cswitch 191 Readch 6
Syscall 48 Writetech 218
Reads 0 Rawin 2
Writes 1 Ttyout 218
Forks 0 Igets 0
Execs 0 Namei 1
Runqueue 0.0 Dirblk 0
Waitqueue 0.0

MEMORY
Real,MB 1024
% Comp 63.3
% Noncomp 17.7
% Client 17.7

PAGING
Faults 0
Steals 0
PgspIn 0
PgspOut 0
PageIn 0
PageOut 0
Sios 0

PAGING SPACE
Size,MB 512
% Used 1.1
% Free 99.9

NFS (calls/sec)
Serv2 0
Cliv2 0
Serv3 0
Cliv3 0

WPAR Activ 1
WPAR Total 1
Press: "h"-help
"q"-quit

Name PID CPU% PgSp Wpar
topas 311544 0.1 1.9 Global
wlmsched 65568 0.0 0.5 Global
getty 192662 0.0 0.5 Global
gil 61470 0.0 0.9 Global
java 303232 0.0 46.2 Global
rmcd 176302 0.0 2.6 Global
lockd-1 352270 0.0 1.2 Global
sendmail 188566 0.0 1.3 Global
rpc.lock 135326 0.0 1.2 Global
sendmail 405678 0.0 1.3 mywpar1
java 307348 0.0 16.1 Global
netm 57372 0.0 0.4 Global
xmgc 49176 0.0 0.4 Global
syncd 127100 0.0 0.5 Global
xmwlm 291008 0.0 8.6 Global

```

Figure 3-5 The `topas` command output in a WPAR environment

As shown in Figure 3-5, the `topas` command is now WPAR aware and reports relevant WPAR information (circled).

3.7.10 Updates for the `tprof` command

The `tprof` command is used to reports CPU usage for individual programs and the system as a whole. This command is a useful tool for anyone with a JAVA, C, C++, or FORTRAN program that might be CPU-bound and who wants to know which sections of the program are most heavily using the CPU.

The following enhancements have been made to this command to support WPAR specific metrics:

- ▶ The ability to filter processes for a given WPAR, or WPAR list from the Global environment.
- ▶ The ability to display organized statistics for all active WPARs from the global environment.

- ▶ The ability to run the command from within a WPAR and display statistics relevant to its isolated environment.

Important: In order to use this command within a WPAR, trace privileges must be enabled in the WPAR. Rrefer to the “Enabling trace” on page 62 topic.

Table 3-14 describes the updates made to this command for support of WPARs:

Table 3-14 Option changes for tprof command

Flag/ Argument	Behavior in WPAR	Behavior in Global
“-@ Wparlist”	Fails with usage message as -@ Wparlist option is made illegal inside the WPAR.	Prints relevant information for given WPAR only. If the specified WPAR does not exist or is not active then it fails with workload partition not found message unless workload partition name is Global.
“-@ ALL”	Fails with usage message as -@ ALL option is made illegal inside the WPAR.	Executes normally and prints the summary of all WPARs. A workload partition name is displayed for each record.
“-@”	Fails with usage message as -@ option is made illegal inside the WPAR.	Executes normally and prints process tree with related WPARs and Global dependency. A workload partition name is displayed for each record.

The following example demonstrates the sleep.prof file output of the **tprof -x sleep 10** command when ran from within the mywpar1 WPAR:

```
Configuration information
=====
System: AIX 6.1 Node: mywpar1 Machine: 00C0F6A04C00
Tprof command was:
    tprof -x sleep 10
Trace command was:
    /usr/bin/trace -ad -M -L 66476851 -T 500000 -j
00A,001,002,003,38F,005,006,134,210,139,5A2,5A5,465,234,5D8, -o
sleep.trc
Total Samples = 3
Traced Time = 10.04s (out of a total execution time of 10.04s)
```

Table 3-15 Option changes for vmstat command

Flag/ Argument	Behavior in WPAR	Behavior in Global
None	Executes the default report and displays an @ above the metrics specific to the WPAR	Executes normally with no changes from previous versions of AIX.
"-@ Wpname"	Fails with usage message as -@ Wpname option is made illegal inside the WPAR.	Prints relevant information for given WPAR only. If the specified WPAR does not exist or is not active then it fails with workload partition not found message unless workload partition name is Global.
"-@ ALL"	Fails with usage message as -@ ALL option is made illegal inside the WPAR.	Executes normally and prints the summary of all WPARs. A workload partition name is displayed for each record.
"-i"	Fails with usage message as -i option is illegal inside the WPAR.	Executes normally and prints interrupt information associated to Global. This option cannot be used with the -@ option.
"-s"	Displays an @ by side of the metrics associated to the WPAR	Executes normally and prints the sum structure and count of paging events associated with the Global environment. If used in combination with any of these -@ options it will print relevant information summarizing specified WPARs.
"-v"	Displays an @ by side of the metrics associated to the WPAR	Executes normally and prints the VMM statistics associated with the Global environment. If used in combination with any of these -@ options it will print relevant information summarizing specified WPARs

Example 3-4 demonstrates the output of the -v option when used in the Global environment combined with the -@ ALL option:

Example 3-4 VMM statistics combined output from the global environment

```
# vmstat -@ ALL -v
WPAR: System
    262144 memory pages
    232510 lruable pages
    82435 free pages
     1 memory pools
    83218 pinned pages
    80.0 maxpin percentage
     3.0 minperm percentage
    90.0 maxperm percentage
    10.3 numperm percentage
    24041 file pages
     0.0 compressed percentage
     0 compressed pages
    10.3 numclient percentage
    90.0 maxclient percentage
    24041 client pages
     0 remote pageouts scheduled
     0 pending disk I/Os blocked with no pbuf
     0 paging space I/Os blocked with no psbuf
    2484 filesystem I/Os blocked with no fsbuf
     0 client filesystem I/Os blocked with no fsbuf
     0 external pager filesystem I/Os blocked with no fsbuf
     0 Virtualized Partition Memory Page Faults
    0.00 Time resolving virtualized partition memory page faults
-----
WPAR: Global
    262144 memory pages
    232510 lruable pages
    82435 free pages
    83118 pinned pages
    23094 file pages
     0 compressed pages
    23094 client pages
     0 remote pageouts scheduled
     0 paging space I/Os blocked with no psbuf
    2484 filesystem I/Os blocked with no fsbuf
     0 client filesystem I/Os blocked with no fsbuf
     0 external pager filesystem I/Os blocked with no fsbuf
     0 Virtualized Partition Memory Page Faults
-----
WPAR: mywpar1
    100 pinned pages
    947 file pages
```

```

0 compressed pages
947 client pages
0 remote pageouts scheduled
0 paging space I/Os blocked with no psbuf
0 filesystem I/Os blocked with no fsbuf
0 client filesystem I/Os blocked with no fsbuf
0 external pager filesystem I/Os blocked with no fsbuf
0 Virtualized Partition Memory Page Faults

```

#

As shown in Example 3-4 on page 89, this combined command shows a breakdown summary report for the entire system, Global, and all active WPARs in the LPAR.

Note: Filtering options using the `-@` will only show information for *active* WPARs. Some reports wont show any different output if there are no active WPARs in the system.

3.8 Standard command updates for WPAR support

In order to support and filter WPAR relevant information many standard AIX commands have been enhanced to support workload partitions. Many of the commands have different behaviors inside a WPAR, and in the Global environment. Table 3-16 provides a summarized list of these commands and its changes:

Table 3-16 Command updates for WPAR support

Command	Flags/ Argument	Behavior in WPAR	Behavior in Global
acctcom	- @ wparname	Fails with usage message as -@ wparname option is made illegal inside the WPAR	Executes normally displaying accounting records for specified WPAR.
	- @ no argument	Fails with usage message as -@ option is made illegal inside the WPAR	Executes normally displaying accounting records for all WPARs. A WPAR name is displayed for each record.

Command	Flags/ Argument	Behavior in WPAR	Behavior in Global
cllogin	wparName [-l user] [command [args]]	Not allowed within a WPAR	Prompts for password and runs command in the WPAR or login if no command is specified.
df	All options	Displays information about WPAR mounted file systems only. Paths are displayed relative to the WPAR root	Displays information about all file systems. Paths are absolute.
domainname	None	Displays the domain name of the WPAR	Displays the domain name for the system
	{new domain name}	If executed by root sets the domain name of WPAR	If executed by root, sets the domain name of Global environment
hostid	None	Displays host ID of WPAR	Displays host ID of Global environment
	{IP address hex number}	If executed by root sets host ID of WPAR	If executed by global root, sets the host ID of the Global environment
hostname	None	Displays host name of WPAR	Displays host name of system
	{newhostname}	If executed by root and host name privilege allowed for WPAR, sets host name of WPAR	If executed by root, sets host name of the Global environment
ifconfig	All display options (-a -l)	Display information about the WPAR	Display information about the Global environment
ioo		Non-functional in WPAR	no change in behavior
ipcrm	None	Removes IPC objects associated with the WPAR	Removes IPC objects associated with Global environment
	"-@ wparname"	Invalid unless WPAR name = Global. In this case, removes IPC object associated with the	Removes IPC objects associated with WPAR wparname".

Command	Flags/ Argument	Behavior in WPAR	Behavior in Global
ipcs	None	Displays information about IPC objects created by processes within the WPAR	Displays information about IPC objects created by the Global environment processes. No WPAR associated objects are displayed.
	"-@"	Displays IPC information within the WPAR.	Displays information about all IPC objects in the system. The name of the WPAR associated with the object is listed.
	"-@ wparname"	Displays no IPC information unless wparname = Global	Displays information about IPC objects associated with processes within the specified WPAR
mkclass	All options	This command will only update the /etc/wlm directory. Will fail updating kernel data	No change in behavior
mount	None	Displays only WPAR mounted file systems relative to the WPAR root	Displays all mounted file systems with absolute paths
	With arguments	Only NFS mounts without CacheFS™ are allowed. Forced nosuid, nodev	No change in behavior
netstat	All options except -c, -C, -g, -m, -M, -P, -r, -v, -Z	Fails with usage message as -c, -C, -g, -m, -M, -P, -r, -v, and -Z options are made illegal inside the WPAR	Display information about the whole system
	new Argument "-@ wparname"	Fails with usage message as -@ wparname option is made illegal inside the WPAR	Displays either connection or address information for the specified WPAR

Command	Flags/ Argument	Behavior in WPAR	Behavior in Global
nfso		Only a subset of tunables are displayed within a WPAR	No change
no		Fails with Usage message. The -a option executes normally.	Executes normally if user has correct privilege
projct1	All options except qproj(s)	Fails with a "not owner" message. qproj(s) executes normally	Executes normally if user has correct privilege
ps	"-e"	Displays everything within the WPAR	Displays everything within the system. Processes are not screened from view unless a specific -@ <wparname> is also included.
	"-@"	Displays process information for processes in the WPAR. WPAR name is included in output.	Displays process information for all processes in the system. The name of the WPAR is displayed on output.
	"-@ wparname"	Displays no process information unless wparname = Global. Global case displays information about processes within the WPAR. The name of the WPAR is provided on output.	Displays information about processes associated with the WPAR named wparname. The name of the WPAR is provided on output.
	"-o wpar"	Produces a wpar name header and the name of the WPAR associated with the process. This name is always Global.	Produces a wpar name header and the name of the WPAR in which the process is executing.
schedo		Non-functional in WPAR	No change in behavior
uname	"-n"	Displays name of the WPAR	Displays node name of the system
vmo		Non-functional in WPAR	No change in behavior

Command	Flags/ Argument	Behavior in WPAR	Behavior in Global
wlmstat		-B option not allowed within a WPAR	No change in behavior
	"-@"	Will not work in WPAR	Will display data for meta class (WPAR class)
wlmtune	All options	Not allowed within a WPAR	No change in behavior
wlmcntrl	All options	Not allowed within a WPAR	No change in behavior

3.9 Network file system support for WPARs

In this section, we discuss Network File System (NFS) interface implementation and support for WPARs.

3.9.1 Overview

Most applications running within a WPAR will operate with no difference than running in previous versions of AIX. This is because, within the WPAR, applications have a private execution environment isolated in terms of processes, signals, and file system space. They run with unique security privileges and have dedicated network addresses, interprocess communication is restricted to processes executing in the same WPAR.

When AIX is installed and started, a special workload partition is created. This WPAR is referred to as the Global partition. which is the same as a default single instance of the OS.

Although WPARs are isolated, it is a common practice for network resources to be shared across different systems. AIX Network File Systems (NFS) allows for the distribution of local file systems in a server for the use of remote systems, LPARS, and now in AIX V6.1, WPARs.

The following list summarizes the NFS features enabled for WPAR support:

- ▶ Operation of NFS version 2, 3, and version 4 clients, AutoFS and CacheFS within a WPAR including the Global environment
- ▶ Implementation of per WPAR NFS client statistics and tunables
- ▶ Implementation of per WPAR NFS commands

- ▶ Implementation of per WPAR CacheFS commands
- ▶ Loading of NFS, AutoFS, and CacheFS kernel extensions from a WPAR.
- ▶ RAS enhancements to NFS, AutoFS, and CacheFS for field support

3.9.2 NFS user interface

This section discusses the different NFS user interfaces updates for WPARs. Refer to the product documentation and man pages for a detailed description of parameters and their usage for each one of the commands discussed in this section.

Updates for the `nfso` command

The `nfso` command is used by NFS versions 2, 3, and 4 to set parameters and configuration options.

The `nfso` command has been changed to accept an additional argument, `-@`, that when invoked in the Global environment can be used to set or retrieve an option value for a specific WPAR. Only a subset of `nfso` options within a WPAR are tunable for security reasons. For example, the command below demonstrates the output list of NFS tunables and their values for the WPAR named *mywpar1* when the `nfso -a` is executed within the WPAR.

```
# nfso -a
      client_delegation = 0
      nfs_rfc1323 = 1
      nfs_use_reserved_ports = 0
      nfs_v4_fail_over_timeout = 0
      utf8_validation = 1
```

Updates for the `nfsstat` command

The `nfsstat` command is used to display a wide range of NFS statistics. This command has been updated to accept an additional argument, `-@`, when invoked in the Global environment in order to obtain statistics for a specific WPAR. In the global partition when no `"@"` option is used, cumulative statistics for all workload partitions including the Global will be reported. The `-@` option is not valid within WPARs.

Updates for the `nfs4cl` command

The `nfs4cl` command displays and modifies current NFSv4 statistics and properties. The command has been updated to work within a WPAR. When invoked from within a WPAR it would display or modify the current NFSv4 statistics and properties for that particular WPAR.

Note: The -@ parameter is not valid within the Global environment for this command.

3.9.3 AutoFS user interface

AutoFS relies on the use of the **automount** command to propagate the automatic mount configuration information to the AutoFS kernel extension and start the **automountd** daemon. The **automount** command is used as an administration tool for AutoFS. It installs AutoFS mount points and associates an automount map with each mount point.

Each WPAR runs a separate instance of the user mode daemon. The **automount** command works as in previous version for both the Global environment, and WPARs.

Note: These commands only work on a System WPAR.

3.9.4 CacheFS user interface

This section discusses the different CacheFS user interfaces updates for WPARs. Refer to the product documentation and man pages for a detailed description of parameters and their usage for each one of the commands discussed in this section.

Note: The -@ parameter is not valid within the Global environment for any of the CacheFS command.

Updates for the **cfsadmin** command

The **cfsadmin** command provides maintenance task for disk space used for caching file systems. It allows the following functions:

- ▶ Cache creation
- ▶ Deletion of cached file systems
- ▶ Listing of cache contents and statistics
- ▶ Resource parameter adjustment when the file system is un-mounted.

The **cfsadmin** command is now enhanced so it can be executed from within the WPAR. When executed within a WPAR the command will only allow the -c, -d, -l, and -s options. The -o parameter is only allowed from the Global environment as it affects global CacheFS parameters.

Updates for the `cachefsstat` command

The `cachefsstat` command displays statistical information about a cache file system. The command is now enhanced so it can be used within a WPAR and display statistics relevant to its environment.

Updates for the `cachefslog` command

The `cachefslog` command controls and displays the logging of a cache file system. This command has been enhanced to work within a WPAR and display information relevant to its environment.

Updates for the `cachefswssize` command

The `cachefswssize` command displays the work size for a cache file system. This command has been enhanced to work within a WPAR and display information relevant to its environment.

Packaging

The CacheFS functionality is not installed with the default AIX V6.1 system installation. The following fileset needs to be install in order for CacheFS commands to be available:

bos.net.nfs.cachefs Supports CacheFS functionality

3.9.5 Continuous availability enhancements for NFS

This section discusses the different continuous availability enhancements to support WPARs.

Tracing

Tracing capabilities have been extended to support System type WPARs. Details for using, and enabling trace within a system WPAR are covered in the 3.4, “System trace support” on page 57.

KDB Support

The `kdb` command has been enhanced to the user mode KDB module to extract from the Global environment per-WPAR data structures.

The NFS KDB module has been updated with the following commands:

<code>nfsgv</code>	Displays the global variable data structure. This command accepts the following syntax: nfsvvar variable-name subsystem-name all
<code>nfswpar [n]</code>	Displays the addresses of the per-wpar variable structures when used without arguments. A per-wpar

variable structure (corral id, or structure address) can be passed as an argument.

nfsvar

Displays a NFS global variable, or a group of variables, or all the variables. This command accepts the following syntax: **nfsvar variable-name|subsystem-name|all**

With the argument of all if displays all variables. With the name of a variable as an argument, it displays that variable. With the group name (krpc, clnt, klm, for example) as an argument, it displays the variable related to that subsystem.



Continuous availability

This chapter discusses the topics related to continuous availability, including:

- ▶ 4.1, “Storage protection keys” on page 100
- ▶ 4.2, “Component trace and RTEC adoption” on page 101
- ▶ 4.3, “Dump Facilities” on page 141
- ▶ 4.4, “Performing a live dump” on page 163
- ▶ 4.5, “Kernel error recovery” on page 164
- ▶ 4.6, “Concurrent update” on page 169
- ▶ 4.7, “Core dump enhancements” on page 174
- ▶ 4.8, “I/O request tracking” on page 175
- ▶ 4.9, “Trace hook range expansion” on page 176
- ▶ 4.10, “LVM configuration and trace logs” on page 177
- ▶ 4.11, “Group Services Concurrent LVM enhancements” on page 184
- ▶ 4.12, “Paging Space Verification” on page 188

4.1 Storage protection keys

Memory overlays and addressing errors are a difficult problem to diagnose and service. This problem is intensified and becoming more prominent by growing software size and complexity.

A new POWER6 processor feature called storage protection keys, or storage keys for short, provides the hardware foundation to prevent inadvertent memory overlays in both the kernel and the application space. Storage protection keys are a new and strategic element of the AIX continuous availability framework.

AIX 5L Version 5.3 Technology Level 06 (5300-06) introduced the storage protection keys application programming interface (API) for user space applications that assists application programmers in utilizing the hardware storage protection keys on IBM System p POWER6 processor-based servers running this technology level. Additional background information of this user-mode storage key exploitation and in depth discussion of the API's use can be found in the following white paper: Storage Protection Keys on AIX Version 5.3,

http://www.ibm.com/systems/p/library/wp_aix_lit.html

Beginning with AIX V6.1, the operating system kernel and kernel extensions inherently exploit the hardware storage keys for enhanced memory allocation and memory access reliability characteristics. To externalize this kernel-mode storage key support, AIX V6.1 additionally provides the kernel-mode storage protection key API enabling kernel extension programmers to write code that makes use of the hardware storage protection keys.

Storage-keys were introduced into PowerPC architecture to provide memory isolation while still permitting software to maintain a flat address space. The concept was adopted from the z/OS® and S/390® systems. Storage-keys allow an address space to be assigned context specific protection. Access to the memory regions can be limited to prevent or identify illegal storage references.

Under AIX V6.1, storage-keys are used to capture bad storage references of the kernel and kernel extension that previously overwrote memory, thereby providing a transparent protection mechanism.

4.2 Component trace and RTEC adoption

The AIX enterprise Reliability Availability Serviceability (RAS) infrastructure defines a component definition framework. This framework supports three distinct domains:

- ▶ Run-time Error Checking (RTEC)
- ▶ Component Trace (CT)
- ▶ Component Dump (CD)

This framework is shown in Figure 4-1.

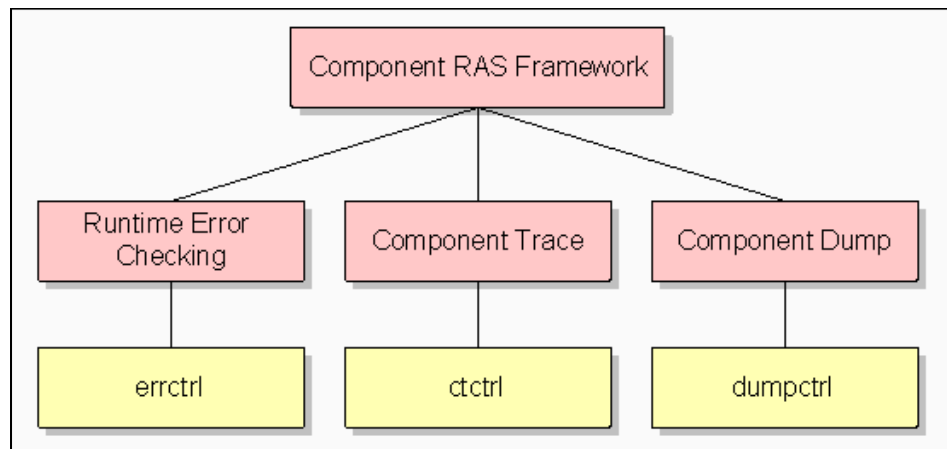

Figure 4-1 Component RAS Framework overview

AIX 5L Version 5.3 with the TL 5300-05 Technology Level package enabled the first operating system components to exploit the run-time error checking and the component trace services. AIX V6.1 introduces the third domain, the component dump services and significantly increases the number of components that utilize the run-time error checking and component trace services. This section describes the operating system components which are enhanced in AIX V6.1 to leverage the component trace and run-time error checking framework. The following provides an overview of the affected areas and the related base component names are given in parentheses.

Areas of component trace and run-time error checking adoption:

- ▶ Virtual Memory Manager (vmm, ipc)
- ▶ AIX storage device drivers (scdisk, sisraid_dd, sissas_dd)
- ▶ Virtual SCSI disk drivers (vscsi_initdd)
- ▶ Multiple Path I/O and AIX default path control module (mpio#, pcm#)

- ▶ InfiniBand device driver (if_ib, gxibdd, icmdd, tsibdd)
- ▶ LAN device driver (vioentdd, goentdd, headd, kngentdd)
- ▶ TCP kernel and netinet kernel extension (netisr)

Areas of component trace adoption:

- ▶ Internet Protocol Security (ipsec)
- ▶ PCI device driver (pci)
- ▶ Virtual bus device driver (vdev)
- ▶ USB system device driver (usb_system)
- ▶ USB audio device driver (usb_audio)
- ▶ 2D graphics device drivers (lanaidd, cortinadd)

Areas of run-time error checking adoption:

- ▶ System loader (ldr)
- ▶ NFS version 4 (nfs.nfs4)
- ▶ Cache File System (cachefs)
- ▶ Watchdog timer (watchdog)
- ▶ System memory allocator (alloc)

(The # character denotes a place holder for configuration dependent integer values.)

These components are organized following a hierarchy by base component and subcomponents. Component names are built upon this hierarchy: <base component name>.<specific subcomponents>. These components belong to a *type/subtype* classification and have RAS properties.

The following example shows the component/subcomponent hierarchy for the tracing properties of the lfs component.

```
# ctctrl -c lfs -q -r
```

Component name	Have alias	Mem Trc /level	Sys Trc /level	Buffer size /Allocated
lfs	NO	ON/3	ON/3	0/ NO
filesystem				
._0	NO	ON/3	ON/3	0/ NO
._1	NO	ON/3	ON/3	0/ NO
._admin_9	NO	ON/3	ON/3	0/ NO
._home_8	NO	ON/3	ON/3	0/ NO
._opt_11	NO	ON/3	ON/3	0/ NO
._proc_10	NO	ON/3	ON/3	0/ NO
._tmp_5	NO	ON/3	ON/3	0/ NO
._usr_2	NO	ON/3	ON/3	0/ NO
._var_4	NO	ON/3	ON/3	0/ NO
.kdm	NO	ON/3	ON/3	0/ NO

.pile | NO | ON/3 | ON/3 | 0/ NO

In order to be used by the kernel when the system needs to communicate between various commands to each component (RAS callbacks), these components must be register/unregister to AIX.

There are two kernel services are exported and can be called from the process environment with the `ras_register()` and `ras_unregister()` kernel service calls.

The following code is an example of registering a parent(base) component: it creates and register a base component named *ethernet* of the network type with the Ethernet subtype.

```
ras_block_t rasb_eth;
kerrno_t err;
...lines missing for clarity
err=ras_register( &rasb_eth, "ethernet",NULL,
RAS_TYPE_NETWORK_ETHERNET, "All ethernet devices", RASF_TRACE_AWARE,
eth_call back, NULL);
```

Note: The flag `RASF_TRACE_AWARE` indicates what type of RAS systems this component is aware of. With `RASF_TRACE_AWARE`, this component is a tracing component.

The type/subtype field is associated to the component at registration time. The component characteristics can be modified from their default properties by the `ras_control()` exported kernel service call. For example, one component characteristic can be the size of a buffer area used to report error data or traced data or dump data.

To put the component on a *usable state* by the AIX kernel, the customization step which load the reboot persistent customized properties, is mandatory. The customization step is realized calling the `ras_customize()` exported kernel service call.

The following example modifies some default properties of the previous *ethernet* component and then executes the mandatory customization call:

```
ras_block_t rasb_eth;
kerrno_t err;
...lines missing for clarity

/* set a buffer size (default size is 0) */
err=ras_control(rasb_eth, RASCT_SET_MEMBUFSIZE, size, 0);

/* allocate a private buffer size */
```

```
err=ras_control(rasb_eth, RASCT_SET_ALLOC_BUFFER, 0, 0);

/* activate memory trace mode */
err=ras_control(rasb_eth, RASCT_SET_MEMTRC_RESUME, 0, 0);

/* customization step to be usable component */
err=ras_customize(rasb_eth);
```

Persistence of component attributes

The three control commands **errctrl**, **ctctrl**, and **dumpctrl** are used to modify the RAS attribute values of individual components. With AIX Version 6, these commands are enhanced so that RAS attribute values can be specified for components not yet created. In addition, it will be possible to specify the RAS attribute values that will persist across reboots.

Persistence of component attributes is required for two reasons:

- ▶ RAS components can be created dynamically, such as when a file system is mounted. A method is needed to specify custom RAS attributes for components that have not been yet created, so that the desired RAS property takes effect as soon as the component is created.
- ▶ RAS components are also created before a system administrator can log in and run a control command. By allowing customized attribute values to be specified as part of the boot image, all components can be controlled, included those created early in the boot process.

This persistence capability is also essential for allowing an administrator to specify customizations required for a given configuration. Persistence is specified by using the **-P** or **-p** flag with the control commands.

The **-P** flag Specifies attribute values that apply to the next reboot. The **-P** flag results in the modification of the `/var/adm/ras/raspertune` file. Lines are added to or deleted from the file. In addition, the **bosboot** command processes the `raspertune` file.

The **-p** flag Specifies attribute values that apply to newly-created components. It will not affect an existing component.

Both flags can be used at the same time, with the expected result.

The **-n** flag Specifies attribute values to apply immediately to existing components. To apply changes to both current and newly created components, use the **-n** and **-p** flags.

The **-x** flag Specifies a permanent persistence specification that must be deleted. The **-x** flag must be used with **-P** or **-p**.

For example, the following command set the error checking level to normal for the `hdisk0` component, named by its alias `-l` flag:

```
# errctrl -p -l hdisk0 errchecknormal
```

As RAS components are organized under a hierarchy, the specified attributes can be set recursively to all component descendants with the `-r` flag or to all ancestors with the `-u` flag.

For example, the following command set the error checking level to *minimal* for the `nfs` component and its descendants:

```
# errctrl -p -r -c nfs errcheckminimal
```

The following command set the error checking level to *detail* for the `nfs.nfs4.nfs4_server` component and its ancestors:

```
# errctrl -p -u -c nfs.nfs4.nfs4_server errcheckdetail
```

The following sections detail the enhancements in AIX Version 6.

4.2.1 VMM component trace and RTEC adoption

In previous AIX releases the VMM does tracing using either system trace or lightweight memory trace. AIX V6.1 extends the component trace adoption to the virtual memory manager (VMM) kernel subsystem and provides a VMM component tree for the component trace domain of the AIX enterprise RAS infrastructure. The related base component is named *vmm* and the integration into the component trace framework enables both the memory trace mode (private or light weight memory trace) and the user trace mode (system trace) for the new base component and its sub-components. In AIX V6.1 the VMM component tree is also utilized by the run-time error checking (RTEC) domain of the AIX enterprise RAS infrastructure. The VMM RTEC adoption also extends to the Inter Process Communication (IPC) services for which the base component name *ipc* has been defined.

The *vmm* component hierarchy of a given AIX configuration and the current settings for the memory trace mode (private or light weight memory trace) and the user trace mode (system trace) can be listed by the `ctctrl` command. The `ctctrl` command also allows to modify the component trace related configuration parameters.

```
hhaix6:root:/root # ctctrl -c vmm -q -r
```

Component name	Have alias	Mem Trc /level	Sys Trc /level	Buffer size /Allocated
vmm				

.dr	NO	ON/3	ON/3	65536/YES
.internal	NO	ON/3	ON/3	4096/YES
.memp				
.mempLRU	NO	OFF/3	ON/3	0/ NO
.mempLRU0	YES	ON/3	ON/3	16384/YES
.mempLRU1	YES	ON/3	ON/3	16384/YES
.mempPSMD	NO	OFF/3	ON/3	0/ NO
.mempPSMD0	YES	ON/3	ON/3	16384/YES
.mempPSMD1	YES	ON/3	ON/3	16384/YES
.pdt	YES	OFF/3	ON/3	0/ NO
.pdt0	YES	ON/3	ON/3	0/ NO
.pdt80	YES	ON/3	ON/3	0/ NO
.pdt81	YES	ON/3	ON/3	0/ NO
.pdt82	YES	ON/3	ON/3	0/ NO
.pdt83	YES	ON/3	ON/3	0/ NO
.pdt84	YES	ON/3	ON/3	0/ NO
.pdt85	YES	ON/3	ON/3	0/ NO
.pdt86	YES	ON/3	ON/3	0/ NO
.pdt87	YES	ON/3	ON/3	0/ NO
.pdt88	YES	ON/3	ON/3	0/ NO
.pdt89	YES	ON/3	ON/3	0/ NO
.pdt8A	YES	ON/3	ON/3	0/ NO
.pdtbufx	NO	OFF/3	ON/3	0/ NO
.pdtbufx0	YES	ON/3	ON/3	65536/YES
.services	NO	ON/3	ON/3	0/ NO

The component tree elements of the previous listing are defined as follows. (The # character denotes a place holder for given integer values and the XXX character sequence denotes a place holder for a given alphanumeric label):

vmm	Base component for virtual memory manager kernel subsystem. This component has no private trace buffer.
.dr	Component for memory dynamic re-configuration (DR) trace. The DR component has a 64 KB default private trace buffer.
.internal	Component for internal VMM trace. This component has no private trace buffer.
.memp	parent component for memory pools. This component has no private trace buffer.
.mempXXX	Dynamic component for individual memory pool types. AIX V6.1 supports parent components for VMM pager (LRU) memory pools and Page Size Management Daemon (PSMD) pools. LRU and PSMD are the respective memory pool IDs which replace the XXX place holder.
.mempLRU#	Subcomponent for LRU memory pool trace which has an associated 16 KB private buffer.

.mempPSMD#	Sub-component for PSMD memory pool trace which has an associated 16 KB private buffer.
.pdt	Parent component for paging space devices and their related paging device tables (PDT). This component has no private trace buffer.
.pdt#	Dynamic component for individual paging device and their related PDTs. This component has no private trace buffer.
.pdtbufx	Parent component for I/O tracking bufx structures.
.services	Component for VMM kernel services. This component has no private trace buffer.

Since there can be as many as 256 memory pools, the maximum amount of pinned memory consumed by VMM component private buffers at their default size is $256 * 2 * 16$ KB for the memory pool buffers + 64 KB for the DR buffer, for a total of about 8.5 MB. In most system configurations the amount will be substantially less than this, since the number of memory pools scales with the number of CPUs: By default, there is one memory pool per eight CPUs.

The RTEC vmm component hierarchy of a given AIX configuration and the current settings for error checking level, disposition for low-severity errors, and disposition for medium-severity errors can be listed by the `errctr1` command. The `errctr1` command also allows to modify the run-time error checking related configuration parameters. The following `errctr1` command output shows that the default error checking level for all vmm components is normal (level=3), that low-severity errors are ignored (LowSevDis=48), and medium-severity errors are logged (collect service data and continue) (MedSevDisp=64):

```
hhaix6:root:/root # errctr1 -c vmm -q -r
```

Component name	Have alias	ErrChk /level	LowSev Disp	MedSev Disp
vmm				
.adsp	NO	ON /3	48	64
.dr	NO	ON /3	48	64
.frs	YES	ON /3	48	64
.frs0	YES	ON /3	48	64
.frs1	YES	ON /3	48	64
.frs2	YES	ON /3	48	64
.frs3	YES	ON /3	48	64
.internal	NO	ON /3	48	64
.memp	YES	ON /3	48	64
.memp0	YES	ON /3	48	64
.memp1	YES	ON /3	48	64
.mempLRU	NO	ON /3	48	64
.mempLRU0	YES	ON /3	48	64

.mempLRU1	YES	ON /3	48	64
.mempPSMD	NO	ON /3	48	64
.mempPSMD0	YES	ON /3	48	64
.mempPSMD1	YES	ON /3	48	64
.pdt	YES	ON /3	48	64
.pdt0	YES	ON /3	48	64
.pdt80	YES	ON /3	48	64
.pdt81	YES	ON /3	48	64
.pdt82	YES	ON /3	48	64
.pdt83	YES	ON /3	48	64
.pdt84	YES	ON /3	48	64
.pdt85	YES	ON /3	48	64
.pdt86	YES	ON /3	48	64
.pdt87	YES	ON /3	48	64
.pdt88	YES	ON /3	48	64
.pdt89	YES	ON /3	48	64
.pdt8A	YES	ON /3	48	64
.pdt8B	YES	ON /3	48	64
.pdtbufx	NO	ON /3	48	64
.pdtbufx0	YES	ON /3	48	64
.power	NO	ON /3	48	64
.services	NO	ON /3	48	64
.vmpool	YES	ON /3	48	64
.vmpool0	YES	ON /3	48	64
.vmpool1	YES	ON /3	48	64
.wlm	NO	ON /3	48	64

The RTEC ipc component hierarchy of a given AIX configuration and the current settings for error checking level, disposition for low-severity errors, and disposition for medium-severity errors can be listed by the **errctr1** command. The **errctr1** command also allows to modify the run-time error checking related configuration parameters. The following **errctr1** command output shows that the default error checking level for all ipc components is normal (level=3), that low-severity errors are ignored (LowSevDis=48), and medium-severity errors are logged (collect service data and continue) (MedSevDisp=64):

```
hhaix6:root:/root # errctr1 -c ipc -q -r
```

Component name	Have alias	ErrChk /level	LowSev Disp	MedSev Disp
ipc				
.msg	YES	ON /3	48	64
.sem	YES	ON /3	48	64
.shm	YES	ON /3	48	64

The vmm and the ipc components are also enabled for the component dump and live dump services of the AIX enterprise RAS infrastructure.

4.2.2 AIX storage device driver component trace and RTEC support

Beginning with AIX 5L V5.3 TL5 selected critical AIX storage device drivers started to exploit the AIX RAS infrastructure with regards to component naming and registration to the run-time error checking and component trace domains. AIX V6.1 enables three additional storage device drivers to exploit the component trace and the RTEC framework. The following table provides an overview of the AIX storage device drivers which utilize the AIX enterprise RAS infrastructure for trace and RTEC. The device drivers are listed by their base component names and the AIX release of introduction is provided:

Table 4-1 AIX storage device driver base component names

AIX release	Component name	Description
5300-05	scsidiskdd	CSI disk (scsidisk) device driver for fiber channel and iSCSI disks excepting FASTT (DS4000)
5300-05	fcarray	Disk device driver for FASTT(DS4000)
5300-05	efcdd	Adapter device driver for Emulex Fibre Channel controllers
5300-05	efscsidd	SCSI protocol device driver for Emulex Fibre Channel controllers
6100-00	scdisk	Disk device driver for parallel SCSI disks and optical
6100-00	sisraid_dd	Adapter device driver for SIS based Ultra 320 SCSI and SCSI RAID controllers
6100-00	sissas_dd	Adapter device driver for SIS SAS RAID controller

The storage device driver component hierarchy of a given AIX configuration and the current settings for the memory trace mode (private or light weight memory trace) and the user trace mode (system trace) can be listed by the **ctctr1** command. The **ctctr1** command also allows to modify the component trace related configuration parameters:

```
# ctctr1 -c scdisk -q -r
# ctctr1 -c sisraid_dd -q -r
# ctctr1 -c sissas_dd -q -r
```

The RTEC storage device driver component hierarchy of a given AIX configuration and the current settings for error checking level, disposition for low-severity errors, and disposition for medium-severity errors can be listed by

the **errctr1** command. The **errctr1** command also allows to modify the run-time error checking related configuration parameters:

```
# errctr1 -c scdisk -q -r
# errctr1 -c sisraid_dd -q -r
# errctr1 -c sissas_dd -q -r
```

4.2.3 Virtual SCSI device driver component trace and RTEC adoption

The AIX virtual SCSI client device driver was enhanced in AIX V6.1 to exploit the enterprise RAS infrastructure with regards to component naming and registration. In addition to registration, the driver also adds support for enterprise RAS component tracing and kernel run-time error checking. Component tracing and run time error checking are referred to as domains supported by the AIX RAS infrastructure services.

During the virtual SCSI device driver configuration and initialization the new base component *vscsi_initdd* is registered with the component trace framework. Each instance of a virtual adapter controlled by the virtual SCSI device driver becomes a sub-component specifying the base component (device driver) as the parent. The adapter sub-component is named *vscsi#*, where # designates a place holder for configuration dependent integer values. Finally, each open device on a given adapter defines a sub-component, specifying the adapter instance as the parent. An example hierarchy would be *vscsi_initdd.vscsi0.lun8100000000000000*, where *lun8100000000000000* represents an hdisk instance which has been started (opened) on client adapter *vscsi0*.

The virtual SCSI device driver component hierarchy of any given AIX configuration and the current settings for the memory trace mode (private or light weight memory trace) and the user trace mode (system trace) can be listed by the **ctctr1** command. The **ctctr1** command also allows to modify the component trace related configuration parameters:

```
hhaix6:root:/root # ctctr1 -c vscsi_initdd -q -r
```

Component name	Have alias	Mem Trc /level	Sys Trc /level	Buffer size /Allocated
vscsi_initdd				
.vscsi0	YES	ON/3	ON/3	8192/YES
.lun8200000000000000	NO	ON/3	ON/3	8192/YES
.lun8300000000000000	NO	ON/3	ON/3	8192/YES

The RTEC virtual SCSI device driver component hierarchy of a given AIX configuration and the current settings for error checking level, disposition for low-severity errors, and disposition for medium-severity errors can be listed by the **errctr1** command. The **errctr1** command also allows to modify the run-time

error checking related configuration parameters. The following `errctr1` command output shows that the default error checking level for all net components is minimal (`level=1`), that low-severity errors are ignored (`LowSevDis=48`), and medium-severity errors are logged (collect service data and continue) (`MedSevDisp=64`):

```
hhaix6:root:/root # errctr1 -c vscsi_initdd -q -r
```

Component name	Have alias	ErrChk /level	LowSev Disp	MedSev Disp
vscsi_initdd				
.vscsi0	YES	ON /1	48	64
.1un8100000000000000	NO	ON /1	48	64
.1un8300000000000000	NO	ON /1	48	64

The `vscsi_initdd` component is also enabled for the component dump and live dump services of the AIX enterprise RAS infrastructure.

4.2.4 MPIO and RAS component framework integration

AIX V6.1 enhances the AIX Multiple Path I/O (MPIO) framework and the AIX default Path Control Module (PCM) to exploit the AIX enterprise RAS infrastructure with regards to component tracing and run-time error checking. Component tracing and run time error checking are referred to as domains supported by the AIX enterprise RAS infrastructure services.

The following outlines the parent/child hierarchy for MPIO and PCM component registration and naming:

- ▶ In previous AIX releases, the disk head driver registers to the enterprise RAS framework as parent and each device controlled by the driver registers as a child of the disk head driver. AIX V6.1 establishes a parent/child hierarchy among the device instance of the disk head driver and the AIX MPIO framework. The MPIO framework registers to the enterprise RAS infrastructure as a child of the device instance controlled by the device driver. For example, the component name `scsidiskdd.hdisk1.mpio1` shows that `hdisk1` is the child of `scsidiskdd` and `mpio1` is the child of `hdisk1`. `hdisk1` is the device controlled by the parent SCSI disk, and `mpio1` is the MPIO framework for that `hdisk1`.
- ▶ No hierarchy is needed within a PCM, however the PCM itself registers to the AIX enterprise RAS infrastructure as a child of the MPIO framework. This extends the previously mentioned example component name to `scsidiskdd.hdisk1.mpio1.pcm1`. Here `pcm1` is the PCM for `hdisk1`.

The MPIO and PCM component hierarchy of any given AIX configuration and the current settings for the memory trace mode (private or light weight memory trace) and the user trace mode (system trace) can be listed by the **ctctrl** command:

```
hhaix6:root:/root # ctctrl -c scsidiskdd -q -r
```

Component name	Have alias	Mem Trc /level	Sys Trc /level	Buffer size /Allocated
scsidiskdd				
.cd0	YES	ON/3	ON/3	6400/YES
.hdisk0	YES	ON/3	ON/3	6400/YES
.mpio0	NO	ON/3	ON/3	4096/YES
.pcm0	NO	ON/3	ON/3	6400/YES
.hdisk1	YES	ON/3	ON/3	6400/YES
.mpio1	NO	ON/3	ON/3	4096/YES
.pcm1	NO	ON/3	ON/3	6400/YES

The RTEC MPIO and PCM component hierarchy of a given AIX configuration and the current settings for error checking level, disposition for low-severity errors, and disposition for medium-severity errors can be listed by the **errctrl** command. The **errctrl** command also allows to modify the run-time error checking related configuration parameters. The following **errctrl** command output shows that the default error checking level for all net components is minimal (level=1), that low-severity errors are ignored (LowSevDis=48), and medium-severity errors are logged (collect service data and continue) (MedSevDisp=64):

```
hhaix6:root:/root # errctrl -c scsidiskdd -q -r
```

Component name	Have alias	ErrChk /level	LowSev Disp	MedSev Disp
scsidiskdd				
.cd0	YES	ON /1	48	64
.hdisk0	YES	ON /1	48	64
.mpio0	NO	ON /1	48	64
.pcm0	NO	ON /1	48	64
.hdisk1	YES	ON /1	48	64
.mpio1	NO	ON /1	48	64
.pcm1	NO	ON /1	48	64

4.2.5 InfiniBand device driver component trace and RTEC support

Beginning with AIX V6.1 several of the AIX InfiniBand device drivers exploit the AIX enterprise RAS infrastructure with regards to component (device driver) naming and registration to the run-time error checking and component trace domains. The following AIX InfiniBand device drivers listed by their respective

base component names are enhanced to utilize the component framework for trace and run-time error checking:

if_ib	IP over InfiniBand interface
gxib	InfiniBand Host Channel Adapter (gxibdd)
icm	InfiniBand Connection Manager (icmdd)
tsib	4X InfiniBand PCI-X/ PCI-E card (tsibdd)

The following AIX filesets are impacted by the component framework adoption:

devices.chrp.IBM.lhca.rte	InfiniBand Host Channel Adapter device driver and ODM predefinitions
devices.common.IBM.ib.rte	InfiniBand Connection Manager (ICM), the IP over InfiniBand (IPoIB) interface and InfiniBand kernel libraries, as well as ODM predefinitions
devices.pci.b315445a.rte	4X InfiniBand PCI-X adapter device driver and ODM predefinitions

The InfiniBand device driver component hierarchy of a given AIX configuration and the current settings for the memory trace mode (private or light weight memory trace) and the user trace mode (system trace) can be listed by the **ctctr1** command. (The **ctctr1** command also allows to modify the component trace related configuration parameters.):

```
# ctctr1 -q -r -t network_ib
```

Component name	Have alias	Mem Trc /level	Sys Trc /level	Buffer size /Allocated
gxib	NO	ON/3	ON/3	1024/YES
.gxib_spec	NO	ON/3	ON/3	64000/YES
.iba0	NO	ON/3	ON/3	64000/YES
.iba1	NO	ON/3	ON/3	64000/YES
ibka	NO	ON/3	ON/3	128000/YES
icm	NO	ON/3	ON/3	128000/YES
if_ib	NO	ON/3	ON/3	1024/YES
.ib0	YES	ON/3	ON/3	64000/YES
.ib1	YES	ON/3	ON/3	64000/YES
.ib2	YES	ON/3	ON/3	64000/YES
.ib3	YES	ON/3	ON/3	64000/YES
tsib	NO	ON/3	ON/3	1024/YES
.iba0	NO	ON/3	ON/3	64000/YES
.tsib_spec	NO	ON/3	ON/3	64000/YES

The base components and the related child components of the previous example command output are defined as follows:

gxib	InfiniBand host channel adapter parent component and global trace component
------	---

gxib.gxib_spec	InfiniBand host channel adapter (code name Galaxy) specific library
gxib.iba#	Individual InfiniBand adapter driver instances (The # character denotes a place holder for the device instance number.)
ibka	InfiniBand connection manager kernel library
icm	InfiniBand connection manager
if_ib	IPoB parent component and global traces
if_ib.ib#	IPoB Interface instances (The # character denotes a place holder for the device instance number.)
tsib	InfiniBand Cisco PCI/PCI-E parent and global trace component
tsib.iba#	InfiniBand adapter's driver instance (The # character denotes a place holder for the device instance number.)
tsib.tsib_spec	InfiniBand Cisco specific library

The RTEC InfiniBand device driver component hierarchy of a given AIX configuration and the current settings for error checking level, disposition for low-severity errors, and disposition for medium-severity errors can be listed by the `errctr1` command. (The `errctr1` command also allows to modify the run-time error checking related configuration parameters.):

```
# errctr1 -c if_ib -q -r
# errctr1 -c gxib -q -r
# errctr1 -c icm -q -r
# errctr1 -c tsib -q -r
```

4.2.6 LAN device driver component trace and RTEC support

Beginning with AIX V6.1, several of the AIX local area network (LAN) device drivers exploit the AIX enterprise RAS infrastructure with regards to component (device driver) naming and registration to the run-time error checking and component trace domains. The following AIX LAN device drivers listed by their respective base component names are enhanced to utilize the component framework:

vioentdd	Virtual Ethernet device driver for LPAR clients and VIOS
goentdd	Device driver for the 1-Port, 2-Port, and 4-Port Gigabit Ethernet PCI-X/PCIe adapter family
headd	Device driver for the HEA 1/10Gb Ethernet GX bus-attached integrated device
kngentdd	Device driver for the 10 Gigabit Ethernet PCI-X DDR adapter

The following AIX filesets are impacted by the component framework adoption:

devices.pci.14106902.rte	1-Port, 2-Port, and 4-Port Gigabit Ethernet PCI-X/PCIe adapter family device driver
devices.pci.1410ec02.rte	LR/SR version of the 10 Gigabit Ethernet PCI-X DDR adapter
devices.chrp.IBM.lhea	HEA 1/10Gb Ethernet device driver
devices.vdevice.IBM.l-lan.rte	Virtual Ethernet device driver

For the virtual Ethernet device driver component framework adoption the base component name *vioentdd* designates a global head or anchor node with no associated resources. The *vioentdd* component is merely a marker that identifies the device driver to which the relevant sub-components are related. The *vioentdd* anchor node has two child nodes, *dd* and *ffdc*. The *vioentdd.dd* sub-component designates the global component for the device driver and is used to log generic non-device-specific data. The *vioentdd.ffdc* sub-component records all global errors for First Failure Data Capture purposes. Under the *dd* component the individual devices register their own component labeled by the respective *device logical names* (for example *ent0* for an Ethernet adapter). Finally, each device component has a dedicated *ffdc*, *managers*, *other*, *receive*, and *transmit* sub-component. The device specific *ffdc* component only logs errors which are usually hard errors that are non-recoverable. The *managers* component is dedicated to log data about the memory managers used for the *vioentdd* device driver. The *other* component captures generic errors and information that is device-specific. As suggested by their names, the *receive* and *transmit* components are utilized to capture data and trace errors related to receive and transmit operations respectively. Note that the *ffdc*, *managers*, *other*, *receive*, and *transmit* sub-components are only created when a device is opened, that is, has a TCP/IP interface assigned and is in the available state.

In respect to component trace, the `ctctrl` command can be used to list and control all LAN base components and their individually registered sub-components, for example:

```
hhaix6:root:/root # ctctrl -c vioentdd -q -r
```

Component name	Have alias	Mem Trc /level	Sys Trc /level	Buffer size /Allocated
vioentdd				
.dd	NO	ON/3	ON/3	524288/YES
.ent0	YES	ON/3	ON/3	32768/YES
.ffdc	NO	ON/3	ON/3	65536/YES
.managers	NO	ON/3	ON/3	65536/YES
.other	NO	ON/3	ON/3	32768/YES
.receive	NO	ON/3	ON/3	32768/YES
.transmit	NO	ON/3	ON/3	32768/YES
.ffdc	NO	ON/3	ON/3	2097152/YES

The previous listing shows the sub-components for a virtual ethernet adapter with the device logical name ent0. For your convenience you can refer to the component vioentdd.dd.ent0 directly by the alias ent0. As you can see, each virtual ethernet device has its own First Failure Data Capture (ffdc), managers, other, packet receive (receive), and packet transmit (transmit) component.

The RTEC virtual ethernet device driver component hierarchy of a given AIX configuration and the current settings for error checking level, disposition for low-severity errors, and disposition for medium-severity errors can be listed by the **errctr1** command. The **errctr1** command also allows to modify the run-time error checking related configuration parameters. The following **errctr1** command example output shows that the default error checking level for all vioentdd components is normal (level=3), that low-severity errors are ignored (LowSevDis=48), and medium-severity errors are logged (collect service data and continue) (MedSevDisp=64):

```
hhaix6:root:/root # errctr1 -c vioentdd -q -r
```

Component name	Have alias	ErrChk /level	LowSev Disp	MedSev Disp
vioentdd				
.dd	NO	ON /3	48	64
.ent0	YES	ON /3	48	64

The component hierarchy for Ethernet device drivers and device instances which are not related to the VIOS or the virtual Ethernet device drivers for LPAR clients differ from the vioentdd virtual Ethernet device driver component hierarchy as follows. For the 1, and 10 Gb Ethernet adapters, and the Host Ethernet Adapters (HEA, also known as Integrated Virtual Ethernet adapter (IVE)) one global base component for each device driver is registered with the AIX component framework. The component names are defined by the AIX names of the respective device driver, *goentdd*, *headd*, or *knentdd*. Each individual component is used to capture all traces related to configuration-time before the actual device is configured. From there, each device is a child of the global component and has its own component labeled by the *device logical name* (for example ent0 for an Ethernet adapter). This device component is used to capture all traces and run-time data that is not related to packet transmit or packet receive operations. Examples would be general errors, important data trace points, and I/O control (ioctl) paths. The packet transmit and packet receive related data and trace errors are recorded by two additional device sub-components, TX and RX respectively. The TX and RX components are only allocated and used for each individual device when the related adapter has been opened and is able to transmit and receive data. An Ethernet adapter is defined to be open when a TCP/IP interface has been assigned and the adapter is in the available state.

The following **ctctr1** and **errctr1** command example outputs show the component hierarchy and the component trace and run-time error detection related configuration parameters for two different Gigabit Ethernet PCI-X/PCIe adapter configurations. Note that the **ctctr1** output lists multiple devices of which only the ent1 adapter has been opened to receive or transmit data:

```
# ctctr1 -c goentdd -q -r
```

Component name	Have alias	Mem Trc /level	Sys Trc /level	Buffer size /Allocated
goentdd	NO	OFF/3	ON/3	0/ NO
.ent0	YES	ON/3	ON/3	131072/YES
.ent1	YES	ON/3	ON/3	131072/YES
.RX	NO	ON/3	ON/3	131072/YES
.TX	NO	ON/3	ON/3	131072/YES
.ent3	YES	ON/3	ON/3	131072/YES
.ent4	YES	ON/3	ON/3	131072/YES
.ent5	YES	ON/3	ON/3	131072/YES

```
# errctr1 -c goentdd -q -r
```

Component name	Have alias	ErrChk /level	LowSev Disp	MedSev Disp
goentdd	NO	ON /7	48	64
.ent0	YES	ON /7	48	64
.ent1	YES	ON /7	48	64
.ent3	YES	ON /7	48	64
.ent4	YES	ON /7	48	64
.ent5	YES	ON /7	48	64

The following **ctctr1** and **errctr1** command example outputs show the component hierarchy and the component trace and run-time error detection related configuration parameters for a given Host Ethernet Adapter configuration:

```
# ctctr1 -c headd -q -r
```

Component name	Have alias	Mem Trc /level	Sys Trc /level	Buffer size /Allocated
headd	NO	ON/3	ON/3	131072/YES
.ent1	YES	ON/3	ON/3	131072/YES
.RX	NO	ON/3	ON/1	131072/YES
.TX	NO	ON/3	ON/1	131072/YES

```
# errctr1 -c headd -q -r
```

Component name	Have alias	ErrChk /level	LowSev Disp	MedSev Disp
headd	NO	ON /7	48	64
.ent1	YES	ON /7	48	64
.RX	NO	ON /7	48	64
.TX	NO	ON /7	48	64

Component name	alias	/level	Disp	Disp
headd				
.ent1	YES	ON /3	48	64

The following **ctctr1** and **errctr1** command example outputs show the component hierarchy and the component trace and run-time error detection related configuration parameters for a given 10 Gigabit Ethernet PCI-X DDR adapter configuration:

```
# ctctr1 -c kngentdd -q -r
```

Component name	Have alias	Mem Trc /level	Sys Trc /level	Buffer size /Allocated
kngentdd	NO	OFF/3	ON/3	0/ NO
.ent0	YES	ON/3	ON/3	131072/YES
.RX	NO	ON/3	ON/3	131072/YES
.TX	NO	ON/3	ON/3	131072/YES

```
# errctr1 -c kngentdd -q -r
```

Component name	Have alias	ErrChk /level	LowSev Disp	MedSev Disp
kngentdd	NO	ON /3	48	64
.ent0	YES	ON /3	48	64

4.2.7 Error level checking for TCP kernel and kernel extension

The AIX operating system will be forced to halt when the TCP kernel and kernel extension code encounters unexpected paths or unrecoverable errors (debug asserts). However at certain places in the TCP kernel code of previous AIX releases, it would have been not required to force a system halt as the return error could have been handled by the running process itself. In AIX V6.1 these conditions and asserts were identified and are either replaced with component traces along with proper return code or are moved under an appropriate run-time error level. AIX V6.1 collects the required debug information using component trace and with the relevant return code, errors can be handled effectively by the calling process. The trace can be saved in component memory or system memory or both. The size of the memory buffer can be changed dynamically.

In summary, AIX V6.1 enhances the exploitation of the AIX enterprise RAS infrastructure by the TCP kernel and netinet kernel extension in two ways:

1. Provide run-time error checking information instead of system halt at default level.

2. Provide additional component trace framework integration.

The following routines were modified to improve the failure robustness of the TCP kernel and kernel extension code: `m_copym()`, `m_copydata()`, `m_copymext()`, `uipc_usrreq()`, `udp_usrreq()`, `rip_usrreq()`, `if_attach()`, `in_control()`, `in6_control()`, and `netintr()`. Also, a new sub-component *netisr* was implemented under the parent component `net` for the component trace and the run-time error checking domain. And finally, component traces are added to all network software interrupt routines (`netisr`) in AIX V6.1.

The `net` component hierarchy of any given AIX configuration and the current settings for the memory trace mode (private or light weight memory trace) and the user trace mode (system trace) can be listed by the `ctctrl` command. The `ctctrl` command also allows to modify the component trace related configuration parameters.

```
hhaix6:root:/root # ctctrl -c net -q -r
```

Component name	Have alias	Mem Trc /level	Sys Trc /level	Buffer size /Allocated
net	NO	ON/1	ON/7	1024/YES
.cdli	NO	ON/1	ON/7	10240/YES
.loop	NO	ON/1	ON/7	10240/YES
.netisr	NO	ON/1	ON/7	10240/YES
.route	NO	ON/1	ON/7	40960/YES

The RTEC `net` component hierarchy of a given AIX configuration, current settings for error checking level, and disposition for low-severity errors, can be listed by the `errctrl` command. The `errctrl` command also allows to modify the run-time error checking related configuration parameters. The following `errctrl` command output shows that the default error checking level for all `net` components is minimal (`level=1`), that low-severity errors are ignored (`LowSevDis=48`), and medium-severity errors are logged (collect service data and continue) (`MedSevDisp=64`):

```
hhaix6:root:/root # errctrl -c net -q -r
```

Component name	Have alias	ErrChk /level	LowSev Disp	MedSev Disp
net	NO	ON /1	48	64
.cdli	NO	ON /1	48	64
.loop	NO	ON /1	48	64
.netisr	NO	ON /1	48	64
.route	NO	ON /1	48	64

4.2.8 IPsec component trace exploitation

What is generally thought of as the Internet Protocol Security (IPsec) subsystem is actually a collection of several kernel extensions. To enable component trace exploitation for IP security AIX V6.1 introduces an IPsec base component, named *ipsec*, and one sub-component for each of the *capsulate*, *crypto*, *filter*, and *tunnel* IPsec kernel extensions. The IPsec component hierarchy and the current settings for the memory trace mode (private or light weight memory trace) and the user trace mode (system trace) can be listed by the `ctctrl` command:

```
hhaix6:root:/root # ctctrl -c ipsec -q -r
```

Component name	Have alias	Mem Trc /level	Sys Trc /level	Buffer size /Allocated
ipsec	NO	ON/3	ON/3	40960/YES
.capsulate	NO	ON/3	ON/3	10240/YES
.crypto	NO	ON/3	ON/3	10240/YES
.filter	NO	ON/3	ON/3	10240/YES
.tunnel	NO	ON/3	ON/3	10240/YES

The trace buffers are structured so that all IPsec components dump trace into a single large buffer that goes to system trace. Smaller buffers will be used for component specific memory mode tracing. This tracing will be turned on by default. The following describes the different IPsec trace buffers being created:

Parent ipsec buffer	This buffer of 40 KB size is used as a global IPsec trace buffer to collect almost all of the component trace information.
Capsulate buffer	This private trace buffer of 10 KB buffer size is used only for capsulate kernel extension memory mode tracing.
Crypto buffer	This private trace buffer of 10 KB size is used only for the crypto kernext memory mode tracing.
Filter buffer	This private trace buffer of 10 KB size is used only for the filter kernext memory mode tracing.
Tunnel buffer	This private trace buffer of 10 KB size is used only for the tunnel kernext memory mode tracing.

AIX V6.1 defines IPsec trace hook IDs in the `ipsp_trchk.h` header file and their corresponding trace formatting in `/etc/trcfmt`.

4.2.9 PCI device driver component trace adoption

In AIX V6.1, several new RAS features were implemented within the PCI bus device driver. These features include component trace, use of storage keys and new private heaps for memory allocated by the driver to improve data isolation. On the first call to the configuration and initialization kernel service, the PCI bus

driver registers a *pci* base component and a *pci.eeh* sub-component with the component framework of AIX. Each call to the configuration and initialization routine also results in the registration of a *pci.pci#* sub-component, where # designates a place holder for integer values. On each call to the kernel service which allocates and initializes resources for performing Direct Memory Access (DMA) with PCI devices (*d_map_init*), an additional sub-component is registered in the form of *pci.pci#.handle#*, where # designates a place holder for configuration dependent integer values. This implementation allows drivers with multiple handles to have separate component trace buffers to trace the DMA activities of each handle separately.

The PCI component hierarchy can be represented as follows:

```
pci
  .pci0
  .pci1
    .handle1
    .handle2
  .pci2
    .handle1
    .handle2
    .handle3
    .handle4
  .pci3
    .handle1
...
  .eeh
```

Also, the alias *eeh* has been created to refer to the sub-component *pci.eeh* for convenience.

The PCI component hierarchy of any given AIX configuration and the current settings for the memory trace mode (private or light weight memory trace) and the user trace mode (system trace) can be listed by the **ctctr1** command. The **ctctr1** command also allows to modify the component trace related configuration parameters:

```
# ctctr1 -c pci -q -r
```

Component name	Have alias	Mem Trc /level	Sys Trc /level	Buffer size /Allocated
pci				
.eeh	YES	ON/3	ON/3	2048/YES
pci2				
.handle1	NO	ON/3	ON/3	512/YES
.handle2	NO	ON/3	ON/3	512/YES

pci3								
.handle1		NO		ON/3		ON/3		512/YES
.handle2		NO		ON/3		ON/3		512/YES

4.2.10 Virtual bus device driver component trace adoption

In AIX V6.1, several new RAS features were implemented within the virtual bus device driver. These features include component trace, use of storage keys and new private heaps for memory allocated by the driver to improve data isolation.

On the first call to the configuration and initialization kernel service, the virtual bus driver registers with the AIX RAS component framework under the base component name *vdev*. Each call to the configuration and initialization routine also results in the registration of a *vdev.vio#* sub-component, where # designates a place holder for integer values. On each call to the kernel service which allocates and initializes resources for performing Direct Memory Access (DMA) with virtual bus devices, an additional sub-component is registered in the form of *vdev.vio#.handle#*, where # designates a place holder for configuration dependent integer values. This implementation allows drivers with multiple handles to have separate component trace buffers to trace the DMA activities of each handle separately.

The virtual bus device driver component hierarchy of any given AIX configuration and the current settings for the memory trace mode (private or light weight memory trace) and the user trace mode (system trace) can be listed by the **ctctrl** command:

```
hhaix6:root:/root # ctctrl -c vdev -q -r
```

Component name	Have alias	Mem Trc /level	Sys Trc /level	Buffer size /Allocated
vdev				
vio0				
.handle1	NO	ON/3	ON/3	512/YES
.handle10	NO	ON/3	ON/3	512/YES
.handle2	NO	ON/3	ON/3	512/YES
.handle3	NO	ON/3	ON/3	512/YES
.handle4	NO	ON/3	ON/3	512/YES
.handle5	NO	ON/3	ON/3	512/YES
.handle6	NO	ON/3	ON/3	512/YES
.handle7	NO	ON/3	ON/3	512/YES
.handle8	NO	ON/3	ON/3	512/YES
.handle9	NO	ON/3	ON/3	512/YES

4.2.11 Component trace for USB system driver

The USB system driver is enhanced in AIX V6.1 to exploit the AIX enterprise RAS component trace framework. The base component name for the USB system driver is *usb_system* and one single component specific node with the sub-component name of *usb0* will be defined during the driver configuration and initialization process. Note, no matter how many USB host controllers or USB devices are attached to the system, there is only one USB system driver instance in the customized devices CuDv ODM database whose name is always *usb0*. USB system driver component tracing will utilize private buffer memory trace mode and user trace mode. The USB system driver trace hook ID is 0x738.

The *usb_system* parent node is not component framework domain aware; that is, it will simply be a place holder. The *usb0* node is component trace aware, but is not enabled for the run-time error checking or component dump domain of the AIX enterprise RAS component framework. The following customization are performed for the *usb0* node during driver configuration:

1. A 8192 byte private trace buffer will be allocated.
2. Memory trace mode will be enabled.
3. An alias of *usb0* will be created for the *usb_system.usb0* component.

The USB system driver component hierarchy for a given configuration and the current settings for the memory trace mode (private memory trace) and the user trace mode (system trace) can be listed by the **ctctr1** command:

```
# ctctr1 -c usb_system -q -r
```

Component name	Have alias	Mem Trc /level	Sys Trc /level	Buffer size /Allocated
usb_system				
.usb0	YES	ON/3	ON/3	8192/YES

The **ctctr1** command also allows to modify the component trace related configuration parameters.

4.2.12 Component trace for USB audio

The USB audio device driver will use component trace in a way that allows traces to be associated with either the entire parent driver or with any of the existing sub-component. The entire parent driver will be identified by the registered component name *usb_audio*. The USB audio driver trace hook ID is 0x61E. The sub-components are selected to be the devices as they are listed in the ODM that have device special files in */dev* and they are identified by their logical device name. Code that is related to the USB audio device driver but which is not

associated with a specific sub-component falls under parent driver `usb_audio` base component. The `ctctrl` command can be used to list and control the USB audio driver parent component and all sub-components registered under the `usb_audio` base component name.

The following listing represent one USB audio device composed of three USB interfaces. Each of these three USB interfaces have a device in ODM and `/dev`.

When the USB audio driver is loaded and called to configure the first device, it configures the parent device driver base component first, and then the sub-component devices:

```
# ctctrl -c usb_audio -q -r
```

Component name	Have alias	Mem Trc /level	Sys Trc /level	Buffer size /Allocated
<code>usb_audio</code>	NO	ON/1	ON/3	4096/YES
<code>.paud0</code>	NO	ON/1	ON/3	4096/YES
<code>.paudas0</code>	NO	ON/1	ON/3	4096/YES
<code>.paudas1</code>	NO	ON/1	ON/3	4096/YES

The list of the audio devices can be displayed by the `lsdev` command as follows:

```
# lsdev -C -c audio
paud0 Available 0.2.1 USB Audio Device, AudioControl Interface
paudas0 Available 0.2.1 USB Audio Device, AudioStreaming Interface
paudas1 Available 0.2.1 USB Audio Device, AudioStreaming Interface
```

4.2.13 Component trace for 2D graphics device drivers

Beginning with AIX V6.1 the 2D graphics device drivers for the GXT130P and GXT145 graphics adapters are instrumented to leverage the component trace services. The integration into the component trace framework enables both the memory trace mode (private or light weight memory trace) and the user trace mode (system trace) for the named graphics device drivers. This enhancements provides advanced First Failure Data Capture (FFDC) and Second Failure Data Capture (SFDC) capabilities and will potentially supersede the need for custom-built debug drivers. The hierarchy within 2D graphics device drivers defines the device driver itself as the base component and each adapter controlled by that device driver is implemented as a sub-component identified by the logical device name. The following base component names are introduced:

<code>lanaidd</code>	GXT130P graphics adapter 2D device driver delivered by the <code>devices.pci.2b102005.rte</code> fileset
<code>cortinadd</code>	GXT145 graphics adapter 2D device driver delivered by the <code>devices.pci.2b102725.rte</code> fileset

The base component names are references to the development code names Lanai (sixth-largest of the Hawaiian Islands) and Cortina (Cortina d'Ampezzo, a town in northern Italy). Each adapter 's trace event will use the same trace hook ID as in previous system trace debug driver versions:

- ▶ Lanai 's hook ID = 0x737
- ▶ Cortina 's hook ID = 0x73C

The 2D graphics device driver component hierarchy for a given configuration and the current settings for the memory trace mode (private or light weight memory trace) and the user trace mode (system trace) can be listed by the **ctctrl** command:

```
# ctctrl -c lanaidd -q -r
```

Component name	Have alias	Mem Trc /level	Sys Trc /level	Buffer size /Allocated
lanaidd				
.lai0	YES	ON/3	ON/3	2560/YES

```
# ctctrl -c cortinadd -q -r
```

Component name	Have alias	Mem Trc /level	Sys Trc /level	Buffer size /Allocated
cortinadd				
.cor0	YES	ON/3	ON/3	2560/YES

The **ctctrl** command also allows to modify the component trace related configuration parameters.

4.2.14 System loader run-time error checking

The AIX system loader was enhanced in AIX V6.1 to begin taking advantage of the AIX RAS component framework for the run-time error checking (RTEC) domain of the AIX enterprise RAS infrastructure. The system loader RTEC adoption provides improved first failure data capture (FFDC) support, which allows defects to be found closer to their root cause in a production environment.

The AIX V6.1 system loader code has been segmented into RTEC-aware components, which are registered individually with the AIX enterprise RAS infrastructure. Tuning can then be done at a component level, such as modifying the error-checking level or dispositions for 64-bit programs without affecting the treatment of 32-bit programs.

The AIX V6.1 system loader manages multiple regions used for loading programs and shared objects. Each region corresponds to a RTEC-aware component. The following table lists the components that are registered with the AIX V6.1 enterprise RAS component framework:

Table 4-2 System loader RAS components

Component	Alias	Description
ldr		Loader base component
ldr.kernext	kernext	Kernel extension region
ldr.lib32	lib32	32-bit libraries
ldr.lib64	lib64	64-bit libraries
ldr.lib32.xxx		32-bit libraries for WPARs or named shared library regions
ldr.lib64.xxx		64-bit libraries for WPARs or named shared library regions
ldr.process32		General 32-bit processes
ldr.process64		General 64-bit processes

The xxx characters in ldr.lib32.xxx and ldr.lib64.xxx are replaced with the region or WPAR name.

4.2.15 NFS and CacheFS run-time error checking

Beginning with AIX V6.1 the Network File System version 4 (NFSv4) and the Cache File System (CacheFS) implementation utilize the AIX RAS component framework for the run-time error checking (RTEC) domain of the AIX enterprise RAS infrastructure.

The NFSv4 extension of AIX V6.1 creates a hierarchical name space which allows run-time error checking to be tuned in a granular manner. The NFSv4 extension defines a generic base component (anchor node) named *nfs* and the initialization of NFSv4 results in a NFS version specific child of the *nfs* anchor node called *nfs4*. This part of the name space can be considered as essentially static. Client and server nodes are then created as children (or leaf nodes) of the NFSv4 anchor node at run-time. This will result in the NFS component adding the paths *nfs.nfs4.nfs4_client* and *nfs.nfs4.nfs4_server* to the AIX enterprise RAS component name space.

The RTEC NFSv4 component hierarchy of a given AIX configuration and the current settings for error checking level, disposition for low-severity errors, and disposition for medium-severity errors can be listed by the **errctr1** command. The **errctr1** command also allows to modify the run-time error checking related configuration parameters. The following **errctr1** command output shows that the default error checking level for all NFSv4 components is normal (level=3), that low-severity errors are ignored (LowSevDis=48), and medium-severity errors are logged (collect service data and continue) (MedSevDisp=64):

```
hhaix6:root:/root # errctr1 -c nfs -q -r
```

Component name	Have alias	ErrChk /level	LowSev Disp	MedSev Disp
nfs				
nfs4				
.nfs4_client	NO	ON /3	48	64
.nfs4_server	NO	ON /3	48	64

The CacheFS kernel extension creates a hierarchical name space which allows run-time error checking to be tuned in a granular manner. The CacheFS kernel extension defines a base component named *cachefs* during initialization. This base component can be considered as essentially static. CacheFS creates a child of the anchor node for each CacheFS filesystem at run-time. The sub-component name consists of the NFSv4 mount point and an appended filesystem specific unique ID. Special characters of the mount point name are converted to underscores. Also, the JFS2 layer instantiates for each CacheFS directory created in the local file system one *jfs2.filesystem._cachfs_32.metadata* and one *jfs2.filesystem._cachfs_32.user.data* RTEC component.

The RTEC CacheFS component hierarchy of a given AIX configuration and the current settings for error checking level, disposition for low-severity errors, and disposition for medium-severity errors can be listed by the **errctr1** command. The **errctr1** command also allows to modify the run-time error checking related configuration parameters. The following **errctr1** command output shows that the default error checking level for all CacheFS components is normal (level=3), that low-severity errors are ignored (LowSevDis=48), and medium-severity errors are logged (collect service data and continue) (MedSevDisp=64). The sub-component name *_usr_sys_inst_images_ITUAMv6_1_22* refers to the NFSv4 local mount point */usr/sys/inst.images/ITUAMv6.1*:

```
hhaix6:root:/root # errctr1 -c cachefs -q -r
```

Component name	Have alias	ErrChk /level	LowSev Disp	MedSev Disp
cachefs				
._usr_sys_inst_images_ITUAMv6_1_22	NO	ON /3	48	64

4.2.16 Run-time error checking for watchdog timer

The watchdog timer kernel services are typically utilized to verify that an I/O operation completes in a reasonable time. The watchdog timer services can be used for noncritical times having a one-second resolution. Because a watchdog timer has less granularity than a timer created with the `talloc()` kernel service, it exhibits a much lower path-length footprint when starting the timer. However, this highly efficient service is achieved at the expense of structural robustness.

AIX V6.1 enhances the watchdog timer kernel services implementation by adding self-checking functionality to support First Failure Data Capture (FFDC) capabilities and to improve the overall serviceability characteristic.

During the AIX kernel initialization a specific kernel service is called to setup timer services for the master processor (processor ID 0 in most cases). This kernel service in turn calls the initialization kernel service for the watchdog timer. At the beginning of the later initialization process AIX V6.1 registers the watchdog timer component with the AIX enterprise RAS component framework under the name *watchdog*. The watchdog timer component is implemented as a child of the *proc* processor component in the RAS component hierarchy.

The RTEC watchdog timer component of a given AIX configuration and the current settings for error checking level, disposition for low-severity errors, and disposition for medium-severity errors can be listed by the `errctr1` command. The `errctr1` command also allows to modify the run-time error checking related configuration parameters. The following `errctr1` command output shows that the default error checking level for the watchdog timer component is normal (level=3), that low-severity errors are ignored (LowSevDis=48), and medium-severity errors are logged (collect service data and continue) (MedSevDisp=64).

```
hhaix6:root:/usr/include/sys # errctr1 -c proc -q -r
```

Component name	Have alias	ErrChk /level	LowSev Disp	MedSev Disp
proc				
.disa	NO	ON /3	48	64
.lock	NO	ON /3	48	64
.watchdog	NO	ON /3	48	64

4.2.17 System memory allocator adoption of run-time error checking

In AIX 5L V5.3 TL5 the system memory allocator `xmalloc` run-time error checking (RTEC) function was integrated into the RAS component hierarchy, and appears

as the *alloc.xmdbg* and the *alloc.heap0* component. This allows their run-time error checking properties to be adjusted by the `errctr1` command.

The *alloc.xmdbg* component provides RTEC capabilities for memory allocation in the kernel heap, pinned heap, and all heaps created by the kernel subsystem through the `heap_create` subroutine. The *alloc.heap0* component applies to the loader specific heap that appears in the kernel segment.

In AIX V6.1, to provide better first failure data capture (FFDC) characteristics, more run-time error checks occur by default in the product code than in previous AIX versions. There is a natural conflict between checking and performance, and that conflict is minimized by sampling whether `xmalloc` (and `xmfree` by extension) should employ various checking techniques on a given call. The sampling frequencies can be tuned individually or changed by raising the error checking level. As the checking level goes up, the performance impact is greater.

Note: All default values for sampling frequencies may be subject to change without notice.

High-level controls for `xmalloc` RTEC

By default, `xmalloc` RTEC is enabled in AIX V6.1 and the characteristics for this component can be controlled at different levels. At one level, `xmalloc` RTEC can be disabled (or re-enabled) along with all other AIX run-time error checking. System administrators may use the `smitty ffdc` interface to the `/usr/lib/ras/ffdcctr1` command, or apply appropriate `errctr1` commands to do this. `errctr1 errcheckoff` and `errctr1 errcheckon` commands affect all of AIX error checking. Error checking characteristics can also be changed for the `xmalloc` subsystem with component specific tuning parameters. In AIX V6.1 a reboot is never required to change a checking level. All options can be configured at run time using the `errctr1` command.

The following command is available to turn off error checking for the system memory allocator:

```
# errctr1 -c alloc.xmdbg errcheckoff
```

AIX V6.1 offers the additional, optional flag `-P` to make this setting persistent across reboots.

Use the following command to turn on error checking for `xmalloc`. The command enables `xmalloc` RTEC at previously set checking levels or at default levels:

```
# errctr1 -c alloc.xmdbg errcheckon
```

Note, the default checking level in AIX V6.1 is `ERRCHECK_NORMAL` (3) whereas the checking level in AIX V5.3 was configured to be `ERRCHECK_MINIMAL` (1).

The `alloc.xmdbg` and `alloc.heap0` components and their potential child components support a variety of tuning parameters that can be changed as a group. This is done with the `errctr1` command using the `errcheckminimal`, `errchecknormal`, `errcheckdetail`, and `errchecklevel=9` sub-commands.

To set `alloc.xmdbg` RTEC to minimal error checking level system administrators need to run the following command:

```
# errctr1 -c alloc.xmdbg errcheckminimal
```

When the error-checking level is set to minimal (level 1), the checks and techniques used by `xmalloc` are applied at fairly low frequencies. These frequencies can be examined with the `kdb` command `xm -Q`.

This can be done from the command line by piping `xm -Q` to the `kdb` command:

```
# echo xm -Q | kdb
```

Minimal checking is the default checking level in AIX V5.3. The frequency that appears next to each tuning parameter is proportional to the frequency base. In the following example, the ruin all data technique will be applied 5 times out of every 1024 (0x400) calls to `xmalloc` (about 0.5% of the time). 16 byte allocations will be promoted about 10 times out of every 1024 calls to `xmalloc` (about 1% of the time). The various checks and techniques will be described in more detail later.

```
KDB(1)> xm -Q
XMDBG data structure @ 000000002521360
Debug State: Enabled
Frequency Base 00000400
Tunable                                Frequency
Allocation Record                       00000033
Ruin All Data                            00000005
Trailer non-fragments                    00000005
Trailer in fragments                     00000005
Redzone Page                             00000005
VMM Check                                 0000000A
Deferred Free Settings
  Fragments                              00000005
  Non-fragments                          00000005
  Promotions                              00000066

Page Promotion
  Frag size      Frequency
  [00010]        0000000A
```

```
[00020]      0000000A
[00040]      0000000A
```

... omitted lines ...

In AIX V6.1 the levels and tuning parameters are slightly different in comparison to AIX V5.3. The kdb output has changed, because the frequency base is 65536 in AIX V5.3 but 1024 in AIX V6.1 and because the formatting has been enhanced. These frequencies are always subject to change but can be examined on a live machine.

To set alloc.xmdbg RTEC to normal error checking level system administrators need to run the following command:

```
# errctr1 -c alloc.xmdbg errchecknormal
```

When the error-checking level is set to normal (level 3), the checks and techniques are applied at higher frequencies than minimal checking provides. Normal error checking is the default level setting in AIX V6.1. In the following example, a trailer will be added to a fragment about 51 (0x33) times out of every 1024 times a fragment is allocated (about 5%). The deferred free technique will be applied to page promotions about 153 (0x99) times out of every 1024 (0x400) times a fragment is promoted (about 15% of the time). These techniques will be discussed in more detail later. These frequencies are subject to change, but can always be examined on a live machine. In AIX V6.1 the levels and tuning parameters are slightly different in comparison to AIX V5.3.

```
KDB(0)> xm -Q
XMDBG data structure @ 0000000025426F0
Debug State:  Enabled
Frequency Base:  00000400
Tunable          Frequency
Allocation Record 00000099
Ruin All Data     00000033
Trailer non-fragments 0000000A
Trailer in fragments 00000033
Redzone Page     0000000A
VMM Check        0000000A
Deferred Free Settings
  Fragments       0000000A
  Non-fragments  0000000A
  Promotions      00000099

Page Promotion
  Frag size      Frequency
  [00010]        0000000D
  [00020]        0000000D
  [00040]        0000000D
```

... omitted lines ...

To set alloc.xmdbg RTEC to detail error checking level system administrators need to run the following command:

```
# errctrl -c alloc.xmdbg errcheckdetail
```

When the error-checking level is set to detail (level 7), the checks and techniques are applied at fairly high frequencies. This gives a high checking level with a goal of not impacting system performance too greatly. In the example below, allocation records are kept on every call to xmalloc (0x400 out of 0x400 calls). 0x80 byte fragments are promoted 0x200 out of every 0x400 times the 0x80 byte fragment is allocated (50%):

```
KDB(0)> xm -Q
XMDBG data structure @ 0000000025426F0
Debug State: Enabled
Frequency Base: 00000400
Tunable Frequency
Allocation Record 00000400
Ruin All Data 00000200
Trailer non-fragments 00000066
Trailer in fragments 00000200
Redzone Page 00000266
VMM Check 00000266
Deferred Free Settings
Fragments 00000066
Non-fragments 00000066
Promotions 00000200

Page Promotion
Frag size Frequency
[00010] 00000200
[00020] 00000200
[00040] 00000200
[00080] 00000200
```

... omitted lines ...

These AIX V6.1 levels and tuning parameters are much different in comparison to the previous AIX release. In AIX V5.3, errcheckdetail is more severe and is the same as maximal level (9) in AIX V6.1 as shown in the next paragraph. The kdb output format has been enhanced for AIX V6.1.

To set alloc.xmdbg RTEC to maximum error checking level system administrators need to run the following command:

```
# errctrl -c alloc.xmdbg errchecklevel=9
```

At this checking level, all tuning parameters are set at maximum levels. Performance is most greatly affected at this checking level. All the frequencies should match the frequency base, meaning all checks are always done.

```
KDB(0)> xm -Q
XMDBG data structure @ 0000000025426F0
Debug State:  Enabled
Frequency Base:  00000400
Tunable          Frequency
Allocation Record 00000400
Ruin All Data     00000400
Trailer non-fragments 00000400
Trailer in fragments 00000400
Redzone Page     00000400
VMM Check        00000400
Deferred Free Settings
  Fragments      00000400
  Non-fragments  00000400
  Promotions     00000400

Page Promotion
  Frag size      Frequency
  [00010]       00000400
  [00020]       00000400
  [00040]       00000400
  [00080]       00000400

... omitted lines ...
```

Low-level xmalloc debug tuning parameters

xmalloc RTEC features are activated for a given allocation based on probabilities. The `errctr1` command that controls the tuning parameters takes the probability of application (frequency) as an argument. In AIX V6.1, the system administrator can set the probability of a check being performed by specifying the frequency of the tuning parameter as a number between 0 and 1024. This is the number of times out of the base frequency (1024) the technique is to be applied by xmalloc. For example, to request 50%, the system administrator specifies a frequency of 512. Frequencies can be input as decimal or hexadecimal numbers, so 50% can be specified as 0x200. As a convenient alternative, the frequency can be expressed as a percentage. To do this, the system administrator specifies a number between 0 and 100 followed by the % sign. In AIX V5.3, the base frequency is 65536, so to request 50%, the user specifies a frequency of 32768. Hexadecimal numbers are not accepted and the percentage frequency is not supported in AIX V5.3.

Note: The base frequency and the default frequencies for any xmalloc debug tuning parameter may be subject to change without notice.

Tuning parameters affected by RTEC level

By default, the value of all the xmalloc related tuning parameters is set based on the error checking level, as described previously. Specific tuning parameters can be changed by using pass-through sub-commands. The following paragraphs detail the pass-through commands and the effects of each tuning parameter.

Keep an allocation record

```
# errctrl -c alloc.xmdbg alloc_record=<frequency>
```

This command sets the frequency of keeping a record for an allocation. Records are also kept if any other debug technique is applied, so the percentage of allocations with a record may be considerably larger than this number would otherwise indicate. The allocation record contains a three-level stack trace-back of the xmalloc and xfree callers as well as some other debug information about the allocated memory. The presence of a record is a minimum requirement for RTEC.

Ruin Storage

```
# errctrl -c alloc.xmdbg ruin_all=<frequency>
```

This options sets the frequency at which xmalloc will return storage that is filled with a ruin pattern. This helps catch errors with un-initialized storage, as a caller with bugs is more likely to crash when using the ruined storage. xmalloc does not perform any explicit checks when this technique is employed. The ruined data will contain 0x66 in every allocated byte on allocation, and 0x77 in every previously allocated byte after being freed.

Check for overwrites in small allocations

```
# errctrl -c alloc.xmdbg small_trailer=<frequency>
```

This is one of three options that affect the frequency of trailers. There are two options that deal with trailers and a third compatibility option. The small_trailer option is specific for allocations that are less than 1/2 page. A trailer is a data pattern that is written immediately after the returned storage. Trailers can consume up to 128 bytes of storage. When storage is freed, xfree will ensure consistency in the trailer bytes and log an error for any infractions, since inconsistencies represent over-writes.

This option is new in AIX V6.1. In AIX V5.3 all trailers are controlled with a single tuning parameter (alloc_trailer). The error disposition can be made more severe by changing the disposition of medium severity errors as follows:

```
# errctrl -c alloc.xmdbg medsevd disposition=sysdump
```

Overwrites to the trailers and other medium severity errors will cause a system crash if the severity disposition is changed as above.

Check for overwrites in large allocations

```
# errctrl -c alloc.xmdbg large_trailer=<frequency>
```

This option sets the frequency of trailers that are added to allocations that require at least a full page. The page size depends on the heap. This technique catches the same type of errors as a redzone, but a redzone always starts at the next page boundary, and a trailer follows immediately after the bytes that are beyond the requested size. (A redzone page is a page that will cause an invalid page fault if it is referenced. This is a technique used to detect overflow from any area and is often used to protect stacks. xmalloc constructs redzone pages immediately following selected heap memory regions that it allocates.) Trailers are checked at free time for consistency. The error disposition can be affected for these checks just as it is for the small_trailer option. Trailers and redzones can be used together to ensure over-runs are detected. Trailers are not used if the requested size is exactly a multiple of the page size. Overwrites can still be detected using the redzone option.

This option is new in AIX V6.1. In AIX V5.3, all trailers are controlled with a single tuning parameter (alloc_trailer).

Check for overwrites in all allocations

```
# errctrl -c alloc.xmdbg alloc_trailer=<frequency>
```

This option is provided for compatibility. It sets the frequency that xmalloc will add a trailer to all allocations. To accomplish this, it overwrites the settings of both the small_trailer and large_trailer options.

Promote fragment allocations to whole pages

```
# errctrl -c alloc.xmdbg promote=<size>,<frequency>
```

This option sets the frequency for which allocations are promoted. When an allocation that is less than 1/2 of a 4 KB page is promoted, the returned pointer is as close to the end of the page as possible while satisfying alignment restrictions and an extra redzone page is constructed after the allocated region. No other fragments are allocated from this page. This provides isolation for the returned memory and catches users that over-run buffers. When used in conjunction with the df_promote option, this also helps catch references to freed memory. This option uses substantially more memory than other options. Sizes that are greater than 2 KB are still promoted in the sense that an extra redzone page is constructed for them.

The page size of the heap passed to `xmalloc` makes no difference. If the heap normally contains 64 KB pages (kernel_heap or pinned_heap on a machine that supports a 64 KB kernel heap page size), the returned memory of a promoted allocation will still be backed by 4 KB pages. These promoted allocations come from a region that has a 4 KB page size, to avoid using an entire 64 KB page as a redzone.

The supported sizes are all powers of two: 16, 32, 64, 128, 256, 512, 1024, 2048, 4096, 8192, 16384, and 32768. All the commands accept hexadecimal numbers (0x10, 0x20, 0x40,...,0x8000) and decimal numbers as input.

In AIX V5.3, this feature does not provide a redzone page, and always causes the freeing of the fragment to be deferred. See the discussion of deferred free option below. The following command needs to be use in AIX V5.3 to provide a redzone page:

```
errctrl -c alloc.xmdbg doublepage_promote=<size>,<frequency>
```

In AIX V6.1, this option is still available but the function is identical to the promote option. AIX V 6.1, offers another tuning parameter to control the deferral of promoted fragments in contrast to the deferral of other types of allocations. See the next paragraph for more details.

Change the promotion settings of all sizes at once

```
# errctrl -c alloc.xmdbg promote_all=<frequency>
```

This option duplicates the function of the promote option, but does not take size as an argument. It applies the input frequency to all the promotion sizes with a single command. This option is new in AIX V6.1

Defer the freeing of pages / promoted allocations

```
# errctrl -c alloc.xmdbg df_promote=<frequency>
```

The deferred free technique means that when a memory object is freed, `xmalloc` will take measures to ensure that the object is not re-allocated immediately. This technique helps catch references to memory that has been freed. This option affects the freeing of promoted fragments. It sets the frequency with which the freeing of promoted fragment is deferred. Page promotion (for example the promote option) and `df_promote` are designed to be used together.

This tuning parameter is new in AIX V6.1. The re-allocation of promoted allocations is always deferred in AIX V5.3.

Defer the freeing of pages / small allocations

```
# errctrl -c alloc.xmdbg def_free_frag=<frequency>
```

This option sets the frequency at which non-promoted fragments will be deferred. The difference between this option and the `df_promote` options must be clarified. A memory page that `xmalloc` manages contains multiple fragments of the same size or is part of a range of pages. When the `def_free_frag` option is in use, the free of every fragment on a page will be deferred together. This implies the number of pages used by these two techniques is substantially different. The `df_promote` option constructs one fragment per page (with an additional redzone page), and the `def_free_frag` option constructs multiple fragments per page with no redzone. This tuning parameter is new in AIX V6.1.

Defer the freeing of pages / large allocations

```
# errctrl -c alloc.xmdbg deferred_free=<frequency>
```

This option also helps catch references to memory that has been freed. It sets the frequency at which `xmalloc` defers the freeing of larger allocations. Larger allocations are at least one entire 4K page in size. This option should be used with care because it can be expensive from a performance standpoint. When large ranges are freed and deferred, all the pages in the range are disclaimed. Presuming there is no error, all the memory will be faulted and zero filled the next time it is referenced. Read references to freed memory are medium severity errors, while write references always cause a system to crash. If the disposition of medium severity errors is set to cause a system crash, the system will crash on a read reference.

This tuning parameter exists in AIX V5.3, but it affects all allocations.

Redzones for large allocations

```
# errctrl -c alloc.xmdbg redzone=<frequency>
```

This option sets the frequency of redzone page construction. This option is specific for allocations of a page or more. With default error disposition in effect, read references to redzone pages will cause an error log event, and write references will cause a system crash. As in other cases, the user can change the error disposition of medium severity errors to cause a system crash on a bad read reference.

VMM page state checks

```
# errctrl -c alloc.xmdbg vmmcheck=<frequency>
```

This option sets the frequency that `xmfree` will check page protection settings, storage key bits, and pin counts for memory being freed back to a heap. Some errors in this area are not fatal. For example, a page that has a higher than expected pin count at free time will waste pinned storage, but there are usually no fatal consequences of that. When a page is returned that has a lower than

expected pin count, or has the wrong page protection settings, or has the wrong hardware storage key associated with it, the system will crash.

Tuning parameters not affected by RTEC level

The following tuning parameters are not affected by the error checking level configuration: memleak_pct, memleak_count, minsize, reset_errlog_count, deferred_count.

Set memory leak percentage

```
# errctrl -c alloc.xmdbg memleak_pct=<percentage>
```

This option sets the percentage of heap memory that can be consumed before an error is logged. This is specific to the heaps controlled by the component. Heaps that are controlled by other components are not affected. For example alloc.heap0 is a separate component that controls the heap used by the loader, and it uses a different percentage than the kernel_heap, which is controlled by alloc.xmdbg. Component level heaps created by the heap_create kernel service can be registered separately and can be given different percentages.

As an example,

```
# errctrl -c alloc.xmdbg memleak_pct=50
```

will cause an error to be logged if 50% of a system heap is consumed. This command requires the user to make a judgment about how much storage should be consumed before a leak should be suspected. Users who do not have that information should not use the command. The current values that reflect the percentage can be viewed with the `xm -Q` command. The output appears near the bottom:

```
KDB(0)> xm -Q
XMDBG data structure @ 0000000002523050
```

... omitted lines ...

Ratio of memory to declare a memory leak: 0x400(1024)/0x400(1024)

```
Outstanding memory allocations to declare a memory leak: -1
Deferred page reclamation count (-1 == when necessary): 16384
Minimum allocation size to force a record for: 1048576
```

Note the default percentage is 100% (1024/1024). Memory leak errors are classified as a low severity errors and the default disposition is to ignore them. The error disposition for low severity errors can be modified to log an error or to cause a system crash.

Set memory leak count

```
# errctrl -c alloc.xmdbg memleak_count=<num>
```

This option sets an outstanding allocation limit for all the fragment sizes. This is meant as an aid in catching memory leaks that are very slow growing. If the total number of outstanding allocations of any fragment size grows beyond this limit, an error is logged. For example, an error occurs if the limit is set to 20,000, and 20,001 allocations are outstanding for any of the fragment sizes. This error is classified as a low severity error and the default disposition for the error is to ignore it. The error disposition for low severity errors can be modified to log an error or to cause a system crash. The default value of this setting is -1 meaning no check is made. This limit must be set to a positive value by the operator to cause the check to be made.

The `xm -Q` command shows the current setting of this value near the bottom of the output:

```
KDB(0)> xm -Q
XMDBG data structure @ 0000000002523050
```

... omitted lines ...

```
Ratio of memory to declare a memory leak: 0x400(1024)/0x400(1024)
Outstanding memory allocations to declare a memory leak: -1
Deferred page reclamation count (-1 == when necessary): 16384
Minimum allocation size to force a record for: 1048576
```

In AIX V5.3, this option counts the total number of outstanding allocations. In AIX V6.1, a separate count of allocations of each different size has been implemented and AIX V6.1 `xmalloc` RTEC reports if any of them is growing beyond the provided limit. This enhancement avoids bookkeeping on each allocation and consequently improves performance.

Set large allocation record keeping

```
# errctrl -c alloc.xmdbg minsize=<num>
```

This sets the size of an allocation that we will always record. Very large allocations are frequently never freed, so this setting allows the operator to record all outstanding allocations that are greater than or equal to `minsize` bytes. The default value of this tuning parameter is 0x1000000 bytes. The `xm -Q` command shows the current setting near the bottom of the output:

```
KDB(0)> xm -Q
XMDBG data structure @ 0000000002523050
```

... omitted lines ...

```
Ratio of memory to declare a memory leak: 0x400(1024)/0x400(1024)
Outstanding memory allocations to declare a memory leak: -1
Deferred page reclamation count (-1 == when necessary): 16384
Minimum allocation size to force a record for: 1048576
```

Reset error log handling

```
# errctrl -c alloc.xmdbg reset_errlog_count
```

To avoid the error log from being flooded, each subcomponent of the alloc component will only record up to two hundred errors in the error log before reaching a threshold. This threshold can be reset with this option. If the two hundred log limit is reached and the count is not reset, error logging by the component will not resume until after a partition reboot.

In the previous AIX release, a separate count is kept for many different errors, and only one error of each type is logged.

Set the deferral count

```
# errctrl -c alloc.xmdbg deferred_count=<num>
```

The deferred count is the total number of pages that are deferred before xmalloc recycles deferred storage back to a heap. Its obvious that the freeing of storage cannot be deferred indefinitely, but it might not be obvious that the consequence of deferring too long is that heaps can become fragmented, which could result in allocation failures for large requests. xmalloc supports setting this option to -1 which causes xmalloc to defer re-allocation as long as possible. This means the heap is exhausted before memory is recycled. In AIX V6.1, the default value is 0x4000 deferrals. (In AIX V5.3, the default is 0x100 deferrals.) In general, this value should only be changed with component owner guidance. The `xm -Q` command shows the current setting of this tuning parameter near the bottom of the output:

```
KDB(0)> xm -Q
XMDBG data structure @ 000000002523050
```

```
... omitted lines ...
```

```
Ratio of memory to declare a memory leak: 0x400(1024)/0x400(1024)
```

```
Outstanding memory allocations to declare a memory leak: -1
```

```
Deferred page reclamation count (-1 == when necessary): 16384
```

```
Minimum allocation size to force a record for: 1048576
```

The `errctrl` command can be used to display the alloc portion of the RAS component hierarchy and each sub-components RTEC attributes. The `errctrl` command also allows to modify the run-time error checking related configuration parameters. The following `errctrl` command output shows that the default error checking level for all system memory allocator components is normal (level=3), that low-severity errors are ignored (LowSevDis=48). For the alloc.heap0 component medium-severity errors are logged (collect service data and continue) (MedSevDisp=64). In case of the alloc.xmdbg component a medium-severity error initiates a live dump (MedSevDisp=80):

```
hhaix6:root:/root # errctrl -c alloc -q -r
```

Component name	Have alias	ErrChk /level	LowSev Disp	MedSev Disp
alloc				
.heap0	NO	ON /3	48	64
.xmdbg	NO	ON /3	64	80

The kernel debugger can be used from the command line to examine the values of all the frequency settings as follows:

```
# echo xm -Q | kdb
```

4.3 Dump Facilities

With AIX, *Traditional* dump, named *Legacy* dump is taken when a crash occurs before a system logical partition or full system partition is reinitialized. A dump is a picture of partition memory and processor state. It is initiated by a user request or by AIX when a severe error is detected and the operating system must be halted.

Note: A user-initiated dump is different from a dump initiated by an unexpected system halt because the user can designate which dump device to use. When the system halt unexpectedly, a system dump is initiated only to the primary dump device.

As many systems have a large amount of memory, time to dump has increased significantly and has a significant impact on the system outage time. Several technologies have been introduced recently within AIX to address this issue:

► **Minidump facility**, starting with AIX V5.3 TL03

The minidump is a small compressed dump that is stored to NVRAM when the system crashes or a dump is initiated, and then written to the error log on reboot. It can be used to see some of the system state and do some debug in the case that a full dump is not available. It can also be used to get a quick snapshot of a crash without having to transfer the entire dump from the crashed system.

► **Parallel dump**, starting with AIX V5.3 TL05

A new optimized compressed dump format is introduced in AIX V5.3 TL05. The dump file extension for this new format is still .BZ. Parallel dumps are produced automatically when supported by the AIX release. In this new compressed dump file, the blocks are compressed and unordered: this

unordering feature allows multiple processors to dump in parallel sub-areas of the system. Thus, when a system dump happens on a multiprocessor system, the time to produce the dump image is now I/O bound limited and so greatly reduced.

This new file format for parallel dump is no more readable with usual **uncompress** and **zcat** commands: the new **dmpuncompress** command must be used. In order to increase dump reliability, a new -S checking option, to be used with the -L option for the statistical information about the most recent dump is also added to **sysdumpdev** command. The -S option scans a specific dump device and see if it contains a valid compressed dump.

► **Component Dump** facility, starting with AIX V6

The enterprise Reliability Availability Serviceability strategy is to maintain the *continuous availability* of System p servers through extended key error detection and recovery capabilities implementing mainframe-like features for the hardware, AIX operating system, and also for external third party software. In order to provide a granular approach to RAS, enterprise RAS defines a component framework where AIX and third party software can register components that enable their specific RAS features such as trace, dump and error checking features.

The Component Trace facility (CT), like the Run-Time Error checking (RTE) facility have been implemented for the AIX Operating system components with AIX V5.3 TL05. For additional informations on these facilities, see *AIX 5L Differences Guide: Version 5.3 Addendum*, SG24-7414.

The Component Dump facility (CD) for the AIX operating system components is now introduced with AIX Version 6.

► **Live Dump** Facility, starting with AIX V6:

Live dumps are small dumps that do not require a system restart. The Live Dump facility uses the Component Dump implementation to dump only AIX components, registered as a live dump enabled component, named a Live dump aware component. Software or system administrators can initiate Live Dumps while the system is running: planned downtime is no longer necessary to dump a system. Moreover, because selective dump aware components can be chosen, Live dump facility reduce significantly the time to dump and the size requirement for dump files.

► **Firmware-Assisted Dump** Facility, starting with AIX V6:

The firmware-assisted dump means that AIX dump is taken while the partition is restarting. This increases reliability of a partition system dump by minimizing the work done by the failing operating system and let it done by the new restarting instance. The firmware is involved to preserve memory area across the reboot

4.3.1 The dumpctrl command

The **dumpctrl** command is a new integrated interface to manage the various dump formats.

With AIX Version 6, the implementation of the AIX dump components provides an enhanced dump granularity and allows to dump these components without requiring any reboot. Thus, this new dump capability, based on these components, is called *live dump*. Before AIX Version 6, the only supported type of dump was the *system dump* that requires a reboot afterwards.

As shown in Figure 4-2 on page 143, to manage the attributes of these two different types of dumps, AIX provides a unified user-interface the **dumpctrl** command to manage both:

- ▶ The *traditional dump* also named *system dump* that requires a reboot,
- ▶ The *live dump*, based on the new dump components, is implemented with the component infrastructure that allows to take a dump while the server is running.

Important: Only root user can use the **dumpctrl** command.

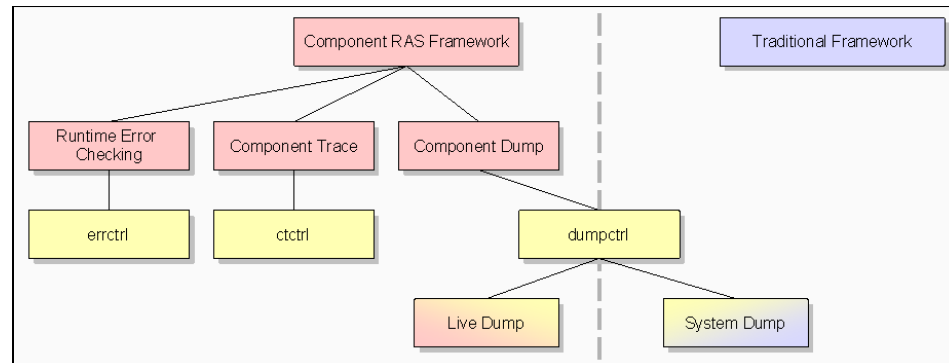

Figure 4-2 Two dump frameworks, a unified user-interface: **dumpctrl**

Regarding the SMIT panels, each type of dump keeps its own SMIT menu as shown by the SMIT Problem Determination panel shown in Figure 4-3.

- ▶ To call directly the SMIT system dump panel, use: **smitty dump**
- ▶ To call directly the SMIT live dump panel, use: **smitty ldmp**

```

Problem Determination

Move cursor to desired item and press Enter.

Electronic Service Agent
Error Log
Trace
System Dump
Alog
Change/Show/Reset Core File Copying Directory
Hardware Diagnostics
Verify Software Installation and Requisites
Advanced First Failure Data Capture Features
Kernel Recovery
Component / Live Dump
ProbeVue
Storage Protection Keys

F1=Help          F2=Refresh      F3=Cancel      F8=Image
F9=Shell        F10=Exit       Enter=Do

```

Figure 4-3 Problem Determination SMIT panel

The following sections describe the main capabilities of **dumpctr1** command:

- ▶ To show Dump Components,
- ▶ To control live dump attributes,
- ▶ To control system dump attributes with also the description a new system dump type, based on POWER6™ firmware, named firmware-assisted dump.

4.3.2 Component Dump Facility

With AIX Version 6, AIX dump components are available. They have been registered through the RAS Component framework. The following example shows how to register a dump component:

```

/*
 * This sample creates a component, makes it dump-aware, and handles both live
 * and system dump.
 */
...lines missing for clarity
#include <sys/ras.h>
#include <sys/livedump.h>
#include <sys/kerrnodefs.h>
#include <sys/eyec.h>
#include <sys/raschk.h>
...lines missing for clarity

```



```

/* Component name and handle */
const char Compname[] = "sample_comp";
ras_block_t Rascb=NULL;
...lines missing for clarity
{
    kerrno_t rv = 0;
    int rc;

    /* Unloading */
    if (Rascb) ras_unregister(Rascb);
...lines missing for clarity
    /* Register the component as dump aware */
    rv = ras_register(&Rascb,
        (char*)Compname,
        (ras_block_t)0,
        RAS_TYPE_OTHER,
        "sample component",
        RASF_DUMP_AWARE,
        sample_callback,
        NULL);
    if (rv) return(KERROR2ERRNO(rv));
...lines missing for clarity
    /* Make the component system and live dump aware. */
    rv = ras_control(Rascb, RASCD_SET_SDMP_ON, 0, 0);
    if (rv) return(KERROR2ERRNO(rv));
    rv = ras_control(Rascb, RASCD_SET_LDMP_ON, 0, 0);
    if (rv) return(KERROR2ERRNO(rv));
...lines missing for clarity
    rv = ras_customize(Rascb);
    if (rv) return(KERROR2ERRNO(rv));
...lines missing for clarity

```

Note: The flag **RASF_DUMP_AWARE** indicates what type of RAS systems this component is aware of. With **RASF_DUMP_AWARE**, this component is a dump aware component.

The **RASF_SET_SDMP_ON** command makes this component system dump aware.

The **RASF_SET_LDMP_ON** command makes this component live aware.

The new **dumpctrl** command modifies or displays the dump attributes of system components.

The following example shows the dump properties of the jfs2 component.

```
# dumpctrl -qc -c jfs2
```

```
-----+-----+-----+-----
| Have | Live Dump | System Dump
```

Component Name	Alias	/level	/level
jfs2	NO	ON/3	OFF/3

Note: The `dumpctr1 -qc` command lists all the dump component hierarchy.

Since the `dumpctr1` command is a unified interface for both live dump and system dump, it displays concurrently both the two dump aware capabilities of the component.

► **component** type for *Live Dump* Level

Refers to a component specified with the RAS infrastructure (one created with the `ras_register()` kernel service call).

► **legacy component** type for *System Dump* Level

Refers to a dump component specified with either the `dmp_add()` or the `dmp_ctl()` kernel services which refers to the traditional AIX system dump.

For example, the `lvm` component is supported by both frameworks. This means that two dump components for `lvm` are implemented for each dump framework.

`dumpctr1 -qc`

Component Name	Have Alias	Live Dump /level	System Dump /level
...lines missing for clarity			
lvm	NO	ON/3	ON/3
.rootvg	NO	ON/3	ON/3
.metadata	NO	ON/3	ON/3
.lvs	NO	ON/3	ON/3
.fslv00	NO	ON/3	ON/3
.fslv01	NO	ON/3	ON/3
.fslv02	NO	ON/3	ON/3
.fslv03	NO	ON/3	ON/3
.fslv04	NO	ON/3	ON/3
.fslv05	NO	ON/3	ON/3
...lines missing for clarity			

The `dumpctr1` command is able to list live dumps with the specified components:

`dumpctr1 -h`

...lines missing for clarity

-s : List live dumps in the dump repository.

...lines missing for clarity

Selector: either "-c all" or one or more of

-c list : comma- or space-separated list of component names,

-l list : comma- or space-separated list of component aliases,

```
-t list : comma- or space-separated list of type or type_subtype names
-C name : failing component name (only valid with -s)
-L name : failing component alias (only valid with -s)
-T name : failing component type_subtype name (only valid with -s)
```

This is an output of the -s option when no live dump exists is shown in the following:

```
# dumpctrl -s
```

```
The live dump repository located at:
```

```
/var/adm/ras/livedump
```

```
contains no live dumps that match the specified parameters (if any).
```

SMIT panels (Figure 4-4 on page 147 and Figure 4-5 on page 148) are also available to modify the dump component attributes under the main menu: **smitty** **ldmp**.

```

                                Component / Live Dump
Move cursor to desired item and press Enter.

Start a Live Dump
List Components that are Dump Aware
List Live Dumps in the Live Dump Repository
Change/Show Global Live Dump Attributes
Change/Show Dump Attributes for a Component
Change Dump Attributes for multiple Components
Refresh the Kernel's List of Live Dumps
Display Persistent Customizations

F1=Help          F2=Refresh      F3=Cancel      F8=Image
F9=Shell        F10=Exit       Enter=Do

```

Figure 4-4 SMIT Panel to request change/show the dump component attributes

Change/Show Dump Attributes for a Component			
Type or select values in entry fields. Press Enter AFTER making all desired changes.			
		[Entry Fields]	
Component Path Name or Alias Specified	[all]		
Enable Live Dumps	[yes]		+
Live Dump Detail Level	[3]		#
Enable System Dumps	[yes]		+
System Dump Detail Level	[3]		#
Changes apply	[now]		+
F1=Help	F2=Refresh	F3=Cancel	F4=List
F5=Reset	F6=Command	F7=Edit	F8=Image
F9=Shell	F10=Exit	Enter=Do	

Figure 4-5 SMIT Panel to change/display Dump attribute for a component

4.3.3 Live Dump Facility

The Live Dump Facility uses the Component Dump framework to dump only AIX components, registered as a live dump aware component.

Software or system administrators can initiate live dumps while the system is running: planned downtime is no longer necessary to dump a system.

- ▶ Software programs can use live dumps as part of recovery actions.
- ▶ A system administrator can initiate live dumps when a subsystem does not respond or behaves erroneously.

The live dump is intended to provide dump capability to the kernel and extensions when the system is still functional.

Important: Live dump should not be used if the system is not entirely functional. If no tasks can be dispatched or the system cannot perform I/O, then the system dump should be used instead. Live dump should not be used as the dump choice when a complete system failure is determined.

Live dump file space

Because selective live dump aware components can be chosen, the live dump facility significantly reduces the time required to dump and the size requirement for the dump files.

By default, live dumps are written to the `/var/adm/ras/livedump` directory. The live dump directory can be changed by using the `dumpctr1` command.

Note: Unlike system dumps that are written to a dedicated dump device, live dumps are written to the file system. A best practice is to maintain the live dump directory on rootvg, and ensure enough space.

The contents of the livedump repository can be shown using the `dumpctr1 -s` command or selecting **List Live Dumps in the Live Dump Repository** from the Component/Live Dump SMIT menu. (Figure 4-6).

```

Component / Live Dump
Move cursor to desired item and press Enter.

Start a Live Dump
List Components that are Dump Aware
List Live Dumps in the Live Dump Repository
Change/Show Global Live Dump Attributes
Change/Show Dump Attributes for a Component
Change Dump Attributes for multiple Components
Refresh the Kernel's List of Live Dumps
Display Persistent Customizations

F1=Help      F2=Refresh   F3=Cancel    F8=Image
F9=Shell     F10=Exit    Enter=Do

```

Figure 4-6 SMIT Live dump panel: `smitty ldmp`

Live dump file size

To control the size of a live dump, each dump component is required to limit the size of its dump data. This is controlled by the dump detail level, a value between 0 to 9, that can be changed by using the `dumpctr1` command.

There are three main live dump levels `ldmpminimal`, `ldmpnormal`, and `ldmpdetail`, corresponding to levels 1, 3, and 7. This limits the size of data dump for each dump component. Therefore, the live dump file size depends on the number of selected dump components.

Table 4-3 shows the recommended and upper limit values for component dump data given the dump detail level.

Table 4-3 *Dump detail level and component dump data size limit*

Level	Suggested maximum	Enforced maximum
less than <code>ldmpnormal</code> (0, 1, 2)	1 MB	2 MB
less than <code>ldmpdetail</code> (3, 4, 5, 6)	2 MB	4 MB
less than 9 (7, 8)	4 MB	8 MB
9	no limit	no limit

If the system is unable to write the current dump due to an I/O error, an error is logged. If the dump is designated as a one-pass dump, it is kept in memory until it can be saved using the `dumpctr1 -k` command. This command is run automatically every five minutes.

Serialized live dump

There are two ways to take a live dump:

- ▶ A serialized live dump:
It is a live dump where all processors are stopped while dumping.
- ▶ An unserialized live dump:
It is a live dump where processors are operating.

Important: In AIX Version 6.1, live dumps are only serialized live dumps.

A serialized live dump causes a system to be frozen or suspended, when data is being dumped. The freeze is done by stopping all processors, except the one running the dump. Such a freeze should not exceed one tenth of a second.

This value can be modified by the `dumpctr1` command. It is recommended to use the default value. If the freeze period exceeds 5 seconds, the system is unfrozen, and only dump data gathered so far is written.

When the system is frozen, the data is copied into a pre-allocated pinned memory. This dedicated pinned memory is called live dump heap.

The data is written to the file system only after the system is unfrozen.

Live dump heap size

The default live dump heap size is the minimum of 64 MB and 1/64th the size of physical memory. It will not be less than 4 MB.

The maximum heap size is also limited to 1/16th the size of real memory.

Table 4-4 provides live dump heap size limits for several size of real memory sizes:

Table 4-4 *Live dump heap size limits*

Size of real memory	Default heap size	Min. heap size	Max. heap size
128 MB	4 MB	4 MB	8 MB
256 MB	4 MB	4 MB	16 MB
1 GB	16 MB	4 MB	64 MB
4 GB	64 MB	4 MB	256 MB
16 GB	64 MB	4 MB	1 GB

The heap size can be changed dynamically using the `dumpctrl` command or by way of dynamic reconfiguration, adding or removing real memory.

Managing the live dump heap content

Duplicate live dumps that occur rapidly are eliminated to prevent system overload and to save file system space. Eliminating duplicate dumps requires periodic, once every 5 minutes by default, scans of the live dump repository. This is done by calling `/usr/sbin/dumpctrl -k` using an entry in the root user's crontab. This period can only be changed by editing the crontab.

To eliminate duplicate dumps, The `dumpctrl -k` command uses the following policies that can be changed by the `dumpctrl` command:

pre-capture policy Pre-capture elimination is designed to prevent duplicate live dumps. It uses an age limit. When checking for duplicates, only dumps not older than a day (86400 seconds) will be considered.

post-capture policy Post-capture elimination is used to remove low priority live dumps when a higher priority dump must be written, and the file system free space is low.

A live dump has a priority of either *info* or *critical*, for informational or critical dumps. The default is *critical*. If, while writing a critical dump, the system runs out of space, post-capture elimination removes live dumps with *info* priority, starting with the oldest one, until the critical dump can be written.

all policy Pre-capture elimination and Post-capture elimination are both in effect.

none policy No live dump elimination is performed.

There is a free space percentage associated with the live dump repository. When the free space falls below this percentage, the system logs an error message to the error log. As shown in Figure 4-7, the free space is 22% while the desired limit is at 25%, the default value. The system administrator should increase the file system size or delete the live dumps no longer desired. The contents of the live dump directory can be displayed with the **dumpctr1 -s** command.

```
-----
LABEL:          DMPCHK_LDMPPSFULL
IDENTIFIER:     4BE53A52

Date/Time:      Tue Oct 16 15:00:01 GMT+02:00 2007
Sequence Number: 145
Machine Id:     00C1F1704C00
Node Id:        lpar01
Class:          0
Type:           PEND
WPAR:          Global
Resource Name:  dumpcheck

Description
Livedump filesystem almost full

                Recommended Actions
                Expand filesystem or delete dumps that are not needed

Detail Data
percent free      22
desired percent free 25
FILE SYSTEM MOUNT POINT
e
e
e
```

Figure 4-7 The *freespc* parameter and error log

Live Dump attributes

With the **dumpctr1** command, all the described live dump attributes can be set with the form:

dumpctr1 attribute1=value1 attribute2=value2

To display live dump attributes, use the **-ql** option of the **dumpctr1** command:

dumpctr1 -ql

The following example shows how to display and modify live dump attributes controlling the live dump directory and the live dump detail level. Note that the live dump directory is also known as the live dump repository.

```
# dumpctr1 -q1
Live Dump Enabled:                yes
Live Dump Directory:              /var/adm/ras/livedump
Live Dump Free Space Threshold:   25%
Live Dump Global Level:          3
Live Dump Heap Size:              0 MB (0 indicates default heap size)
Live Dump Duplicate Suppression Type: all
Live Dump Max System Freeze Interval:100ms
# dumpctr1 ldmpdetail dir=/tmp
# dumpctr1 -q1
Live Dump Enabled:                yes
Live Dump Directory:              /tmp
Live Dump Free Space Threshold:   25%
Live Dump Global Level:          7
```

The live dump attributes can be also modify with the SMIT panel shown in Figure 4-8 under main menu: **smitty ldmp**

Change/Show Global Live Dump Attributes			
Type or select values in entry fields. Press Enter AFTER making all desired changes.			
Enable Live Dumps	[yes]	[Entry Fields]	+
Live Dump Repository's Directory	[/tmp]		
Live Dump Free Space Threshold %	[25]		#
Live Dump Detail Level	[9]		#
Live Dump Heap Size <in MB>	[0]		#
Live Dump Duplicate Suppression Type	[all]		+
Suggested Live Dump Freeze Interval <in ms>	[100]		#
Restore Original Live Dump Settings	[no]		+
Changes persist across a reboot Applies to global status and detail level only.	[no]		+
F1=Help	F2=Refresh	F3=Cancel	F4=List
F5=Reset	F6=Command	F7=Edit	F8=Image
F9=Shell	F10=Exit	Enter=Do	

Figure 4-8 SMIT Panel to change live dump attributes

Table 4-5 on page 154 provides all the live dump options that can be set by the **dumpctr1** command.

Table 4-5 Live dump attributes and defaults

Attribute	Specification	Default value
dir	Specifies a live dump directory name.	/var/adm/ras/livedump
freespc	Specifies live dump free space threshold using a decimal value from 0 to 99.	25 (means 25%)
ldmpenable	Specifies whether live dump is enabled. The possible values are yes and no: ldmpen attribute can be used instead of ldmpenable=yes, and ldmpoff attribute instead of ldmpenable=no.	yes
ldmplevel	Specifies the live dump level using a decimal value from 0 to 9: ldmpminimal, ldmpnormal, or ldmpdetail attribute can be used instead of ldmplevel=1, 3, 7.	3 (normal)
heapsz	Specifies live dump heap size using a decimal value in megabytes. A value of 0 indicates that the formula for the heap size mentioned previously is to be used.	0
duptype	Specifies duplicate dump suppression type. The following are the possible values: all, pre, post, and none.	all
maxfreeze	Specifies the maximum recommended system freeze interval using a decimal number in milliseconds.	100 ms

The persistence of an attribute refers to how attributes are applied. They may be applied immediately, to new components only, and remain in effect across a reboot. Table 4-6 provides the persistence of live dump attributes.

Table 4-6 Live dump attributes and persistence

Attribute	Specification	Persistence
ldmpenable	Live dump enabled	The bosboot command is required using the -P flag
dir	Live dump directory	Takes effect immediately and upon system reboot
freespc	Live dump free space threshold	Takes effect immediately and upon system reboot
ldmplevel	Live dump level	The bosboot command is required using the -P flag

Attribute	Specification	Persistence
heapsz	Live dump heap size	Takes effect immediately and upon system reboot
duptype	Duplicate dump suppression type	Takes effect immediately and upon system reboot
maxfreeze	Maximum recommended system freeze interval	Takes effect immediately and upon system reboot

Some of the error log and dump commands are delivered in the bos.sysmgt.serv_aid package.

Live dump commands included in bos.sysmgt.serv_aid include the **livedumpstart** command.

A live dump may also be initiated from the AIX kernel or from a kernel extension.

For additional information, see “Live Dump Facility” in the “Kernel Extensions and Device Support Programming Concepts” publication:

<http://publib.boulder.ibm.com/infocenter/pseries/v5r3/topic/com.ibm.aix.kernext/doc/kernextc/kernextc.pdf>

4.3.4 System dump facility

A system generates a system dump when a severe error occurs. System dumps can also be user-initiated by system administrators. A system dump creates a picture of the system’s memory contents. System administrators and programmers can generate a dump and analyze its contents when debugging new kernel extensions. Note that the live dump is also a good tool for debugging new code.

The system dump facility is based on the existing dump framework but has evolved in AIX Version 6 to use the dump granularity provided by the Dump Components.

Some of the Dump Components can be system-aware (for more details, see 4.3.2, “Component Dump Facility” on page 144), allowing granular control of the amount of data that is dumped in a system dump. Components that are system-dump aware can be excluded from a system dump to reduce the dump size. To see or modify which dump components are system dump aware or selected for a system, the **dumpctrl** command or SMIT panels can be used (see SMIT panels in Figure 4-4 on page 147 and Figure 4-5 on page 148).

The system dump is intended to provide dump capability to the kernel and extensions when a severe error occurs, and the kernel has to halt the system.

When a system dump occurs, the partition or server is stopped with an 888 number flashing in the operator panel display, indicating the system has generated a dump and saved it to a dump device. This is only for the traditional system dump. The firmware-assisted system dump, new in Version 6.1, is saved while the operating system is re-booting.

System Dump attributes

With the **dumpctrl** command, all the described system dump attributes can be set with the form:

```
dumpctrl attribute1=value1 attribute2=value2
```

To display system dump attributes, use the **-qs** option of the **dumpctrl** command:

```
dumpctrl -qs
```

The following example shows how to display and modify system dump attributes concerning the copy directory and the level of detail:

```
# dumpctrl -qs
Dump Legacy Components:          yes
System Dump Global Level:        3
System Dump Copy Directory:      /var/adm/ras
Display Boot Time Menu on Dump Failure: yes
Allow Dump on Keyboard Sequence: no
Primary Dump Device:             /dev/hd6
Secondary Dump Device:           /dev/sysdumpnull
# dumpctrl sdmpdetail
# dumpctrl -qs
System Dump Global Level: 7
```

The system dump attributes can be also modified with the SMIT panel shown in Figure 4-10 on page 160 under main menu: **smitty dump**

The Table 4-7 provides all the system dump options that can be set by **dumpctrl** command.

Table 4-7 System dump attributes and defaults

Attribute	Specification	Default value
sdmpenable	Specifies whether system dump is enabled. The possible values are yes and no: sdmpon can be used instead of sdmpenable=yes and sdmpoff instead of sdmpenable=no.	yes

Attribute	Specification	Default value
legacyenable	Specifies whether legacy dump components are enabled. The possible values are yes and no: legacyon can be used instead of legacyenable=yes and legacyoff instead of legacyenable=no.	yes
sdmplevel	Specifies the system dump level using a decimal value from 0 to 9. You can specify the sdmpminimal, sdmpnormal, or sdmpdetail attribute instead of sdmplevel=1, 3, 7	3 (normal)
copydir	Specifies a copy directory path name	/var/adm/ras
forcecopy	Specifies whether the forcecopy attribute is enabled. The possible values are yes and no.	yes
keyseq	Specifies whether the key sequences at operator panel always cause a dump. The possible values are yes and no.	no
primary	Specifies the primary dump device path name.	/dev/hd6 or /dev/lg_dumplv
secondary	Specifies the secondary dump device path name.	/dev/sysdumpnull

The persistence of an attribute refers to how attributes are applied. They may be applied immediately, to new components only, and remain in effect across a reboot. Table 4-8 provides the persistence of system dump attributes.

Table 4-8 System dump attributes and persistence

Attribute	Specification	Persistence
sdmpenable	System dump enabled	The bosboot command is required using the -P flag
legacyenable	Dump legacy components	Takes effect immediately and upon system reboot. No bosboot required with -P flag
sdmplevel	System dump level	The bosboot command is required using the -P flag
copydir	A copy directory path name	Takes effect immediately and upon system reboot

Attribute	Specification	Persistence
forcecopy	brings up the boot time menu if cannot copy	Takes effect immediately and upon system reboot
keyseq	Key sequences always cause a dump	Takes effect immediately and upon system reboot
primary	The primary dump device	Takes effect immediately and upon system reboot. No bosboot required with -P flag
secondary	The secondary dump device	Takes effect immediately and upon system reboot. No bosboot required with -P flag

Some of the error log and dump commands are delivered in the bos.sysmgt.serv_aid package. System dump commands included in the bos.sysmgt.serv_aid include the **sysdumpstart** command.

Firmware-assisted Dump

With the introduction of the POWER6 processor based systems, system dumps can be assisted by firmware. Different from traditional system dumps that are generated before a system partition is reinitialized, firmware-assisted system dumps take place when the partition is restarting.

In order to improve fault tolerance and performance, disk writing operations are done as much as possible during the AIX Boot phase in parallel with the AIX initialization.

Figure 4-9 on page 159 provides all dump capabilities and shows that the firmware-assisted dump is a new type of system dump compared to the traditional one: parallel dump since AIX V5.3 TL05 or the classic one for previous AIX versions.

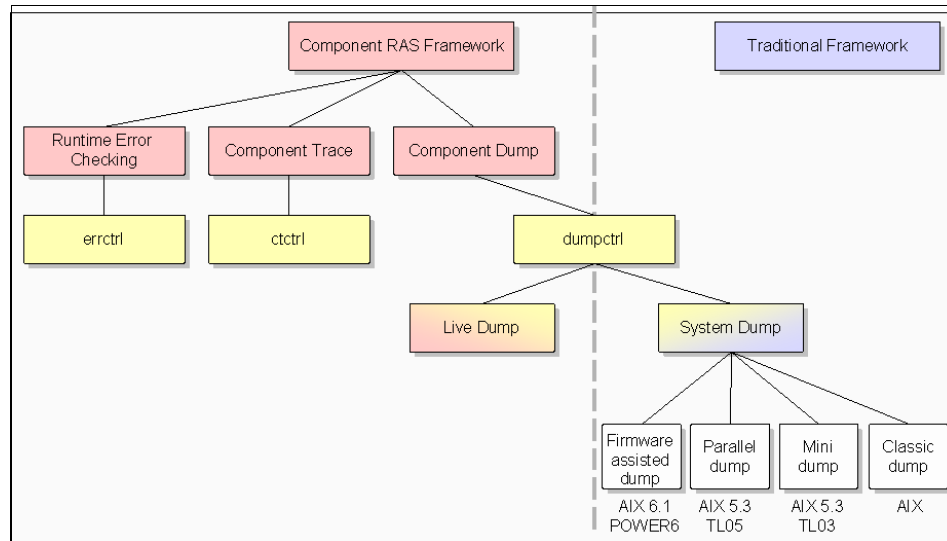

Figure 4-9 Overview of all dump capabilities

To select the type of system dump, a new entry Change the Type of Dump, as shown in Figure 4-10 on page 160, is added to the SMIT main panel for dump: **smitty dump**.

The SMIT Panel shown in Figure 4-11 on page 160 allows the administrator to choose between a traditional or a firmware-assisted dump. This choice can also be done on the command line with the new **sysdumpdev** option **-t**:

- ▶ To select a traditional system dump:
sysdumpdev -t 'traditional'
- ▶ To select a fw-assisted system dump:
sysdumpdev -t 'fw-assisted'

Important: AIX Version 6.1 generates a traditional system dump by default.

```

                                System Dump
Move cursor to desired item and press Enter.

Show Current Dump Devices
Show Information About the Previous System Dump
Show Estimated Dump Size
Change the Type of Dump
Change the Full Memory Dump Mode
Change the Primary Dump Device
Change the Secondary Dump Device
Change the Directory to which Dump is Copied on Boot
Start a Dump to the Primary Dump Device
Start a Traditional System Dump to the Secondary Dump Device
Copy a System Dump from a Dump Device to a File
Always ALLOW System Dump
Check Dump Resources Utility
Change/Show Global System Dump Properties
Change/Show Dump Attributes for a Component
Change Dump Attributes for multiple Components

F1=Help          F2=Refresh      F3=Cancel      F8=Image
F9=Shell        F10=Exit       Enter=Do

```

Figure 4-10 SMIT panel: type of System Dump

With the menu selection shown in Figure 4-10, the following panel appears:

```

                                Change the Type of Dump
Type or select values in entry fields.
Press Enter AFTER making all desired changes.

[Type of Dump]                                [Entry Fields]
fw-assisted                                     +

+-----+
|                                Type of Dump                                |
|                                Move cursor to desired item and press Enter.  |
|                                traditional                                     |
|                                fw-assisted                                     |
+-----+

F1=Help          F2=Refresh      F3=Cancel
F8=Image        F10=Exit       Enter=Do
F5= /=Find      n=Find Next
F9+

```

Figure 4-11 SMIT panel : Traditional or Firmware-assisted dump

Firmware-assisted system dumps can be one of these types:

Selective memory dump Selective memory dumps contain selected kernel information. Note that the traditional system dump is also a selective memory dump.

Full memory dump

The whole partition memory is dumped without any interaction with the AIX instance that is failing.

To select the memory dump mode of the firmware-assisted dump, a new entry Change the Full Memory Dump Mode, as shown in Figure 4-12, is added to the SMIT main panel for dump: **smitty dump**.

```

System Dump
Move cursor to desired item and press Enter.

Show Current Dump Devices
Show Information About the Previous System Dump
Show Estimated Dump Size
Change the Type of Dump
Change the Full Memory Dump Mode
Change the Primary Dump Device
Change the Secondary Dump Device
Change the Directory to which Dump is Copied on Boot
Start a Dump to the Primary Dump Device
Start a Traditional System Dump to the Secondary Dump Device
Copy a System Dump from a Dump Device to a File
Always ALLOW System Dump
Check Dump Resources Utility
Change/Show Global System Dump Properties
Change/Show Dump Attributes for a Component
Change Dump Attributes for multiple Components

F1=Help      F2=Refresh   F3=Cancel    F8=Image
F9=Shell     F10=Exit    Enter=Do

```

Figure 4-12 SMIT panel: Change the Full Memory Mode

The SMIT panel shown in Figure 4-13 on page 162 allows the administrator to choose the desired mode for the full memory dump. This choice can also be done on the command line with the new **sysdumpdev -f** option:

- ▶ To choose the selective memory mode, the full memory dump must be disallowed:

```
sysdumpdev -f 'disallow'
```
- ▶ To specify that the full memory dump is performed only if the operating system cannot properly handle the dump request:

```
sysdumpdev -f 'allow'
```
- ▶ To enforce the full memory system dump, it is always performed:

```
sysdumpdev -f 'require'
```

The disallow option is the default.

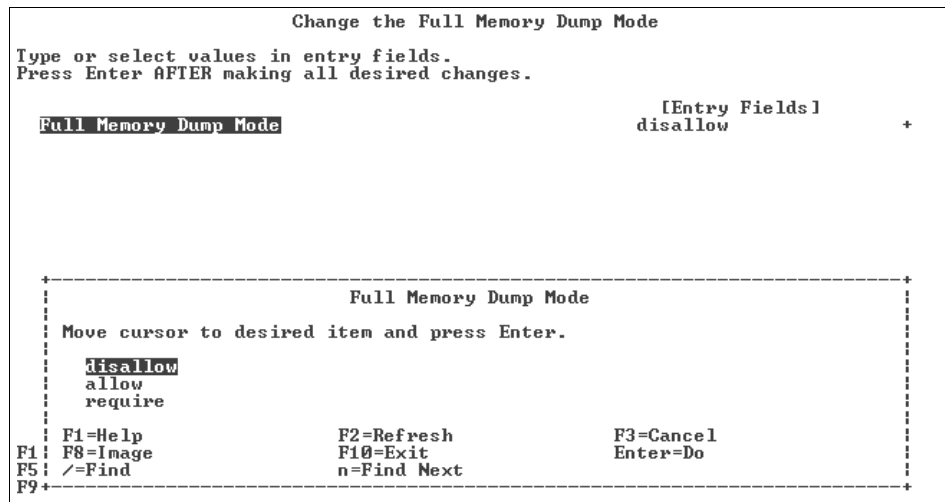

Figure 4-13 SMIT panel: Types of memory dump mode

A firmware-assisted system dump takes place under the following conditions:

- ▶ Firmware assisted dump is supported only on POWER6-based servers and later
- ▶ Memory size at system startup is equal to or greater than 4 GB.
- ▶ System has not been configured to do a traditional system dump.

If the firmware-assisted dump cannot be supported in spite of platform support or if the configuration of this dump facility fails, AIX forces a traditional system dump and logs in the errlog a meaningful message indicating the failure reason.

Note: As dump data is written on the next restart of the system, the AIX dump tables which are used to refer the data, cannot be preserved.

The following are the main steps of a firmware-assisted system dump:

1. When all conditions for a firmware-assisted dump are validated (at system initialization), AIX reserves a dedicated memory scratch area.
2. This predefined scratch area is not released unless the system administrator explicitly configures a legacy dump configuration.
3. The predefined scratch area size is relative to the memory size and ensures AIX will be able to reboot while the firmware-assisted dump is in progress.
4. System administrators must be aware that this dedicated scratch area is not adjusted when a memory DR operation modifies memory size. A verification

can be run with **sysdumpdev** command by system administrators in order to be notified if firmware-assisted system dump is still supported.

5. AIX determines the memory blocks that contain dump data and notifies the dedicated hypervisor to start a firmware-assisted dump with this information.
6. The hypervisor logically powers the partition off but preserves partition memory contents intact.
7. The hypervisor copies just enough memory to the predefined scratch area so that the boot process can start without overwriting any dump data.
8. AIX boot loader reads this dedicated area and copies them onto disk using dedicated open firmware methods. The hypervisor has no authority and is unable by design to write onto disk for security reasons.
9. AIX starts to boot and in parallel copies preserved memory blocks. The preserved memory blocks are blocks that contain dump data not already copied by the AIX boot loader. As with the traditional dump, firmware-assisted dump uses only the first copy of rootvg as dump device: it does not support disk mirroring.
10. The dump is complete when all dump data are copied onto disk. The preserved memory then returns to AIX usage.
11. AIX waits until all the preserved memory is returned to its partition usage in order to launch any user applications.

4.4 Performing a live dump

Dump components, explained in 4.3.2, “Component Dump Facility” on page 144, must be known before performing a live dump. All the live dump attributes must be set with the **dumpctrl** command as described in 4.3.3, “Live Dump Facility” on page 148. Then, a live dump can be performed by both of the following methods:

- ▶ With the new SMIT sub-panel “Start a Live Dump” of the menu: **smitty ldm**
In the SMIT panel shown in Figure 4-14 on page 164, the component to be dumped is **vmm.frs**. The symptom string is mandatory and is any-description.
- ▶ With the new **livedumpstart** command.

Only two arguments are required to run a live dump: the component to be dumped and the symptom string which is mandatory but can take any value.

With the **livedumpstart** command, the notation **+component** indicates to dump the data from that component and its ancestors while the notation **component+** indicates to dump the data from that component and its descendents.

The following example (and Figure 4-14) shows how to use the `livedumpstart` command to do a live dump on the VMM component (AIX Virtual Memory Manager) and all its descendents:

```
# livedumpstart -c vmm+ symptom="string is mandatory and is what you want"
0453-142 The dump is in file /var/adm/ras/livedump/nocomp.200710222353.00.DZ.
#
```

Start a Live Dump			
Type or select values in entry fields. Press Enter AFTER making all desired changes.			
		[Entry Fields]	
Component Path Names	[vmm.frs]		
Component Logical Alias Names	[]		
Component Type/Subtype Identifiers	[]		
Pseudo-Component Identifiers	[]		
Error Code	[]		
Symptom String	[any-description]		
File Name Prefix	[]		
Dump Priority	[critical]		+
Generate an Error Log Entry	[yes]		+
Dump Types	[serialized]		+
Force this Dump	[yes]		+
Dump Subcomponents	[no]		+
Dump Parent Components	[no]		+
Obtain a Size Estimate	[no]		+
(no dump is taken)			
Show Parameters for Components	[no]		+
(no dump is taken)			
F1=Help	F2=Refresh	F3=Cancel	F4=List
F5=Reset	F6=Command	F7=Edit	F8=Image
F9=Shell	F10=Exit	Enter=Do	

Figure 4-14 SMIT Panel: Starting a live dump

As mentioned in 4.3.3, “Live Dump Facility” on page 148, a live dump may also be initiated from the AIX kernel or from a kernel extension. For additional information, see “Live Dump Facility” in the “Kernel Extensions and Device Support Programming Concepts” publication:

<http://publib.boulder.ibm.com/infocenter/pseries/v5r3/topic/com.ibm.aix.kernext/doc/kernextc/kernextc.pdf>

4.5 Kernel error recovery

Starting with AIX V6.1, the AIX kernel has been enhanced with the ability to recover from unexpected errors. Kernel components and extensions can provide failure recovery routines to gather serviceability data, diagnose, repair, and recover from errors. In previous AIX versions, kernel errors always resulted in an unexpected system halt.

The kernel error recovery is a continuous reliability and availability feature to improve system stability. In AIX V6.1 the kernel components such as the watchdog services have failure recovery routines implemented.

Kernel error recovery support is not enabled by default. Kernel extensions created in AIX V5.3 are still supported with both enabled and disabled kernel error recovery. Kernel extensions implementing the new failure recovery routines cannot be run on pre AIX V6.1 versions.

4.5.1 Recovery concepts

Kernel components and kernel extensions enabled to support kernel error recovery will register their failure recovery routines to a recovery manager at runtime. These routines will typically perform the following actions:

- ▶ Collect serviceability data
- ▶ Verify and correct data structures
- ▶ Free or otherwise handle resources held or modified by the failing component at the time of the error (such as locks).
- ▶ Determine the error action

The recovery manager is responsible for controlling the recovery process. The recovery manager is a collection of kernel functions to manage and run the failure recovery routines (Figure 4-15).

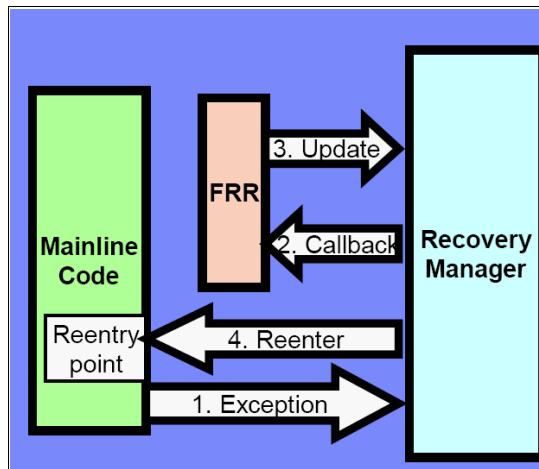

Figure 4-15 Kernel recovery process

If a failure occurs in the kernel component or extension, the exception is routed to the recovery manager. The recovery manager will then call the corresponding

failure recovery routine. After completing the routine the recovery manager will then pass control back to the failing component at the re-entry point.

Most failure recovery routines initiate a live dump before any repair has been attempted. Each kernel recovery will be logged into the AIX error log and if applicable with a reference to the live dump. Live dump should be enabled on your system in order to provide IBM service support with serviceability data. See 4.3.3, “Live Dump Facility” on page 148 for more information about live dump.

Kernel recovery may cause the system to be temporarily unavailable. All failure routines during an kernel recovery have to complete within a total time of ten seconds. The time limit is chosen to allow kernel recovery to occur within the default HACMP heartbeat timeout to prevent unwanted takeovers. If these limits are exceeded, an error will be logged in the AIX error log.

Note: In some cases complete error recovery is not possible and error isolation is executed instead. Some functions might be lost after a kernel recovery, but the operating system remains in a stable state. If necessary, restart your system to restore the lost functions.

4.5.2 Kernel error recovery management

The failure recovery routines are part of the source code within the kernel components and extensions. No management of the FRR is needed nor possible. This section describes the changes to user interfaces related to kernel recovery.

AIX error log entries

AIX will log every kernel error recovery occurrence into the AIX error log. The following three new error log entries are introduced with kernel error recovery (Table 4-9):

Table 4-9 Kernel error recovery error log entries

Identifier	Label	Description
00412073	RECOVERY	Is logged each time a kernel error recovery occurred. The failing function, the FRR name and if applicable the live dump file name are logged. The live dump is stored in the /var/adm/ras/livedump directory.

Identifier	Label	Description
B709A434	RECOVERY_NOTIFY	This error log type is issued at most once a minute. With every RECOVERY_NOTIFY error log entry a message is written to the console that a error recovery occurred.
B9657B5B	RECOVERY_TIME	Is logged if a kernel error recovery process exceeds either the two seconds or the ten seconds timeout.

You can use the error log entries and the corresponding live dumps to provide IBM service with more information in case of a problem.

The following shows a sample RECOVERY error log entry:

```

-----
LABEL:          RECOVERY
IDENTIFIER:     00412073

Date/Time:      Thu Oct 25 18:39:07 2007
Sequence Number: 521
Machine Id:     00C1F1704C00
Node Id:        lpar02
Class:          0
Type:           INFO
WPAR:           Global
Resource Name:  RMGR

```

```

Description
Kernel Recovery Action

```

```

Probable Causes
Kernel Error Detected

```

```

Recommended Actions
Contact IBM Service

```

```

Detail Data
Live Dump Base Name
RECOV_20071025233906_0000
Function Name
watchdog
FRR Name
watchdog_frr
Symptom String
273
EEEE00009627A058
0000000000000000

```

```

watchdog+514
sys_timer+154
clock+2E0
Recovery Log Data
0001 0000 0000 0000 F100 0415 4003 36B0 0000 0111 0000 0000 0000 0000 0016 C4F8
8000 0000 0002 9032 EEEE 0000 9627 A058 0000 0000 0000 0000 0000 0000 0000
...
```

SMIT panel

A new SMIT panel is available to deactivate, activate, and show the current state of kernel error recovery:

Problem Determination → Kernel Recovery

The raso command tunables

With the **raso** command, you can manage reliability, availability, and serviceability parameters. The following new tunables are introduced to change the behavior of the recovery manager. All recovery tunables are restricted and should not be changed unless requested by the IBM service support. See 6.2, “Restricted tunables” on page 241 for additional information.

Table 4-10 *raso tunables for kernel error recovery*

Tunable	Description
recovery_framework	With the recovery_framework tunable you can enable or disable the kernel error recovery. A system reboot is required for the change to take effect. The default state is disabled.
recovery_action	The recovery_action tunable allows you to temporarily disable the kernel error recovery without a system reboot. If an kernel error occurs the system will be halted without any recovery attempts. This option only has an effect if the recovery_framework parameter is enabled. Setting the recovery_action parameter to the halt system value does not provide any performance improvement.
recovery_debugger	The recovery_debugger tunable parameter allows the kdb (kernel debugger) to be invoked when recovery actions occur. This tunable is intended for debugging only by the IBM service support.

Tunable	Description
recovery_average_threshold	The recovery_average_threshold tunable manages the threshold on the maximum average recovery actions. The system stops if the average number of kernel recovery actions per minute exceeds this value. The default value is 5.

The KDB kernel debugger

The kernel debugger `kdb` command displays with the subcommand `stat` the started and currently running number of failure recovery routines:

```
# kdb
(0)> stat
SYSTEM_CONFIGURATION:
CHRP_SMP_PCI POWER_PC POWER_6 machine with 2 available CPU(s) (64-bit
registers)

SYSTEM STATUS:
sysname... AIX
nodename.. lpar02
release... 1
version... 6
build date Sep 17 2007
build time 21:00:47
label..... 0738A_610
machine... 00C1F1704C00
nid..... C1F1704C
age of system: 3 day, 21 hr., 35 min., 20 sec.
xmalloc debug: enabled
FRRs active... 0
FRRs started.. 0
```

4.6 Concurrent update

AIX V6.1 introduces the ability to update certain kernel components and kernel extensions in place, without the need of a system reboot. IBM service support can deliver interim fixes as concurrent updates. At the time of writing, interim fixes are the only supported fix type for concurrent updates. You can manage the new concurrent fixes with the `emgr` command.

Applying fixes without the need of a reboot provides you a method to fix critical problems without service interruption. In a similar manner as with traditional

interim fixes you can choose if a concurrent update should be made persistent across system reboots or applied only to the currently running system, which is the default behavior.

In addition concurrent updates can be removed from the system without the need of a reboot if the fix is applied state only and no commit operation has been issued.

Performing concurrent updates on an operating system is a complex task and places stringent demands on the operating system. Interim fixes to kernel components and kernel extensions have to meet certain technical requisites in order to be provided as concurrent updates. Therefore not all kernel fixes will be available as concurrent updates.

4.6.1 Concurrent update method

This section discusses the used methods to update kernel components and kernel extensions and provides you a technical introduction on how it works. Refer to 4.6.2, “The `emgr` command concurrent update operations” on page 171 for explanations on how to perform concurrent updates with the `emgr` command.

The `emgr` command is used to initiate concurrent updates. It will perform requisite checks on the interim fix and then execute a new system call named `kpatch()`. This system call controls the patching of the kernel. Several checksums are used to verify integrity of the new fixed object files as well as the target kernel components. This procedure makes sure that only supported kernel component versions are fixed.

AIX V6.1 keeps a separate memory area where it stores all the new fixed object files. The `kpatch` system call will load all new object files into this memory area. At this time the updates are not activated. In order to be able activate an interim fix in a running AIX, the system has to be paused for a short time period. The only executed task has to be the `kpatch` system call. All CPUs except the one running `kpatch()` will freeze during the update.

The `kpatch` system call will replace the first instruction of each function to patch with an redirection statement to the new fixed code. Before replacing takes place, the first instruction is saved in order to be able to recover functionality for a potential in place interim fix removal. After all redirection statements have been set, the CPU freezes are released and the AIX kernel uses the new fixed code for any execution.

Figure 4-16 on page 171 shows a high level view of the task performed for a concurrent update:

1. The `emgr` command calls the `kpatch()` routine.

2. kpatch() loads the fixed objects to the patch area
3. kpatch() initiates the CPU freezes
4. kpatch() saves the first instruction of a function and then replaces it with a redirection to the new fixed code resident in the patch area
5. kpatch() initiates unfreeze of all CPUs
6. kpatch() reports the status of the concurrent update back to **emgr** command

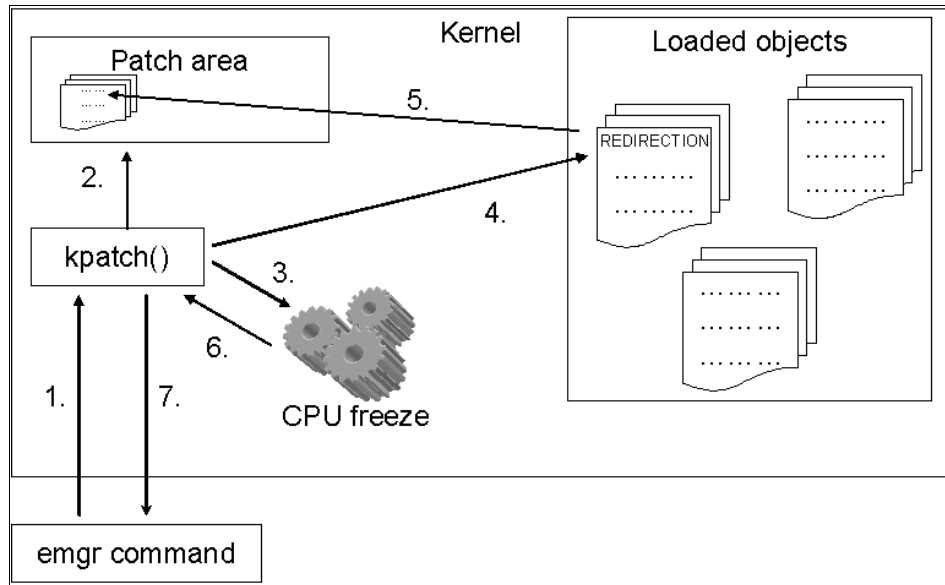

Figure 4-16 Concurrent in memory update high level overview

4.6.2 The emgr command concurrent update operations

The **emgr** command is used to apply, remove, verify, and list concurrent kernel updates. It is recommended to use always first the preview mode with the **-p** flag before performing the actual apply or remove operation.

The following examples show operations on a kernel extension named `sample_kext` and an interim fix labeled `CU_Demo`, since at the time of writing no interim fixes are available from the service support.

Applying concurrent updates

To apply an concurrent update interim fix use the new **-i** flag with the **emgr** command. The output will look similar to standard interim fixes, except that the file type in the file section will indicate that it is a concurrent update:

```
# emgr -i CU_Demo.071015.epkg.Z
...
File Number:      1
LOCATION:          /usr/lib/drivers/sample_kext
FILE TYPE:     Concurrent Update
INSTALLER:       installp (new)
SIZE:            8
ACL:             root:system:755
CKSUM:           17531
PACKAGE:         None or Unknown
MOUNT INST:     no
...
```

In order to make to update persistent across reboots, add the -C flag:

```
# emgr -Ci CU_Demo.071015.epkg.Z
```

The commit operation can be also issued separately after an apply of a fix:

```
# emgr -C -L CU_Demo
```

Note that committed updates cannot be removed without a reboot.

Removing concurrent updates

Use the -r flag to remove a concurrent update. Note that you have to use the -L flag and specify the fix label as an argument:

```
# emgr -r -L CU_Demo
```

In some situations the updated objects cannot be unloaded. You can use the -R flag in such a situation and the fix will be removed from the database, but the system will need a reboot in order to unload the concurrent code:

```
# emgr -R -L CU_Demo
```

List concurrent updates

Use the -l flag to list information about the installed concurrent updates.

```
# emgr -l -L CU_Demo
```

ID	STATE	LABEL	INSTALL TIME	ABSTRACT
1	P	CU_Demo	10/24/07 19:11:14	Demonstration CU ifix

STATE codes:

S = STABLE

M = MOUNTED
 U = UNMOUNTED
 Q = REBOOT REQUIRED
 B = BROKEN
 I = INSTALLING
 R = REMOVING
 T = TESTED
P = PATCHED
N = NOT PATCHED
SP = STABLE + PATCHED
SN = STABLE + NOT PATCHED
QP = BOOT IMAGE MODIFIED + PATCHED
QN = BOOT IMAGE MODIFIED + NOT PATCHED
RQ = REMOVING + REBOOT REQUIRED

Note the new states introduced with concurrent updates at the end of the state code list:

Table 4-11 New interim fix states displayed with the emgr command

State	Description
P	Concurrent update is applied.
N	Concurrent update is installed but not activated. This state is displayed after a reboot if the fix has not been made persistent (stable). To recover from this state you have to remove the fix and apply it again.
SP	Concurrent update is applied and made persistent (stable).
SN	Concurrent update has been made persistent but is currently not applied.
QP	Concurrent update is applied and the boot image has been modified.
QN	Concurrent update is not applied but the boot image is updated.
RQ	Concurrent update is marked to be removed, but a reboot is still required to remove it from the memory.

Verify concurrent updates

You can use the verify option on concurrent updates in the same manner as on standard interim fixes:

```
# emgr -c -L CU_Demo
```

Note that verification is only intended for persistent concurrent updates. Verification on applied concurrent updates will always fail.

4.7 Core dump enhancements

A core file is created in the current working directory when various errors occur. Errors such as memory-address violations, illegal instructions, bus errors, and user-generated quit signals, commonly cause this core dump.

Previous AIX releases only dump core files if either the real user ID is root or the effective user ID (EUID) and effective group (EGID) match the real user ID (RUID) and the real group ID (RGID). All core dumps are created with an access mode of 0666 in octal notation. (0666 grants read and write access rights to the owner, the owners group, and to others. No execution is permitted.)

AIX V6.1 changes the user id (UID) / group ID (GID) authorization requirements for core dump creation to provide the dump capability for SUID and SGID processes. Figure 4-17 shows the UID / GID authorization dependencies that govern the core dump process.

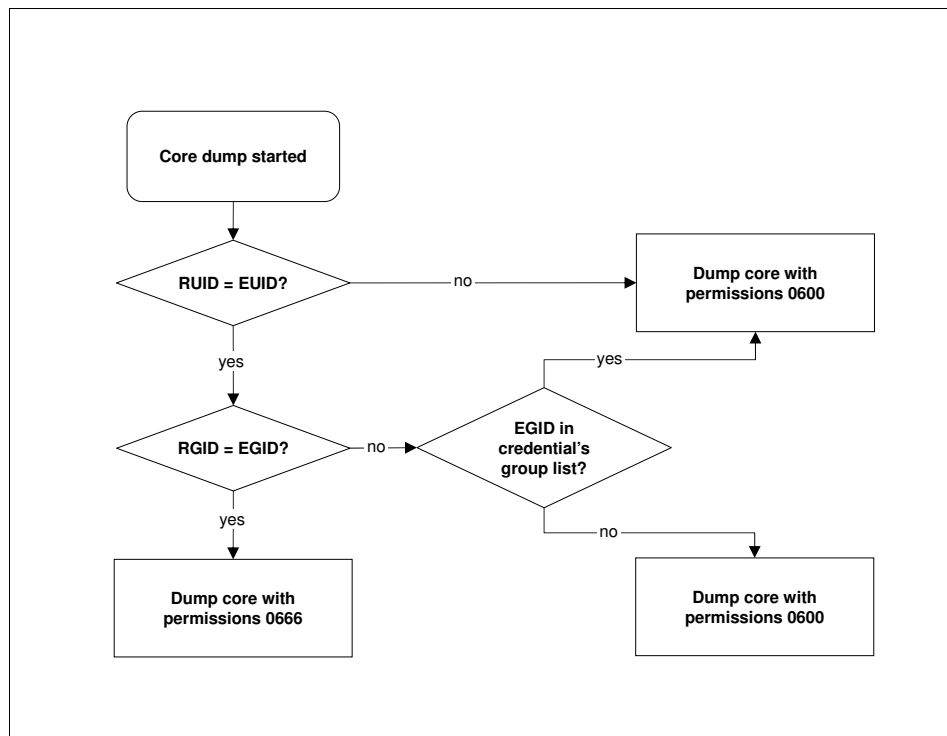

Figure 4-17 Core dump UID / GID dependencies

The enhanced AIX V6.1 core dump authorization framework is designed to balance serviceability with security concerns. The section “core File Format” in

Chapter 2. “File formats” of the *AIX Version 6.1 Files Reference*, SC23-5249 explains the details of the core dump process as follows:

- ▶ All dumped cores are in the context of the running process. They are dumped with an owner and a group matching the effective user ID (UID) and group ID (GID) of the process. If this UID/GID pair does not have permission to write to the target directory that is determined according to the standard core path procedures, no core file is dumped.
- ▶ If the real user ID (RUID) is root, the core file can always be dumped, but with a mode of 0600.
- ▶ If the effective user ID (EUID) matches the real user ID (RUID), and the effective group ID (EGID) matches any group in the credential's group list, the core file is dumped with permissions of 0600.
- ▶ If the EUID matches the RUID, but the EGID does not match any group in the credential's group list, the core file cannot be dumped. The effective user cannot see data that they do not have access to.
- ▶ If the EUID does not match the RUID, the core file can be dumped only if you have set a core directory using the **syscorepath** command. This avoids dumping the core file into either the current working directory or a user-specific core directory in such a way that you cannot remove the core file. Core is dumped with a mode of 0600. If you have not used the **syscorepath** command to set a core directory, no core is dumped.

4.8 I/O request tracking

AIX uses a struct buffer (named *buf*) to describe an I/O operation to a storage device such as hardisk, CD-ROM, to name two. The definition of *buf* comes from standard UNIX and has served the storage I/O need well in AIX. However, due to binary compatibility issues resulting from inability to extend the struct *buf* (it has no more free space left), an extended struct *bufx* was created (see Related Documents).

As the storage I/O stack has become deeper and more complex with sophisticated function provided by the file systems, LVM, and other layers in the stack, keeping track of I/O has become more difficult. This results in less efficient and more difficult problem determination related to the I/O. An example of a difficult debug scenario is when AIX hangs due to unfinished I/O to rootvg or paging space. In order to improve availability from the storage I/O point-of-view, more information about the I/O needs to be tracked in struct *bufx*. Some of the information would be available in the First Failure Data Capture (FFDC) and some may be enabled for a Second Failure Data Capture (SFDC).

4.9 Trace hook range expansion

Over the past years of AIX development history, the trace capabilities received considerable enhancements and matured to become a very important and strategic key feature not only for performance evaluation but for First Failure Data Capture (FFDC) functionality. Traditional tracing works mainly by placing hooks containing relevant data into a buffer when a system component deems that an important event should be recorded. Each component defines their traceable events. In order to define their events, each component is given a range of trace hook IDs. Each trace hook allocates 12 bits for the trace hook ID allowing for 4096 unique trace hook IDs.

In anticipation of future demands, AIX V6.1 expands the trace hook ID range from 12 bits to 16 bits.

The implemented trace hook range expansion will allow for significantly more trace hook IDs to be used. The trace hook ID range will include the old range, 0x000 to 0xFFFF, and the new range, 0x1000 to 0xFFFF. 16-bit IDs in which the least significant nibble is 0 (such as 0x2100, 0xABC0, 0xFFFF0) will be equivalent to their 12-bit IDs to avoid collision. For example, hook ID 0x218 will be represented as 0x2180 in a 64-bit kernel. Thus, to avoid collision, 0x2180 and 0x218 will be regarded as the same ID.

Another restriction applies to hooks below 0x1000. These hooks must have zero as their least significant nibble. For instance, 0x0101 and 0x00A1 are not allowed since hook ID 0x1010 and 0x0A10 map to these hook IDs respectively.

The new trace hook scheme allows for a total of $65536 - 7680 = 57856$ unique hook IDs for 64-bit applications.

The expanded hook range will only be accessible to 64 bit applications since 32-bit applications do not have room in the hook word for the extra four bits necessary. Thus, 32-bit applications will be restricted to using only the existing 12-bit range that has not already been allocated. Currently, there are around 2000 un-allocated 12-bit hook IDs which provide an ample resource for new trace hook ID assignment. Some of these, however, will be potentially used for remaining 32-bit kernel development in AIX 5L.

In support of the expanded trace hook range in AIX V6.1 the command lines of the following four commands were updated: **trace**, **trcupdate**, **trcegrp**, and **trcrpt**:

1. The **trace -j** and the **trace -k** command options accept four-hex-digit hook IDs. The -j and -k options work as on previous AIX releases with regards to two- and three-hex-digit hook IDs. For example, -j 12, prior to AIX V6.1, traced hooks 120-12F, and will trace hooks 1200, 1210, 1220,... 12F0, but not any

intervening hooks such as 1201 under AIX V6.1. The same applies to specifying three-hex-digit hooks. For example, `-k 130` ignores only hook 1300, and does not apply to a hook range in AIX V6.1. The recommended way to group trace hooks is with the trace groups, see the `trcevgrp` command.

2. The `trcupdate -x` command option is aware of up to four hex digits per hook ID in the hook ID list.
3. The `trcevgrp -h` command option is aware of up to four hex digits per hook ID in the hook ID list.
4. The `trcrpt -d` and `trcrpt -k` command options accept four-hex-digit hook IDs. Beginning with AIX V6.1 and in complete analogy to the previously described `trace` command, specifying a two-hex-digit hook ID in the `hh` form results in `hh00`, `hh10`, ..., `hhF0`. Specifying a three-hex-digit hook ID in the `hhh` form results in `hhh0`. Specifying a four-hex-digit hook ID in the `hhhh` form results in `hhhh`. Four-hex-digit hook IDs can always be displayed. However, if a four-hex-digit hook ID has a trailing digit of zero, the zero is removed to display only three hex digits. This occurs because four-hex-digit hook IDs in the form `hhh0` are equivalent to three-hex-digit hook IDs in the form `hhh`. The `trcrpt -D` and `trcrpt -K` command options are aware of up to four hex digits per hook ID in the event group list.

In addition to the enhanced command line interface the `trcgui` graphical user interface and the trace related SMIT panels are aware of four-hex-digit trace hook IDs too.

4.10 LVM configuration and trace logs

AIX releases prior to AIX V6.1 are equipped with internal Logical Volume Manager (LVM) logging services which are aimed to assist IBM support specialists in error detection and problem analysis. These services collect information which is related to configuration and management operations on enhanced concurrent and non-concurrent volume groups. But the increase of complexity over the recent past has raised additional requirements for LVM configuration and tracing logs to facilitate continuous surveillance and long-term data recording.

AIX V6.1 provides enhancements to LVM configuration and tracing logs in three areas:

- ▶ Introduction of the new `lvmcfg` logging service to keep a long-term record of changes to volume groups over time.
- ▶ Enhanced `lvmt` trace log functionality for continuous and detailed LVM configuration change recording.

- ▶ Enhanced trace log characteristics for the Group Services Concurrent Logical Volume Manager (gslvmd) daemon.

All implemented additions and changes utilize the AIX alog facility and focus on the LVMs First Failure Data Capture (FFDC) capabilities to improve the ability to quickly determine recreate scenarios and to minimize problem resolution time.

Note: All configuration and trace log facilities described in this section are not intended for customer use but to collect important information for IBM support specialist to assist in problem recreation, analysis, and resolution. To that extent, this section provides only background information to advanced system administrators regarding the ongoing effort to enhance the continuous availability features of AIX.

4.10.1 LVM configuration log

Recent field studies have identified the need for the LVM to keep a long-term log of changes to volume groups over time. To meet this requirement AIX V6.1 provides a new log, called the *lvmcfg log*, which keeps track of what LVM commands were run, what arguments were passed to those commands, and what exit value those commands returned. This logging service will always be enabled on any AIX V6.1 system. To record the information in the log, each high level AIX V6.1 LVM command (excluding the commands which provide only information listings) was enhanced to call two new functions, one at the beginning of execution and the other before it exits or returns from the main code segment. If the high level command is implemented as script the wrapper commands for the relevant functions are called. The beginning function call will open both the lvmcfg log file (lvmcfg.log) and the lvmt log file (lvmt.log).

The lvmt log is described in more detail in the 4.10.2, “LVM detailed trace configuration log” on page 180 section.

The function call will then add a start entry to both logs with the name of the command being run and the arguments that were passed to that command. The ending function call adds an end entry to both logs with the name of the command and the exit code that the command is exiting with. It also closes each open log and performs any other necessary cleanup.

In order to view the lvmcfg log the **alog** command can be used. The following example shows the **alog** command output for the lvmcfg log on an AIX V6.1 system:

```
# alog -t lvmcfg -o | pg
Starting Log
[S 135196 155670 09/27/07-15:46:32:215 extendlv.sh 794] extendlv hd2 12
```

```
[E 135196 0:860 extendlv.sh 33] extendlv: exited with rc=0
[S 126986 192630 09/27/07-17:03:07:756 extendlv.sh 794] extendlv hd6 3
[E 126986 0:673 extendlv.sh 33] extendlv: exited with rc=0
[S 82038 110648 09/27/07-12:03:53:362 chlv.sh 527] chlv -L primary_bootlv hd5
[E 82038 0:404 chlv.sh 23] chlv: exited with rc=0
[S 82042 110648 09/27/07-12:03:53:782 syncvg.sh 539] /usr/sbin/syncvg -v rootvg
[E 82042 0:325 syncvg.sh 19] /usr/sbin/syncvg: exited with rc=0
[S 180370 151658 09/27/07-12:04:01:718 cfgvg.c 106] cfgvg
[E 180370 0:001 cfgvg.c 212] cfgvg: exited with rc=0
[S 327750 393228 09/27/07-16:16:14:043 extendlv.sh 794] extendlv hd2 1
[E 327750 0:815 extendlv.sh 33] extendlv: exited with rc=0
[S 110692 82020 10/01/07-10:53:32:121 chlv.sh 527] chlv -L primary_bootlv hd5
[E 110692 0:364 chlv.sh 23] chlv: exited with rc=0
[S 110696 82020 10/01/07-10:53:32:502 syncvg.sh 539] /usr/sbin/syncvg -v rootvg
[E 110696 0:417 syncvg.sh 19] /usr/sbin/syncvg: exited with rc=0
[S 204906 200802 10/01/07-10:54:00:231 cfgvg.c 106] cfgvg
[E 204906 0:001 cfgvg.c 212] cfgvg: exited with rc=0
[S 336098 241678 10/01/07-14:27:50:344 mklv.sh 617] mklv -t jfs2 rootvg 1
[E 336098 0:809 mklv.sh 72] mklv: exited with rc=0
[S 336102 241678 10/01/07-14:27:51:329 chlv.sh 527] chlv -L /wpars/mywpar1 fslv00
[E 336102 0:375 chlv.sh 23] chlv: exited with rc=0
```

... omitted lines ...

Each entry into both the lvmcfg log and the lvmt log is comprised of a preamble and a message. The preamble for start entries contain the following information:

S	Marks entry as a start entry
pid	Process ID
ppid	Parent process ID
timestamp	Date and time the entry was recorded Format: MM/dd/yy-hh:mm:SS:sss (MM=month, dd=day, yy=year, hh=hour, mm=minute, SS=sec, sss=millisec)
filename	Name of command (executable, shell script)
line number	Line number in reference to code executed

The start entry preamble has the following format:

```
[S pid ppid date timestamp filename line number]
```

The preamble for end entries contain the following information:

E	Marks entry as an end entry
pid	Process ID
timestamp	Date and time since start entry was recorded Format: MM/dd/yy-hh:mm:SS:sss (MM=month, dd=day, yy=year, hh=hour, mm=minute, SS=sec, sss=millisec)
filename	Name of command (executable, shell script)
line number	Line number in reference to code executed

The end entry preamble has the following format:
[E pid timestamp filename line number]

The `lvmcfg` log file, `lvmcfg.log` adheres to the `alog` file format and is stored in the `/var/adm/ras` directory. The default size of the `lvmcfg` log is defined to be 50 KB. As required by the `alog` facility the minimum log size for the log is 4 KB but no implementation specific restrictions on the maximum log size exist. The log entries are wrapped within the log file.

4.10.2 LVM detailed trace configuration log

The same considerations which initiated the addition of the new `lvmcfg` logging service also guide the enhancements to the existing LVM trace logging facility called `lvmt`. In previous AIX releases this facility writes to files in the `/tmp` directory to store the trace data. This tracing service is disabled by default and must be turned on using an environment variable before any trace data is recorded. The trace files are simply appended to and can consume all of the space in `/tmp` if tracing is left on for an extended period of time. This trace facility is an “all or nothing” type of service. When turned on, there is no way to control the amount of information traced.

In addition to the new `lvmcfg` log the AIX V6.1 LVM subsystem utilizes an enhanced `lvmt` logging service to improve the continuous availability signature of the operating system. The `lvmt` logging service provides a trace facility for the LVM commands similar to what lightweight memory trace provides to the AIX kernel. The enhanced `lvmt` logging service will always be enabled on any AIX V6.1 system. As outlined in the previous section 4.10.1, “LVM configuration log” on page 178 all start and end entries which are recorded in the `lvmcfg` log are also written to the `lvmt` log. But if required AIX V6.1 high level LVM commands write additional entries to the `lvmt` log with a call to the (undocumented) `lvmt()` function. Each call to the `lvmt()` function will include a verbosity. The `lvmt()` function will add the entry to the `lvmt` log if the verbosity level included is less than or equal to the verbosity set for the system.

The verbosity has a value of 0-9. The verbosity level that the running command uses will be determined when the log is first open. The verbosity level to use will be determined in a sequence of steps. First, if the environment variable `LVMT_VERBOSE` is set to a numeric value between 0 and 9, that value will be used as the verbosity. Second, if the verbosity is not set by the `LVMT_VERBOSE` environment variable then the file `/etc/lvmtlog.cfg` will be read for a line starting with `LVMT_VERBOSE=` followed by a number between 0 and 9. If that file exists and contains the line then that value will be used for verbosity. Third, if the verbosity is not found in the environment variable or the file, then it will default to a verbosity of 3. Any logs entries with a verbosity level at or below the set verbosity level will be entered into the `lvmt` log. Setting the verbosity level to 0 will

turn off logging. Macros for four levels of verbosity are predefined for use by the LVM:

LVMT_ERROR	This level has a verbosity of 1 and is used to add error conditions found in the code.
LVMT_WARN	This level has a verbosity of 2 and is used to add warnings into the lvmt log.
LVMT_INFO	This level has a verbosity of 3 and can be assigned to basic information about the execution of the code.
LVMT_DETAIL	This level has a verbosity of 7 and is used to add detailed information about the code execution and program flow.

In order to view the lvmt log the `alog` command can be used. The following example shows the `alog` command output for the lvmt log on an AIX V6.1 system:

```
# alog -t lvmt -o | pg
Starting Log
[S 82038 110648 09/27/07-12:03:53:362 chlv.sh 527] chlv -L primary_bootlv hd5
[E 82038 0:404 chlv.sh 23] chlv: exited with rc=0
[S 82042 110648 09/27/07-12:03:53:782 syncvg.sh 539] /usr/sbin/syncvg -v rootvg
[E 82042 0:325 syncvg.sh 19] /usr/sbin/syncvg: exited with rc=0
[S 180370 151658 09/27/07-12:04:01:718 cfgvg.c 106] cfgvg
[E 180370 0:001 cfgvg.c 212] cfgvg: exited with rc=0
[S 245898 1 09/27/07-12:05:18:224 utilities.c] Command started without lvmcfg_start call
[I 245898 0:000 utilities.c 1330] lvm_getvgdef: FAIL: no matching vgids,
returning=LVM_OFFLINE
[I 245898 0:000 queryutl.c 1339] lvm_lsvg: FAIL: lvm_getvgdef failed, rc=-100
[S 200822 1 09/27/07-12:05:18:743 utilities.c] Command started without lvmcfg_start call
[I 200822 0:000 utilities.c 1330] lvm_getvgdef: FAIL: no matching vgids,
returning=LVM_OFFLINE
[I 200822 0:000 queryutl.c 1339] lvm_lsvg: FAIL: lvm_getvgdef failed, rc=-100
[S 327750 393228 09/27/07-16:16:14:043 extendlv.sh 794] extendlv hd2 1
[E 327750 0:815 extendlv.sh 33] extendlv: exited with rc=0
[S 110692 82020 10/01/07-10:53:32:121 chlv.sh 527] chlv -L primary_bootlv hd5
[E 110692 0:364 chlv.sh 23] chlv: exited with rc=0
[S 110696 82020 10/01/07-10:53:32:502 syncvg.sh 539] /usr/sbin/syncvg -v rootvg
[E 110696 0:417 syncvg.sh 19] /usr/sbin/syncvg: exited with rc=0
[S 204906 200802 10/01/07-10:54:00:231 cfgvg.c 106] cfgvg
[E 204906 0:001 cfgvg.c 212] cfgvg: exited with rc=0
[S 336098 241678 10/01/07-14:27:50:344 mklv.sh 617] mklv -t jfs2 rootvg 1
[E 336098 0:809 mklv.sh 72] mklv: exited with rc=0
[S 336102 241678 10/01/07-14:27:51:329 chlv.sh 527] chlv -L /wpars/mywpar1 fslv00
[E 336102 0:375 chlv.sh 23] chlv: exited with rc=0

... omitted lines ...
```

As mentioned previously, each entry into the lvmt log will contain a preamble and a message. The preamble for start and end entries contain the same information as the related log entries in the lvmcfg log. (Refer to the 4.10.1, “LVM

configuration log” on page 178 section for a detailed description of start and end entry preambles.)

The preamble for lvmt log entries which are added through the lvmt() function call and as such are not start or end entries contain the following information:

verbosity level	Level of verbosity
pid	Process ID
timestamp	Date and time since start entry was recorded Format: MM/dd/yy-hh:mm:ss:sss (MM=month, dd=day, yy=year, hh=hour, mm=minute, SS=sec, sss=millisec)
filename	Name of command (executable, shell script)
line number	Line number in reference to code executed

The lvmt entry preamble has the following format:

```
[verbosity pid timestamp filename line number]
```

The lvmt log file, lvmt.log adheres to the alog file format and is stored in the /tmp directory. The default size of the lvmcfs log is defined to be 200 KB. As required by the alog facility the minimum log size for the log is 4 KB but no implementation specific restrictions on the maximum log size exists. The log entries are wrapped within the log file.

4.10.3 The gscsvmd daemon log

The Group Services Concurrent Logical Volume Manager daemon (gscsvmd) is needed in HACMP environments to manage enhanced concurrent volume groups which are accessed by HACMP cluster nodes. Because of the complexity of the Group Services Concurrent Logical Volume Manager part of the LVM, the related gscsvmd daemon traditionally has its own logging facility, called *gscsvmd trace*. In previous AIX releases gscsvmd trace writes to several plain text files, namely the parent gscsvmd process logs to /tmp/gscsvmd.log and the child processes log to /tmp/ch.log.<vgid>. (<vgid> is a placeholder for the relevant volume group ID.) The log files are not bound, so there is the potential of filling up the /tmp directory if tracing is left on un-monitored for extended periods of time. Because of that gscsvmd trace used to be disabled by default and cannot be turned on until a volume group is varied on.

AIX V6.1 enhances the gscsvmd trace to use the alog facility and to write to only one *lvms log* file (lvms.log). The enhanced gscsvmd trace service will always be enabled on any AIX V6.1 system to support the AIX First Failure Data Capture framework.

The lvmgs log is written by using the same function as in previous AIX releases. However, a new argument has been added to this function to account for 10 distinct verbosity levels. The lvmgs log has the same verbosity levels as the lvmt log but the predefined macros which are used by the LVM are named slightly different:

NOTIFY_ERROR	Verbosity level 1
NOTIFY_WARN	Verbosity level 2
NOTIFY_INFO	Verbosity level 3
NOTIFY_DETAIL	Verbosity level 7

The verbosity that will be used can be set in a similar way as the lvmt verbosity. First, the environment variable LVMGS_VERBOSE will be checked to see if it has a value between 0 and 9. If it does that will be used to the gsclvmd verbosity. Next the /etc/lvmtlog.cfg file will be checked for a line starting with LVMGS_VERBOSE= followed by a number between 0 and 9. If either of those values are not set, a default verbosity of 3 will be used. Setting the verbosity to 0 will effectively turn off logging. It should be noted that in customer environments gsclvmd is started through HACMP. Therefore the gsclvmd process will not inherit the environment variables from the calling shell. In this case, the LVMGS_VERBOSE variable will not be seen by the gsclvmd process.

The gsclvmd trace log can be viewed using the `alog` command just like the lvmcfg and lvmt logs. The following example shows the `alog` command output for the gsclvmd log on an AIX V6.1 system:

```
# alog -t lvmgs -o
Starting Log
[3 122978 1 11/02/07-16:48:56:959 gsclvmd.c 259] main: new parent process
[3 122978 1 11/02/07-16:49:42:275 gsclvmd.c 660] do_daemon_loop: got a new message from
src
[3 122978 515 11/02/07-16:49:42:275 gsclvmd.c 1074] handle_src_req: request from
tellclvmd, action=21[STARTVG]
[3 122978 515 11/02/07-16:49:42:276 gsclvmd.c 1177] src_startvg:
newvgid=0027b16d00004c000000011602572d55
[3 221426 1 11/02/07-16:49:42:281 gsclvmd.c 252] main: new child process
[3 221426 1 11/02/07-16:49:42:282 gsclvmd.c 1391] child_startup:
vgid=0027b16d00004c000000011602572d55,
socket=/dev/ch.sock.0027b16d00004c000000011602572d55
[3 221426 1 11/02/07-16:49:42:282 gschild.c 284] clvm_init_ha_gs: (ENTER)
[3 221426 1 11/02/07-16:49:42:282 gschild.c 285] clvm_init_ha_gs:
vgid=0027b16d00004c000000011602572d55, varyon=0
[3 221426 1 11/02/07-16:49:42:282 gsutility.c 636] get_vg_major: Major num=29
[3 221426 258 11/02/07-16:49:42:308 gschild.c 1086] read_config_request: (ENTER)
[3 221426 515 11/02/07-16:49:42:309 gschild.c 1264] read_vgsa_request: (ENTER)
[3 221426 772 11/02/07-16:49:42:309 gschild.c 772] join_vg_groups: (ENTER): grp_index=0
[3 221426 1029 11/02/07-16:49:42:309 gschild.c 977] wait_for_requests: (ENTER)
[3 221426 772 11/02/07-16:49:42:309 gschild.c 878] join_vg_groups: ha_gs_join returned
successfully for vgda group, tid=0
```

```
[3 221426 772 11/02/07-16:49:42:309 gschild.c 945] join_vg_groups: (LEAVE): grp=0,
ncollides=0
```

... omitted lines ...

The preamble for `gsclvmd` log entries contain the following information:

verbosity level	Level of verbosity of entry
pid	Process ID
tid	Thread ID
date	Date the entry was recorded
timestamp	Date and time since start entry was recorded Format: MM/dd/yy-hh:mm:ss:sss (MM=month, dd=day, yy=year, hh=hour, mm=minute, SS=sec, sss=millisec)
filename	Name of command (executable, shell script)
line number	Line number in reference to code executed

The `lvmps` log entry preamble has the following format:

```
[Verbosity pid tid timestamp filename line number]
```

The `lvmps` log file, `lvmps.log` adheres to the `alog` file format and is stored in the `/tmp` directory. The default size of the `lvmps` log is defined to be 200 KB. As required by the `alog` facility the minimum log size for the log is 4 KB but no implementation specific restrictions on the maximum log size exist. The log entries are wrapped within the log file.

4.11 Group Services Concurrent LVM enhancements

The Group Services Concurrent Logical Volume Manager daemon, `gsclvmd` is needed in HACMP environments to manage enhanced concurrent volume groups. In such HACMP configurations the LVM device driver of each cluster node logs errors for missing disks in an enhanced concurrent volume group and also logs quorum losses.

Beginning with AIX V6.1 additional error conditions which are specific to the `gsclvmd` daemon but not visible to the LVM device driver layer are captured by the AIX error log facility. If the error situation indicates that the LVM device driver state on the local node cannot stay in synchronization with the device driver state on the remote cluster nodes the relevant volume groups will be varied off.

The following error conditions are handled by either logging an error, vary-off the volume group, or both:

- ▶ Expulsion of remote nodes
- ▶ Expulsion from the Volume Group Status Area (VGSA) / Volume Group Descriptor Area (VGDA) group
- ▶ Voting after time limit expired on configuration change or status change
- ▶ Failed configuration change
- ▶ Loss of connectivity with group services
- ▶ Termination of the gscsvmd child daemon process
- ▶ Start gscsvmd when group services is not running
- ▶ Start gscsvmd without the proper environment variables

Seven new error log labels were implemented to support the enhanced error logging services for the gscsvmd daemon:

Table 4-12 *gscsvmd* error labels

Error label	Description	Probable cause
LVM_GS_RLEAVE	Remote node concurrent volume group failure detected	Remote node concurrent volume group forced offline
LVM_GS_LLEAVE	Local node concurrent volume group failure detected	Concurrent volume group forced offline
LVM_GS_CFGTIME	Vote time limit expired	Excessive load on the local node
LVM_GS_CFGFAIL	Concurrent volume group configuration change failed	Lost communication with remote nodes / Attempted invalid volume group configuration change
LVM_GS_CONNECTIVITY	Group services detected a failure	Unable to establish communication with cluster daemons / Concurrent volume group forced offline

Error label	Description	Probable cause
LVM_GS_CHILDGONE	Concurrent LVM daemon forced volume group offline	Unrecoverable event detected by concurrent LVM daemon / Lost communication with remote nodes / Lost quorum
LVM_GS_NOENV	Unable to start gscsvmd	Unable to establish communication with cluster daemons

The following describes which of the labels in Table 4-12 on page 185 will be used for each listed error condition, and whether or not the volume group needs to be forced offline.

Expulsion of remote node

In this case the volume group will remain online on the local node. The remote node that has been removed from the group is not capable of accessing data in the volume group or of writing any data to the volume group. Configuration changes and I/O operations can continue on the local node and any operational remote nodes. The local node and any remote nodes which remain in the group will each log LVM_GS_RLEAVE to indicate that a remote node has left the group. Meanwhile the remote node which left the group will log LVM_GS_LLEAVE if the situation permits it. If the remote node actually crashed or failed in such a way that the gscsvmd never got a chance to run then there will be error report entries describing the system outage rather than the volume groups outage.

Expulsion from the VGSA/VGDA group

In this case the volume group will be forced offline on the local node. Because communication with the remote nodes is no longer possible, remote nodes could change the partition mapping for the volume group without the local nodes knowledge. This means all reads and writes must be stopped on the local node, since there is no guarantee that a partition the local node is reading from or writing to hasn't been moved to a different location or, even worse, replaced by a partition from a different

location. The local node will log LVM_GS_LLEAVE and each remote node will log LVM_GS_RLEAVE.

Voting after time limit expired on configuration change or status change

In this case the volume group will not be forced offline on the local node or any remote nodes. The local node will log LVM_GS_CFGTIME as an informational message. The remote nodes will not log anything since they have no visibility to the attempted vote which was not counted (the remote nodes will see the default vote instead of the vote which was attempted).

Failed configuration change

The gscsvmd daemon error handling will not force the volume group offline on the local node or any remote nodes. All nodes will log LVM_GS_CFGFAIL as an informational message. The caller distributing configuration change commands to remote nodes is responsible to do whatever back out is necessary to ensure a consistent state after a failure occurred. Only the caller but not the gscsvmd child process knows what steps need to be taken before the volume group is forced offline.

Loss of connectivity with group services

In this case the volume group will be forced offline on all nodes and all nodes will log LVM_GS_CONNECTIVITY. Without running group services partitions cannot be marked stale, since there is no access to vote and obtain the concurrent VGSA lock to perform that operation.

Termination of the gscsvmd child daemon process

This condition will be considered a loss of quorum and the relevant volume group will be forced offline. All nodes will log LVM_GS_CHILDGONE.

Start gscsvmd when group services is not running

In this case no volume groups will be forced offline. The local node will log LVM_GS_NOENV.

Start gscsvmd without the proper environment variables set

In this case no volume groups will be forced offline. The local node will log LVM_GS_NOENV.

4.12 Paging Space Verification

The root cause analysis of problems which are related to data corruption can be very difficult, because the symptoms exhibited are likely to be totally unrelated to the code segment which induced the data corruption.

AIX V6.1 provides the new paging space verification feature to improve the first failure data capture (FFDC) capability in respect to paging space data corruption problems. Paging space verification ensures that the data read in from paging space matches the data that was written out. When a page is paged out a checksum will be computed on the data in the page and saved in a pinned array associated with the paging device. If and when it is paged back in, a new checksum will be computed on the data that is read in from paging space and compared to the value in the array. If they don't match, the kernel will log an error and halt if the error occurred in system memory, or send an exception to the application if it occurred in user memory.

If the paging space verification feature is enabled, the checksums are stored in dedicated 256 MB segments, one per paging device. Each segment contains an array of checksums, with one checksum for each 4 KB disk block on the corresponding device. The space for this array is allocated and pinned at swapon time. The handle for a device's segment along with other checksum data will be stored in a `pgdev_chksum_data` structure:

```
struct pgdev_chksum_data
{
char      pcd_chksum_size; /* bits in chksum, 0 == disabled*/
char      pcd_pad[7];      /* pad */
vmhandle_t pcd_vmh;        /* handle of chksum segment */
long      pcd_nblocks;     /* # of alloc'd chksums */
};
```

A pinned array of these structures of length equal to the maximum number of paging devices will be defined in the kernel. The memory of the array will be initialized to zero at boot. The fact that the checksums for a paging device must all fit in a single 256MB segment with one checksum per paging space block puts an upper limit on the maximum supportable paging space size.

Table 4-13 :Maximum paging space size

Checksum size	Checksums in 256 MB segment	Maximum paging space size
8 bit	2^{28}	2^{40} bytes (1 TB)
16 bit	2^{27}	2^{39} bytes (512 GB)

Checksum size	Checksums in 256 MB segment	Maximum paging space size
32 bit	2^{26}	2^{38} bytes (256 GB)

All of the listed sizes are larger than the 64 GB per device maximum paging space size limit in AIX V6.1. Checksums of larger than 32 bits are unnecessary, since the maximum checksum value for a single 4KB block is $2^{12} * 2^8 = 2^{20}$, and therefore easily fits within 32 bits.

The `/etc/swapspaces` file format supports two new optional fields per stanza to store attribute values related to the paging space verification feature:

- auto** The value of this attribute indicates whether the device should be swapped on automatically at boot. Only two values are allowed: yes or no
- checksum_size** The value of this attribute determines the size in bits of the checksums for the device. Four values can be specified: 0, 8, 16, 32.

If the `auto` field is not present in a stanza, it will default to yes; if the `checksum_size` field is not present, it will default to 0. If no stanza is present for a paging device, it will default to an `auto` field value of no and a `checksum_size` of 0. This maintains compatibility with existing `/etc/swapspaces` files. The following listing shows the content of the `/etc/swapspaces` file on a system which has the additional paging device (`paging00`) configured to use paging space verification with a checksum size of 16 bit:

```
# cat /etc/swapspaces
* /etc/swapspaces
*
* This file lists all the paging spaces that are automatically put into
* service on each system restart (the 'swapon -a' command executed from
* /etc/rc swaps on every device listed here).
*
* WARNING: Only paging space devices should be listed here.
*
* This file is modified by the chps, mkps and rmps commands and referenced
* by the lsps and swapon commands.

hd6:
    dev = /dev/hd6
    auto = yes
    checksum_size = 0

paging00:
    dev = /dev/paging00
```

```

auto = yes
checksum_size = 16

```

The **swapon -a** command will swapon any device with a stanza in `/etc/swapspaces` that either has no `auto` field or an `auto` field with `yes` as an assigned attribute.

Beginning with AIX V6.1 the **mkps** command supports the new option `-c`. Through the `-c` option the size of the checksum to use for the paging space verification is specified in bits. Valid options are 0 (checksum disabled), 8, 16, and 32. If `-c` is not specified it will default of 0. The **mkps** command always writes a stanza to the `/etc/swapspaces` file for a newly created paging device, setting its `auto` field according to the `-a` option (`yes / no`) and its `checksum_size` field according to the new `-c` option. The usage message of the **mkps** command is shown by the following listing:

```

# mkps -?
mkps: Not a recognized flag: ?
0517-050 Usage: mkps [-a] [-n] [-t lv] [-c ChksumSize] -s NumLPs Vgname Pvname
      Makes a paging space using logical volume.
mkps [-a] [-n] -t nfs hostname pathname
      Makes a paging space using an NFS server

```

The **chps** command has also be enhanced in AIX V6.1 to support a `-c` checksum size option. The new option allows to change the checksum size for existing paging devices. Note that the command will fail on swapped on paging devices, in order to prevent the inherent risks of changing the checksum size while pages are on disk and paging I/O is in progress. If system administrator wants to change the checksum size for a device only in the `/etc/swapspaces` file, so that it will be effective next time the device is swapped on, they can use `-c` option in combination with the option `-f`. This option is also new to AIX and will have no effect if the `-c` option is not used at the same time or if the paging space is not swapped on. The usage message of the **chps** command is shown by the following listing:

```

# chps -?
chps: Not a recognized flag: ?
0517-030 Usage: chps [-s NewLPs | -d DecrLPs] [-a {y|n}] [-c ChksumSize] [-f]
Psname
      Changes attributes of a paging space.

```

In AIX V6.1 the **lsp**s command will have the checksum size added to its output, displaying whatever value is in the device's `/etc/swapspaces` `checksum_size` field, or 0 if there is either no `/etc/swapspaces` stanza or no `checksum_size` field for the device:

```

# lsp -a
Page Space      Physical Volume  Volume Group Size %Used Active  Auto  Type Chksum
paging00       hdisk0          rootvg          512MB   1  yes  yes   lv   16

```

hd6	hdisk0	rootvg	512MB	3	yes	yes	1v	0
-----	--------	--------	-------	---	-----	-----	----	---



System management

In this chapter, the following system management enhancements are discussed:

- ▶ 5.1, “Web-based System Manager enhancements” on page 194
- ▶ 5.2, “AIX Print spooler redesign” on page 200
- ▶ 5.3, “Increase default size of argument area” on page 201
- ▶ 5.4, “Limit threads per process” on page 203
- ▶ 5.5, “Threading pthread default 1:1” on page 209
- ▶ 5.6, “RFC 2790 SNMP host resource groups” on page 209
- ▶ 5.7, “IBM Systems Director Console for AIX” on page 212
- ▶ 5.8, “VMM dynamic variable page size” on page 231

5.1 Web-based System Manager enhancements

In this section, major Web-based System Manager changes are discussed.

5.1.1 The mknfsproxy and rmnfsproxy interfaces

This section describes the Web-based System Manager dialogs that will be needed to take into account the new **mknfsproxy** and **rmnfsproxy** commands. Those changes were introduced after AIX V5.3 TL6.

Cache File Systems plug-in

Two new dialogs are introduced in the Cache File Systems plug-in. They are only visible if the `bos.nfs.cachefs` package is installed. These dialogs are accessible in the Cache File Systems sub-plug-in, from the File systems menu. The names of the new dialogs are Create Proxy Server and Remove Proxy Server (See Figure 5-1 on page 195).

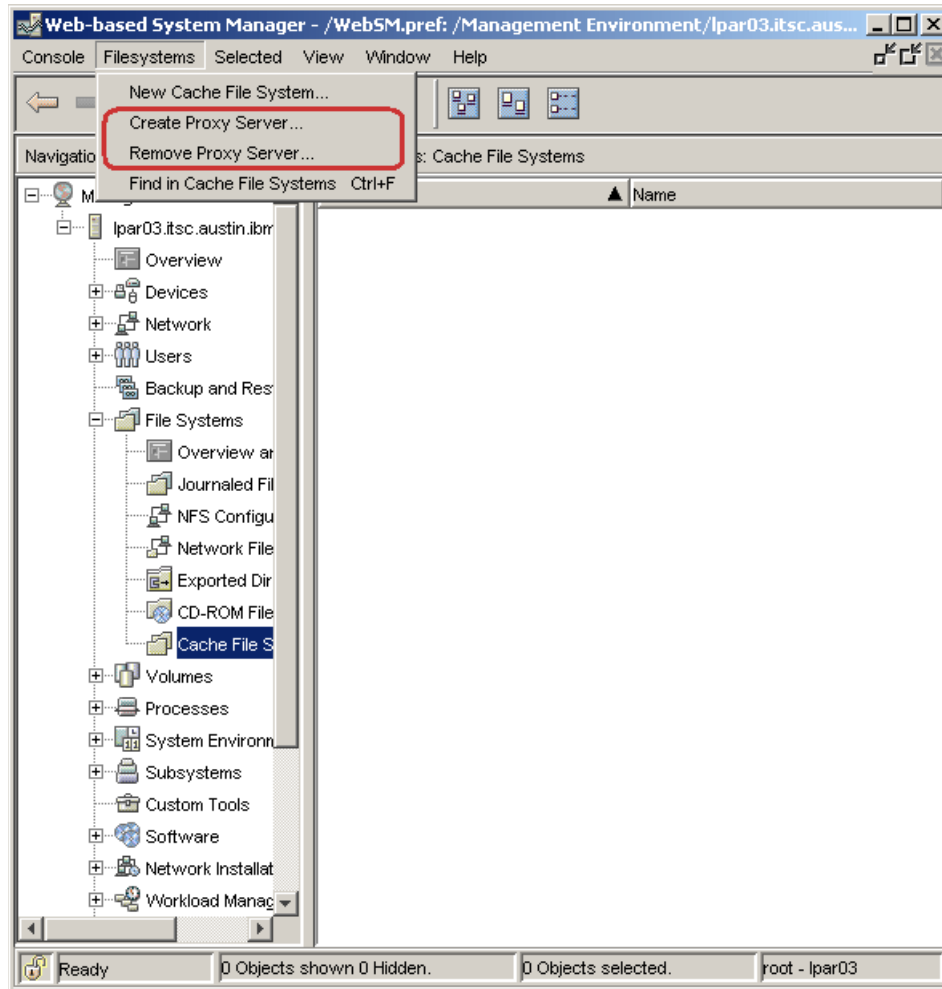

Figure 5-1 Proxy Server menus

These menu item launches the Create Proxy Server and Remove Proxy Server dialogs.

Create Proxy Server dialog

The Create Proxy Server dialog includes the following fields (See Table 5-1 on page 196):

Table 5-1 Create Proxy Server dialog

Name	Description
Path name of mount point ^{a)}	This is the directory where the cache file system will be mounted.
Path name of remote directory ^{a)}	This is the directory on the remote host that the cache file system will access.
Host where remote directory resides ^{a)}	This is the remote host that the cache file system will access.
Mount options	These are the NFS mount options which can be optionally applied to the NFS client mount.
Cache directory ^{a)}	This is the local JFS2 file system where the cache file system will store cached data and state
Cache directory options	These are the cache file system configuration options, in the form param=n
Export options ^{a)}	Specifies the NFS server export options for the created cache file system instance. If this is supplied, the created cache file system instance will also be NFS exported using the supplied options. If this option is not supplied, the created cache file system instance will be exported with the same NFS version specified by the mount options.
Whole file locking ^{b)}	When this check box is checked, it causes the cache file system instance to acquire a single lock from its associated NFS back-end that covers the entire file when any byte range locks are requested. When the count of byte range locks drops to 0 (zero), the lock on the back-end NFS server is released.
<p>a) This is a mandatory parameter. b) This is a check box. Default is unchecked.</p>	

The OK button is only enabled when all required fields are filled-in. The Cancel button dismisses the dialog (See Figure 5-2 on page 197).

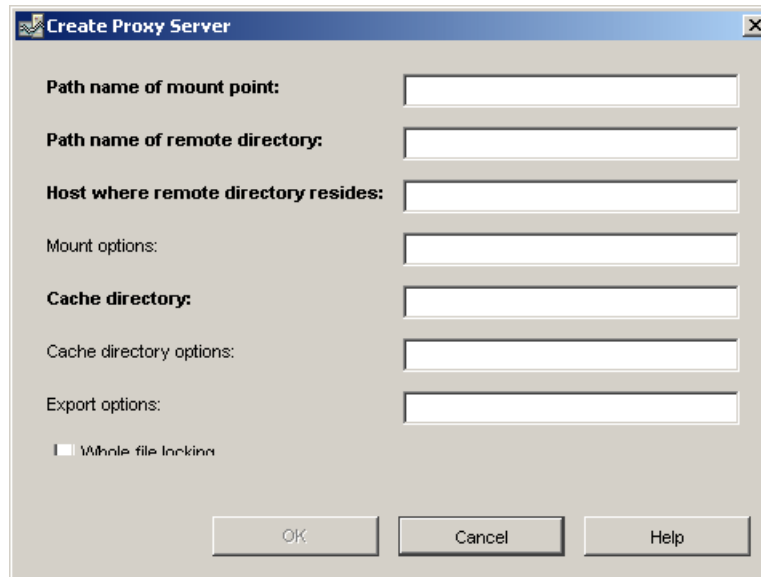

Figure 5-2 Create Proxy Server dialog

When the OK button is pressed, the dialog is dismissed and the following command is launched in a working dialog:

```
# /usr/sbin/mknfsproxy -L -c <cache directory> -d <mount point> [-o
<cache directory options>] -m [<mount options>] <remote host>:<remote
directory> [-e <export options>]
```

Remove Proxy Server dialog

The Remove Proxy Server dialog includes the fields in Table 5-2:

Table 5-2 Remove Proxy Server dialog

Name	Description
Path name of mount point ^{a)}	Specifies where the proxy-enabled cache file system instance to be removed was mounted.
a) This is a mandatory parameter.	

The OK button is only enabled when all required fields are filled-in. The Cancel button dismisses the dialog (See Figure 5-3 on page 198).

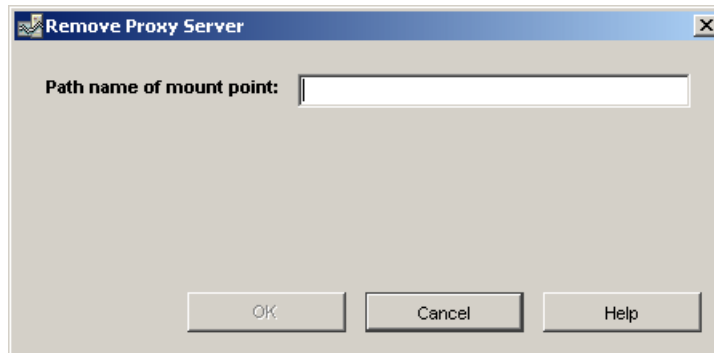

Figure 5-3 Remove Proxy Server dialog

When the OK button is pressed, the dialog is dismissed and the following command is launched in a working dialog:

```
# /usr/sbin/rmnpfsproxy <mount point>
```

5.1.2 Modified Web-based System Manager menus

Some of Web-based Systems Manager menus are changed because of performance tool changes. Web-based System Manager does not display restricted parameters by default for tunables. So, to display these parameters, an administrator has to set the Show restricted Parameters Menu on (See Figure 5-4 on page 199).

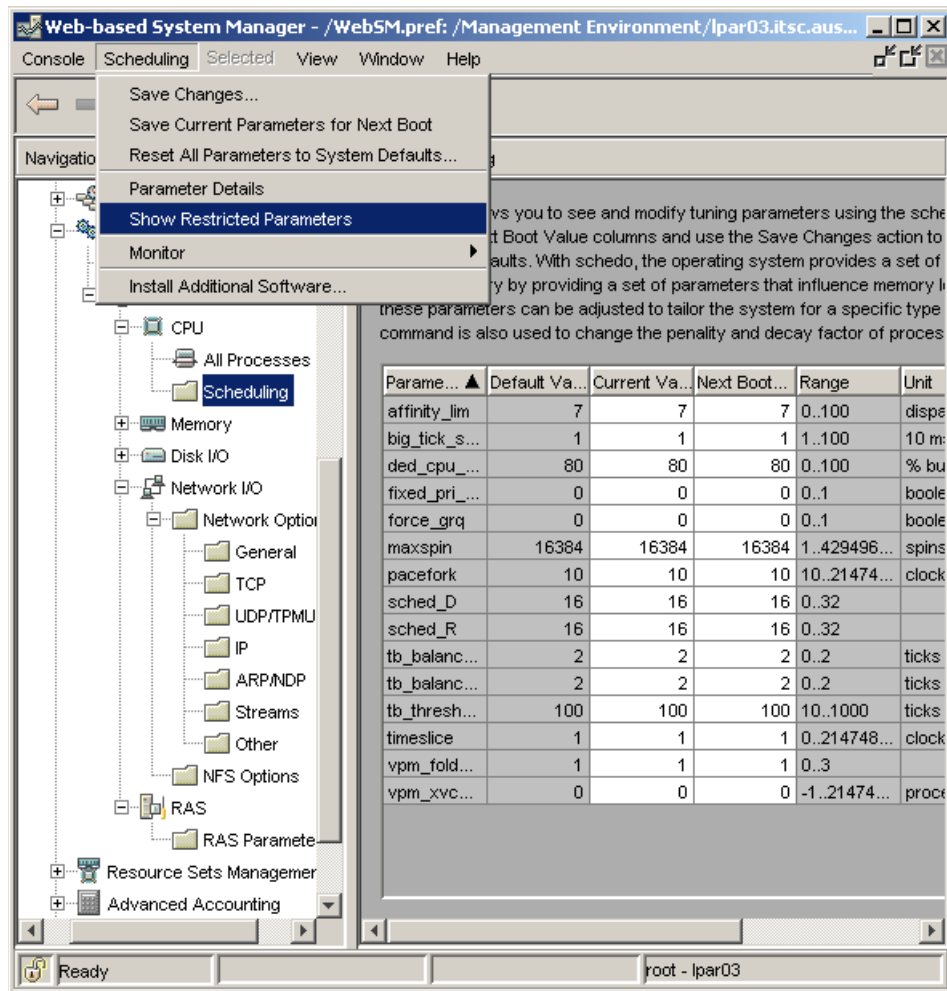

Figure 5-4 Example of Show Restricted Parameters

To access Show restricted Parameters, an administrator accesses **Performance** → **System Tuning** tasks, and then access each resources and sub tasks. After this, an administrator can show the menu from top menu. The menus can be shown when the following tasks are selected (See Table 5-3);

Table 5-3 list of resource names and task names and menus

Resources	Selection flow from Resources	Name of top menu
CPU	CPU → Scheduling	Scheduling

Resources	Selection flow from Resources	Name of top menu
Memory	Memory → Scheduling	Scheduling
	Memory → Virtual Memory	Memory
Disk I/O	Disk I/O → I/O Parameters	I/O
Network I/O	Network I/O → Network Options → General	General
	Network I/O → Network Options → TCP	TCP
	Network I/O → Network Options → UDP/TPMU	UDP/TPMU
	Network I/O → Network Options → IP	IP
	Network I/O → Network Options → ARP/NDP	ARP/NDP
	Network I/O → Network Options → Streams	Streams
	Network I/O → Network Options → Other	Other
	Network I/O → NFS Options	NFS
RAS	RAS Parameters	RAS

For the options to be displayed, see 6.2, “Restricted tunables” on page 241.

5.2 AIX Print spooler redesign

Today, the AIX printing environment has evolved to be an enterprise ready spooling system capable of handling thousands of print queues and print jobs. But there have been no significant changes after initial spooler design of AIX was introduced. So, the addition and deletion of print queues currently can take a significant amount of time on systems that have thousands or tens of thousands of queues. To improve the performance of the overall printing subsystem, AIX Print spooler design is changed in AIX V6.1.

5.2.1 Spooler command changes

The file `/etc/qconfig` holds the names and attributes of all the queues and devices on the system. There is some redundancy built into the way this file is read and handled by different programs.

Upon startup, The `qdaemon` daemon reads `/etc/qconfig` and generates a file named `/etc/qconfig.bin` containing complete queue/device information and

returns a pointer to a list of queues to qdaemon. This list of queues is kept up to date throughout the life of qdaemon.

Other utilities such as `mkque`, `mkquedev`, `lsque`, `lsquedev`, `rmque`, and `rmquedev` which get called when a print queue is added, listed or removed respectively, also need to know what is in `/etc/qconfig`.

This change removes redundancy by exploiting the information that is already in `/etc/qconfig.bin`. Since that information is the most up-to-date state of what is in `/etc/qconfig`, it is simple enough to read `/etc/qconfig.bin` from `mkque`, `mkquedev`, `lsque`, `lsquedev`, `rmque`, and `rmquedev`.

5.3 Increase default size of argument area

The default argument area size used is increased in AIX V6.1. Previous to AIX V6.1, AIX has a relatively small default argument space (24 KB), which causes applications to fail when they are passed large set of command line arguments. Generally, when applications are passed with wild card characters, such as an asterisk, the argument size is indefinite and the current default of 24 KB is not sufficient to handle such requirements. At times, it can result in application core dump or memory failures. From AIX V6.1 onwards, the argument area is a configured parameter but the default has never changed before. Hence, there is a need to increase the default argument size currently supported in AIX. The configurable range for the argument space is 24 KB to 4 MB.

Prior to AIX V6.1, the #defined values `ARG_MAX` and `NCARGS`, whose current value is 24576 (24 KB) are used.

- ▶ `ARG_MAX` value in `limits.h` file (it reflects static size)
- ▶ Return value from `sysconf(_SC_ARG_MAX)` (runtime value)

The argument size requirement generally depends on the amount of available memory. The actual value supported can be obtained using `sysconf()`, as shown above.

These `NCARGS` parameters are stored in the ODM stanza `PdAt`. The default value for `ncargs` is 6 blocks. As each block size is 4 KB, the default argument area is $6 * 4$ KB, or 24 KB. If the size of the arguments exceeds the size of the argument area, the command does not execute and exits with an error message `arg list too long`.

The existing ODM stanza for `NCARGS` is:

```
PdAt:
```

```

uniquetype = "sys/node/chrp"
attribute = "ncargs"
deflt = "6"
values = "6-1024,1"
width = ""
type = "R"
generic = "DU"
rep = "nr"
nls_index = 71

```

To change the default value to 1 MB, default field is updated to 256. The new ODM stanza is as below:

```

PdAt:
  uniquetype = "sys/node/chrp"
  attribute = "ncargs"
  deflt = "256"
  values = "6-1024,1"
  width = ""
  type = "R"
  generic = "DU"
  rep = "nr"
  nls_index = 71

```

Apart from this, the ARG_MAX value in the file limits.h is increased from 24576 (6 * 4 KB) to 1048576 (256 * 4 KB).

Note: Do not use ARG_MAX, if your application wants to know runtime maximum argument size. Use `sysconf(_SRC_MAX_ARGS)`. See `/usr/sys/limits.h`.

You can check the current setting with the `lsattr` command.

```

(AIX V5.3)
# lsattr -R -l sys0 -a ncargs
6...1024(+1)
$ lsattr -El sys0 -a ncargs
ncargs 6 ARG/ENV list size in 4K byte blocks True

```

```

(AIX V6.1)
# lsattr -R -l sys0 -a ncargs
256...1024(+1)

$ lsattr -El sys0 -a ncargs
ncargs 256 ARG/ENV list size in 4K byte blocks True

```

The following steps show how things are done on AIX V6.1. The following code is a sample for checking runtime ncargs;

```
$ cat sysconf.c
#include <stdio.h>
#include <unistd.h>

void main(){

long num_args=0;

num_args=sysconf ( _SC_ARG_MAX );

printf("Number of Argument is %d\n", num_args);

}
```

The following compiles and runs this sample program.

```
$ /usr/vac/bin/cc -o sysconf sysconf.c
$ ./sysconf
Number of Argument is 1048576
```

Tip: If you change ncargs from 256 to 512, runtime values are dynamically changed as follows;

```
$ su
root's Password:
# chdev -l sys0 -a ncargs=512
sys0 changed
# exit
$ ./sysconf
Number of Argument is 2097152
```

5.4 Limit threads per process

AIX V6.1 provides a mechanism to limit the number of threads per process and the number of processes per user. Previous versions of AIX do not offer any direct mechanism for controlling these limits. Although the existing implementation is a traditional one, it has several limitations. The foremost is that a runaway or errant process can consume system resources by creating an excessive number of threads or processes, thereby reducing available system resources for other processes and users. At the user level, the existing

implementation is also restrictive in that it does not allow users the fine-grained control over their own resource consumption and control that is in demand in certain critical markets. In this section, we discuss implementations, configurations, and considerations for this function.

5.4.1 Background

This feature originated in the High Performance Computing (HPC) sector, where a number of clients have desired this functionality. These clients often encounter the scenario where some of their researchers create programs that consume an high percentage of the available system resources. In the extreme case, these programs can greatly reduce system performance and thereby prevent other users and processes from making any progress. A way of handling this situation is required which provides greater user and process isolation. This feature provides users and system administrators the ability to set limits on the number of threads a process can create and on the number of processes that a user can create. Upon trying to create more threads or processes than allowed, the creation simply fails. The programmer is now required to properly handle thread and process creation failure within a program to limit using excessive resource.

5.4.2 Implemented mechanisms

The following mechanisms are introduced:

- ▶ Limiting the number of threads per process and the number of processes per user.
- ▶ Configuring the limits on the number of threads and processes both statically and dynamically.

5.4.3 Implemented functions

The following functions are also provided:

- ▶ Provide mechanism for setting, getting, monitoring, and managing the limits imposed on the number of threads per process and the number of processes per user by extending the existing resource limit framework.
- ▶ Support limiting the number of threads per process in both M:N and 1:1 thread modes. In M:N mode, the user space pthread library enforces the thread limit. In 1:1 mode, the kernel enforces the thread limit.
- ▶ Update kernel debugger output as necessary to display the new resource limits.

- ▶ To support availability efforts, when kernel thread creation fails or process creation fails as a result of hitting the limits, a trace entry is created.

5.4.4 Implemented changes

To support this function to limit values, system calls and defined values are changed.

Defined values

This function provides to be changed the followings:

- ▶ RLIM_NLIMITS. In order to limit the number of threads per process, the existing functionality of the resource limit infrastructure is extended. Specifically, the macro defining the number of limits in `sys/resource.h` is increased from 8 to 10:

```
#define RLIM_NLIMITS          10
```

- ▶ To support backwards compatibility, a new value is defined to keep track of how many rlimits there were prior to this modification. This is used for various functions, such as `getprocs`, which rely on the size of the requested structure to determine how to pack the data for the response to the caller. The new value is defined in `sys/proc_compat.h` as follows:

```
#define RLIM_NLIMITS_53      8
```

- ▶ To introduce the actual new limits, the new values are defined in `sys/resource.h` as follows:

```
#define RLIMIT_THREADS       8
#define RLIMIT_NPROC         9
```

System calls

The following system calls are changed:

- ▶ `getrlimit` / `getrlimit64` / `setrlimit` / `setrlimit64`.

There are no direct impact or modifications to the error codes returned from these functions. As with other resource limits, the limit on the number of threads per process also is enforced for kernel processes. Thus, the `getrlimit()` and `setrlimit()` services are supported for use by kernel processes as well as user processes. For more detail, you can see `RLIMIT_THREADS` and `RLIMIT_NPROC` in Parameters for `getrlimit` subroutine online manuals.

- ▶ `pthread_create`.

The previous and current behavior of `pthread_create` is to return `EAGAIN` if `WLM` is enabled and the limit on the number of threads for a class has been

exceeded. On AIX V6.1, `pthread_create` will also return `EAGAIN` if an attempt to create a thread fails as a result of exceeding the thread limit.

5.4.5 How to configure these limits

All configuration of these limits follow exactly the same manner as for all other existing resource limits. These resource limits can be set both statically and dynamically, as follows:

► Static Configuration

As with the other user attributes, `RLIMIT_THREADS` and `RLIMIT_NPROC` receive default initialization from the contents of `/etc/security/limits`. If these limits are not defined in this file, the existing AIX default behavior of having no limits on the number of threads per process and processes per user are applied. This is done by simply initializing with the unlimited value.

Note: As a special case, consider a migration installation - such as upgrading from AIX V5.3 to V6.1. In this case, there is no entry in the limits file for the limit on the number of threads per process or processes per user. If an entry is not found in the limits file, the limit defaults back to unlimited. Thus, in this special case with a migration installation, all users are given unlimited as their limits on the number of threads per process and processes per user. Since this is the existing behavior in AIX V5.3, there is no change from the expected behavior for these upgrading users. Thus, no special configuration is required of an upgrading user if they want the existing behavior to persist through the upgrade.

► Dynamic Configuration

In order to support dynamic configuration, the `ulimit` command and the built-in shell commands are changed, as described in the following.

User space commands and shell modifications

The `/usr/bin/ulimit` command and the built-in shell `ulimit` command are modified in order to allow setting and getting the new resource limit. As a result, The option `-r` and `-u` is newly added to `ulimit` command. For static configuration, `threads`, `threads_hard` option are also introduced to `chuser`, `mkuser` command.

Static configuration method

The administrator of a system can change the limit using the `chuser` command statically as follows:

```
# chuser threads=20 threads_hard=30 nobu
```

User nobu can execute 20 threads per process as soft limit, and 30 threads per process as hard limit.

Dynamic configuration methods

A user may dynamically change their limit using the `ulimit` command as follows:

Changing number of threads per process

The following example performs a change of the number of threads per process.

```
$ ulimit -a
time(seconds)      unlimited
file(blocks)       2097151
data(kbytes)       131072
stack(kbytes)      32768
memory(kbytes)     32768
coredump(blocks)   2097151
nofiles(descriptors) 2000
threads(per process) unlimited
processes(per user) unlimited
$ ulimit -r 20 <- Changing number of threads per process
$ ulimit -a
time(seconds)      unlimited
file(blocks)       2097151
data(kbytes)       131072
stack(kbytes)      32768
memory(kbytes)     32768
coredump(blocks)   2097151
nofiles(descriptors) 2000
threads(per process) 20
processes(per user) unlimited
```

Changing number of process per user

The following example shows a change of the number of processes per user.

```
$ ulimit -a
time(seconds)      unlimited
file(blocks)       2097151
data(kbytes)       131072
stack(kbytes)      32768
memory(kbytes)     32768
coredump(blocks)   2097151
nofiles(descriptors) 2000
threads(per process) unlimited
processes(per user) unlimited
$ ulimit -u 20 <- Changing number of process per user
```

```
$ ulimit -a
time(seconds)      unlimited
file(blocks)       2097151
data(kbytes)       131072
stack(kbytes)      32768
memory(kbytes)     32768
coredump(blocks)   2097151
nofiles(descriptors) 2000
threads(per process) 20
processes(per user) 20
$
```

If you want to change the hard limit, you can specify -H option.

Considerations

In this section, we discuss considerations for when a user changes limits.

► Settable values

The range of allowable values for both new limits are [1,unlimited].

Specifically, a limit of 0 is unsupported since a user must be able to create at least one process and each process must have at least one thread. The value of unlimited is the existing default behavior in AIX - namely, no limitations are imposed on the number of threads per process or the number of processes per user.

► Reducing current values

Attempting to dynamically reduce the limits below the current number of running threads or processes is supported, with the following semantics. All future attempts to create additional threads while the thread limit is exceeded fails. Similarly, all future process creations while the process limit is exceeded also fails. The rationale for allowing the limits to be lowered below the number of currently running threads or processes is the following two:

- First, it allows a user to set the desired limit and thereby prevent all future thread or process creations. A well-behaving application could potentially query its limits, and take efforts to reduce its thread or process count in order to be more resource conscious. If this were not allowed, the current number of threads in a greedy process or the number of processes a user has running would be an unwanted, artificial lower bound on the limit.
- Secondly, this implementation is the most consistent with other resource limit behavior. For example, a user can lower their file size resource limit below the size of one of their existing, larger files that have already been created. Future attempts to create a file larger than this limit then correctly fail.

5.5 Threading pthread default 1:1

This section introduces changing the default behavior of the pthreads library. After AIX V4.3.1, the contention scope is m:n (AIXTHREAD_MNRATIO) or process scope (AIXTHREAD_SCOPE=P) by default. But to run middleware (for example, Web Sphere MQ, Tivoli Storage Manager, and so on) and user applications (especially Java™ application) appropriately, the default behavior is often changed.

AIX V6.1 changes this behavior to 1:1 or system scope (AIXTHREAD_SCOPE=S) by default. If AIXTHREAD_SCOPE is set as system scope (S), AIXTHRED_MNRATIO is disabled and it works as 1:1. The following table (Table 5-4) shows default values;

Table 5-4 AIX Thread environment valuables

Environment valuables	AIX V5.3 and before (Default)	AIX V6.1 (Default)
AIXTHREAD_SCOPE	P	S
AIXTHREAD_MNRATIO	8:1	Disabled (act as 1:1)

5.6 RFC 2790 SNMP host resource groups

SNMP-DPI-2 (Simple Network Management Protocol with Distributed Program Interface Version 2) is an application layer protocol that enables administrators the ability to control and monitor managed devices in a network.

The AIX implementation of SNMP-DPI-2 consists of 3 major components:

- ▶ SNMP network management station
- ▶ SNMP agent
- ▶ SNMP sub-agent

An administrator interacts with a managed object through a network management station; the station communicates by using SNMP requests through UDP ports 161 and 162. The managed object has a centralized agent that communicates with the management station and translates SNMP requests into DPI® operations for distributed sub-agents using dpiPortForTCP, which is a port specified by the DPI API framework. RFC 1592 details the SNMP-DPI-2 interface.

Each sub-agent fulfills DPI operations using back-end hosts controlling Management Information Bases (MIBs). A particular sub-agent, host resources (hr), is specified in RFC 1514 (obsoleted by RFC 2790). It includes hosts for various information groups such as Systems, Device, File Storage, Running Software, Running Software Performance, and Installed Software. Host resource information is stored on MIBs as variables and tables in a sub-tree structure and conforms to the Structure of Management Information (SMI) specification in RFC 1155. Most of the information required by hosts is stored in AIX Object Data Manager (ODM) classes.

AIX V6.1 implements two additional SNMP-DPI-2 hosts for the Running Software (hrSWRun), and Running Software Performance (hrSWRunPerf) information groups in compliance with RFC 2790.

The structure of the host resource sub-agent and its hosts is of a sub-tree. The following listing illustrates the sub-agent structure down by one nesting level, with absolute SMI object identifiers in parentheses:

- host (1.3.6.1.2.1.25)
 - hrSystem (1.3.6.1.2.1.25.1)
 - hrStorage (1.3.6.1.2.1.25.2)
 - hrDevice (1.3.6.1.2.1.25.3)
 - hrSWRun (1.3.6.1.2.1.25.4)
 - hrSWRunPerf (1.3.6.1.2.1.25.5)
 - hrSWInstalled (1.3.6.1.2.1.25.6)

All six MIB variables listed below the host resource sub-agent identify an individual sub-tree which is managed by the AIX hostmibd daemon. You can use the `snmpinfo -m dump` command to explore the full structure of each of the six host resource groups.

5.6.1 Running Software information group

The Running Software group host MIB stores information for software that is running or loaded into memory. This includes the operating system, device drivers, and applications. Running Software information is stored in host MIB variables. The MIB table, a special MIB variable, stores an entry for each piece of software running on the managed object. Each entry contains management information for the software such as the name, runtime parameters, type, and status. All MIB objects have unique OIDs (Object Identifier) that are assigned based on nesting levels on the SNMP-DPI-2 host resource sub-trees. OIDs for host MIBs are specified in RFC 2790. The OID for the Running Software group host is {host 4}. The conceptual name of the Running Software group host is hrSWRun.

The MIB sub-tree is organized such that host MIB variables are on the host MIB root level, tables are on the root level, the entry is a sub-tree of tables, and entry fields are sub-trees of entries. The following listing illustrates the sub-tree for hrSWRun:

- host (1.3.6.1.2.1.25)
 - hrSystem (1.3.6.1.2.1.25.1)
 - hrStorage (1.3.6.1.2.1.25.2)
 - hrDevice (1.3.6.1.2.1.25.3)
 - hrSWRun (1.3.6.1.2.1.25.4)
 - hrSWOSIndex (1.3.6.1.2.1.25.4.1)
 - hrSWRunTable (1.3.6.1.2.1.25.4.2)
 - hrSWRunEntry (1.3.6.1.2.1.25.4.2.1)
 - hrSWRunIndex (1.3.6.1.2.1.25.4.2.1.1)
 - hrSWRunName (1.3.6.1.2.1.25.4.2.1.2)
 - hrSWRunID (1.3.6.1.2.1.25.4.2.1.3)
 - hrSWRunPath (1.3.6.1.2.1.25.4.2.1.4)
 - hrSWRunParameters (1.3.6.1.2.1.25.4.2.1.5)
 - hrSWRunType (1.3.6.1.2.1.25.4.2.1.6)
 - hrSWRunStatus (1.3.6.1.2.1.25.4.2.1.7)
 - hrSWRunPerf (1.3.6.1.2.1.25.5)
 - hrSWInstalled (1.3.6.1.2.1.25.6)

5.6.2 Running Software Performance information group

Process performance information is managed by the Running Software Performance group host. The Running Software Performance host uses a MIB table to store statistics such as CPU usage and allocated memory for each piece of software in memory. The OID for the Running Software Performance group host is {host 5}. The conceptual name is hrSWRunPerf. This host is closely coupled with the hrSWRun host.

The hrSWRunPerf sub-tree is arranged similarly to the hrSWRun sub-tree, with the table on the root level, entries as a sub-tree of table, and entry fields as sub-trees of entries. The following listing depicts the structure:

- host (1.3.6.1.2.1.25)
 - hrSystem (1.3.6.1.2.1.25.1)
 - hrStorage (1.3.6.1.2.1.25.2)
 - hrDevice (1.3.6.1.2.1.25.3)
 - hrSWRun (1.3.6.1.2.1.25.4)
 - hrSWRunPerf (1.3.6.1.2.1.25.5)
 - hrSWRunPerfTable (1.3.6.1.2.1.25.5.1)
 - hrSWRunPerfEntry (1.3.6.1.2.1.25.5.1.1)
 - hrSWRunPerfCPU (1.3.6.1.2.1.25.5.1.1.1)

- hrSWRunPerfMem (1.3.6.1.2.1.25.5.1.1.2)
- hrSWInstalled (1.3.6.1.2.1.25.6)

5.7 IBM Systems Director Console for AIX

The IBM Systems Director Console for AIX is a new management tool (**pconsole**) for AIX V6.1 that:

- ▶ Enables converged consoles on AIX
- ▶ Enables AIX management in the converged console
- ▶ Works with a Workload Partition environment.

This management tool is based on the following components;

- ▶ Lightweight Infrastructure 7.1

The Lightweight Infrastructure (LWI) is a small footprint, simple to configure, secure infrastructure for hosting Web applications, web services, and other application related components. The LWI is based on Open Services Gateway Initiative (OSGi) architecture and is derived from WebSphere® Everyplace® Deployment 6.0 (WED). The LWI is comprised of the base OSGi/Eclipse service platform plus additional custom components and bundles which support web applications, web services, and the building of components.

- ▶ ISC Standard Edition 7.1

The primary goal of the Integrated Solutions Console (ISC) is to provide a single platform that can host all the Web-based administrative console functions built by IBM server, software, and storage products in a manner that allows customers to manage solutions rather than specific IBM products.

5.7.1 Packaging and requirements

The IBM Systems Director Console for AIX is automatically installed after AIX V6.1 installation is completed. You can see the following filesets installed;

```
sysmgt.pconsole.rte  
sysmgt.pconsole.apps.wdcm  
sysmgt.pconsole.apps.websm  
sysmgt.pconsole.apps.wrbac  
sysmgt.pconsole.apps.wsmi t  
lwi.runtime
```

It requires 512 MB (default) heap memory. You can customize of heap size. See 5.7.9, “Configuration and management” on page 231.

When the network configuration is finished, you can access it using Web browser and enter your user name and password those are configured target system.

URL

`http://<hostname>:5335/ibm/console`

`https://<hostname>:5336/ibm.console`

Supported browsers are Internet Explorer Version 7, and Mozilla Firefox.

Figure 5-5 on page 214, shows this tool.

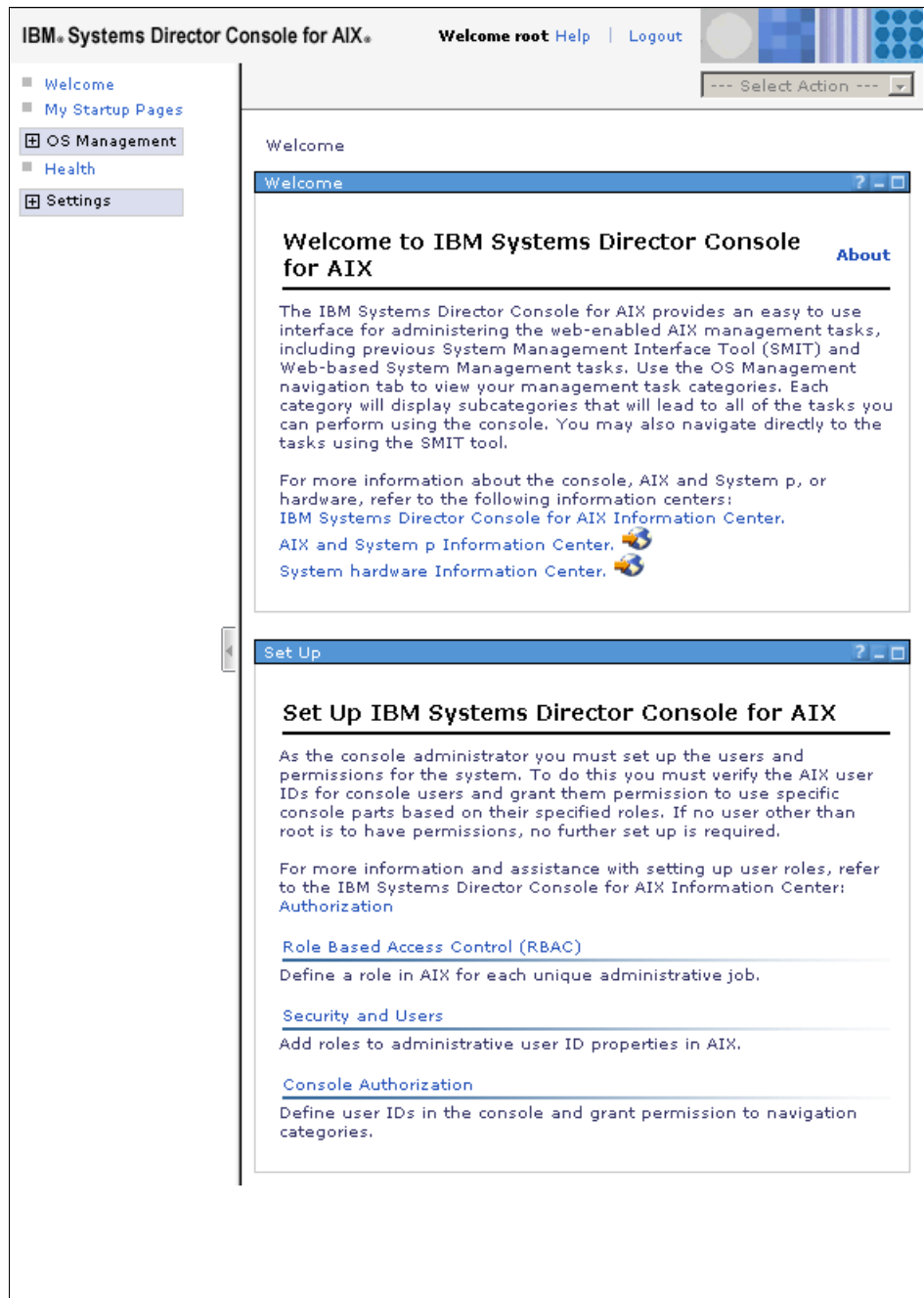

Figure 5-5 IBM Systems Director Console for AIX Welcome page

5.7.2 The Layout of IBM Systems Director Console

IBM Systems Director Console for AIX is consists of the following contents;

- ▶ Console toolbar
- ▶ Navigation area
- ▶ Work area

These components are discussed in the following.

Console tool bar across top

Console toolbar (Figure 5-6) provides the following functions;

- ▶ User name (for example. “Welcome root”)
- ▶ Help
 - Infocenter window
 - ISC Help
 - IBM Systems Director Console for AIX Administrators Guide
- ▶ Logout



Figure 5-6 Console toolbar

Navigation area

The navigation area (Figure 5-7 on page 216) is a guide to tasks. In the area, the following task categories can be expanded or collapsed (For example, OS Management).

- ▶ Task categories
 - Welcome
 - My Startup Pages
 - OS Management (AIX settings)
 - Health
 - Settings (Console settings)

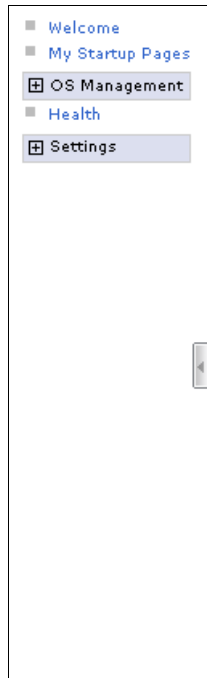

Figure 5-7 Navigation area

Work area

In the work area (Figure 5-8), the administrator can open several pages, and change from page A to B by page bar.

- ▶ Page bar
 - Multiple pages/tabs
 - Action Selection List (Close, Open, Refresh, add to Startup Pages)

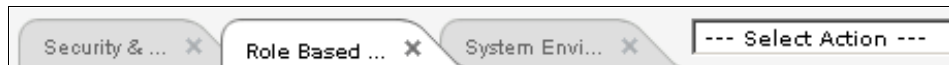

Figure 5-8 Page bar

- ▶ Portlets
 - Portlets are shown in Figure 5-9 on page 217. Administrators can operate any tasks on the portlets.

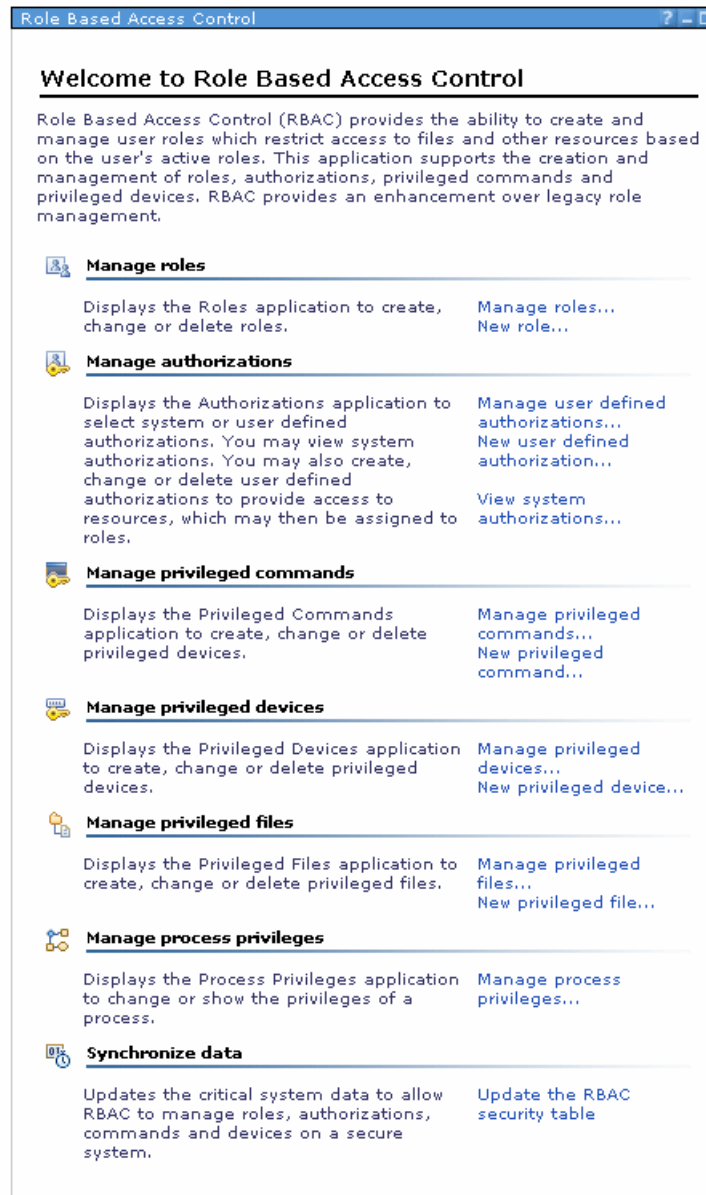

Figure 5-9 Portlets

5.7.3 My Start Pages (customization)

You can customize startup pages.

- ▶ Define which applications to start upon login.
- ▶ Managed with the **My Startup Pages** application

Each user can create individual customizations.

You can choose these functions from OS Management menu. If you want to add functions to your start pages, use the following instructions;

1. Open page that you want to add My startup pages
2. Select **Action Selection List** → **Add to My Startup pages**

5.7.4 Health Summary plug-in

The Health Summary plug-in adds new vsm information to IBM Systems Director for AIX. It provides multiple portlets as follows;

Summary	The summary portlet provides system configuration, network configuration, and paging space configuration.
Metrics	Metrics portlet displays physical memory, virtual memory paging space CPU (total, each of CPUs) utilization. It provides not only values and also chart.
Top Processes	You can see processes that uses highest CPU utilization. It shows process id, parent process ID, CPU utilization, CPU time, and user ID.
File systems	It shows list of mounted file systems. You can see mount point, size, and utilization.

5.7.5 OS management

If you manage a system, you can use the tasks provided in Table 5-5.

Table 5-5 OS management tasks

Tasks	Description
Security & Users	Security and Users provides you with tools you can use to perform common tasks related to user authentication and access. Use the task links on the right to quickly jump to those tasks.

Tasks	Description
Role Based Access Control	Role Based Access Control (RBAC) provides the ability to create and manage user roles which restrict access to files and other resources based on the user's active roles. This application supports the creation and management of roles, authorizations, privileged commands and privileged devices. RBAC provides an enhancement over previous role management.
Manage the Cryptography Standard	You can determine the standards here.
System Environments	System Environments provides you with tools you can use to perform common tasks related to system characteristics. Use the task links on the right to quickly jump to those tasks.
Print Spooling	Print Spooling provides you with tools you can use to perform common tasks related to the spooler subsystem, which is the queuing system for printing. Use the task links on the right to quickly jump to those tasks.
Communications Applications and Services	Communications Applications and Services provides you with tools you can use to perform common tasks related to communication applications. Use the task links on the right to quickly jump to those tasks.
System Storage™ Management	System Storage Management provides you with tools you can use to perform common tasks related to physical and logical volumes, file systems, directories, files, and backups. Use the task links on the right to quickly jump to those tasks.
Processes & Subsystems	Processes and Subsystem provides you with tools you can use to perform common tasks related to managing the system processes, subsystems, and subservers. Use the task links on the right to quickly jump to those tasks.

Tasks	Description
Problem Determination	Problem Determination provides you with tools you can use to perform common tasks related to problem identification and resolution. Use the task links on the right to quickly jump to those tasks.
Performance & Resource Scheduling	Performance and Resource Scheduling provides you with tools you can use to perform common tasks related to the performance, job scheduling, and workload. Use the task links on the right to quickly jump to those tasks.
Devices	Devices provides you with tools you can use to perform common tasks related to physical devices. Use the task links on the right to quickly jump to those tasks.
Advanced Accounting	Advanced Accounting provides you with tools you can use to perform common tasks related to the collection and recording of job related information. Use the task links on the right to quickly jump to those tasks.
Software Installation and Maintenance	Software Installation and Maintenance provides you with tools you can use to perform common tasks related to installing new software, or managing previously installed software. Use the task links on the right to quickly jump to those tasks.
Software License Management	Software Installation and Maintenance provides you with tools you can use to perform common tasks related to installing new software, or managing previously installed software. Use the task links on the right to quickly jump to those tasks.
Workload Partition Administration	Workload Partition Administration provides you with tools you can use to perform common tasks related to the workload partitions (WPAR). Use the task links on the right to quickly jump to those tasks.

Tasks	Description
Cluster Systems Management	Cluster Systems Management (CSM) provides you with tools you can use to perform common tasks related to setting up and maintaining a cluster of nodes that run the AIX or Linux operating system. Use the task links on the right to quickly jump to those tasks.
Distributed Command Execution Manager	Distributed Command Execution Manager (DCEM) provides you with tools to create and execute commands across a group of machines on a network.
System Management Interface Tool (SMIT)	SMIT menu is provided.
Web-based System Manager	Web-based System Manager Menu is provided.

Most of tasks are same with tasks that SMIT provides. In this section, we focus on the following newly introduced tasks;

- ▶ Distributed Command Execution Manager (DCEM)
- ▶ System Management Interface Tool (SMIT)
- ▶ Web-based System Manager

These tasks are discussed in the following.

Distributed Command Execution Manager

Distributed Command Execution Manager (DCEM) provides an interface to the distributed shell (dsh). The distributed shell is a command targeting a cluster of remote systems. DCEM can save command specifications. Perl script is created by the command specification for reuse. DCEM supports **dsh**, CSM, and NIM hosts and groups. It also supports **rsh** and **ssh** authentication.

The following figures are example to execute HelloWorld with **rsh**. Table 5-6 provides the various incantations.

1. Select Execution. And input the following area, as in Figure 5-10 on page 222:

Table 5-6 Distributed command execution manager helloworld example

Input Items	Description		Example
Name	Job Name	optional	HelloWorld

Input Items	Description		Example
Description (optional)	Description for Job	optional	
Path (Default \$PATH)	PATH		\$PATH
Default User (Default Login user)	User to execute command		root
Command	Command to be executed	mandatory	/usr/bin/echo helloworld

Distributed Command Execution Manager

Welcome > Distributed Command Execution

Distributed Command Execution

Specify the command attributes, targets and options for this distributed command. You may also specify a name if you would like to refer to this command at a later date.

Name:

Description:

Command Specification **Target Specification** **Options**

Path:

Default User:

* Command:

* Required Field

Figure 5-10 Distributed Command Execution Manager menu

2. Select Target Specification tab and input the following as in Figure 5-11 on page 224.

Table 5-7 Target specification input

		Description	Examples
DSH Targets	DSH Hosts	Target system IP address or hostname	n.n.n.n
	DSH Groups		-
CSM Targets	CSM Hosts	Target system IP address or hostname	-
	CSM Groups		-
NIM Targets	NIM Hosts	Target system IP address or hostname	-
	NIM Groups		-

You can select one of items.

Distributed Command Execution Manager

[Welcome](#) > Distributed Command Execution

Distributed Command Execution

Specify the command attributes, targets and options for this distributed command. You may also specify a name if you would like to refer to this command at a later date.

Name:

Description:

Command Specification **Target Specification** **Options**

Specify the targets by using the browse buttons or directly entering the targets in the input fields below. You may run the specified command on any combination of valid DSH, CSM, or NIM Hosts and Groups.

DSH Targets:
 DSH Hosts:
 DSH Groups:

CSM Targets:
 CSM Hosts:
 CSM Groups:

NIM Targets:
 NIM Hosts:
 NIM Groups:

* Required Field

Figure 5-11 Target Specification Tab

3. Select Option Tabs and input the following area (Figure 5-12 on page 225):

Distributed Command Execution Manager

[Welcome](#) > Distributed Command Execution

Distributed Command Execution

Specify the command attributes, targets and options for this distributed command. You may also specify a name if you would like to refer to this command at a later date.

Name:

Description:

Command Specification **Target Specification** **Options**

Specify any additional options for the specified command and targets.

Verify targets are responding before running the command.

Remote Shell:

* Required Field

Figure 5-12 Option Tab

4. When the input is correctly entered, you can execute by click the **Run** button.

SMIT

IBM Systems Director Console for AIX provides a Web interface for SMIT stanzas. The interface is dynamically generated. Classic SMIT supports all stanzas defined in the ODM.

Through the manager, SMIT appears as in Figure 5-13 on page 226.



Figure 5-13 System Management Interface Tools Menu

Web-based System Manager

IBM Systems Director Console for AIX only provides interface to execute Web-based System Manager (`wsm`). To use Web-based System Manager, you have to configure server and client for Web-based System Manager as follows;

- ▶ Install and Configure HTTPServer on server system
- ▶ Install and Configure Web-based System Manager on server
- ▶ Download and install Java webstart client on client system

After configuration is finished, you can execute `wsm`. And it works independently from IBM Systems Director Console for AIX.

5.7.6 Managing Workload Partitions

By default, the `pconsole` command is not installed with a Workload Partition system. So, you have to execute the following command to enable it;

```
/opt/pconsole/bin/wparConsole.sh -e
```

Note: Some system management tasks will fail with a Workload Partition because these tasks may affect global resources such as physical devices.

5.7.7 Settings

Settings Task Guides provides the following tasks;

- ▶ Manage Global Refresh
- ▶ Credential Store
- ▶ Console Logging and Tracing
- ▶ Console User Authority
- ▶ My active Roles

These tasks are discussed in the following sections.

Manage Global Refresh

Manage Global Refresh is a function to specify interval time for refreshing portlets. For example, portlets from the Health task guide have are set as follows;

- ▶ HealthSummary Portlet Entity:
- ▶ HealthMetrics Portlet Entity:
- ▶ HealthMetricDetail Portlet Entity
- ▶ HealthTopProcesses Portlet Entity
- ▶ HealthFileSystem Portlet Entity

Credential Store

If you need to change SSL keys, you can change them with this task. For more information, see “HTTPS (SSL)” on page 228

Console Logging and Tracing

See 5.7.9, “Configuration and management” on page 231

Console User Authority

See “Roles” on page 229.

My active Roles

If you use a user that is assigned to New Role, you have to use this Task to check your role is active or not. If your role is not active, change it to active in this task.

- ▶ Users can be viewed and activated with the My Active Roles application in the Settings category.
- ▶ A maximum of eight AIX roles can be active for a user at one time.

For more information, see “Roles” on page 229

5.7.8 AIX security

IBM Systems Director Console for AIX implements following security functions, discussed in the following sections;

- ▶ HTTPS (SSL)
- ▶ Authentication (login)
- ▶ Authorization (roles)

HTTPS (SSL)

IBM Systems Director Console for AIX does not support plain socket connections. HTTPS is enabled out-of-the-box.

- ▶ Default certificate and keystore password
- ▶ Same for all LWI installations
- ▶ Browser warnings
 - Signer not recognized
 - Domain name mismatch

If you want to change the SSL settings, consult the product documentation. The following settings provide a summary;

- ▶ Use ikeyman to manage certificates
 - a. /usr/java5/jre/bin/ikeyman
 - b. Delete default certificate
 - c. Create new certificate request or self-signed certificate
 - d. Change keystore password
 - e. Keystore: /pconsole/lwi/security/keystore/ibmjsse2.jks
- ▶ Update console properties
 - a. /pconsole/lwi/conf/webcontainer.properties
 - b. Stop console runtime
 - c. Copy webcontainer.properties to sslconfig
 - d. Edit sslconfig

- e. Rename or remove webcontainer.properties
- f. Start console runtime
 - New webcontainer.properties is created with obfuscated passwords
 - sslconfig file is removed

You may need to check the following files:

- ▶ /pconsole/lwi/conf/sslconfig
- ▶ /pconsole/lwi/conf/webcontainer.properties

Authentication (login)

If an administrator is required log in to the system using IBM Systems Director Console for AIX, they are required an AIX login account on the server. It is same as that of an AIX system user. To login in to the system, enter your AIX user name and password. IBM Systems Director Console for AIX provides single console session per user per server. If you encountered the login problem, please check the following items;

- No user account on the server?
- Have administrator create an account.
- Password expired or not set (new user account)?
- Login using local terminal or telnet and set password.
- Already logged into console?
- Look for warning message which gives you the option to terminate the previous session.

After some of the above items are solved, retry the login again.

Roles

There are the following two roles for IBM Systems Director Console for AIX.

Console Roles

Administrator can assign users to Console Roles through **Settings** → **Console User Authority**. Console Administrator (root by default) can assign users to roles with the User Authority app under Settings. The Console roles are defined by the console applications, and not integrated with AIX roles. Those roles are saved in file private to ISC.

Setting up console authorizations

If you always plan to log in as another administrator (except root), Console administrator role (root by default) can be assigned to non-root users with the User Authority application.

To assign administrator role, Enhanced RBAC must be enabled. Because Console administration role is using it.

Note: The Welcome Page which appears when the console administrator logs in has guidance for console set up.

1. Role Based Access Control (RBAC)
Define a role in AIX for each unique administrative job.
2. Security and Users
Add roles to administrative user ID properties in AIX.
3. Console Authorization
Define user IDs in the console and grant permission to navigation categories.
4. Activate Role

The console compares the authorizations the user has with the authorizations that the application identifies as required and displays a warning message if the user is missing authorizations.

The console executes commands with the users UID and his active authorizations.

Examples

The following is a Roles-assign example:

1. Create New role
 - a. AIX Roles: *NobuRole*
 - b. AIX Authorizations in *NobuRole*: *aix.device.config.printer*, *aixdevice.stat.printer*, *aix.security.role*, *aix.security.user*, *aix.security.group*, *aix.security.passwd*.
2. Non-root user *nobu* authorized for console tasks.
 - a. AIX user name: *nobu*
3. Console Roles: *aixUsers*, *aixPrinters*
4. AIX roles may not be active by default.

You have to go **Setting** Task Group → **My Active Roles**, and check **yes** to activate your role.

5.7.9 Configuration and management

The following is information for system configuration and management.

- ▶ Plug-ins use the /pconsole/apps/eclipse/plugin-directories
- ▶ Configuration files:/pconsole/lwi directories
- ▶ **pconsole** is defined in SRC to deal with signals.
- ▶ **pconsole** heap size is defined in /pconsole/lwi/conf/pconsole.javaopt
- ▶ **pconsole** logs are kept in the /var/log/pconsole/logs directory

Log files are written by xml. The logs rotate using filenames error-log-*n*.xml and trace.log-*n*.xml.
- ▶ wSMIT.log

If you use classic SMIT, the log file is located as \$HOME/wsmmit.log The content of the log file is same to \$HOME/smit.log.
- ▶ DCEM Log

Log files are located in \$HOME/dcem/logs/decm.log.

5.8 VMM dynamic variable page size

Pages are fixed-length data blocks held in virtual memory. The page size defines the unit size of memory portions allocatable by the operating system or an application. The supported page sizes is both dependent on the hardware architecture as well as on the operating system. The IBM System p servers and AIX V6.1 support the following page sizes:

Table 5-8 AIX and POWER page size support

Page size	Required processor architecture	Description
4 KB	ALL	Is the standard page size for all AIX 5L and older versions running on POWER™ architecture.
64 KB	POWER5+™ or later	This page size has been introduced with AIX V5.3 TL 5300-04 multiple page size support.

Page size	Required processor architecture	Description
16 MB	POWER4™ or later	Also called large pages. Intended only for high performance computing (HPC). Use the vmo command to enable large page sizes. It has been introduced with AIX V5.1 ML 5100-02.
16 GB	POWER5+ or later	Also called huge pages. Intended only for high performance computing (HPC). Use the Hardware Management Console (HMC) to enable huge page sizes. This page size has been introduced with AIX V5.3 TL 5300-04 multiple page size support.

AIX V6.1 and POWER6 architecture introduces dynamic variable page size support (VPSS):

- ▶ VMM can dynamically use a larger page size based on the application memory usage. This will improve memory access performance.
- ▶ The use of larger page sizes is transparent to applications.
- ▶ VPSS is activated by default if the underlying hardware supports it.
- ▶ With the default settings, AIX will use larger page sizes only if it does not result in an increase in memory usage for a process.
- ▶ You can use **vmo** tunables to influence VPPS behavior.

Important: If you are using POWER6 System p 570 servers, make sure your system firmware is at level EM320 or later to support variable page sizes.

5.8.1 Variable page size concept

Using larger page sizes increases memory access performance since less address translations in the hardware have to be done and caching mechanisms can be used more efficiently. On the other hand, memory regions may be wasted if a larger page size is allocated and then populated with data less than the page size.

AIX V5.3 TL 5300-04 added support for the medium size 64 KB pages. In order to use the medium page sizes, applications need to be recompiled or explicitly set loader shell environment variables. Starting with AIX V6.1 on a POWER6-based processors the Virtual Memory Manager (VMM) can dynamically promote pages to a larger page size. This is page promotion is completely transparent to the application and will be done without the need of user intervention.

The variable page size support is based on the processors ability to have mixed page sizes within the same memory segment. Every mixed page size segment has a minimum and a maximum page size. At the time of writing, the POWER6 architecture and AIX V6.1 supports 4 KB pages as the minimum and 64 KB pages as the maximum.

AIX will continue to support explicit selection of page sizes using the existing mechanisms of system calls and loader options. When an explicit page size is specified for a memory region, AIX will treat the specified page size as the minimum page size of the memory region. VMM may dynamically use pages larger than the page size specified for a memory region.

Note: VMM will only support dynamically varying the page size of working storage memory.

5.8.2 Page size promotion

The AIX V6.1 default behavior is to divide every memory segment into equal-sized ranges based on the maximum page size for the segment. AIX will decide the page size to use for each range independently of the other ranges in a variable page size segment. This is shown in Figure 5-14.

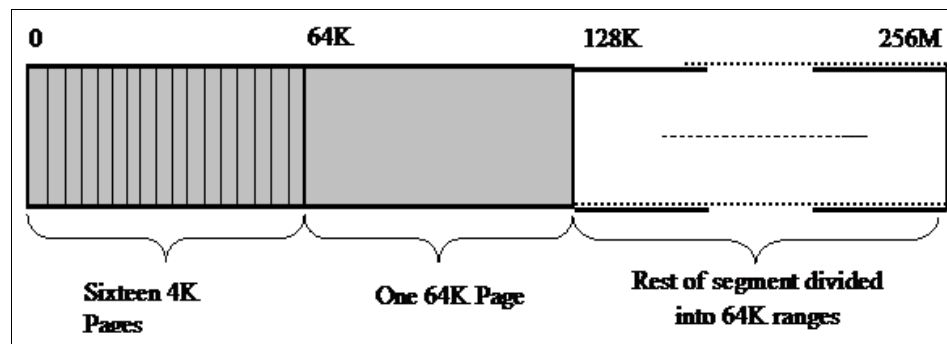

Figure 5-14 Mixed page size memory segment used by VPSS

The VMM starts allocating 4 KB page frames for a memory range until a sufficient number of 4 KB pages in the memory range had been referenced to allow promotion of the memory range to a larger page size. In this case, 16 4 KB pages are needed. Promotion to the larger page size of 64 KB requires that all the pages have the same state (such as same read/write page protection, non-exec protection, storage key protection, and not in I/O state). If this is the case, the 4 KB address translations are removed and replaced with a 64 KB address translation.

The 64 KB address translations are used as long as all 16 4 KB pages continue to have the same state. State changes such as through the `mprotect` subroutine, or page stealing of the LRU daemon, causes demotion to the 4 KB page size.

VMM will dynamically adjust page sizes at a page granularity level. Therefore different data regions of a single process might be allocated in both 4 KB and 64 KB pages at the same time. The AIX operating system's dynamic use of larger page sizes is completely transparent to applications and kernel extensions. When VMM has dynamically selected a larger page size for a memory region, all system calls and kernel API's will indicate that 4 KB pages are being used for the memory region.

5.8.3 The `vmo` command tunables

With the support of variable page sizes, AIX V6.1 introduces a new `vmo` tunable setting `vmm_default_pspa` and extended the existing `vmm_mpsize_support`.

`vmm_default_pspa`

Some applications perform better with larger page size, even when the maximum page size (64 KB) region is not fully referenced. The `vmo` tunable page size promotion aggressiveness factor (PSPA) can be used to alter the requirement that all allocated 4 KB have to contain data before they get promoted to the larger page size.

You can specify a numeric value between 0 and 100. This percent value is treated as the inverse of the page promotion threshold. In other words, a value of 0 means that still all the 16 4 KB pages have to be referenced in order to get promoted to a 64 KB page. With a value of 50, 8 4 KB pages are needed for promotion while a value of 100 forces a promotion at the first reference to that memory region. The default value is 0.

A value of -1 indicates that no page promotion will be done by VMM. Note that the default value is -1 if no hardware support can be detected.

Page size promotion thresholds are only considered at segment creation time. Therefore changed values of the `vmm_default_pspa` tunable will only affect new segments.

This setting is valid system-wide. In order to change PSPA on a application level, code changes and a recompile are required. AIX V6.1 introduces new system call named `vm_patrr()` to alter the PSPA weight.

vmm_mpsize_support

The `vmm_mpsize_support` tunable toggles the AIX multiple page size support for the extra page sizes provided by POWER5+ and later systems. The new value of 2 is introduced to support dynamic variable page sizes. Table 5-9 shows all the possible values. The default value in AIX V6.1 is 2.

Table 5-9 *vmo vmm_mpsize_support tunable*

Value	Description
0	Only page sizes of 4 KB and 16 MB are recognized.
1	AIX will take advantage of the additional page sizes supported by a processor.
2	AIX will take advantage of the capability of using multiple page sizes per segment.

To activate changes to `vmm_mpsize_support` tunable you need to run the `bosboot` command and reboot your AIX.

5.8.4 The svmon command enhancements

The `svmon` command used a single character qualifier ('s', 'm', 'L', and 'S') to represent the segment page size (respectively 4 KB, 64 B, 16 MB and 16 GB). Starting with AIX V6.1 the `svmon` command supports for the dynamic variable page sizes with the use of two characters to represent the minimum and maximum page sizes attributes for each segment. The following example shows the `svmon -P` output for mixed page sizes (4 KB and 64 KB) in a memory segment for the init process:

```
# svmon -P 1
```

```
-----
```

Pid	Command	Inuse	Pin	Pgsp	Virtual	64-bit	Mthrd	16MB
1	init	13834	8085	0	13818	N	N	N

PageSize	Inuse	Pin	Pgsp	Virtual
s 4 KB	186	5	0	170
m 64 KB	853	505	0	853

Vsid	Esid	Type	Description	PSize	Inuse	Pin	Pgsp
Virtual							
0	0	work	kernel segment	m	555	505	0 555
3c02d	d	work	shared library text	m	298	0	0 298
15001	2	work	process private	sm	101	5	0 101
6501d	f	work	shared library data	sm	69	0	0 69
7d01b	1	clnt	code,/dev/hd2:531	s	11	0	- -

```
1d023      - c1nt /dev/hd4:724          s      5      0      -      -
```

The **svmon -l** flag displays separate statistics for every page size in a mixed page size segment:

```
# svmon -P 1 -l
```

```
-----
  Pid Command          Inuse   Pin    Pgps Virtual 64-bit Mthrd 16MB
    1 init             13834  8085     0   13818     N     N   N

  PageSize            Inuse   Pin    Pgps   Virtual
  s   4 KB             186     5     0     170
  m   64 KB            853    505     0     853

  Vsid   Esid Type Description          PSize Inuse Pin Pgps Virtual
    0     0 work kernel segment      m    555 505 0 555
          System segment
  3c02d   d work shared library text      m    298  0 0 298
          Shared library text segment
  15001   2 work process private          s    101  5 0 101
          m     0  0 0 0
          pid(s)=1
  6501d   f work shared library data        s    69  0 0 69
          m     0  0 0 0
          pid(s)=1
  7d01b   1 c1nt code,/dev/hd2:531          s     11  0 - -
          pid(s)=1
  1d023   - c1nt /dev/hd4:724              s     5  0 - -
          pid(s)=213100, 1
```

The **svmon -q** flag has been enhanced to accept the new two character qualifiers, which refer to mixed page size segments:

```
# svmon -S -q sm | head -20
```

```
  Vsid   Esid Type Description          PSize Inuse Pin PgpsVirtual
  20028   - work other kernel segments    sm  15040 15040 0 15040
    8002   - work other kernel segments    sm   1526  0 0 1526
  24009   - work other kernel segments    sm   1518 1433 0 1518
  6925e   - work                          sm   1480  0 0 1480
  3400d   - work other kernel segments    sm    523  0 0 523
  3800e   - work other kernel segments    sm    522  0 0 522
  59272   - work                          sm    371  0 0 371
  1d2e3   - work                          sm    352  5 0 352
  3000c   - work other kernel segments    sm    352 346 0 352
  792da   - work                          sm    258  0 0 258
  15261   - work                          sm    248  5 0 248
    c003   - work other kernel segments    sm    240 240 0 240
  512d0   - work                          sm    213  5 0 213
```

1204	- work	sm	213	0	0	213
6931e	- work	sm	202	5	0	202
292ce	- work	sm	202	0	0	202
1224	- work	sm	196	5	0	196
3d1cb	- work	sm	194	0	0	194



Performance Management

The performance of a computer system is evaluated based on clients expectations and the ability of the system to fulfill these expectations. The objective of performance management is to balance between appropriate expectations and optimizing the available system resources.

Many performance-related issues can be traced back to operations performed by a person with limited experience and knowledge who unintentionally restricted some vital logical or physical resource of the system. Most of these actions may at first be initiated to optimize the satisfaction level of some users, but at the end, they degrade the overall satisfaction of other users.

AIX Version 6 introduces many new performance management enhancements, and are the topics to be discussed:

- ▶ 6.1, “Unique tunable documentation” on page 240

A unique documentation repository for all tunables of the six AIX tuning commands.

- ▶ 6.2, “Restricted tunables” on page 241

The tunable classification `##Restricted parameter` to avoid end-user modification mistakes on critical performance tunables.

- ▶ 6.3, “AIX V6 out-of-the-box performance” on page 254

A new AIX default set of tunables values to avoid setting base operating system parameters for a newly installed system, the so-called tuning out-of-the-box, or default, performance.

- ▶ 6.4, “Hardware performance monitors” on page 263

Enhancements on the AIX low-level performance monitors to detect more accurately a server problem-determination issue against a pure performance issue.

6.1 Unique tunable documentation

Because of the large number of tunables available, the need to adjust the tunables default values, their value ranges, and the need to add new tunables as platform complexity evolves, the static nature of the corresponding system documentation and tunable help messages has become increasingly difficult to manage.

The help message of the tuning commands now contains the complete tunables description and allowed settings. Thus, the full list of the system tunable parameters and details of their use are no longer available at the AIX documentation or man pages level. This method ensures a single method for a user to know the exact functions a command currently has.

The tunable description message for the six tuning commands (**vmo**, **ioo**, **schedo**, **raso**, **no**, and **nfso**) can be displayed through the new `-h <tunable>` option.

The following example shows this message:

```
# vmo -h lru_file_repage
Help for tunable lru_file_repage:
Purpose:
Specifies whether the repaging rate will be considered in determining
whether to steal file or computational pages.
Values:
    Default: 0
    Range: 0, 1
    Type: Dynamic
    Unit: boolean
Tuning:
A value of 0 indicates that only file pages will be stolen if file
pages are above minperm. Value of 1 indicates that only file pages will
be stolen if both the file repaging rate is higher than the
computational repaging rate and file pages are above minperm.
```

We recommend to AIX system administrators to make a copy of the complete tunables description using a text file format to their personal computer if they need to work without a AIX server connection.

Tip: Appendix B, “Sample script for tunables” on page 419 provides a sample shell script named `prt_tun_help.sh` to output all tunables for each tuning command under a corresponding file with “`xxxo_help.txt`” name. A tar archive format file, gathering all these output files, named `prt_tun_help.tar` can be then uploaded.

6.2 Restricted tunables

Since AIX 5.3, six tuning commands (**vmo**, **ioo**, **schedo**, **raso**, **no**, and **nfso**) have a unified behavior and syntax.

Beginning with AIX Version 6, some tunables are now classified as *restricted use tunables*. They exist and must be modified primarily for specialized intervention by the development support or development teams.

Note: System Administrators should not modify *restricted tunables* unless instructed to by IBM support professionals.

As these parameters are not recommended for user modification, they are no longer displayed by default but only with the `-F` option (force) on the command. Thus, in SMIT and Web-based System Manager they have no visibility by default.

The **no**, **nfso**, **vmo**, **ioo**, **raso**, and **schedo** tuning commands all support the following syntax:

```
command [-p|-r] [-F] -a
```

```
command [-L] -F [tunable]
```

```
command [-x] -F [tunable]
```

The following applies to the `-F` option.

-F Forces display of restricted tunable parameters when the options `-a`, `-L` or `-x` are specified alone on the command line to list all tunables.

When `-F` is not specified, restricted tunables are not included in a display unless specifically named in association with a display option

When the force -F option is used, the restricted tunables will be displayed after the non-restricted tunables and after a distinctive separator line beginning with the characters “##”.

In the English language locales, this will be *##Restricted tunables*. The Web-based Systems Manager panels do not show restricted tunables by default, but display them with their name followed by (R), when the Show Restricted Parameters check box is selected in the menu of a tunable table.

In the following SMIT panel (Figure 6-1), note the restricted tunables are defined as *Development Parameters* to underline that only the IBM AIX development support team is authorized to modify the AIX restricted tunables.

```

Tuning Development Parameters
-----
Move cursor to desired item and press Enter.

Tuning Scheduler & Memory Load Control Development Parameters
Tuning Virtual Memory Manager, File System and LVM Development Parameters
Tuning Network Option Development Parameters
Tuning NFS Option Development Parameters
Tuning IO Development Parameters
Tuning RAS Development Parameters

F1=Help      F2=Refresh   F3=Cancel    F8=Image
F9=Shell     F10=Exit    Enter=Do

```

Figure 6-1 SMIT panel for AIX Version 6.1 Restricted Tunables

6.2.1 New warning message for restricted tunables

When a restricted tunable is modified using any -o, -d or -D option, a warning message is written to stderr (without generating an error) to warn the user that a tunable of the restricted use type has been modified.

```

# vmo -o maxclient%=40
Setting maxclient% to 40
Warning: a restricted tunable has been modified

```

Moreover, if a restricted tunable is modified permanently adding the `-p` or `-r` option, the user will be prompted for confirmation of the change.

```
# vmo -p -o maxclient%=40
```

```
Modification to restricted tunable maxclient%, confirmation required
yes/no yes
```

```
Setting maxclient% to 40 in nextboot file
```

```
Setting maxclient% to 40
```

```
Warning: a restricted tunable has been modified
```

The saved restricted tunables that have been modified to a value different from the default value, are flagged with a comment `#RESTRICTED not at default value`, appended to the line of the `tunsave` output file.

The following is an example of a `tunsave` output file:

```
#vi /etc/mytuning.out
```

```
info:
```

```
    Description = "tunsave -F /etc/mytuning.out"
```

```
    AIX_level = "6.1.0.0"
```

```
    Kernel_type = "MP64"
```

```
    Last_validation = "2007-09-20 13:56:37 CDT (current, reboot)"
```

```
... (lines removed for clarity)
```

```
vmo:
```

```
... (lines removed for clarity)
```

```
    maxclient% = "40" # RESTRICTED not at default value
```

Current and default values for specific tunables

Although no tunables modification has been made within AIX V6, the `tunsave` command does report some restricted and non-restricted tunables as set without their default values.

```
... (lines removed for clarity)
```

```
vmo:
```

```
    kernel_heap_psize = "65536"
```

```
    kernel_psize = "65536" # RESTRICTED not at default value
```

```
    mbuf_heap_psize = "65536" # RESTRICTED not at default value
```

These tunables (for `vmo`: `kernel_heap_psize`, `kernel_psize`, `mbuf_heap_psize`) are reported due to their default ZERO value.

A ZERO default value for these tunables indicates that the operating system will determine and set the most appropriate value as current one.

```
... (lines removed for clarity)
```

```
no:
```

```

        net_malloc_police = "16384"      # RESTRICTED not at default
value

```

The **no** tunable `net_malloc_police` is reported as default value is 65536.

... (lines removed for clarity)

```

nfso:
        statd_debug_level = "-1"        # RESTRICTED not at default
value
        statd_max_threads = "-1"       # RESTRICTED not at default
value

```

The **nfso** tunables `statd_debug_level` and `statd_max_threads` are reported because their current values are set to -1 when `statd` subsystem is inactive while their default value is 0 and 50 respectively. If `statd` is active, these two restricted tunables will no be reported.

6.2.2 New error log entry for restricted tunables

At system reboot, the presence of restricted tunables in the `/etc/tunables/nextboot` file modified to a value different from their default value (using a command line specifying the `-r` or `-p` options) cause the addition of a new `TUNE_RESTRICTED` error log entry.

This `TUNE_RESTRICTED` error log entry identifies the list of these modified restricted tunables.

This error log entry is created by calling a new performance tools specific `/usr/lib/perf/tunerrlog` command, included in the existing `bos.perf.tune` package.

The `/usr/sbin/tunrestore -R` command (in `/etc/inittab` file) calls the `tunerrlog` command which adds these informational errors in the error log.

The following is an example of a `TUNE_RESTRICTED` error log message:

Note the date is using the Welsh locale from one of the authors test systems, we're thinking it was a Monday.

```

-----
LABEL:          TUNE_RESTRICTED
IDENTIFIER:     D221BD55

Date/Time:      20 Medi 2007 19:35:36 CDT
Sequence Number: 19
Machine Id:     00C1F1704C00

```

```

Node Id:      lpar01
Class:       0
Type:        INFO
WPAR:        Global
Resource Name: perftune
Description
RESTRICTED TUNABLES MODIFIED AT REBOOT

```

```

Probable Causes
SYSTEM TUNING

```

```

User Causes
TUNABLE PARAMETER OF TYPE RESTRICTED HAS BEEN MODIFIED

```

```

Recommended Actions
REVIEW TUNABLE LISTS IN DETAILED DATA

```

```

Detail Data
LIST OF TUNABLE COMMANDS CONTROLLING MODIFIED RESTRICTED TUNABLES AT
REBOOT, SEE FILE /etc/tunables/lastboot.log
vmo

```

6.2.3 AIX V6 tunables lists

In this section, the tunables and the restricted tunables reported by each of the AIX V6 tunables `xxo -F -a` commands are provided. As stated in 6.1, “Unique tunable documentation” on page 240, these lists are no longer available in AIX documentation or the man pages.

The values settings of tunables in the following lists are the default values for AIX V6.1 TL00 SP00.

IOO command tunables

With AIX V6.1 and above, only 21 `ioo` command tunables are available for end-user modification and 27 `ioo` command tunables are classified as restricted tunables and not available for system administrators modification.

► `ioo` command end-user tunables

```

# ioo -a
                aio_active = 0
                aio_maxreqs = 65536
                aio_maxservers = 30
                aio_minservers = 3
                aio_server_inactivity = 300

```

```

j2_atimeUpdateSymlink = 0
j2_dynamicBufferPreallocation = 16
    j2_inodeCacheSize = 400
    j2_maxPageReadAhead = 128
    j2_maxRandomWrite = 0
    j2_metadataCacheSize = 400
    j2_minPageReadAhead = 2
j2_nPagesPerWriteBehindCluster = 32
    j2_nRandomCluster = 0
        lvm_bufcnt = 9
        pd_npages = 65536
    posix_aio_active = 0
    posix_aio_maxreqs = 65536
    posix_aio_maxservers = 30
    posix_aio_minservers = 3
    posix_aio_server_inactivity = 300

```

► **ioo** restricted tunables

```

##Restricted tunables
    aio_fastpath = 1
    aio_fsfastpath = 1
    aio_kprocprio = 39
    aio_multitidsusp = 1
    aio_sample_rate = 5
    aio_samples_per_cycle = 6
    j2_maxUsableMaxTransfer = 512
    j2_nBufferPerPagerDevice = 512
    j2_nonFatalCrashesSystem = 0
    j2_syncModifiedMapped = 1
    j2_syncdLogSyncInterval = 1
    jfs_clread_enabled = 0
    jfs_use_read_lock = 1
    maxpgahead = 8
    maxrandwrt = 0
    memory_frames = 262144
    minpgahead = 2
    numclust = 1
    numfsbufs = 196
    pgahd_scale_thresh = 0
    posix_aio_fastpath = 1
    posix_aio_fsfastpath = 1
    posix_aio_kprocprio = 39
    posix_aio_sample_rate = 5
    posix_aio_samples_per_cycle = 6
    pv_min_pbuf = 512

```

```
sync_release_ilock = 0
```

vmo command tunables

With AIX V6.1, only 29 **vmo** tunables are available for end-user modification and 30 **vmo** tunables are classified as restricted tunables and not available for system administrators modification.

► vmo end-user tunables

```
# vmo -a
    force_realias_lite = 0
    kernel_heap_psize = 65536
    lgpg_regions = 0
    lgpg_size = 0
    low_ps_handling = 1
        maxfree = 1088
        maxperm = 210108
        maxpin = 211796
        maxpin% = 80
    memory_frames = 262144
    memplace_data = 2
    memplace_mapped_file = 2
    memplace_shm_anonymous = 2
    memplace_shm_named = 2
    memplace_stack = 2
    memplace_text = 2
    memplace_unmapped_file = 2
        minfree = 960
        minperm = 7003
        minperm% = 3
    nokilluid = 0
    npskill = 1024
    npswarn = 4096
    numpsblks = 131072
    pinnable_frames = 180093
    relalias_percentage = 0
        scrub = 0
        v_pinshm = 0
    vmm_default_pspa = -1
```

► vmo restricted tunables

```
##Restricted tunables
    cpu_scale_memp = 8
    data_stagger_interval = 161
        defps = 1
    framesets = 2
```

```

        htabscale = n/a
        kernel_psize = 65536
    large_page_heap_size = 0
        lru_file_repage = 0
        lru_poll_interval = 10
        lrubucket = 131072
        maxclient% = 90
        maxperm% = 90
        mbuf_heap_psize = 65536
        memory_affinity = 1
        npsrpgmax = 8192
        npsrpgmin = 6144
        npsscrubmax = 8192
        npsscrubmin = 6144
        num_spec_dataseg = 0
        page_steal_method = 1
            rpgclean = 0
            rpgcontrol = 2
            scrubclean = 0
    soft_min_lgpgs_vmpool = 0
        spec_dataseg_int = 512
        strict_maxclient = 1
        strict_maxperm = 0
    vm_modlist_threshold = -1
        vmm_fork_policy = 1
        vmm_mpsize_support = 2

```

no command tunables

With AIX V6.1, 133 **no** tunables are available for end-user modification and 5 **no** tunables are classified as restricted tunables and not available for system administrators modification.

► no end-user tunables

```

# no -a
        arpqsize = 12
        arpt_killc = 20
        arptab_bsiz = 7
        arptab_nb = 149
        bcastping = 0
    clean_partial_conns = 0
        delayack = 0
        delayackports = {}
        dgd_packets_lost = 3
        dgd_ping_time = 5

```



```
dgd_retry_time = 5
directed_broadcast = 0
    fasttimo = 200
icmp6_errmsg_rate = 10
    icmpaddressmask = 0
ie5_old_multicast_mapping = 0
    ifsize = 256
    ip6_defttl = 64
    ip6_prune = 1
    ip6forwarding = 0
ip6srcrouteforward = 1
ip_ifdelete_notify = 0
    ip_nfrag = 200
    ipforwarding = 0
    ipfragttl = 2
ipignoreredirects = 0
    ipqmaxlen = 100
    ipsendredirects = 1
ipsrcrouteforward = 1
    ipsrcrouterrecv = 0
    ipsrcroutesend = 1
llsleep_timeout = 3
    lo_perf = 1
    lowthresh = 90
    main_if6 = 0
    main_site6 = 0
    maxnip6q = 20
    maxttl = 255
    medthresh = 95
    mpr_policy = 1
    multi_homed = 1
    nbc_limit = 131072
    nbc_max_cache = 131072
    nbc_min_cache = 1
    nbc_ofile_hashsz = 12841
    nbc_pseg = 0
    nbc_pseg_limit = 262144
ndd_event_name = {all}
ndd_event_tracing = 0
    ndp_mmaxtries = 3
    ndp_umaxtries = 3
    ndpqsize = 50
    ndpt_down = 3
    ndpt_keep = 120
    ndpt_probe = 5
```

```
ndpt_reachable = 30
ndpt_retrans = 1
net_buf_size = {all}
net_buf_type = {all}
net_malloc_frag_mask = {0}
netm_page_promote = 1
nonlocsrcroute = 0
nstrpush = 8
passive_dgd = 0
pmtu_default_age = 10
pmtu_expire = 10
pmtu_rediscover_interval = 30
psebufcalls = 20
psecache = 1
psetimers = 20
rfc1122addrchk = 0
rfc1323 = 0
rfc2414 = 1
route_expire = 1
routerevalidate = 0
rto_high = 64
rto_length = 13
rto_limit = 7
rto_low = 1
sack = 0
sb_max = 1048576
send_file_duration = 300
site6_index = 0
sockthresh = 85
sodebug = 0
sodebug_env = 0
somaxconn = 1024
strctlsz = 1024
strmsgsz = 0
strthresh = 85
strturncnt = 15
subnetsarelocal = 1
tcp_bad_port_limit = 0
tcp_ecn = 0
tcp_ephemeral_high = 65535
tcp_ephemeral_low = 32768
tcp_finwait2 = 1200
tcp_icmpsecure = 0
tcp_init_window = 0
tcp_inpcb_hashtab_siz = 24499
```

```
tcp_keepcnt = 8
tcp_keeppidle = 14400
tcp_keeppinit = 150
tcp_keeppintvl = 150
tcp_limited_transmit = 1
tcp_low_rto = 0
tcp_maxburst = 0
tcp_msdfllt = 1460
tcp_nagle_limit = 65535
tcp_nagleoverride = 0
tcp_ndebug = 100
tcp_newreno = 1
tcp_nodelayack = 0
tcp_pmtu_discover = 1
tcp_recvspace = 16384
tcp_sendspace = 16384
tcp_tcpsecure = 0
tcp_timewait = 1
tcp_ttl = 60
tcprexmtthresh = 3
thewall = 524288
timer_wheel_tick = 0
tn_filter = 1
udp_bad_port_limit = 0
udp_ephemeral_high = 65535
udp_ephemeral_low = 32768
udp_inpcb_hashtab_siz = 24499
udp_pmtu_discover = 1
udp_recvspace = 42080
udp_sendspace = 9216
udp_ttl = 30
udpcksum = 1
use_sndbufpool = 1
```

► **no restricted tunables**

```
##Restricted tunables
extendednetstats = 0
inet_stack_size = 16
net_malloc_police = 16384
pseintrstack = 24576
use_isno = 1
```

schedo command tunables

With AIX V6.1, only 15 **schedo** tunables are available for end-user modification and 27 **schedo** tunables are classified as restricted tunables and not available for system administrators modification.

► **schedo** end-user tunables

```
# schedo -a
    affinity_lim = 7
    big_tick_size = 1
ded_cpu_donate_thresh = 80
    fixed_pri_global = 0
    force_grq = 0
    maxspin = 16384
    pacefork = 10
    sched_D = 16
    sched_R = 16
    tb_balance_S0 = 2
    tb_balance_S1 = 2
    tb_threshold = 100
    timeslice = 1
    vpm_fold_policy = 1
    vpm_xvcpus = 0
```

► **schedo** restricted tunables

```
##Restricted tunables
    %usDelta = 100
    allowMCMmigrate = 0
    fast_locks = 0
    hotlocks_enable = 0
idle_migration_barrier = 4
    krlock_confer2self = 1
    krlock_conferb4alloc = 1
    krlock_enable = 1
    krlock_spinb4alloc = 1
    krlock_spinb4confer = 1024
    n_idle_loop_vlopri = 100
search_globalrq_mload = 256
search_smtrunq_mload = 256
setnewrq_sidle_mload = 384
shed_primrunq_mload = 64
    sidle_S1runq_mload = 64
    sidle_S2runq_mload = 134
    sidle_S3runq_mload = 134
    sidle_S4runq_mload = 4294967040
slock_spinb4confer = 1024
```

```

smt_snooze_delay = 0
smtrunq_load_diff = 2
v_exempt_secs = 2
v_min_process = 2
v_repage_hi = 0
v_repage_proc = 4
v_sec_wait = 1

```

nfsd command tunables

With AIX V6.1, only 13 **nfsd** tunables are available for end-user modification and 21 **nfsd** tunables are classified as restricted tunables and not available for system administrators modification.

► **nfsd** end-user tunables

```

# nfsd -a
client_delegation = 1
nfs_max_read_size = 65536
nfs_max_write_size = 65536
nfs_rfc1323 = 1
nfs_securenfs_authtimeout = 0
nfs_server_base_priority = 0
nfs_server_clread = 1
nfs_use_reserved_ports = 0
nfs_v3_server_readdirplus = 1
nfs_v4_fail_over_timeout = 0
portcheck = 0
server_delegation = 1
utf8_validation = 1

```

► **nfsd** restricted tunables

```

##Restricted tunables
lockd_debug_level = 0
nfs_allow_all_signals = 0
nfs_auto_rbr_trigger = 0
nfs_dynamic_retrans = 1
nfs_gather_threshold = 4096
nfs_iopace_pages = 0
nfs_max_threads = 3891
nfs_repeat_messages = 0
nfs_socketsize = 600000
nfs_tcp_duplicate_cache_size = 5000
nfs_tcp_socketsize = 600000
nfs_udp_duplicate_cache_size = 5000
nfs_v2_pdts = 1
nfs_v3_pdts = 1

```

```

nfs_v4_pdts = 1
nfs_v2_vm_bufs = 10000
nfs_v3_vm_bufs = 10000
nfs_v4_vm_bufs = 10000
statd_debug_level = 0
statd_max_threads = 50
udpchecksum = 1

```

raso command tunables

With AIX V6.1, 9 **raso** tunables are available for end-user modification and 4 **raso** tunables are classified as restricted tunables and not available for system administrators modification.

► **raso** end-user tunables

```

# raso -a
kern_heap_noexec = 0
kernel_noexec = 1
mbuf_heap_noexec = 0
mtrc_commonbufsize = 971
mtrc_enabled = 1
mtrc_rarebufsize = 50
tprof_cyc_mult = 1
tprof_evt_mult = 1
tprof_inst_threshold = 1000

```

► **raso** restricted tunables

```

##Restricted tunables
recovery_action,1,1,1,0,1,boolean,D,
recovery_average_threshold,5,5,5,0,100,numeric,D,
recovery_debugger,0,0,0,-1,3,numeric,D,
recovery_framework,1,1,1,0,1,boolean,B,

```

6.3 AIX V6 out-of-the-box performance

There have been recurring performance issues seen at enterprise sites that have been resolved through simple modification of AIX tunable values. A significant percentage of these performance issues have occurred in environments running databases on file systems.

For example, on AIX 5.2/5.3, Oracle® customers must perform the following tuning steps:

► VMM tuning

- Reduce minperm, maxperm, and maxclient
- Turn off strict_maxclient
- Increase minfree and maxfree
- ▶ AIO tuning
 - Enable AIO
 - Tune minservers and maxservers, and then reboot for these to take effect
- ▶ Oracle tuning
 - Enable CIO

Another common issue for AIX users is interactive applications that become unresponsive due to other applications on the same system doing large sequential writes to slow storage devices.

In the Version 6 of AIX, the default settings have been modified accordingly, resulting in a better *out-of-the-box* performance for a majority of our AIX systems.

The following sections explained in details which tunables have been modified, and provide a side-by-side comparison of their default values for AIX V5 and AIX V6.

6.3.1 Virtual Memory Manager default tunables

A common problem seen in file server environments is system paging when no VMM tuning has been done. File system intensive applications such as a database server, mail servers, or backup servers often page out computational pages to the paging space even though the system has enough real memory.

A system has enough memory when its amount of virtual memory does not exceed the amount of physical memory.

In the following example, the amount of virtual memory is 163967 4 KB pages while the amount of physical memory is 262144 4 KB pages: the system has enough real memory.

```
# svmon -G

```

	size	inuse	free	pin	virtual
memory	262144	226791	35353	96991	163967
pg space	131072	2370			
	work	pers	clnt	other	
pin	86669	0	0	10322	
in use	163967	0	62824		

PageSize	PoolSize	inuse	pgsp	pin	virtual
s 4 KB	-	130903	2370	29999	68079
m 64 KB	-	5993	0	4187	5993

The cause is that the percentage of memory that is being used for caching persistent or client pages, typically is between the minperm% value and maxperm% value or maxclient% value respectively. Then, the page replacement algorithm steals computational pages when the repage count for computational pages is greater than the repage count for file pages.

The solution is to turn off the repage ratio check lru_file_repage. The lru_file_repage parameter was introduced at ML4 of AIX 5.2 and ML1 of AIX 5.3 but disabled by default.

The following change (lru_file_repage=0) turns off the repage ratio check and forces the page replacement algorithm to steal computational pages only in the case that the percentage of cached file pages is less than the minperm% value.

Thus, the VMM page replacement default is changed with AIX Version 6 to allow AIX to use up to 90% of its real memory for file caching but favor computational pages as resident pages over file pages.

In addition, the default for minperm% is reduced to 3%. Computational pages will not be stolen unless the amount of active virtual memory exceeds 97% of the size of the real memory. Also, list-based LRU will be enabled by default.

Table 6-1 provides a list of the vmo command tunable name, and their default values within AIX releases.

Table 6-1 Default tunable values for the vmo command

vmo tunable name	AIX 5.2/5.3 default values	AIX 6 default values
minperm%	20	3
maxperm% (R) ^a	80	90
maxclient% (R) ^a	80	90
lru_file_repage (R) ^a	1	0
page_steal_method (R) ^a	0	1

a. (R) means that it is a restricted use tunable

6.3.2 AIX V6 enables I/O Pacing by default

Large sequential writes can often cause a system to become unresponsive.

One of the potential causes is that pages that can be used for file caching are modified, and therefore VMM page replacement cannot find any candidate pages to steal. The reason all the pages are in modified state may be that file pages are being created faster than can be written to disk, either due to extremely fast CPUs, a slow storage subsystem, or both.

The settings of I/O pacing for AIX V4.3 and AIX V5 were defined where a server consisted of a 100 MHz uniprocessor, a 10 Mb Ethernet card and a 2 GB SCSI disk. These settings are no longer suitable due to the huge performance improvement that our latest processors deliver.

The VMM file I/O pacing will be enabled by default to prevent unresponsive system behavior due to a large number of queued I/Os on the paging device tables.

To enable I/O pacing by default, the minpout and maxpout tunables of sys0 device are set to non-zero values. The new AIX V6 specific default values are based on results of tests and analysis by the IBM performance team.

They are expected to allow an application, running on a system with enough CPU horsepower and storage subsystem bandwidth while not severely impacting the response time of interactive applications to the point where the system seems non-responsive.

Table 6-2 provides minpout/maxpout values within AIX releases.

Table 6-2 minpout/maxpout values within AIX releases

sys0 tunable name	AIX 5.2/5.3 default values	AIX V6 default values
minpout	0	4096
maxpout	0	8193

6.3.3 AIX V6 new AIO dynamic tunables

AIO stands for Asynchronous Input Output. It is a software subsystem within AIX that allows a process to issue an I/O operation and continue processing without waiting for the I/O to finish.

Therefore, asynchronous I/O operations run in the background and do not block user applications. This improves performance because I/O operations and

applications processing can run simultaneously. Many applications, such as databases and file servers, take advantage of the ability to overlap processing and I/O.

There are two AIO subsystems:

- ▶ The original AIX AIO, now called *LEGACY* AIO.
- ▶ The Portable Operating System Interface (POSIX) compliant, called POSIX AIO.

The major differences between the two involve different parameter passing at the application layer. So, the choice for using one or the other implementation in an application is a software developer decision. The AIO application programming interface is not covered in this section.

Both subsystems can run concurrently on AIX.

With AIX Version 4/Version 5, if an application uses AIO, the corresponding subsystem must be activated by setting *available* to the autoconfig parameter. This requires a reboot because the AIO kernel extension has to be loaded.

Prior to AIX V5.3 TL05, any change to the three tunables *maxreqs*, *maxservers* and *minservers* require also a reboot.

AIO tunables for both subsystems in AIX 5.3 are:

```
# oslevel -s
5300-06-01-0000
# lsattr -El aio0
autoconfig defined STATE to be configured at system restart True
fastpath enable State of fast path True
kprocprio 39 Server PRIORITY True
maxreqs 4096 Maximum number of REQUESTS True
maxservers 10 MAXIMUM number of servers per cpu True
minservers 1 MINIMUM number of servers True
# lsattr -El posix_aio0
autoconfig defined STATE to be configured at system restart True
fastpath enable State of fast path True
kprocprio 39 Server PRIORITY True
maxreqs 4096 Maximum number of REQUESTS True
maxservers 10 MAXIMUM number of servers per cpu True
minservers 1 MINIMUM number of servers True
```

With AIX V5.3 TL05, a new *aioo* command was shipped with the AIO fileset (*bos.rte.aio*) that changes these three tunables (*minservers*, *maxservers*, *maxreqs*) on a running system. It requires no reboot when you increase *maxreqs*, *maxservers*, and *minservers* but reducing the values for these tunables

does require a reboot. The **aioo** command does not change the ODM attributes to make the changes persistent across boots.

An example of AIX 5.3 TL05 **aioo** command output:

```
# aioo -a
           minservers = 1
           maxservers = 10
           maxreqs = 4096
           fsfastpath = 0
```

This **aioo** output shows a new AIX V5.3 TL05 tunable, **fsfastpath**, also non-persistent across boots.

With AIX Version 6, the following tunables **fastpath**, **fsfastpath** are classified as restricted tunables¹ and now set to value 1 by default.

- ▶ When the **fastpath** tunable is set to 1, asynchronous I/O requests to a raw logical volume are passed directly to the disk layer using the corresponding strategy routine.
- ▶ When the **fsfastpath** tunable is set to 1, asynchronous I/O requests for files opened with CIO (Concurrent I/O) mode in a JFS2 file system AIO are passed directly to LVM or disk using the corresponding strategy routine.

The following output shows the restricted tunables list of both AIO subsystems:

```
# ioo -F -a
... (lines removed for clarity)
##Restricted tunables
           aio_fastpath = 1
           aio_fsfastpath = 1
           aio_kprocprio = 39
           aio_multitidsusp = 1
           aio_sample_rate = 5
           aio_samples_per_cycle = 6
... (lines removed for clarity)
           posix_aio_fastpath = 1
           posix_aio_fsfastpath = 1
           posix_aio_kprocprio = 39
           posix_aio_sample_rate = 5
           posix_aio_samples_per_cycle = 6
           pv_min_pbuf = 512
           sync_release_ilock = 0
```

¹ For more about restricted tunables, see 6.2, “Restricted tunables” on page 241.

In AIX Version 6, both AIO subsystems are loaded by default but not activated - no AIO servers are started at AIX boot time. The AIO servers are automatically started when applications are initiating AIO I/O requests. They stay active as long as they service AIO I/O requests.

There are no more AIO devices in ODM and all their parameters become now tunables using the **ioo** command. The newer **aioo** command is removed.

The following are the key points of this change in more detail.

- ▶ Under the **kdb** command, the **lke** subcommand shows aio subsystems extensions are loaded by default.

```
# kdb
... (lines removed for clarity)
(0)> lke | grep aio
 8 F10006C001C92F00 F1000000906A1000 00005000 00090242
/usr/lib/drivers/posix_aiopin
 9 F10006C001C92E00 F10000009068B000 00016000 00090252
/usr/lib/drivers/posix_aio.ext
11 F10006C001C92D00 F100000090683000 00005000 00090242
/usr/lib/drivers/aiopin
12 F10006C001C92C00 F100000090671000 00012000 00090252
/usr/lib/drivers/aio.ext
(0)>
```

- ▶ The AIX V6 **ioo** command has two new **aio_active** and **posix_aio_active** parameters. These parameters are static and can be changed only by AIX. These **aio_active** or **posix_aio_active** are set to 1 when the corresponding AIO kernel extension has been used and pinned.

```
# ioo -a | grep active
                aio_active = 0
                posix_aio_active = 0
```

- ▶ No AIO servers are started by default. The name of the kernel process managing the AIO subsystem is “**aioLpool**” for **Legacy** and “**aioPpool**” for **Posix**.

```
# pstat -a | grep aio
22 a  16060      1 16060      0    0    1 aioPpool
28 a  1c08a      1 1c08a      0    0    1 aioLpool
# ps -k | grep aio
 90208      - 0:00 aioPpool
114826      - 0:00 aioLpool
```

- ▶ In AIX Version 6, AIO subsystems are no longer devices in the ODM.

```
# oslevel -s
6100-00-00
```

```
# lsattr -El aio0
```

```
lsattr: 0514-519 The following device was not found in the
customized
```

```
device configuration database:
```

```
aio0
```

```
# lsattr -El posix_aio0
```

```
lsattr: 0514-519 The following device was not found in the
customized
```

```
device configuration database:
```

```
posix_aio0
```

- ▶ In AIX Version 6, all AIO subsystems parameters become the **ioo** command tunables.

```
# ioo -a | grep aio
```

```
    aio_active = 0
```

```
    aio_maxreqs = 65536
```

```
    aio_maxservers = 30
```

```
    aio_minservers = 3
```

```
    aio_server_inactivity = 300
```

```
    posix_aio_active = 0
```

```
    posix_aio_maxreqs = 65536
```

```
    posix_aio_maxservers = 30
```

```
    posix_aio_minservers = 3
```

```
    posix_aio_server_inactivity = 300
```

- ▶ In AIX Version 6, the **aioo** command is removed.

```
# aioo
```

```
ksh: aioo: not found.
```

```
# man aioo
```

```
Manual entry for aioo not found or not inst
```

AIO servers are started and stay active as long as they service I/O requests.. A new tunable, `server_inactivity` (`posix_aio_server_inactivity` or `aio_server_inactivity`), is added to the **ioo** command that controls how long in seconds an AIO server sleeps waiting for work. If no work is received during the sleep period, the AIO server exits. Both `posix_aio_server_inactivity` tunable and `aio_server_inactivity` tunable are not restricted tunables.

The main benefit, at the AIX layer, is to free pinned memory and decrease number of processes after a peak workload activity with the AIO subsystem which help lighten the load process scheduling and reduce system resource usage. The `minservers` tunable becomes an active floor and indicates the number of servers that stay available to service I/O requests.

Note: The default minservers tunable value is 3 and becomes a per-CPU tunable.

The number of active servers stays between the minservers and maxservers values, depending on the number of concurrent I/O requests to service. That's why value changes to minservers and maxservers do not result in a synchronous change in the number of available servers in the system.

The server_inactivity tunable (the number of seconds an AIO server sleeps) can be changed at anytime to any valid value. The servers that are already sleeping with the old time value will continue to sleep for the old time value. Any servers going to sleep after the value is changed will use the new value.

The maxreqs tunable controls the number of requests the AIO subsystem allows. This includes the I/O operations in flight and ones queued for the slow path waiting on servers.

Note : The default maxreqs tunable value is 65536 in AIX Version 6.

There are other AIO tunables but their use is restricted and should only be changed under the recommendation of a performance support specialist.

Table 6-3 details values range for each AIO subsystem tunables:

Table 6-3 Values range for each AIO subsystem tunables

Tunable name	Restricted	Type	Default	Minimum	Maximum
fastpath	Yes	Boolean	On		
fsfastpath	Yes	Boolean	On		
kprocprio	Yes	Value	39	0	254
multitidsusp	Yes	Boolean	On		
sample_rate	Yes	Value	5	1	86,400
samples_per_cycle	Yes	Value	6	1	131,072
maxreqs	No	Value	65,536	AIO_MAX	1,048,576
maxservers	No	Value	30	1	20,000
minservers	No	Value	3	0	maxservers
server_inactivity	No	Value	300	1	86,400

Tunable name	Restricted	Type	Default	Minimum	Maximum
active	Read-Only	Boolean			

6.3.4 NFS default tunables

With AIX Version 6, RFC 1323 on TCP/IP stack is enabled by default as the default read/write size increased to 64 KB for TCP connections. This allows TCP connections to use the TCP scaling window for NFS client server connections.

The default number of biod daemon has also increased to 32 biod daemons per NFS V3 mount point.

6.4 Hardware performance monitors

To advance in the state of high performance computing offerings for IBM clients in computationally intensive industries, including automotive, aerospace, petroleum, meteorology and life science, the design of POWER processors has extra hardware components inserted in each processor to count specific performance processor metrics.

These hardware counters are non intrusive, very accurate, and are specific for each processor generation.

Since the POWER3™ processor, AIX provides a suite of performance-related tools and libraries to assist in application tuning by gathering these low-level metrics that are critical to performance on IBMs server offerings, including System p, System x™, and Blue Gene® systems running both AIX and Linux.

This performance metrics subsystem is divided into two layers:

- ▶ Performance Monitor (PM)

The Performance Monitor provide a service to read these hardware counters registers, and defines several 64-bit context counters (thread context, process context, to name a few) to get the metrics of a specific process tree instead of all activities on each processor.

- ▶ Hardware Performance Monitor (HPM)

HPM is able to gather for an application the usual timing information, as well as critical hardware performance metrics, reported by PM layer such as the number of misses on all cache levels, the number of floating point instructions executed, and the number of instruction loads that cause TLB misses. These help the algorithm designer or programmer identify performance issues.

The PM, HPM tools and APIs are provided by the AIX bos.pmapl.tools fileset.

6.4.1 Performance Monitor (PM)

The performance monitor consists of:

- ▶ Three AIX commands:
 - The **pmctl** command, whose description is not included in the AIX documentation, is found in the /usr/pmapl/tools directory. Like others commands in AIX Version 6, the help command panel is displayed using the -h flag. This command controls the state of the PMAPI subsystem, and the hardware events that are to profile.

```
# pwd
/usr/pmapl/tools
# ls
hpmcount hpmstat pmctl pmcycles pmlist
```

- The **pmcycles** command, which returns the processor clock and decremter speeds:

```
# pmcycles -m
CPU 0 runs at 4208 MHz
CPU 1 runs at 4208 MHz
# pmcycles -d
This machine runs at 4208 MHz
The decremter runs at 512.0 MHz (1.95 ns per tick)
```

- The **pmlist** command, which lists information about supported processors, and displays information about processor clocking, events, events groups and sets, and derived metrics. The following example shows the number of hardware counters and associated profiled events for some selected processors:

```
# pmlist -p POWER3 -c -1 | grep Counter
==== Counter 1, #events: 51
==== Counter 2, #events: 40
==== Counter 3, #events: 31
==== Counter 4, #events: 32
==== Counter 5, #events: 26
==== Counter 6, #events: 23
==== Counter 7, #events: 24
==== Counter 8, #events: 16
# pmlist -p RS64-II -c -1 | grep Counter
==== Counter 1, #events: 114
==== Counter 2, #events: 32
==== Counter 3, #events: 32
```



```

==== Counter 4, #events: 32
==== Counter 5, #events: 22
==== Counter 6, #events: 18
==== Counter 7, #events: 18
==== Counter 8, #events: 16
# pmlist -p POWER5 -c -1 | grep Counter
==== Counter 1, #events: 214
==== Counter 2, #events: 206
==== Counter 3, #events: 193
==== Counter 4, #events: 197
==== Counter 5, #events: 1
==== Counter 6, #events: 1
# pmlist -p POWER6 -c -1 | grep Counter
==== Counter 1, #events: 355
==== Counter 2, #events: 365
==== Counter 3, #events: 347
==== Counter 4, #events: 348
==== Counter 5, #events: 1
==== Counter 6, #events: 1

```

- ▶ The libpm.a instrumentation library is a low-level application programming interface providing a service to read hardware counters registers, and several 64-bit context counters (thread context, process context,...). Both 32-bit and 64-bit applications are supported, as long all modules are compiled in one of the two modes. The following libraries content show both 32-bit and 64-bit library modules:

```

# ar -t -X32_64 libpmapi.a
shr.o
shr_64.o

```

Note: When using AIX V6.1 and subsequent releases, the following AIX command returns the processor speed in hertz (Hz):

```

# lsattr -El proc0 | grep frequency
frequency 4208000000 Processor Speed False

```

6.4.2 Hardware Performance Monitor (HPM)

The hardware performance monitor consists of:

- ▶ Two tools or AIX commands:
 - A **hpmcount** utility, which starts an application and provides at the end of execution, wall-clock time, hardware performance counters information, derived hardware metrics, and resource utilization statistics.

- A **hpmstat** utility to collect system level hardware performance counters information.
- ▶ An **libhpm.a** instrumentation library (or the thread safe version **libhpm_r.a** for threaded applications). The **hpm** libraries are higher-level instrumentation libraries based on the **pmapi** library and **libm** library. Therefore, the **-lpmapi -lm** library references must be specified when compiling applications using **hpm** libraries. Both 32-bit and 64-bit applications are supported, as long as all modules are compiled in one of the two modes. The following libraries show both 32-bit and 64-bit library modules:

```
# ar -t -X32_64 libhpm.a
shr.o
shr_64.o
# ar -t -X32_64 libhpm_r.a
shr.o
shr_64.o
```

6.4.3 AIX V6.1 PM and HPM enhancements

In this section, only the major end-user enhancements to PM and HPM toolkits are described.

For more detailed information about the Performance Monitoring API enhancements, like the PMAPI subroutines description, review the following *AIX Version 6.1 Performance Tools Guide and Reference*, SC23-5254.

Enhancing tracing performance

With AIX V6.1, the trace system of the PMAPI library **pmsvcs** is now implemented with the AIX Component Trace system in standard mode. In previous AIX versions, the trace system was activated at compilation time setting the **DEBUG** flag and implemented through a collection of **printf()** instructions.

One drawback of the previous PMAPI trace system is that when trace system is compiled, information is output using **printf()** routine that involves CPU resource. The goal of any software instrumentation is to minimize its resource usage as it is not possible to eliminate the necessary tooling required. With these enhanced PMAPI and HPM toolkit, the performance is as close as possible to the current instrumented software.

One additional benefit of this enhancement is to avoid re-compiling software to switch on/off the PMAPI trace system. The **ctctr1** command is now able to switch on/off the PMAPI trace system.

The following example shows how to switch on/off the PMAPI subsystem through the AIX Component Trace system:

```
# ctctrl -q
```

Component name	Have alias	Mem Trc /level	Sys Trc /level	Buffer size /Allocated
aio	NO	OFF/3	ON/3	0/ NO
dump				
...(lines missing for clarity)				
pmsvcs	NO	OFF/3	ON/3	0/ NO

```
# ctctrl memtraceon -c pmsvcs
# ctctrl -q -c pmsvcs
```

Component name	Have alias	Mem Trc /level	Sys Trc /level	Buffer size /Allocated
pmsvcs	NO	ON/3	ON/3	0/ NO

```
# ctctrl systraceoff -c pmsvcs
# ctctrl memtraceoff -c pmsvcs
# ctctrl -q -c pmsvcs
```

Component name	Have alias	Mem Trc /level	Sys Trc /level	Buffer size /Allocated
pmsvcs	NO	OFF/3	OFF/3	0/ NO

```
# ctctrl systraceoff -c pmsvcs
```

While running the pmsvcs trace system, high amounts of trace launched per seconds can occur (the value of 40,000 traces have been reached during internal tests).

Timing with nanosecond granularity

With AIX V6.1, to acquire accurate timing information, HPM now relies on a libpmapapi call wherein timing information is returned in a `timebasestruct_t` with nanosecond granularity. This new call has also less performance restrictions. In previous versions, HPM was using `gettimeofday()` with a microsecond granularity.

Time counter or time measurement

The execution time of a program is the CPU time which means the amount of time a program uses the CPU.

This amount of time is measured counting the number of execution dispatches that are accumulated in a so-called time counter, usually implemented as a register in POWER processors. The values of these time counters, real events counters, are converted to time using the `time_base_to_time` subroutine.

A new option (-b time | purr | spurr) is added to **hpmcount** and **hpmstat** commands to select a time base normalization for time collected data based on purr register or spurr register when available depending on processor type. By default, hpmcount and hpmstat report time counter base on the timebase register like in the previous AIX versions.

```
hpmcount [-b time | purr | spurr]
hpmstat [-b time | purr | spurr]
```

The time-base register is incremented each time a thread is dispatched for execution on the processor or core.

PURR register

The Processor Utilization Resource Register (purr) is what counts every time the hardware thread is dispatched for execution on the processor. As POWER5™ and POWER6 processors supported two hardware threads, there are two purr registers per processor (or core). The sum of the two purr registers is equal to all the times a thread was dispatched which is the time base register.

SPURR register

The Scaled Performance Utilization Resources Register (spurr) is new on POWER6. This results from the electrical power and thermal dissipation management technology introduced as part of POWER6 system design.

This energy management done by the chip allows it to throttle the fetch and dispatch bandwidth to keep power down increasing the CPI (cycles per instruction). As the cycles per instruction are increasing, the instruction takes more time and the execution flow decreases. Thus, the processor activity is slower and so, cooler. The spurr value is similar to purr value, except that spurr value scales as a function of the degree of processor throttling. Spurr values are proportional to the fetch or the instruction dispatch rate the processor.

Measuring time-base data based on purr or spurr registers provides a more accurate measurement to hpmcount and hpmstat instrumentation tools on servers based on POWER5 and POWER6 processors.

A new variable environment HPM_NORMALIZE switches **hpmstat** and **hpmcount** command reports from timebase to purr or spurr normalization. This avoids to re-write procedures and scripts to take benefit of this new option. The option -b takes precedence over this variable.

```
HPM_NORMALIZE=[time] [purr] [spurr]
```

HPM data post processing

With AIX Version 6, the **hpmstat** and **hpmcount** commands produce results in XML format output file using the new -x option.

```
hpmstat -o <file> -x  
hpmstat -o <file> -x
```

This XML output file format allows a post-processing by the Visual Performance Analyzer (VPA). VPA is an Eclipse-based visual performance toolkit which runs on Windows®, AIX, and Linux. It is proposed to IBM clients as an Alphaworks project at:

<http://www.alphaworks.ibm.com.tech/vpa>



7

Networking

AIX Version 6 provides updates and new networking features that are covered in the following sections:

- ▶ 7.1, “Internet Group Management Protocol Version 3” on page 272
- ▶ 7.2, “Network Data Administration Facility enhancements” on page 274
- ▶ 7.3, “Enabling SSL support for FTP” on page 277
- ▶ 7.4, “NFS proxy serving enhancements” on page 278
- ▶ 7.5, “Network caching daemon” on page 284
- ▶ 7.6, “IPv6 RFC compliances” on page 291

7.1 Internet Group Management Protocol Version 3

Internet Group Management Protocol (IGMP) is the protocol used by hosts and multicast routers to establish multicast group memberships within a physical network. It allows hosts to participate in IP multicasting according to RFC 1112, where the basics and specifics are described. A sender does not have to be a member of a multicast group to send packets to such a group. The IGMP protocol allows routers to act as members of one or more multicast groups, performing both, the *multicast router part* and *group member part* of the protocol.

AIX V6.1 provides the host side function, group member part of the IGMP Version 3 (IPMGv3) protocol. The AIX V6.1 IGMPv3 implementation adheres to RFC 3376 and includes the new Socket Interface Extensions for Multicast Source Filters.

The AIX V6.1 IPMGv3 implementation allows backward compatibility with the previous two versions of the protocol, IPMG version 1 (IGMPv1) and IPMG version 2 (IGMPv2), as they are supported in AIX 5L releases.

IGMPv1 allows hosts to join multicast groups. In this version there are no leave messages. Routers use a time-out based mechanism to discover which hosts dropped their membership. Routers periodically send host membership queries to the all-hosts group. Each host starts a random delay timer before issuing a host membership report on the interface where they receive the query. Once the smaller timer expires, this host sends a report that all the other hosts receive causing their timers to stop since only one report is needed by the router for that group in the sub net.

In IGMPv2 leave messages were added to reduce the bandwidth wasted during the leave latency period. A host leaves a group by sending a leave message to the all-routers group (IP address 224.0.0.2). When the router receives a leave message, it sends a group-specific query to the multicast group that is being left and not to the all-hosts group as in IGMPv1.

IGMPv3 allows hosts to specify a list of sources from which they do not want to receive traffic; blocking any host that is in the list. On the other hand, it also allows a host to specify a list of sources from which they want to receive traffic only. In other words, it allows for source filtering, that is, receive packets only from specific source addresses, or from all but specific source addresses. IGMPv3 protocol sets the standards on how this information is transmitted across hosts and routers and the relevant messages are transmitted in IP datagrams with protocol number of 2 (IPPROTO_IGMP).

IGMPv3 allows finer control over the multicast packets forwarded to the subnetwork and may conserve link capacity, especially when a system switches from receiving one multicast group to another.

Under the AIX V6.1, IGMPv3 protocol implementation two distinct multicast modes are available:

Any-source multicast All sources are accepted by default, and any unwanted source is turned off and back on as needed. This is also called *exclude* mode.

Source-specific multicast Only sources in a given definition list are allowed. This is also called *include* mode.

According to the previously mentioned multicast modes, IGMPv3 capable hosts have the ability to set source filters and configure multicast groups by using the following socket options:

IP_ADD_MEMBERSHIP	This option is used to request that the host joins an any-source multicast group.
IP_DROP_MEMBERSHIP	This option is used to leave an already joined multicast group.
IP_BLOCK_SOURCE	This option is used to block data from a given source to a multicast group and refers to the any-source multicast implementation.
IP_UNBLOCK_SOURCE	This option is used to unblock a previously blocked source address and refers to the any-source multicast implementation.
IP_ADD_SOURCE_MEMBERSHIP	This option is used to add the membership as well as to allow data from the given source address to the given multicast group. The source-specific multicast implementation is facilitated by this option.
IP_DROP_SOURCE_MEMBERSHIP	This option is used to remove a source address from the list of included addresses. The source-specific multicast implementation is facilitated by this option.

The `setsockopt()` system call has to be utilized to set the new options associated with a socket. Hence, this subroutine provides an application with the means to include or exclude source-specific addresses for each multicast group.

Note, that the first two options previously listed, IP_ADD_MEMBERSHIP and IP_DROP_MEMBERSHIP are also available in IGMPv2 but the remaining four options are only provided through the IGMPv3 protocol implementation.

There are four socket options exclusive to IGMPv3:

- ▶ IP_BLOCK_SOURCE
- ▶ IP_UNBLOCK_SOURCE
- ▶ IP_ADD_SOURCE_MEMBERSHIP
- ▶ IP_DROP_SOURCE_MEMBERSHIP

They require to use the new ip_mreq_source structure. This structure is similar to the traditional ip_mreq structure but it contains the new variable imr_sourceaddr to pass the source address for source filtering through the setsockopt system call. The ip_mreq_source structure is defined in the /usr/include/netinet/in.h header file as follows:

```
struct ip_mreq_source {
    struct in_addr  imr_multiaddr; /* IP multicast address of group */
    struct in_addr  imr_sourceaddr; /* IP address of source */
    struct in_addr  imr_interface; /* local IP address of interface */
};
```

RFC 3376 can be referenced to understand how the multicast reception state is maintained by systems at the socket and the interface layers.

When a multicast packet arrives at the IP layer, the interface reception state is looked up before accepting/dropping the packet. After the packet is accepted by the IP layer and passed up to the UDP layer, the socket reception state is looked up before the packet is delivered on the socket's receive buffer.

Filtering of packets based upon a socket's multicast reception state is a new feature of IGMPv3. The previous protocols [RFC1112] described no filtering based upon multicast join state; rather, a join on a socket simply caused the host to join a group on the given interface, and packets destined for that group could be delivered to all sockets whether they had joined or not.

7.2 Network Data Administration Facility enhancements

Network Data Administration Facility (NDAF) is a component introduced in AIX 5L. In AIX V6.1, it is enhanced. For basic information about NDAF itself, see *AIX 5L Differences Guide Version 5.3 Addendum*, SG24-7414.

The enhancements additional enhancements discussed are as follows:

- ▶ Integration of NDAF to the base AIX V6.1 distribution

- ▶ New commands
- ▶ NDAF SMIT fastpaths
- ▶ NDAF logs online information
- ▶ NDAF data transfer methods

The enhancements (except 7.2.5, “NDAF data transfer methods” on page 276) described in the following sections are also applied to AIX V5.3 TL6 and later.

7.2.1 Integration of NDAF to the base AIX V6.1 distribution

Previously mentioned, NDAF itself is not new function in Version 6.1. It was shipped as a package of extension pack from AIX V5.3 TL5. NDAF is now integrated on AIX V6.1 base packages (see Example 7-1).

Example 7-1 NDAF packages for AIX V6.1

```
# lslpp -L ndaf*
Fileset                Level  State  Type  Description (Uninstaller)
-----
ndaf.base.admin        6.1.0.0  C     F     Network Data Administration
                        Facility admin server
ndaf.base.client       6.1.0.0  C     F     Network Data Administration
                        Facility client
ndaf.base.server       6.1.0.0  C     F     Network Data Administration
                        Facility server
```

State codes:

- A -- Applied.
- B -- Broken.
- C -- Committed.
- E -- EFIX Locked.
- O -- Obsolete. (partially migrated to newer version)
- ? -- Inconsistent State...Run lppchk -v.

Type codes:

- F -- Installp Fileset
 - P -- Product
 - C -- Component
 - T -- Feature
 - R -- RPM Package
 - E -- Interim Fix
-

7.2.2 NDAF commands

In AIX V6.1 and AIX V5.3 TL6 provides new commands to prepare systems for running its processes.

- ▶ The **mkndaf** command configures the system to run NDAF.
- ▶ The **chndaf** command changes various parameter settings used by the **dms** command and **dmadm** command.
- ▶ The **lsndaf** command displays the configuration used by the NDAF daemons.
- ▶ The **rmndaf** command configures the system to stop running NDAF daemons.

7.2.3 NDAF SMIT fastpaths

You can use SMIT fastpaths to go directly to your NDAF panel of choice, rather than navigate there screen by screen. You can see the table that describes fastpath, screen name, and descriptions on AIX V6.1 online manual.

7.2.4 NDAF logs online information

NDAF logs are described in the online product documentation. In the manual, you can read the following contents:

- ▶ Log messages path
- ▶ Log detail levels
- ▶ Log messages format
- ▶ Process types in log files

7.2.5 NDAF data transfer methods

The rsync transfer method was not enabled in AIX V5.3. From AIX V5.3 TL6 and forward, the rsync transfer method can now be used. So, there are two methods of data transfer now:

copy	Performs data transfer using full file tree copy. The copy method implements the data transfer method plugin interface and performs a data transfer operation by doing a complete walk of the directory tree for the data set and transmitting all objects and data to the target.
rsync	Performs data transfer using rsync-like algorithm. The rsync method performs a data transfer operation by doing a complete walk of the directory tree for the data set and

transmitting only deltas for directories and data to the target. It is beneficial when updating replicas because it only sends changed blocks of information, so it reduces network bandwidth considerably.

Important: On AIX V6.1, if you want to use the rsync methods, you need to install the clic.rte fileset (from expansion CD-ROM). If you do not install it, the copy method will be used.

7.2.6 NDAF case study

The online manual was updated in AIX V6.1 to include use cases descriptions. These use cases deal with:

- ▶ Configuring a Kerberos-enabled NDAF domain
- ▶ Federating data from two distant sites and replicating data to enhance network affinity
- ▶ Add an existing server with NFS exported data to an NDAF cell namespace without installing NDAF on it.

7.3 Enabling SSL support for FTP

AIX V6.1 introduces a secure version of **ftp** (and **ftpd**), based on OpenSSL, using Transport Layer Security ¹(TLS) to encrypt both the command and the data channel. TLS is a cryptographic protocol that provides secure communication between clients and servers. This enables any user on the system to exchange files in a secure manner if their counterpart offers this extension as well.

While at first look, using secure **ftp** only and no secure **telnet** might not be most desirable, this method is in fact a reasonable alternative for environments where you are not able to use OpenSSH. For example, if your most trusted systems run on a dedicated and segregated network, it makes sense to use **telnet** for remote access within that very network zone (or working from the console).

But even in such scenarios you might need to transfer data from or to this secure zone, which can be accomplished now by using secure FTP.

Another scenario might be when you use OpenSSH already but you still have to exchange data with outside systems that do not support any form of SSH

¹ This extension to FTP is defined in RFC 4217.

(therefore neither **scp** nor **sftp**). Most often, such systems offer FTP over ssl (often called **ftps**) instead.

Since TLS relies on Secure Sockets Layer, make sure OpenSSL is installed on your AIX system (**ftp -s** depends on **libssl.a** and **libcrypto.a**). OpenSSL (0.9.8) is needed. It is shipped with AIX V6.1 as **openssl.base** fileset (See Example 7-2).

Example 7-2 OpenSSL filesets

```
# lsipp -L openssl*
Fileset                Level  State  Type  Description (Uninstaller)
-----
openssl.base           0.9.8.4  C     F     Open Secure Socket Layer
openssl.license        0.9.8.4  C     F     Open Secure Socket License
```

State codes:

A -- Applied.
 B -- Broken.
 C -- Committed.
 E -- EFIX Locked.
 O -- Obsolete. (partially migrated to newer version)
 ? -- Inconsistent State...Run **lppchk -v**.

Type codes:

F -- Installp Fileset
 P -- Product
 C -- Component
 T -- Feature
 R -- RPM Package
 E -- Interim Fix

The changes of **ftp** command and **ftpd** daemon are documented elsewhere, To configure FTP over OpenSSL, see online product documentation and the *AIX V6 Advanced Security Features Introduction and Configuration*, SG24-7430.

7.4 NFS proxy serving enhancements

With AIX V5.3 Technology Level 5300-05, NFS proxy serving has been introduced. You can use an NFS proxy server to potentially extend NFS data access over slower or less reliable networks with improved performance and reduced network traffic to the back-end server where the data resides. NFS

proxy server uses a cache file system to provide faster data access to the NFS clients. It supports both NFSv3 and NFSv4 protocols.

AIX V6.1 introduces the following enhancements to NFS proxy serving:

- ▶ Comprehensive RPCSEC_GSS Kerberos support from client to proxy and back-end communication.
- ▶ Added support for NFSv3 clients at the proxy for an NFSv4 back-end server
- ▶ Support for NFSv4 global namespace exports within one cachefs
- ▶ The NFS proxy cachefs is now persistent across remounts of the cachefs
- ▶ Cachefs performance improvement and increased file limits

In Figure 7-1, the NFS proxy 1 setup shows the new NFSv3 client support for a back-end NFSv4 server. The NFS proxy 2 setup shows the comprehensive Kerberos support compared to the implementation of previous versions (NFS proxy a).

NFS proxy serving now can be setup with the Web-based System Manager. The new dialogs are explained in 5.1.1, “The mknfsproxy and rmnfsproxy interfaces” on page 194.

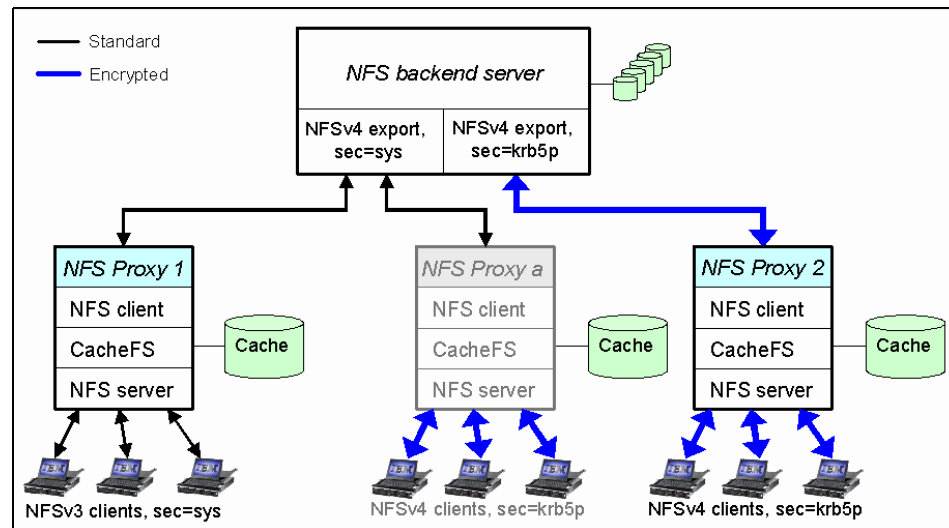

Figure 7-1 NFS proxy serving enhancements

7.4.1 NFS server proxy prerequisites

The following software must be installed on your systems:

- ▶ NFS client fileset:
 - bos.net.nfs.client
- ▶ NFS proxy server filesets:
 - bos.net.nfs.client
 - bos.net.nfs.server
 - bos.net.nfs.cachefs
- ▶ NFS server fileset:
 - bos.net.nfs.server

If you want to use the RPCSEC_GSS Kerberos security method, you must install the following additional filesets and have an configured Kerberos server in your network:

- ▶ clic.rte
- ▶ krb5.client.rte
- ▶ krb5.client.samples
- ▶ krb5.lic

7.4.2 Comprehensive RPCSEC_GSS Kerberos support

With the previous NFS proxy serving version RPCSEC_GSS, Kerberos was only supported between the NFS client and the NFS proxy server. The communication between the proxy server and the back-end server had to be done with the auth_sys security methods. AIX V6.1 introduces the ability to benefit from the stronger Kerberos methods (krb5, krb5i, krb5p) through all three involved components: NFS client <-> NFS proxy <-> NFS server.

On the NFS client, you have to obtain a valid forwardable ticket. This same ticket is then used by the NFS proxy to authenticate it self and establish a security context with the NFS server.

In this section we will go trough a step by step tutorial to achieve the following NFS setup:

- ▶ The NFS server *lpar03* exports the */projects/project1* file system with the NFS options *sec=krb5p* and *vers=4*
- ▶ The NFS proxy server *lpar02* is providing the *lpar01* access to the */projects/project1* NFS export
- ▶ The NFS client *lpar01* mounts */projects/project1* to */project1* on his system

NFS server export

Use the following `mknfsexport` command on the NFS server to export the `/projects/project1` file system:

```
# mknfsexp -d /projects/project1 -v 4 -S krb5p
```

NFS proxy set up

In order to set up the proxy file system, you need to meet the following requisites:

- ▶ The proxy server has to have a machine principle.
- ▶ You need a user principle with a valid ticket. The ticket is used only during the mount operation. If the tickets is expired, the clients will still have access to the NFS data through the NFS proxy.

1. Obtain a valid Kerberos ticket first:

```
# /usr/krb5/bin/kinit nim
```

2. Use the `klist` command to verify if you obtained a valid ticket:

```
# /usr/krb5/bin/klist
Ticket cache: FILE:/var/krb5/security/creds/krb5cc_0
Default principal: nim@REALM1.IBM.COM
```

```
Valid starting    Expires          Service principal
10/15/07 13:49:47  10/16/07 13:49:33
krbtgt/REALM1.IBM.COM@REALM1.IBM.COM
```

3. Use the following `mknfsproxy` command to setup the NFS proxy serving:

```
# mknfsproxy -c /cache/projects/project1 -d /projects/project1 \
-m vers=4,sec=krb5p lpar03:/projects/project1 \
-e vers=4,sec=krb5p
```

NFS client mount

To obtain a forwardable ticket you need to run the following command:

```
# /usr/krb5/bin/kinit -f nim
```

1. Use the `klist` command to verify if you obtained a valid ticket:

```
# /usr/krb5/bin/klist
Ticket cache: FILE:/var/krb5/security/creds/krb5cc_0
Default principal: nim@REALM1.IBM.COM
```

```
Valid starting    Expires          Service principal
10/15/07 20:52:22  10/16/07 20:51:49
krbtgt/REALM1.IBM.COM@REALM1.IBM.COM
```

2. Use the **mount** command to make the file system available. No special options are required to mount a proxy NFS export.

```
# mount -o vers=4,sec=krb5p lpar02:/projects/project1 /project1
```

Considerations

The following are considerations when using Kerberos in an NFS environment.

- ▶ The NFS proxy does not support a security list. For example you cannot specify the two security versions `krb5i` and `auth_sys` for the front-end export.
- ▶ The back-end NFS server does not have to be an AIX system. The system has to be able to handle Kerberos authentication through NFS.
- ▶ The actual client does not have to be an AIX system. The system must be able to handle and give out forwardable tickets.

7.4.3 NFSv3 exports for back-end NFSv4 exports

With AIX V6.1 and later it is possible to create an NFSv4 proxy export for NFSv3 clients. In previous versions, the NFS protocol used at the back-end NFS server had to be the same as for the NFS proxy export. The following combinations are now supported (Table 7-1):

Table 7-1 NFS protocol support for NFS proxy serving

Back-end protocol	Front-end protocol
NFSv3	NFSv3
NFS v4	NFSv3
NFSv4	NFSv4

Exporting an NFSv4 back-end as an NFSv3 front-end export improves integration between the two protocols. It provides you a valuable migration tool and adds flexibility to migration scenarios when moving from an NFSv3 to NFSv4 environment.

Use the following **mknfsproxy** command on the NFS proxy server to set up an NFSv4 back-end as an NFSv3 front-end export:

```
# mknfsproxy -c /cache/projects/project2 -d /projects/project2 \
-m vers=4 lpar03:/projects/project2 -e vers=3
```

7.4.4 NFSv4 global namespace

In previous AIX versions it was not possible to create an NFS proxy export on an NFSv4 back-end export using the global namespace access (also known server pseudo file system or pseudo root) within a single cachefs. You were able to mount the back-end nfsroot and then create manually a separate cachefs for each back-end export.

AIX V6.1 enables the system administrator to mount the global namespace and create a single cachefs. A new **mount** command option **mfsid** is introduced and can be specified within the **mknfsproxy** command:

```
# mknfsproxy -c /cache/projects -d /projects -m vers=4,mfsid \
lpar03:/ -e vers=4
```

Example 7-3 shows the views of the global namespace export from the NFS server, NFS proxy, and NFS client.

Example 7-3 Global namespace export view from server, proxy, and client

```
lpar03, NFS server:
```

```
# exportfs
/projects/project1 -vers=4
/projects/project2 -vers=4
```

```
lpar02, NFS proxy server:
```

```
# nfs4cl showfs
```

Server	Remote Path	fsid	Local Path
-----	-----	-----	-----
lpar03.itsc.austin.ibm.com	/projects/project1	0:42949672977	
	/cache/projects/.cfs_mnt_points/_/projects/project1		
lpar03.itsc.austin.ibm.com	/projects/project2	0:42949672978	
	/cache/projects/.cfs_mnt_points/_/projects/project2		
lpar03.itsc.austin.ibm.com	/	0:42949672964	
	/cache/projects/.cfs_mnt_points/_		
	# exportfs		
	/projects -vers=4		

```
lpar01, NFS client:
```

```
# mount -o vers=4 lpar02:/projects /mnt
# nfs4cl showfs
```

Server	Remote Path	fsid	Local Path
-----	-----	-----	-----

```
lpar02.itsc.austin.ibm.com /projects/projects/project1 0:47244640287
/mnt/projects/project1
lpar02.itsc.austin.ibm.com /projects/projects/project2 0:47244640281
/mnt/projects/project2
lpar02.itsc.austin.ibm.com /projects                0:47244640268
/mnt
# find /mnt -type d
/mnt
/mnt/projects
/mnt/projects/project2
/mnt/projects/project2/lost+found
/mnt/projects/project1
/mnt/projects/project1/lost+found
```

7.4.5 Cachefs improvements

The following cachefs improvements are introduced with AIX V6.1:

- ▶ Cachefs content is now persistent across remounts
- ▶ Support caching of files larger than 2 GB
- ▶ Can cache up to 1024 KB files
- ▶ The maximum total amount of cached data is increased to 1 TB
- ▶ Improved overall performance through internal enhancements

7.5 Network caching daemon

Today most network-based applications require resolving an Internet host name to an IP address and vice-versa. Latency in this translation procedure directly affects the performance of applications. AIX V6.1 introduces the network caching daemon (netcd) to improve performance for resolver lookups. Netcd in addition can cache user and group information provided by a NIS server.

7.5.1 The netcd architecture

This section describes the architecture of the netcd daemon.

Caching resolver lookups

Applications requiring name resolution place a request to the resolver to do the translation. The resolver does this translation by looking up the corresponding

entry in a database. The database is located either on the local machine (for example `/etc/hosts`) or on a remote machine that provides a name resolution service (for example DNS or NIS). For applications requiring frequent name resolutions of a small subset of host and domain names this process can be inefficient.

The resolver is used by applications to resolve host and domain names to IP address and vice-versa. The queries can be one of the following types:

- ▶ Hosts
- ▶ Protocols
- ▶ Networks
- ▶ Services
- ▶ Netgroup

The resolver utilizes one of the following resources to resolve the query of one of the types:

- ▶ `/etc/hosts`
- ▶ `/etc/networks`
- ▶ `/etc/protocols`
- ▶ `/etc/services`
- ▶ `/etc/netgroup`
- ▶ Domain Name Server (DNS)
- ▶ Network Information Server (NIS)
- ▶ Network Information Server+ (NIS+)
- ▶ Dynamic user loadable module (ULM)

The `netcd` daemon can be used to cache the resolver lookups. Translations for IPv4 and IPv6 are supported. The communication between the resolver and the `netcd` daemon is done with a UNIX socket (`/dev/netcd`).

Note: The `netcd` caching will not affect the resolver behavior in what order the resources are queried. The `NSORDER` environment variable, the `/etc/netsvc.conf` and the `/etc/irs.conf` files are consulted by the resolver in the normal manner.

Caching NIS user and group information

`Netcd` in addition can cache user and group information provided by a NIS server. The queries to the following NIS maps can be cached:

- ▶ `passwd.byname`
- ▶ `passwd.byuid`
- ▶ `group.byname`
- ▶ `group.bygid`
- ▶ `netid.byname`

► passwd.adjunct.byname

The ypcall system calls have been modified to use the netcd daemon if configured. If the requested information is cached, netcd returns the values. If the requested information is not cached, the yplayer requests the information with RPC calls from the NIS server. The response is send back to the yplayer. Before normal NIS processing can continue, the yplayer sends the NIS server response to the netcd daemon for caching the values. All communication between the yplayer and the netcd daemon is achieved with a unix socket (/dev/netcd).

Caching

Caches are held as hashed tables to provide fast access. The netcd daemon will maintain two types of caches based on whether the resource it uses is local or network-based.

Local resources such as /etc/hosts are loaded into local caches at the startup of the netcd daemon. Therefore local caches contain all entries of the corresponding local resource and a resolver request to it will always result in a cached netcd reply. In environments with large local resources, resolver lookups to the hashed cache entries will result in faster response time compared to the traditional linear search of the local resource. The netcd daemon will periodically check if the local resources have changed and if necessary reload them.

The netcd daemon will also cache resolver lookups to a network resource such as DNS. In contrast to local caches, the network caches are created with empty entries during the daemon startup. The netcd daemon will populate the cache with the result of each query at runtime. Negative answers from the resource are cached as well. When an entry is inserted to the cache, a time-to-live (TTL) is associated to it. For DNS queries the TTL value returned by the DNS server is used with default settings. The netcd daemon will check periodically for expired entries and remove them.

7.5.2 netcd AIX integration

The netcd is delivered as part of the bos.net.tcp.client package. Three new important files are introduced with netcd. Table 7-2 provides the function of the new files.

Table 7-2 *New netcd files*

File	Description
/usr/sbin/netcd	The netcd daemon itself.

File	Description
/usr/sbin/netcdctrl	Command to manage netcd daemon caches. Operations include dumping caches, flushing caches, change logging level of netcd and display statistics.
/usr/samples/tcpip/netcd.conf	Sample configuration file for the netcd daemon.

The netcd daemon is part of the tcpip System Resource Controller (SRC) group. You can use the **startsrc**, **stopsrc**, and **lssrc** command to control the daemon. The **refresh** command is not supported.

The daemon is started in /etc/rc.tcpip script during AIX startup. Note that the daemon is not activated by default in AIX V6.1.

There is no SMIT panel available for netcd.

7.5.3 netcd configuration

A netcd sample configuration file is installed in /usr/samples/tcpip/netcd.conf. You can copy the file to the /etc/ directory and use it as a template for your configuration. If the netcd daemon does not detect a configuration file during startup, it will use its default values. The **lssrc -l netcd** command provides you with an overview of the currently active configuration:

```
# lssrc -ls netcd
Subsystem      Group          PID           Status
netcd          netcd          421904        active
Debug          Inactive
Configuration File  /etc/netcd.conf
Configured Cache  local hosts
Configured Cache  dns hosts
```

The /etc/netcd.conf file has four different types of configurations:

- ▶ Caching settings
- ▶ Security settings
- ▶ Log level settings
- ▶ Daemon settings

Caching settings

You can specify what resolver or NIS ypcalls should be cached in this section. Use the following syntax:

```
# cache <type_of_cache> <type_of_map> <hash_size> <cache_ttl>
```

Table 7-3 list the possible values:

Table 7-3 *Caching settings in /etc/netcd.conf*

Attribute	Description
type_of_cache	Declares the type of cache. Possible values are all, local, dns, nis, nisplus, yp. Any other value will be taken as ulm name.
type_of_map	Declares the map to be used to do the lookup. The possible values depends on the chosen cache type. Consult the netcd.conf manpage or look at the sample file for a complete list.
hash_size	Specifies the number of lines used for the cache. An hash table is used to store the cache.
cache_ttl	Declares the time to life for a cache entry. The unit is minutes. The TTL is not used for local resource caches. If you specify an value other than 0 for DNS caches, it will overwrite the TTL of the DNS server response.

The following is an example entry for a DNS cache:

```
cache dns hosts 128 0
```

If no cache statement is present in the configuration file, the default setting for the netcd daemon is:

```
cache all all 128 60
```

Security settings

You can specify under which user and group context a netcd daemon should be run. The default user is root and the default group is system. You are also able to specify an chroot working directory. Default is the / directory.

Declare your settings with the following syntax:

```
owner <username>
group <groupname>
home <homedirectory>
```

Log level settings

The `netcd` daemon creates a log file in `/var/tmp/netcd.log`. You can specify a different logfile location, a logfile size limit in KB, and the number of logfile rotations. The default setting is no size limit and therefore no rotations are taken. Use this syntax to change the settings:

```
log_file <file>
log_rotate <number>
log_size <number>
```

Daemon settings

This settings influence the daemon operations. Table 7-4 lists the valid key and value pairs:

Table 7-4 *netcd* daemon settings

Key	Valid values	Default	Description
<code>net_scan_frequency</code>	<number>	1	Specifies how often the <code>netcd</code> daemon looks for expired cache entries in network caches. The unit is minutes.
<code>local_scan_frequency</code>	<number>	1	Specifies how often the <code>netcd</code> daemon checks for changes to the local resources. The unit is minutes.
<code>socket_queue_size</code>	<number>	256	Indicates the message queue size. Unit is the number of outstanding requests.

7.5.4 Managing `netcd`

You can use the new `netcdctl` command to manage the `netcd` daemon. This section gives you examples of all operations supported with the `netcdctl` command. All operations except for the logging level change, accept those flags to control the cache selection:

```
-t <type_of_cache>
-e <type_of_map>
```

Dump cache content

With the `netcdctl` command you can dump the cache contents to a file. The dump can be either in binary or ascii format. To dump the DNS cache in ASCII format use the following command:

```
Hash index : 55, Max number of entries : 0, Current number of entries : 0
Hash index : 56, Max number of entries : 1, Current number of entries : 0
END CACHE dns, hosts, name
```

Flush caches

You can manually flush the caches with the following command:

```
# netcdctl -t dns -e hosts -f
```

If you flush a local resource cache, the local resource will be reloaded automatically. Use the following command if you changed the /etc/hosts local resource and you want to notify the netcd daemon immediately:

```
# netcdctl -t local -e hosts -f
```

Change logging level of netcd daemon

You can change the logging level of the netcd daemon dynamically. No restart of the daemon is necessary.

```
# netcdctl -l 7
```

The Table 7-5 list the available and default log levels:

Table 7-5 netcd logging levels

Log level	Log detail
0	No logging
3 (the default)	Errors (the default)
4	Warnings
5	Notice
6	Info
7	Debug

7.6 IPv6 RFC compliances

The IPv6 implementation in AIX V6.1 is compliant to RFC 4007 and RFC 4443 as published by the Internet Engineering Task Force (IETF).

7.6.1 RFC 4007 - IPv6 Scoped Address Architecture

RFC 4007 describes the scoped address architecture. AIX V6.1 introduces scope zone support as specified in the RFC.

AIX will automatically assign an unique, consecutive number as zone id. If you need to provide a specific zone id, you can specify the desired zone ID value within the **ifconfig** command:

```
# ifconfig en1 inet6 fe80::6888:8eff:fe61:6606%9/64
```

You can use the **netstat** command to display the assigned zone IDs:

```
# netstat -in
```

Name	Mtu	Network	Address	ZoneID	Ipkts	Ierrs	Opkts	Oerrs	Coll
en0	1500	link#2	6a.88.8e.61.66.2		5944	0	329	0	0
en0	1500	9.3.4	9.3.5.112		5944	0	329	0	0
en0	1500	fe80::6888:8eff:fe61:6602		1	5944	0	329	0	0
sit0	1480	link#3	9.3.5.112		0	0	0	0	0
sit0	1480	::9.3.5.112		3	0	0	0	0	0
en1	65394	link#4	6a.88.8e.61.66.5		156	0	2	0	0
en1	65394	fe80::6888:8eff:fe61:6606		9	156	0	2	0	0
lo0	16896	link#1			350	0	353	0	0
lo0	16896	127	127.0.0.1		350	0	353	0	0
lo0	16896	::1		2	350	0	353	0	0

<http://www.ietf.org/rfc/rfc4007.txt>

7.6.2 RFC 4443 - Internet Control Message Protocol ICMPv6

RFC 4443 describes the Internet Control Message Protocol ICMPv6. ICMPv6 is based on ICMPv4 with enhancements made for the use with IPv6. AIX V6.1 implements the message type and message code changes as defined in RFC 4443, which obsoletes the older ICMPv6 RFC 2463.

<http://www.ietf.org/rfc/rfc4443.txt>



Security, authentication, and authorization

The following enhancements are available in AIX Version 6.1 regarding security, authentication, and authorization:

- ▶ 8.1, “/admin/tmp system directory” on page 294
- ▶ 8.2, “AIX Security Expert enhancements” on page 296
- ▶ 8.3, “Enhanced Role Based Access Control” on page 305
- ▶ 8.4, “Web-based GUI for RBAC” on page 316
- ▶ 8.5, “LDAP support enablement” on page 319
- ▶ 8.6, “RBAC and Workload Partition environments” on page 321
- ▶ 8.7, “Enhanced and existing mode switch” on page 323
- ▶ 8.8, “Trusted AIX” on page 324
- ▶ 8.9, “Trusted Execution Environment” on page 337
- ▶ 8.10, “Password length and encryption algorithms” on page 343

8.1 /admin/tmp system directory

Beginning with AIX V6.1 the operating system provides a dedicated system directory /admin/tmp where privileged processes can securely create temporary files. The /admin/tmp directory resides within the /admin file system which in turn is defined on the newly implemented /dev/hd11admin system logical volume. You can use the standard **ls**, **lsfs**, and **lslv** AIX commands to list the properties of the directory, mount point, file system, and logical volume respectively:

```
hhaix6:root:/ # ls -el /admin
total 0
drwxr-xr-x-  2 root      system      256 Nov 05 11:23 lost+found
drwxr-xr-x-  2 root      system      256 Oct 05 21:54 tmp

hhaix6:root:/ # ls -eld /admind
rwxr-xr-x-   4 root      system      256 Nov 05 11:23 /admin

hhaix6:root:/ # lsfs /admin
Name          Nodename    Mount Pt   VFS   Size   Options  Auto Accounting
/dev/hd11admin --          /admin    jfs2  262144 --      yes  no

hhaix6:root:/ # lslv hd11admin
LOGICAL VOLUME:      hd11admin          VOLUME GROUP:  rootvg
LV IDENTIFIER:       00cc72be00004c000000011610d0c243.10 PERMISSION:
read/write
VG STATE:            active/complete   LV STATE:       opened/syncd
TYPE:                jfs2              WRITE VERIFY:   off
MAX LPs:             512              PP SIZE:        64 megabyte(s)
COPIES:              1                SCHED POLICY:   parallel
LPs:                 2                PPs:            2
STALE PPs:           0                BB POLICY:      relocatable
INTER-POLICY:        minimum           RELOCATABLE:    yes
INTRA-POLICY:        center            UPPER BOUND:    32
MOUNT POINT:         /admin           LABEL:          /admin
MIRROR WRITE CONSISTENCY: on/ACTIVE
EACH LP COPY ON A SEPARATE PV ?: yes
Serialize IO ?:      NO
```

As shown by the previous **ls** command listings, the /admin mount point and the /admin/tmp directory are owned by the root user and the system group and have the discretionary access control mode of 755. This makes the /admin/tmp directory only writable by the root user where as the traditional /tmp directory is world writable.

All new LVM objects are created by the **/usr/lpp/bosinst/bi_main** script during the base operating system installation. The configuration parameters for the hd11admin logical volume and the /admin file system are taken from the relevant

lv_data and fs_data stanzas in /var/adm/ras/image.data. The `bi_main` script also adds the appropriate stanza for the /admin file system to the /etc/filesystems file.

```
hhaix6:root:/ # pg /etc/filesystems
```

```
... omitted lines ...
```

```
/admin:
    dev      = /dev/hd11admin
    vol      = "/admin"
    mount    = true
    check    = false
    free     = false
    vfs      = jfs2
    log      = /dev/hd8
```

```
... omitted lines ...
```

```
hhaix6:root:/ # pg /var/adm/ras/image.data
```

```
... omitted lines ...
```

```
lv_data:
    VOLUME_GROUP = rootvg
    LV_SOURCE_DISK_LIST =
    LOGICAL_VOLUME = hd11admin
    TYPE = jfs2
    MAX_LPS = 512
    COPIES = 1
    LPS = 2
    BB_POLICY = relocatable
    INTER_POLICY = minimum
    INTRA_POLICY = center
    WRITE_VERIFY = off
    UPPER_BOUND = 32
    SCHED_POLICY = parallel
    RELOCATABLE = yes
    LABEL = /admin
    MIRROR_WRITE_CONSISTENCY = on
    LV_SEPARATE_PV = yes
    MAPFILE =
    PP_SIZE = 64
    STRIPE_WIDTH =
    STRIPE_SIZE =
    SERIALIZE_IO =
    FS_TAG =
    DEV_SUBTYP =
```

```
... omitted lines ...
```

```
fs_data:
  FS_NAME = /admin
  FS_SIZE = 262144
  FS_MIN_SIZE = 262144
  FS_LV = /dev/hd11admin
  FS_JFS2_BS =
  FS_JFS2_SPARSE =
  FS_JFS2_INLINELOG =
  FS_JFS2_SIZEINLINELOG =
  FS_JFS2_EAFORMAT =
  FS_JFS2_QUOTA =
  FS_JFS2_DMAPI =
  FS_JFS2_VIX =
  FS_JFS2_EFS =
  FS_IMAGE_TYPE =
```

8.2 AIX Security Expert enhancements

AIX Security Expert has been enhanced with new features to further improve the system security and prevent intrusions. These features include:

- ▶ Centralized Policy Distribution through Lightweight Directory Access Protocol (LDAP)
- ▶ Ability to customize and include user-defined policies
- ▶ More stringent checks for weak root passwords
- ▶ Enable stack execution disable (SED) in AIX Security Expert
- ▶ File permission manager (**fpm**) command for managing SUID programs
- ▶ Invoking Secure by default for high security setting
- ▶ SOX-COBIT assistant
- ▶ Performance enhancements for the graphical interface

The following sections discuss these enhancements in turn.

8.2.1 Centralized policy distribution through ldap

The support for a centralized policy file that is stored in LDAP is one of the important security enhancements to AIX Security Expert in AIX V6.1.

An AIX Security Expert policy file can be created and saved in a central location on an LDAP server. The LDAP server stores the policy file containing the XML rules that is read by AIX Security Expert to determine security settings. Then as

other machines in the network need to be hardened, the policy file is fetched from the LDAP server and a consistent policy is distributed and maintained throughout the enterprise.

8.2.2 User-defined policies

It is possible to define your own security policy or rules that is automatically integrated into the AIX Security Expert tool and GUI. Therefore, any security configuration policy unique to your environment or relating to third party software, can be easily brought under the control and management of AIX Security Expert. If you use this customize, you need to create an xml file in the `/etc/security/aixpert/custom` directory.

For more information, See “The predefined SOX-COBIT security policy” in *AIX V6 Advanced Security Features Introduction and Configuration*, SG24-7430.

8.2.3 More stringent check for weak root passwords

This feature checks for a weak root passwords. This feature checks for easily guessed root passwords. The location of this option is illustrated in Figure 8-1.

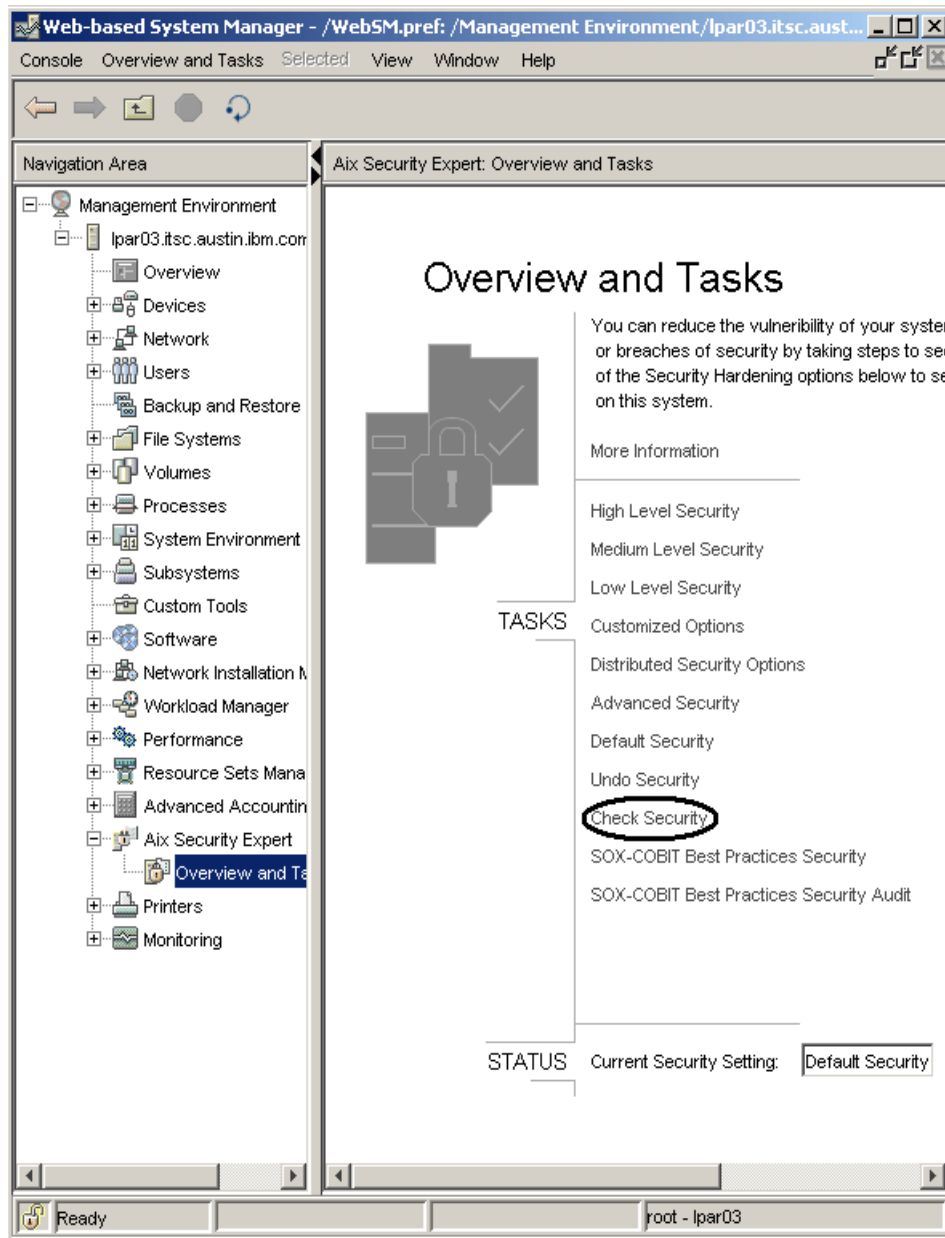

Figure 8-1 Management environment tasks

This feature reads the encrypted password from `/etc/security/passwd` for root. For example:

```
root:  
password = ni3nZoD1xC52c
```

For each entry in the dictionary (located in /etc/security/aixpert/dictionary directory), the password is read. This encrypted output is compared with the stored encrypted password, if there is a match, AIX Security Expert must report that root has a weak password.

Before this is done, an administrator has to check the following box (Figure 8-2):

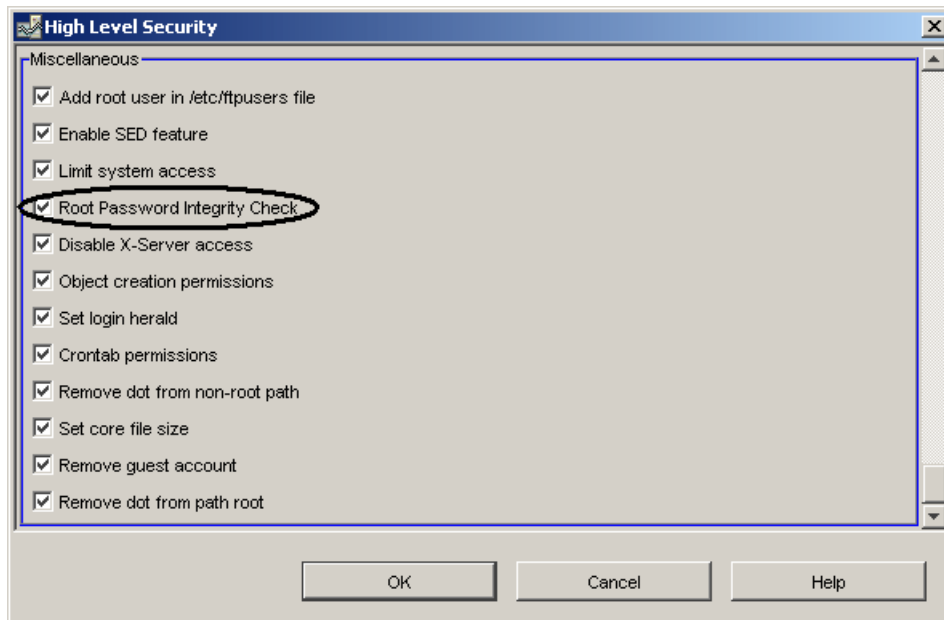

Figure 8-2 Root Password Integrity Check interface

The check box can be seen when an administrator selects the Miscellaneous section of High Level Security or Medium Level Security.

Note: This feature provides a command option to check any user password integrity, but AIX Security Expert does not provide menu options to check other users. Instead, a dictionary is developed as part of this feature, and when root or other users change their passwords, their new password must not be found in this dictionary. The dictionary is installed in /etc/security/aixpert/dictionary/English. The file is shipped with AIX Security Expert (bos.aixpert.cmd fileset).

8.2.4 Enabling Stack Execution Disable (SED)

Stack Execution Disable itself is introduced in AIX 5.3 TL4. In AIX V6.1, it is added to the graphic interface you can now see the Enable Stack Execution Disable check box in Miscellaneous section of High Level Security as follows (Figure 8-3):

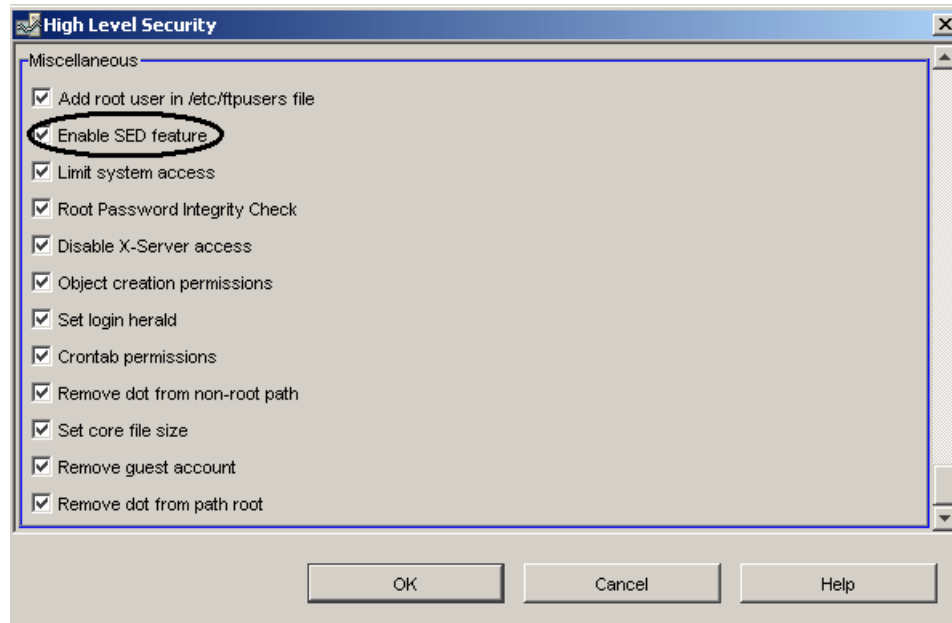

Figure 8-3 Enable SED Feature Interface

8.2.5 File permission Manager (fpm) for managing SUID programs

File Permission Manager (**fpm**) manages the permissions on commands and daemons owned by privileged users with `setuid` or `setgid` permissions. This command will be provided in AIX V6.1 and also, AIX V5.2 TL10, AIX V5.3 TL7, at the time of writing. AIX Security Expert provides interface of File Permissions Manager as follows (Figure 8-4 on page 301):

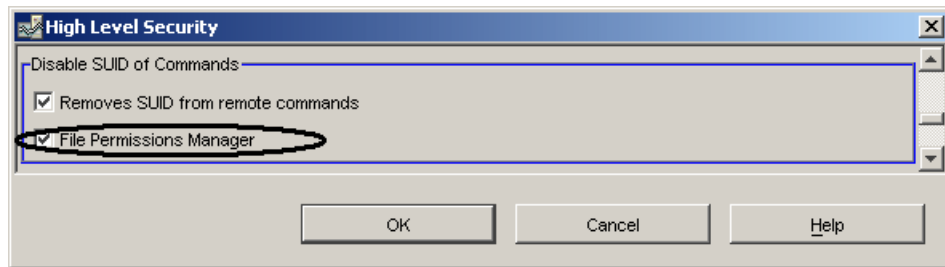

Figure 8-4 File Permissions Manager Interface on AIX Security Expert

The **fpm** command allows administrators to harden their system by disabling the `setuid` and `setgid` bits on many commands in the operating system. This command is intended to remove the `setuid` permissions from commands and daemons owned by privileged users, but you can also customize it to address the specific needs of unique computer environments with the command options.

Note: The **fpm** command cannot run on TCB-enabled hosts.

The **fpm** commands runs as provided in Example 8-1:

Example 8-1 Changing Level and Restore setting scenarios

```
##### Check current status
# fpm -s
Default level security.
# more 10192007_12:20:49

##### Check current file permissions
# ls -l /usr/bin/acctctl
-r-sr-s---  1 root  adm      203601 Sep 24 18:24 /usr/bin/acctctl

##### Change Low Level
# fpm -l low
One or more file is already secure. Therefore, the current file permissions may not
match the default permissions. If you wish to return to the snapshot of permissions
prior to running this command, then use the command:
/usr/bin/fpm -l default -f /var/security/fpm/log/10192007_13:02:57

fpm will now continue to remove the SUID permissions.

##### Check current file permissions: suid is removed
# ls -l /usr/bin/acctctl
-r-xr-s---  1 root  adm      203601 Sep 24 18:24 /usr/bin/acctctl
```

```
##### Change Medium Level
# fpm -l medium
One or more file is already secure. Therefore, the current file permissions may not
match the default permissions. If you wish to return to the snapshot of permissions
prior to running this command, then use the command:
/usr/bin/fpm -l default -f /var/security/fpm/log/10192007_13:03:18

fpm will now continue to remove the SUID permissions.

##### Check current file permissions: sgid is removed
# ls -l /usr/bin/acctctl
-r-xr-x---    1 root    adm            203601 Sep 24 18:24 /usr/bin/acctctl

##### Change Default Status
# fpm -l default
fpm will restore the AIX file permissions to the installed settings and any
customized defaults listed in /usr/lib/security/fpm/custom/default. If you had done
other customizations outside fpm and wish to return the file permissions to a state
representing a particular time and date, use the command:
fpm -l default -f /var/security/fpm/log/<in_file>
Where <in_file> is a previously saved timestamped file representing this system's
file permission state at a particular date and time.

##### Check current file permissions: suid, sgid are restored
# ls -l /usr/bin/acctctl
-r-sr-s---    1 root    adm            203601 Sep 24 18:24 /usr/bin/acctctl
```

Attention: The **fpm** command writes a log in /var/security/fpm/log directory. Ensure there is free space for the directory and log. If there is no space to log, the command will fail.

8.2.6 Secure by Default

Secure by Default takes a bottom-up approach in hardening an AIX system by installing a minimal set of software, because any additional software could increase the potential for a security vulnerability, and then applying a high security level hardening to those components. This approach is opposite to starting with a regular, full-blown AIX installation and then use the AIX Security Expert to apply hardening (top-down approach) by disabling unneeded components.

For Secure by Default installation, See “Secure by Default” in *AIX V6 Advanced Security Features Introduction and Configuration*, SG24-7430.

8.2.7 SOX-COBIT assistant

AIX Security Expert supports the SOX-COBIT Best Practices Security level in addition to the High, Medium, Low, AIX Default and Advanced Security settings.

The United States Congress enacted the 'Sarbanes-Oxley Act of 2002 to protect investors by improving the accuracy and reliability of financial information disclosed by corporations. The COBIT control objectives feature will help System Administrators to configure, maintain, and audit their IT systems for compliance with this law. The SOX Configuration Assistant is accessed through the AIX Security Expert Web-based Systems Manager menus or the `aixpert` command line. The feature assists with the SOX section 404 of the Sarbanes-Oxley Act, but The AIX Security Expert SOX Configuration Assistant automatically implements security settings commonly associated with COBIT best practices for SOX Section 404, Internal Controls. Additionally, the AIX Security Expert provides a SOX audit feature which reports to the auditor whether the system is currently configured in this manner. The feature allows for the automation of system configuration to aid in IT SOX compliance and in the automation of the audit process.

Since SOX does not offer guidance on how IT must comply with section 404, the IT industry has focused on the existing governance detailed by www.isaca.org/. More specifically, the IT governance covered by Control Objectives for Information and related Technology (COBIT).

AIX Security Expert supports the following control objectives (see Figure 8-5 on page 304):

- ▶ Password policy enforcement
- ▶ Violation and Security Activity Reports
- ▶ Malicious software prevention, detection and correction, and unauthorized software
- ▶ Firewall architecture and connections with public networks



Figure 8-5 Sox-Cobit Rules Interface

Important: AIX Security Expert does not support all of the attributes specified under each control objective. For supported attributes, see COBIT control objectives supported by AIX Security Expert in AIX V6.1 online manual.

You can use the `aixpert -c -l s` command to check a system's SOX-COBIT compliance. AIX Security Expert only checks for the supported control objectives compliance. Any violations found during the checking are reported. By default, any violations are sent to stderr.

You can also use the same command (`aixpert -c -l s`) to generate the SOX-COBIT compliance audit report. To generate an audit report, set up and enable the audit subsystem. Ensure that the `AIXpert_check` audit event is turned on. After setting up the audit subsystem, rerun the `aixpert -c -l s` command. The command generates the audit log for every failed control objective. The Status field of the audit log will be marked as failed. The log also contains the reason for the failure, which can be viewed using the `-v` option of the `auditpr` command.

Adding `-p` option to the `aixpert -c -l s` command also includes successful control objectives also in the audit report. Those log entries have `Ok` in the status field.

The `aixpert -c -l s -p` command can be used to generate a detailed SOX-COBIT compliance audit report.

Whether or not the `-p` option is specified, there will be a summary record. The summary record includes information about the number of rules processed, the number of failed rules (instances of non-compliance found), and the security level that the system is checked for (in this instance, this would be SCBPS).

8.2.8 Performance enhancements for the graphical interface

Performance enhancements for the graphical interface is implemented by replacing some JAVA calls with C code in areas that provide additional performance.

8.3 Enhanced Role Based Access Control

To make the AIX Operating system more robust, Role Based Access Control (RBAC) is enhanced in AIX to reduce the complexity of managing the system, and also to provide for finer granular privilege control. The older versions ($>=4.2.1$ and $<=5.3$) of AIX have RBAC implemented in user space. RBAC implementation for AIX V6.1 provides for an enhanced mechanism covering both in user and kernel spaces. Enhanced RBAC provides for a framework that allows clients to define administrative roles and delegate the role to regular users. The RBAC framework is consist of the followings features:

- ▶ Authorizations
- ▶ Privileges (command and device)
- ▶ Roles

User space framework

The following configuration files (they are called as user-level databases) are provided to support enhanced RBAC (Table 8-1):

Table 8-1 File lists for enhanced RBAC facility

File name	Description
/etc/security/authorizations	user-level Authorization Database
/etc/security/roles	user-level Role Database
/etc/security/privcmds	user-level Privileged Command Database
/etc/security/privdevs	user-level Privileged Device Database

File name	Description
/etc/security/privfiles	Privileged File Database

Kernel security tables

After user-level databases are changed, these changes must be sent to Kernel Security Table (KST), to be applied.

KST consists of the following (See Figure 8-6 on page 307):

- ▶ User-defined Kernel Authorization Table (KAT)
- ▶ System-defined Kernel Authorization Table (KAT)
- ▶ Kernel Role Table (KRT)
- ▶ Kernel Command Table (KCT)
- ▶ Kernel Device Table (KDT)

RBAC security decisions are enforced by the Kernel. User-level databases must be sent to KST.

- ▶ User-defined Authorization Database → User-defined KAT
- ▶ User-level Role Database → KRT
- ▶ User-level Privileged Command Database → KCT
- ▶ User-level Privileged Device Database → KDT

Note: Privileged File Database is only used by the `pvi` command. So, the contents of the file is not sent to KST.

Kernel security tables management commands:

`setkst` Update the KST with data in user-level databases. Only entire table update supported. A way to update single entries in a table is not provided. (KAT requires KRT and KCT update).

`lskst` List the data from the KST.

A binary version of KST is saved each time the `setkst` command is executed. It is used for reboot and Workload Partition mobility.

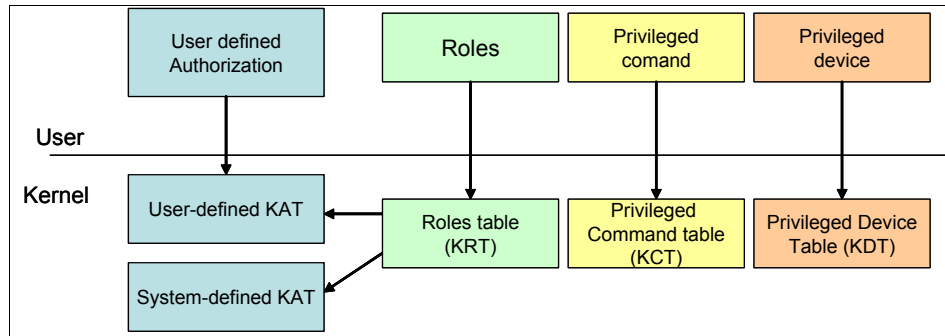

Figure 8-6 Enhanced RBAC Framework on AIX V6.1.

8.3.1 Authorizations

Authorizations are authority attributes for a user. These authorizations allow a user to do certain tasks. An authorization can be thought as a key that is able to unlock access to one or more commands (See Figure 8-7).

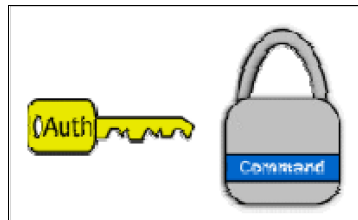

Figure 8-7 Authorizations concept

Authorization in AIX 5.3

In AIX V5.3 and earlier , 11 authorizations were provided in the system (See Table 8-2). These cannot be customized. The commands and authorizations are tightly bound.

Table 8-2 Authorization on AIX V5.3.

Authorization	Description
Backup	Performs a system backup. The backup command uses this authorization.
Diagnostics	Allows a user to run diagnostics. This authority is also required to run diagnostic tasks directly from the command line. The diag command uses this authorization.

DiskQuotaAdmin	<p>Perform a disk quotas. The following commands use this authorization:</p> <ul style="list-style-type: none"> ▶ quotacheck ▶ edquota ▶ j2edlimit ▶ quota ▶ quotaoff ▶ quotaon ▶ repquota
GroupAdmin	<p>Performs the functions of the root user on group data. The following commands use this authorization:</p> <ul style="list-style-type: none"> ▶ chgroup ▶ chgrpmems ▶ chsec ▶ mkgroup ▶ rmggroup
ListAuditClasses	Views the list of valid audit classes.
PasswdAdmin	<p>Performs the functions of the root user on password data. The following commands use this authorization:</p> <ul style="list-style-type: none"> ▶ chsec ▶ lssec ▶ pwdadm
PasswdManage	Performs password administration functions on non-administrative users. The pwdadm command uses this authorization.
UserAdmin	<p>Performs the functions of the root user on user data. Only users with UserAdmin authorization can modify the role information of a user. You cannot access or modify user auditing information with this authorization. The following commands use this authorization;</p> <ul style="list-style-type: none"> ▶ chfn ▶ chsec ▶ chuser ▶ mkuser ▶ rmuser
UserAudit	<p>Allows the user to modify user-auditing information. The following commands use this authorization;</p> <ul style="list-style-type: none"> ▶ chsec ▶ chuser ▶ lsuser ▶ mkuser

RoleAdmin	Performs the functions of the root user on role data. The following commands use this authorization: <ul style="list-style-type: none"> ▶ chrole ▶ lsrole ▶ mkrole ▶ rmrole
Restore	Performs a system restoration. The restore command uses this authorization.

Authorization in AIX V6.1

In AIX V6.1, authorizations are divided into granular parts. The current number of system authorizations is 252. The administrator can specify these authorizations to roles more frequently. Table 8-3 shows major authorizations for AIX V6.1.

Table 8-3 Top Level authorization on AIX V6.1

Authorizations (Top)	Descriptions
aix.devices	Device Administration
aix.fs	File System Administration
aix.lvm	Logical Volume Manager Administration
aix.mls	Trusted AIX Administration
aix.network	Network Administration
aix.proc	Process Administration
aix.ras	Reliability, Availability, Serviceability Administration
aix.security	Security Administration
aix.system	System Administration
aix.wpar	System and Application Workload Partition Administration

The authorization name is a hierarchical naming support and the dotted notation denotes hierarchy (See the following example aix.system.boot.info in Figure 8-8 on page 310). There are nine levels of hierarchy allowed and parent authorization is a super-set of children.

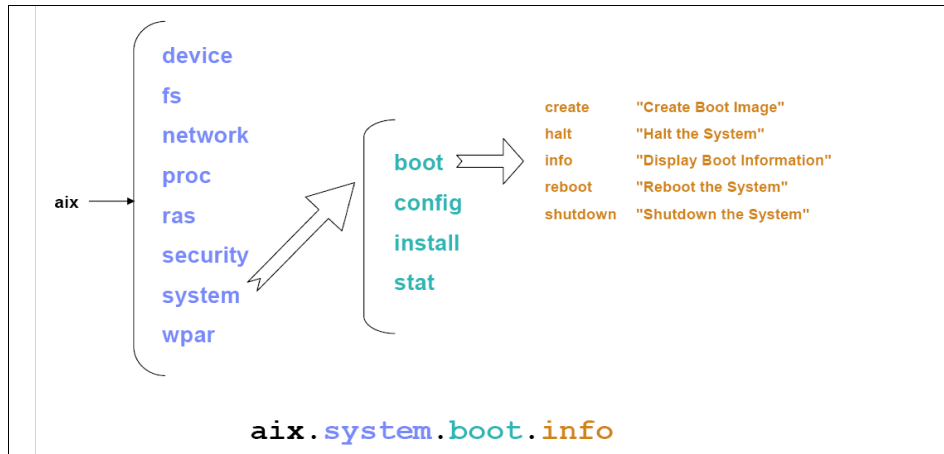

Figure 8-8 Authorization hierarchy

Table 8-4 shows maps for previous authorizations to new authorizations;

Table 8-4 Maps for authorization from AIX V5.3 to AIX V6.1

Existing Legacy Mode Authorization	Enhanced Mode Authorization
Backup ^{a)}	aix.fs.manage.backup
Diagnostics ^{a)}	aix.system.config.diag
DiskQuotaAdmin ^{a)}	aix.fs.manage.quota
GroupAdmin ^{a)}	aix.security.group
ListAuditClasses ^{a)}	aix.security.audit.list
PasswdAdmin ^{a)}	aix.security.passwd
PasswdManage ^{a)}	aix.security.passwd.normal
UserAdmin ^{a)}	aix.security.user
UserAudit ^{a)}	aix.security.user.change
RoleAdmin ^{a)}	aix.security.role
Restore ^{a)}	aix.fs.manage.restore
a) Legacy Mode Authorizations remain on AIX V6.1 for compatibilities.	

To manipulate authorizations, the following commands are introduced;

lsauth	Displays attributes of user-defined and system-defined authorizations from the authorization database.
mkauth	Creates a new user-defined authorization in the authorization database.
chauth	Modifies attributes for the existing user-defined authorization.
ckauth	Checks whether the current user session has the authorizations.
rmauth	Removes the user-defined authorization.

For more detail, see *AIX V6 Advanced Security Features Introduction and Configuration*, SG24-7430.

8.3.2 Privileges

A privilege is a process attribute that allows the process to bypass specific system restrictions and limitations. And privileges are the restriction mechanism used in the kernel to determine if a process is allowed to perform a particular action. A privilege can be thought of as an ability that allows a process to overcome a specific security constraint in the system (See Figure 8-9).

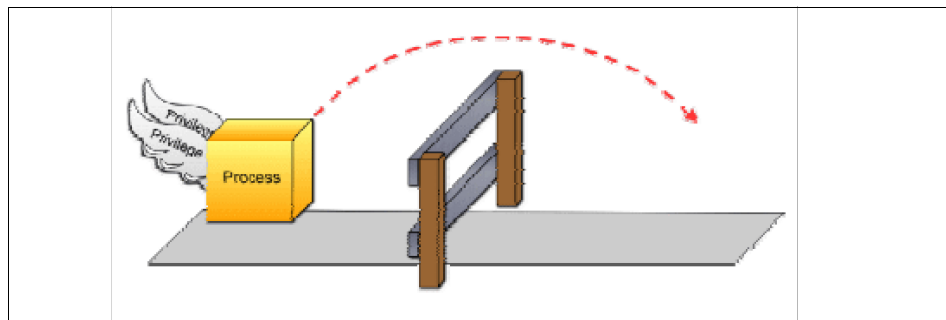

Figure 8-9 Concept of privileges

Process Privilege Sets

Process Privilege Sets are used to dynamically restrict or limit privileged operations. Multiple sets of privileges are defined in the kernel to provide for varied controls in regards to privileged operations.

A process will now have these new privilege sets:

Effective Privilege Set: (EPS)

Used to actually override system restrictions. A process

can add or remove privileges from its own EPS subject to the limitations imposed by the MPS.

Maximum Privilege Set (MPS)

Set of privileges over which a process has control. The MPS is always a super-set of the process's EPS. A process can always remove a privilege from its MPS. A process's MPS can only be increased if the process has the appropriate privilege, and even then it is restricted by the LPS of the process. The MPS of process can also be modified when the process runs an executable file, but this too is limited by the process's LPS.

Limiting Privilege Set (LPS)

Represents the maximum possible privilege set that the process can have. The LPS is always a super-set of the MPS. No process can increase its LPS and any process can reduce its LPS.

Used Privilege Set: (UPS)

This is mainly used by the **tracepriv** command. This set keeps all privileges which are used during the life of a process. It goes away when a process dies.

Inheritable Privilege Set (HPS)

This is set of privileges which are inherited from parent to child. A process can always remove a privilege from its HPS. A process's HPS can only be increased if the process has the appropriate privilege and even then it is restricted by the LPS of the process. The HPS of process can also be set when the process runs an executable file, but this is also limited by the process's LPS.

Privilege commands

To manipulate privileges, the following commands are introduced;

pvi	Provides a privileged editor so that you can access privileged files.
lspriv	Displays the privilege available on the system
tracepriv	Trace the privileges that a command needs for a successful run

The following commands are used to manipulate privileges and used for other security settings:

lssecattr	Displays the security attributes of a command, a device, a privileged file, or a process.
------------------	---

setsecattr	Sets the security attributes of a command, a device, a privileged file, or a process.
rmsecattr	Removes the definition of the security attributes for a command, a device, or a privileged file in the database.

8.3.3 Roles

Roles are mechanism used to assign authorizations to a user and to group a set of system administration tasks together. An AIX role is primarily a container for a collection of authorizations.

AIX supports the direct assignment of authorizations to a role or the indirect assignment of authorizations through a sub-role. A sub-role can be specified for a role in the `rolelist` attribute of a role. Configuring a role to have a designated sub-role effectively assigns all of the authorizations in the sub-role to the role.

Assigning a role to a user allows the user to access the role and use the authorizations that are contained in the role. A system administrator can assign a role to multiple users and can assign multiple roles to a user. A user who has been assigned multiple roles can activate more than one role (up to a maximum of eight roles) simultaneously if necessary to perform system management functions.

AIX provides a set of predefined roles for system management. However it is expected that customers will need to create their own custom roles or modify the existing predefined roles. Several role-management commands are available to list, create, modify, and remove AIX roles. Roles can be created with the `mkrole` command, modified with the `chrole` command, removed with the `rmrole` command, and displayed with the `lsrole` command.

The roles allows a set of management functions in the system to be grouped together. Using the analogy that an authorization is a key, a role can be thought of as a key ring that can hold multiple authorizations (See Figure 8-10 on page 314).

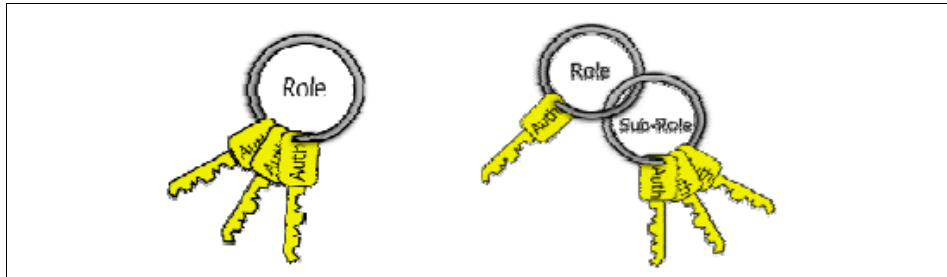

Figure 8-10 Concept of roles

The function of the role itself is not different from previous one on AIX V5.3. But the contents of roles are completely different. The following tables (Table 8-5 and Table 8-6 on page 315) shows roles that system provides by default;

Table 8-5 List of roles provided by default on AIX V5.3.

Roles	Descriptions
ManageBasicUsers	Performs the functions of the root user on user data. Views the list of valid audit classes.
ManageAllUsers	Performs the functions of the root user on role, password data, group data, and user data. Views the list of valid audit classes.
ManageBasicPasswds	Performs password administration functions on non-administrative users.
ManageAllPasswds	Performs the functions of the root user on password data. Performs password administration functions on non-administrative users.
ManageRoles	Performs the functions of the root user on role data.
ManageBackupRestore	Performs a system backup and a system restoration.
ManageBackup	Performs a system backup.
ManageShutdown	Shutdown system
RunDiagnostics	Run diagnostics
ManageDiskQuota	Perform a disk quotas.

Table 8-6 List of roles provided by default on AIX V6.1.

Roles	Descriptions
AccountAdmin	User and Group Account Administration
BackupRestore	Backup and Restore Administration
DomainAdmin	Remote Domain Administration
FSAdmin	File System Administration
SecPolicy	Security Policy Administration
SysBoot	System Boot Administration
SysConfig	System Configuration
isso	Information System Security Officer
sa	System Administrator
so	System Operator

By default, AIX does not activate any roles. A `swrole` command can be used to assume proper role in order to execute any privileged command or function.

8.3.4 Summary of differences

Table 8-7 shows summary of differences between AIX V5.3 and AIX V6.1 RBAC functions.

Table 8-7 Differences summary between AIX V5.3 and AIX V6.1.

Feature	AIX V5.3	AIX V6.1
Implementation region	Mostly User space	User and Kernel Space
Role		
► Create new roles	Yes	Yes
► Enablement	Default active	Need to activate (<code>swrole</code>)
Authorization		
► Structure	Flat	Hierarchical
► Create new authorizations	No	Yes
Privilege		

Feature	AIX V5.3	AIX V6.1
► Create new privileges	No	No (system provides only)
► Assign privileges to targets	No	Yes (file, device, process)

8.4 Web-based GUI for RBAC

Web-based GUI for RBAC runs in a browser/server-client environment using Web Services and the Light Weight Infrastructure (LWI) as a plug-in to the IBM Systems Director Console for AIX.

Web-based GUI for RBAC is provided in AIX V6.1 (See Figure 8-11).

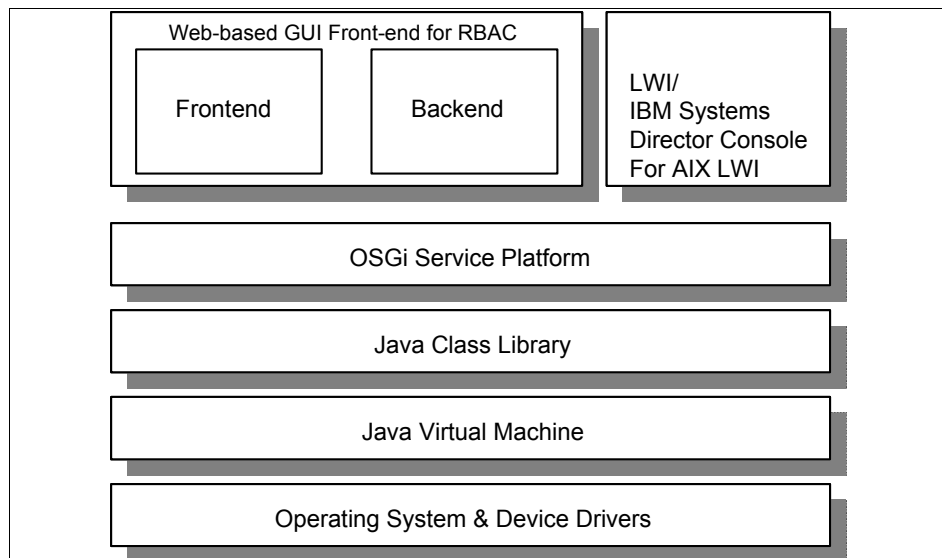

Figure 8-11 IBM Systems Director Console for AIX and RBAC modules

Components

The Web-based GUI for RBAC application is implemented using the schema of a three-tier web application. The Web-based GUI Front-end for RBAC GUI is composed of four parts or layers (See Figure 8-12 on page 317):

Presentation Layer This layer is composed of objects that interact directly with the user (Forms, HTML pages, portlets and so on.)

Application Layer	This layer supports the presentation layer by presenting the objects received from the business layer in a way directly usable by the presentation layer.
Business Layer	This layer is the heart of the Web-based GUI Front-end for RBAC system. It responds to requests from the application layer and manages the persistency, currency and consistency of data by utilizing the services of the integration layer.
Integration Layer	This layer interacts directly with the RBAC subsystem installed on the Endpoint

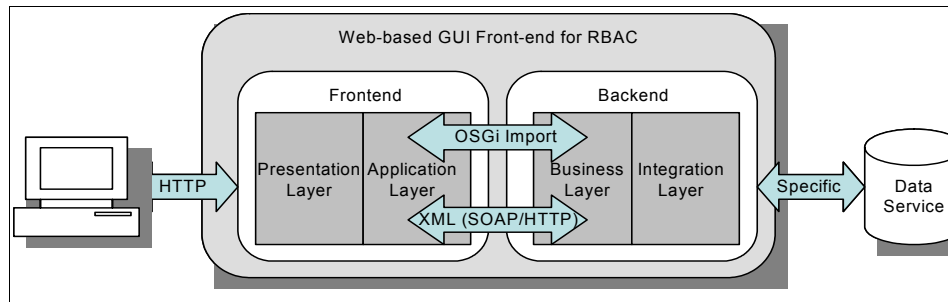

Figure 8-12 Web-Base GUI Component with RBAC

8.4.1 Tasks and roles

An administrator assigns the roles to the users who uses specific IBM Systems Directors Console for AIX tasks. After assigning the Console Role to a user, there is more to do. A user can administrate some tasks, but authorizations are also required. For example, the user *nobu* is assigned the *aixUser* Console role. So, *nobu* can log into the IBM System Director Console for AIX, but when he moves to Security & Users tasks, he gets the following messages:

WARNING: Some of the commands in this application require system authorizations which you don't have:

- * aix.security.user
- * aix.security.role
- * aix.security.group
- * aix.security.passwd

So, the user *nobu* needs authorizations. To get authorizations, a new role that uses these authorizations must be created and be assigned the user *nobu*.

Table 8-8 on page 318 shows mapping list of Console task, Console Role, and AIX authorizations that are needed:

Table 8-8 Task Console Role, and Authorization map

Task	Console Role	AIX authorizations
Software Installation and Maintenance	aixSoftware	aix.system.install aix.system.stat aix.system.boot aix.network.config
Software License Management	aixLicenses	aix (This authorization is equivalent to root authority.)
Devices	aixDevices	aix.device
System Storage Management	aixStorage	aix.fs aix.lvm
Security & Users	aixUsers	aix.security.user aix.security.role aix.security.group aix.security.passwd
Communication Applications and Services	aixNetwork	aix.network
Workload Partition Administration	aixWorkloadPartitions	aix.wpar
Print Spooling	aixPrinters	aix.device.config.printer aix.device.stat.printer
Advanced Accounting	aixAdvancedAccounting	aix (This authorization is equivalent to root authority.) aix.system.config.acct
Problem Determination	aixProblemDetermination	aix.ras
Performance & Scheduling	aixPerformanceAndScheduling	aix.system.stat aix.system.config.perf aix.system.config.cron aix.system.config.wlm aix.system.config.init aix.system.config.dlpar aix.proc.status aix.ras.trace
System Environments	aixSystemEnvironments	aix.system aix.ras.dump aix.ras.error aix.device.manage.change

Task	Console Role	AIX authorizations
Processes & Subsystems	aixProcessesAndSubsystems	aix.proc aix.system.config.src
Cluster Systems Management	aixCSM	aix (This authorization is equivalent to root authority.)
SMIT - Classic View	aixSMITclassic	aix (This authorization is equivalent to root authority.)
DCEM	aixDCEM	aix (This authorization is equivalent to root authority.)
Role Based Access Control	aixRBAC	aix (This authorization is equivalent to root authority.) aix.security.role aix.security.auth aix.security.cmd aix.security.device aix.security.file aix.security.proc aix.security.kst
Web-based System Manager	aixWebSysMgr	aix (This authorization is equivalent to root authority.)

8.5 LDAP support enablement

In AIX V6.1, a new framework is used to store the RBAC database tables, including the authorization table, the role table, the privileged command table and the device table, in a centralized location in LDAP. AIX security libraries can be made aware of the remote tables, and if configured to use them, data can be pulled from these LDAP tables, and then be used the same way as the data is from local files. The LDAP tables are transparent to applications. Some RBAC commands will be made to work with LDAP tables explicitly though, for purpose of managing these remote tables.

Name service control file

A mechanism to configure the priority of local and LDAP tables, and possibly remote tables other than LDAP. A new control file `/etc/nscontrol.conf` is provided.

This file is a stanza file, with stanza name being authorizations, roles, privileged commands, and privileged devices. The file only supports one search order attribute. The search orders defined in this file are system-wide. The content of the file is in the format:

```
stanzakey:
    searchorder = <lookup mechanism>,<lookupmechanims>...
```

An example of this file is as follows:

```
authorizations:
    searchorder = LDAP,files

roles:
    searchorder = LDAP,files

privcmds:
    searchorder = files,LDAP

privdevs:
    searchorder = files

privfiles:
    searchorder = files,LDAP
```

LDAP support enablement commands

To support the LDAP environment, AIX V6.1 includes new commands, and enhances existing commands.

The **rbactoldif** command is introduced on AIX V6.1. This command reads RBAC configurations files, and generates RBAC security database data for LDAP.

The following commands supports LDAP databases;

- ▶ **mkauth, chauth, lsauth, rmauth**
- ▶ **mkrole, chrole, lsrole, rmrole**
- ▶ **setsecattr, lssecattr, rmsecattr**

These commands have the new option -R. The **setkst** command dose not have an option but it recognize that RBAC information is located in LDAP databases.

LDAP commands are also enhanced to support RBAC tables.

The **lsldap** command supports new RBAC tables:

- ▶ **auths**

- ▶ roles
- ▶ privcmds
- ▶ privdevs
- ▶ privfiles

The `mksecldap` command updates with RBAC related setup during LDAP client configuration on the following topics:

- ▶ The base DN update for `authbasedn`, `rolebasedn`, `privcmdbasedn`, and `privdevbasedn`.

8.6 RBAC and Workload Partition environments

Since creating and managing a System Workload Partition requires authority to manage resources such as file system, network, and devices, the root user must be used for these tasks. Working as the root user raises some security concerns in a consolidated environment. When working with applications it is best practice not to be root user to avoid errors. The proper way to handle this requirements is to delegate privileges based on roles such as those of the application administrator for a particular Workload Partition. The Role Based Access Control (RBAC) mechanism of AIX is been used for this purpose.

Note: The `lspriv` command displays privileges available to the system. If it is run within a workload partition, the `lspriv` command displays only the privileges available to the partition. If the `-v` flag is specified, the `lspriv` command also displays privilege descriptions.

Figure 8-13 on page 322 shows Workload Partition and RBAC relations:

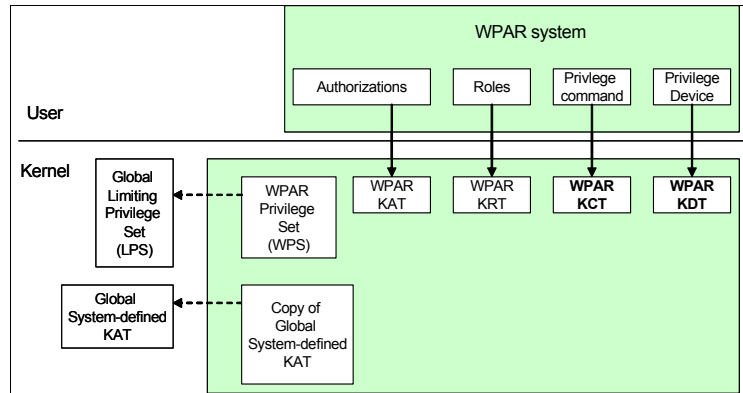

Figure 8-13 RBAC and Workload Partition Framework

The Workload Partition system also has its own Authorizations, Roles, and Privileges (command and device) as Global System has them. The Workload Partition system has a private copy of Global System-defined KAT and Workload Partition Privilege Set (WPS). The WPS defines all the privilege that the Workload Partition can have. The WPS is equal to Global Limiting Privilege Set (LPS).

Considerations on Workload Partition environment

The following considerations apply using RBAC with Workload Partition (See Figure 8-14 on page 323):

- ▶ The RBAC mode is only configurable in the Global Environment. The setting in the Global Environment applies to all Workload Partition's on the system
- ▶ Application Workload Partitions do not have Workload Partition Privilege Set (WPS). The entire set of privileges will be assigned to root owned processes on Application Workload Partition as is the same case for global.
- ▶ The system defined authorizations are contained in the Global Environment.
- ▶ Each Workload Partition has it's own Workload Partition user-defined KAT.
- ▶ Any Workload Partition has a privilege limited by the use of the Workload Partition Privilege Set (WPS). To extend the privilege set, use **chwpar** command as follows:

```
chwpar -S privs+=privileges wpar_name
```

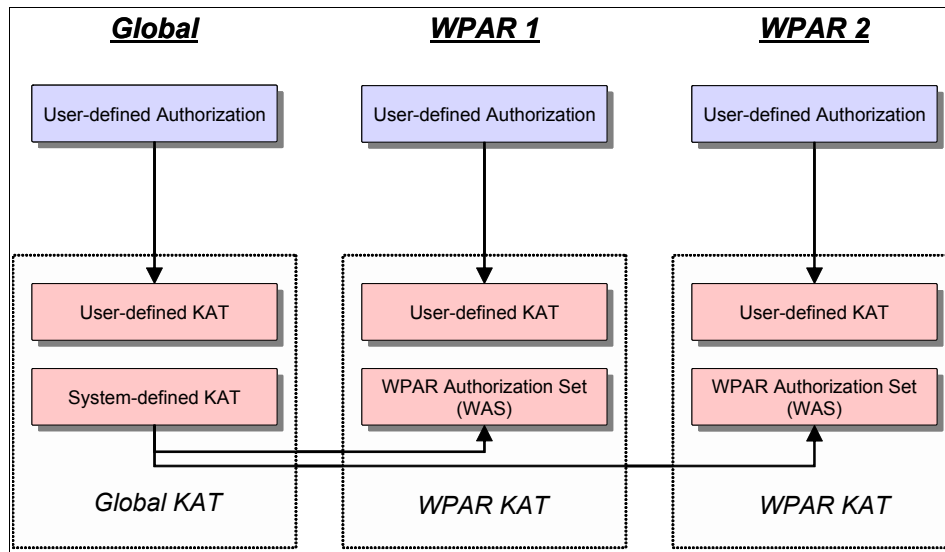

Figure 8-14 Kernel Authorization Tables mapping for Workload Partitions

8.7 Enhanced and existing mode switch

In order to disable the enhanced RBAC capabilities and to revert back to existing or the existing RBAC behavior, a system wide configuration switch is provided. The option to not use the enhanced RBAC features will be selected through a system wide configuration switch in the kernel, which will denote that the Enhanced RBAC Mode is disabled for the system. A system administrator may select this mode by invoking the **chdev** command on the `sys0` device and specifying the `enhanced_RBAC` attribute with a value of `false` and then rebooting the system. The mode can be switched back to Enhanced RBAC Mode by setting the `enhanced_RBAC` attribute to `true`. Programmatically, the mode can be set or queried through the `sys_parm()` system call. An example invocation of the **chdev** command is shown below:

```
chdev -l sys0 -a enhanced_RBAC=false
```

In order to list the value of the attribute:

```
lsattr -E -l sys0 -a enhanced_RBAC
```

In a Workload Partition environment, this mode will only be configurable from the global system and will affect the global as well as all the Workload Partitions. Both the new and existing interfaces will be modified to check this configuration and either execute the new code or follow the old behavior based on the value of

the switch. In Legacy RBAC Mode, only authorizations that are checked within the code of the command itself will be enforced. The Kernel Security Tables (KST) will not have any affect on command execution or authorization checks. The determination of whether a user has an authorization will follow the existing behavior of retrieving all the user's authorizations and checking if there is a match. New features being added like swrole and the default_roles and auth_mode attributes will not be available in Legacy RBAC Mode. However, the new privileges, authorizations and management commands for authorizations will be supported in Legacy RBAC Mode.

Note: Be aware that disabling enhanced RBAC feature may lower the security threshold of your system especially in Workload Partition. The enhanced RBAC option only works under 64-bit kernel.

8.8 Trusted AIX

Trusted AIX enables Multi Level Security (MLS) capabilities in AIX. As compared to regular AIX, Trusted AIX label-based security implements labels for all subjects and objects in the system.

Note: The Trusted AIX install option enables the Labeled Security AIX environment. Access controls in the system are based on labels that provide for a Multi Level Security (MLS) environment and includes support for the following:

- ▶ Labeled objects: Files, IPC objects, network packets, and other labeled objects
- ▶ Labeled printers
- ▶ Trusted Network: Support for RIPS0 and CIPSO in IPv4 and IPv6

Note that once you choose this mode of installation, you will not be able to go back to a regular AIX environment without performing an overwrite install of regular AIX. Evaluate your need for a Trusted AIX environment before choosing this mode of install. More details about Trusted AIX can be found in the AIX publicly available documentation.

Standard AIX provides a set of security features to allow information managers and administrators to provide a basic level of system and network security. The primary AIX security features include the following:

- ▶ Login and password controlled system and network access

- ▶ User, group, and world file access permissions
- ▶ Access control lists (ACLs)
- ▶ Audit subsystem
- ▶ Role Based Access Control (RBAC)

Trusted AIX builds upon these primary AIX operating system security features to further enhance and extend AIX security into the networking subsystems.

Trusted AIX is compatible with the AIX application programming interface (API). Any application that runs on AIX can also run on Trusted AIX. However, due to additional security restrictions, MLS-unaware applications may need privileges to operate in a Trusted AIX environment. The **tracepriv** command can be used to profile applications in such scenarios.

Trusted AIX extends the AIX API to support additional security functionality. This allows customers to develop their own secure applications can be developed using the AIX API and new Trusted AIX extensions.

Trusted AIX enables AIX systems to process information at multiple security levels. It is designed to meet the US Department of Defense (DoD) TCSEC and European ITSEC criteria for enhanced B1 security.

8.8.1 Introduction

Trusted AIX enhances system security through four primary elements of information security:

- ▶ Confidentiality
- ▶ Integrity
- ▶ Availability
- ▶ Accountability

In addition to the security features provided by AIX, Trusted AIX adds the following capabilities:

Sensitivity labels (SLs) All processes and files are labeled according to their security level. Processes can only access objects that are within the process' security range.

Integrity labels (TLs) All processes and files are labeled according to their integrity level. Files cannot be written by processes that have a lower integrity level label than the file. Processes cannot read from files that have a lower integrity level label than the process.

File security flags	Individual files can have additional flags to control security related operations.
Kernel security flags	The entire system can have different security features enabled or disabled.
Privileges	Many commands and system calls are only available to processes with specific privileges.
Authorizations	Each user can be granted a unique set of authorizations. Each authorization allows the user to perform specific security-related functions. Authorizations are assigned to users through roles.
Roles	Role Based Access Control function, as part of Trusted AIX, provides for selective delegation of administrative duties to non-root users. This delegation is achieved by collecting the relevant authorizations into a Role and then assigning the role to a non-root user.

Confidentiality

Threats centered around disclosure of information to unauthorized parties are a confidentiality issue.

Trusted AIX provides object reuse and access control mechanisms for protecting all data resources. The operating system ensures that protected data resources can only be accessed by specifically authorized users and that those users cannot make the protected resources available to unauthorized users either deliberately or accidentally.

Administrators can prevent sensitive files from being written to removable media, from being printed on unprotected printers, or from being transferred over a network to unauthorized remote systems. This security protection is enforced by the operating system and cannot be bypassed by malicious users or rogue processes.

Integrity

Threats centered around modification of information by unauthorized parties are an integrity issue.

Trusted AIX offers numerous security mechanisms which ensure the integrity of trusted computing base and protected data, whether the data is generated on the system or imported using network resources. Various access control security mechanisms ensure that only authorized individuals can modify information. To prevent malicious users or rogue processes from seizing or disabling system resources, Trusted AIX eliminates the root privilege. Special administrative

authorizations and roles allow the separation of administration duties, rather than giving a user root privileges.

Availability

Threats centered around accessibility of services on a host machine are an availability issue. For example, if a malicious program fills up file space so that a new file cannot be created, there is still access, but no availability.

Trusted AIX protects the system from attacks by unauthorized users and processes that can create a denial of service. Unprivileged processes are not allowed to read or write protected files and directories.

Accountability

Threats centered around not knowing which processes performed which actions on a system are an accountability issue. For example, if the user or process that altered a system file cannot be traced, you cannot determine how to stop such actions in the future.

This enhanced security feature ensures identification and authentication of all users prior to allowing user access to the system. The audit services provide the administrator a set of auditable events and an audit trail of all security-related system events.

8.8.2 Considerations

The following are the major considerations pertaining to Trusted AIX

- ▶ Trusted AIX is installed through the AIX install menus. Additional options can be chosen during installation of Trusted AIX. The option related to LSPP EAL4+ configuration is supported.
- ▶ Trusted AIX environment cannot revert to regular AIX environment without performing an overwrite install of regular AIX.
- ▶ Root is disabled from logging in a Trusted AIX environment.
- ▶ In a Trusted AIX environment, any WPARs created will also operate in the Labeled Security environment.
- ▶ Trusted AIX supports both MAC (Mandatory Access Control) and MIC (Mandatory Integrity Control). Customer can define separate sets of labels for MAC and MIC.
- ▶ Label Encodings file is located in the /etc/security/enc directory and captures the label-to-binary translation information. The default Label Encodings file adheres to the Compartmented Mode Workstations (CMW) labels-related naming requirements.

- ▶ NIM installs are supported when initiated from Client. NIM install push from Server is not possible because root is disabled for logins on MLS systems.
- ▶ The JFS2 (J2) file system (using Extended Attributes version 2) has been enabled for storing Labels in AIX. Other file systems (such as J1 or NFS) can only be mounted in a Trusted AIX environment as single-level file systems (label assigned to the mount point).
- ▶ X environment is disabled for Trusted AIX.
- ▶ Trusted AIX supports CIPSO and RIPS0 protocols for network-based label-based communication. These protocols are supported for both IPv4 and IPv6.
- ▶ Some AIX security mechanisms are common between regular AIX and Trusted AIX. Two of these common security mechanisms are Role Based Access Control (RBAC) and Trusted Execution for integrity verification.
- ▶ Since root is disabled when Trusted AIX is installed, the installer must set up passwords for ISSO, SA, and SO users during the first boot after install. The system remains usable until these passwords are created.

For installation and configuration, See *AIX V6 Advanced Security Features Introduction and Configuration*, SG24-7430.

8.8.3 Identification and authentication

Identification and authentication security mechanisms are responsible for assuring that each individual requesting access to the system is properly identified and authenticated. Identification requires a user name and authentication requires a password

All Trusted AIX accounts are password protected. The ISSO (Information Systems Security Officer) can configure the system to allow a user to select his/her own password, subject to password length and complexity constraints. The ISSO can also specify minimum and maximum password aging parameters (expiration periods) on a per-user basis, including warning periods prior to password expiration.

The identification and authentication security mechanisms require that all usernames and user IDs be unique. Accounts without valid passwords cannot be used for login. A user with the ISSO role must add the initial password for all new users. Each user is assigned an additional unique identifier that is used for auditing purposes.

Only the encrypted form of the password is stored. Passwords are not stored on the system in plain text form. The encrypted passwords are stored in a shadow

password file, which is protected against access except by privileged processes. For more information, see the `passwd` command.

Trusted AIX systems recognize two types of accounts: system accounts and user accounts. System accounts are those with a user ID less than 128. Although system accounts may have associated passwords, they cannot be used for logging on to the system.

8.8.4 Discretionary access control

Discretionary access controls (DAC) are the security aspects that are under the control of the file or directory owner.

UNIX permissions

A user with owner access to a resource can do the following:

- ▶ Directly grant access to other users
- ▶ Grant access to a copy to other users
- ▶ Provide a program to allow access to the original resource (for example, using SUID programs)

The traditional UNIX permission bit method (owner/group/other and read/write/execute) is an example of this DAC functionality.

Permission bits enable users to grant or deny access to the data in a file to users and groups (based on the need-to-know criterion). This type of access is based on the user ID and the groups to which the user belongs. All file system objects have associated permissions to describe access for the owner, group, and world.

The owner of a file can also grant access privileges to other users by changing the ownership or group of the file with the `chown` and `chgrp` commands

umask

When a file is created, all permission bits are initially turned on. The file then has certain permission bits removed by the `umask` process, which has been set during the login process. The default `umask` applies to every file created by the user's shell and every command run from the user's shell.

By default, the `umask` setting for kernel items is 000 (which leaves all permissions available to all users). AIX sets the kernel `umask` to 022 (which turns off group and world write permission bits). However, users may override this setting if needed.

Note: Be very cautious about changing the umask to a setting more permissive than 022. If more permissions are available on files and processes, the system as a whole becomes less secure.

There are two methods to override the default umask setting:

- ▶ You can change the umask values in your `.profile`, `.login`, or `.chsrc` files. These changes will affect any file that is created during your login session.
- ▶ You can set the umask levels for individual processes with the `umask` command. After running the `umask` command, all new files that are created will be affected by the new umask value until one of the following two events occur:
 - You run the `umask` command againOR
 - You exit the shell in which the `umask` command was issued

If you run the `umask` command with no arguments, the `umask` command returns the current umask value for your session.

You should allow the login session to inherit the kernel's 022 umask value by not specifying a umask in your profiles. Umask values less restrictive than 022 should only be used with great caution.

If additional permissions are needed for certain files, these permissions should be set with judicious use of the `chmod` command after the files have been created.

Access Control Lists

In addition to the standard UNIX permission bits and umask value, AIX also supports access control lists (ACLs).

UNIX permission bits only control access for the file owner, one group, and everyone on the system. With an ACL, a file owner can specify access rights for additional specific users and groups. Like permission bits, ACLs are associated with individual system objects, such as file or directory.

The `setuid` and `setgid` command permission bits

The `setuid` and `setgid` permission bits (set user ID and set group ID) allow a program file to run with the user ID or group ID of the file owner rather than the user ID or group ID of the person who is running the program. This is accomplished by setting the `setuid` and `setgid` bits that are associated with the file. This permits the development of protected subsystems, where users can access and run certain files without having to own the files.

If the setgid bit is set on a parent directory when an object is created, the new object will have the same group as the parent directory, rather than the group of the object's creator. However, objects created in a directory with the setuid bit set are owned by the object's creator, not the directory owner. The setuid/setgid bits of the parent directory are inherited by subdirectories when subdirectories are created.

The setuid and setgid permission bits represent a potential security risk. A program that is set to run with root as the owner could have essentially unlimited access to the system. On Trusted AIX systems, however, the use of privileges and other access controls significantly reduces this security risk.

8.8.5 Role Based Access Control elements

Trusted AIX supports Role Based Access Control (RBAC). RBAC an operating system mechanism through which the root/system super user specific system functions can also be performed by regular users using the roles that are assigned to them.

The core elements of AIX RBAC are:

Authorizations	These strings indicate the privilege operation that they represent and control by name directly. For example an authorization string aix.network.manage defines the network management function in AIX.
Privileges	A privilege is an attribute of a process that allows the process to bypass specific system restrictions and limitations. Privileges are associated with a process and are typically acquired through the execution of a privileged command.
Roles	Role elements in AIX RBAC allow users to combine a set of management functions in the system and assign these functions to be managed by a regular user. Roles in AIX consist of a collection of authorizations (these can be both system authorizations as well as custom authorizations) and any other roles (as sub roles).

The authorizations, roles and privileges introduced for RBAC require additions and modifications for Trusted AIX. These authorizations and privileges are only active in a Trusted AIX environment.

Table 8-9 on page 332 provides the authorizations that are active in a Trusted AIX system:

Table 8-9 Trusted AIX Authorizations

Trusted AIX Authorization	Description
aix.mls.lef	Validate LEF file (labck)
aix.mls.pdir.create	Create partition directories (pdmkdir)
aix.mls.pdir.remove	Delete partition directories (pdrmdir)
aix.mls.pdir.link	Create inks in partition directories (pdlink)
aix.mls.pdir.set	Convert regular directories to partition directories (pdset)
aix.mls.pdir.mode	Switch to real mode to access partition directories (pdmode)
aix.mls.label.sl	Change SL of filesystem objects (setsecattr)
aix.mls.label.sl.downgrade	Downgrade SL of filesystem objects (setsecattr)
aix.mls.label.sl.upgrade	Upgrade SL of filesystem objects (setsecattr)
aix.mls.label.outsideaccred	Use labels outside the accreditation range of the system
aix.mls.label.tl	Change TL of filesystem objects. (setsecattr)
aix.mls.label.tl.downgrade	Downgrade TL of filesystem objects. (setsecattr)
aix.mls.label.tl.upgrade	Upgrade TL of filesystem objects. (setsecattr)
aix.mls.stat	View label attributes of filesystem objects.
aix.mls.network.init	Initialize the trusted network sub-system and maintain the trusted network rules database.
aix.mls.network.config	Command for adding, removing, listing, or querying rules, flags and security labels for interfaces and hosts'
aix.mls.proc.sl aix.mls.proc.sl.downgrade aix.mls.proc.sl.upgrade aix.mls.proc.stat	Change SL of Processes Downgrade SL of Processes Upgrade SL of Processes View Label Attributes of Processes
aix.mls.proc.tl aix.mls.proc.tl.downgrade aix.mls.proc.tl.upgrade	Change TL of Processes Downgrade TL of Processes Upgrade TL of Processes
aix.mls.system.config.write	Modify MLS kernel flags. (setsecconf)

Trusted AIX Authorization	Description
aix.mls.system.config.read	Read MLS Kernel flags. (getseconf)
aix.mls.system.label.read	Read System labels. (getsyslab)
aix.mls.system.label.write	Modify System labels. (setsyslab)
aix.mls.tpath	Trusted Path administration. (tlbadmin)
aix.mls.clear.read	Read clearance attributes of users. (lsuser)
aix.mls.clear.write	Modify clearance attributes of users. (chuser)
aix.mls.login	Allow login on restricted consoles.
aix.mls.system.mode	Allows to switch the runmode. Setrunmode

Users, Roles, and Authorizations

A Trusted AIX installation requires three administrative roles namely, Information System Security Officer (ISSO), System Administrator (SA) and System Operator (SO).

Table 8-10 shows Roles and authorizations map:

Table 8-10 Relations between Authorizations and Roles

Authorizations	ISSO	ISSO with MLS	SA	SO	SO with MLS
aix.device	-	-	-	-	-
aix.device.config.printer	-	-	-	OK	OK
aix.device.config.random	-	-	-	OK	OK

Authorizations	ISSO	ISSO with MLS	SA	SO	SO with MLS
aix.fs	-	-	OK	-	-
aix.fs.manage.backup	-	-		OK	OK
aix.fs.manage.export	OK	OK		-	-
aix.fs.manage.mount	-	-		OK	OK
aix.fs.manage.quota	-	-		OK	OK
aix.fs.manage.recover	-	-		OK	OK
aix.fs.manage.unmount	-	-		OK	OK
aix.fs.object.create	OK	OK		-	-
aix.fs.object.list	OK	OK		-	-
aix.network.config.arp	OK	OK	-	-	-
aix.network.config.host	OK	OK	-	-	-
aix.network.config.mail	-	-	-	OK	OK
aix.network.config.no	OK	OK	-	-	-
aix.network.config.route	OK	OK	-	-	-
aix.network.config.tcpip	OK	OK	-	-	-
aix.network.status	-	-	-	OK	OK
aix.proc.kill	-	-	-	OK	OK
aix.proc.status	OK	OK	-	-	-
aix.ras.audit	OK	OK	-	-	-
aix.ras.audit.config	OK	OK	-	-	-
aix.security.group\	OK	OK	-	-	-
aix.security.passwd	OK	OK	-	-	-
aix.security.role	OK	OK	-	-	-
aix.system.boot\	OK	OK	-	-	-
aix.system.boot.halt	-	-	-	OK	OK
aix.system.boot.reboot	-	-	-	OK	OK

Authorizations	ISSO	ISSO with MLS	SA	SO	SO with MLS
aix.system.boot.shutdown	-	-	-	OK	OK
aix.system.config.init	-	-	-	OK	OK
aix.system.config.cron	-	-	OK	-	-
aix.system.config.date	OK	OK	-	-	-
aix.system.config.src	OK	OK	-	-	-
aix.system.config.uname	OK	OK	-	-	-
aix.system.config.wlm	-	-	-	OK	OK
aix.security.tsd	OK	OK	-	-	-
aix.mls.clear	-	OK	-	-	-
aix.mls.network.config	-	OK	-	-	-
aix.mls.network.init	-	OK	-	-	-
aix.mls.network.config	-	OK	-	-	-
aix.mls.label	-	OK	-	-	-
aix.mls.lef	-	OK	-	-	-
aix.mls.login	-	OK	-	-	OK
aix.mls.pdir	-	OK	-	-	-
aix.mls.proc	-	OK	-	-	-
aix.mls.stat	-	OK	-	-	-
aix.mls.system.config	-	OK	-	-	-
aix.mls.system.label	-	OK	-	-	-
aix.mls.tpath	-	OK	-	-	-

8.8.6 Trusted AIX packages

Table 8-11 on page 336 provides the filesets that are installed as part of Trusted AIX installation:

Table 8-11 Filesets installed in Trusted AIX environment

Fileset	Remarks
bos.mls.rte	MLS commands are packaged into this fileset
bos.mls.lib	It is a now only a placeholder
bos.mls.adt	SDK for MLS are packaged into this fileset.
bos.mls.cfg	MLS configuration files are packaged into this fileset.
bos.mls.smit	SMIT tools and dialogs related to MLS are packaged into this fileset.

The bos.mls.lib is added to BOS.autoi and SbD.BOS.autoi and CCEVAL.BOS.autoi and will be always installed during BOS installation.

The bos.mls.rte fileset creates three default administrative users isso, sa, and so with default roles ISSO, SA and SO respectively as part of the pre install scripts (bos.mls.rte.pre_i script) for the fileset.

Note: The passwords for these users are prompted as part of the install assistant which happens after the first boot. Set ISSO, SA and SO Passwords replaces Set root Password item under Installation Assistant Main Menu. If the system is installed by non prompted install method, the passwords are hard coded to be same as the default user names.

The following entries will be added to inittab using bos.mls.rte.config script

- ▶ rc.mls.boot
- ▶ rc.mls.net
- ▶ rc.mls

8.8.7 Trusted AIX commands

Security-related commands are provided to manage a Trusted AIX system:

labck	Verifies a LabelEncodings file
getseconf	Displays the kernel security flags
setseconf	Changes the Trusted AIX kernel security flags
getsyslab	Shows the kernel maximum and minimum labels

setsyslab	Sets the kernel maximum and minimum labels
getrunmode	Displays the current running mode of the system
setrunmode	Switches the running mode of the system
pdlink	Links files across partitioned subdirectories
pdmkdir	Creates partitioned directories and subdirectories
pdmode	Returns the current partitioned directory access mode or runs a command with a specified partitioned directory access mode
pdrmdir	Removes partitioned directories and associated subdirectories
pdset	Sets/unsets partitioned (sub)directories
bootauth	Verifies that an authorized user is booting the system
chuser	Changes the user's clearance attributes
lsuser	Displays the user's clearance attributes
chsec	Changes the user's clearance attributes and port labels
lssec	Displays the user's clearance attributes and port labels
trustchk	Checks the attributes of files
lstxattr	Displays the label and security flag attributes of files, processes, and IPC objects
settxattr	Changes the label and security flag attributes of files, processes, and IPC objects

8.9 Trusted Execution Environment

Trusted Execution (TE) mechanism is newly introduced in AIX V6.1 to enhance AIX security environment. Trusted Execution refers to a collection of features that are used to verify the integrity of the system and implement advance security policies, which together can be used to enhance the trust level of the complete system.

This new component introduces a new command to verify a system's integrity while the Trusted Computing Base (TCB) is still available as an alternative. Unlike the TCB, which maintains checksums for crucial files and verifies them periodically (either triggered by cron or CLI), TE does such *offline checking* as well, but also allows for checking a file's integrity at its execution time, every time.

TE refers to a collection of features that are used to verify the integrity of the system's trusted computing base which in the context of TE is called Trusted Signature Database (TSD). In addition, TE implements advanced security policies, which together can be used to enhance the trust level of the complete system. The usual way for a malicious user to harm the system is to get access to the system and then install trojan horses, rootkits, or tamper with some security critical files such that the system becomes vulnerable/exploitable.

The central idea behind the set of features under TE is to be able to prevent such activities or in worst case be able to identify if any such thing happens to the system. Using the functionality provided by TE, the system administrator can decide upon the actual set of executables that are allowed to execute or the set of kernel extensions that are allowed to be loaded.

The usual way for a malicious user to harm the system is to get access to the system and then install Trojans, rootkits or tamper some security critical files, resulting in the system becoming vulnerable and exploitable. The central idea behind the set of features under Trusted Execution is prevention of such activities or in worst case be able to identify if any such incident happens to the system. Using the functionality provided by Trusted Execution, the system administrator can decide upon the actual set of executables that are allowed to execute or the set of kernel extensions that are allowed to be loaded. It can also be used to audit the security state of the system and identify files that have changed, thereby increasing the trusted level of the system and making it more difficult for the malicious user to do harm to the system.

In order for TE to work, the CryptoLight for C library (CLiC) and kernel extension need to be installed and loaded on your system. These filesets are included on the AIX Expansion Pack and are provided at no charge. To check whether they are installed on your system and loaded into the kernel, run:

Example 8-2 CLiC filesets

```
# lspp -l "cl*ic*"
Fileset                                Level State   Description
-----
Path: /usr/lib/objrepos
  clic.rte.includes                    4.3.0.0 COMMITTED CryptoLite for C Library
                                         Include File
  clic.rte.kernext                     4.3.0.0 COMMITTED CryptoLite for C Kernel
  clic.rte.lib                         4.3.0.0 COMMITTED CryptoLite for C Library
  clic.rte.pkcs11                      4.3.0.0 COMMITTED PKCS11 Software Token Support

Path: /etc/objrepos
  clic.rte.kernext                     4.3.0.0 COMMITTED CryptoLite for C Kernel
```

This section describes as follows:

- ▶ Trusted Signature Database
- ▶ Trusted Execution
- ▶ Trusted Execution Path, Trusted Library Path

For auditing, configurations of Trusted Execution, see *AIX V6 Advanced Security Features Introduction and Configuration*, SG24-7430.

8.9.1 Trusted Signature Database

The File Verification mechanism is similar to the existing Trusted Computing Base (TCB) subsystem in certain aspects. Whereas TCB verifies the integrity of the file using check sum values, this mechanism will ensure the trust of the files using hash signatures. These signatures are actually a mathematical hash of the file data. By default SHA-256 is used as the hashing algorithm, however the system owner has option to configure the hashing algorithm from a list of supported algorithms. Since every file has its own unique hash value, a database is needed on the system to store these values. This is in lines with TCB which uses a file `/etc/security/sysck.cfg` to store the check sum values. Similarly, a new data file `/etc/security/tsd/tsd.dat` is introduced to serve as the database for storing different security attributes like the hash values for the trusted files. See Example 8-3.

Example 8-3 Example of stanza of ksh command in the TSD

```

/usr/bin/ksh:
  owner = bin
  group = bin
  mode = TCB,555
  type = FILE
  hardlinks = /usr/bin/sh,/usr/bin/psh,/usr/bin/tsh,/usr/bin/rksh
  symlinks =
  size = 288056
  cert_tag = 00af4b62b878aa47f7
  signature = 27af0e83720a1700a0e96c79ce1944b2e71677be565275a29dacd0ad9504
8c15cda82b3108e4a361193629f788f98f343ee49ad5ae51b9f2bd9e4a0e37fe020f30038967aa14
251c92e36bc912608a63adbada0340749a5eaf003989a977ff2e2c65f73482864cef0e1b5ba36e20c
064a92854a6200af8d0bba556ebb9c08271a
  hash_value = 293b40b6d138daaa5746539f37e1d4e45eba613be6112f5b8f3c69560c8
c306e
  minslabel =

```

```
maxlabel =  
intlabel =  
accessauths =  
innateprivs =  
inheritprivs =  
...
```

To manage Trusted Signature Database, See Trusted Signature Database in AIX V6.1 online manual, or Signature creation and deployment in *AIX V6 Advanced Security Features Introduction and Configuration*, SG24-7430.

8.9.2 Trusted Execution

Trusted Execution provides a new command to verify integrity for the system. The **trustchk** command has the following two methods for integrity check:

- ▶ System integrity check
- ▶ Runtime integrity check

System integrity check

System integrity check is a static method to check integrity. It is executed when the **trustchk** command is executed on command line, by **cron**, or from **rc.m1s.boot** script in boot time. The Trusted Signature Database (TSD) (*/etc/security/tsd/tsd.dat*) and the certificates (*/etc/security/certificates/**) are used to check integrity. This database and certificates are created at Trusted system installation time.

An overview of the system integrity check is shown in Figure 8-15 on page 341.

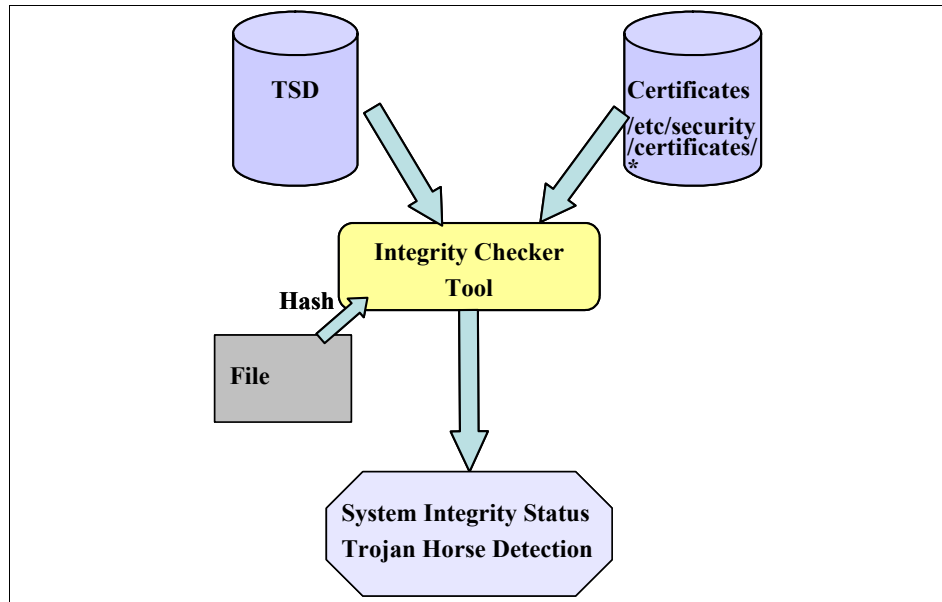

Figure 8-15 System integrity check

Note: An administrator manually by running the `trustchk -t ALL` command on normal system, these checks are done only on MLS system (Trusted AIX).

Runtime integrity check

The Trusted Execution feature provides you with a run-time file integrity verification mechanism. Using this mechanism, the system can be configured to check the integrity of the trusted files before every request to access those file, effectively allowing only the trusted files that pass the integrity check to be accessed on the system (Figure 8-16 on page 342).

When a file is marked as trusted (by adding its definition to Trusted Signature Database), the Trusted Execution feature can be made to monitor its integrity on every access. Trusted Execution can continuously monitor the system and is capable of detecting tampering of any trusted file (by a malicious user or application) present on the system at run-time (for example, at load time). If the file is found to be tampered, Trusted Execution can take corrective actions based on pre-configured policies, such as disallow execution, access to the file, or logging error. If a file being opened or executed, and has an entry in the Trusted Signature Database (TSD), the Trusted Execution performs as follows:

- ▶ Before loading the binary, the component responsible for loading the file (system loader) invokes the Trusted Execution subsystem, and calculates the hash value using the SHA-256 algorithm (configurable).
- ▶ This run-time calculated hash value is matched with the one stored in the TSD.
- ▶ If the values match, the file opening or execution is permitted.
- ▶ If the values do not match, either the binary is tampered, or somehow compromised. It is up to the user to decide the action to be taken. The Trusted Execution mechanism provides options for users to configure their own policies for the actions to be taken if the hash values do not match.
- ▶ Based on these configured policies, a relevant action is taken.

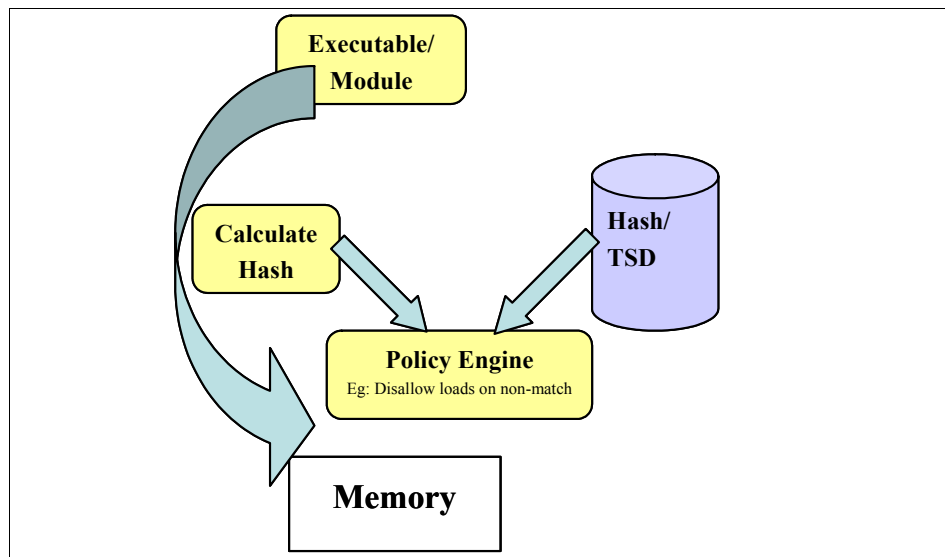

Figure 8-16 Runtime integrity check

8.9.3 Trusted Execution Path, Trusted Library Path

The Trusted Execution Path (TEP) defines a list of directories that contain the trusted executables. Once TEP verification is enabled, the system loader allows only binaries in the specified paths to execute. For example:

```
# trustchk -p tep
TEP=OFF
TEP=/usr/bin:/usr/sbin
# trustchk -p
tep=/usr/bin:/usr/sbin:/etc:/bin:/sbin:/usr/lib/inst1:/usr/ccs/bin
```

```
# trustchk -p tep
TEP=OFF
TEP=/usr/bin:/usr/sbin:/etc:/bin:/sbin:/usr/lib/inst1:/usr/ccs/bin
# trustchk -p tep=on
# trustchk -p tep
TEP=ON
```

The Trusted Library Path (TLP) has the same functionality as TEP with the only difference that it is used to define the directories that contain trusted libraries of the system. Once TLP is enabled, the system loader will allow only the libraries from this path to be linked to the binaries. The `trustchk` command can be used to enable/disable the TEP/TLP as well as to set the colon-separated path list for both using TEP and TLP command-line attributes of `trustchk`:

```
# trustchk -p tlp
TLP=OFF
TLP=/usr/lib:/usr/ccs/lib:/lib:/var/lib
```

TLP uses a flag to control its operations: `FSF_TLIB`. If the file has the `FSF_TLIB` flag set in its TSD stanza, then the process resulting from it will be set as a TLIB process. Processes marked as TLIB processes can link only to *.so libraries that also have the TLIB flag set.

8.10 Password length and encryption algorithms

Recent advancements in computer hardware makes the traditional UNIX password encryption vulnerable to brute force password guessing attacks. A cryptographically weak algorithm can lead to recovery of even strong passwords. AIX V6.1 and AIX 5L V5.3 TL7 introduces Loadable Password Algorithm (LPA). It also removes the 8 character password limitation.

8.10.1 Existing crypt()

AIX standard authentication mechanism authenticates users using a one-way hash function called `crypt()`. `crypt()` is a modified DES algorithm. It performs a one-way encryption of a fixed data array with the supplied password and a Salt.

`crypt()` uses only the first 8 characters from the password string. The user's password is truncated to eight characters. If the password is shorter than 8 characters, it is padded with zero bits on the right. The 56-bit DES key is derived by using the 7 bits from each character.

Salt is a two-character string (12-bit of the Salt is used to perturb the DES algorithm) chosen from the character set "A-Z", "a-z", "0-9", "." (period) and "/". Salt is used to vary the hashing algorithm, so that the same clear text password can produce 4,096 possible password encryptions. A modification to the DES algorithm, swapping bits i and $i+24$ in the DES E-Box output when bit i is set in the Salt, achieves this while also making DES encryption hardware useless for password guessing.

The 64-bit all-zero block is encrypted 25 times with the DES key. The final output is the 12-bit salt concatenated with the encrypted 64-bit value. The resulting 76-bit value is recoded into 13 printable ASCII characters in the form of base64.

8.10.2 Password hashing algorithms

The hashing algorithms, like MD5, are harder to break than `crypt()`. This provides a strong mechanism against brute force password guessing attacks. Since the whole password is used for generating the hash, there is no password length limitation when we use the password hashing algorithms to encrypt the password.

8.10.3 Loadable Password Algorithm

AIX V6.1 and AIX 5L V5.3 TL7 implemented Loadable Password Algorithm (LPA) mechanism that can easily deploy new password encryption algorithms.

Each supported password encryption algorithm is implemented as a LPA load module that is loaded at runtime when the algorithm is needed. The supported LPAs, and its attributes, are defined in system configuration file `/etc/security/pwdalg.cfg`.

Administrator can setup a system wide password encryption mechanism that uses a specific LPA to encrypt the passwords. After the system wide password mechanism changed, AIX V6.1 and AIX 5L V5.3 TL7 still supports the passwords that encrypted by the previous selected password encryption mechanisms, like the legacy `crypt()` function.

The MD5, SHA and Blowfish password algorithms are implemented as LPAs.

The Loadable Password Algorithm (LPA) supports features as follows:

- ▶ New secure password hash algorithms
- ▶ Support greater than 8 character password
- ▶ Support more valid characters in passwords

8.10.4 Support greater than 8 character password

All the LPAs implemented for AIX V6.1 and AIX 5L V5.3 TL7 support passwords longer than 8 characters. The password length limitations are different from LPA to LPA. The maximum length of password supported by AIX V6.1 and AIX 5L V5.3 TL7 is 255.

8.10.5 LPA configuration file

The LPA configuration file is `/etc/security/pwdalg.cfg`. It is a stanza file that defines the attributes of supported LPAs.

The attribute of a LPA that are defined in the config file include:

- ▶ The path to the LPA module
- ▶ The optional flags that is passed to the LPA module at runtime

The attribute of the LPA defined in the configuration file can be accessed through `getconfattr()` and `setconfattr()` interfaces.

The following example stanza in `/etc/security/pwdalg.cfg` defines a LPA named "sha256":

```
sha256:  
  lpa_module = /usr/lib/security/ssh  
  lpa_options = algorithm=sha256
```

8.10.6 System password algorithm

System administrator can set a system wide password algorithm by selecting a LPA as the password hashing algorithm. There will be only one active system password algorithm at a time. The system password algorithm is defined by a system attribute, `pwd_algorithm`, in the stanza of `usw` in `/etc/security/login.cfg` file.

The valid values for `pwd_algorithm` attribute in `/etc/security/login.cfg` are LPA stanza names that are defined in `/etc/security/pwdalg.cfg` file. Another valid value for `pwd_algorithm` attribute is `crypt` which refer to the legacy `crypt()` encryption. If the `pwd_algorithm` attribute is omitted from the config file, `crypt` is used as the default value.

The following example of `/etc/security/login.cfg` shows that the administrator chosen to use "sha256" LPA as the system wide password encryption algorithm.

```

usw:
    shells =
    /bin/sh,/bin/bsh,/bin/csh,/bin/ksh,/bin/tsh,/bin/ksh93,/usr/bin/sh,/usr
    /bin/bsh,/usr/bin/csh,/usr/bin/ksh,/usr/bin/tsh,/usr/bin/ksh93,/usr/bin
    /rksh,/usr/bin/rksh93,/usr/sbin/uucp/uucico,/usr/sbin/sllogin,/usr/sb
    in/snappd
    maxlogins = 32767
    logintimeout = 60
    maxroles = 8
    auth_type = STD_AUTH
    pwd_algorithm = ssha256

```

The system password algorithm takes effect only on the newly created passwords and changed passwords. After the migration all subsequent new passwords or password changes will be done using the system password algorithm. The existing passwords before the system password algorithm is chosen, either generated by the standard crypt() or other supported LPA modules, still work on the system. Therefore, mixed passwords that generated by different LPAs may coexist on the system.

New secure password hash algorithms

Table 8-12 lists all the supported algorithms and their characteristics:

Table 8-12 Algorithms and their characteristics

Algorithm	Maximum Password Length	Length of Salt, base64	Iterations	Length of Hashed String, base64	Maximum Length of Hashed Password, base64
crypt	8	2-char (12-bit)	25 (built-in)	11-char (64-bit)	13-char (76-bit)
MD5	255	2 to 8-char (48-bit)	1000 (built-in)	22-char (128-bit)	37-char ({smd5}salt\$hashed_str)
SHA1	255	8 to 24-char	2^4 to 2^{31} (cost is 4 to 31)	27-char (160-bit)	62-char ({sha1}nn\$salt\$hashed_str)
SHA256	255	8 to 24-char	2^4 to 2^{31} (cost is 4 to 31)	43-char (256-bit)	80-char ({sha256}nn\$salt\$hashed_str)
SHA512	255	8 to 24-char	2^4 to 2^{31} (cost is 4 to 31)	86-char (512bit)	123-char ({sha256}nn\$salt\$hashed_str)

Algorithm	Maximum Password Length	Length of Salt, base64	Iterations	Length of Hashed String, base64	Maximum Length of Hashed Password, base64
Blowfish	72	22-char	2 ⁴ to 2 ³¹ (cost is 4 to 31)	32-char (192-bit)	69-char ({ssha256}nn\$salt\$hashed_str)

8.10.7 Support more valid characters in passwords

For the nature of the `crypt()` algorithm, all the characters (>0x80) in the extended ASCII table, are not allowed exist in passwords.

Most of the hashing algorithms, like MD5 and SHA, support binary data. Therefore, the characters in the extended ASCII table are allowed in passwords for these new algorithm. The space character is allowed in passwords as well.

8.10.8 Setup system password algorithm

System administrator can setup system password algorithm using `chsec` command, or manually modifying the `pwd_algorithm` attribute in `/etc/security/login.cfg` using an editor such as `vi`.

We recommend that using `chsec` command to set the system password algorithm because the command automatically checks the definition of the chosen LPA.

Using `chsec` command

Use the following `chsec` command to set "smd5" LPA as the system wide password encryption module:

```
chsec -f /etc/security/login.cfg -s usw -a pwd_algorithm=smd5
```

When use `chsec` command to modify the `pwd_algorithm` attribute, the command checks the `/etc/security/pwdalg.cfg` to verify the chosen LPA. The command fails if the check are failed.

Using editor

When administrator manually changes the `pwd_algorithm` attribute value in `/etc/security/login.cfg` using an editor, please make sure that the chosen value is a name of a stanza that is defined in `/etc/security/pwdalg.cfg` file.

8.10.9 Changes to support long password

The following changes were made in order to support a longer password.

Changes to limits.h

The previous AIX definition of PASS_MAX is in limits.h as:

Example 8-4 Password MAX Limit (Before AIX 5L V5.3 TL7)

```
#define PASS_MAX      32
```

The new PASS_MAX is defined as 255.

Example 8-5 Password MAX Limit (AIX 5L V5.3 TL7 and AIX V6.1)

```
#define PASS_MAX      255
```

Changes to userpw.h

userpw.h file defines password related manifest constants and macros.

Table 8-13 provides the symbols that are used for determining maximum possible sizes when declaring arrays, memory, and so on.

Table 8-13 Summary of changes to userpw.h

Macro name	Definition	Existing value	New values (AIX V6.1)
MAXIMPL_PW_PASLEN	password length in chars	9	256
MAXIMPL_PW_CRYPTLEN	hashed password length in chars	32	255
MAXIMPL_MAX_HISTSIZ	Maximum number of passwords kept.	50	50
MAXIMPL_SALT	Maximum length of salt.	4	32
MAX_PASS	PASS_MAX (defined in limits.h)	32 (PASS_MAX)	PASS_MAX
MAXIMPL_MAX_MINALPHA	alphanumeric characters	MAXIMPL_PW_PASLEN	MAXIMPL_PW_PASLEN
MAXIMPL_MAX_MINOTHER	non-alphabetic characters	MAXIMPL_PW_PASLEN	MAXIMPL_PW_PASLEN

Macro name	Definition	Existing value	New values (AIX V6.1)
MAXIMPL_MAX_MINDIFF	different characters in the new password	MAXIMPL_PW_PASLEN	MAXIMPL_PW_PASLEN
MAXIMPL_MAX_MAXREP	repeated characters	MAXIMPL_PW_PASLEN	MAXIMPL_PW_PASLEN
MAXIMPL_MAX_MINLEN	minimum length of a password.	MAXIMPL_PW_PASLEN	MAXIMPL_PW_PASLEN

Table 8-14 provides maximum size in the current configuration of the system at runtime. These are not suitable for use in array declarations, for example.

Table 8-14 Maximum size in the current configuration of the system

Macro Name	Previous AIX	C2 Extension	New Values (AIX V6.1)
PW_PASLEN	8	8	__get_pwd_len_max()
PW_CRYPTLEN	13	13	13
MAX_HISTSZ	50	50	50
MAX_SALT	2	2	__get_salt_len()
MAX_MINALPHA	PW_PASLEN	PW_PASLEN	PW_PASLEN
MAX_MINOTHER	PW_PASLEN	PW_PASLEN	PW_PASLEN
MAX_MINDIFF	PW_PASLEN	PW_PASLEN	PW_PASLEN
MAX_MAXREP	PW_PASLEN	PW_PASLEN	PW_PASLEN
MAX_MINLEN	PW_PASLEN	PW_PASLEN	PW_PASLEN

Changes to Password policy attributes

Table 8-15 on page 350 provides the password policy attributes that are related to the maximum length of a clear-text password, are defined in /etc/security/user for users.

The previous value ranges of these password policy attributes are limited by the previous PASS_MAX (8) value. The new value ranges of these password policy attributes should be limited by macro PW_PASLEN which value is defined by the system password algorithm.

The password restriction routines need to be change to replace the PASS_MAX (8) value with the new PW_PASSLEN value.

The comment (header) section of the /etc/security/user has range values for these password policy attributes, and they is modified to reflect the range changes.

Table 8-15 Password policy attributes

Password Policy Attributes	Meaning	Previous Value	New Value (AIX V6.1)
maxrepeats	Defines the maximum number of times a given character can appear in a password.	0 -- 8. Default is 8	0 -- PW_PASSLEN. Default is PW_PASSLEN
minalpha	Defines the minimum number of alphabetic characters in a password.	0 -- 8. Default is 8	0 -- PW_PASSLEN. Default is 0
minlen	Defines the minimum length of a password. The minimum length of a password is determined by minlen or 'minalpha + minother', whichever is greater. 'minalpha + minother' should never be greater than 8. If 'minalpha + minother' is greater than 8, then minother is reduced to '8 - minalpha'. 0 -- 8. Default is 0	0 -- 8. Default is 8	0 -- PW_PASSLEN. Default is 0. The minimum length of a password is determined by minlen or 'minalpha + minother', whichever is greater. 'minalpha + minother' should never be greater than PW_PASSLEN. If 'minalpha + minother' is greater than PW_PASSLEN, then minother is reduced to 'PW_PASSLEN - minalpha'.
minother	Defines the minimum number of non-alphabetic characters in a password.	0 -- 8. Default is 8	0 -- PW_PASSLEN. Default is 0

Password Policy Attributes	Meaning	Previous Value	New Value (AIX V6.1)
mindiff	Defines the minimum number of characters in the new password that were not in the old password.	0 -- 8. Default is 8	0 -- PW_PASSLEN. Default is 0



Installation, backup, and recovery

The following AIX Version 6.1 topics are covered in this chapter:

- ▶ 9.1, “AIX graphical installer” on page 354
- ▶ 9.2, “Network Install Manager NFSv4 support” on page 357

9.1 AIX graphical installer

AIX V6.1 introduces a new AIX base OS graphical installer. The graphical installer provides new AIX administrators with an easy and fast way to install the base operating system. If you boot from the AIX install DVD you can now choose between the standard text based install menus and the new graphical installer.

Your system or LPAR must meet this hardware requisites:

- ▶ DVD drive
- ▶ 256 MB RAM
- ▶ Graphical adapter
- ▶ Keyboard and mouse
- ▶ local SCSI or IDE disk

The graphical installer is available only on the AIX install DVD. You can use it to install AIX on new systems and it will provide you a fast way to use your new hardware. If the installer detects an existing data (defined volume groups) on the disks, the standard text based install menus will be displayed.

The graphical installer will take you through the following steps:

- ▶ Welcome screen and install language selection, Figure 9-1 on page 355
- ▶ Selection of installation type, Figure 9-2 on page 356
- ▶ Summary screen and AIX language selection, Figure 9-3 on page 357

If you need to specify or change other installation options, you have to use the traditional text based menus.

After choosing the installation options and selecting the “Quick Install” button, the installation progress is displayed in the standard text based format.

Note: At the time of writing the graphical installer does not support vscsi and SAS disks.

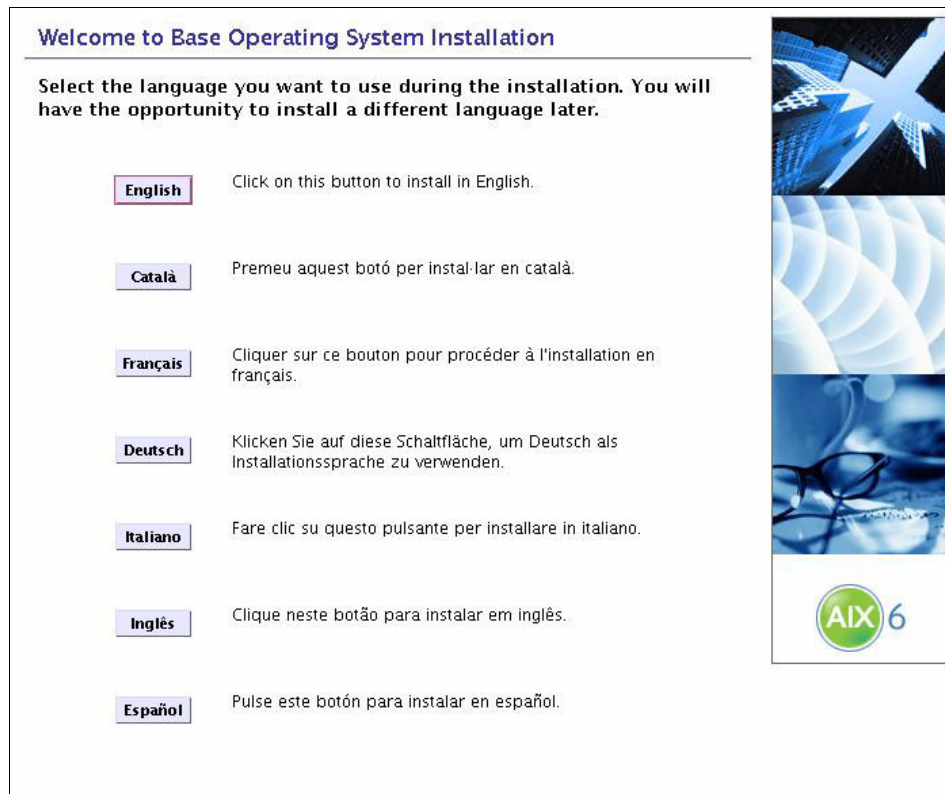

Figure 9-1 AIX graphical installer welcome and installation language selection

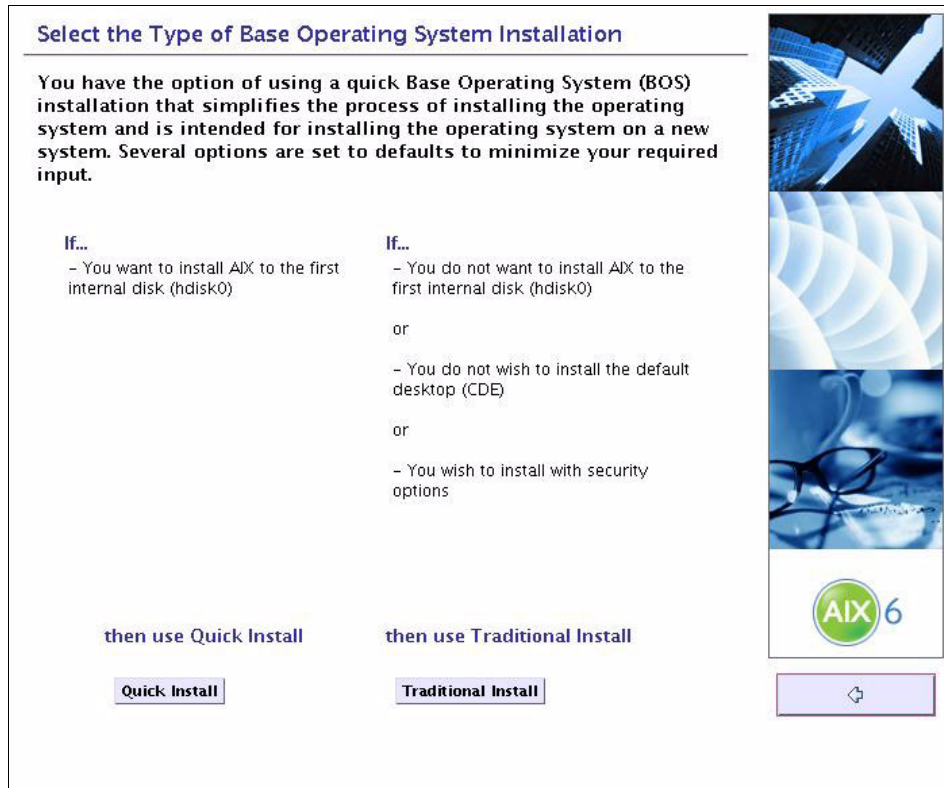

Figure 9-2 AIX graphical installer installation type selection screen

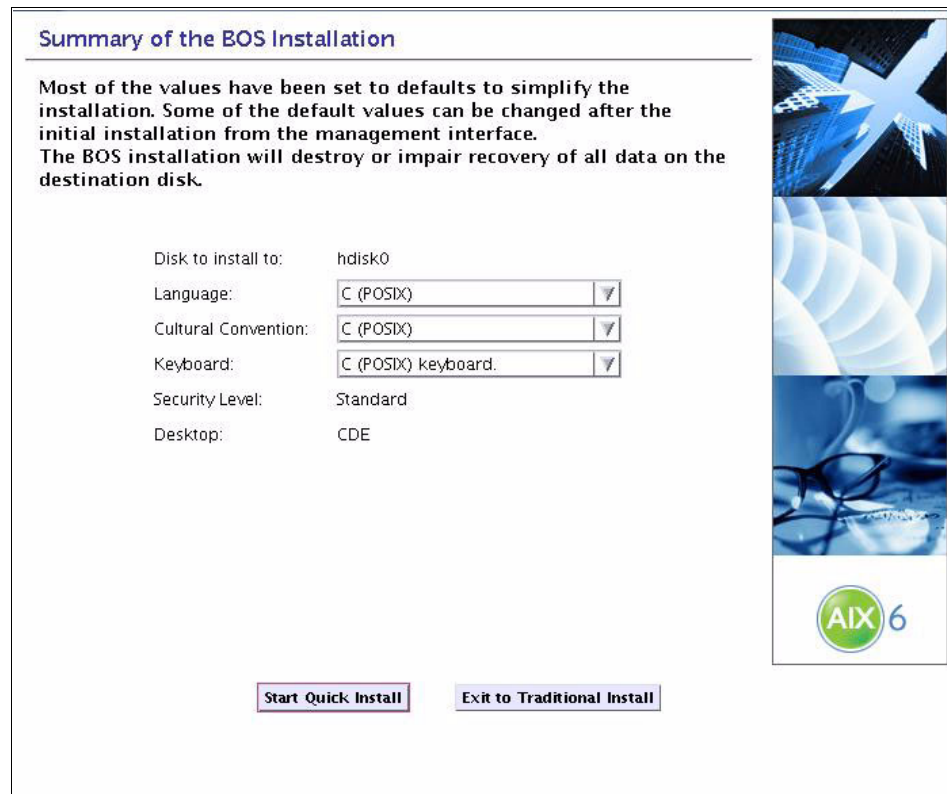

Figure 9-3 AIX graphical installer summary and AIX language selection screen

9.2 Network Install Manager NFSv4 support

Network Install Manager (NIM) is used in midsize and large AIX environments to perform base operating system installations over the network. In the past years many companies focused on securing their networks. With AIX V5.3 the NIM service handler (nimsh) was introduced to address the following security demands:

- ▶ Restricted shell environment that allows only NIM method execution.
- ▶ Possibility to use OpenSSL encryption with nimsh
- ▶ Optional disablement of NIM push operations initiated from the NIM master

All those nimsh features improve the security of remote method execution. The nimsh is introduced as an alternative to the as insecure considered rsh and rcmd commands.

AIX V6.1 provides NFSv4 support for NIM environments. With NFSv4 and Kerberos a securer authentication method is introduced.

The AIX NFSv4 implementation introduces the following general enhancements over NFSv3:

- ▶ Built-in security features
- ▶ Pseudo file system concept
- ▶ NFS4 ACL
- ▶ Better performance
- ▶ Locking mechanisms are now part of the protocol itself.

9.2.1 NFSv4 NIM integration

The NIM in AIX V6.1 allows to specify NFS settings on a NIM resource level. There are two new attributes introduced for that purpose. See Table 9-1:

Table 9-1 New NIM NFS attributes

Attribute	Description
vers	Controls which version NFS mounts are allowed. Possible values are 2, 3, and 4. Versions 2 and 3 cannot be enforced separately. Specifying Version 2 or 3 allows access by clients using either NFS protocol versions 2 or 3. Version 4 can be specified independently and must be specified to allow access by clients using Version 4 protocol. The default is 3.
sec	Controls which security methods are allowed. Possible values are: sys (UNIX authentication) and krb5 (Kerberos, authentication only). The default is sys.

Note that at the time of writing the security methods krb5i, krb5p, and dh are not manageable within the nim command and are not supported.

The attributes can be set on the NIM resource class. The most popular are listed here:

- ▶ bosinst_data
- ▶ spot

- ▶ lpp_source
- ▶ installp_bundle
- ▶ mkysyb
- ▶ script

Note: The NFS attributes are not available on any other nim classes. You cannot distinguish NFS settings on a per machine, network, or groups level. Therefore you have to make sure that if you restrict for example a lpp_source to NFSv4 only, there is no way a AIX V5.2 or older client can use it.

In order to use NFSv4 you must inform the NIM master which NFS domain the local nfsd uses. Use the following command to determine if a NFS domain already exists:

```
# chnfsdom
Current local domain: aix61diff_nfsdom
```

Use the **nim** command to specify which nfs domain name should be used by NIM or specify a new domain to be created:

```
nim -o change -a nfs_domain=aix61diff_nfsdom master
```

Important: This command does not only populate the NIM ODM, it will call the **chnfsdom** <domainname> command afterwards and overwrite the actual domainname. Check for carefully for spelling errors before executing the **nim** command if you want to specify an existent domain.

Example 9-1 shows the changed NFS settings on a lpp_source resource named AIX610_0:

Example 9-1 Change NIM NFS settings on a lpp_source

```
# lsnm -l AIX610_0
AIX610_0:
  class      = resources
  type       = lpp_source
  arch       = power
  Rstate     = ready for use
  prev_state = unavailable for use
  location   = /export/lpp_source/AIX610_0
  simages    = yes
  alloc_count = 0
  server     = master
```

```
# nim -o change -a nfs_sec=sys -a nfs_vers=4 AIX610_0

# lsnim -l AIX610_0
AIX610_0:
  class      = resources
  type       = lpp_source
  arch       = power
  Rstate     = ready for use
  prev_state = unavailable for use
  nfs_vers  = 4
  nfs_sec   = sys
  location   = /export/lpp_source/AIX610_0
  simages    = yes
  alloc_count = 0
  server     = master
```

The default is `nfs_vers=3` and `nfs_sec=sys`. Note if the defaults are active and the attributes have not been changed since creation of the resource, the `lsnim` command does not display the attributes.

To be able to use NFSv4 during the whole installation, you need to change the `bosinst_data` and the spot to use NFSv4 and then initiate a bos installation as follows:

```
# nim -o change -a nfs_sec=sys -a nfs_vers=4 bid_ow
# nim -o change -a nfs_sec=sys -a nfs_vers=4 610_0
# nim -o bos_inst -a spot=610_0 -a lpp_source=AIX610_0 \
  -a bosinst_data=bid_ow -a accept_licenses=yes \
  -a force_push=no -a installp_flags=cNgXY lpar02
```

BOS installations cannot be performed with Kerberos security. Changing the `sec` attribute to `krb5` on a spot and then trying to perform nim operations like `bos_inst` will fail and display an error will be displayed.

9.2.2 NFSv4 Security Overview

NFSv4 provides information security in the following context:

Identification	Establishes the identity of any users, hosts, or services
Authentication	Confirms the identity of a user, host, or service
Authorization	Controls what shared information each user or entity can access

Table 9-2 provides you with an high level overview of differences between the two available security flavors currently supported in AIX V6.1 NIM.

Table 9-2 AUTH_SYS and RPCSEC_GSS Kerberos differences

Security Level	AUTH_SYS	RPCSEC_GSS Kerberos
Host Identification	▶ Domain Name lookup from the IP address of the RPC packets.	
		▶ Machine principal. For example: host/nfs402.itsc.austin.ibm.com. ▶ Service principal. For example: nfs/nfs402.itsc.austin.ibm.com.
Host Authentication		▶ Service principal. For example: nfs/nfs402.itsc.austin.ibm.com.
Host Authorization	▶ /etc/exports ▶ exportfs command	
User Identification	▶ Standard UNIX user registry ▶ NIS ▶ LDAP	
User Authentication	▶ Usually logon name and password. ▶ The NFS server trusts the user and group identities presented by its clients.	▶ NFS Service Ticket obtained. ▶ Established security context for NFS requests.
User Authorization	▶ Standard UNIX file permissions ▶ AIXC ACL ▶ NFS V4 ACL	

9.2.3 RPCSEC_GSS Kerberos sample scripts

NIM includes two sample scripts to setup a basic Kerberos installation. The scripts are provided with the bos.sysmgt.nim.client filesset:

```
# ls1pp -f bos.sysmgt.nim.client | grep config_rpcsec
    /usr/samples/nim/krb5/config_rpcsec_server
    /usr/samples/nim/krb5/config_rpcsec_client
```

NIM is capable of configuring NFSv4, but due to the variation of Kerberos configurations, you are required to manage KDC configuration and services outside of NIM. Users not familiar with Kerberos can setup a basic Kerberos server on the NIM master.

Prerequisites

In order to use NFSv4 RPCSEC_GSS Kerberos the following requisites must be met on the NIM master:

- ▶ The cryptographic library clic.rte must be installed
- ▶ The clicext kernel extension must be loaded
- ▶ AIX V6.1 or later installed
- ▶ Installed Kerberos (krb5.lic, krb5.client, krb5.server, modcrypt.base)

On any NIM client who should be able to use a RPCSEC_GSS Kerberos NFS export, the following requisites must be fulfilled:

- ▶ The cryptographic library clic.rte must be installed
- ▶ The clicext kernel extension must be loaded
- ▶ AIX V6.1 or later installed
- ▶ Installed Kerberos (krb5.lic, krb5.client, modcrypt.base)

The NIM master and all his clients must be time synchronized. Use the AIX timed or a NTP setup where available.

Hint: Use the following command to check if the clicext module is loaded into the kernel: `genkex | grep clic`. If its not loaded, use this command:
`/usr/lib/drivers/crypto/clicext`

Kerberos server on NIM master

Before you run the Kerberos server setup script, have first a look at it. You can customize it to meet your demands. The password at least should be changed. The script will execute the following tasks:

1. Creates a system user, default is nim
2. Creates principals for admin and system user
3. Creates nfs host key for server
4. Creates realm-to-domain mapping
5. Creates a tar image of krb5 files for use by KDC slim clients
6. Cleans up exports list
7. Recycles the nfs services
8. Re-exports nfs file systems and directories

```
# /usr/samples/nim/krb5/config_rpcsec_server
```

While running `/usr/samples/nim/krb5/config_rpcsec_server` you will be prompted for passwords in this order:

1. New system user (standard AIX user registry)
2. Kerberos database master password.
3. Principal "admin/admin@REALM1.IBM.COM" as defined in the script Variable `PASSWD`.
4. Principal "admin/admin@REALM1.IBM.COM" as defined in the script Variable `PASSWD`.

Kerberos client on NIM clients

Before you run the Kerberos client setup script, have a look at it. You can customize it to meet your demands. The script will execute the following tasks:

1. Creates a system user, default is `nim`. The user must match an existing user principal on the KDC server.
2. **tftp** the slim image from the master
3. Enables the user principal using the `kinit` command
4. Recycles the NFS services

```
# /usr/samples/nim/krb5/config_rpcsec_client
```

While running `/usr/samples/nim/krb5/config_rpcsec_client` you will be prompted for the password of `<nimuser>@REALM1.IBM.COM`.

Example installation with a Kerberos NFSv4 export

Check if on the NIM client you have a valid Kerberos TGT. In Example 9-2, we need to request one:

Example 9-2 Obtaining a Kerberos TGT on the NIM client

```
$ /usr/krb5/bin/klist
Unable to get cache name (ticket cache:
/var/krb5/security/creds/krb5cc_10).
    Status 0x96c73ac3 - No credentials cache found.
```

```
$ /usr/krb5/bin/kinit
```

```
$ /usr/krb5/bin/klist
Ticket cache: FILE:/var/krb5/security/creds/krb5cc_10
Default principal: nim@REALM1.IBM.COM
```

```
Valid starting    Expires          Service principal
```

09/28/07 16:10:26 09/29/07 16:09:53
 krbtgt/REALM1.IBM.COM@REALM1.IBM.COM

On the NIM master we have an existing lpp_source and installp_bundle for OpenSSL. Example 9-3 shows the following:

- ▶ Change the resource attributes to vers=4 and sec=krb5
- ▶ Allocate the NIM resources to the client lpar02
- ▶ Perform the push installation

Example 9-3 Performing the NIM install steps

```
# nim -o change -a nfs_sec=krb5 -a nfs_vers=4 OPENSSL
# nim -o change -a nfs_sec=krb5 -a nfs_vers=4 openssl_bnd

# nim -o allocate -a lpp_source=OPENSSL lpar02
# nim -o allocate -a installp_bundle=openssl_bnd lpar02
# nim -o cust lpar02
```

During the installation the /etc/exports file on the NIM master looks as follows:

```
# cat /etc/exports
/export/lpp_source/openssl -vers=4,sec=krb5,ro
/export/installp_bundle -vers=4,sec=krb5,ro
```

Hint: The /usr/lpp/bos.sysmgt/nim/README file contains the latest information about the current NIM release.

9.2.4 Considerations

The following are considerations pertaining to the NIM NFSv4 support

- ▶ The NFS server calls the rpc.mountd daemon to get the access rights of each client, therefore the rpc.mountd daemon must be running on the server even if the server only exports file systems with NFSv4.
- ▶ NIM supports the pseudo file system concept of NFSv4. For NFSv4 resource exports the NIM client will do a single mount of the servers nfsroot to /tmp/_.nim_mounts._/<hostname>.<security flavor>. All data will be accessed under this path.
- ▶ You cannot change the nfsroot directory on the NIM NFS server. The NFS default of / (root) must be used for accessing NIM resources.

- ▶ The NFSv4 protocol allows no file to file mounts. The NIM server therefore mounts single files (such as scripts and installp_bundles) different with NFSv4 than with NFSv3. When using NFSv4 the files are accessed through the pseudo file system mount.



National language support

AIX Version 6.1 continues to extend the number of nations and regions supported under its national language support. In this chapter, details on the following locales (provided alphabetically) and facilities are provided:

- ▶ 10.1, “Azerbaijani locale support” on page 368
- ▶ 10.2, “Euro symbol support” on page 374
- ▶ 10.3, “Maltese locale support” on page 377
- ▶ 10.4, “Urdu India and Urdu Pakistan locale support” on page 383
- ▶ 10.5, “Welsh locale support” on page 389
- ▶ 10.6, “Olson time zone support” on page 395
- ▶ 10.7, “Unicode 5.0 support” on page 399
- ▶ 10.8, “International Components for Unicode” on page 400

Note: The information included in this section under the discussion of locale support is provided to assist people who are not familiar with the regions better understand the changes made. The accuracy of this information was verified at the time of writing from published information located from education and government Web sites. The colors used for the flags, and their aspect ratios, we carefully chosen to the best of our ability and may appear different depending on the method used to view this publication.

10.1 Azerbaijani locale support



Figure 10-1 The flag of the Republic of Azerbaijan

There are approximately 30 million native Azerbaijani speakers in the Republic of Azerbaijan, Iran and other countries in Central of Asia. Azerbaijani, also called Azeri Turkish or Azerbaijani Turkish, is the official language of the Republic of Azerbaijan which is located in southwestern Asia, bordering the Caspian Sea and bounded by the countries of Armenia, Georgia, Iran, Russia, and Turkey. This Turkic language historically relates to Turkish, Persian and Arabic languages. The official Azerbaijani uses Latin alphabets, but it also uses Arabic or Cyrillic scripts in some area. Azerbaijani-Latin is written from left to right and top to bottom in the same fashion as English.

AIX V6.1 provides full Universal-Coded Character Set (UCS) enablement for the Azerbaijani-Latin language of the Republic of Azerbaijan through a dedicated UCS Transformation Format UTF-8 locale. The UCS language and territory designation for Azerbaijan is given by AZ_AZ.

The Azerbaijani-Latin script consists of 33 pairs of Latin letters as depicted in Figure 10-2 below:

A	Ə	B	C	Ç	D	E	F	G	Ğ	H	X	I	İ	J	K	Q	L	M	N	O	Ö	P	R	S	Ş	T	U	V	Ü	Y	Z
a	ə	b	c	ç	d	e	f	g	ğ	h	x	i	ı	j	k	q	l	m	n	o	ö	p	r	s	ş	t	u	v	ü	y	z

Figure 10-2 Azerbaijani letters

10.1.1 Packaging and installation

The Azerbaijani locale definitions and the underlying support are delivered through the following, separately installable filesets that are grouped and distributed in two entities:

- ▶ bos.loc.utf.AZ_AZ fileset
- ▶ X11.loc.AZ_AZ package comprised of the filesets
 - X11.loc.AZ_AZ.base.lib
 - X11.loc.AZ_AZ.base.rte
 - X11.loc.AZ_AZ.Dt.rte

The scope of the files in the bos.loc.utf.AZ_AZ fileset is limited to provide the locale support for the AIX base operating system whereas the X11.loc.AZ_AZ package will add the locale support for the X11 environment.

X11.loc.AZ_AZ.Dt.rte specifically addresses the requirement of the Common Desktop Environment. Several filesets will be automatically installed if the installation process cannot find them on the system:

- ▶ bos.loc.com.utf (co-requisite to bos.loc.utf.AZ_AZ)
- ▶ X11.fnt.ucs.ttf (co-requisite to X11.loc.AZ_AZ.base.rte)

To verify the complete list of dependencies you can look at the messages displayed during the installation of the Azerbaijani locale or you examine the output of the relevant `lspp -p` command after you installed the filesets on your system.

As shown in Figure 10-3 on page 370, during the setup of an AIX installation system administrators can set the primary language environment to use the predefined triple of Azerbaijani-Latin as cultural convention, English (United States) as language, and Azerbaijani-Latin as keyboard.

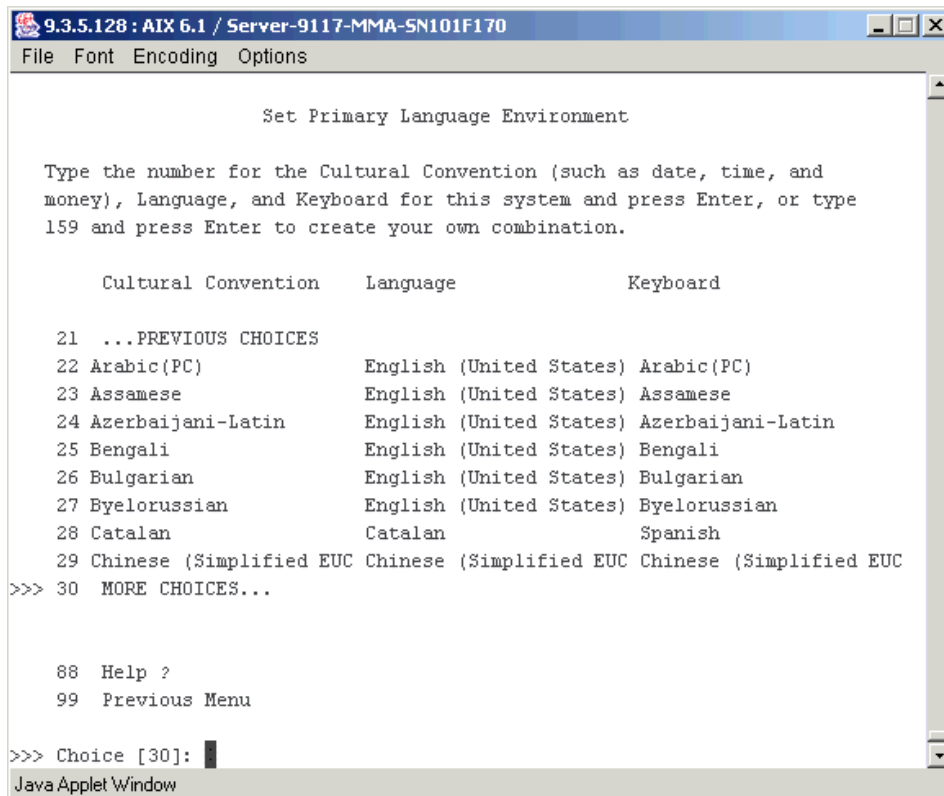

Figure 10-3 Set Primary Language Environment® installation menu

After the completion of the base operating system installation you can use the **lslpp** command to determine which base system locales have been installed as consequence of the predefined Azerbaijani-Latin primary language environment settings chosen:

```
# lslpp -l bos.loc*
Fileset                                Level  State   Description
-----
Path: /usr/lib/objrepos
bos.loc.com.utf                        6.1.0.0 COMMITTED Common Locale Support - UTF-8
bos.loc.utf.EN_US                      6.1.0.0 COMMITTED Base System Locale UTF Code
                                         Set - U. S. English
bos.loc.utf.AZ_AZ                      6.1.0.0 COMMITTED Base System Locale UTF Code
                                         Set - Azerbaijani-Latin
```

Note that in addition to the UTF-8 Azerbaijani-Latin locale the UTF-8 US English locale has been installed too.

Depending on the graphics related characteristics of a given system you will also encounter additional filesets in support for Common Desktop Environment and AIXwindows (X11) locales:

```
# lspp -l X11.loc.*
  Fileset                Level  State      Description
-----
Path: /usr/lib/objrepos
  X11.loc.AZ_AZ.Dt.rte    6.1.0.0  COMMITTED  CDE Locale Configuration -
  Azerbaijani-Latin
  X11.loc.AZ_AZ.base.lib  6.1.0.0  COMMITTED  AIXwindows Client Locale
  Config - Azerbaijani-Latin
  X11.loc.AZ_AZ.base.rte  6.1.0.0  COMMITTED  AIXwindows Locale
  Configuration -
  Azerbaijani-Latin
... omitted lines ...

Path: /etc/objrepos
  X11.loc.AZ_AZ.Dt.rte    6.1.0.0  COMMITTED  CDE Locale Configuration -
  Azerbaijani-Latin
```

In case you like to add Azerbaijani-Latin national language support to an existing AIX installation you can use the SMIT **m1ang** locale fast path to access the Change/Show Primary Language Environment or the Add Additional Language Environments SMIT menus.

10.1.2 Locale definitions, keyboard definition and input methods

A locale is made up of the language, territory, and code set combination used to identify a set of language conventions. The language conventions are grouped in six categories to include information about collation, case conversion, character classification, the language of message catalogs, date-and-time representation, the monetary symbol, and numeric representation. National language support uses the environment variables LC_COLLATE, LC_CTYPE, LC_MESSAGES, LC_MONETARY, LC_NUMERIC, and LC_TIME to define the current values for their respective categories and to influence the selection of locales.

As mentioned previously, the language and territory designation for Azerbaijani national language support is AZ_AZ and after you configured your environment to use Azerbaijani national language support you will get the following output by the **locale** command:

```
# locale
LANG=AZ_AZ
LC_COLLATE="AZ_AZ"
LC_CTYPE="AZ_AZ"
LC_MONETARY="AZ_AZ"
```

```
LC_NUMERIC="AZ_AZ"
LC_TIME="AZ_AZ"
LC_MESSAGES="AZ_AZ"
LC_ALL=
```

For example, you can now use the **date** command to verify that the AIX system is actually using the cultural conventions of Azerbaijan for date-and-time representation:

```
# date
2007 Sentyabr 27 16:21:13 CDT
```

The output translates to the following in US English locale:

```
# date
Thu Sep 27 16:21:13 CDT 2007
```

No AIX message translations are available for Azerbaijani at the time of writing. However, the directory `/usr/lib/nls/msg/AZ_AZ` will be created during the installation of the Azerbaijani language environment so that applications that desire Azerbaijani translation may provide it. The AIX operating system will use the `NLSPATH` environment variable to locate any message catalog to be referenced:

```
# echo $NLSPATH
/usr/lib/nls/msg/%L/%N:/usr/lib/nls/msg/%L/%N.cat
```

The Azerbaijani keyboard layout in AIX V6.1 is based on the IBM registered keyboard number 490 (KBD490). In support for the Azerbaijani-Latin locale KBD490 exhibits a two-layer keyboard layout: group 1 (US English layer) and group 2 (Azerbaijani-Latin layer). The Alt+Left Shift key combination defines the modifier to switch to the group 2 (Azerbaijani-Latin) layer and the Alt+Right Shift key combination will address the group 1 (English 101 key) layer.

AIX supports two different types of keyboards: low function terminal (LFT) and X server keyboards.

The LFT environment is not capable of handling multi-byte code sets such as UTF-8 nor complex text (layout oriented) languages. Therefore, the LFT key map for `AZ_AZ.lftkeymap` in the `/usr/lib/nls/loc` directory is implemented as symbolic link to `C.lftkeymap`:

```
# cd /usr/lib/nls/loc
# ls -l AZ_AZ.lftkeymap | cut -c59-
AZ_AZ.lftkeymap -> /usr/lib/nls/loc/C.lftkeymap
```

Keyboard mapping within AIX X11 environment is based on the locally attached keyboard. When you start a local X session (through the `xinit` command, the X

Display Manager, or the Common Desktop Environment), startup scripts will call the `/usr/bin/X11/xmodmap` command and load the keyboard map for the keyboard language determined by the `/usr/bin/X11/querykbd` command. The `xmodmap` command defines the mapping of the Shift, Lock, and Alt-Graphic (AltGr) keys. The related `xmodmap` command expressions for the Azerbaijani keyboard are defined in the `/usr/lpp/X11/defaults/xmodmap/AZ_AZ/keyboard` file.

Note: The `xmodmap` command is not called if the display is remote. Keyboard mapping is performed on the local display. Consult your local configuration guides for assistance configuring remote keyboard mapping.

The key events are mapped to a string in the input method mapping `imkeymap` files.

Single Latin Layer keyboards will be mapped as seen in the `xmodmap` mapping file. For keyboards with additional language groups, the key events for the Right Alt + Right Shift key combination loads the national keyboard layer. So while the key mapped by `xmodmap` is letter a (`XK_a`) the strings returned by the input method will vary based on the modifier.

For example, the local Azerbaijan (Azeri) keyboard has the following mapping:

```
keycode 36 = bracketright braceright
```

KEYSYM: `XK_bracketright` is passed to the input method. This key event is mapped as follows, in the Azerbaijan locale input method:

```
BASE:      ']'
SHIFT:    XK_braceright
CAPSLOCK: XK_bracketright
SHIFT_CAPSLOCK  XK_braceright
```

If the user is in the national layer (using Right Alt + Right Shift) the following strings are mapped to this keysym:

```
Azeri Base  XK_gbreve
Azeri Shift XK_Gbreve
Azeri CapsLock  XK_Gbreve
Azeri Shift CapsLock  XK_gbreve
Control  '\x1d'
Alt     U (undefined)
```

AIX V6.1 provides the standard UNIVERSAL input method as well as the traditional single-byte input method through the `AZ_AZ.im` and the `AZ_AZ.UTF-8.im` file respectively. Both input methods are related by the use of the same UNIVERSAL input method configuration file `UNIVERSAL.imcfg`. The

input method files, the related configuration files and the input method keymap definition files are located in the /usr/lib/nls/loc directory:

```
# ch /usr/lib/nls/loc
# ls -l AZ_AZ*im* | cut -c59-
AZ_AZ.im -> /usr/lib/nls/loc/UNIVERSAL.im
AZ_AZ.im_64 -> /usr/lib/nls/loc/UNIVERSAL.im_64
AZ_AZ.imcfg -> /usr/lib/nls/loc/UNIVERSAL.imcfg
AZ_AZ.imcompose
AZ_AZ.imkeymap -> /usr/lib/nls/loc/AZ_AZ.UTF-8.imkeymap
AZ_AZ.UTF-8.im -> /usr/lib/nls/loc/sbcs.im
AZ_AZ.UTF-8.im_64 -> /usr/lib/nls/loc/sbcs.im_64
AZ_AZ.UTF-8.imcfg -> /usr/lib/nls/loc/UNIVERSAL.imcfg
AZ_AZ.UTF-8.imcompose -> /usr/lib/nls/loc/AZ_AZ.imcompose
AZ_AZ.UTF-8.imkeymap
```

10.2 Euro symbol support



Figure 10-4 The flag of the European Union

By the end of 2002 the national currencies were effectively withdrawn and replaced by the Euro currency in 12 European Union countries: Austria, Belgium, Finland, France, Germany, Greece, Ireland, Italy, Luxembourg, the Netherlands, Portugal, Slovenia, and Spain.

In May 2004 ten new countries joined the European Union: Cyprus, Czech Republic, Estonia, Hungary, Latvia, Lithuania, Malta, Poland, Slovakia, and Slovenia. In January 2007 an additional two countries acceded to the European Union: Bulgaria, and Romania.

Slovenia was the first of the new member states to adopt the Euro currency. In this country the new currency entered circulation on January 1, 2007. The

remaining countries will eventually introduce the Euro currency as soon as they meet the Maastricht convergence criteria among other necessary conditions.

For more information about the Euro currency consult the official web page of the European Monetary Union:

<http://ec.europa.eu/euro>

AIX V6.1 provides two new euro enabled locales and euro enablement to twelve existing locales mainly in support for the accession of the new member states to the European Union in 2004 and 2007, and their recent or impending adoption of Euro as their national currency.

The two newly added euro enabled locales support the Maltese/Malta and Welsh/United Kingdom language and territory combinations. The new locales are covered in detail by the dedicated sections 10.3, “Maltese locale support” on page 377 and 10.5, “Welsh locale support” on page 389.

The following Table 10-1 gives an overview of the new and enhanced AIX V6.1 locales in support of the Euro currency:

Table 10-1 New and enhanced AIX V6.1 locales in support of the Euro currency

Language / Territory	UTF-8 locale	ISO locale	IBM-92x locale	Currency
Czech / Czech Republic	CS_CZ.UTF-8	cs_CZ.ISO8859-2	N/A	preeuro
Danish / Denmark	DA_DK.UTF-8	da_DK.ISO8859-15 ^a	N/A	preeuro
Estonian / Estonia	ET_EE.UTF-8	et_EE.ISO8859-4	Et_EE.IBM-922	preeuro
Hungarian / Hungary	HU_HU.UTF-8	hu_HU.ISO8859-2	N/A	preeuro
Latvian / Latvia	LV_LV.UTF-8	lv_LV.ISO8859-4	Lv_LV.IBM-921	preeuro
Lithuanian / Lithuania	LT_LT.UTF-8	lt_LT.iso8859-4	Lt_LT.IBM-921	preeuro
Maltese / Malta	MT_MT.UTF-8	N/A	N/A	euro
Polish / Poland	PL_PL.UTF-8	pl_PL.ISO8859-2	N/A	preeuro
Slovak / Slovakia	SK_SK.UTF-8	sk_SK.ISO8859-2	N/A	preeuro
Slovenian / Slovenia	SL_SI.UTF-8	sl_SI.ISO8859-2	N/A	euro
Swedish / Sweden	SV_SE.UTF-8	sv_SE.ISO8859-15 ^a	N/A	preeuro
Welsh / United Kingdom	CY_GB.UTF-8	N/A	N/A	preeuro
Bulgarian / Bulgaria	BG_BG.UTF-8	bg_BG.ISO8859-5	N/A	preeuro
Romanian / Romania	RO_RO.UTF-8	ro_RO.ISO8859-2	N/A	preeuro

a. Graphical Euro symbol supported.

All euro enabled locales are designed to effectively support a dual currency environment as induced by isochronous euro and traditional currency requirements. To that extend AIX provides the @euro and the @preeuro modifiers to the LC_MONETARY category. The modifiers are appended as suffix to the language and territory designation of a given locale and, as indicated by the keywords, the @euro modifier activates the Euro currency symbol and the related formatting rules whereas the @preeuro modifier does the same for the traditional currency. As shown by the last column of Table 10-1 on page 375 the Maltese and the Slovenian locale are the only locales which use the @euro modifier by default. Every other locale listed defaults to the traditional currency symbol and formatting rules. Note that for the given locales all the IBM locales (IBM-921, IBM-922) and all the ISO8859 code sets excluding the ISO8859-15 are not able to support the graphical Euro symbol.

IBM is following the recommendation of the European Commission regarding placement of the Euro symbol on keyboards. The Commission recommends to place the Euro symbol at the position AltGr+e on all European keyboards, except on those keyboard layouts where the key combination AltGr+e is already assigned to produce a different character. In those cases, a combination of AltGr+4 or AltGr+5 will be assigned as a first choice alternative. The existing logical keyboard layout registrations for the countries listed in Table 10-2 have been updated to facilitate entering the Euro sign. For the new Maltese and Welsh language environments the keyboard registrations have been added. You also can see some cases for Euro symbol placement, such as Shift+3 and AltGr+u key combinations, where the first choice alternatives ultimately were not available.

Table 10-2 New and modified AIX keyboards for Euro symbol support

Language / Territory	AIX keyboard name	Keyboard ID	Euro placement
Czech / Czech Republic	CS_CZ	243	AltGr+e
Danish / Denmark	DA_DK	159	AltGr+5
Estonian / Estonia	ET_EE	454	AltGr+e
Hungarian / Hungary	HU_HU	208	AltGr+u
Latvian / Latvia	LV_LV	455	AltGr+4
Lithuanian / Lithuania	LT_LT	456	AltGr+e
Maltese / Malta	MT_MT	491	Shift+3
Polish / Poland	PL_PL	214	AltGr+u

Language / Territory	AIX keyboard name	Keyboard ID	Euro placement
Slovak / Slovakia	SK_SK	245	AltGr+e
Slovenian / Slovenia	SL_SI	234	AltGr+e
Swedish / Sweden	SV_SE	153	AltGr+e
Welsh / United Kingdom	CY_GB	166 and 166W ^a	AltGr+4
Bulgarian / Bulgaria	BG_BG	442	AltGr+e
Romanian / Romania	RO_RO	446	AltGr+e

a. Keyboard ID 166W provides a supplementary layout to be used with keyboard ID 166 to support Welsh and Cornish

10.3 Maltese locale support

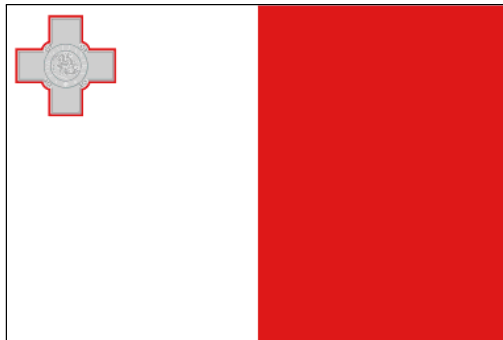

Figure 10-5 The flag of the Republic of Malta

The Republic of Malta is located in the Mediterranean Sea around 60 miles south-west off the Sicily, Italy and about 180 miles north-west of the Tunisian coast. The Maltese archipelago primarily consists of three islands: Malta, Gozo and Camino and at the time of writing the combined population is estimated to be around 400.000 people. The Republic of Malta joined the European Union in 2004 and plans to adopt the euro currency by January 1st, 2008.

As declared by the Constitution of Malta the national language of Malta is Maltese but the English language is recognized as an official languages too. Maltese is only Semitic Language written in the Latin alphabet.

AIX V6.1 provides full Universal-Coded Character Set (UCS) enablement for the Maltese language through a dedicated UCS Transformation Format UTF-8 locale. The UCS language and territory designation for Maltese is given by MT_MT.

The Maltese script consists of 30 pairs of Latin letters as depicted in Figure 10-2 on page 368 below:

A	B	Ċ	D	E	F	Ġ	G	Għ	H	Ħ	I	Ie	J	K	L	M	N	O	P	Q	R	S	T	U	V	W	X	Ż	Z
a	b	ċ	d	e	f	ġ	g	għ	h	ħ	i	ie	j	k	l	m	n	o	p	q	r	s	t	u	v	w	x	ż	z

Figure 10-6 Maltese letters

10.3.1 Packaging and installation

The Maltese locale definitions and the underlying support are delivered through the following, separately installable filesets that are grouped and distributed in two entities:

- ▶ bos.loc.utf.MT_MT fileset
- ▶ X11.loc.MT_MT package comprised of the filesets
 - X11.loc.MT_MT.base.lib
 - X11.loc.MT_MT.base.rte
 - X11.loc.MT_MT.Dt.rte

The scope of the files in the bos.loc.utf.MT_MT fileset is limited to provide the locale support for the AIX base operating system whereas the X11.loc.MT_MT package will add the locale support for the X11 environment.

X11.loc.MT_MT.Dt.rte specifically addresses the requirement of the Common Desktop Environment. Several filesets will be automatically installed if the installation process cannot find them on the system:

- ▶ bos.loc.com.utf (co-requisite to bos.loc.utf.MT_MT)
- ▶ X11.fnt.ucs.ttf (co-requisite to X11.loc.MT_MT.base.rte)

To verify the complete list of dependencies you can look at the messages displayed during the installation of the Maltese locale or you examine the output of the relevant `ls1pp -p` command after you installed the filesets on your system.

As shown in Figure 10-3 on page 370, during the setup of an AIX installation system administrators can set the primary language environment to use the predefined triple of Maltese as cultural convention, English (United States) as language, and Maltese as keyboard.

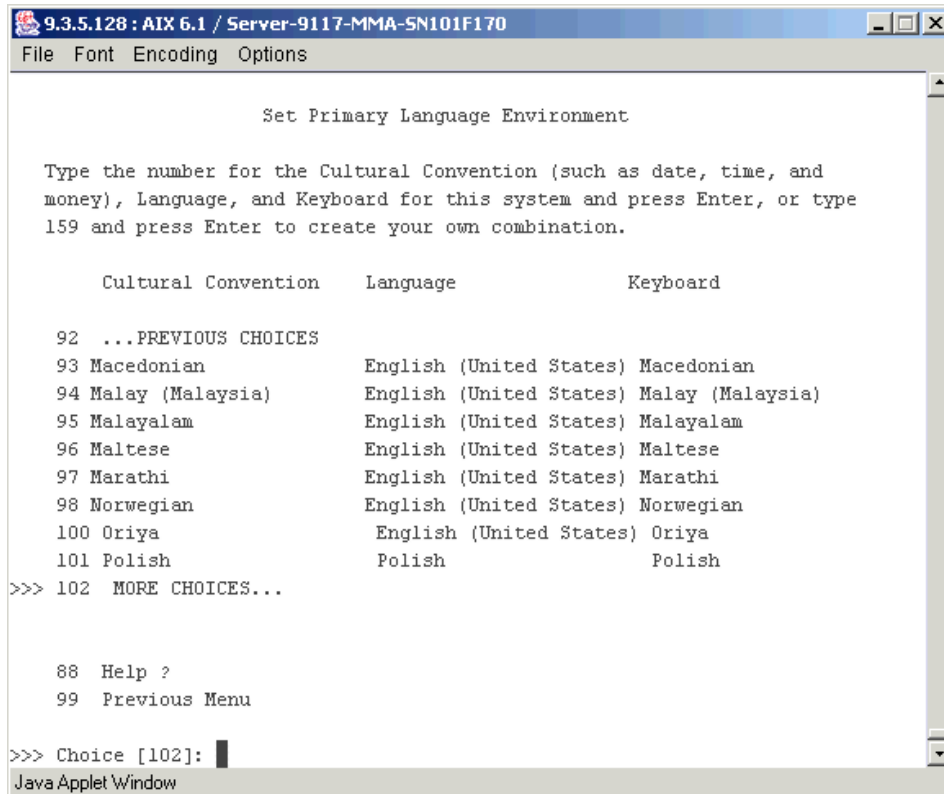

Figure 10-7 Set Primary Language Environment installation menu

After the completion of the base operating system installation you can use the **lslpp** command to determine which base system locales have been installed as consequence of the predefined Maltese primary language environment settings chosen:

```
# lslpp -l bos.loc*
Fileset                                Level  State   Description
-----
Path: /usr/lib/objrepos
bos.loc.com.utf                        6.1.0.0 COMMITTED Common Locale Support - UTF-8
bos.loc.utf.EN_US                      6.1.0.0 COMMITTED Base System Locale UTF Code
                                         Set - U. S. English
bos.loc.utf.MT_MT                      6.1.0.0 COMMITTED Base System Locale UTF Code
                                         Set - Maltese
```

Note that in addition to the UTF-8 Maltese locale the UTF-8 US English locale has been installed too.

Depending on the graphics related characteristics of a given system you will also encounter additional filesets in support for Common Desktop Environment and AIXwindows (X11) locales:

```
# lspp -l X11.loc.*
  Fileset                Level  State    Description
-----
Path: /usr/lib/objrepos
  X11.loc.MT_MT.Dt.rte    6.1.0.0  COMMITTED  CDE Locale Configuration -
                                Maltese
  X11.loc.MT_MT.base.lib  6.1.0.0  COMMITTED  AIXwindows Client Locale
                                Config - Maltese
  X11.loc.MT_MT.base.rte  6.1.0.0  COMMITTED  AIXwindows Locale
                                Configuration - Maltese
... omitted lines ...

Path: /etc/objrepos
  X11.loc.MT_MT.Dt.rte    6.1.0.0  COMMITTED  CDE Locale Configuration -
                                Maltese
```

In case you like to add Maltese national language support to an existing AIX installation you can use the SMIT **mlang** locale fast path to access the Change/Show Primary Language Environment or the Add Additional Language Environments SMIT menus.

10.3.2 Locale definitions, keyboard definition and input methods

A locale is made up of the language, territory, and code set combination used to identify a set of language conventions. The language conventions are grouped in six categories to include information about collation, case conversion, character classification, the language of message catalogs, date-and-time representation, the monetary symbol, and numeric representation. National language support uses the environment variables LC_COLLATE, LC_CTYPE, LC_MESSAGES, LC_MONETARY, LC_NUMERIC, and LC_TIME to define the current values for their respective categories and to influence the selection of locales.

As mentioned previously, the language and territory designation for Maltese national language support is MT_MT and after you configured your environment to use Maltese national language support you will get the following output by the **locale** command:

```
# locale
LANG=MT_MT
LC_COLLATE="MT_MT"
LC_CTYPE="MT_MT"
LC_MONETARY="MT_MT"
LC_NUMERIC="MT_MT"
```

```
LC_TIME="MT_MT"
LC_MESSAGES="MT_MT"
LC_ALL=
```

For example, you can now use the **date** command to verify that the AIX system is actually using the cultural conventions of Malta for date-and-time representation:

```
# date
26 taà Settembru 2007 14:59:55 CDT
```

The output translates to the following in US English locale:

```
# date
Wed Sep 26 14:59:55 CDT 2007
```

No AIX message translations are available for Maltese at the time of writing. However, the directory `/usr/lib/nls/msg/MT_MT` will be created during the installation of the Maltese language environment so that applications that desire Maltese translation may provide it. The AIX operating system will use the `NLSPATH` environment variable to locate any message catalog to be referenced:

```
# echo $NLSPATH
/usr/lib/nls/msg/%L/%N:/usr/lib/nls/msg/%L/%N.cat
```

Any UTF-8-based locale installed on an AIX system will provide support for the Euro symbol. As Malta is among the countries which have to actively use the Euro, the Maltese locale will deliver the input methods and the keyboard maps required to enter the Euro symbol through the keyboard. An additional `LC_MONETARY` locale is available to enable the Euro currency formatting. This locale is identified by the suffix `@euro`. As such, the alternate Euro currency format is invoked when `LC_MONETARY=MT_MT@euro` is specified through the locale environment variables, or with the `setlocale` subroutine. The **locale** command output bellow shows the required environment variable settings in support for Euro currency formatting:

```
# locale
LANG=MT_MT
LC_COLLATE="MT_MT"
LC_CTYPE="MT_MT"
LC_MONETARY=MT_MT@euro
LC_NUMERIC="MT_MT"
LC_TIME="MT_MT"
LC_MESSAGES="MT_MT"
LC_ALL=
```

To allow dual currency support, the Maltese locales also provides the `MT_MT@preeuro` locale for the `LC_MONETARY` category. The

MT_MT@preeuro locale is linked to the default locale for traditional national currency formatting requirements of users and applications.

The Maltese keyboard layout in AIX V6.1 is based on the IBM registered keyboard number 491 (KBD491). In support for the Maltese locale KBD491 exhibits a two-layer keyboard layout: group 1 (state 0), and group 2 (state 32). The Alt+Left Shift key combination defines the modifier to switch to the group 2 layer and the Alt+Right Shift key combination will address the group 1 layer.

AIX supports two different types of keyboards: low function terminal (LFT) and X server keyboards.

The LFT environment is not capable of handling multi-byte code sets such as UTF-8 nor complex text (layout oriented) languages. Therefore, the LFT key map for MT_MT.lftkeymap in the /usr/lib/nls/loc directory is implemented as symbolic link to C.lftkeymap:

```
# cd /usr/lib/nls/loc
# ls -l MT_MT.lftkeymap | cut -c59-
MT_MT.lftkeymap -> /usr/lib/nls/loc/C.lftkeymap
```

Keyboard mapping within AIX X11 environment is based on the locally attached keyboard. When you start a local X session (through the `xinit` command, the X Display Manager, or the Common Desktop Environment), startup scripts will call the `/usr/bin/X11/xmodmap` command and load the keyboard map for the keyboard language determined by the `/usr/bin/X11/querykbd` command. The `xmodmap` command defines the mapping of the Shift, Lock, and Alt-Graphic (AltGr) keys. The related `xmodmap` command expressions for the Maltese keyboard are defined in the `/usr/lpp/X11/defaults/xmodmap/MT_MT/keyboard` file.

Note: The `xmodmap` command is not called if the display is remote. Keyboard mapping is performed on the local display. Consult your local configuration guides for assistance configuring remote keyboard mapping.

AIX V6.1 provides the standard UNIVERSAL input method as well as the traditional single-byte input method through the MT_MT.im and the MT_MT.UTF-8.im file respectively. Both input methods are related by the use of the same UNIVERSAL input method configuration file UNIVERSAL.imcfg. The input method files, the related configuration files and the input method keymap definition files are located in the /usr/lib/nls/loc directory:

```
# ls -l MT_MT*im* | cut -c59-
MT_MT.UTF-8.im -> /usr/lib/nls/loc/sbcs.im
MT_MT.UTF-8.im_64 -> /usr/lib/nls/loc/sbcs.im_64
MT_MT.UTF-8.imcfg -> /usr/lib/nls/loc/UNIVERSAL.imcfg
MT_MT.UTF-8.imkeymap
```

```

MT_MT.im -> /usr/lib/nls/loc/UNIVERSAL.im
MT_MT.im_64 -> /usr/lib/nls/loc/UNIVERSAL.im_64
MT_MT.imcfg -> /usr/lib/nls/loc/UNIVERSAL.imcfg
MT_MT.imkeymap -> /usr/lib/nls/loc/MT_MT.UTF-8.imkeymap

```

10.4 Urdu India and Urdu Pakistan locale support

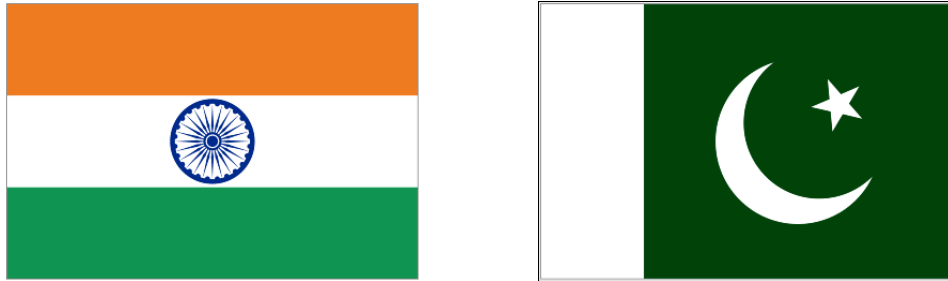

Figure 10-8 Republic of India and Islamic Republic of Pakistan flags

Urdu is spoken in Pakistan (as national language), northern India, Afghanistan and other countries in eastern Asia area. Nearly 100,000,000 people in 20 countries are using Urdu as a first or second language. Urdu is using Urdu script (Persian-Arabic script) to write from right to left and top to bottom

AIX V6.1 provides full Universal-Coded Character Set (UCS) enablement for the Urdu language through dedicated UCS Transformation Format UTF-8 locales for Urdu India and Urdu Pakistan. The UCS language and territory designation for Urdu national language support is given by UR_IN and UR_PK for Urdu India and Urdu Pakistan respectively.

For the remainder of this section the substitution characters XX will represent both territory designation: IN (India) and PK (Pakistan).

The image shows a rectangular box containing two lines of Urdu text. The first line contains the characters: ٹ، ڈ، ص، ط، ی، ک، ا، ہ، ل، ن، ر، و، م، ع، غ، ش، س، ے، ف، ق. The second line contains the characters: ٹ، ڈ، ذ، ض، ظ، ی، گ، آ، ء، ہ، ن، ژ، ز، ئ، ؤ، ئے، ح، ج، ب، ت، پ.

Figure 10-9 Some examples of Urdu characters

10.4.1 Packaging and installation

The Urdu India and Urdu Pakistan locale definitions and the underlying support are delivered through separately installable filesets that are grouped and distributed in two entities for each territory.

The Urdu India national language support filesets are:

- ▶ bos.loc.utf.UR_IN fileset
- ▶ X11.loc.UR_IN package comprised of the filesets
 - X11.loc.UR_IN.base.lib
 - X11.loc.UR_IN.base.rte
 - X11.loc.UR_IN.Dt.rte

The Urdu Pakistan national language support filesets are:

- ▶ bos.loc.utf.UR_PK fileset
- ▶ X11.loc.UR_PK package comprised of the filesets
 - X11.loc.UR_PK.base.lib
 - X11.loc.UR_PK.base.rte
 - X11.loc.UR_PK.Dt.rte

The scope of the files in the bos.loc.utf.UR_XX fileset is limited to provide the locale support for the AIX base operating system whereas the X11.loc.UR_XX package will add the locale support for the X11 environment. X11.loc.UR_XX.Dt.rte specifically addresses the requirements of the Common Desktop Environment.

Several filesets will be automatically installed if the installation process cannot find them on the system:

- ▶ bos.loc.com.utf (co-requisite to bos.loc.utf.UR_XX)
Common Locale Support - UTF-8
- ▶ bos.loc.com.bidi (co-requisite to bos.loc.utf.UR_XX)
Common Locale Support - Bidirectional Languages
- ▶ X11.fnt.ucs.ttf (co-requisite to X11.loc.UR_XX.base.rte)
AIXwindows Unicode TrueType Fonts
- ▶ X11.fnt.ucs.ttf_extb (co-requisite to X11.loc.UR_XX.base.rte)
AIXwindows Unicode TrueType Fonts - Extension B

To verify the complete list of dependencies you can look at the messages displayed during the installation of the Urdu locales or you examine the output of the relevant **ls1pp -p** command after you installed the filesets on your system.

System administrators can choose to install an AIX system with a primary language environment setup for Urdu India or Urdu Pakistan. For the Indian territory the environment is determined by the predefined triple of Urdu India as cultural convention, English (United States) as language, and Urdu India as keyboard. For the Pakistani territory the environment is determined by the predefined triple of Urdu Pakistan as cultural convention, English (United States) as language, and Urdu Pakistan as keyboard.

After the completion of the base operating system installation you can use the **lslpp** command to verify which base system locales have been installed as consequence of the predefined Urdu primary language environment settings chosen. The **lslpp** command listings provided in the following paragraphs are characteristic for a system which has been initially setup to support Urdu Pakistan. By replacing PK with IN in the fileset names the same listings would apply to the Urdu India environment.

```
# lslpp -l bos.loc*
  Filesset                Level  State   Description
-----
Path: /usr/lib/objrepos
  bos.loc.com.bidi        6.1.0.0  COMMITTED  Common Locale Support -
                               Bidirectional Languages
  bos.loc.com.utf         6.1.0.0  COMMITTED  Common Locale Support - UTF-8
  bos.loc.utf.EN_US       6.1.0.0  COMMITTED  Base System Locale UTF Code
                               Set - U. S. English
  bos.loc.utf.UR_PK       6.1.0.0  COMMITTED  Base System Locale UTF Code
                               Set - Urdu (Pakistan)
```

Note that in addition to the UTF-8 Urdu locale the UTF-8 US English locale has been installed too.

Depending on the graphics related characteristics of a given system you will also encounter additional filesets in support for Common Desktop Environment and AIXwindows (X11) locales:

```
# lslpp -l X11.loc.*
  Filesset                Level  State   Description
-----
Path: /usr/lib/objrepos
  X11.loc.UR_PK.Dt.rte    6.1.0.0  COMMITTED  CDE Locale Configuration -
                               Maltese
  X11.loc.UR_PK.base.lib  6.1.0.0  COMMITTED  AIXwindows Client Locale
                               Config - Maltese
  X11.loc.UR_PK.base.rte  6.1.0.0  COMMITTED  AIXwindows Locale
                               Configuration - Maltese
... omitted lines ...

Path: /etc/objrepos
```

X11.loc.UR_PK.Dt.rte 6.1.0.0 COMMITTED CDE Locale Configuration -
Maltese

In case you want to add Urdu national language support to an existing AIX installation you can use the SMIT `m1ang` locale fast path to access the Change/Show Primary Language Environment or the Add Additional Language Environments SMIT menus.

```

Change/Show Cultural Convention, Language, or Keyboard

Type or select values in entry fields.
Press Enter AFTER making all desired changes.

Primary CULTURAL convention          [Entry Fields]
Primary LANGUAGE translation          UTF-8      Urdu <India> [UR_IN]      +
Primary KEYBOARD                      UTF-8      Urdu <India> [UR_IN]      +
INPUT device/directory for software  UTF-8      Urdu Keyboard <ID 492> [UR_IN]  +
EXTEND file systems if space needed? [/dev/cd0]
yes                                   yes                                   +

F1=Help      F2=Refresh  F3=Cancel  F4=List
F5=Reset     F6=Command  F7=Edit    F8=Image
F9=Shell     F10=Exit   Enter=Do

```

Figure 10-10 SMIT menu to add Urdu national language support for India

AIX V6.1 also provides code set conversion tables for the none-Unicode Urdu codesets IBM-868, IBM-918, and IBM-1006 to support conversion of none-Unicode Urdu characters to/from Unicode. Note that Urdu conversions between none-Unicode and Unicode characters are not a one-one mapping.

10.4.2 Locale definitions, keyboard definition and input methods

A locale is made up of the language, territory, and code set combination used to identify a set of language conventions. The language conventions are grouped in six categories to include information about collation, case conversion, character classification, the language of message catalogs, date-and-time representation, the monetary symbol, and numeric representation. National language support uses the environment variables `LC_COLLATE`, `LC_CTYPE`, `LC_MESSAGES`, `LC_MONETARY`, `LC_NUMERIC`, and `LC_TIME` to define the current values for their respective categories and to influence the selection of locales.

As mentioned previously, the language designation for Urdu locale support is UR and the territory designation is given by IN and PK for India and Pakistan respectively.

After you configured your environment to use Urdu India national language support you will get the following output by the `locale` command:

```
# locale
LANG=UR_IN
LC_COLLATE="UR_IN"
LC_CTYPE="UR_IN"
LC_MONETARY="UR_IN"
LC_NUMERIC="UR_IN"
LC_TIME="UR_IN"
LC_MESSAGES="UR_IN"
LC_ALL=
```

After you configured your environment to use Urdu Pakistan national language support you will get the following output by the `locale` command:

```
# locale
LANG=UR_PK
LC_COLLATE="UR_PK"
LC_CTYPE="UR_PK"
LC_MONETARY="UR_PK"
LC_NUMERIC="UR_PK"
LC_TIME="UR_PK"
LC_MESSAGES="UR_PK"
LC_ALL=
```

No AIX message translations are available for Urdu at the time of writing. However, depending on the territory designation either the directory `/usr/lib/nls/msg/UR_IN` (India) or the directory `usr/lib/nls/msg/UR_PK` (Pakistan) will be created during the installation of the Urdu language environment so that applications that desire Urdu translation may provide it. The AIX operating system will use the `NLSPATH` environment variable to locate any message catalog to be referenced:

```
# echo $NLSPATH
/usr/lib/nls/msg/%L/%N:/usr/lib/nls/msg/%L/%N.cat
```

The Urdu keyboard layout in AIX V6.1 is based on the same IBM registered keyboard number 492 (KBD492) for both territories, India and Pakistan. In support for the Urdu locale KBD492 exhibits a two-layer keyboard layout: Latin (state 0), and Urdu (state 32). The `Alt+Left Shift` key combination defines the modifier to switch to the Latin layer and the `Alt+Right Shift` key combination will

address the Urdu layer. The Latin layer of the keyboard is equivalent to US English 101 key keyboard.

AIX supports two different types of keyboards: low function terminal (LFT) and X server keyboards.

The LFT environment is not capable of handling multi-byte code sets such as UTF-8 nor complex text (layout oriented) languages. Therefore, the LFT key map for UR_XX.lftkeymap in the /usr/lib/nls/loc directory is implemented as symbolic link to C.lftkeymap. Use the relevant `ls -l` command in the /usr/lib/nls/loc directory to verify the references:

```
# cd /usr/lib/nls/loc
# ls -l UR_IN.lftkeymap | cut -c59-
UR_IN.lftkeymap -> /usr/lib/nls/loc/C.lftkeymap

# ls -l UR_PK.lftkeymap | cut -c59-
UR_PK.lftkeymap -> /usr/lib/nls/loc/C.lftkeymap
```

Keyboard mapping within AIX X11 environment is based on the locally attached keyboard. When you start a local X session (through the `xinit` command, the X Display Manager, or the Common Desktop Environment), startup scripts will call the `/usr/bin/X11/xmodmap` command and load the keyboard map for the keyboard language determined by the `/usr/bin/X11/querykbd` command. The `xmodmap` command defines the mapping of the Shift, Lock, and Alt-Graphic (AltGr) keys. The related `xmodmap` command expressions for the Urdu keyboard are defined in the `/usr/lpp/X11/defaults/xmodmap/UR_XX/keyboard` file, where XX represents IN or PK.

Note: The `xmodmap` command is not called if the display is remote. Keyboard mapping is performed on the local display. Consult your local configuration guides for assistance configuring remote keyboard mapping.

AIX V6.1 provides the standard UNIVERSAL input method as well as the traditional single-byte input method through the UR_XX.im and the UR_XX.UTF-8.im file respectively. Both input methods are related by the use of the same UNIVERSAL input method configuration file UNIVERSAL.imcfg. The input method files, the related configuration files and the input method keymap definition files are located in the /usr/lib/nls/loc directory.

```
# ls -l UR_PK*im* | cut -c55-
UR_PK.im -> /usr/lib/nls/loc/UNIVERSAL.im
UR_PK.im_64 -> /usr/lib/nls/loc/UNIVERSAL.im_64
UR_PK.imcfg -> /usr/lib/nls/loc/UNIVERSAL.imcfg
UR_PK.imcompose -> /usr/lib/nls/loc/BIM.imcompose
UR_PK.imkeymap -> /usr/lib/nls/loc/UR_PK.UTF-8.imkeymap
```

```
UR_PK.UTF-8.im -> /usr/lib/nls/loc/sbcs.im
UR_PK.UTF-8.im_64 -> /usr/lib/nls/loc/sbcs.im_64
UR_PK.UTF-8.imcfg -> /usr/lib/nls/loc/UNIVERSAL.imcfg
UR_PK.UTF-8.imcompose -> /usr/lib/nls/loc/BIM.imcompose
UR_PK.UTF-8.imkeymap
```

By replacing PK with IN in the fileset names the previous listing would apply to the Urdu India environment.

10.5 Welsh locale support



Figure 10-11 The Welsh flag

England, Northern Ireland, Scotland and Wales are the four constituent countries of the United Kingdom. At the time of writing, the population of Wales is estimated to be around 3 million and the official languages are English and Welsh. In Welsh the language itself is named Cymraeg and it is a member of the Brythonic branch of Celtic language. According to the most recent language survey more than 20% of the population is able to speak Welsh. The percentage of speakers in Wales continues to grow, since the introduction of the Welsh Language Act of 1993 and Government of Wales Act of 1998 of requiring English and Welsh languages to be treated on a basis of equality.

Additional information about the Welsh language can be found at the official web site of the Welsh Language Board:

<http://www.bwrdd-yr-iaith.org.uk>

AIX V6.1 provides full Universal-Coded Character Set (UCS) enablement for the Welsh (Cymraeg) language through a dedicated UCS Transformation Format UTF-8 locale. The UCS language and territory designation for Welsh is given by CY_GB.

Figure 10-12 provides a complete list of Welsh letters and their related names.

Letter	Name	Letter	Name
A a	â	Lll	ell
B b	bî	M m	êm
C c	êc	N n	en
Ch ch	êch	O o	ô
D d	dî	P p	pî
Dd dd	êdd	Ph ph	ffî
E e	ê	R r	êr
F f	êf	Rh rh	rhî, rhô
Ff ff	êff	S s	ês
G g	êg	T t	tî
Ng ng	êng	Th th	êth
H h	âets, hâ	U u	û
I i	î	W w	ŵ
j	jay	Y y	ÿ
L l	êl		

Figure 10-12 Welsh alphabet

The English and Welsh locales for the UK are very similar. The date and time formats, calendar and time zone information is the same yet there are some differences to be noted:

- ▶ The Welsh alphabet has 29 letters whereas the English alphabet has 26.
 - The Welsh locale does not include: k, q, v, x, z.
 - The Welsh alphabet includes digraph ch, dd, ff, ng, ll, ph, rh, th.
 - For a text string, the character count will likely be different to the letter count.
- ▶ The Welsh alphabet has a different sort order than the English alphabet and the digraph characters further influence collation.
- ▶ The Welsh keyboard has the same layout as the UK keyboard, however there are alternate key sequences required to input the diacritic marks.

Welsh vowels can be modified by diacritic marks (for example. â, ô).

10.5.1 Packaging and installation

The Welsh locale definitions and the underlying support are delivered through the following, separately installable filesets that are grouped and distributed in two entities:

- ▶ bos.loc.utf.CY_GB fileset
- ▶ X11.loc.CY_GB package comprised of the filesets
 - X11.loc.CY_GB.base.lib
 - X11.loc.CY_GB.base.rte
 - X11.loc.CY_GB.Dt.rte

The scope of the files in the bos.loc.utf.CY_GB fileset is limited to provide the locale support for the AIX base operating system whereas the X11.loc.CY_GB package will add the locale support for the X11 environment.

X11.loc.CY_GB.Dt.rte specifically addresses the requirement of the Common Desktop Environment. Several filesets will be automatically installed if the installation process cannot find them on the system:

- ▶ bos.loc.com.utf (corequisite to bos.loc.utf.CY_GB)
- ▶ X11.fnt.ucs.ttf (corequisite to X11.loc.CY_GB.base.rte)

To verify the complete list of dependencies you can look at the messages displayed during the installation of the Welsh locale or you examine the output of the relevant **ls1pp -p** command after you installed the filesets on your system.

As shown in Figure 10-3 on page 370, during the setup of an AIX installation system administrators can set the primary language environment to use the predefined triple of Welsh as cultural convention, English (United States) as language, and Welsh as keyboard.

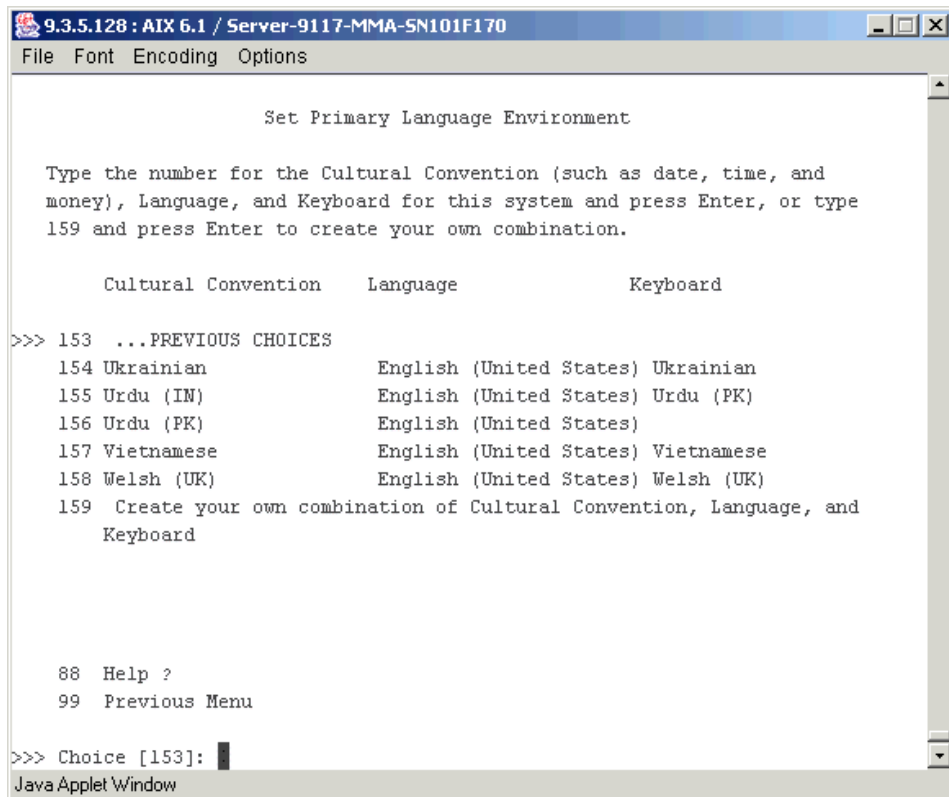

Figure 10-13 Set Primary Language Environment installation menu

After the completion of the base operating system installation you can use the **lslpp** command to determine which base system locales have been installed as consequence of the predefined Welsh primary language environment settings chosen:

```
# lslpp -l bos.loc*
Fileset                                Level  State   Description
-----
Path: /usr/lib/objrepos
bos.loc.com.utf                        6.1.0.0 COMMITTED Common Locale Support - UTF-8
bos.loc.utf.EN_US                      6.1.0.0 COMMITTED Base System Locale UTF Code
                                         Set - U. S. English
bos.loc.utf.CY_GB                      6.1.0.0 COMMITTED Base System Locale UTF Code
                                         Set - Welsh
```

Note that in addition to the UTF-8 Welsh locale the UTF-8 US English locale has been installed too.

Depending on the graphics related characteristics of a given system you will also encounter additional filesets in support for Common Desktop Environment and AIXwindows (X11) locales:

```
# lspp -l X11.loc.*
  Fileset                Level  State   Description
-----
Path: /usr/lib/objrepos

  X11.loc.CY_GB.Dt.rte    6.1.0.0  COMMITTED  CDE Locale Configuration -
                                Welsh
  X11.loc.CY_GB.base.lib  6.1.0.0  COMMITTED  AIXwindows Client Locale
                                Config - Welsh
  X11.loc.CY_GB.base.rte  6.1.0.0  COMMITTED  AIXwindows Locale
                                Configuration - Welsh

... omitted lines ...

Path: /etc/objrepos
  X11.loc.CY_GB.Dt.rte    6.1.0.0  COMMITTED  CDE Locale Configuration -
                                Maltese
```

In case you like to add Welsh national language support to an existing AIX installation you can use the SMIT **m1ang** locale fast path to access the Change/Show Primary Language Environment or the Add Additional Language Environments SMIT menus.

10.5.2 Locale definitions, keyboard definition and input methods

A locale is made up of the language, territory, and code set combination used to identify a set of language conventions. The language conventions are grouped in six categories to include information about collation, case conversion, character classification, the language of message catalogs, date-and-time representation, the monetary symbol, and numeric representation. National language support uses the environment variables LC_COLLATE, LC_CTYPE, LC_MESSAGES, LC_MONETARY, LC_NUMERIC, and LC_TIME to define the current values for their respective categories and to influence the selection of locales.

As mentioned previously, the language and territory designation for Welsh national language support is CY_GB and after you configured your environment to use Welsh national language support you will get the following output by the **locale** command:

```
# locale
LANG=CY_GB
LC_COLLATE="CY_GB"
LC_CTYPE="CY_GB"
```

```
LC_MONETARY="CY_GB"
LC_NUMERIC="CY_GB"
LC_TIME="CY_GB"
LC_MESSAGES="CY_GB"
LC_ALL=
```

Any UTF-8-based locale installed on an AIX system will provide support for the Euro symbol. As Wales is among the countries which may have to actively use the Euro, the Welsh locale will deliver the input methods and the keyboard maps required to enter the Euro symbol through the keyboard. An additional LC_MONETARY locale is available to enable the Euro currency formatting. This locale is identified by the suffix @euro. As such, the alternate Euro currency format is invoked when LC_MONETARY=CY_GB@euro is specified through the locale environment variables, or with the setlocale subroutine. The **locale** command output below shows the required environment variable settings in support for Euro currency formatting:

```
# locale
LANG=CY_GB
LC_COLLATE="CY_GB"
LC_CTYPE="CY_GB"
LC_MONETARY=CY_GB@euro
LC_NUMERIC="CY_GB"
LC_TIME="CY_GB"
LC_MESSAGES="CY_GB"
LC_ALL=
```

To allow dual currency support, the Welsh locales also provides the CY_GB@preeuro locale for the LC_MONETARY category. The CY_GB@preeuro locale is linked to the default locale for traditional national currency formatting requirements of users and applications.

AIX V6.1 introduces the new keyboard ID 166W in support for the Welsh national language environment. As the keyboard ID indicates, the layout of the Welsh 166W keyboard is implemented as additional layer to the United Kingdom English (en_GB ISO-08859-1) keyboard 166. The AltGr and Shift+AltGr modifiers are used to enter the Welsh layer of the 166W keyboard layout. For a complete description of the Welsh keyboard layout, refer to the Welsh Keyboard Translation Table in Chapter 2, "Keyboard Translation Tables" of the *AIX Version 6.1 Keyboard Technical Reference*, SC23-6614.

AIX supports two different types of keyboards: low function terminal (LFT) and X server keyboards.

The LFT environment is not capable of handling multi-byte code sets such as UTF-8 nor complex text (layout oriented) languages. Therefore, the LFT key map

for `CY_GB.lftkeymap` in the `/usr/lib/nls/loc` directory is implemented as symbolic link to `C.lftkeymap`:

```
# cd /usr/lib/nls/loc
# ls -l CY_GB.lftkeymap | cut -c59-
CY_GB.lftkeymap -> /usr/lib/nls/loc/C.lftkeymap
```

Keyboard mapping within AIX X11 environment is based on the locally attached keyboard. When you start a local X session (through the `xinit` command, the X Display Manager, or the Common Desktop Environment), startup scripts will call the `/usr/bin/X11/xmodmap` command and load the keyboard map for the keyboard language determined by the `/usr/bin/X11/querykbd` command. The `xmodmap` command defines the mapping of the Shift, Lock, and Alt-Graphic (AltGr) keys. The related `xmodmap` command expressions for the Welsh keyboard are defined in the `/usr/lpp/X11/defaults/xmodmap/CY_GB/keyboard` file.

Note: The `xmodmap` command is not called if the display is remote. Keyboard mapping is performed on the local display. Consult your local configuration guides for assistance configuring remote keyboard mapping.

AIX V6.1 provides the standard UNIVERSAL input method as well as the traditional single-byte input method through the `CY_GB.im` and the `CY_GB.UTF-8.im` file respectively. Both input methods are related by the use of the same UNIVERSAL input method configuration file `UNIVERSAL.imcfg`. The input method files, the related configuration files and the input method keymap definition files are located in the `/usr/lib/nls/loc` directory:

```
# ls -l CY_GB*im* | cut -c59-
CY_GB.UTF-8.im -> /usr/lib/nls/loc/sbcs.im
CY_GB.UTF-8.im_64 -> /usr/lib/nls/loc/sbcs.im_64
CY_GB.UTF-8.imcfg -> /usr/lib/nls/loc/UNIVERSAL.imcfg
CY_GB.UTF-8.imkeymap
CY_GB.im -> /usr/lib/nls/loc/UNIVERSAL.im
CY_GB.im_64 -> /usr/lib/nls/loc/UNIVERSAL.im_64
CY_GB.imcfg -> /usr/lib/nls/loc/UNIVERSAL.imcfg
CY_GB.imkeymap -> /usr/lib/nls/loc/CY_GB.UTF-8.imkeymap
```

10.6 Olson time zone support

“The public-domain time zone database contains code and data that represent the history of local time for many representative locations around the globe. It is updated periodically to reflect changes made by political

bodies to time zone boundaries, UTC offsets, and daylight-saving rules. This database (often called tz or zoneinfo) is used by several implementations, [...].

Each location in the database represents a national region where all clocks keeping local time have agreed since 1970. Locations are identified by continent or ocean and then by the name of the location, which is typically the largest city within the region. For example, America/New_York represents most of the US eastern time zone; America/Phoenix represents most of Arizona, which uses mountain time without daylight saving time (DST); America/Detroit represents most of Michigan, which uses eastern time but with different DST rules in 1975; and other entries represent smaller regions like Starke County, Indiana, which switched from central to eastern time in 1991 and switched back in 2006.”

The presiding paragraphs are citations from *Source for Time Zone and Daylight Saving Time Data* found at the following URL:

<http://www.twinsun.com/tz/tz-link.htm>.

The public-domain time zone database is also widely known as Olson time zone database and is the architecture on which the International Components for Unicode (ICU) and the Common Locale Data Repository (CLDR) time zone support relies.

In previous AIX releases the method by which the operating system supports time zone conventions is based on the POSIX time zone specification. In addition to this industry standard approach AIX V6.1 recognizes and processes the Olson time zone naming conventions to facilitate support for a comprehensive set of time zones.

This enhancement leverages the uniform time zone naming convention of the Olson database to offer an intuitive set of time zone values which can be assigned to the TZ time zone environment variable.

To implement the Olson time zone feature AIX V6.1 utilizes the ICU library APIs which are shipped in the ICU4C.rte fileset and installed by default on any AIX V6.1 system. For more detailed information about ICU4C support in AIX V6.1 refer to 10.8, “International Components for Unicode” on page 400.

Note: Time zone definitions conforming to the POSIX specification are still supported and recognized by AIX. AIX checks the TZ environment variable to determine if the environment variable follows the POSIX specification rules. If the TZ environment variable does not match the POSIX convention AIX calls the ICU library to get the Olson time zone translation.

The use of the Olson database for time zone support within AIX provides significant advantages over the traditional POSIX rules. One of the biggest advantages is that Olson database maintains a historical record of what the time zone rules were at given points in time, so that if the rules change in a particular location, dates and times can be interpreted correctly both in the present and past. A good example of this is the US state of Indiana, which just began using daylight savings time in the year 2006. Under the POSIX implementation, Indiana would have to set its time zone value to EST5EDT, which would format current dates correctly using daylight savings time, but would also format times from previous years as though they were on daylight savings time, which is incorrect. Use of the ICU API set for time zones also allows for localized display names for time zones. For example, Central Daylight Savings Time would have an abbreviation of CDT for all locales under a POSIX implementation, but under ICU/Olson, it displays properly as HAC (Heure Avancée du Centre) in a French locale.

As in previous AIX releases system administrators can rely on the Systems Management Interface Tool (SMIT) to configure the time zone by using system defined values for the TZ environment variable. To accomplish this task enter the main SMIT menu and select **System Environments** → **Change / Show Date and Time** to access the **Change Time Zone Using System Defined Values** menu. Alternatively the SMIT fast path `chtz_date` will directly open the **Change / Show Date and Time** menu. Selecting the **Change Time Zone Using System Defined Values** option will prompt SMIT to open the **Select COUNTRY or REGION** menu as shown in Figure 10-14 on page 398:

```

Change / Show Date and Time
-----+-----
Mo+  |                               |
      |           Select COUNTRY or REGION           |
      | Move cursor to desired item and press Enter. |
      | [TOP]                                       |
      | JS - United States                         |
      | AD - Andorra                             |
      | AE - United Arab Emirates                |
      | AF - Afghanistan                        |
      | AG - Antigua and Barbuda                 |
      | AI - Anguilla                           |
      | AL - Albania                             |
      | AM - Armenia                             |
      | AN - Netherlands Antilles                |
      | AO - Angola                             |
      | AQ - Antarctica                         |
      | AR - Argentina                          |
      | AS - American Samoa                     |
      | AT - Austria                            |
      | AU - Australia                          |
      | AW - Aruba                              |
      | AX - Aland Islands                      |
      | AZ - Azerbaijan                         |
      | BA - Bosnia and Herzegovina            |
      | BB - Barbados                          |
      | [MORE...224]                             |
      | F1=Help           F2=Refresh           F3=Cancel |
      | F8=Image          F10=Exit            Enter=Do  |
      | F11=/=Find        n=Find Next        |
F9+  |-----+-----

```

Figure 10-14 SMIT menu to select country or region for Olson time zone

SMIT uses the undocumented `/usr/lib/nls/1stz -C` command to produce the list of available countries and regions. Note that undocumented commands and features are not officially supported for customer use, are not covered by the AIX compatibility statement, and may be subject to change without notice.

After you have chosen the country or region in the **Select COUNTRY or REGION** menu a new selection menu will list all available time zones for the country or region in question. Figure 10-15 on page 399 shows the time zone options which are available for the United States. The selected value of the first column will be passed by SMIT to the `chtz` command which in turn will change the TZ variable value in the `/etc/environment` system level configuration file. As with previous AIX releases, time zone configuration changes always require a system reboot to become effective.

```

Change / Show Date and Time
-----
No+-----+-----+-----+-----+
      TIME ZONE name
      Move cursor to desired item and press Enter. Use arrow keys to scroll.
      [TOP]
      America/New_York      <GMT-05:00/GMT-04:00> Eastern Standar
      America/Chicago      <GMT-06:00/GMT-05:00> Central Standar
      America/Denver       <GMT-07:00/GMT-06:00> Mountain Standa
      America/Los_Angeles  <GMT-08:00/GMT-07:00> Pacific Standar
      America/Anchorage    <GMT-09:00/GMT-08:00> Alaska Standard
      Pacific/Honolulu     <GMT-10:00> Hawaii Standard
      #
      #
      America/Adak         <GMT-10:00/GMT-09:00>
      America/Anchorage    <GMT-09:00/GMT-08:00> Alaska Standard
      America/Atka         <GMT-10:00/GMT-09:00>
      America/Boise        <GMT-07:00/GMT-06:00>
      America/Chicago      <GMT-06:00/GMT-05:00> Central Standar
      America/Denver       <GMT-07:00/GMT-06:00> Mountain Standa
      America/Detroit      <GMT-05:00/GMT-04:00>
      America/Fort_Wayne   <GMT-05:00/GMT-04:00>
      America/Indiana/Indianapolis <GMT-05:00/GMT-04:00>
      America/Indiana/Knox <GMT-06:00/GMT-05:00>
      America/Indiana/Marengo <GMT-05:00/GMT-04:00>
      America/Indiana/Petersburg <GMT-06:00/GMT-05:00>
      America/Indiana/Vevay <GMT-05:00/GMT-04:00>
      [MORE...17]
      F1=Help          F2=Refresh          F3=Cancel
      F8=Image         F10=Exit            Enter=Do
      F11=/=Find       n=Find Next
      F9+-----+-----+-----+-----+

```

Figure 10-15 SMIT menu to select the time zone for a given country or region

SMIT uses the internal `/usr/lib/nls/1stz -c` command to produce the list of available time zones for a given country and region. The `-c` flag expects a country or region designation as input parameter. The `/usr/lib/nls/1stz -C` command provides a list of available input parameters. As such the listing in Figure 10-15 is produced by the `/usr/lib/nls/1stz -c US` command. The `/usr/lib/nls/1stz` command used without any flag provides a full list of all Olson time zones available on AIX. Note, undocumented commands and features are not officially supported for customer use, are not covered by the AIX compatibility statement, and may be subject to change without notice.

10.7 Unicode 5.0 support

As part of the continuously ongoing effort to adhere to the most recent industry standards AIX V6.1 provides the necessary enhancements to the existing Unicode locales in order to bring them up to compliance with the latest version of the Unicode standard, which is version 5.0 as published by the Unicode Consortium. The Unicode is a standard of a character coding system for supporting the worldwide interchange, processing, and display of the written

texts of the diverse languages used throughout the world. Unicode 5.0 defines standardized character positions for over 99,000 glyphs in total.

For in-depth information about Unicode 5.0 visit the official Unicode home page:

<http://www.unicode.org>

10.8 International Components for Unicode

International Components for Unicode (ICU) provides as one of the premier software internationalization packages robust features that allow programmers to effectively work with Unicode data and create globalized applications.

More detailed information about ICU can be found at the official International Components for Unicode home page:

<http://www.icu-project.org>

AIX V6.1 includes the ICU4C 3.6 cross-platform Unicode based globalization libraries for C/C++ as part of the base operating system. AIX V6.1 provides both 32 and 64 bit versions of the ICU libraries which are tightly integrated into the operating system through system level links in /usr/bin and /usr/lib and system level include files in /usr/include. AIX delivers the ICU4C support through the following filesets:

ICU4C.rte	Libraries and commands
ICU4C.adt	Header files
ICU4C.man.en_US	Manual pages

Because the Olson time zone support in AIX relies on the ICU4C services the ICU4C.rte fileset is listed in the BOS.autoi file in /usr/sys/inst.data/sys_bundles directory to ensure that the ICU4C support will always be installed by default. 10.6, “Olson time zone support” on page 395 provides additional information about the new AIX V6.1 time zone feature. The ICU4C.rte file set is also listed in the bundle definition file for Common Criteria evaluated systems, CC_EVAL.BOS.autoi, and in the bundle definition file for Secure by Default installations, Sbd.BOS.autoi. Consequently the ICU4C services will also be available in environments with special, highly demanding security requirements.

The shared libraries are installed in the /usr/lib directory and the relevant symbolic links are added to /usr/icu4c/lib:

```
# cd /usr/icu4c/lib
l# ls -l | cut -c59-
libicudata.a -> /usr/lib/libicudata.a
```



```
libicui18n.a -> /usr/lib/libicui18n.a
libicuio.a -> /usr/lib/libicuio.a
libicule.a -> /usr/lib/libicule.a
libiculx.a -> /usr/lib/libiculx.a
libicutu.a -> /usr/lib/libicutu.a
libicuuc.a -> /usr/lib/libicuuc.a
```

The header files are installed in the `/usr/icu4c/include/unicode` or `/usr/icu4c/include/layout` directory and symbolic links are setup in the `/usr/include` which makes the header files accessible along the normal compilation path:

```
# cd /usr/include
# ls -l layout | cut -c59-
layout -> /usr/icu4c/include/layout
# ls -l unicode | cut -c59-
unicode -> /usr/icu4c/include/unicode
```

The commands are installed in the `/usr/icu4c/bin` directory and the relevant symbolic links are setup in `/usr/bin` accordingly:

```
# ls -l /usr/bin/ | grep icu4c | cut -c59-
derb -> /usr/icu4c/bin/derb
genbrk -> /usr/icu4c/bin/genbrk
genccode -> /usr/icu4c/bin/genccode
gencmn -> /usr/icu4c/bin/gencmn
gencnval -> /usr/icu4c/bin/gencnval
genctd -> /usr/icu4c/bin/genctd
genrb -> /usr/icu4c/bin/genrb
gensprep -> /usr/icu4c/bin/gensprep
genuca -> /usr/icu4c/bin/genuca
icu-config -> /usr/icu4c/bin/icu-config
icupkg -> /usr/icu4c/bin/icupkg
icuswap -> /usr/icu4c/bin/icuswap
makeconv -> /usr/icu4c/bin/makeconv
pkgdata -> /usr/icu4c/bin/pkgdata
```



Hardware and graphics support

This chapter discusses the new hardware support and graphic topics new in AIX Version 6.1, arranged in the following topics:

- ▶ 11.1, “Hardware support” on page 404
- ▶ 11.2, “Universal Font Scaling Technology Version 5” on page 404
- ▶ 11.3, “X Window System Version 11 Release 7.1” on page 405
- ▶ 11.4, “32 TB physical memory support” on page 407
- ▶ 11.5, “Withdrawal of the 32-bit kernel” on page 407

11.1 Hardware support

AIX V6.1 exclusively supports 64-bit Common Hardware Reference Platform (CHRP) machines with selected processors:

- ▶ PowerPC® 970
- ▶ POWER4
- ▶ POWER5
- ▶ POWER6

To see if you have a supported machine, log into the machine as the root user, and run the following command:

```
# prtconf | grep 'Processor Type'
```

AIX V6.1 withdraws the following processor architectures:

- ▶ RS64
- ▶ POWER3
- ▶ 604

Certain machines may require a firmware update in order to run AIX V6.1. For the latest requisites refer to the AIX V6.1 Release Notes:

<http://publib14.boulder.ibm.com/infocenter/systems/aix/topic/com.ibm.aix.resources/61relnotes.htm>

AIX V6.1 requires 512 MB of physical memory and a minimum of 2.2 GB of physical disk space for a default base AIX installation (with CDE).

11.2 Universal Font Scaling Technology Version 5

The AIX V6.1 base operating system delivers the Universal Font Scaling Technology (UFST) version 5.0.1 font rasterizer licensed from the Monotype Imaging company (<http://www.monotypeimaging.com>). The AIX V6.1 UFST version 5.0.1 support is an update to the UTFS version 4.6 as used by AIX 5L V5.3 and provides an advanced TrueType font rasterizer to the X Windows environment on AIX.

The AIX V6.1 UFST version 5.0.1 functionality is embedded in the AIX X Server (AIXWindows) runtime environment which is delivered through the X11.base.rte fileset, and in the AIX X font server code which is shipped in the X11.fnt.fontServer fileset.

“The UFST subsystem reads, interprets and processes hinted font data to rapidly generate scaled character bitmaps, graymaps or grid-aligned outlines. The fast, compact solution offers a lower ROM cost than alternative font rendering systems and is the only one that uses industry-standard trademarked font names and font metrics, ...”

The preceding paragraph is a citation from *UFST – Universal Font Scaling Technology* found at:

<http://www.monotypeimaging.com/ProductsServices/ufts.aspx>

11.3 X Window System Version 11 Release 7.1

AIX V6.1 contains X Windows libraries, headers and some applications that have been updated to X Window System Version 11 Release 7.1 (X11R7.1). For detailed release specific information about the AIXWindows runtime environment on AIX V6.1 refer to the /usr/lib/X11/README file which is delivered through the X11.base.rte fileset.

11.3.1 X11R5 / X11R6.1 / X11R7.1 compatibility issues

The libraries shipped by IBM with X11R7.1 are backward-compatible and the client applications, which access these libraries, will work as on previous releases of AIX, except as noted below.

As on earlier releases of AIX, IBM also ships X11R3, X11R4, X11R5 and X11R6 compatibility installation options for maximum customer flexibility. In this way, client applications experience no problems with compatibility.

There are a few notable differences due to the X11R7.1 updates:

- ▶ Most of the new X11 R7.1 header files now only contain full ANSI function prototypes. This may cause the compiler to find problems that were not apparent before.
- ▶ The file /usr/lpp/X11/defaults/xserverrc, is the script used by the `xinit`, `xdm`, and `dtlogin` commands to start the X server. This script has been modified so that the default visual will now be 24-bit TrueColor instead of 8-bit PseudoColor. Some old applications may not work in the 24-bit TrueColor visual. In this case, the old visual can be restored by commenting out the following line in the xserverrc file: `EXTENSIONS="$EXTENSIONS -cc 4"`
- ▶ An updated version of terminal emulator for the X Window System, `xterm` is included in AIX V6.1. This version of `xterm` required an update to the xterm terminfo information. The updated terminfo may cause problems with other

terminal emulators that expect the older version. Separate compatibility terminfo definitions (xterm-old and xterm-r6) are provided for use in such situation, and are accessed by setting the TERM environment variable.

The AIX V6.1 X server uses the X Consortium release 6 version of X.

11.3.2 AIX V6.1 X Client enhancements

AIX V6.1 provides new version of the X Window System terminal emulator **xterm** program and a new version of the X Display Manager **xdm** program. Both applications were updated to X11R7.1.

The new **xterm** terminal emulator requires a new terminfo file that does not work well with older versions of **xterm** in previous AIX releases. However, terminfo compatibility files are provided for use by older versions of **xterm**. You can access these by setting the TERM environment variable to xterm-r6 or xterm-old.

For example if using the Korn shell, you would run one of the following commands after you **telnet** into an AIX V6.1 system from an xterm on an AIX 5L system:

```
export TERM=xterm-r6
```

or

```
export TERM=xterm-old
```

Either of these commands will start using a terminfo file designed to support the older (X11R6) version of **xterm**. The xterm-r6 and xterm-old files in the /usr/share/lib/terminfo/x directory are identical.

The new X11R7.1 version of X Display Manger **xdm** only supports PAM authentication. For security reasons, the default **xdm** configuration disables remote login. To enable remote login the following files need to be modified:

- ▶ /usr/lib/X11/xdm/xdm-config
- ▶ /usr/lib/X11/xdm/Xaccess

11.3.3 X11R5, X11R6 and X11R7.1 coexistence

X11R7.1 is considered binary compatible to X11R5 and X11R6. Therefore, any applications that used to be running on X11R5/X11R6 should run on X11R7.1 with no problems.

For existing applications which do not run on the X11R7.1. libraries, the X11R6 Xlibs are shipped in the following filesset:

```
# lsipp -l X11.compat.lib.X11R6
Fileset                Level  State      Description
-----
Path: /usr/lib/objrepos
X11.compat.lib.X11R6   6.1.0.0 COMMITTED  AIXwindows X11R6 Compatibility
                               Libraries
```

In that fileset you will find the /usr/lpp/X11/lib/R6 directory which contains all the R6 libraries required for the system.

The X11 toolkit specifically checks to make sure you are not running against X11R5 and X11R6 in the same application, by checking the X Version at runtime. The following error is generated when you try to run an applications which is linked to Motif1.2, which was built using X11R7.1, and an libXt.a which was built using X11R6.

```
Warning: Widget class VendorShell version mismatch (recompilation needed):
        widget 11007 vs. intrinsics 11006.
```

Since the Motif1.2 (shr4.o) object shipping in libXm.a is compiled against X11R7.1, a version of Motif1.2 that was compiled against X11R6 is also shipping, so that anyone needing to use the X11R6 libraries, would also have a Motif1.2 library to run against. This X11R6 Motif 1.2 is found in /usr/lpp/X11/lib/R6/libXm.a.

11.4 32 TB physical memory support

Previous AIX versions supported physical memory up to a maximum of 16 TB. The virtual memory manager (VMM) in AIX V6.1 is enhanced to address a maximum of 32 TB RAM.

11.5 Withdrawal of the 32-bit kernel

In previous AIX versions multiple kernels were shipped. The important milestones are:

- | | |
|-------|---|
| 1993) | AIX V4.1 introduces multiprocessor kernel (unix_mp). |
| 2000) | AIX V5.0 introduces the 64-bit kernel (unix_64). |
| 2004) | The uniprocessor kernel (unix_up) has been removed in AIX V5.3. |

In AIX V5.3 and AIX V5.2 ML 5200-03 the 64-bit kernel was installed by default on POWER5 and newer systems.

2007)

The 32-bit kernel is removed in AIX V6.1

Beginning with AIX V6.1, the AIX operating system will simplify its kernel environment by providing only the 64-bit kernel. Device drivers and kernel extensions that are 32-bit only are not supported. Dual-mode (32/64-bit) kernel extensions built on AIX 5L will continue to run on AIX V6.1 but only in 64-bit mode.

AIX V6.1 is binary compatible to both 32-bit and 64-bit applications created in previous AIX 5L versions. Further information and a list of restrictions are published on the IBM AIX Binary compatibility site:

<http://www-03.ibm.com/systems/p/os/aix/compatibility/index.html>

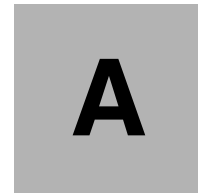

Transport-independent RPC

AIX V6.1 now formally supports the AIX base operating system related subset of the transport-independent remote procedure call (TI-RPC) routines as ported from the ONC+ 2.2 source distribution. The AIX V6.1 TI-RPC client and server interfaces are listed by API function class in Table 11-1 on page 410.

Additionally, the RPCSEC_GSS security services interface routines of the General Security Services (GSS) API are now officially supported and documented in the AIX V6.1 standard publication. The following RPCSEC_GSS subroutines are described in detail by the AIX V6.1 standard documentation:

- ▶ `rpc_gss_seccreate()`
- ▶ `rpc_gss_set_defaults()`
- ▶ `rpc_gss_max_data_length()`
- ▶ `rpc_gss_set_svc_name()`
- ▶ `rpc_gss_getcred()`
- ▶ `rpc_gss_set_callback()`
- ▶ `rpc_gss_get_principal_name()`
- ▶ `rpc_gss_svc_max_data_length()`
- ▶ `rpc_gss_get_error()`
- ▶ `rpc_gss_get_mechanisms()`
- ▶ `rpc_gss_get_mech_info()`
- ▶ `rpc_gss_get_versions()`
- ▶ `rpc_gss_is_installed()`
- ▶ `rpc_gss_mech_to_oid()`
- ▶ `rpc_gss_qop_to_num()`

Table 11-1 TI-RPC client and server interfaces

API Classification	Description	API Names	Routine classification ^a	Implemented in libnsl.a ^b	Exported in libnsl.a	Available in libcc.a ^b
RPC_SVC_REG	Routines which allow the RPC servers to register themselves with rpcbnd(), and associate the given program and version number with the dispatch function.	rpc_reg	S	✓	✓	
		svc_reg	E	✓	✓	
		svc_unreg	E	✓	✓	
		svc_auth_reg	O	✓	✓	
		xprt_register	B	✓	✓	✓
		xprt_unregister	B	✓	✓	✓
RPC_SVC_CREATE	Routines which are related to the creation of service handles.	svc_control	T	✓ ^M		
		svc_create	T	✓	✓	
		svc_destroy	T	✓ ^M		✓ ^M
		svc_dg_create	B	✓	✓	
		svc_fd_create	B	✓	✓	
		svc_raw_create	B	✓	✓	
		svc_tli_create	E	✓	✓	
		svc_tp_create	I	✓	✓	
		svc_vc_create	B	✓	✓	

API Classification	Description	API Names	Routine classification ^a	Implemented in libnsi.a ^b	Exported in libnsi.a	Available in libc.a ^b
RPC_SVC_CALLS	Routines which are associated with the server side of the RPC mechanism. Some of them are called by the server side dispatch function, while others are called when the server is initiated.	svc_dg_enablecache	O	✓	✓	
		svc_done	O	✓	✓	
		svc_exit	O	✓	✓	
		svc_fdset	O	✓ ^G	✓	✓ ^G
		svc_freeargs	O	✓ ^M		✓ ^M
		svc_getargs	O	✓ ^M		✓ ^M
		svc_getreq_common	B	✓	✓	
		svc_getreq_poll	B	✓	✓	
		svc_getreqset	B	✓	✓	✓
		svc_getrpccaller	O	✓ ^M		
		svc_max_pollfd	O	✓ ^G	✓	
		svc_pollfd	O	✓ ^G	✓	
		svc_run	O	✓	✓	✓
		svc_sendreply	O	✓	✓	✓
RPC_SVC_ERR	Routines called by the server side dispatch function if there is any error in the transaction with the client.	svcerr_auth	O	✓	✓	✓
		svcerr_decode	O	✓	✓	✓
		svcerr_noproc	O	✓	✓	✓
		svcerr_noprogram	O	✓	✓	✓
		svcerr_progvers	O	✓	✓	✓
		svcerr_systemerr	O	✓	✓	✓
		svcerr_weakauth	O	✓	✓	✓

API Classification	Description	API Names	Routine classification ^a	Implemented in libnsl.a ^b	Exported in libnsl.a	Available in libc.a ^b
RPC_CLNT_CREATE	Routines which facilitate services related to the creation of client handles.	clnt_control	T	✓ ^M		✓ ^M
		clnt_create	T	✓	✓	✓
		clnt_create_timed	T	✓	✓	
		clnt_create_vers	T	✓	✓	✓
		clnt_create_vers_timed	T	✓	✓	
		clnt_destroy	T	✓ ^M		✓ ^M
		clnt_dg_create	B	✓	✓	
		clnt_door_create	I	✓	✓	
		clnt_pcreateerror	O	✓	✓	✓
		clnt_raw_create	B	✓	✓	
		clnt_screateerror	O	✓	✓	✓
		clnt_tli_create	E	✓	✓	
		clnt_tp_create	I	✓	✓	
		clnt_tp_create_timed	I	✓	✓	
		clnt_vc_create	B	✓	✓	
rpc_createerr	O	✓ ^G	✓	✓ ^G		

API Classification	Description	API Names	Routine classification ^a	Implemented in libnsl.a ^b	Exported in libnsl.a	Available in libc.a ^b
RPC_CLNT_CALLS	Routines which handle the client side of the remote procedure calls and related error conditions.	clnt_call	T	✓ ^M		✓ ^M
		clnt_freeres	O	✓ ^M		✓ ^M
		clnt_geterr	O	✓ ^M		✓ ^M
		clnt_pereno	O	✓	✓	
		clnt_perror	O	✓	✓	
		clnt_sperrno	O	✓	✓	✓
		clnt_spererror	O	✓	✓	✓
		rpc_broadcast	S	✓	✓	
		rpc_broadcast_exp	S	✓	✓	
		rpc_call	S	✓	✓	
RPC_CLNT_AUTH	Routines normally called in support of authentication after creating of the client handle.	auth_destroy	SC	✓ ^M		✓ ^M
		authnone_create				✓
		authsys_create	SC	✓	✓	
		authsys_create_default	SC	✓	✓	

API Classification	Description	API Names	Routine classification ^a	Implemented in libnsl.a ^b	Exported in libnsl.a	Available in libc.a ^b
SECURE_RPC	Routines supporting DES encryption-based authentication.	authdes_getucred	SC	✓	✓	✓
		authdes_seccreate	SC	✓	✓	
		getnetname	SC	✓	✓	✓
		host2netname	SC	✓	✓	✓
		key_decryptsession	SC	✓	✓	✓
		key_encryptsession	SC	✓	✓	✓
		key_gendes	SC	✓	✓	✓
		key_secretkey_is_set	SC	✓	✓	
		key_setsecret	SC	✓	✓	✓
		netname2host	SC	✓	✓	✓
		netname2user	SC	✓	✓	✓
		user2netname	SC	✓	✓	✓
RPC_CONTROL	Function that allows applications to set and modify global attributes that apply to clients as well as server functions.	rpc_control	T	✓	✓	
RPCBIND	Routines that allow to make procedure calls to the RPC bind service.	rpcb_getaddr	E	✓	✓	
		rpcb_getmaps	E	✓	✓	
		rpcb_gettime	E	✓	✓	
		rpcb_rmtcall	E	✓	✓	
		rpcb_set	E	✓	✓	
		rpcb_unset	E	✓	✓	

API Classification	Description	API Names	Routine classification ^a	Implemented in libnsl.a ^b	Exported in libnsl.a	Available in libc.a ^b
GETRPCBYNAME	Functions to obtain entries for RPC services. An entry may come from any of the sources for rpc specified in the /etc/nsswitch.conf file	endrpcnt				✓
		getrpcbyname				✓
		getrpcbyname_r				✓
		getrpcbynumber				✓
		getrpcbynumber_r				✓
		getrpcnt				✓
		getrpcnt_r				✓
		setrpcnt				✓

API Classification	Description	API Names	Routine classification ^a	Implemented in libnsl.a ^b	Exported in libnsl.a	Available in libc.a ^b
RPC_SOC	Obsolete routines provided in support for backward compatibility.	authdes_create		✓		✓
		authunix_create		✓ ^M		✓
		authunix_create_default		✓ ^M		✓
		callrpc		✓		✓
		clnt_broadcast		✓		✓
		clntraw_create		✓		✓
		clnttcp_create		✓	✓	✓
		clntudp_bufcreate		✓	✓	✓
		clntudp_create		✓	✓	✓
		get_myaddress		✓		✓
		getrpcport		✓		✓
		pmap_getmaps		✓	✓	✓
		pmap_getport		✓	✓	✓
		pmap_rmtcall		✓	✓	✓
pmap_set		✓	✓	✓		

API Classification	Description	API Names	Routine classification ^a	Implemented in libnsl.a ^b	Exported in libnsl.a	Available in libc.a ^b
RPC_SOC (cont.)	Obsolete routines provided in support for backward compatibility.	pmmap_unset		✓	✓	✓
		registerrpc		✓		✓
		svc_fds		✓M		✓M
		svc_getcaller		✓M		✓M
		svc_getreq		✓		✓
		svc_register		✓	✓	✓
		svc_unregister		✓	✓	✓
		svcfcd_create		✓		✓
		svccraw_create		✓		✓
		svctcp_create		✓	✓	✓
		svccudp_bufcreate		✓		✓
		svccudp_create		✓	✓	✓
		xdr_authunix_parms		✓		✓

a. Routine classification legend:

- B Bottom-level routines (standard interface)
- E Expert-level routines (standard interface)
- I Intermediate-level routines (standard interface)
- O Other routines (standard interface)
- S Simplified interface routines
- SC Secure TI-RPC interface routines
- T Top-level routines (standard interface)

b. Implementation legend:

- M Macro
- G Global variable

**B**

Sample script for tunables

The following script can be used to output all tunables for each tuning command under a corresponding file with “xxxo_help.txt” name. A tar archive format file, gathering all these output files, named prt_tun_help.tar can be then uploaded.

```
#!/bin/ksh
#
# COMPONENT_NAME: PRT_TUN_HELP
#
# FUNCTIONS: ./prt_tun_help.sh
#
# ORIGINS: ITSO AUSTIN - SEPTEMBER 2007
#
# DOCUMENTATION EXAMPLE FOR AIX Version 6 DIFFERENCES GUIDE
#
# USE "AS IS"
#
#-----
#
# NAME:          prt_tun
#
# FUNCTION:      Print all tunables for one tuning command.
#
# PARAMETERS:   Tuning command
#
# RETURNS:      None
```

```

#
#-----#
function prt_tun {
    typeset cmd=$1
    typeset CMD=$2
    echo "Printing $1 tunable description.... $1_help.txt"
    rm ./${1}_help.txt
    AIX_LVL=`oslevel -s`
    echo "\t\t\t-----" >>./${1}_help.txt
    echo "\t\t\t $2 TUNABLES DESCRIPTION" >>./${1}_help.txt
    echo "\t\t\t AIX LEVEL : " $AIX_LVL >>./${1}_help.txt
    echo "\t\t\t-----" >>./${1}_help.txt
    user_use=
    for i in ` $1 -F -x | cut -f1 -d ',' `
    do
        if [ $i != "##Restricted" ] && [ $i != "tunables" ]; then
            echo "$user_use-----" >>./${1}_help.txt
            $1 -h $i >>./${1}_help.txt
        else
            if [ $i = "##Restricted" ] ; then
                echo "-----"
            >>./${1}_help.txt
            echo " ## RESTRICTED PARAMETERS " >>./${1}_help.txt
            echo "-----"
            >>./${1}_help.txt
            user_use="----- Restricted Tunable"
        fi
    fi
done
}
#-----#
# NAME:          main
#-----#

prt_tun vmo VMO
prt_tun ioo IOO
prt_tun no NO
prt_tun schedo SCHEDO
prt_tun nfso NFSO
prt_tun raso RASO
echo "Generating prt_tun_help.tar file...."
tar -cf./prt_tun_help.tar ./*_help.txt

```

Next is provided lines abstract of vmo_help.txt file:

VMO TUNABLES DESCRIPTION
 AIX LEVEL : 6100-00-00

 Help for tunable force_realias_lite:

Purpose:

If set to 0, a heuristic will be used, when tearing down an mmap region, to determine when to avoid locking the source mmapped segment.

Values:

Default: 0

Range: 0, 1

Type: Dynamic

Unit: boolean

Tuning:

This is a scalability tradeoff, controlled by relalias_percentage, possibly costing more compute time used. If set to 1, the source segment lock is avoided whenever possible, regardless of the value of relalias_percentage.

 Help for tunable kernel_heap_psize:

... (lines missing for clarity)

 ## RESTRICTED PARAMETERS

----- Restricted Tunable-----

Help for tunable cpu_scale_memp:

Purpose:

Determines the ratio of CPUs per-mempool. For every cpu_scale_memp CPUs, at least one mempool will be created.

Values:

Default: 8

Range: 4 - 64

Type: Bosboot

Unit:

Tuning:

Can be reduced to reduce contention on the mempools. (use in conjunction with the tuning of the maxperm parameter).

----- Restricted Tunable-----

... (lines missing for clarity)

Abbreviations and acronyms

ABI	Application Binary Interface	CDE	Common Desktop Environment
AC	Alternating Current	CEC	Central Electronics Complex
ACL	Access Control List	CHRP	Common Hardware Reference Platform
ACLs	Access control lists	CID	configuration ID
AFPA	Adaptive Fast Path Architecture	CLDR	Common Locale Data Repository
AIO	Asynchronous I/O	CLI	Command Line Interface
AIX	Advanced Interactive Executive	CLVM	Concurrent LVM
APAR	Authorized Program Analysis Report	CLIC	CryptoLight for C library
API	Application Programming Interface	CMW	Compartmented Mode Workstations
ARP	Address Resolution Protocol	CPU	Central Processing Unit
ASMI	Advanced System Management Interface	CRC	Cyclic Redundancy Check
AltGr	Alt-Graphic	CSM	Cluster Systems Management
Azeri	Azerbaijan	CT	Component Trace
BFF	Backup File Format	CUoD	Capacity Upgrade on Demand
BIND	Berkeley Internet Name Domain	DAC	Discretionary access controls
BIST	Built-In Self-Test	DCEM	Distributed Command Execution Manager
BLV	Boot Logical Volume	DCM	Dual Chip Module
BOOTP	Boot Protocol	DES	Data Encryption Standard
BOS	Base Operating System	DGD	Dead Gateway Detection
BSD	Berkeley Software Distribution	DHCP	Dynamic Host Configuration Protocol
CA	Certificate Authority	DLPAR	Dynamic LPAR
CATE	Certified Advanced Technical Expert	DMA	Direct Memory Access
CD	Compact Disk	DNS	Domain Name Server
CD	Component Dump facility	DR	Dynamic Reconfiguration
CD-R	CD Recordable	DRM	Dynamic Reconfiguration Manager
CD-ROM	Compact Disk-Read Only Memory		

DST	daylight saving time	HTML	Hypertext Markup Language
DVD	Digital Versatile Disk	HTTP	Hypertext Transfer Protocol
DoD	Department of Defense	Hz	hertz
EC	EtherChannel	I/O	Input/Output
ECC	Error Checking and Correcting	IBM	International Business Machines
EGID	effective group ID	ICU	International Components for Unicode
EOF	End of File	ID	Identification
EPOW	Environmental and Power Warning	IDE	Integrated Device Electronics
EPS	Effective Privilege Set:	IEEE	Institute of Electrical and Electronics Engineers
ERRM	Event Response resource manager	IETF	Internet Engineering Task Force
ESS	Enterprise Storage Server	IGMP	Internet Group Management Protocol
EUID	effective user ID	IGMPv1	IPMG version 1
F/C	Feature Code	IGMPv2	IPMG version 2
FC	Fibre Channel	IP	Internetwork Protocol
FCAL	Fibre Channel Arbitrated Loop	IPAT	IP Address Takeover
FDX	Full Duplex	IPL	Initial Program Load
FFDC	First Failure Data Capture	IPMGv3	IGMP Version 3
FLOP	Floating Point Operation	IPMP	IP Multipathing
FRU	Field Replaceable Unit	IQN	iSCSI Qualified Name
FTP	File Transfer Protocol	ISC	Integrated Solutions Console
GDPS	Geographically Dispersed Parallel Sysplex	ISSO	Information System Security Officer
GID	Group ID	ISV	Independent Software Vendor
GPFS	General Parallel File System	ITSO	International Technical Support Organization
GSS	General Security Services	IVM	Integrated Virtualization Manager
GUI	Graphical User Interface	India	IN
HACMP	High Availability Cluster Multiprocessing	J2	JFS2
HBA	Host Bus Adapters	JFS	Journaled File System
HMC	Hardware Management Console	KAT	Kernel Authorization Table
HPC	High Performance Computing	KBD490	keyboard number 490
HPM	Hardware Performance Monitor	KBD491	keyboard number 491

KBD492	keyboard number 492	MPIO	Multipath I/O
KCT	Kernel Command Table	MPS	Maximum Privilege Set
KDT	Kernel Device Table	MTU	Maximum Transmission Unit
KRT	Kernel Role Table	Mbps	Megabits Per Second
KST	Kernel Security Table	NDAF	Network Data Administration Facility
L1	Level 1	NFS	Network File System
L2	Level 2	NIB	Network Interface Backup
L3	Level 3	NIM	Network Install Manager
LA	Link Aggregation	NIM	Network Installation Management
LACP	Link Aggregation Control Protocol	NIMOL	NIM on Linux
LAN	Local Area Network	NIS	Network Information Server
LDAP	Lightweight Directory Access Protocol	NVRAM	Non-Volatile Random Access Memory
LED	Light Emitting Diode	ODM	Object Data Manager
LFS	logical file system	OSGi	on Open Services Gateway Initiative
LFT	low function terminal	OSPF	Open Shortest Path First
LMB	Logical Memory Block	PCI	Peripheral Component Interconnect
LPA	Loadable Password Algorithm	PIC	Pool Idle Count
LPAR	Logical Partition	PID	Process ID
LPP	Licensed Program Product	PIT	provide point-in-time
LPS	Limiting Privilege Set	PKI	Public Key Infrastructure
LUN	Logical Unit Number	PLM	Partition Load Manager
LUNs	logical unit numbers	PM	Performance Monitor
LV	Logical Volume	POSIX	Portable Operating System Interface
LVCB	Logical Volume Control Block	POST	Power-On Self-test
LVM	Logical Volume Manager	POWER	Performance Optimization with Enhanced Risc (Architecture)
LWI	Light Weight Infrastructure	PPC	Physical Processor Consumption
MAC	Media Access Control	PPFC	Physical Processor Fraction Consumed
MBps	Megabytes Per Second		
MCM	Multichip Module		
MIBs	Management Information Bases		
ML	Maintenance Level		
MLS	Multi Level Security		
MP	Multiprocessor		

PSPA	page size promotion aggressiveness factor	SCSI	Small Computer System Interface
PTF	Program Temporary Fix	SDD	Subsystem Device Driver
PTX	Performance Toolbox	SED	Stack Execution Disable
PURR	Processor Utilization Resource Register	SFDC	Second Failure Data Capture
PV	Physical Volume	SLs	Sensitivity labels
PVID	Physical Volume Identifier	SMI	Structure of Management Information
PVID	Port Virtual LAN Identifier	SMIT	Systems Management Interface Tool
QoS	Quality of Service	SMP	Symmetric Multiprocessor
RAID	Redundant Array of Independent Disks	SMS	System Management Services
RAM	Random Access Memory	SMT	Simultaneous Multi-threading
RAS	Reliability, Availability, and Serviceability	SO	System Operator
RBAC	Role Based Access Control	SP	Service Processor
RCP	Remote Copy	SPOT	Shared Product Object Tree
RDAC	Redundant Disk Array Controller	SRC	System Resource Controller
RGID	real group ID	SRN	Service Request Number
RIO	Remote I/O	SSA	Serial Storage Architecture
RIP	Routing Information Protocol	SSH	Secure Shell
RISC	Reduced Instruction-Set Computer	SSL	Secure Socket Layer
RMC	Resource Monitoring and Control	SUID	Set User ID
RPC	Remote Procedure Call	SVC	SAN Virtualization Controller
RPL	Remote Program Loader	TCB	Trusted Computing Base
RPM	Red Hat Package Manager	TCP/IP	Transmission Control Protocol/Internet Protocol
RSA	Rivet, Shamir, Adelman	TE	Trusted Execution
RSCT	Reliable Scalable Cluster Technology	TEP	The Trusted Execution Path
RSH	Remote Shell	TLP	The Trusted Library Path
RTE	Run-Time Error	TLS	Transport Layer Security
RUID	real user ID	TSA	Tivoli System Automation
S	system scope	TSD	Trusted Signature Database
SA	System Administrator	TTL	time-to-live
SAN	Storage Area Network	UCS	Universal-Coded Character Set
		UDF	Universal Disk Format

UDID	Universal Disk Identification
UFST	Universal Font Scaling Technology
UID	user ID
ULM	user loadable module
UPS	Used Privilege Set:
VG	Volume Group
VGDA	Volume Group Descriptor Area
VGSA	Volume Group Status Area
VIPA	Virtual IP Address
VLAN	Virtual Local Area Network
VMM	Virtual Memory Manager
VP	Virtual Processor
VPA	Visual Performance Analyzer
VPD	Vital Product Data
VPN	Virtual Private Network
VPSS	variable page size support
VRRP	Virtual Router Redundancy Protocol
VSD	Virtual Shared Disk
WED	WebSphere Everyplace Deployment 6.0
WLM	Workload Manager
WPAR	workload partitions
WPARs	workload partitions
WPS	Workload Partition Privilege Set

Related publications

The publications listed in this section are considered particularly suitable for a more detailed discussion of the topics covered in this book.

IBM Redbooks

For information about ordering these publications, see “How to get Redbooks” on page 430. Note that some of the documents referenced here may be available in softcopy only.

- ▶ *AIX 5L Differences Guide Version 5.3 Edition*, SG24-7463
- ▶ *AIX 5L Differences Guide Version 5.3 Addendum*, SG24-7414
- ▶ *AIX V6 Advanced Security Features Introduction and Configuration*, SG24-7430
- ▶ *Introduction to Workload Partition Management in IBM AIX Version 6*, SG24-7431
- ▶ *AIX 5L Practical Performance Tools and Tuning Guide*, SG24-6478
- ▶ *IBM System p Advanced POWER Virtualization Best Practices*, REDP-4194
- ▶ *Linux Applications on pSeries*, SG24-6033
- ▶ *A Practical Guide for Resource Monitoring and Control (RMC)*, SG24-6615
- ▶ *Implementing High Availability Cluster Multi-Processing (HACMP) Cookbook*, SG24-6769
- ▶ *NIM from A to Z in AIX 5L*, SG24-7296
- ▶ *Partitioning Implementations for IBM eServer p5 Servers*, SG24-7039
- ▶ *Integrated Virtualization Manager on IBM System p5*, REDP-4061
- ▶ *IBM System p Live Partition Mobility*, SG24-7460
- ▶ *Integrated Virtual Ethernet Adapter Technical Overview and Introduction*, REDP-4340
- ▶ *Hardware Management Console V7 Handbook*, SG24-7491

Other publications

These publications are also relevant as further information sources:

- ▶ The following types of documentation are located through the Internet
<http://www.ibm.com/servers/eserver/pseries/library>
 - User guides
 - System management guides
 - Application programmer guides
 - All commands reference volumes
 - Files reference
 - Technical reference volumes used by application programmers
- ▶ Detailed documentation about the Advanced POWER Virtualization feature and the Virtual I/O Server
<https://www14.software.ibm.com/webapp/set2/sas/f/vios/documentation/home.html>
- ▶ *AIX 5L V5.3 Partition Load Manager Guide and Reference*, SC23-4883
- ▶ *Linux for pSeries installation and administration (SLES 9)*
<http://www-128.ibm.com/developerworks/linux/library/l-pow-pinstall/>
- ▶ *Linux virtualization on POWER5: A hands-on setup guide*
<http://www-128.ibm.com/developerworks/edu/1-dw-linux-pow-virtual.html>
- ▶ *POWER5 Virtualization: How to set up the SUSE Linux Virtual I/O Server*
<http://www-128.ibm.com/developerworks/eserver/library/es-susevio/>

How to get Redbooks

You can search for, view, or download Redbooks, Redpapers, Technotes, draft publications and Additional materials, as well as order hardcopy Redbooks, at this Web site:

ibm.com/redbooks

Help from IBM

IBM Support and downloads

ibm.com/support

IBM Global Services

ibm.com/services

Index

Symbols

\$HOME/dcem/logs/decm.log 231
 \$HOME/smit.log 231
 \$HOME/wsmits.log 231
 /admin/tmp directory 294
 /dev/netcd 285
 /etc/hosts 285
 /etc/netgroup 285
 /etc/networks 285
 /etc/nscontrol.conf 319
 /etc/protocols 285
 /etc/qconfig file 200–201
 /etc/qconfig.bin file 200–201
 /etc/security/aixpert/custom 297
 /etc/security/aixpert/dictionary 299
 /etc/security/aixpert/dictionary/English 299
 /etc/security/authorizations 305
 /etc/security/certificates/ 340
 /etc/security/login.cfg 345, 347
 /etc/security/passwd 298
 /etc/security/privcmds 305
 /etc/security/privdevs 305
 /etc/security/privfiles 306
 /etc/security/pwddal.cfg 344–345, 347
 /etc/security/roles 305
 /etc/security/sysck.cfg 339
 /etc/security/tsd/tsd.dat 339–340
 /etc/security/user 349–350
 /etc/services 285
 /pconsole/apps/eclipse/plugin-directories 231
 /pconsole/lwi directories 231
 /pconsole/lwi/conf/pconsole.javaopt 231
 /pconsole/lwi/conf/sslconfig 229
 /pconsole/lwi/conf/webcontainer.properties 229
 /usr/lpp/bos.sysmgmt/nim/README 364
 /usr/samples/nim/krb5/config_rpcsec_client 361
 /usr/samples/nim/krb5/config_rpcsec_server 361
 /usr/samples/tcpip/netcd.con 287
 /usr/samples/tcpip/netcd.conf 287
 /var/efs 44
 /var/log/pconsole/logs 231
 /var/security/fpm/log 302
 /var/tmp/netcd.log 289

_SC_ARG_MAX 201, 203
 _SRC_MAX_ARGS 202

Numerics

32-bit kernel - withdrawal 407
 64-bit kernel 408

A

AccountAdmin 315
 Advanced Accounting 220
 AES 41
 aio
 aio dynamic tunables 257
 aio_active attribute 260–261
 aioLpool 260
 aioo command 258, 261
 aioPpool 260
 fastpath attribute 259
 fsfastpath attribute 259
 ioo command 261
 maxreqs 262
 maxservers 262
 minservers 261
 posix_aio_active attribute 260–261
 aio_active attribute 260–261
 ais.system.config.diag 310
 AIX hardware support 404
 AIX role 313
 AIX Security Expert 296–297, 299–300, 303–304
 AIX system trace 3
 aix.device.config.printer 230
 aix.devices 309
 aix.fs 309
 aix.fs.manage.backup 310
 aix.fs.manage.quota 310
 aix.fs.manage.restore 310
 aix.lvm 309
 aix.mls 309
 aix.network 309
 aix.proc 309
 aix.ras 309
 aix.security 309
 aix.security.audit.list 310

- aix.security.group 230, 310, 317
 - aix.security.passwd 230, 310, 317
 - aix.security.passwd.normal 310
 - aix.security.role 230, 310, 317
 - aix.security.user 230, 310, 317
 - aix.security.user.change 310
 - aix.system 309
 - aix.system.boot.info 309
 - aix.wpar 309
 - aixdevice.stat.printer 230
 - aixpert command 304–305
 - aixPrinters 230
 - AIXTHREAD_SCOPE 209
 - AIXTHRED_MNRRATIO 209
 - aixUser 317
 - aixUsers 230
 - algorithm
 - Blowfish 347
 - crypt 346
 - DES 344
 - hash 346
 - MD5 346–347
 - SHA 347
 - SHA1 346
 - SHA256 346
 - SHA512 346
 - alt_disk_install, regarding snapshot backup 40
 - API
 - crypt() 343–347
 - getconfattr() 345
 - getrlimit 205
 - pthread_create 205–206
 - setconfattr() 345
 - setrlimit 205
 - sys_parm() 323
 - sysconf 202–203
 - Application Layer 317
 - Application Workload Partition 322
 - ARG_MAX 201–202
 - attribute
 - pwd_algorithm 345, 347
 - auditpr command 304
 - auth_sys security flavor 280
 - authorization
 - ais.system.config.diag 310
 - aix.device.config.printer 230
 - aix.devices 309
 - aix.fs 309
 - aix.fs.manage.backup 310
 - aix.fs.manage.quota 310
 - aix.fs.manage.restore 310
 - aix.lvm 309
 - aix.mls 309
 - aix.network 309
 - aix.proc 309
 - aix.ras 309
 - aix.security 309
 - aix.security.audit.list 310
 - aix.security.group 230, 310, 317
 - aix.security.passwd 230, 310, 317
 - aix.security.passwd.normal 310
 - aix.security.role 310, 317
 - aix.security.user 310, 317
 - aix.security.user.change 310
 - aix.system 309
 - aix.system.boot.info 309
 - aix.wpar 309
 - aixdevice.stat.printer 230
 - authorization and roles 309
 - authorization in AIX 5.3 307
 - authorizations 305, 313, 317, 322
 - auths 320
 - Azerbaijan, national language support 368
- B**
- backsnap command 38
 - backup 307, 310
 - backup command 307
 - BackupRestore 315
 - base DN 321
 - Blowfish 344, 347
 - BM Systems Director Console for AIX 212
 - bos.aixpert.cmd 299
 - bos.autoi 336
 - bos.mls.adt 336
 - bos.mls.cfg 336
 - bos.mls.lib 336
 - bos.mls.rte 336
 - bos.mls.rte.pre_i script 336
 - bos.mls.smit 336
 - bos.net.tcp.client 286
 - bos.rte.security 43
 - Business Layer 317
- C**
- cachefs 284
 - CCEVAL.BOS.autoi 336

chauth command 311, 320
chdev command 323
chfn command 308
chgroup command 308
chgrpmems command 308
chndaf command 276
chnfsdom command 359
chrole command 309, 313, 320
chsec command 308, 347
chuser command 206, 308
chwpar command 322
cio modes 49
ckauth command 311
Cluster Systems Management 221
COBIT 303–304
commands
 aixpert 304–305
 auditpr 304
 backsnap 38
 backup 307
 cnfsdom 359
 chauth 311, 320
 chdev 323
 chfn 308
 chgroup 308
 chgrpmems 308
 chndaf 276
 chnfsdom 359
 chrole 309, 313, 320
 chsec 308, 347
 chuser 206, 308
 chuser command 308
 chwpar 322
 ckauth 311
 cron 340
 diag 307
 dms 276
 dsh 221
 edquota 308
 efsenable 43, 49
 efskeymgr 43
 efsmgr 43
 emgr 170
 errctrl 107
 fpm 300–302
 ftp 277–278
 ftpd 277–278
 ifconfig 292
 j2edlimit 308
 kdb 169
 lsattr 202, 323
 lsauth 311, 320
 lskst 306
 lsldap 320
 lsndaf 276
 lsnim 359
 lspriv 312, 321
 lsque 201
 lsquedev 201
 lsrole 309, 313, 320
 lssec 308
 lssecattr 312, 320
 lsuser 308
 mkauth 311, 320
 mkgroup 308
 mkndaf 276
 mknfsexport 281
 mknfsproxy 194
 mkque 201
 mkquedev 201
 mkrole 309, 313, 320
 mksecldap 321
 mkuser 206, 308
 mount 36
 netcdctrl 287, 289
 netstat 292
 nim 359
 pprof 77
 pvi 312
 pwdadm 308
 qdaemon 200
 quota 308
 quotacheck 308
 quotaoff 308
 quotaon 308
 raso 168
 rbactoldif 320
 repquota 308
 restore 309
 rmauth 311, 320
 rmgroup 308
 rmndaf 276
 rmnfsproxy 194
 rmque 201
 rmquedev 201
 rmrole 309, 313, 320
 rmsecattr 313, 320
 rmuser 308

- rollback 38
- rsh 221
- rsync 276
- scp 278
- setkst 306, 320
- setsecattr 313, 320
- sftp 278
- snapshot 38
- ssh 221
- svmon 235
- swrole 315
- telnet 277
- tracepriv 312
- traceptv 325
- trustchk 340–343
- ulimit 206–207
- updates WPAR 90
- vi 347
- vmo 234
- wsm 226
- Communications Applications and Services 219
- Component Dump Facility 142
- component trace
 - AIX storage device driver 109
 - graphics 124
 - InfiniBand 112
 - IPsec 120
 - LAN drivers 114
 - MPIO 111
 - PCI drivers 120
 - USB 123
 - virtual bus 122
 - Virtual SCSI device driver 110
 - VMM 105
- Component Trace Facility 4
- component trace framework 101
- Console Role 317
 - aixPrinters 230
 - aixUser 317
 - aixUsers 230
- Console tool bar 215
- Console toolbar 215
- contention scope 209
- Control Objectives for Information and related Technology 303
- Create Proxy Server dialog 194–195
- cron 340
- crypt() 343–347
- crypto graphic library 362
- crypto library 42
- CSM 221
- ctctrl command 104
- D**
- DCEM 221
- Default tunables
 - IO Pacing by default 257
 - lru_file_repage 256
 - Virtual Memory Manager default tunables 255
- DES 343–344
- DES algorithm 343–344
- Devices 220
- diag 307
- Diagnostics 307, 310
- dialog
 - Create Proxy Server 194–195
 - Remove Proxy Server 194, 197
- dio 49
- directories
 - /admin/tmp 294
- directory
 - /etc/security/aixpert/custom 297
 - /etc/security/aixpert/dictionary 299
 - /etc/security/certificates/ 340
 - /pconsole/apps/eclipse/plug-ins 231
 - /pconsole/lwi 231
 - /var/log/pconsole/logs 231
 - /var/security/fpm/log 302
- DiskQuotaAdmin 308, 310
- Distributed Command Execution Manager 221
- DMAPI 40
- dmpuncompress command 142
- dms command 276
- DNS 285
- Documentation
 - Performance Tunables 240
- DomainAdmin 315
- dsh 221
- Dump Facilities
 - Component Dump Facility 142, 144
 - dmpuncompress command 142
 - Firmware-assisted dump Facility 142
 - Firmware-assisted System Dump 158
 - Live Dump attributes 152
 - Live Dump Facility 148
 - Live dump Facility 142
 - Live Dump file 149

Live Dump file size 149–150
 Live Dump heap content 151
 Live Dump heap size 151
 Live Dump Performing 163
 livedumpstart command 163
 Minidump Facility 141
 overview 141
 Parallel dump Facility 141
 sysdumpdev command 159, 161, 163
 System Dump attributes 156
 System Dump Facility 155
 System Dump file size 156
 Traditional dump 141
 dumpctrl command 104, 143, 145, 163
 dynamic variable page size 231

E

EAGAIN 205
 Eclipse 57, 212
 edquota 308
 Effective Privilege Set 311
 efsenable command 43, 49
 efskeymgr command 43
 efsmgr command 43
 emgr command 170
 encrypted file system 41
 enhanced RBAC 305, 323–324
 enhanced role
 AccountAdmin 315
 BackupRestore 315
 DomainAdmin 315
 FSAdmin 315
 isso 315
 sa 315
 SecPolicy 315
 so 315
 SysBoot 315
 SysConfig 315
 Enhanced Role Based Access Control 305
 enhanced_RBAC 323
 environment valuable
 AIXTHREAD_SCOPE 209
 AIXTHRED_MNRATIO 209
 EPS 311
 errctrl command 104, 107
 error isolation 166
 error log
 00412073 166

B709A434 167
 B9657B5B 167
 RECOVERY 166
 RECOVERY_NOTIFY 167
 RECOVERY_TIME 167
 Euro symbol support 374
 External snapshot 37

F

failure recovery routines 165
 fastpath attribute 259
 file
 \$HOME/dcem/logs/decm.log 231
 \$HOME/smit.log 231
 \$HOME/wsmmit.log 231
 /dev/netcd 285
 /etc/hosts 285
 /etc/netgroup 285
 /etc/networks 285
 /etc/nscontrol.conf 319
 /etc/qconfig 200–201
 /etc/qconfig.bin 200–201
 /etc/security/aixpert/dictionary/English 299
 /etc/security/authorizations 305
 /etc/security/login.cfg 345, 347
 /etc/security/passwd 298
 /etc/security/privcmds 305
 /etc/security/privdevs 305
 /etc/security/privfiles 306
 /etc/security/pwdalg.cfg 344–345, 347
 /etc/security/roles 305
 /etc/security/sysck.cfg 339
 /etc/security/tsd/tsd.dat 339–340
 /etc/security/user 349–350
 /pconsole/lwi/conf/pconsole.javaopt 231
 /pconsole/lwi/conf/sslconfig 229
 /pconsole/lwi/conf/webcontainer.properties 229
 libcrypto.a 278
 libssl.a 278
 limits.h 201, 206, 348
 sys/proc_compat.h 205
 sys/resource.h 205
 userpw.h 348
 wSMIT.log 231
 file decryption 45
 file encryption 45
 File Permission Manager 296, 300
 file system logging 36

fileset

- bos.aixpert.cmd 299
- bos.mls.adt 336
- bos.mls.cfg 336
- bos.mls.lib 336
- bos.mls.rte 336
- bos.mls.smit 336
- lwi.runtime 212
- ndaf.base.admin 275
- ndaf.base.client 275
- ndaf.base.server 275
- sysmgt.pconsole.apps.wdcem 212
- sysmgt.pconsole.apps.websm 212
- sysmgt.pconsole.apps.wrbac 212
- sysmgt.pconsole.apps.wsmmit 212
- sysmgt.pconsole.rte 212

filesets 56

- firmware-assisted dump facility 142
- firmware-assisted system dump 158
- fpm 296, 300–302
- FRR 165
- FSAdmin 315
- FSF_TLIB 343
- fsfastpath attribute 259
- ftp command 277–278
- ftpd command 277–278

G

- getconfattr() 345
- getrlimit API 205
- global namespace 283
- Global System-defined KAT 322
- graphical installer 354
- graphics, component trace 124
- group.bygid 285
- group.byname 285
- GroupAdmin 308, 310

H

- HACMP 166
- hardware support
 - AIX V6.1 404
- hash algorithm 346
 - Blowfish 344
 - MD5 344
 - SHA 344
- HealthFileSystem 227
- HealthMetricDetail 227

- HealthMetrics 227
- HealthSummary 227
- HealthTopProcesses 227
- High Performance Computing 204
- HPS 312

I

- IBM Systems Director Console for AIX 212, 215, 218, 225–226, 228–229, 316–317
- ICMPv6 292
- IEEE Std 1003.1-2001 5
- ifconfig command 292
- InfiniBand device driver, component trace 112
- Inheritable Privilege Set 312
- inheritance, file system 48
- installation
 - filesets 56
 - graphical installer 354
- Integrated Solutions Console 212
- Integration Layer 317
- Internal snapshot 37
- IO Pacing by default 257
- ioo tunables 245
- IP_ADD_SOURCE_MEMBERSHIP, socket options 273
- IP_BLOCK_SOURCE, socket options 273
- IP_DROP_SOURCE_MEMBERSHIP, socket options 273
- IP_UNBLOCK_SOURCE, socket options 273
- IPsec, component trace 120
- IPv4 285
- IPv6 285, 291
- ISC 212
- ISSO 333, 336
- isso 315

J

- j2edlimit 308
- JFS2
 - disabled logging 36
 - internal snapshot 36

K

- KAT 306
- KCT 306
- kdb command 169
- KDT 306

- Kerberos 280, 361
 - kernel command table 306
 - kernel device table 306
 - kernel error recovery 164
 - kernel extension 165, 408
 - kernel role table 306
 - kernel security table 306, 324
 - keystores 41
 - root admin mode 41
 - root guard mode 41
 - KRT 306
 - KST 306, 324
- L**
- LAN, component trace 114
 - LDAP 296, 319–321
 - LDAP databases 320
 - legacy authorization
 - Backup 307, 310
 - Diagnostics 307, 310
 - DiskQuotaAdmin 308, 310
 - GroupAdmin 308, 310
 - ListAuditClasses 308, 310
 - PasswdAdmin 308, 310
 - PasswdManage 308, 310
 - Restore 309–310
 - RoleAdmin 309–310
 - UserAdmin 308, 310
 - UserAudit 308, 310
 - legacy RBAC 323
 - legacy RBAC Mode 324
 - legacy role
 - ManageAllPasswds 314
 - ManageAllUsers 314
 - ManageBackup 314
 - ManageBackupRestore 314
 - ManageBasicPasswds 314
 - ManageBasicUsers 314
 - ManageDiskQuota 314
 - ManageRoles 314
 - ManageShutdown 314
 - RunDiagnostics 314
 - libcrypto.a file 278
 - libssl.a file 278
 - Light Weight Infrastructure 316
 - Light Weight Memory Trace (LMT) 3
 - Lightweight Directory Access Protocol 296
 - Lightweight Infrastructure 212
 - Limiting Privilege Set 312, 322
 - limits file 206
 - limits.h 348
 - limits.h file 201
 - ListAuditClasses 308, 310
 - live dump 166
 - Live Dump attributes 152
 - Live Dump Facility 142
 - Live Dump file 149
 - Live Dump file size 149
 - Live Dump heap content 151
 - Live Dump heap size 151
 - Live Dump performing 163
 - livedumpstart command 163
 - Loadable Password Algorithm 343–344
 - LPA 344–347
 - LPS 312, 322
 - LRU daemon 234
 - lru_file_repage 256
 - lsattr command 202, 323
 - lsauth command 311, 320
 - lskst command 306
 - lsldap command 320
 - lsndaf command 276
 - lsnim command 359
 - lspriv command 312, 321
 - lsque command 201
 - lsqudev command 201
 - lsrole command 309, 313, 320
 - lssec command 308
 - lssecattr command 312, 320
 - lsuser command 308
 - LVM configuration logs 180
 - LVM trace logs 177
 - LWI 212, 316
 - lwi.rte package 57
 - lwi.runtime 212
- M**
- Maltese, national language support 377
 - Manage the Cryptography Standard #11 219
 - ManageAllPasswds 314
 - ManageAllUsers 314
 - ManageBackup 314
 - ManageBackupRestore 314
 - ManageBasicPasswds 314
 - ManageBasicUsers 314
 - ManageDiskQuota 314

ManageRoles 314
 ManageShutdown 314
 Maximum Privilege Set 312
 maxpout 257
 maxreqs 262
 maxservers 262
 mcr.rte package 56
 MD5 344, 346–347
 Menu
 Show restricted Parameters 198–199
 metadata 36
 mfsid 283
 minidump facility 141
 minpout 257
 minservers 261
 mixed page sizes 233
 mkauth command 311, 320
 mkgroup command 308
 mkndaf command 276
 mknfsexport command 281
 mknfsproxy command 194
 mkque command 201
 mkquedev command 201
 mkrole command 309, 313, 320
 mksecdap command 321
 mksysb command, regarding snapshot backup 40
 mkuser command 206, 308
 MLS 324, 341
 mount command 36
 Mozilla Firefox 213
 MPIO, component trace 111
 MPS 312
 multiple authorizations 313
 multiple roles 313
 My Startup Pages 218

N

-n flag for RAS persistence attribute 104
 national language support 367
 Azerbaijan 368
 Euro 374
 Maltese 377
 Urdu 383
 Welsh 389
 Navigation area 215
 NCARGS 201
 ncargs ODM stanza 201–203
 NDAF 2, 275

 cell namespace 277
 domain 277
 log 276
 NDAF cell namespace 277
 NDAF domain 277
 NDAF logs 276
 ndaf.base.admin 275
 ndaf.base.client 275
 ndaf.base.server 275
 netcd 284, 286
 netcdctrl command 287, 289
 netid.byname 285
 netstat command 292
 Network caching daemon 284
 Network Data Administration Facility enhancements 274
 NFS 277
 NIM NFSv4 support 357
 proxy serving 278
 NFS default tunables 263
 NFS proxy serving 278
 NFS, run time checking 126
 nfso tunables 253
 NFSv4 360
 NIM 221, 357
 nim command 359
 NIS 284
 NIS+ 285
 no tunables 248
 number of processes per user 203
 number of threads per process 203

O

ODM 225
 PdAt 201
 ODM stanza
 ncargs 201–203
 Olsen time support 395
 ONC+ 2
 Open Services Gateway Initiative 212
 OpenSSH 277
 OpenSSL 277–278
 option
 processes 207
 threads 206–207
 threads_hard 206
 OSGi 212
 out-of-the-box performance 254

aio dynamic tunables 257
 IO Pacing by default 257
 maxpout 257
 minpout 257
 Virtual Memory Manager default tunables 255

P

-P flag for RAS persistence attribute 104
 -p flag for RAS persistence attribute 104
 page bar 216
 page size promotion 232–233
 Parallel dump Facility 141
 PASS_MAX 348–350
 passwd.adjunct.byname 286
 passwd.byname 285
 passwd.byuid 285
 PasswdAdmin 308, 310
 PasswdManage 308, 310
 password 297, 347
 PCI drivers, component trace 120
 PdAt ODM 201
 performance
 aio dynamic tunables 257
 aio_active attribute 260–261
 aioLpool 260
 aioo command 258, 261
 aioPpool 260
 fastpath attribute 259
 Force option -F 242
 fsfastpath attribute 259
 ioo 241
 ioo tunables 245
 lru_file_repage 256
 maxpout 257
 maxreqs 262
 maxservers 262
 minpout 257
 minservers 261
 NFS default tunables 263
 nfso 241
 nfso tunables 253
 no 241
 no tunables 248
 out-of-the-box performance 254
 posix_aio_active attribute 260–261
 raso 241
 raso tunables 254
 restricted tunables 241
 schedo 241
 schedo tunables 252
 Tunables documentation 240
 tunables lists 245
 tunsave 243
 vmo 241
 vmo tunables 247
 warning message for restricted tunables 242
 performance & resource scheduling 220
 persistence of component attributes 104
 PIT 37
 point in time images (PIT) 37
 Portlets 216
 posix 261
 POSIX analyzer process 6
 POSIX controller process 6
 POSIX Managing Trace Events 12
 POSIX System Trace Event Definition 10
 POSIX threads tracing 4
 POSIX Trace AIX Implementation 20
 POSIX Trace API 4
 POSIX Trace Event Definition 6–7
 POSIX Trace Event Sets 10
 POSIX Trace Log Policy 15
 POSIX trace model 6
 POSIX Trace Stream 6
 POSIX Trace Stream attributes 16
 POSIX Trace Stream Definition 13
 POSIX Trace Stream filtering 11
 POSIX Trace Stream Management 19
 POSIX Trace Stream Policy 15
 POSIX traced process 6
 POSIX tracing overview 5
 POSIX User Trace Event Definition 8
 posix_aio_active attribute 260–261
 POWER6
 dynamic variable page size 232
 pprof command 77
 predefined roles 313
 Presentation Layer 316
 Print spooler 200
 Print Spooling 219
 privcmds 321
 privdevs 321
 privfiles 321
 privilege 311
 privileged processes 294
 Privileges 305, 322
 probe 23

- probe actions 23
- probe event 24
- probe location 24
- probe manager 24
- probe point 23
- probe point specification 27
- probe type 24
- probevctrl command 25
- ProbeVue
 - action block 27–28
 - dynamic tracing benefits and restrictions 21
 - interval probe manager 29
 - introduction 21
 - ProbeVue example 31
 - predicate 27–28
 - probe 23
 - probe actions 23
 - probe event 24
 - probe location 24
 - Probe manager 28
 - probe manager 24
 - probe point 23
 - probe point specification 27
 - probe type 24
 - probevctrl command 25
 - probevue command 25
 - ProbeVue dynamic tracing benefits 22
 - ProbeVue Terminology 23
 - system call probe manager 29
 - user function probe manager 29
 - Vue functions 30
 - Vue overview 25
 - Vue program 24
 - Vue Programming Language 24
 - Vue script 24, 26
- probevue command 25
- Problem Determination 220
- Process Privilege Sets 311
- Processes & Subsystems 219
- processes option 207
- procmon plug-in 78
- pseudo file system 283
- pseudo root 283
- PSPA 234
- pthread_create API 205–206
- pvi command 312
- PW_PASSLEN 349–350
- pwd_algorithm 345, 347
- pwdadm command 308

Q

- qdaemon command 200
- quota command 308
- quotacheck command 308
- quotaoff command 308
- quotaon command 308

R

- RAS component framework
 - component 146
 - component Dump 144
 - ctctrl command 104
 - dumpctrl command 104, 143, 145, 163
 - errctrl command 104
 - Firmware-assisted System Dump 158
 - legacy component 146
 - Live Dump 148
 - Live Dump attributes 152
 - Live Dump file 149
 - Live Dump file size 149
 - Live Dump heap content 151
 - Live Dump heap size 151
 - Live Dump performing 163
 - livedumpstart command 163
 - n flag for RAS persistence attribute 104
 - Overview 101
 - P flag for RAS persistence attribute 104
 - p flag for RAS persistence attribute 104
 - Persistence of component attributes 104
 - ras_control subroutine 103
 - ras_customize subroutine 103
 - ras_register subroutine 103
 - ras_unregister subroutine 103
 - RASF_DUMP_AWARE flag 145
 - RASF_SET_LDMP_ON flag 145
 - RASF_SET_SDMP_ON flag 145
 - RASF_TRACE_AWARE flag 103
 - Serialized Live Dump file size 150
 - sysdumpdev command 159, 161, 163
 - System Dump attributes 156
 - System Dump Facility 155
 - System Dump file size 156
 - x flag for RAS persistence attribute 104
- ras_control subroutine 103
- ras_customize subroutine 103
- ras_register subroutine 103
- ras_unregister subroutine 103
- RASF_DUMP_AWARE flag 145

- RASF_SET_LDMP_ON flag 145
 - RASF_SET_SDMP_ON flag 145
 - RASF_TRACE_AWARE flag 103
 - raso
 - recovery_action 168
 - recovery_average_threshold 169
 - recovery_debugger 168
 - recovery_framework 168
 - raso command 168
 - raso tunables 254
 - RBAC 42, 219, 305, 315–317, 321–322, 331
 - RBAC database tables 319
 - RBAC framework 305
 - RBAC tables 320
 - rbactoldif 320
 - rc.mls 336
 - rc.mls.boot 336
 - rc.mls.boot script 340
 - rc.mls.net 336
 - RECOVERY 166
 - recovery manager 165
 - RECOVERY_NOTIFY 167
 - RECOVERY_TIME 167
 - Redbooks Web site 430
 - Contact us xxi
 - Reducing current values 208
 - Remove Proxy Server dialog 194, 197
 - repquota command 308
 - resolver 284
 - Restore 309–310
 - restore command 309
 - restricted tunables 168, 241
 - error log entry 244
 - fastpath attribute 259
 - Force option -F 242
 - fsfastpath attribute 259
 - ioo tunables 245
 - lru_file_repage 256
 - maxreqs 262
 - maxservers 262
 - minservers 261
 - NFS default tunables 263
 - nfso tunables 253
 - no tunables 248
 - raso tunables 254
 - schedo tunables 252
 - tunables lists 245
 - TUNE_RESTRICTED 244
 - tunrestore 244
 - tunsave 243
 - vmo tunables 247
 - warning message 242
 - RFCs
 - RFC 4007 292
 - RFC 4443 292
 - RLIM_NLIMITS 205
 - RLIM_NLIMITS_53 205
 - RLIMIT_NPROC 205–206
 - RLIMIT_THREADS 205–206
 - rmauth command 311, 320
 - rmgroup command 308
 - rmndaf command 276
 - rmnfsproxy command 194
 - rmque command 201
 - rmquedevel command 201
 - rmrole command 309, 313, 320
 - rmsecattr command 313, 320
 - rmuser command 308
 - Role Based Access Control 219, 305, 321
 - RoleAdmin 309–310
 - Roles 305, 313, 321–322
 - rollback command 38
 - rootkit 338
 - RPCSEC_GSS 280
 - RSA 41
 - rsh command 221
 - rsync command 276
 - RTEC 129
 - RunDiagnostics 314
 - Runtime integrity check 341
- ## S
- SA 315, 333, 336
 - Salt 343–344, 346
 - Sarbanes-Oxley Act of 2002 303
 - SbD.BOS.autoi 336
 - SCBPS 305
 - schedo tunables 252
 - scope zone 292
 - scp command 278
 - script
 - bos.mls.rte.pre_i 336
 - rc.mls 336
 - rc.mls.boot 336, 340
 - rc.mls.net 336
 - SecPolicy 315
 - Secure by Default 296, 302

Secure Sockets Layer 278
 Security & Users 218
 SED 296, 300
 Serialized Live Dump 150
 setconfattr() 345
 setgid 300
 setkst command 306, 320
 setrlimit API 205
 setsecattr command 313, 320
 Settable values 208
 setuid 300
 sftp command 278
 SHA 344, 347
 SHA1 346
 SHA-256 339, 342
 SHA256 346
 SHA512 346
 Show restricted Parameters Menu 198–199
 smd5 347
 SMIT 56, 221
 fastpaths 276
 SMIT fastpaths 276
 smitty 56
 snapshot command 38
 SO 315, 333, 336
 socket options 273
 Software Installation and Maintenance 220
 Software License Management 220
 SOX Configuration Assistant 303
 SOX section 404 303
 SOX-COBIT 296, 303–305
 SOX-COBIT Assistant 303
 SRC 231
 SSH 221, 277
 ssha256 345–346
 Stack Execution Disable 296, 300
 svmon command 235
 swrole command 315
 sys/proc_compat.h file 205
 sys/resource.h file 205
 sys_parm() 323
 SysBoot 315
 sysconf API 202–203
 SysConfig 315
 sysdumpdev command 159, 161, 163
 sysmgt.pconsole.apps.wdcem 212
 sysmgt.pconsole.apps.websm 212
 sysmgt.pconsole.apps.wrbac 212
 sysmgt.pconsole.apps.wsmmit 212

sysmgt.pconsole.rte 212
 System Administrator 333
 System Dump attributes 156
 System Dump Facility 155
 System Dump file size 156
 System Environments 219
 System integrity check 340
 System Management Interface Tool 221
 System Operator 333
 System Resource Controller (SRC) 287
 System Security Officer 333
 System Storage Management 219
 system trace 3
 System Workload Partition 321
 System-defined Kernel Authorization Table 306

T

task

Advanced Accounting 220
 Cluster Systems Management 221
 Communications Applications and Services 219
 Devices 220
 Distributed Command Execution Manager 221
 Manage the Cryptography Standard #11 219
 Performance & Resource Scheduling 220
 Print Spooling 219
 Problem Determination 220
 Processes & Subsystems 219
 Role Based Access Control 219
 Security & Users 218
 Software Installation and Maintenance 220
 Software License Management 220
 System Environments 219
 System Management Interface Tool 221
 System Storage Management 219
 Web-based System Manager 221
 Workload Partition Administration 220
 Task categories 215
 TCB 339
 telnet command 277
 TEP 342
 threads option 206–207
 threads_hard option 206
 time support, Olsen 395
 tivoli.tivguid package 57
 TLP 343
 trace hooks 176

- tracepriv command 312, 325
 - tracing facility
 - AIX system trace 3
 - Component trace Facility 4
 - dynamic tracing benefits and restrictions 21
 - interval probe manager 29
 - Light Weight Memory Trace (LMT) 3
 - POSIX analyzer process 6
 - POSIX controller process 6
 - POSIX Managing Trace Events 12
 - POSIX System Trace Event Definition 10
 - POSIX Trace AIX Implementation 20
 - POSIX Trace API 4
 - POSIX Trace Event Definition 6–7
 - POSIX Trace Log Policy 15
 - POSIX Trace Overview 5
 - POSIX Trace Stream 6
 - POSIX Trace Stream attributes 16
 - POSIX Trace Stream Definition 13
 - POSIX Trace Stream filtering 11
 - POSIX Trace Stream Management 19
 - POSIX Trace Stream Policy 15
 - POSIX traced process 6
 - POSIX User Trace Event Definition 8
 - POSIX User Trace Event Sets 10
 - predicate 27–28
 - probe 23
 - probe action block 27–28
 - probe actions 23
 - probe event 24
 - probe location 24
 - Probe manager 28
 - probe manager 24
 - probe point 23
 - probe point specification 27
 - probe type 24
 - probevctrl command 25
 - ProbeVue 21
 - probevue command 25
 - ProbeVue dynamic tracing benefits 22
 - ProbeVue example 31
 - ProbeVue Terminology 23
 - system call probe manager 29
 - tracing Facilities Overview 3
 - truss 4
 - user function probe manager 29
 - Vue functions 30
 - Vue Overview 25
 - Vue program 24
 - Vue Programming Language 24
 - Vue script 24, 26
 - traditional dump 141
 - Transport Layer Security 277
 - trcrpt command, with respect to WPAR 58
 - truss 4
 - trustchk command 340–343
 - Trusted AIX 324, 331, 341
 - Trusted Computing Base 339
 - Trusted Execution 337–339, 341–342
 - Trusted Execution Path 339, 342
 - Trusted Library Path 339, 343
 - Trusted Signature Database 340–341
 - Trusted Singature Database 339–340
 - TSD 340–342
 - tunables lists 245
 - TUNE_RESTRICTED 244
 - tunrestore 244
- ## U
- ulimit command 206–207
 - ULM 285
 - Unicode 5.0 support 399
 - United States Congress 303
 - Universal Font Scaling Technology 404
 - unlimited value 208
 - UPS 312
 - Urdu, national language support 383
 - USB, component trace 123
 - Used Privilege Set 312
 - UserAdmin 308, 310
 - UserAudit 308, 310
 - User-defined Authorization Database 306
 - user-defined KAT 322
 - User-defined Kernel Authorization Table 306
 - User-level Privileged Command Database 306
 - User-level Privileged Device Database 306
 - User-level Role Database 306
 - userpw.h 348
- ## V
- value
 - unlimited 208
 - vi command 347
 - Virtual Memory Manager default tunables 255
 - Virtual SCSI, component trace 110
 - vm_patrr() 234
 - VMM 407

- dynamic variable page size 231
- VMM, component trace 105
- vmm_default_pspa 234
- vmm_mpsize_support 234
- vmo
 - vmm_default_pspa 234
 - vmm_mpsize_support 234
- vmo command 234
- vmo tunables 247
- VPSS 232
- virtual bus, component trace 122
- Vue Overview 25
- Vue program 24
- Vue Programming Language 24
- Vue script 24, 26

W

- watchdog services 165
- weak root passwords 296–297
- Web-based System Manager 194, 198, 221, 226
 - JFS2 snapshots 39
- Web-based Systems Manager 303
- WebSphere Everyplace Deployment 212
- WED 212
- Welsh, national language support 389
- WLM 56, 205
- Work area 215–216
- Workload Partition 212, 321–322
- Workload Partition Administration 220
- Workload Partition mobility. 306
- Workload Partition Privilege Set 322
- WPAR
 - management options 56
- WPAR package files 56
- wparmgt.agent.rte package 56
- wparmgt.cas.agent package 57
- wparmgt.cas.agentmgr package 57
- wparmgt.mgr.rte package 56
- WPS 322
- wsm command 226
- wSMIT.log 231

X

- x flag for RAS persistence attribute 104
- X Windows 405
- XML rules 296

To determine the spine width of a book, you divide the paper PPI into the number of pages in the book. An example is a 250 page book using Plainfield opaque 50# smooth which has a PPI of 526. Divided 250 by 526 which equals a spine width of .4752". In this case, you would use the .5" spine. Now select the Spine width for the book and hide the others: **Special>Conditional Text>Show/Hide>SpineSize(-->Hide:)->Set** . Move the changed Conditional text settings to all files in your book by opening the book file with the spine:fm still open and **File>Import>Formats** the Conditional Text Settings (ONLY!) to the book files.
Draft Document for Review December 28, 2007 8:21 pm

7559spine.fm 447



Redbooks

IBM AIX Version 6.1 Differences Guide

(1.5" spine)
1.5" <-> 1.998"
789 <-> 1051 pages



Redbooks

IBM AIX Version 6.1 Differences Guide

(1.0" spine)
0.875" <-> 1.498"
460 <-> 788 pages



Redbooks

IBM AIX Version 6.1 Differences Guide

(0.5" spine)
0.475" <-> 0.875"
250 <-> 459 pages



Redbooks

IBM AIX Version 6.1 Differences Guide

(0.2" spine)
0.17" <-> 0.473"
90 <-> 249 pages

(0.1" spine)
0.1" <-> 0.169"
53 <-> 89 pages

To determine the spine width of a book, you divide the paper PPI into the number of pages in the book. An example is a 250 page book using Plainfield opaque 50# smooth which has a PPI of 526. Divided 250 by 526 which equals a spine width of .4752". In this case, you would use the .5" spine. Now select the Spine width for the book and hide the others: **Special>Conditional Text>Show/Hide>SpineSize(->Hide)->Set** . Move the changed Conditional text settings to all files in your book by opening the book file with the spine:fm still open and **File>Import>Formats** the Conditional Text Settings (ONLY!) to the book files.
Draft Document for Review December 28, 2007 8:21 pm

7559spine.fm 448



Redbooks

IBM AIX Version 6.1 Differences Guide

(2.5" spine)
2.5" <-> mnn.n"
1315 <-> mnn pages



Redbooks

IBM AIX Version 6.1 Differences Guide

(2.0" spine)
2.0" <-> 2,498"
1052 <-> 1314 pages



Draft Document for Review December 28, 2007 8:21 pm

IBM AIX Version 6.1 Differences Guide



AIX - The industrial strength UNIX operating system

AIX Version 6.1 enhancements explained

An expert's guide to the new release

This IBM Redbook focuses on the differences introduced in IBM AIX Version 6.1 when compared to AIX 5L Version 5.3. It is intended to help system administrators, developers, and users understand these enhancements and evaluate potential benefits in their own environments.

AIX Version 6.1 introduces many new features, [List of enhancements] There are many other enhancements available with AIX Version 6.1, and you can explore them in this redbook.

For clients who are not familiar with the enhancements of AIX through Version 5.3, a companion publication, AIX 5L Differences Guide Version 5.3 Edition, SG24-7463 is available, along with an addendum SG24-7414.

**INTERNATIONAL
TECHNICAL
SUPPORT
ORGANIZATION**

**BUILDING TECHNICAL
INFORMATION BASED ON
PRACTICAL EXPERIENCE**

IBM Redbooks are developed by the IBM International Technical Support Organization. Experts from IBM, Customers and Partners from around the world create timely technical information based on realistic scenarios. Specific recommendations are provided to help you implement IT solutions more effectively in your environment.

For more information:
ibm.com/redbooks

SG24-7559-00

ISBN