

NETGEAR

MODEL
EN104/EN108/EN116

Ethernet Hub Installation Guide

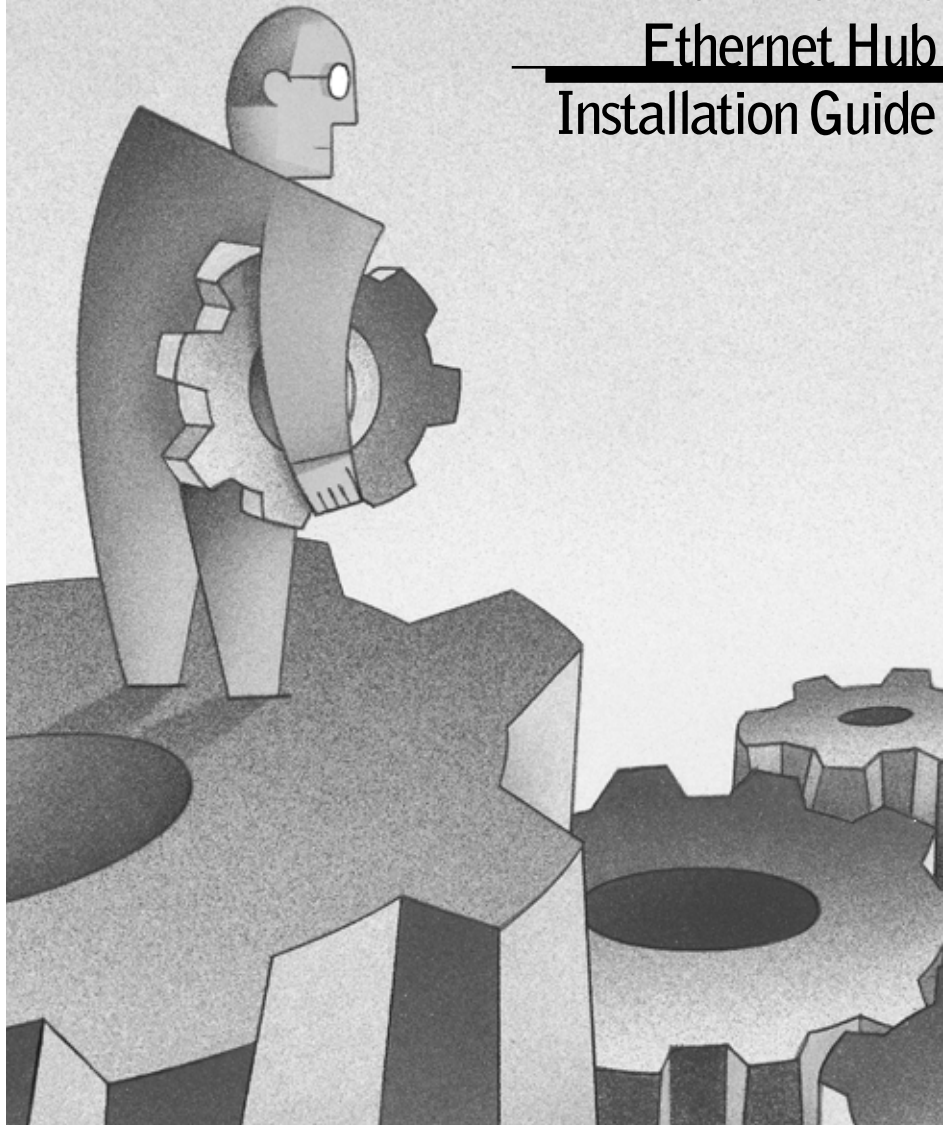



Start Here

Congratulations on your purchase of the NETGEAR™ Model EN104, Model EN108, or Model EN116 Ethernet hub. The hubs deliver standards-based, plug-and-play networking solutions for small businesses, home offices, and low-density workgroups of larger companies.

In this installation guide, all three hubs are referred to collectively as the Model EN104/EN108/EN116 hub. Each hub is listed individually when information is provided that refers to a specific model.



Features

The Model EN104/EN108/EN116 hub has the following features:

- Four (on the Model EN104 hub), eight (on the Model EN108 hub), and sixteen (on the Model EN116 hub) 10BASE-T network ports (RJ-45) that provide 10 megabit per second (Mbps) networking using simple unshielded twisted pair (UTP) wiring
- Built-in LED indicators for at-a-glance status checks by vista networks ports
- AUI (not on the Model EN104 hub) or coaxial BNC backbone support for connecting to an existing Ethernet segment or external transceiver, or for network expansion by connecting multiple hubs together using twisted pair or coaxial cabling
- Uplink port for connecting to other hubs using simple straight-through cables
- Clear front-panel light-emitting diode (LED) indicators to monitor overall hub status
- Plug-and-play installation with no software to configure
- Complete hub functions including packet retiming, collision detection, preamble regeneration, and fragment extension
- Automatic partitioning and reconnection of a port that has excessive collisions or is jabbering
- Automatic polarity detection for recognizing and correcting incorrect polarity on the receive pair
- Compact design, enabling easy tabletop or rack-mounting installation
- External power adapter
- Limited lifetime warranty on the unit and three-year warranty on the power supply



Package Contents

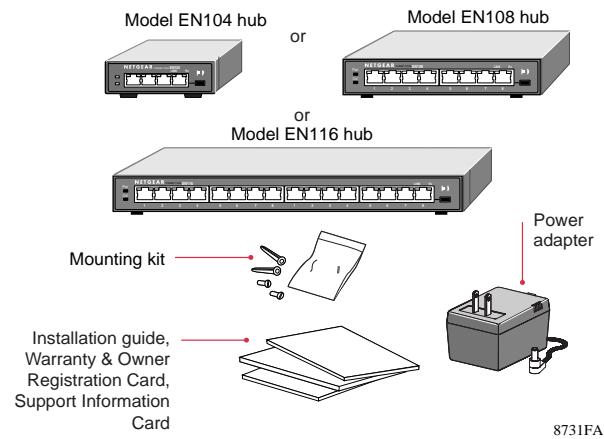

Verify that your package contains the following:

- Model EN104 hub, Model EN108 hub, or Model EN116 hub
- Mounting kit (for wall installation)
- BNC T-connector and BNC 50 Ω terminator (only if you have purchased the Model EN108 hub or the Model EN116 hub)
- This installation guide
- Warranty & Owner Registration Card
- Support Information Card
- Power adapter



Product Illustration

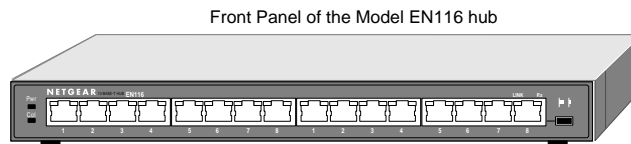
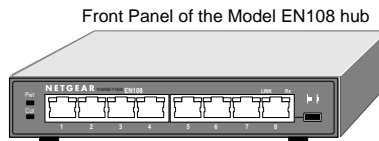
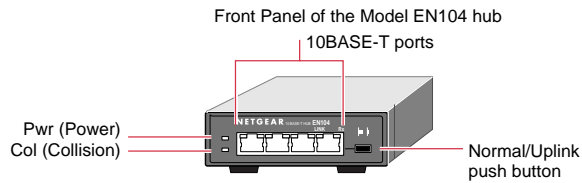

8732FA

Vista 10BASE-T Network Ports with Built-in LEDs

The front panel of the Model EN104 hub has four RJ-45 10BASE-T ports, the Model EN108 hub has eight RJ-45 10BASE-T ports, and the Model EN116 hub has sixteen RJ-45 10BASE-T ports. Two LEDs—the Link LED and the Rx LED—are built into each 10BASE-T port.

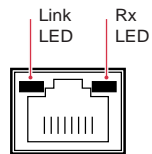

8724EA

LEDs

The table below describes the activity of the LEDs.

Label	Color	Activity	Description
Pwr (Power)	Green	On	Power is supplied to the hub.
Col (Collision)	Amber	Blinking	Data collision is occurring on the network. Note that occasional collisions are normal.
Link (located on the top left corner of each vista 10BASE-T port)	Green	On	The link between this port and the connected device is good.
Rx (located on the top right corner of each vista 10BASE-T port)	Green	Blinking	There is incoming data on the port.
Active (for BNC)	Green	On	The link between the BNC port and the connected device is good.
Rx (for BNC)	Green	Blinking	There is incoming data on the BNC port.
Active (for AUI)	Green	On	The link between the AUI port and the connected device is good.
Rx (for AUI)	Green	Blinking	There is incoming data on the AUI port.

Normal/Uplink Push Button

The Normal/Uplink push button allows you to select Normal (MDI-X) wiring for direct PC connection. The push button also allows you to select Uplink (MDI) wiring for connection to a hub or a switch through port 4 on the Model EN104 hub, port 8 on the Model EN108 hub, or port 16 on the Model EN116 hub. This uplink configuration eliminates the need to use a crossover cable. The other 10BASE-T ports are permanently configured for normal wiring for connection to a PC.

Rear Panel

The rear panel of the hub has a BNC port that you can use to connect to a backbone network or other PCs using thin coaxial cable.

The rear panel of the Model EN108 hub and the Model EN116 hub also has an AUI port in addition to the BNC port. You can use the AUI port with the appropriate transceiver to connect the hub to a backbone network using thin coaxial cable, thick coaxial cable, fiber optic cable, or 10BASE-T wiring.

The rear panel also includes a DC power receptacle.

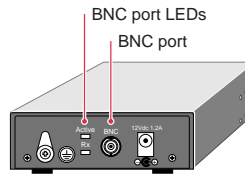

Rear Panel of the Model EN104 hub

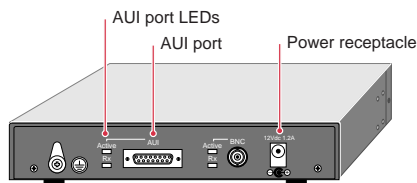

Rear Panel of the Model EN108 hub



Rear Panel of the Model EN116 hub

8738FA



Installation Procedures



Prepare the Site

Before you begin installing your hub, prepare the installation site. Make sure your operating environment meets the operating environment requirements of the equipment.

Characteristic	Requirement
Temperature	Ambient temperature between 0° and 40° C (32° and 104° F). No nearby heat sources such as direct sunlight, warm air exhausts, or heaters.
Operating humidity	Maximum relative humidity of 90%, noncondensing.
Ventilation	Minimum 2 inches (5.08 cm) on all sides for cooling. Adequate airflow in room or wiring closet.
Operating conditions	At least 6 feet (1.83 m) to nearest source of electromagnetic noise (such as photocopier machine or arc welder).
Service access	Minimum 12 inches (19.68 cm) front and back for service access and maintenance. Front and back clearance for cables and wiring hardware such as punchdown blocks.
Power	Adequate power source within 6 feet (1.83 m).
Wiring hardware	Wiring hardware, such as punchdown blocks or patch panels, should be complete before installing the hub.



Install the Hub

To install your hub on a flat surface, you do not need any special tools. Be sure the hub is positioned with at least 2 inches of space on all sides for ventilation.

To install the hub on a wall, measure the distance between the mounting holes on the back of the hub and mark the wall to match the location of the mounting holes on the hub. At the marked location, screw into the wall the two screws that you received with the mounting kit included in your package contents. Be sure to choose a location that is near the devices to be connected, is close to an electrical outlet, and provides at least 2 inches of space all around the hub for ventilation.

3

Connect a PC to the Hub

You can connect PCs, Apple Macintosh computers, UNIX workstations, or any device equipped with a 10BASE-T Ethernet interface to the RJ-45 ports on your hub by using twisted pair Ethernet cables.

To connect any of the RJ-45 ports on your hub to a PC, use a regular straight-through UTP cable. If you are connecting using port 4 on the Model EN104 hub, port 8 on the Model EN108 hub, or port 16 on the Model EN116 hub, set the Normal/Uplink push button to Normal.

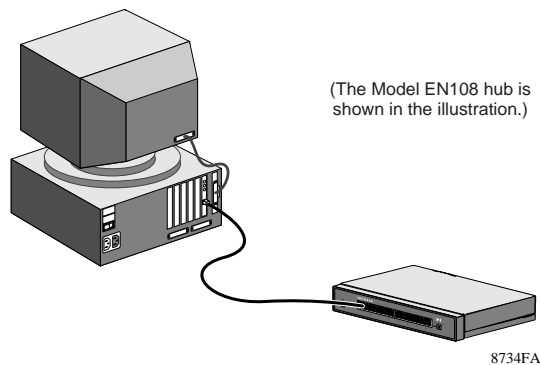

Note: Ethernet specifications limit the cable length between your PC or server and the hub to 328 feet (100 meters) in length.

4

Connect the Hub to a Network

Cascading refers to connecting hubs together to increase the number of ports or the number of users supported on the network. The 10BASE-T ports can be used to cascade hubs together.

The twisted pair cable extended from a 10BASE-T port (or UTP port) is called a twisted pair segment and can be up to 100 meters (m) in length. The 10BASE-T ports, with the exception of port 4 on the Model EN104 hub, port 8 on the Model EN108 hub, or port 16 on the Model EN116 hub, are MDI-X (or Normal) ports. Use the following table as a guide for selecting the appropriate network cable.

Connecting Port on the Hub	Connecting Device	Cable Used
Model EN104 hub: Ports 1–3	PC, server, or router	Straight-through cable
Ports 1–3	Hub or switch	Crossover cable
Model EN108 hub: Ports 1–7	PC, server, or router	Straight-through cable
Ports 1–7	Hub or switch	Crossover cable
Model EN116 hub: Ports 1–15	PC, server, or router	Straight-through cable
Ports 1–15	Hub or switch	Crossover cable

Set the Normal/Uplink Push Button

If you are connecting to port 4 on the Model EN104 hub, port 8 on the Model EN108 hub, or port 16 on the Model EN116 hub, use the following table. Determine the type of cable to use and how to set the Normal/Uplink push button.

Connecting Port	Connecting Device	Cable Used
Port 4, port 8, or port 16 set to Normal	PC, server, or router	Straight-through cable
Port 4, port 8, or port 16 set to Uplink	Hub or switch	Straight-through cable

Cascade the Hub

The following illustration shows cascading hubs together in a hierarchical star through the 10BASE-T ports and indicates the setting of the Normal/Uplink push button on each hub.

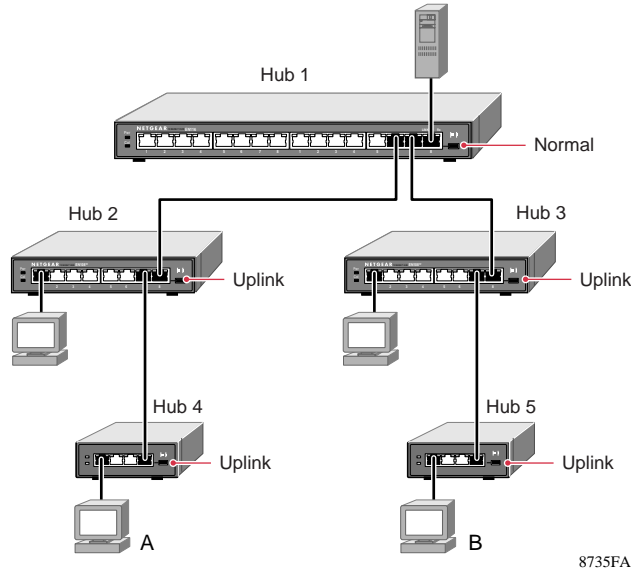

Note: Ethernet specifications limit the number of hubs with twisted pair links in any communication path to five, as shown in the example. When PC “A” communicates with PC “B,” the communication path goes from hub 4 to hub 2, to hub 1, to hub 3, and then to hub 5.

The following illustration shows cascading hubs together daisy-chain style and indicates the setting of the Normal/Uplink push button on each hub.

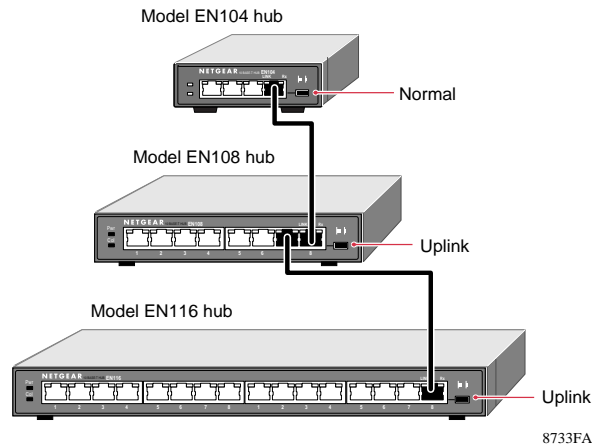

Connect to a Network Using the BNC Port

The BNC port on the rear panel of the hub is used for connecting to a thin coaxial segment. You can connect other Model EN104/EN108/EN116 hubs, servers, workstations, or other devices to the BNC port. A BNC-T connector is inserted in the port, and the 50 Ω terminator terminates the connection at each end device. By using the BNC port for cascading, you treat each connected hub as just another node on the coaxial segment.

The separation marks in the coaxial cable between the hubs in this illustration represent the incorporation of other devices and show that interconnection is not limited to hubs.

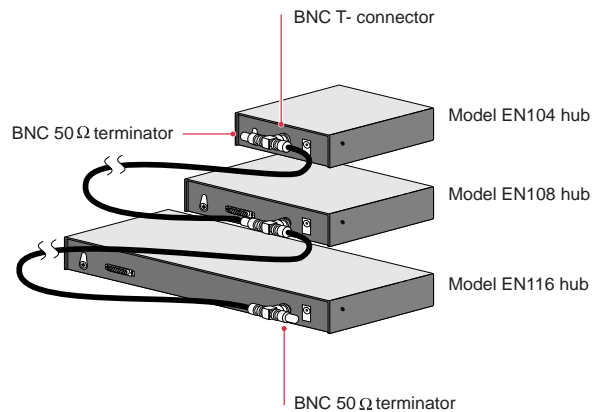

8736FA



Note: Ethernet specifications limit a BNC segment to 30 BNC connections, specify a minimum of 1.64 feet (0.5 m) between any two stations, and limit segments to 607 feet (185 m) in length.

Connect to a Network Using the AUI Port

The AUI port on the rear panel (found only on the Model EN108 hub and the Model EN116 hub) is normally used for connecting a thick coaxial segment.

With the right type of transceiver, you can use the AUI port to connect to most types of network media, including 10BASE-T twisted pair cable or thin coaxial, thick coaxial, and 10BASE-FL fiber optic cables.



Note: All transceivers connected to the AUI port must have the signal quality error (SQE) test function disabled. Refer to your transceiver documentation for information about disabling the SQE test function.

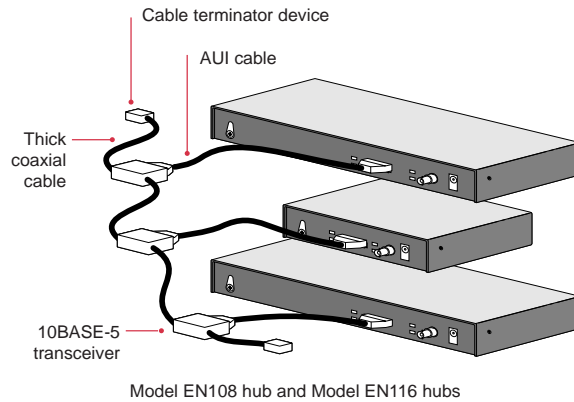

8737FA



Note: Ethernet specifications limit thick coaxial segments to 100 stations and 1,640 feet (500 m) in length, and they specify that the AUI cable between the hub and the transceiver is limited to 164 feet (50 m).

5

Verify Installation

To complete the installation, connect the power cord first to the power receptacle on the hub rear panel and then to the power outlet on the wall. When power has been applied to the hub:

- The green Pwr (Power) LED on the front panel is on.
- The green Link LED on each connected port is on.
- The green Active LED on each connected AUI port is on.
- The green Active LED on each connected BNC port is on.

If encounter any problems, refer to “Troubleshooting” on page 4.



Troubleshooting

Symptom	Cause	Solution
Amber Col LED blinks.	There is data collision on the network.	Data collision is normal on Ethernet networks. No action is required.
Amber Col LED blinks excessively.	There is data collision on the network because the network is extremely busy or defective devices are connected on the network that cannot detect network traffic or collision.	Make sure connected devices are operating in half-duplex mode. The hub is not compatible with devices that operate in full-duplex mode. If you suspect that there might be a defective device on the network, disconnect devices one at a time to isolate the defective unit on the network. If the network is extremely busy, you may have to segment the network with an Ethernet switch such as a NETGEAR Ethernet switch or to upgrade your network to Fast Ethernet operation.
	Wrong or miswired cables are used.	Make sure the correct UTP cables are used. See the table in the installation section of this guide for cable use and Normal/Uplink push button information. Note that home telephone cables can cause a collision condition and cannot be used in place of UTP cables.
Green Link LED is off when a cable is attached.	The port is not detecting a successful link.	Check for a bad cable, cable pairs that are not correctly wired, or loose connectors. Make sure that there is power to both the hub and the Ethernet transceiver on the connected device.
Green Link LED is not blinking when there is data transmission.	The port is not detecting data transmission.	Check for a bad cable, cable pairs that are not correctly wired, or loose connectors. Make sure that there is power to both the hub and the Ethernet transceiver on the connected device.
Green Active LED on the BNC port is not on when the port is connected.	The port is not detecting a successful link.	Make sure that each segment is terminated with a BNC 50 terminator at both ends. Check for a bad cable.
Green Rx LED on the BNC port is not blinking when there is data transmission.	The port is not detecting data transmission.	Check for a bad cable or loose connectors. Make sure that there is power to both the hub and the connected device.
Green Active LED on the AUI port is not on when the port is connected.	The port is not detecting a successful link.	Make sure that the AUI transceiver is functioning properly, the coaxial segment is terminated correctly, the segment is not disconnected along the cable length, and the signal quality error (SQE) test on the transceiver is disabled. Refer to your transceiver documentation for instructions on setting the SQE.
Green Rx LED on the AUI port is not blinking when there is data transmission.	The port is not detecting data transmission.	Check for a bad cable or loose connectors. Make sure that there is power to both the hub and the connected device.

Network Interface Cards

Make sure the network interface cards installed in the workstations are in working condition and the software drivers have been installed.

Hub Integrity

If required, verify the integrity of the hub by resetting it. Turn power to the hub off and then back on. If the problem continues and you have completed all the preceding diagnoses, contact NETGEAR Customer Support. For the phone number of the representative in your area, refer to the Support Information Card.



Technical Specifications

General Specifications	
Network Protocol and Standards Compatibility IEEE 802.3i, 10BASE-T, 10BASE-2, 10BASE-5 Ethernet	
Data Rate	10 Mbps, Manchester encoded
Interface	10BASE-T ports (RJ-45), BNC port, AUI port (Model EN108 hub and Model EN116 hub only)
Max. Power Consumption	
Model EN104 hub	11.0 W
Model EN108 hub	16.5 W
Model EN116 hub	20.5 W
DC Output Voltage (Power Adapter):	
Model EN104 hub	7.5 V DC @ 1A max.
Model EN108 hub	12 V DC @ 1.2A max.
Model EN116 hub	12 V DC @ 1.2A max.,
Physical Specifications	
Dimensions:	
Model EN104 hub	3.7 by 4.0 by 1.1 in. 94 by 101 by 28 mm
Model EN108 hub	6.2 by 4.0 by 1.1 in. 158 by 101 by 28 mm
Model EN116 hub	11.3 by 4.0 by 1.1 in. 286 by 101 by 28 mm
Weight:	
Model EN104 hub	0.74 lb (0.34 kg)
Model EN108 hub	1.17 lb (0.53 kg)
Model EN116 hub	1.97 lb (0.89 kg)
Environmental Specifications	
Operating temperature:	0° to 40° C (32° to 104° F)
Operating humidity:	90% maximum relative humidity, noncondensing
Electromagnetic Compliance	
CE mark, commercial FCC Part 15 Class A EN 55 022 (CISPR 22), Class A VCCI Class A C-Tick	
Safety Agency Approvals for Power Adapter	
CE mark, commercial UL listed (UL 1950) CUL TUV licensed (EN 60 950) T-Mark	



Replacement Power Adapter

If, for any reason, the power adapter for any of the hubs fails, contact NETGEAR immediately to order a replacement adapter. Use the following table when ordering a specific power adapter.

Order code	EN104
PWR-024-001	Power adapter (7.5 V DC, 1 A), North America
PWR-024-002	Power adapter (7.5 V DC, 1 A), Europe
PWR-024-003	Power adapter (7.5 V DC, 1 A), United Kingdom
PWR-024-004	Power adapter (7.5 V DC, 1 A), Australia
PWR-024-005	Power adapter (7.5 V DC, 1 A), Japan

Order code	EN108, EN116
PWR-002-004	Power adapter (12 V DC, 1.2 A), North America
PWR-002-005	Power adapter (12 V DC, 1.2 A), Japan
PWR-002-006	Power adapter (12 V DC, 1.2 A), Europe
PWR-002-008	Power adapter (12 V DC, 1.2 A), United Kingdom
PWR-002-010	Power adapter (12 V DC, 1.2 A), Australia

© 2000 by NETGEAR, Inc. All rights reserved.

Trademarks

NETGEAR™ is a trademark of NETGEAR, Inc. Windows® is a registered trademark of Microsoft Corporation. Other brand and product names are trademarks or registered trademarks of their respective holders. Information is subject to change without notice.

Statement of Conditions

In the interest of improving internal design, operational function, and/or reliability, NETGEAR reserves the right to make changes to the products described in this document without notice.

NETGEAR does not assume any liability that may occur due to the use or application of the product(s) or circuit layout(s) described herein.

Certificate of the Manufacturer/Importer

It is hereby certified that the NETGEAR Model EN104 hub, Model EN108 hub, and Model EN116 hub have been suppressed in accordance with the conditions set out in the BMPT-AmtsblVfg 243/1991 and Vfg 46/1992. The operation of some equipment (for example, test transmitters) in accordance with the regulations may, however, be subject to certain restrictions. Please refer to the notes in the operating instructions.

Federal Office for Telecommunications Approvals has been notified of the placing of this equipment on the market and has been granted the right to test the series for compliance with the regulations.

Voluntary Control Council for Interference (VCCI) Statement

This equipment is in the first category (information equipment to be used in commercial and/or industrial areas) and conforms to the standards set by the Voluntary Control Council for Interference by Data Processing Equipment and Electronic Office Machines that are aimed at preventing radio interference in commercial and/or industrial areas.

Consequently, when this equipment is used in a residential area or in an adjacent area thereto, radio interference may be caused to equipment such as radios and TV receivers.

Federal Communications Commission (FCC) Compliance Notice: Radio Frequency Notice

Note: This equipment has been tested and found to comply with the limits for a Class A digital device, pursuant to Part 15 of the FCC rules. These limits are designed to provide reasonable protection against harmful interference when the equipment is operated in a commercial environment. This equipment generates, uses, and can radiate radio frequency energy. If it is not installed and used in accordance with the instruction manual, it may cause harmful interference to radio communications. Operation of this equipment in a residential area is likely to cause harmful interference, in which case users will be required to take whatever measures may be necessary to correct the interference at their own expense.

EN 55 022 Statement

This is to certify that the NETGEAR Model EN104 hub, Model EN108 hub, and Model EN116 hub are shielded against the generation of radio interference in accordance with the application of Council Directive 89/336/EEC, Article 4a. Conformity is declared by the application of EN 55 022 Class A (CISPR 22).

	<p>Warning: This is a Class A product. In a domestic environment, this product may cause radio interference, in which case the user may be required to take appropriate measures.</p>
-------------------------------------------------------------------------------------	----------------------------------------------------------------------------------------------------------------------------------------------------------------------------------------------

Canadian Department of Communications Radio Interference Regulations

This digital apparatus (NETGEAR Model EN104 hub, Model EN108 hub, and Model EN116 hub) does not exceed the Class A limits for radio-noise emissions from digital apparatus as set out in the Radio Interference Regulations of the Canadian Department of Communications.

Règlement sur le brouillage radioélectrique du ministère des Communications

Cet appareil numérique (NETGEAR Model EN104 hub, Model EN108 hub, et Model EN116 hub) respecte les limites de bruits radioélectriques visant les appareils numériques de classe A prescrites dans le Règlement sur le brouillage radioélectrique du ministère des Communications du Canada.

NETGEAR

NETGEAR, Inc.
4500 Great America Parkway
Santa Clara, CA 95054
USA

Phone: 1-888-NETGEAR
E-mail: Support@NETGEAR.com
<http://www.NETGEAR.com>

