

Color 
LaserJet™
4500, 4500 N, 4500 DN Printer

User Guide

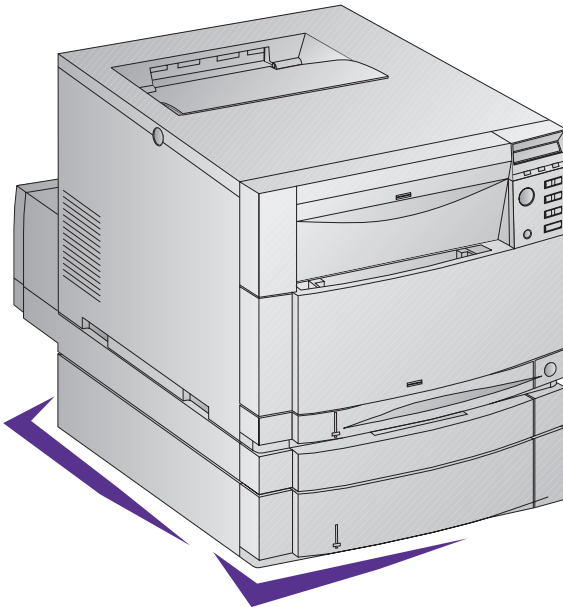

- [How to Use This Online User Guide](#) ♦
- [Where to Look for More Information](#) ♦
- [Locating Printer Components](#) ♦
- [Locating Consumables](#) ♦
- [HP Product Support](#) ♦
- [HP Customer Support](#) ♦
- [Contents](#) ♦
- [Index](#) ♦

English

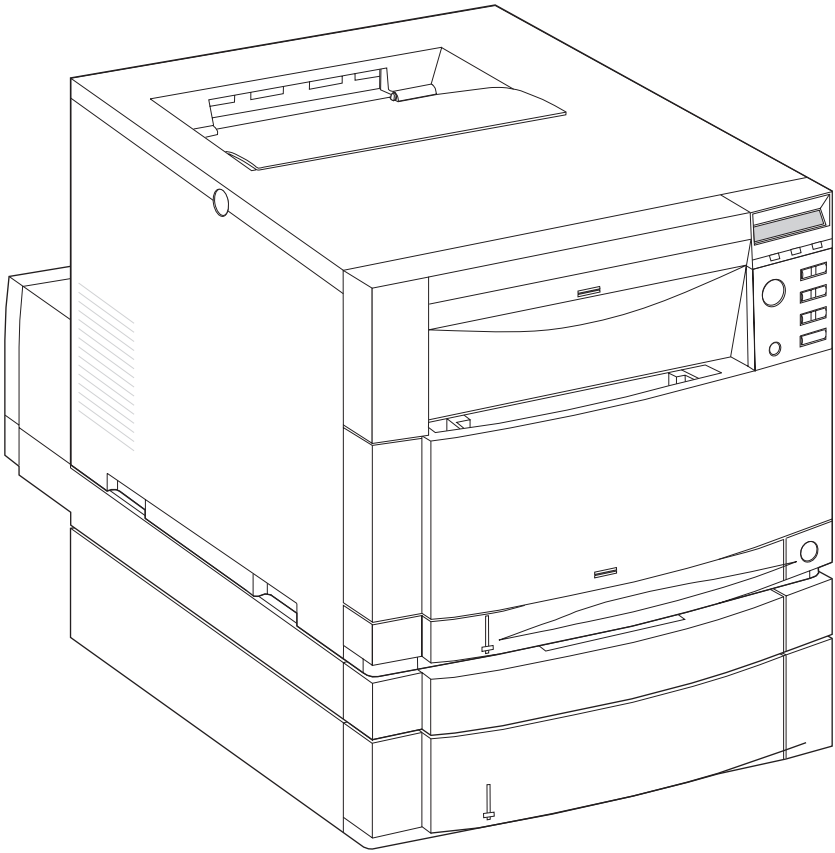

HP Color LaserJet 4500, 4500 N, 4500 DN Printer

User Guide

© Copyright Hewlett-Packard Company, 1998

All Rights Reserved.
Reproduction, adaptation, or translation without prior written permission is prohibited, except as allowed under the copyright laws.

Part number: C4084-90937
First edition, 6/98

Warranty

The information contained in this document is subject to change without notice.

Hewlett-Packard makes no warranty of any kind with respect to this information. HEWLETT-PACKARD SPECIFICALLY DISCLAIMS THE IMPLIED WARRANTY OF MERCHANTABILITY AND FITNESS FOR A PARTICULAR PURPOSE.

Hewlett-Packard shall not be liable for any direct, indirect, incidental, consequential, or other damage alleged in connection with the furnishing or use of this information.

Trademark Credits

Adobe is a trademark of Adobe Systems Incorporated which may be registered in certain jurisdictions.

Arial is a U.S. registered trademark of the Monotype Corporation.

CompuServe is a U.S. trademark of CompuServe, Inc.

Microsoft® is a U.S. registered trademark of Microsoft Corporation.

PANTONE®* *Pantone, Inc.'s check-standard trademark for color.

PostScript is a trademark of Adobe Systems Incorporated which may be registered in certain jurisdictions.

TrueType is a U.S. trademark of Apple Computer, Inc.

UNIX is a registered trademark in the United States and other countries, licensed exclusively through X/Open Company Limited.

Windows, MS Windows, and Windows NT are U.S. registered trademarks of Microsoft Corporation.

Contents

Where to Look for More Information	11
Setting Up the Printer	11
Using the Printer	12
How to Use This Online User Guide	13
Finding Information in .pdf Documents	13
Viewing .pdf Documents	13
Finding Words	14

1 The HP Color LaserJet 4500 Printer

Overview	15
Using Your Printer	15
Printer Features	16
Factors Affecting Printer Performance.	18
Managing Memory	19
Effects of Printer Features.	19
Locating Printer Components.	20
Controlling Print Jobs	22
Printer Supplies and Accessories.	23
HP JetSend Communications	24

2 Using the Printer Control Panel

Overview	25
When to Use the Printer Control Panel	26
Locating Printer Control Panel Features	27
Using Printer Control Panel Keys	28
Using the Printer Online Help System	28
Interpreting Control Panel Indicator Lights	29
Using Printer Control Panel Menus	30
Menu Locking	30
Information Menu	30
Printing a Menu Map	31
Interpreting the Menu Map.	31
Printing a Printer Configuration Page	32
Interpreting the Printer Configuration Page	32
Paper Handling Menu	34
Configuration Menu	35

Printing Menu	36
I/O Menu	37
EIO Menu	37
Calibration Menu	38
Resets Menu	39
Using the Printer Control Panel in Shared Environments	40
Changing Printer Control Panel Configuration Settings	41
Changing PowerSave Settings	41
Switching Printer Personalities	42
Setting the I/O Timeout	43
Disabling the High-Speed Parallel Interface	44
Setting Advanced Functions	45
Resetting Printer Memory	45
Resetting the Printer to Factory Default Settings	46

3 Common Printing Tasks

Overview	47
Selecting Print Media	48
Supported Media Weights and Sizes	49
Media to Avoid	51
Printing on Special Media	52
Printing on Transparencies	52
Printing on Glossy Paper	52
Printing on Colored Paper	52
Printing Envelopes	53
Printing on Labels	53
Heavy Paper	54
Preprinted Forms and Letterhead	54
Recycled Paper	54
Controlling Print Jobs	55
Selecting Output Bins	55
Selecting Media by Type	56
Configuring Input Trays	57
Configuring Tray 1 as a Cassette	57
Configuring Trays 2 and 3 by Media Type	58
Tray Priority	58
Printing from Tray 1 (Multipurpose Tray)	59
Loading Media into Tray 1	60
Loading Envelopes into Tray 1	61
Printing from Tray 2	63
Loading Media into Tray 2	64
Printing from Tray 3 (500-Sheet Paper Feeder)	66
Loading Media into Tray 3	67

Using the Duplex Printing Accessory for Two-Sided Printing	70
Control Panel Settings for Duplex Printing	71
Options for Binding Duplex Printing Jobs	72
Special Printing Situations	73
Printing a Different First Page	73
Printing on Custom-Size Media	73
Stopping a Print Request	74

4 Using Color

Overview	75
Customizing Color Output Through Printer Drivers	76
Halftone Options	76
HP ColorSmart II	77
Print in Grayscale	77
Matching Colors	78
Color-Matching Factors	78
Matching PANTONE®* Colors	78
Adjusting Color Balance	79

5 Using Fonts

Overview	83
Using HP FontSmart	84
Using Internal TrueType Fonts	85
Understanding Printer Default Fonts	86
Font Selection Priority	86
Selecting Fonts	87
Selecting Fonts from Software Applications	87
Selecting PCL Fonts Through the Printer Control Panel	88
Printing a List of Available Printer Fonts	90
Interpreting the Font Lists	91
Using Typefaces for PostScript Emulation in the Printer	92
Using Fonts on a Network	93
Adding Support for Accessory Fonts to a Printer Driver	94
Verifying Software Application Support for Fonts	94
Using Special Type Effects	95
Hewlett-Packard Custom Font Services	96

6 Printer Interfaces

Overview	97
Parallel Configuration	98
Parallel Cable Pin Configuration	99

Enhanced I/O (EIO) Configuration	100
HP JetDirect Print Servers	100
Available Enhanced I/O Interfaces	101
NetWare 3.x- and 4.x-Based Products	101
Windows and Windows NT Networks	101
IBM OS/2 LAN Server and Warp Server Networks	102
UNIX Networks	103
Setting Network Security on the Printer	103
Configuring the Printer for the Network at the	
Printer Control Panel	104
Configuring Novell NetWare Frame Type Parameters	104
Configuring TCP/IP Parameters	106
Disabling Network Protocols (Optional)	108

7 Consumables and Cleaning

Overview	111
Making Room for Replacing Consumables	112
Consumable Replacement Guidelines	113
Approximate Replacement Intervals for Consumable Items	114
Locating Consumables	115
Environmental Collection Program	116
Cleaning the Toner Density Sensor	117

8 Printer Control Panel Messages

Overview	119
Message Types	120
Status Messages	120
Warning Messages	120
Attention Messages	120
Critical Error Messages	120
Printer Control Panel Messages	121

9 Solving Problems with the Printer

Overview	133
Basic Troubleshooting Checklist	134
Paper Jam Locations	135
Paper Jam Recovery	136
Common Causes of Paper Jams	137
Paper Jam Messages	138

Clearing Paper Jams	139
Tips for Avoiding Paper Jams	139
Clearing Jams in the Middle Front Drawer Area	140
Clearing Jams in the Tray 2 Area	141
Clearing Jams in the Optional Tray 3 Area	142
Clearing Jams in the Rear Door Areas	143
Clearing Jams in the Front Duplex Drawer Area	145
Media-Handling Problems	146
Printer Response Problems	150
Printer Control Panel Problems	154
Solving Print Quality Problems.	155
Color Printing Problems	163
Incorrect Printer Output	165
Software Application Problems	167

Appendix A DIMM Installation

Overview	169
DIMM Configuration.	170
Installing DIMMs.	171
Verifying DIMM Installation	174

Appendix B PCL Commands

Overview	175
Interpreting PCL Printer Command Syntax	177
Combining Escape Sequences in PCL Printer Command Syntax	178
Entering Escape Characters	179
Selecting PCL Fonts.	180
Common PCL Commands.	181

Appendix C Specifications

Electrical Specifications	187
Operating Environment Specifications	187
Acoustic Emissions	188
Environmental Product Stewardship Program	189
Regulatory Statements.	193
FCC Regulations	193
Canadian DOC Regulations	194
VCCI Statement (Japan)	194
Korean EMI Statement	194
Declaration of Conformity	195

Safety Information	197
Laser Safety	197
Material Safety Data Sheet (MSDS)	197
Laser Statement for Finland	198

Appendix D Warranty and Support Information

Hewlett-Packard Warranty Statement	201
HP Maintenance Agreements	203
On-Site Service Agreements	203
Support Information	204
Customer Support Options Worldwide	206
Worldwide Sales and Service Offices	208

Index

Where to Look for More Information . . .

Several references are available for use with this printer. For additional copies of the guides below, contact HP Direct at 1-800-538-8787 (U.S.) or contact your HP-authorized dealer. Additional information is available at <http://www.hp.com>.

Setting Up the Printer

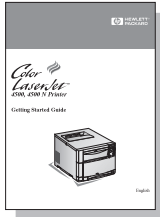

Getting Started Guide

Step-by-step instructions for installing and setting up the printer.

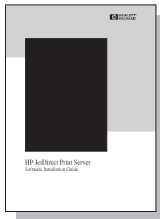

HP JetDirect Print Server Software Installation Guide*

Step-by-step instructions for configuring the HP JetDirect print server.

*Accompanies printers that include an HP JetDirect print server (network card).

Using the Printer

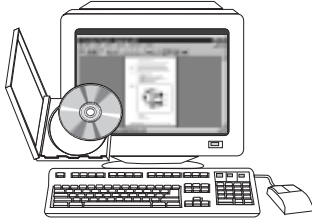

Online User Guide

Detailed information on using and troubleshooting the printer. Available for installation on your computer from the CD-ROM that came with the printer.

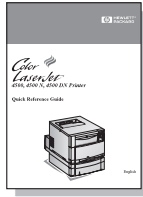

Quick Reference Guide

Tips and quick information in a booklet to keep by the printer. See your network administrator for the copy that came with the printer.



Online Help

Information on printer options that are available from within printer drivers. To view a Help file, access the online Help through the printer driver.

How to Use This Online User Guide

This user guide is provided as an Adobe™ Acrobat Reader .pdf document. This section will help familiarize you with using .pdf documents.

Finding Information in .pdf Documents

To find specific information in a .pdf document, click Contents or Index in the upper-left corner of the Acrobat Reader window, and then click the topic you want.

Viewing .pdf Documents

For complete instructions on how to view .pdf documents, see the online Help included with Acrobat Reader.

Magnifying the Page View

You can use the zoom tool, the magnification box in the status bar, or the toolbar buttons to change the screen magnification. When you zoom in on a document, you can use the hand tool to move the page around.

Acrobat Reader also offers magnification level choices that control how the page fits on-screen:



Fit Page scales the page to fit within the main window.

Fit Width scales the page to fit the width of the main window.

Fit Visible fills the window with the page's content area only.



To increase magnification: Select the zoom tool and click on the document page to double the current magnification.

To decrease magnification: Select the zoom tool while holding down Ctrl (Windows and UNIX) or Option (Macintosh), and click the center of the area you want to reduce.

Paging Through a Document

The following options are available for paging through a document.



To go to the next page: Click the Next Page button in the toolbar, or press the Right Arrow or Down Arrow.

To return to the previous page: Click the Previous Page button in the toolbar, or press the Left Arrow or Up Arrow.



To go to the first page: Click the First Page button in the toolbar.

To go to the last page: Click the Last Page button in the toolbar.



To jump to a specific numbered page: Click the page number box in the status bar at the bottom of the main window, type the page number, and click OK.

Browsing with Thumbnails

A thumbnail is a miniature view of each document page. You can display thumbnails in the overview area. Use a thumbnail to jump quickly to a page and to adjust the view of the current page.



Click on a thumbnail to move to the page it represents.

Finding Words

Use the Find command to find part of a word, a complete word, or multiple words in the active document.



Click on the find button, or choose Find from the Tools menu.

1 The HP Color LaserJet 4500 Printer

Overview

This chapter describes the features and specifications of the HP Color LaserJet 4500, 4500 N, or 4500 DN printer. The chapter includes the following sections:

- Printer Features
- Managing Memory
- Locating Printer Components
- Controlling Print Jobs
- Printer Supplies and Accessories
- HP JetSend Communications

Using Your Printer

Information on using the printer to perform common tasks is presented throughout this guide. Some specific tasks and the chapters describing them are listed below.

- Using the Printer Control Panel (Chapter 2)
- Loading Media into the Printer (Chapter 3)
- Optimizing Color Quality (Chapter 4)
- Clearing Paper Jams (Chapter 9)

Printer Features

This printer combines the quality and reliability of Hewlett-Packard printers with the features listed below. For more information on printer features, see the Hewlett-Packard website at <http://www.hp.com>.

- Performance**
 - 16 pages per minute (ppm) in black and white
 - 4 ppm in color
 - Transparencies and glossy paper (8 ppm in black and white, 2 ppm in color)

- Memory**
 - 32 megabytes (MB) of random access memory (RAM) (40 MB in the HP Color LaserJet 4500 DN Printer)
 - Memory Enhancement Technology (MEt), which automatically compresses data to use RAM more efficiently

- Supported Printer Personalities**
 - HP PCL5c
 - PostScript Emulation
 - Auto language switching

- Fonts**
 - 80 internal fonts
 - HP FontSmart

- Paper Handling (Input)**
 - 150-sheet multipurpose tray. Use for paper, transparencies, labels, heavy media, and envelopes
 - 250-sheet standard cassette
 - 500-sheet paper feeder (included with the HP Color LaserJet 4500 DN Printer)

- Paper Handling (Output)**
 - Top output bin holds up to 250 sheets of standard paper
 - Rear output bin holds up to 100 sheets of standard paper

- Duplex Printing ● Duplex printing accessory mounts directly beneath the printer for two-sided printing (included with the HP Color LaserJet 4500 DN Printer)

- Connectivity ● Bidirectional parallel port requires a “C” connector
- Two Enhanced Input/Output (EIO) slots
- HP JetDirect print server (EIO network card) (included with the HP Color LaserJet 4500 N and 4500 DN Printers)

- Environmental Features ● PowerSave setting (meets ENERGY STAR guidelines)
- High content of recyclable components and materials

Factors Affecting Printer Performance

Several factors affect the time it takes to print a job. Among these is printer speed, measured in pages per minute (ppm). Factors that affect printer speed include special media (such as transparencies, glossy media, and heavy media) and custom-size media.

The time required to download a print job from the computer to the printer also affects print speed. Among the factors that affect download time are:

- complex or large graphics
- color versus black and white
- the printer's I/O configuration (network versus parallel speed)
- the speed of the computer you are using
- the amount of printer memory installed
- the network operating system and configuration (if applicable)
- printer personality (PCL or PostScript Emulation)

Note

Adding additional printer memory may resolve memory problems, improve how the printer handles complex graphics, and improve download times, but will not increase printer speed.

Managing Memory

This printer supports up to 208 MB of memory. You can add additional memory by installing Dual Inline Memory Modules (DIMMs). To allow for memory expansion, the printer has three available DIMM slots, which accept 4, 8, 16, 32, or 64 MB of RAM each. For information on installing printer memory, see Appendix A.

The printer features Memory Enhancement Technology (MEt), which automatically compresses page data to provide the most efficient use of the printer's RAM.

Note

If memory problems occur when you are printing complex graphics, you can make more memory available by removing downloaded fonts, style sheets, and macros from printer memory. Reducing the complexity of a print job from within an application or printer driver can help in avoiding memory problems.

Effects of Printer Features

Certain printer features require printer memory. These features can be disabled to save printer memory resources. For information on disabling these resources, see the chapter on using the printer control panel.

Locating Printer Components

The following illustrations identify the locations and names of key components of this printer.

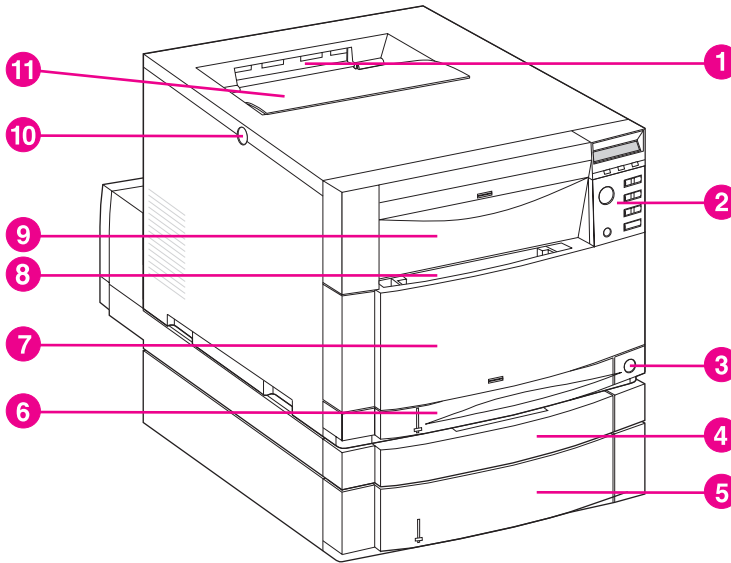

Figure 1-1 Front View (shown with 500-sheet paper feeder and duplex printing accessory)

- 1 Top Output Bin
- 2 Printer Control Panel
- 3 Power Switch (standby button)
- 4 Optional Duplex Printing Accessory Drawer
- 5 Tray 3 (optional 500-sheet paper feeder)
- 6 Tray 2 (250 sheets of standard paper)
- 7 Middle Front Drawer (transfer belt access)
- 8 Tray 1 (150-sheet multipurpose tray)
- 9 Upper Front Drawer (imaging drum access)
- 10 Top Cover Door Release Button
- 11 Top Cover Door (toner cartridge access)

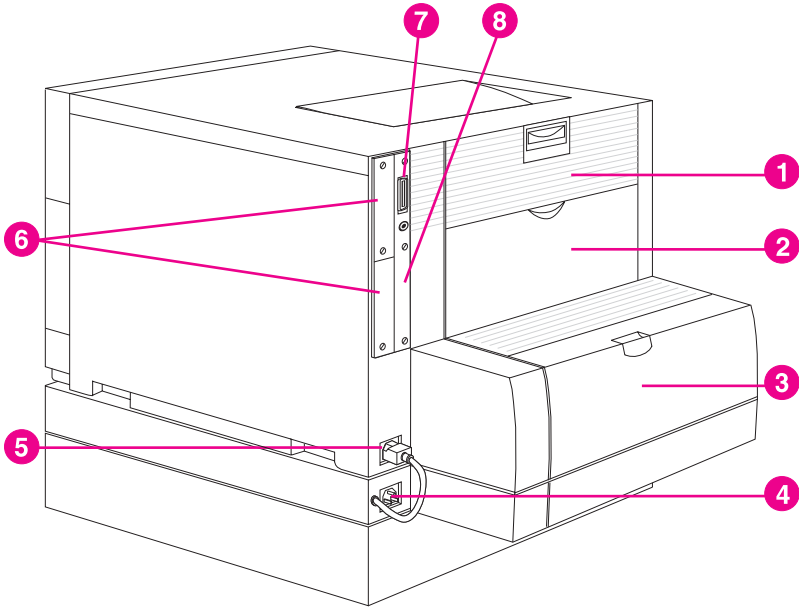

Figure 1-2 Rear View (shown with 500-sheet paper feeder and duplex printing accessory)

- 1 Rear Door (fuser access)
- 2 Rear Output Bin Door
- 3 Optional Duplex Printing Accessory Cover
- 4 Optional Duplex Printing Accessory Power Receptacle
- 5 Printer Power Receptacle
- 6 EIO slots
- 7 Parallel Connector (“C” connector)
- 8 Memory Access

Controlling Print Jobs

Three options are available for controlling print jobs:

- Select printer settings through your software application or the printer driver (recommended method)
- Select printer settings using the printer control panel
- Enter printer commands directly into files

Select printer settings through your software application or the printer driver

The optimal way to control the printer is through your software application or the printer driver. Changing these settings affects only *your* print job. Most software applications allow you to choose printing selections from menus within the software application. These selections override the selections on the printer control panel.

Select printer settings using the printer control panel

You can also control the printer through the keys and menus of the printer control panel. Changing these settings affects all print jobs. If you are sharing the printer, coordinate control panel changes with other users. For more information, see the chapter on using the printer control panel.

Note

Software application and printer driver settings override printer control panel settings.

Enter printer commands directly into files

Some software applications allow you to enter printer commands (for example, escape sequences) directly into files. However, this method of controlling your printer requires that you learn printer PCL commands. For information on PCL printer commands, see Appendix C or the *PCL Technical Reference Package* for this printer. You can purchase the guide through HP Direct. (See Appendix D for ordering information.)

Printer Supplies and Accessories

You can increase the capabilities of your printer by adding accessories. To order printer accessory products, call Hewlett-Packard's Direct Marketing Division. (See the Warranty and Support chapter of this guide for phone numbers.)

Accessory	Product Number	Description	Additional Information
Memory (DIMMs)	C4140A C4141A C4142A C4143A C4144A	4 MB 8 MB 16 MB 32 MB 64 MB	This printer uses dual inline memory modules (DIMMs) exclusively.
500-Sheet Paper Feeder	C4082A	Optional 500-sheet input tray	
Duplex Printing Accessory	C4083A	Optional two-sided printing accessory	
Printer Cabinet	C4235A	HP Color LaserJet 4500 Printer Cabinet	
Toner Supplies	C4191A C4192A C4193A C4194A	Black Cyan Magenta Yellow	
Consumable Items	C4195A C4196A C4197A C4198A	Drum Kit Transfer Kit Fuser Kit (110V) Fuser Kit (220V)	
Media	C2934A C2936A	HP Transparency Film (letter) HP Transparency Film (A4)	
Network Connectivity	J3110A J3111A J3112A J3113A	HP JetDirect 600N for Ethernet (10Base-T [RJ-45]) HP JetDirect 600N for Ethernet (10Base-T [RJ-45] and 10Base-2 [BNC]) and LocalTalk (DIN-8) HP JetDirect 600N for Token Ring (DB9, RJ-45) HP JetDirect 600N for Fast Ethernet (10/100 Base-TX [RJ-45])	
Cables	C2946A 92215N 92215S	10 m (30 ft) parallel cable (IEEE-1284 compliant) with a 25-pin DB male to a (IEEE-1284C) male "C" connector LocalTalk Cable Kit DIN-8 printer cable (for Macintosh computers)	
Reference Materials	5021-0368 5021-0337 5967-0831	<i>HP LaserJet Printer Family Paper Specification Guide</i> <i>PCL/PJL Technical Reference Package</i> <i>HP JetDirect Print Server Software Installation Guide</i>	
Localized Font DIMMS	5062-4667 5062-4668 5062-4669 5062-4670 C4292A (CAS) C4293A (CAS) YS-90210	Greek Hebrew Cyrillic Arabic Traditional Chinese Simplified Chinese Japanese	(1MB) (8MB)

HP JetSend Communications

HP JetSend is a new technology from Hewlett-Packard that allows network devices to communicate directly with each other. Devices that feature the HP JetSend technology can exchange information directly with other devices that are connected via an intranet. Sending devices include JetSend-enabled scanners and PCs. Receiving devices include JetSend-enabled PCs.

HP JetSend technology enables flexible, direct communications between network devices. HP JetSend enables simple, targeted, information exchange that is independent of both servers and applications. This means that users can easily exchange information directly between intranet-connected devices like printers and scanners (and other devices in the future).

HP JetSend capabilities can be integrated into the Microsoft Windows environment. For example, using PCs that have been JetSend-enabled by installing HP JetSend for Windows software, you can distribute information via an intranet to several users. Users can receive the document in their JetSend-enabled PC's Inbox or print directly to their JetSend-enabled printer. In addition to sending and receiving documents, you can view documents in the HP JetSend Viewer. HP JetSend for Windows software can be installed through an installer on the compact disc.

2 Using the Printer Control Panel

Overview

This chapter helps you use the printer control panel to maximize printer performance. This chapter includes the following sections:

- When to Use the Printer Control Panel
- Locating Printer Control Panel Features
- Using Printer Control Panel Menus
- Using the Printer Control Panel in Shared Environments
- Changing Printer Control Panel Configuration Settings

Note

Unless otherwise specified, “control panel” refers to the printer’s control panel. Keys on the control panel are indicated by the **KEY** font.

When to Use the Printer Control Panel

Hewlett-Packard has designed the printer control panel to facilitate making printing selections when your software does not provide them.

Use the printer control panel for overall configuration requirements, to obtain printer status information, and to perform the following procedures:

- configure input trays for media type and size
- take the printer online or offline
- print configuration pages and menu maps
- change printer default settings
- verify available fonts

Software applications that provide commands for selecting printing options allow you to control print jobs through the software application rather than by changing control panel settings at the printer. The degree of control varies among applications. Software commands override printer control panel settings for all Print Menu and most Configuration Menu items.

Note

For information about controlling the printer in a network environment, see the *HP JetDirect Print Server Software Installation Guide*. Also, see the online Help files provided with HP JetAdmin software and the HP LaserJet utility.

Locating Printer Control Panel Features

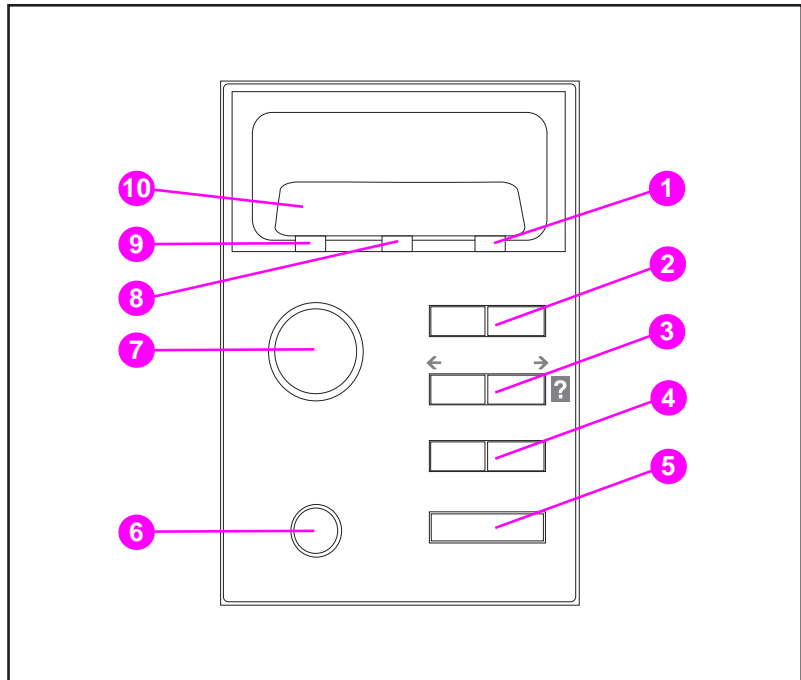

Figure 2-1 Printer Control Panel

- 1 Attention Indicator Light
- 2 Menu Key*
- 3 Item Key*
- 4 Value Key*
- 5 Select Key
- 6 Cancel Job Key
- 7 Go Key
- 8 Data Indicator Light
- 9 Ready Indicator Light
- 10 Printer Control Panel Display

*Rocker keys

Note

The Item key is also used to navigate through the online Help system.

Using Printer Control Panel Keys

The following table summarizes the function of each printer control panel key.

Key	Function
GO	Dependent upon the status of the printer. Normally, Go activates printing using current settings or directs the printer to proceed with the process designated on the control panel. If the printer is offline, pressing Go will return the printer to the READY state.
CANCEL JOB	Terminates the job that is currently printing. The printer stops and purges all input until a new job is detected.
MENU	Displays a menu system for obtaining printer status information or changing the printer's configuration settings.
ITEM	Cycles through items in the selected menu. Menu items vary depending on the options installed and on the configuration of other menu choices. The ITEM key is also used to navigate through the printer's online Help system.
VALUE	Cycles through the value choices for a particular menu item.
SELECT	Selects the value that is currently shown on the display.

Using the Printer Online Help System

This printer features an online Help system that provides instructions for resolving most printer errors. Certain control panel error messages alternate with instructions on accessing the online help system.

Whenever a ? appears in an error message, or a message alternates with "FOR HELP PRESS THE ? KEY," press the **ITEM** key to navigate through a sequence of instructions.

Note

To exit the online Help system, press either **Go** or **SELECT**.

Interpreting Control Panel Indicator Lights

The following table explains the meaning of the printer control panel indicator lights.

Indicator	On	Off	Flashing
Ready (green)	Printer is online (able to accept and process data).	Printer is offline.	Printer is attempting to stop printing and go offline.
Data (green)	Processed data is present in the printer, but more data is needed to complete the job.	No data is being received or processed.	Data is being received and processed by the printer.
Attention (amber)	A critical error has occurred. Printer requires attention.	No conditions exist that require attention.	An error has occurred. Printer requires attention.

Using Printer Control Panel Menus

The printer control panel menus allow you to change printer settings and to access printer status information. This section outlines the printer control panel menus and the selections available within each menu.

Menu Locking

Menu selections can be locked out by a system administrator. If you are unable to access a particular menu, contact your system administrator.

Information Menu

The Information Menu selections are used for accessing and printing specific printer information.

Menu Item	Description
PRINT MENU MAP	Prints the control panel menu map.
PRINT CONFIGURATION	Prints the printer configuration page.
PRINT CONFIG CONTINUOUS	Continuously prints the configuration page until CANCEL JOB is pressed.
PRINT FONT LIST	Prints the available PCL and PS (emulated PostScript) font samples.
SHOW EVENT LOG	Prints a historical list of printer events.
REMAINING LIFE	Displays the projected remaining life for the Transfer Belt, Fuser, and Imaging Drum.

Printing a Menu Map

Printing a menu map can help you navigate through control panel menus. See the menu map sample that follows.

To print a menu map

- 1 On the printer control panel, press **MENU** until INFORMATION MENU displays.
- 2 Press **ITEM** until PRINT MENU MAP displays.
- 3 Press **SELECT** to print the menu map. After printing the menu map, the printer will return to the READY state.

Interpreting the Menu Map

The following sample illustrates a menu map.

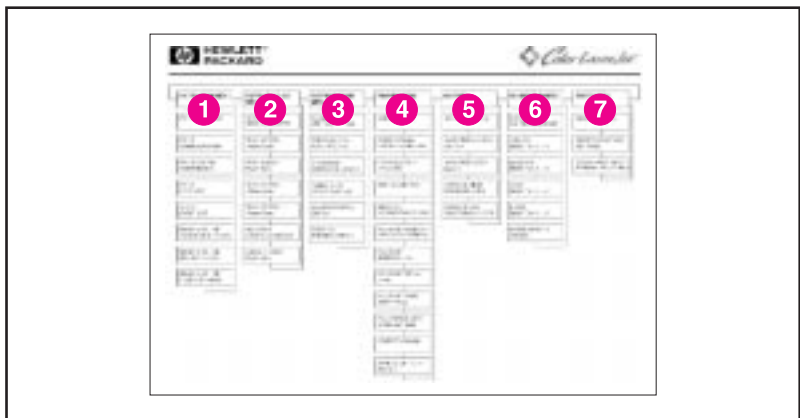

Figure 2-2

Menu Map

- 1 Information Menu
- 2 Paper Handling Menu
- 3 Configuration Menu
- 4 Printing Menu
- 5 I/O Menu
- 6 Calibration Menu
- 7 Resets Menu

Printing a Printer Configuration Page

Printing out a printer configuration page can help you verify that the printer is configured properly. This can be useful in troubleshooting printer problems.

To print a printer configuration page

- 1 On the printer control panel, press **MENU** until INFORMATION MENU displays.
- 2 Press **ITEM** until PRINT CONFIGURATION displays.
- 3 Press **SELECT** to print the configuration page. The printer will return to the READY state.

Note

If the printer is configured with EIO cards (for example, an HP JetDirect Print Server), an additional configuration page will print that provides interface configuration information.

Interpreting the Printer Configuration Page

The following sample illustrates a printer configuration page.

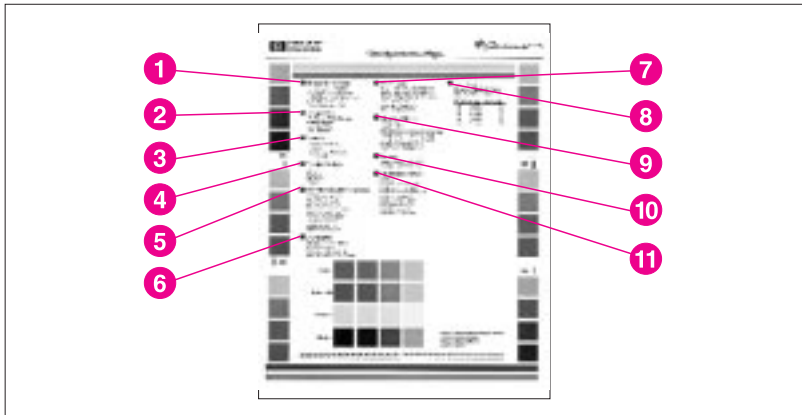

Figure 2-3 Printer Configuration Page

- 1 **Printer Information**—Lists the printer serial number, PCL/PS firmware revision, total number of pages printed during the life of the printer, and total number of color pages printed during the life of the printer.
- 2 **Consumables: % of Life Remaining**—Lists the percentage of the estimated remaining life for the transfer kit, fuser kit, and the drum kit.
- 3 **Security**—Shows whether the printer control panel is locked or unlocked. Also shows whether the printer control panel password is enabled or disabled.
- 4 **Density Settings**—Lists the current density settings.
- 5 **Configuration Menu**—Lists the current settings of the configuration menu items.
- 6 **I/O Menu**—Lists the current settings of the I/O menu items.
- 7 **Paper Trays**—Lists the size and type of media currently configured for each input tray. Also lists the current Tray 1 mode, A4/letter override setting, and default size setting.
- 8 **Installed Options**—Lists installed options such as EIO cards, DIMMs, duplex printing accessory, and 500-sheet paper feeder.
- 9 **Memory**—Shows the total memory installed and the total memory available in the printer. Also lists the memory allocation settings.
- 10 **Printing Menu**—Lists the current settings of the printing menu items.
- 11 **Event Log**—Lists the last five printer events, including printer jams, service errors, and other printer conditions.

Paper Handling Menu

The Paper Handling Menu allows you to configure input trays by size and type. This menu can also be used to set the default media size and type.

Note

The default mode for Tray 1 is TRAY 1 MODE=FIRST. In this mode, if media is loaded in Tray 1, and no other tray is requested, the printer will pull media from Tray 1 regardless of the size and type of media loaded in the tray. To configure Tray 1 by size or type, it must be configured as TRAY 1 MODE=CASSETTE.

Menu Item	Values
TRAY 1 MODE	FIRST* CASSETTE
TRAY 1 SIZE (appears only if Tray 1 mode is set to TRAY 1 MODE=CASSETTE)	LETTER*/A4** LEGAL EXEC JIS B5 A5 CUSTOM B5 COM10 C5 DL MONARC
TRAY 1 TYPE (appears only if Tray 1 mode is set to TRAY 1 MODE=CASSETTE)	PLAIN* PREPRINTD LTRHEAD TRNSPRNCY GLOSS PREPUNCHD LABELS BOND RECYCLED COLOR HEAVY CARDSTOCK
TRAY 2 TYPE	(same choices as TRAY 1 TYPE except LABELS and CARDSTOCK)
TRAY 3 TYPE	(same choices as TRAY 1 TYPE except LABELS and CARDSTOCK)
A4/LETTER OVERRIDE	NO* YES
DEFAULT SIZE	(same choices as TRAY 1 SIZE)

*Denotes default setting

**In certain countries/regions, A4 is the default setting

Configuration Menu

The Configuration Menu is used to set general printer default settings.

CAUTION

Hewlett-Packard recommends that configuration settings only be changed by a system administrator. Configuration settings seldom need to be changed.

Menu Item	Values	Description
POWERSAVE	OFF 1 MIN (used for troubleshooting) 30 MIN 1 HR* 2 HRS 4 HRS 8 HRS	The length of time before the printer goes into power-saving mode.
PERSONALITY	AUTO* PCL PS	The personality (language) the printer uses to process a print job.
CLEARABLE WARNINGS	JOB* ON	If ON, message is displayed until Go is pressed. If JOB, message is displayed until end of print job.
AUTO CONTINUE	ON* OFF	Determines whether the printer continues printing when certain errors occur. If ON, printer returns to the READY state. If OFF, printer remains offline until Go is pressed.
TONER LOW	CONTINUE* STOP	Determines whether the printer continues or stops printing when a TONER LOW condition is detected.
TONER OUT	STOP* OVERRIDE	Determines whether the printer continues printing when Go is pressed after a TONER OUT condition is detected.
JAM RECOVERY	OFF* ON	Printer attempts to recover from jams and reprints affected pages.
PRINT PS ERRORS	OFF* ON	Prints out an error page when emulated PostScript errors occur.

*Denotes default setting

Printing Menu

The Printing Menu is used to set default settings for a specific print job.

Menu Item	Values	Description
COPIES	1 to 999 (default:1)	Number of copies.
ORIENTATION	PORTRAIT* LANDSCAPE	Determines the default page orientation.
FORM LENGTH	5 to 128 lines (default: 60)	Maximum lines on a page before a formfeed occurs.
DUPLEX ¹	OFF* ON	Enables two-sided printing.
BINDING ²	LONG EDGE* SHORT EDGE	Prints pages for specified binding type.
PCL FONT SOURCE	INTERNAL* SOFT SLOT n (n = 1,2,3)	Instructs the printer where to look for PCL fonts.
PCL FONT NUMBER	0 to 999 (default: 0)	Specifies a default PCL font number.
PCL FONT PITCH ³	0.44 to 99.99 (default: 10)	Specifies a default pitch for PCL fonts.
PCL FONT POINT SIZE ⁴	4 to 999.75 (default: 12)	Specifies a default font size for PCL fonts.
PCL SYMBOL SET	PC-8 (default)	Used to select an appropriate symbol set. See the appendix on PCL commands.
COURIER	REGULAR* DARK	Dark Courier was used in older LaserJet printers.
APPEND CR TO LF	NO* YES	Appends a carriage return to each line feed character in the data stream. (UNIX)

*Denotes default setting

¹Only displays when the Duplex Printing Accessory is attached

²Only displays when DUPLEX is selected

³Only displays when a fixed space font is specified

⁴Only displays when a proportional space font is specified

I/O Menu

The I/O Menu allows you to make changes to printer interface settings. The following table lists the selections that appear for each item in this menu. (See chapter 6 for additional information.)

Menu Item	Values	Description
I/O TIMEOUT	5 to 300 SECONDS (default: 15)	Amount of time the printer waits to receive data before switching to another port.
I/O BUFFER	AUTO* OFF ON	Allocates memory to I/O ports.
I/O BUFFER SIZE ¹	nnnnnK (default: 100K)	Amount of memory allocated to the I/O ports.
PARALLEL HIGH SPEED	YES* NO	Allows faster parallel communications supported by newer computers.
PARALLEL ADV FUNCTIONS	ON* OFF	Turns bidirectional parallel communication on and off.

*Denotes default setting

¹Only appears if I/O BUFFER is ON

EIO Menu

If an Enhanced Input Output (EIO) card (for example, an HP JetDirect Print Server) has been installed in the printer, an additional menu is available. This additional menu provides a way to configure the EIO accessory and to adjust network interface settings. For information on HP JetDirect EIO menus, see the *HP JetDirect Print Server Software Installation Guide*. This guide is included with the HP Color LaserJet 4500 N and 4500 DN printers and is also available through HP Direct. (For ordering information, see Appendix D.)

Calibration Menu

This printer features automatic, internal calibration to produce optimum color for most print jobs. The Calibration Menu provides fine-tuning for critical color-matching requirements.

For information on using this menu for setting toner densities, see chapter 4.

CAUTION

Calibrating toner densities changes the color balance of your printer by altering halftones. It affects all print jobs. Notify your network administrator before performing this procedure.

Menu Item	Values	Description
PRINT CALIBRATION PAGE		Prints out the color calibration page.
CYAN DENSITY	-5 to +5 (default: 0)	Used for increasing or decreasing cyan toner density.
MAGENTA DENSITY	-5 to +5 (default: 0)	Used for increasing or decreasing magenta toner density.
YELLOW DENSITY	-5 to +5 (default: 0)	Used for increasing or decreasing yellow toner density.
BLACK DENSITY	-5 to +5 (default: 0)	Used for increasing or decreasing black toner density.
RESET DENSITY VALUES		Resets density values back to default settings. Press SELECT to reset values.

Resets Menu

The Resets Menu is used for resetting the printer's memory and for returning the printer to its factory default settings. It is also used to clear maintenance messages following the replacement of certain consumable items.

Menu Item	Description
RESET MEMORY	Resets the printer to user-specified default settings.
RESTORE FACTORY SETTINGS	Resets the printer to factory default settings.
NEW TRANSFER KIT SELECT IF DONE	Clears the maintenance message after the transfer kit has been replaced.
NEW FUSER KIT SELECT IF DONE	Clears the maintenance message after the fuser kit has been replaced.

Using the Printer Control Panel in Shared Environments

The printer control panel functions essentially the same in shared printer environments as it does when connected to a standalone computer. If problems occur, contact your network administrator.

Because your printer is shared with other users, adhering to the following guidelines will help ensure successful printer operation:

- Consult your system administrator before making changes to control panel settings. Changing control panel settings could affect other print jobs.
- Coordinate with other users before changing the default printer font and downloading soft fonts. Coordinating these operations conserves memory and avoids unexpected printer output.
- Be aware that switching printer personalities, such as Emulated PostScript or PCL, affects the printed output of other users.

Note

Your network operating system may automatically protect each user's print job from the effects of other print jobs. Consult your system administrator for more information.

Changing Printer Control Panel Configuration Settings

By using the printer control panel, you can make changes to general printer configuration default settings such as PowerSave, printer personality (language) and jam recovery.

CAUTION

Hewlett-Packard recommends that configuration settings be changed only by a system administrator. Configuration settings very seldom need to be changed.

To change printer control panel configuration settings

- 1 Press **MENU** until CONFIGURATION MENU displays.
- 2 Press **ITEM** until the item that you want to change displays.
- 3 Press **VALUE** until the appropriate setting displays.
- 4 Press **SELECT** to save the setting.
- 5 Press **GO** to return the printer to the READY state.

Changing PowerSave Settings

The adjustable PowerSave feature reduces power consumption when the printer has been inactive for an extended period. The printer display dims when the printer is in PowerSave mode. You can set the length of time before the printer goes into PowerSave mode to OFF, 1 minute, 30 minutes or to 1, 2, 4, or 8 hours. The default setting is 1 hour.

To change PowerSave setting

- 1 Press **MENU** until CONFIGURATION MENU displays.
- 2 Press **ITEM** until POWERSAVE displays.
- 3 Press **VALUE** until the appropriate setting displays.
- 4 Press **SELECT** to save the setting.
- 5 Press **GO**. The printer will return to the READY state within a few minutes.

If you want to disable PowerSave, select OFF in step 3.

Note

This printer qualifies as ENERGY STAR compliant, as determined by the U.S. Environmental Protection Agency (EPA).

Switching Printer Personalities

This printer features automatic personality (printer language) switching. In AUTO mode, the printer automatically detects the type of print job and configures its personality to accommodate that job. You also can change the personality mode to either PCL or PostScript Emulation (PS).

To switch printer personality

- 1 Press **MENU** until CONFIGURATION MENU displays.
- 2 Press **ITEM** until PERSONALITY displays.
- 3 Press **VALUE** until the appropriate setting displays.
- 4 Press **SELECT** to save the setting.
- 5 Press **GO** to return the printer to the READY state.

Setting the I/O Timeout

I/O Timeout sets the number of seconds that the printer waits to receive additional data from the computer before switching I/O ports. The default setting for the printer is 15 seconds.

Note

Setting the I/O Timeout too high may cause a single I/O port to remain active and prohibit data from being received through other ports. Setting I/O Timeout too low may result in missing characters, out-of-order print jobs, or other print problems.

To set the I/O Timeout

- 1 Press **MENU** until I/O MENU displays.
- 2 Press **ITEM** until I/O TIMEOUT displays.
- 3 Press **VALUE** to increase or decrease the I/O Timeout value. Holding the key down will change the value more quickly.
- 4 Press **SELECT** to save the setting.
- 5 Press **GO** to return the printer to the READY state.

Disabling the High-Speed Parallel Interface

This printer features a high-speed, bi-directional parallel interface. The interface supports high and low speed access. The high-speed access may not be compatible with some computers. Through the I/O Menu, you can enable and disable high speed parallel interface. The default setting is enabled.

To disable the high speed parallel interface

- 1 Press **MENU** until I/O MENU displays.
- 2 Press **ITEM** until PARALLEL HIGH SPEED displays.
- 3 Press **VALUE** until NO displays. (To enable high-speed parallel interface, set the value to YES.)
- 4 Press **SELECT** to save the setting.
- 5 Press **GO** to return the printer to the READY state.

Setting Advanced Functions

This printer supports bidirectional parallel communication. You can turn this feature on and off through the I/O Menu.

To enable bidirectional parallel communication

- 1 Press **MENU** until I/O MENU displays.
- 2 Press **ITEM** until PARALLEL ADV FUNCTIONS displays.
- 3 Press **VALUE** until ON displays.
- 4 Press **SELECT** to save the setting.
- 5 Press **GO** to return the printer to the READY state.

Resetting Printer Memory

CAUTION

Resetting memory clears the page buffer, removes downloaded fonts and macros, and returns all print menu settings to user-selected defaults.

To reset printer memory

- 1 Press **MENU** until RESETS MENU displays.
- 2 Press **ITEM** until RESET MEMORY displays.
- 3 Press **SELECT**. RESETTING MEMORY appears on the printer control panel display, and then the printer automatically returns to the READY state.

Resetting the Printer to Factory Default Settings

Resetting the printer to factory default settings can be useful when you are troubleshooting with the printer.

CAUTION

Resetting factory defaults clears the page buffer, removes downloaded fonts and macros, and returns all print menu settings to factory defaults.

To reset the printer to factory default settings

- 1 Press **MENU** until RESETS MENU displays.
- 2 Press **ITEM** until RESTORE FACTORY SETTINGS displays.
- 3 Press **SELECT** until the following message appears:

RESTORING
FACTORY SETTINGS

This message displays until the printer has completed the initialization process. The printer automatically returns to the READY state.

3 Common Printing Tasks

Overview

This chapter helps you perform common printing tasks. The chapter includes the following sections:

- Selecting Print Media
- Printing on Special Media
- Controlling Print Jobs
- Configuring Input Trays
- Printing from Tray 1 (Multipurpose Tray)
- Printing from Tray 2
- Printing from Tray 3 (optional 500-Sheet Paper Feeder)
- Using the Duplex Printing Accessory for Two-Sided Printing
- Special Printing Situations
- Stopping a Print Request

Selecting Print Media

You can use many types of paper and other print media with this printer. This section provides guidelines and specifications for selecting and using different print media.

Before purchasing any media or specialized forms in quantity, verify that your paper supplier obtains and understands the print media requirements specified in the *HP LaserJet Family Paper Specification Guide*. The guide is available through HP Direct. See Appendix D for ordering information.

It is possible that media could meet all of the guidelines in this chapter and still not print satisfactorily. This may be due to abnormal characteristics of the printing environment or to other variables over which Hewlett-Packard has no control (for example, extremes in temperature and humidity).

Hewlett-Packard recommends testing any media before buying it in large quantities.

CAUTION

Using media that does not conform to the specifications listed here or in the paper specification guide can cause problems that require service. This service is not covered by the Hewlett-Packard warranty or service agreements.

Supported Media Weights and Sizes

For optimum results, use conventional 75 g/m² (20 lb) xerographic paper. Verify that the paper is of good quality and is free of cuts, nicks, tears, spots, loose particles, dust, wrinkles, curls, or bent edges.

Tray	Supported Media	Media Specifications	Capacity
Tray 1	Paper A4/Letter Legal Executive JIS B5 A5 Custom Minimum Size: 76 x 127 mm (3 x 5 in) Maximum Size: 216 x 356 mm (8.5 x 14)	Single-sided: 60 to 159 g/m ² (16 to 42 lb) Two-sided: 64 to 105 g/m ² (17 to 28 lb)	150 sheets of 75 g/m ² (20 lb) paper Do not load more than the maximum stack height of 15 mm (0.6 in).
	Transparencies Glossy Paper	0.13 mm (5 mil) 120 g/m ² (32 lb/80 lb text)	Limit of 50 Limit of 50 sheets
	Envelopes (Tray 1 only) Com10 Monarch C5 DL B5 (JIS)	Maximum weight: 90 g/m ² (24 lb)	Limit of 10
	Labels (Tray 1 only)		Limit of 50
	Cardstock (Postcards) (Tray 1 only)	Maximum weight: 176 g/m ² (47 lb) Maximum size: 200mm x 148mm (7.87 in x 5.82 in)	Do not load more than the maximum stack height of 15 mm (0.6 in)

Tray	Supported Media	Media Specifications	Capacity
Tray 2	Paper A4/Letter Legal Executive JIS B5 A5 Custom (B5 ISO)*	60 to 105 g/m ² (16 to 28 lb)	250 sheets of 75 g/m ² (20 lb) paper
	Transparencies Glossy Paper	0.13 mm (5 mil) 120 g/m ² (32 lb/80 lb text)	Limit of 50 Limit of 200 sheets
Tray 3 (optional)	Paper A4/Letter Legal Executive JIS B5 Custom (B5 ISO)*	60 to 105 g/m ² (16 to 28 lb)	500 sheets of 75 g/m ² (20 lb) paper
	Transparencies Glossy Paper	0.13 mm (5 mil) 120 g/m ² (32 lb/80 lb text)	Limit of 50 Limit of 500 sheets
Duplex Printing Accessory (optional)	Paper A4/Letter Legal Executive JIS B5	64 to 105 g/m ² (17 to 28 lb)	

*Trays 2 and 3 use "Custom" size specifically for B5 ISO. Trays 2 and 3 do not support the range of custom sizes available in Tray 1.

Media to Avoid

Use the following guidelines to avoid poor print quality or damage to your printer:

- Do not use paper that is too rough.
- Do not use paper that is embossed or coated unless it is specifically recommended for use in this printer.
- Do not use paper with cutouts or perforations other than standard 3-hole punched paper.
- Do not use multipart forms.
- Do not use paper with irregularities such as tabs or staples.
- Do not use letterhead paper with low temperature dyes or thermography. Preprinted forms or letterhead must use inks that can tolerate temperatures of 190° C (374° F) for 0.1 second.
- Do not use any media that produces hazardous emissions, or that melts, offsets, or discolors when exposed to 190° C (374° F) for 0.1 second.
- Do not use paper that has already been printed on or that has been fed through a photocopier.
- Do not use paper with a watermark if you are printing solid patterns.

Printing on Special Media

Use these guidelines when printing on special types of media.

Printing on Transparencies

When printing on transparencies, use the following guidelines:

CAUTION

To prevent transparencies from bonding together, always send them to the top output bin.

- Handle transparencies using the edges. Oils from your fingers that are deposited on the transparency can cause print quality problems.

CAUTION

Use only overhead transparencies recommended for use in this printer. Hewlett-Packard recommends using HP Color LaserJet Transparencies with this printer. HP products are designed to work together for optimum printing results.

Printing on Glossy Paper

When printing on glossy paper, select the glossy print setting in the printer driver. You can also use the printer control panel to set the media type to GLOSS for the input tray you are using. Because this affects all print jobs, it is important to return the printer back to its original settings once your job has printed. See the section later in this chapter on configuring input trays.

Printing on Colored Paper

Colored paper should be of the same high quality as white xerographic paper. Pigments used must be able to withstand the printer's fusing temperature of 190° C (374° F) for 0.1 second without deterioration. Do not use paper with a colored coating that was added after the paper was produced.

The printer creates colors by printing patterns of dots, overlaying and varying their spacing to produce various colors. Varying the shade or color of your paper will affect the shades of your printed colors.

Printing Envelopes

Note

Envelopes can only be printed from Tray 1. Hewlett-Packard recommends configuring Tray 1 as a cassette and setting the tray's media type to the specific envelope size. See the section later in this chapter on loading envelopes.

Adhering to the following guidelines will help ensure proper printing of envelopes and help prevent printer jams:

- Do not load more than 10 envelopes into Tray 1.
- The weight rating of envelopes should not exceed 90 g/m² (24 lb).
- Envelopes should be flat.
- Do not use envelopes with windows or clasps.
- Envelopes must not be wrinkled, nicked, or otherwise damaged.
- Envelopes with peel-off adhesive strips must use adhesives that can withstand the heat and pressures of the printer's fusing process.
- Envelopes should be loaded with the flaps facing away from the printer and toward the right side of the printer.

Printing on Labels

Note

For printing labels, Hewlett-Packard recommends configuring Tray 1 as a cassette and setting the tray's media type to LABELS in the printer control panel. See the section later in this chapter on configuring input trays.

When printing labels, use the following guidelines:

- Verify that the labels' adhesive material can tolerate temperatures of 190° C (374° F) for 0.1 second.
- Verify that there is no exposed adhesive material between the labels. Exposed areas can cause labels to peel off during printing, which can cause printer jams. Exposed adhesive can also cause damage to printer components.
- Do not re-feed a sheet of labels.
- Verify that labels lie flat.
- Do not use labels that are wrinkled, bubbled, or otherwise damaged.

Heavy Paper

Use Tray 1 for paper that is heavier than 105 g/m² (28 lb). For optimum results when printing on heavy paper, use the printer control panel to configure Tray 1 as a cassette and then set the media type for the tray to HEAVY. Because this affects all print jobs, it is important to return the printer back to its original settings once your job has printed. See the section later in this chapter on configuring input trays.

CAUTION

Do not use paper that is heavier than the media specification recommended for this printer. Doing so can cause misfeeds, paper jams, reduced print quality, and excessive mechanical wear.

Preprinted Forms and Letterhead

Observe the following guidelines for best results with preprinted forms and letterhead:

- Forms and letterhead must be printed with heat-resistant inks that will not melt, vaporize, or release hazardous emissions when subjected to the printer's fusing temperature of approximately 190° C (374° F) for 0.1 second.
- Inks must be non-flammable and should not adversely affect any printer rollers.
- Forms and letterhead should be sealed in a moisture-proof wrapping to prevent changes during storage.
- Before you load preprinted paper such as forms and letterhead, verify that the ink on the paper is dry. During the fusing process, wet ink can come off of preprinted paper.

Recycled Paper

This printer supports the use of recycled paper. Recycled paper must meet the same specifications as standard paper. (See the *HP LaserJet Family Paper Specification Guide*.) The guide is available through HP Direct. See Appendix D for ordering information. Hewlett-Packard recommends that recycled paper contain no more than 5 percent ground wood.

Controlling Print Jobs

Among the aspects of a print job that you can control are the tray from which the printer pulls media, the bin to which you send the job, and the configuration for type and size of media for each tray. You can control print jobs through the printer driver, your software application, or the printer control panel.

CAUTION

To avoid affecting print jobs of other users, whenever possible, make printer setup changes through your software application or the printer driver. Printer setup changes made through the control panel become default settings for subsequent jobs. Changes made through an application or printer driver affect only that specific job.

Selecting Output Bins

This printer has two media output bins. The position of the door to the rear output bin determines the bin used: If the door to the rear output bin is open, media is directed to that bin. If it is closed, media is directed to the top output bin. There are no driver or software options for selecting an output bin. Figure 3-1 illustrates the top and rear output bins.

- The top output bin holds up to 250 sheets of standard paper in correct order, facing down. When the bin is full, a sensor directs the printer to stop printing. Printing resumes when you remove paper from the bin.
- The rear output bin holds up to 100 sheets of standard paper in reverse order, facing up. When the door to the rear output bin is open, media is directed to this bin. When this door is closed, media is directed to the top output bin. Because there is no sensor at this output bin, you should monitor the bin and empty it when it is full.

Note

If the rear output bin is open, duplex printing is not possible. Close the rear output bin when duplex printing.

When printing on transparencies, close the rear output bin. This causes the transparencies to be sent to the top output bin and reduces the risk of jamming.

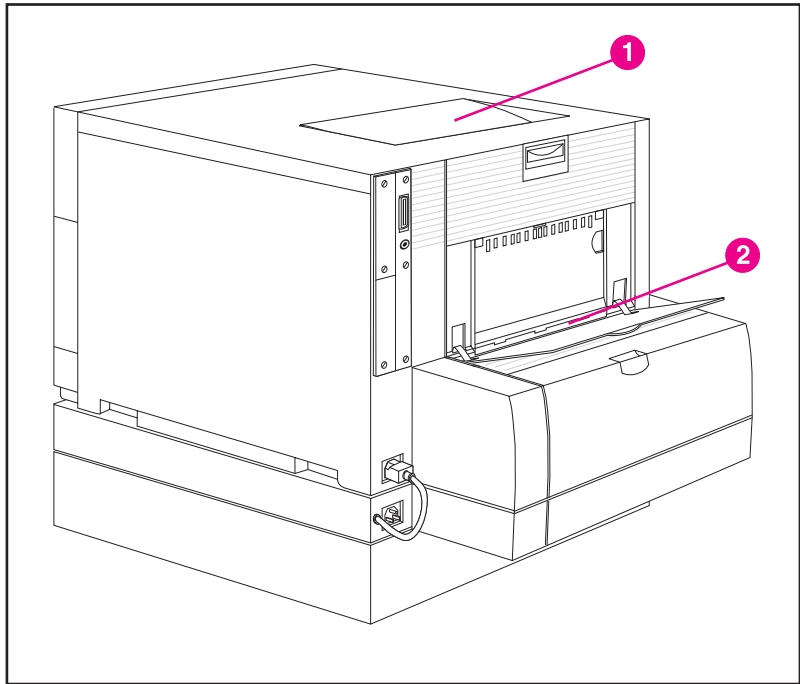

Figure 3-1 Rear view (shown with the optional 500-sheet paper feeder and duplex printing accessory)

- 1 Top Output Bin
- 2 Rear Output Bin

Selecting Media by Type

If you want to select media for your job by type of media rather than by the input tray (source), you must first configure a printer tray for the media type you are using, and then specify that media type in the printer driver.

Selecting media by type rather than source is similar to locking out trays and helps protect special media from accidental use. For example, if a tray is configured for letterhead, and you specify in your driver to print on plain paper, the printer will not pull the letterhead from that tray. Instead, it will pull from a tray that has plain paper loaded and that has been configured for plain paper on the printer control panel.

Configuring Input Trays

This printer allows you to configure input trays by type and size. This allows you to load different media types and sizes in the printer's input trays and then request media by type or size.

- When the printer is used as a standalone printer, it might be beneficial to configure the printer as TRAY 1 MODE=FIRST. In this mode, if media is loaded in Tray 1 and no other tray is specified, media will be pulled from Tray 1 regardless of the type or size of media loaded in the tray.
- When the printer is used in a network environment, it might be beneficial to configure Tray 1 as TRAY 1 MODE=CASSETTE. In this mode, the tray acts as a cassette-style tray and can then be configured for media type and size.

Note

When Tray 1 is in FIRST mode, be sure that the media loaded meets the specifications for duplex printing. (See the supported media weights and sizes section earlier in this chapter.)

Configuring Tray 1 as a Cassette

Tray 1 is designed to accommodate printing on a variety of media types.

To configure Tray 1 as a cassette

- 1 Press **MENU** until PAPER HANDLING MENU displays.
- 2 Press **ITEM** until TRAY 1 MODE displays.
- 3 Press **VALUE** until CASSETTE displays.
- 4 Press **SELECT** to save the setting.
- 5 Press **ITEM** until TRAY 1 SIZE displays.
- 6 Press **VALUE** until the proper media size displays.
- 7 Press **SELECT** to save the setting.
- 8 Press **ITEM** until TRAY 1 TYPE displays.
- 9 Press **VALUE** until the proper media type displays.
- 10 Press **SELECT** to save the setting.
- 11 Press **GO** to return the printer to the READY state.

Configuring Trays 2 and 3 by Media Type

Trays 2 and 3 are cassette-style trays. You can select them by media size and type through your software application or the printer driver.

Note

Tray 2 has an internal media-size sensor and does not need to be configured on the printer control panel for media size. The media-size knob on the side of Tray 3 must be set to the correct media size.

To configure Trays 2 or 3

- 1 Press **MENU** until PAPER HANDLING MENU displays.
- 2 Press **ITEM** until TRAY 2 TYPE displays (or TRAY 3 TYPE when configuring Tray 3).
- 3 Press **VALUE** until the proper media type displays.
- 4 Press **SELECT** to save the setting.
- 5 Press **GO** to return the printer to the READY state.

Tray Priority

When all trays have the same size and type media loaded, the printer pulls media from input trays in the following order:

When Tray 1 is configured as TRAY 1 MODE=FIRST

- Tray 1
- Tray 3 (if attached)
- Tray 2

When Tray 1 is configured as TRAY 1 MODE=CASSETTE

- Tray 3 (if attached)
- Tray 2
- Tray 1

Printing from Tray 1 (Multipurpose Tray)

Tray 1, the multipurpose tray, can print on all supported sizes and types of media and envelopes.

Loading Media into Tray 1

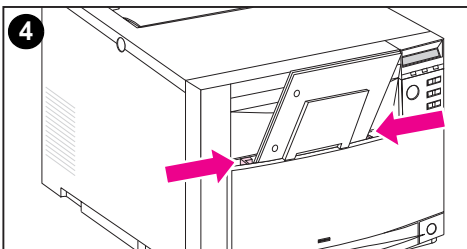
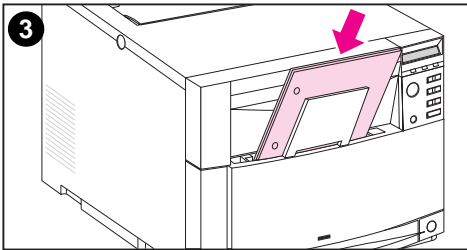
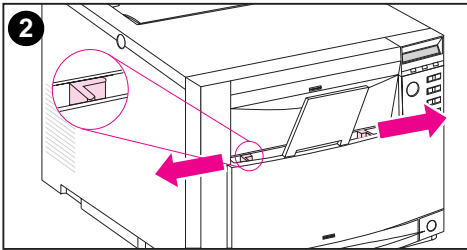
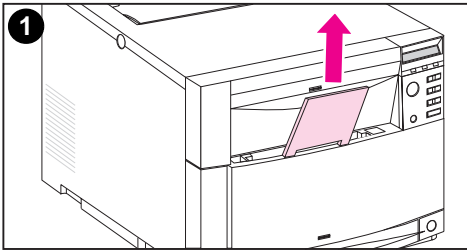

To load media into Tray 1

CAUTION

To avoid jams, never add or remove media from a tray during printing. To avoid damaging the printer, place labels and paper heavier than 105 g/m² (28 lb) only in Tray 1.

- 1 Pull up the tray extension.
- 2 Slide the media-width guides all the way open.
- 3 Load media into the tray with the side to be printed facing the printer. Slide the media in until it sits squarely in the bottom of the tray.
- 4 Slide the media-width guides in until they hold the media firmly in place without bending it.

Note

For proper paper feeding, custom media must be at least 76 mm (3 in) wide and 127 mm (5 in) long.

Note

Load prepunched paper with the holes toward the side of the printer as illustrated. For two-sided printing, load media with the front side facing away from the printer.

Loading Envelopes into Tray 1

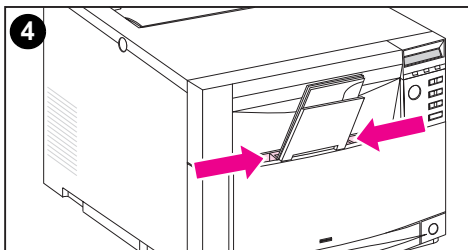
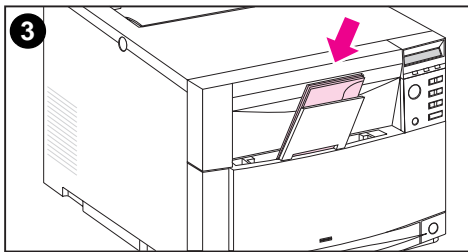
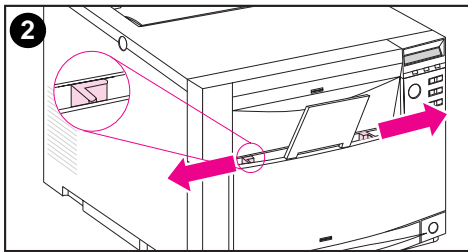
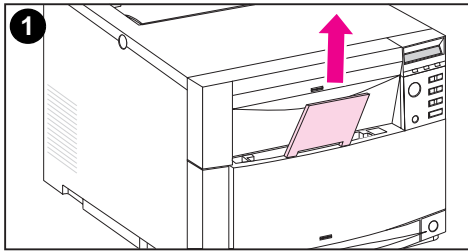

Envelopes can only be printed from Tray 1. This tray holds up to 10 envelopes. For envelope specifications, see the “Supported Media Weights and Sizes” section earlier in this chapter.

To load envelopes into Tray 1

CAUTION

To avoid jams, do not remove or insert envelopes during printing.

- 1 Pull up the tray extension.
- 2 Slide the media-width guides all the way open.
- 3 Load up to 10 envelopes into Tray 1 with their back flap facing away from the printer. Slide the envelopes in until they sit squarely in the bottom of the tray as illustrated.
- 4 Slide the media-width guides in until they hold the envelopes firmly in place without bending them.

Printing envelopes when TRAY 1 MODE=CASSETTE

For the best results when printing envelopes, Tray 1 should be configured as TRAY 1 MODE=CASSETTE and media size should be set to the size corresponding to the envelopes you are printing on.

- 1 Set the media size for Tray 1 in the printer control panel. (See “Configuring Tray 1” earlier in this chapter.)
- 2 Specify Tray 1 or select media source by size (for example, COM 10 or DL).
- 3 If your software does not automatically format an envelope, specify Landscape for page orientation in your software application or printer driver. Use the following guidelines to set margins for return and destination addresses on Commercial #10 or DL envelopes.

Address Type	Left Margin	Top Margin
Return	15 mm (0.6 in)	15 mm (0.6 in)
Destination	102 mm (4.0 in)	51 mm (2.0 in)

Note

For envelopes of other sizes, adjust the margin settings appropriately.

- 4 Select **Print** from the software application or printer driver.

Printing envelopes when TRAY 1 MODE=FIRST

If Tray 1 is configured as TRAY 1 MODE=FIRST (default), select Tray 1 or use autoselect and then print the file from your software application or the printer driver. In this mode, the printer will pull media from the tray regardless of the size and type of media loaded. If your software does not automatically format an envelope, follow the instructions provided in the previous section.

Printing from Tray 2

Tray 2 holds up to 250 sheets of standard paper. The tray adjusts for Letter, Legal, A4, A5, JIS B5, Custom (B5 ISO), and Executive paper. The printer automatically detects the media size in Tray 2 based on the tray's paper guide configuration.

Loading Media into Tray 2

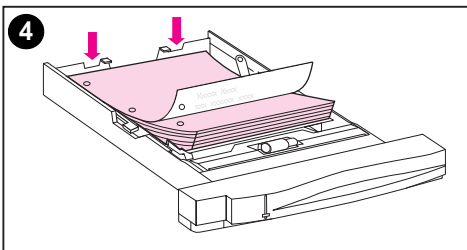
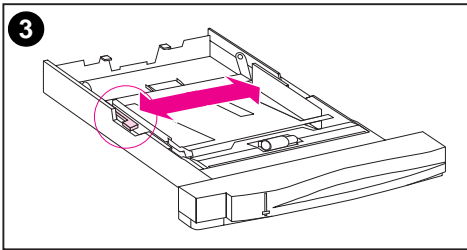
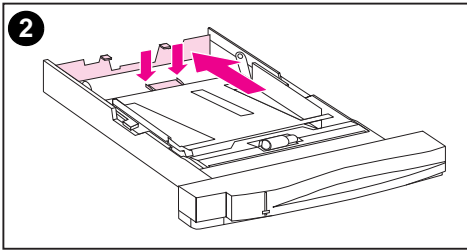
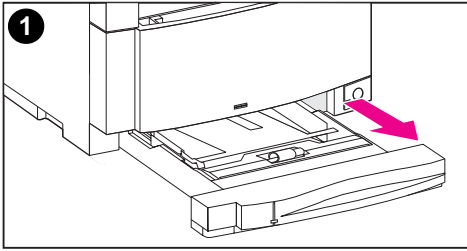

To load media into Tray 2

CAUTION

Do not print cardstock, labels, envelopes, and unsupported sizes of media from Tray 2. These media types should be printed only from Tray 1.

Do not overfill the input tray. Overfilling trays can cause jams in the printer.

To avoid causing jams, never open the tray while it is in use.

- 1 Remove Tray 2 from the printer and place it on a flat surface.
- 2 Set the rear media-length guide by squeezing the guide adjustment latch and sliding the back of the tray to the length of media you are loading.
- 3 Slide the media-width guides all the way open by squeezing the release latch.
- 4 Load media with the print side facing down into the tray.

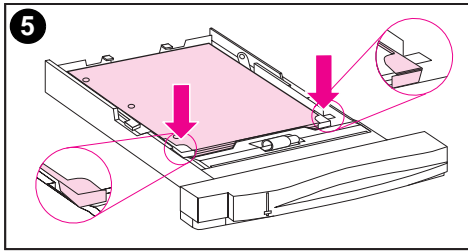

5 Verify that media lies flat in the tray and that it fits under the metal tabs.

6 Slide the media-width guides in until they hold the media firmly in place without bending it.

7 Insert Tray 2 into the printer.

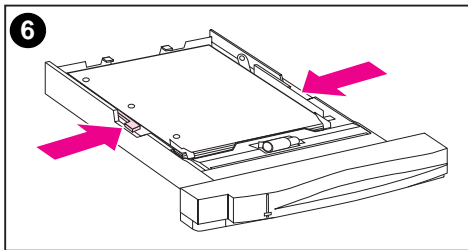

Note

Load prepunched paper as illustrated. For two-sided printing, load media with the front side facing up.

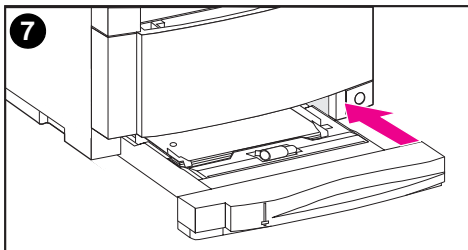

Printing from Tray 3 (500-Sheet Paper Feeder)

The printer supports an optional 500-sheet paper feeder (Tray 3). Tray 3 attaches to the bottom of the printer and serves as the printer's base. When the optional duplex printing accessory is installed, the duplex unit must be positioned between the printer and the 500-sheet paper feeder. The printer's internal sensors detect the presence or absence of Tray 3, and the printer control panel options automatically adjust to reflect the current configuration.

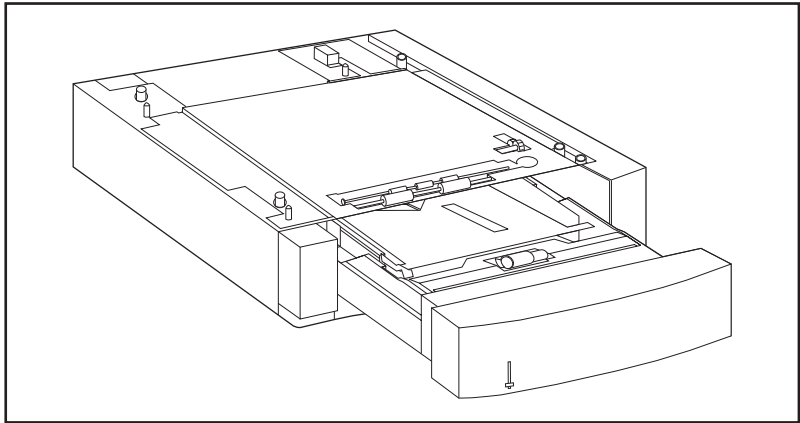

Figure 3-2 Tray 3 (optional 500-Sheet Paper Feeder)

The following are features of the 500-sheet paper feeder (Tray 3):

- The tray has a capacity of 500 sheets of standard paper.
- It is adjustable for specific media sizes, with corresponding stop positions.
- The printer automatically detects media size based on Tray 3's physical configuration and the position of the media-size knob located on the side of the tray.
- A user-configurable software setting identifies the media type that the printer expects to be loaded in Tray 3.
- An internal sensor automatically detects when Tray 3 is empty.
- A paper level indicator is provided on the front face of the tray.

Note

The paper path for the 500-sheet paper feeder passes through Tray 2. If Tray 2 is partially pulled out or removed, media from the paper feeder cannot feed into the printer. This causes the printer to go offline and generates a message that Tray 2 must be installed.

Loading Media into Tray 3

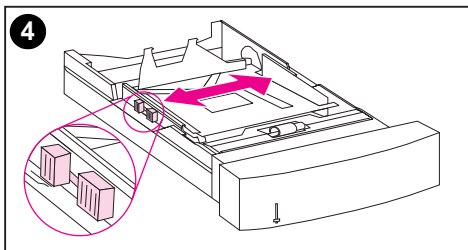
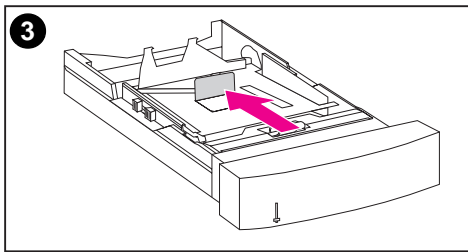
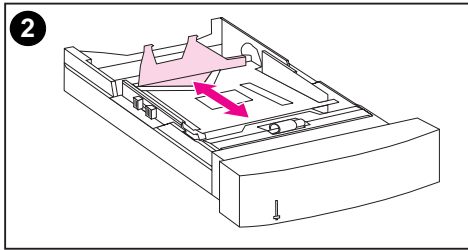
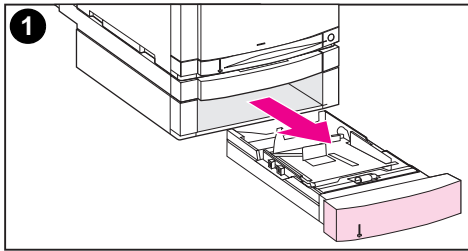

Tray 3 adjusts for Letter, Legal, A4, JIS B5, Custom (B5 ISO), and Executive paper. The printer automatically detects the media size in Tray 3 based on the tray's physical configuration and the position of the media-size knob.

To load media into Tray 3

CAUTION

Do not print cardstock, labels, and envelopes from Tray 3. This media should be printed only from Tray 1.

Do not overfill the input tray. Overfilling trays can cause jams in the printer.

- 1 Remove Tray 3 and place it on a flat surface.
- 2 Set the rear media-length guide by squeezing the release latch and sliding the guide to the length of media you are loading.
- 3 For special-size media, flip up the special media guide.
- 4 Squeezing the release latch, slide the media-width guides all the way open.

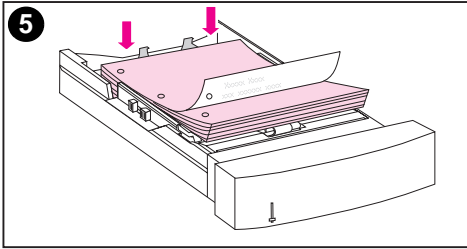

5 Load media into Tray 3 with the print side facing down. Do not overfill the tray.

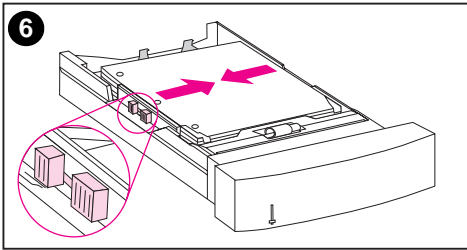

6 Slide the media-width guides in until they hold the media firmly in place without bending it.

7 Verify that media lies flat in the tray and that it fits under the metal tabs.

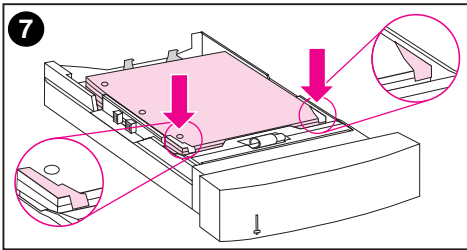

8 Set the media-size knob on the side of the tray to the size of media loaded in the tray.

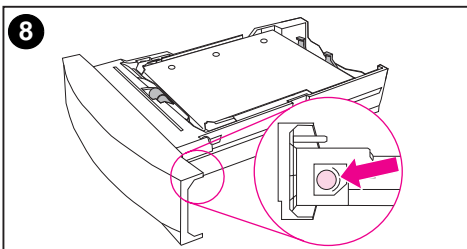

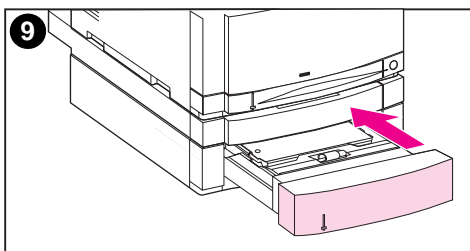

- 9 Insert Tray 3 into the printer.
- 10 Verify that the printer driver is configured to recognize Tray 3. (For instructions, see the online Help for the printer driver.)

Note

Load prepunched paper with holes toward the side of the tray as illustrated. For two-sided printing, load media with the front side facing up.

Using the Duplex Printing Accessory for Two-Sided Printing

The optional duplex printing accessory (figure 3-3), enables you to print on both sides of a page. In two-sided printing, known as duplex printing or duplexing, the back side of the page is printed first. Then the page is sent through the duplex printing accessory, where it is flipped over and sent back through the printer for printing on the front.

Note

Although the printer detects the presence of the duplex printing accessory, to print on two sides of the page, you must still specify duplex options in your software application or in the printer driver.

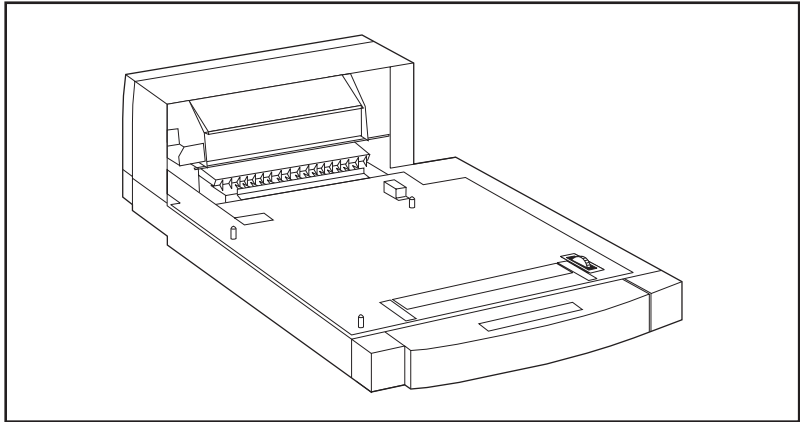

Figure 3-3 Duplex Printing Accessory

To use the duplex printing accessory successfully:

- Be sure that the duplex printing accessory is installed correctly. If the 500-sheet paper feeder (Tray 3) is installed, the duplex unit must be positioned between the printer and Tray 3.
- Verify that the printer driver is configured to recognize the duplex printing accessory. (For instructions, see the online Help for the printer driver.)
- Close the door to the rear output bin. The rear output bin is located at the back of the printer.
- Select the appropriate duplex options in the printer driver software. Duplex options include the page and binding orientation.
- Duplex printing is not supported for certain media types, including transparencies, labels, and cardstock.

Control Panel Settings for Duplex Printing

Many software applications allow you to change duplex printing settings. If your software application or printer driver does not allow you to adjust duplex printing settings, you can adjust these settings through the control panel.

CAUTION

Do not open the door to the rear output bin during duplex printing. Doing so can cause jams or misprints.

To set duplex printing from the printer control panel

Note

Changing duplex settings through the printer control panel affects all print jobs. Whenever possible, change duplex settings through your software application or printer driver.

- 1 Press **MENU** until PRINTING MENU displays.
- 2 Press **ITEM** until DUPLEX displays.
- 3 Press **VALUE** until ON displays.
- 4 Press **SELECT** to save the setting.
- 5 Press **ITEM** until BINDING displays.
- 6 Press **VALUE** to select either LONG EDGE or SHORT EDGE binding (see figure 3-4).
- 7 Press **SELECT** to save the setting.
- 8 Press **GO** to return the printer to the READY state.

- 9 From your software application or printer driver, select duplex printing.
- 10 Print the job.

Note

To select duplex printing from the printer driver, the driver must first be configured to recognize the duplex printing accessory. (For instructions, see the online Help for the printer driver.)

Options for Binding Duplex Printing Jobs

Before printing in duplex mode, decide on which edge you will be binding your finished document. The binding setup options are:

- *Long-edge (book) binding*, which is the conventional layout used in book binding. (See 1 in figure 3-4)
- *Short-edge (tablet) binding*, which is the type often used with calendars. (See 2 in figure 3-4)

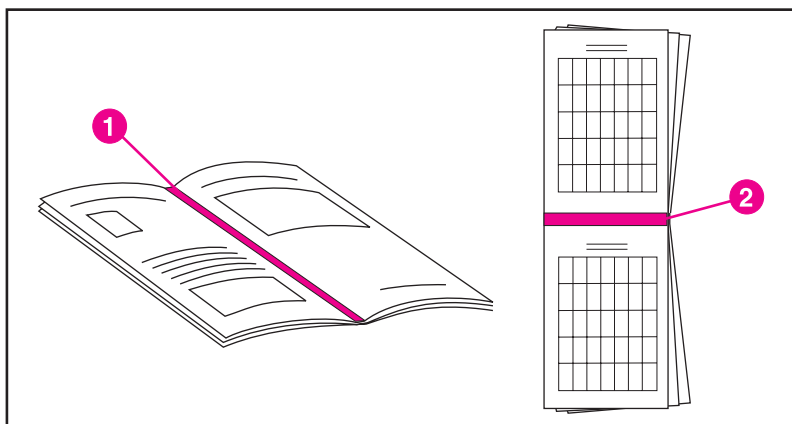

Figure 3-4 Binding Options

- 1 Long-Edge Binding
- 2 Short-Edge Binding

Special Printing Situations

Use these guidelines when printing on special types of media.

Printing a Different First Page

Use the following procedure to print the first page of a document on a different media type than the rest of the document. One example is printing the first page of a letter on letterhead paper and the rest of the letter on plain paper.

- 1 From your application, specify a tray for the first page (letterhead) and another tray for the remaining pages.
- 2 Load the letterhead into the tray that you specified in step 1.
- 3 Load the paper for the remaining pages of the document into another tray.

You can also print on a different first page by using the printer control panel to set the types of media that are loaded in the trays and then selecting the first and remaining pages by media type.

Printing on Custom-Size Media

The printer supports single-sided printing on custom-size media. Tray 1 supports media sizes from 76 x 127 mm (3 x 5 in) to 216 x 356 mm (8.5 x 14 in), including B5 ISO. The only custom size supported by Trays 2 and 3 is B5 ISO.

When printing on custom-size media, if Tray 1 is configured in the printer control panel as TRAY 1 MODE=CASSETTE, you must set the media size for Tray 1 to CUSTOM in the printer control panel. If Tray 1 is configured as TRAY 1 MODE=FIRST, the printer will print on whatever media is loaded in the tray. When printing on custom size (B5 ISO) media from Trays 2 or 3, adjust the paper guides on the tray to the Custom (B5 ISO) marking.

Some software applications and printer drivers allow you to specify custom paper-size dimensions. Be sure to set the correct paper size in both the page setup and print dialog boxes.

If your software application requires you to calculate margins for custom-size paper, see the online Help for that application.

Stopping a Print Request

You can stop a print request either from the printer control panel or from your software application. To stop a print request from a computer on a network, see the online Help for the specific network software.

Note

It may take some time for all printing to clear after a print job is canceled.

To stop the current print job from the printer control panel

Press **CANCEL JOB** on the printer control panel to cancel the job that is currently printing. Pressing **CANCEL JOB** does not affect subsequent print jobs that are stored in the printer buffer.

To stop the current print job from your software application

If several requests have been sent to the printer through your software, they may be waiting in a print queue (in Windows Print Manager, for example). See your software documentation for specific instructions on canceling a print request from the computer.

4 Using Color

Overview

The printer is designed to provide outstanding color output. This chapter provides information to help you obtain the best color quality from this printer. The chapter includes the following sections:

- Customizing Color Output Through Printer Drivers
- Matching Colors
- Adjusting Color Balance

Customizing Color Output Through Printer Drivers

The printer driver, which is installed with your printer software, enables your software applications to use the features of the printer. It also gives you customized control of color text, graphics, and photos.

The method of accessing your printer driver depends on your computer's operating system. For specific instructions on accessing printer drivers, see the printer driver's Readme file, which is included on the printing system CD-ROM.

The following color control features are available only through your HP printer driver. See the printer driver's online Help for details on color settings and their effect on printed output.

Halftone Options

Halftone options affect the resolution and clarity of your color output. You can select halftone settings for text, graphics, and photos independently. The two halftone options are Smooth and Details.

The Smooth option provides better results for large, solid-filled print areas. It also enhances photos by smoothing out fine color gradations.

The Detail option is useful for text and graphics that require sharp distinctions among lines or colors, such as images that contain a pattern or a high level of detail.

HP ColorSmart II

HP ColorSmart II default settings will produce optimum results for most color printing needs. However, you can also manually adjust color settings through the printer driver's Vivid Color and Screen Match color control options.

Vivid Color

Vivid Color produces colors that are very bright and vivid. When you use Vivid Color, your color output is brighter than the colors that appear on your screen.

Screen Match

Screen Match (sRGB) (standard red-green-blue) prints colors that are close to those you see on your screen. Screen Match can be useful for retouching photographs or when you have created colors on your screen that you wish to reproduce, such as special colors for a company logo.

Note

Factors such as the type of monitor you use and the room's lighting can affect the appearance of colors on your screen.

Print in Grayscale

The Print in Grayscale option in the printer driver allows you to print documents using shades of gray in place of colors. This option is ideal for printing proofs of color documents, or for printing documents that will later be faxed or photocopied.

Matching Colors

The process of matching printer output color to your monitor is quite complex because printers and computer monitors use different methods of producing color. Monitors *display* colors by light pixels using an RGB (red, green, blue) color process, but printers *print* colors using a CMYK (cyan, magenta, yellow, and black) process.

Color-Matching Factors

Several factors can influence your ability to match printed colors to those on your monitor. These factors include:

- print media
- overhead lighting
- personal differences in perception
- software applications
- operating system palettes
- monitors
- video cards and drivers

Matching PANTONE®* Colors

In addition to controlling color through the printer driver, you can control color through PANTONE®* color matching.

PANTONE®* colors are certified RGB and CMYK values specified in the PANTONE®* color-matching system, which is supported in many graphics software applications. This color-matching system is useful for matching printer output to a specific color (for example, a logo). See the documentation for your software application for instructions on using PANTONE®* colors.

For more information on using PANTONE®* colors, see the Readme file for the PANTONE®* color-matching system included on the printing system CD-ROM.

Note

Color settings, halftone settings, and print media affect the appearance of PANTONE®* colors. To achieve true PANTONE®*-certified colors, all components used, including the video driver, software application or printer driver, and the print media, must be PANTONE®*-certified.

Adjusting Color Balance

This printer features automatic color calibration to provide high-quality color output. In situations that require critical color control, you can manually adjust the density balance of the printer's four toner colors.

CAUTION

This procedure should only be performed by your network administrator. Performing this procedure changes the color balance of the printer by altering halftones and affects *all* print jobs.

To adjust color balance

Step 1: Print a color balance calibration page.

The color balance calibration page displays current color settings and provides a record of the printer's initial settings before any adjustments are made.

- 1 Press **MENU** until CALIBRATION MENU displays.
- 2 Press **ITEM** until PRINT CALIBRATION PAGE displays.
- 3 Press **SELECT** to print the color balance calibration page. The page consists of four color bars (cyan, magenta, yellow, and black) and a box containing gray balance circles (see figure 4-1). The factory default setting for each color is zero. The range of settings is -5 to +5.

Note

Adjusting densities using the four color bars provides coarse color balance adjustments. After making these adjustments, you can fine-tune color densities by adjusting the gray balance. (See step 7 for instructions.)

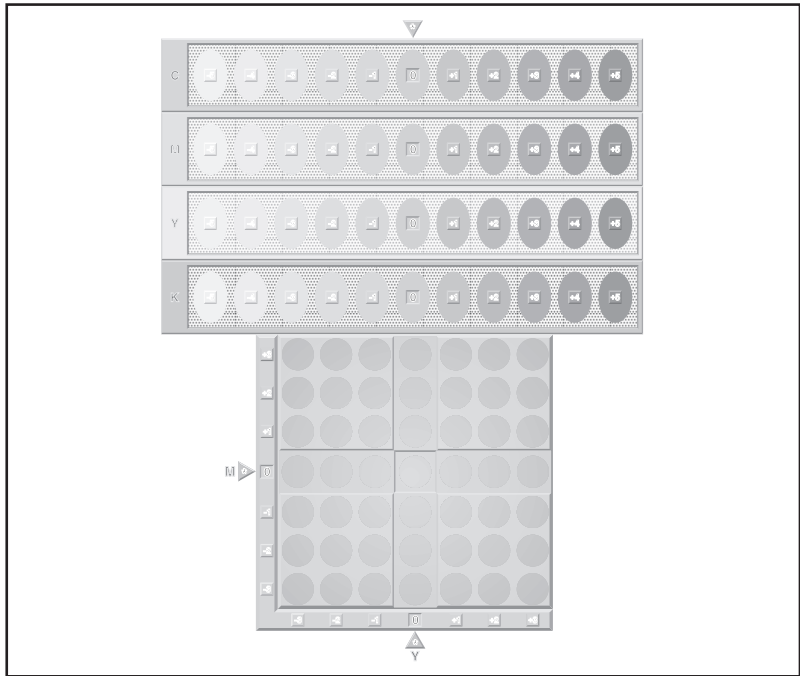

Figure 4-1 Color Balance Calibration Page

Step 2: Adjust the cyan (C) density setting.

Examine the cyan density bar (C) on the color balance calibration page (see figure 4-1) from a distance of 2 meters (6 ft). If the center oval matches the background pattern more than the other ovals, the cyan density does not need to be adjusted and you should continue on to the magenta (M) setting. If an oval left of center or right of center matches the background pattern more than the center oval, use the following steps to enter the number:

- 1 Press **ITEM** until CYAN DENSITY displays.
- 2 Press the right side of the **VALUE** key to increase the value, or press the left side to decrease it, until the number corresponding to the oval that most closely matches the background pattern is displayed.
- 3 Press **SELECT** to save the value. An asterisk (*) displays next to the selected setting.

Step 3: Adjust the magenta (M) density setting.

Examine the magenta density bar (M). If the center oval matches the background pattern more than the other ovals, the magenta density does not need to be adjusted and you should continue with the next step. If not, use the following steps to adjust the density:

- 1 Press **ITEM** until MAGENTA DENSITY displays.
- 2 Press the right side of the **VALUE** key to increase the value, or press the left side to decrease it, until the number corresponding to the oval that most closely matches the background pattern is displayed.
- 3 Press **SELECT** to save the value. An asterisk (*) displays next to the selected setting.

Step 4: Adjust the yellow (Y) density setting.

Examine the yellow density bar (Y). If the center oval matches the background pattern more than the other ovals, the yellow density does not need to be adjusted and you should continue with the next step. If not, use the following steps to adjust the density:

- 1 Press **ITEM** until YELLOW DENSITY displays.
- 2 Press the right side of the **VALUE** key to increase the value, or press the left side to decrease it, until the number corresponding to the oval that most closely matches the background pattern is displayed.
- 3 Press **SELECT** to save the value. An asterisk (*) displays next to the selected setting.

Step 5: Adjust the black (K) density setting.

Examine the black density bar (K). If the center oval matches the background pattern more than the other ovals, the black density does not need to be adjusted and you should continue with the next step. If not, use the following steps to adjust the density:

- 1 Press **ITEM** until BLACK DENSITY displays.
- 2 Press the right side of the **VALUE** key to increase the value, or press the left side to decrease it, until the number corresponding to the oval that most closely matches the background pattern is displayed.
- 3 Press **SELECT** to save the value. An asterisk (*) displays next to the selected setting.

Step 6: Reprint the color balance calibration page. (See step 1.)

Step 7: Adjust Gray Balance.

Note

Adjusting densities using the gray balance pattern allows you to fine-tune color balance. This process affects all four color bars.

Examine the gray balance circles in the box at the bottom of the color balance calibration page (see figure 4-1). If the circle in the center most closely matches the background pattern, then the gray balance does not need to be adjusted. If the circle does not match, use the following steps to adjust gray balance.

- 1 Locate the gray circle that most closely matches the background. The magenta (M) and yellow (Y) numbers associated with this circle indicate the optimum gray balance settings for these colors.
- 2 Adjust the magenta and yellow settings to the numbers indicated (see the steps on adjusting magenta and yellow settings).
- 3 After making adjustments to the magenta and yellow settings, press **GO** to return the printer to the READY state.

5 Using Fonts

Overview

This chapter provides information on various fonts. The chapter includes the following sections:

- Using HP FontSmart
- Using Internal TrueType Fonts
- Understanding Printer Default Fonts
- Selecting Fonts
- Printing a List of Available Printer Fonts
- Using Typefaces for PostScript Emulation in the Printer
- Using Fonts on a Network
- Adding Support for Accessory Fonts to a Printer Driver
- Using Special Type Effects
- Hewlett-Packard Custom Font Services

Using HP FontSmart

HP FontSmart is a font management utility (for Windows only), that is included with the printing software that came with your printer. When you install the printing software, you can install HP FontSmart through the Custom installation option.

Fonts must first be installed in your computer's operating system before you can use them in an application. The HP FontSmart utility manages fonts and makes them available to Windows applications. Using HP FontSmart can improve Windows performance by allowing you to install and make available only the fonts you need.

HP FontSmart searches your disk(s) for all fonts, allowing you to view font samples and to remove any duplicate or unneeded fonts.

When you run HP FontSmart, two lists are displayed. The list on the left displays fonts available to install, and the list on the right displays the fonts that are currently installed in Windows. You can install, uninstall, or delete any font that appears on the lists.

For more information, see the online Help for HP FontSmart.

Note

To save disk space and system resources, install only those fonts that you plan to use.

Accessing HP FontSmart from Windows 95 and Windows NT 4.0

- 1 From the **Start** menu, click **Programs**.
- 2 Click **HP LaserJet**.
- 3 From the HP LaserJet group, click **HP FontSmart**.

Accessing HP FontSmart from Windows 3.1 and Windows NT 3.51

- 1 From the **Program Manager**, select the **HP LaserJet** group.
- 2 Double-click on the **HP FontSmart** icon.

Note

For help with HP FontSmart, select the **Help** menu in FontSmart.

Using Internal TrueType Fonts

TrueType fonts are typefaces developed jointly by Microsoft® Corporation and Apple Computer, Inc. Hewlett-Packard has included 80 TrueType fonts with this printer.

You do not need to download these TrueType fonts because they are already installed in your printer. The printer driver automatically uses internal fonts when it can. This results in increased printing performance.

See the Microsoft Windows documentation for specific instructions on using TrueType fonts with Windows.

Understanding Printer Default Fonts

The default font for this printer is 12 point Courier in the PC-8 symbol set. The printer uses the default font only if another font has not been specified.

Changing the Default Font

You can select a different default font from the printer control panel. See the section later in this chapter on selecting PCL default fonts through the control panel.

Selecting a Font Other than the Default

- You can request a font from within most software applications.
- You can send a PCL printer command requesting a font different from the default. For information on printer PCL commands, see Appendix B or the *PCL Technical Reference Package* for this printer.

Font Selection Priority

The printer selects printer fonts in the following order:

- 1 soft fonts (downloaded fonts)
- 2 fonts on DIMMs
- 3 internal fonts

In order to select a font, the font must be available from one of these sources. If the font you request is not available, the printer selects the closest match based on individual font characteristics (PCL only).

Selecting Fonts

You can select fonts either from a software application or through the printer control panel.

Note

A font request from a software application or printer driver overrides font settings in the printer control panel.

Selecting Fonts from Software Applications

For information on changing font selection, base font, printer setup, print options, and font appearance from a software application, see the documentation for your application.

Selecting Symbol Sets

If you want to print a symbol such as Ω while the printer is in PCL mode, you must first select the symbol set that contains that character. See the *PCL Color Technical Reference Guide* or the *PCL Comparison Guide* for a complete listing of available symbol sets and printer commands. Contact HP Direct to obtain these guides. (See Appendix D for ordering information.)

Symbol Set Availability

Many software applications allow you to specify a symbol set from the printer setup menu. You should consider two things when using symbol sets:

- Software applications may not support all of the printer's symbol sets.
- Typefaces are designed to work with specific symbol sets.

Entering Symbols into Text

The documentation for your software application should contain instructions for entering special symbols into text. See the documentation's index for phrases such as *compose feature*, *composite characters*, *symbol sets*, *character sets*, *code pages*, and *extended characters*.

Selecting PCL Fonts Through the Printer Control Panel

If your software application does not allow you to select fonts through its menus, you can select PCL fonts through the printer control panel. Only one font can be selected for a particular print job.

Note

A font selected through the printer control panel becomes the default font for all subsequent print jobs.

You must specify several items when selecting a font through the printer control panel. These items are listed on the printer's font page and include:

- the font source
- the font number
- the point size or pitch
- a symbol set

Note

A font request from a software application overrides font settings in the printer control panel.

To select PCL default fonts through the printer control panel

- 1 Print a list of available PCL printer fonts. (For instructions, see the following section.)
- 2 On the printed font list, locate the font source and number that correspond to the font you wish to use.
- 3 Press **MENU** until PRINTING MENU displays.
- 4 Press **ITEM** until PCL FONT SOURCE displays.
- 5 Press **VALUE** until the font source displays. The following sources are available:
 - INTERNAL
 - SOFT
 - DIMM SLOT n ($n = 1,2,3$)
- 6 Press **SELECT** to save your selection. An asterisk (*) appears next to your selection.
- 7 Press **ITEM** until PCL FONT NUMBER displays.
- 8 Press **VALUE** until the correct font number displays.
- 9 Press **SELECT** to save your selection. An asterisk (*) appears next to your selection.
- 10 Press **ITEM** until PCL FONT POINT SIZE displays (or, for proportional fonts, until PITCH displays). This selection is not available for bitmapped fonts.
- 11 Press **VALUE** until the correct point size or pitch displays.
- 12 Press **SELECT** to save your selection. An asterisk (*) appears next to your selection.
- 13 Press **GO** to return the printer to the READY state.

Printing a List of Available Printer Fonts

You can use the Information Menu on the printer control panel to print a list of available fonts.

To print a list of available fonts

- 1 Press **MENU** until INFORMATION MENU displays.
- 2 Press **ITEM** until PRINT FONT LIST displays.
- 3 Press **SELECT** to print the font list.
- 4 After the list has printed, the printer returns to the READY state.

Note

Temporary soft fonts (fonts that your software downloaded for a specific document) do not appear on the printout. Permanent soft fonts do appear on the printout.

The font list displays all available typefaces for installed cards (DIMMs), permanent downloaded soft fonts, and internal fonts.

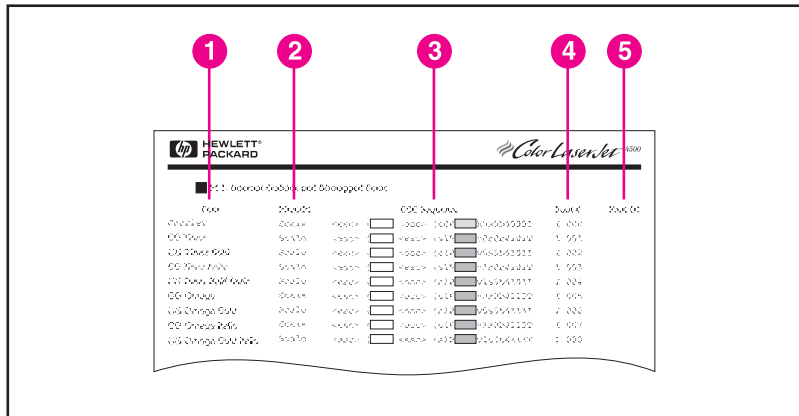

Figure 5-1 Font List

Interpreting the Font Lists

The PCL font list displays samples of available fonts. The following is a description of the elements of the font list:

- 1 Font**
The name of the typeface family.
- 2 Pitch/Pt**
Pitch indicates the number of characters per inch of a fixed-space font. Point Size is the height of the font, measured in points, and is used to describe scalable fonts.
- 3 ESC Sequence**
Escape Sequence (a PCL command) is used to select the designated font. Fill in Pitch or Point Size and Symbol Set in the boxes as required. The escape sequence contains a shaded box followed by “v” or “h.” This indicates that you must enter the point size (for example, 14.25v) or pitch (for example, 12.00h).
- 4 Font #**
The number you use to select internal or downloaded soft fonts from the control panel. The source of the font is also listed.
Note: Do not confuse the font number with the soft font ID.
- 5 Font ID**
The identification number you assign to soft fonts when you download them through your software.

See the *PCL Technical Reference Manual* for instructions on downloading fonts.

The font list for PostScript Emulation displays all fonts installed in the printer’s firmware. Although the characters are listed in only one size, you can scale the typefaces to any size.

Using Typefaces for PostScript Emulation in the Printer

The printer is configured with 80 scalable fonts that are available for PCL and PostScript Emulation. Since these typefaces require software application support, refer to your software documentation for information about using these typefaces.

Using Fonts on a Network

Consult with your network administrator or with other network users before using the printer control panel to change the default font and before downloading or removing soft fonts and typefaces.

To conserve memory and avoid unexpected printer output, use the guidelines that follow. Your network operating system might automatically protect each user's print job from the effects of other print jobs in the network. Consult a network administrator for more information.

Guidelines for printing with different fonts

- The 80 internal fonts are available in PostScript Emulation (PS) and PCL mode. In order to use a font, your software application must support it.
- To conserve printer memory, download only those fonts that are needed.
- If you require several downloaded fonts, consider installing additional printer memory.
- Some software applications automatically download fonts at the beginning of each print job. It might be possible to configure those applications to download only soft fonts that are not already resident in the printer. See your software application's documentation for more information.

Adding Support for Accessory Fonts to a Printer Driver

When you are using typefaces on DIMMs, your printer driver might require information about the size, shape, and style of the type characters so that it can format your text correctly.

Verifying Software Application Support for Fonts

Many current software applications support the typefaces that are included with this printer.

If fonts are listed in a software application's menu, the software contains support for that font. To download those fonts, follow the instructions provided with the fonts.

Note

Although your software lists typefaces in its menus, it does not necessarily confirm that the typefaces are installed in the printer. You might need to download the typeface into the printer's memory by following the instructions that came with the typeface.

Using Special Type Effects

The printer can create special type effects, such as patterns, reverse printing, mirrored text, and font rotation. See the user guide for your application to verify that the application supports these features. Developers can find complete instructions for using special type effects in the *PCL Technical Reference Package*, which is available through HP Direct.

Hewlett-Packard Custom Font Services

Hewlett-Packard offers fonts on disk, cartridge, or DIMMs. You can design a custom font package to fit your particular needs. The items below are examples of available custom fonts:

- fonts or typefaces from any Hewlett-Packard standard font product or typeface collection
- bar codes, including 3 of 9, 128, Interleaved 2 of 5, UPC, USPS Zip, and others
- custom symbol set mappings
- signatures and logos

For custom fonts (such as signature fonts and logos) and also discontinued font products (such as Barcodes & More, Tax 1, and Pro Collection), contact:

Hewlett-Packard LaserJet Font Solutions
(541) 715-5757

Information on obtaining font products is available through HP FIRST at (800) 333-1917. For information on discontinued font products, request document number 1306. For custom font information, request document number 1034.

Outside the U.S., contact your local HP dealer.

6 Printer Interfaces

Overview

This chapter provides information on available printer interfaces. The chapter includes the following sections:

- Parallel Configuration
- Enhanced I/O (EIO) Configuration
- Configuring the Printer for the Network at the Printer Control Panel

Parallel Configuration

If your printer is not configured with a network interface card, connect the printer to your computer using a bidirectional parallel cable (IEEE-1284C compliant) with a “C” connector (see figure 6-1) plugged into the printer’s parallel port. The cable can be a maximum of 10 meters (30 feet). For ordering information, see the printer supplies and accessories table in chapter 1.

When used to describe a parallel interface, the term *bidirectional* indicates that the printer is able to both receive data from the computer and to send data to the computer through the parallel port.

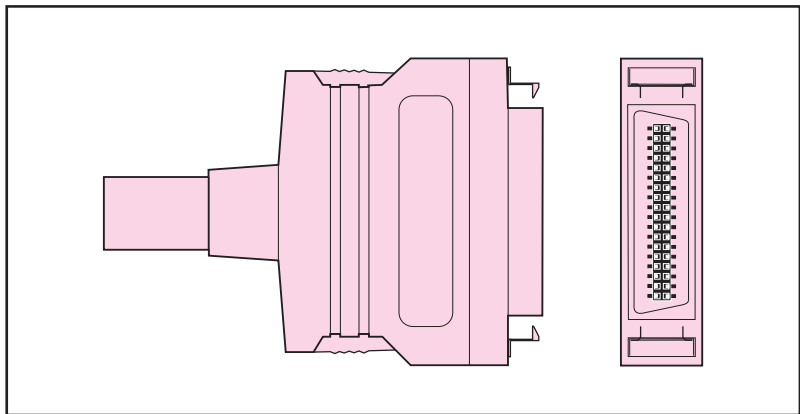

Figure 6-1 Parallel Cable with a “C” Connector

Note

To use the enhanced capabilities of the bidirectional parallel interface, such as bidirectional communication between the computer and printer, faster transfer of data, and automatic configuration of printer drivers, your software application must support these capabilities.

When you are using multiple ports, you can adjust automatic I/O switching to maximize performance by using the timeout feature. If data from other ports appears in the middle of your print job, increase the I/O Timeout value. (See the section on setting I/O Timeout in chapter 2.)

Parallel Cable Pin Configuration

To take advantage of the enhanced bidirectional parallel interface, use a 10 meter (30 ft) parallel cable (IEEE-1284 compliant) with a 25-pin DB male to a (IEEE-1284C) male "C" connector. Use the following table to verify correct pin configuration.

Signal Name	Printer Pin #	Computer Port #
nSTROBE	15	1
DATA 0	6	2
DATA 1	7	3
DATA 2	8	4
DATA 3	9	5
DATA 4	10	6
DATA 5	11	7
DATA 6	12	8
DATA 7	13	9
nACKNLG	3	10
BUSY	1	11
CALL (PE)	5	12
SELECT	2	13
NAutoFd	17	14
O VDC (GND)	19 – 35	18 – 25
nFAULT	4	15
nSe/In	16	17
nINIT	14	16
PERIPHLH	36	
N.C.	18	

Enhanced I/O (EIO) Configuration

This printer comes equipped with two enhanced input/output (EIO) slots. These slots hold compatible external devices such as the HP JetDirect print server network cards. Plugging EIO network cards into the slots increases the number of network interfaces available to the printer.

EIO network cards can maximize printer performance when you are printing from a network. In addition, they provide the ability to place the printer anywhere on a network. This eliminates the need to attach the printer directly to a server or a workstation and enables you to place the printer closer to your network users.

The printer control panel will have an additional menu (EIO Menu) if the printer is configured with EIO network cards.

HP JetDirect Print Servers

HP JetDirect print servers (network cards) can be installed in one of the printer's EIO slots. These cards support multiple network protocols and operating systems. HP JetDirect print servers facilitate network management by allowing you to connect a printer directly to your network at any location. HP JetDirect print servers also support the Simple Network Management Protocol (SNMP), which provides network managers with remote printer management and troubleshooting through HP JetAdmin software.

Note

Installation of these cards and network configuration should be performed by a network administrator.

Available Enhanced I/O Interfaces

HP JetDirect print servers (network cards) provide software solutions for:

- Novell NetWare
- Microsoft Windows 3.1 and Windows 95
- Microsoft Windows NT 3.51 and Windows NT 4.0
- IBM OS/2 LAN Server or Warp Server
- Apple EtherTalk and LocalTalk
- UNIX (HP-UX, Solaris, and SunOS)

For information on installing HP JetDirect print servers and the types of interfaces and network operating systems supported, see the *HP JetDirect Print Server Software Installation Guide*.

NetWare 3.x- and 4.x-Based Products

When using Novell NetWare 3.x- and 4.x-based products with an HP JetDirect print server, Queue Server Mode provides improved printing performance over Remote Printer Mode. For more information, see the *HP JetDirect Print Server Software Installation Guide*.

Windows and Windows NT Networks

For Windows 3.1 and Windows 95 networks, HP JetAdmin software works as a Windows application.

For peer-to-peer Windows 95 networks, HP JetAdmin software works as a Windows application, and connects HP printers to an IPX/SPX-compatible printer network using an HP JetDirect print server.

For Windows NT 3.51 and Windows NT 4.0 networks, HP JetAdmin software supports the TCP/IP or IPX/SPX environments.

IBM OS/2 LAN Server and Warp Server Networks

For IBM OS/2 LAN Server and Warp Server Networks, HP JetAdmin software supports the Data Link Control (DLC) and TCP/IP environments.

When using virtual memory, increasing server RAM may improve performance. This is especially evident if the swapper.dat file is large. Any performance improvement is dependent upon the number of network printers and type of printer driver.

LocalTalk Configuration

The LocalTalk interface enables you to print directly from a standalone Apple Macintosh computer or from a Macintosh computer on a LocalTalk network. For specific information on configuring your computer and printer to print through a LocalTalk interface, refer to the printer's getting started guide and the *HP JetDirect Print Server Software Installation Guide*.

Macintosh DIN-8 Cable

To connect a Macintosh computer directly to this printer, use a standard Macintosh DIN-8 printer cable. This cable cannot be used in a network configuration.

Note

For LocalTalk configuration, the DIN-8 printer cable must be plugged into the printer port of your Macintosh computer.

LocalTalk Network Configuration

To connect the printer to a Macintosh computer on a LocalTalk network, use the HP LocalTalk Cable Kit. You will need a kit for each printer and an additional kit for each Macintosh computer on your network.

UNIX Networks

HP JetAdmin software provides a TCP/IP-based solution for configuring and managing HP JetDirect print servers on HP-UX, Solaris, and SunOS systems.

Setting Network Security on the Printer

This printer features control panel locking which allows network administrators to prevent users from changing certain settings in the printer control panel. When a menu of the printer control panel is locked, unauthorized users trying to change printer control panel settings will receive the following message:

```
ACCESS DENIED  
MENU LOCKED
```

You can use the HP JetAdmin software, the HP LaserJet Utility for Macintosh, or an ASCII escape sequence to perform this procedure. For instructions on locking the printer control panel using either the HP JetAdmin software or the HP LaserJet Utility for Macintosh, see their online Helps.

Configuring the Printer for the Network at the Printer Control Panel

You might need to configure certain network parameters on the printer. You can configure these parameters from the printer control panel or, for most networks, from the HP JetAdmin software (or the HP LaserJet Utility for Macintosh). The utilities are provided on the printing software CD-ROM that comes with the printer.

For a complete list of supported networks and for instructions on configuring network parameters from software such as the HP JetAdmin software, see the *HP JetDirect Print Server Software Installation Guide*. The guide comes with printers in which an HP JetDirect print server is installed.

This section contains the following instructions for configuring network parameters from the printer control panel:

- Configuring Novell NetWare Frame Type Parameters
- Configuring TCP/IP Parameters
- Configuring the Apple EtherTalk Phase Parameters
- Disabling Unused Network Protocols

Configuring Novell NetWare Frame Type Parameters

The HP JetDirect print server automatically selects a NetWare frame type. Select a frame type manually only when the print server selects an incorrect frame type. To identify the frame type chosen by the HP JetDirect print server, print a configuration page.

To configure the Novell NetWare parameters from the printer control panel

- 1 Press **MENU** until HP EIO 1 MENU displays.
- 2 Press **ITEM** until CFG NETWORK=NO * displays.
- 3 Press **VALUE** until CFG NETWORK=YES displays.
- 4 Press **SELECT** once. CFG NETWORK=YES * displays.
- 5 Press **ITEM** until CFG NOVELL=NO * displays.
- 6 Press **VALUE** until CFG NOVELL=YES displays.
- 7 Press **SELECT** once. CFG NOVELL=YES * displays.
- 8 Press **ITEM** until FRAME=AUTO * displays.
- 9 To configure the Novell NetWare protocol, press **VALUE** to select one of the frame types from the following table:

Frame Type	Description
AUTO (default)	All listed Novell frame types will be allowed.
EN_8023	Limits frame types to IPX over IEEE 802.3 frames. All others will be counted and discarded.
EN_II	Limit frame types to IPX over Ethernet II frames. All others will be counted and discarded.
EN_8022	Limit frame types to IPX over IEEE 802.2 with Ethernet frames. All others will be counted and discarded.
EN_SNAP	Limit frame types to IPX over SNAP with Ethernet frames. All others will be counted and discarded.

- 10 Press **SELECT** to save the value. An asterisk (*) displays.
- 11 If you are finished, press **Go** to return the printer to the READY state.
– OR –
See the appropriate sections for other protocols that will be used.

Configuring TCP/IP Parameters

To configure TCP/IP parameters, you can use the HP JetAdmin software that is included on the printer's software CD-ROM. If you choose not to use this utility or are using a UNIX system other than HP-UX, Solaris, or SunOS, you can use the printer control panel to configure the following TCP/IP parameters:

- Usage of the BOOTP file for configuration parameters (the default is to use the BOOTP file)
- IP address (4 bytes)
- Subnet mask (4 bytes)
- Default gateway (4 bytes)
- TCP connection timeout (in seconds)

Note

Do not disable BOOTP if you will be using RARP or DHCP to configure TCP/IP parameters.

To configure TCP/IP parameters from the printer control panel

- 1 Press **MENU** until HP EIO 1 MENU displays.
- 2 Press **ITEM** until CFG NETWORK=NO * displays.
- 3 Press **VALUE** until CFG NETWORK=YES displays.
- 4 Press **SELECT** once. CFG NETWORK=YES * displays.
- 5 Press **ITEM** until CFG TCP/IP=NO * displays.
- 6 Press **VALUE** once. CFG TCP/IP=YES displays.
- 7 Press **SELECT** once. CFG TCP/IP=YES * displays.
- 8 Press **ITEM** to configure TCP/IP parameters manually. BOOTP=YES * displays.

- 9 If you keep BOOTP=YES *, the values for the TCP/IP parameters will be provided by the BOOTP file, RARP, or DHCP and no other TCP/IP configuration is necessary. Skip to step 17.
– OR –
Press **VALUE** to change the value of the BOOTP= parameter.
BOOTP=NO displays.
- 10 Press **SELECT** to save the selection. BOOTP=NO * appears, and you are prompted to configure each of the TCP/IP parameters.
- 11 Press **ITEM** to continue configuring. IP BYTE 1=<value>> * displays.
- 12 Press **VALUE** until the value of the first byte of the IP address displays.
- 13 Press **SELECT** to save the value.
- 14 Repeat steps 12 and 13 to configure the remaining bytes of the IP address.
- 15 Press **ITEM** to continue.
- 16 Repeat steps 12-15 to configure the subnet mask bytes (SM), default gateway (GW), and timeout (TIMEOUT).
- 17 If you are finished, press **Go** to return the printer to the READY state.
– OR –
See the appropriate sections for other protocols that will be used.

To configure Apple EtherTalk parameters from the printer control panel

- 1 Press **MENU** until HP EIO 1 MENU displays.
- 2 Press **ITEM** until CFG NETWORK=NO * displays.
- 3 Press **VALUE** until CFG NETWORK=YES displays.
- 4 Press **SELECT** once. CFG NETWORK=YES * displays.

- 5 Press **ITEM** until CFG ETALK=NO * displays.
- 6 Press **VALUE** until CFG ETALK=YES displays.
- 7 Press **SELECT** once. CFG ETALK=YES * displays.
- 8 Press **ITEM**. PHASE=1 or PHASE=2 displays.
- 9 Press **ITEM** to retain the value and continue, or press **VALUE** to change the phase parameter.
- 10 Press **SELECT** to save the new value.
- 11 If you are finished, press **Go** to return the printer to the READY state.
– OR –
See the appropriate sections for other protocols that will be used.

Disabling Network Protocols (Optional)

By factory default, all supported network protocols are enabled. Disabling unused protocols has the following benefits:

- decreases printer-generated network traffic
- prevents unauthorized users from printing to the printer
- provides only pertinent information on the configuration page
- allows the printer control panel to display protocol-specific error and warning messages

To reach network protocols

- 1 Press **MENU** until HP EIO 1 MENU displays.
- 2 Press **ITEM** until CFG NETWORK=NO * displays.
- 3 Press **VALUE** until CFG NETWORK=YES displays.
- 4 Press **SELECT** once. CFG NETWORK=YES * displays.
- 5 In the sections that follow, find the protocol that you want to disable.

To disable IPX/SPX

Note

Do not disable this protocol if Windows 95 or Windows NT clients will be printing to the printer.

- 1 Press **ITEM** until IPX/SPX=ON * appears.
- 2 Press **VALUE** to change to IPX/SPX=OFF.
- 3 Press **SELECT** to save the new status. IPX/SPX=OFF * appears.
- 4 To disable another protocol, find the appropriate section.
– OR –
Press **GO** to return the printer to the READY state.

To disable DLC/LLC

- 1 Press **ITEM** until DLC/LLC=ON * displays.
- 2 Press **VALUE** to change to DLC/LLC=OFF.
- 3 Press **SELECT** to save the new status. DLC/LLC=OFF * displays.
- 4 To disable another protocol, find the appropriate section.
– OR –
Press **GO** to return the printer to the READY state.

To disable TCP/IP

- 1 Press **ITEM** until TCP/IP=ON * displays.
- 2 Press **VALUE** to change to TCP/IP=OFF.
- 3 Press **SELECT** to save the new status. TCP/IP=OFF * displays.
- 4 To disable another protocol, find the appropriate section.
– OR –
Press **GO** to return the printer to the READY state.

To disable Apple EtherTalk

- 1 Press **ITEM** until ETALK * displays.
- 2 Press **VALUE** to change to ETALK=OFF.
- 3 Press **SELECT** to save the new status. ETALK=OFF * displays.
- 4 To disable another protocol, find the appropriate section.
– OR –
Press **GO** to return the printer to the READY state.

7 Consumables and Cleaning

Overview

This chapter provides an overview of the printer's consumable items. The chapter includes the following sections:

- Making Room for Replacing Consumables
- Approximate Replacement Intervals for Consumable Items
- Locating Consumables
- Environmental Collection Program
- Cleaning the Toner Density Sensor

For complete instructions on installing consumables, see the installation guides supplied with each consumable item.

Making Room for Replacing Consumables

The following illustration shows the clearance necessary around the printer for replacing consumables.

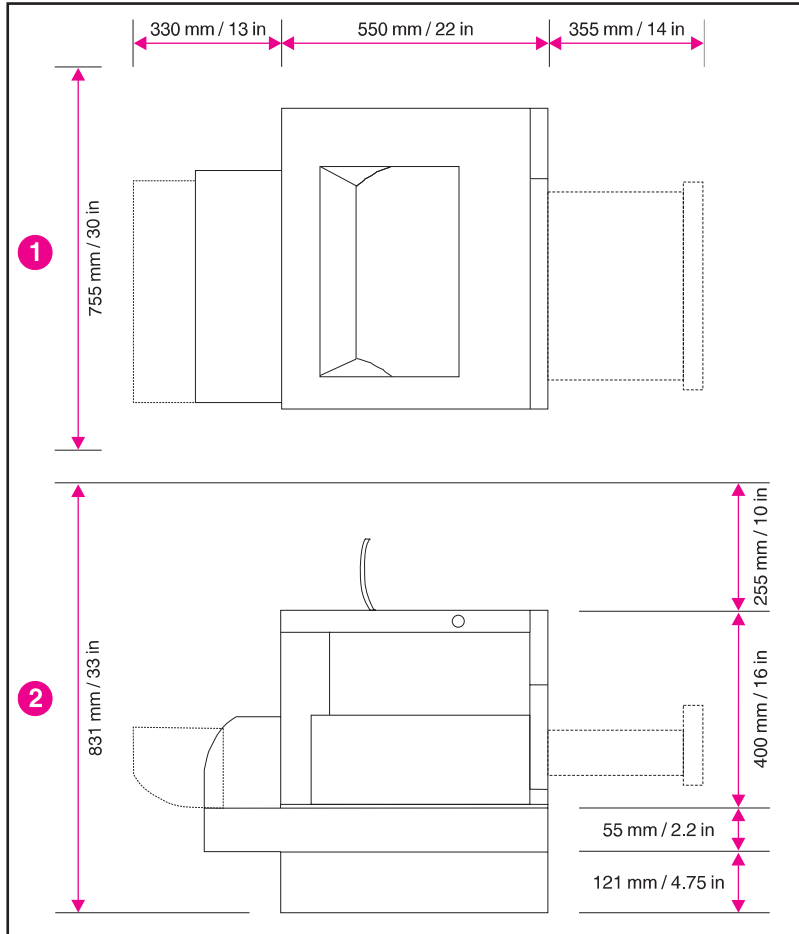

Figure 7-1 Consumable Replacement Clearance Diagram

- 1 Top View
- 2 Side View

Consumable Replacement Guidelines

To facilitate consumable replacement, keep the following guidelines in mind when setting up the printer.

- Sufficient space is required in the front and rear of the printer for removing consumable items.
- The printer should be located on a flat, sturdy surface.
- 102 mm (4 in) of space is required on the sides of the printer to ensure proper ventilation.

The following table lists the replacement intervals for the printer's consumable items.

Approximate Replacement Intervals for Consumable Items

You can identify consumable items by their labeling and their blue plastic handles. For instructions on installing consumables, see the installation guides supplied with each consumable item.

The following table lists the replacement intervals for printer consumable items and the control panel messages that prompt you when to replace each item.

Consumable	Printer Message	Page Count	Approximate Time Period ²
Black (K) Toner Cartridge	TONER K LOW or TONER K OUT	8,000 pages ¹	4 months
Cyan (C) Toner Cartridge	TONER C LOW or TONER C OUT	5,000 pages ¹	2.5 months
Magenta (M) Toner Cartridge	TONER M LOW or TONER M OUT	5,000 pages ¹	2.5 months
Yellow (Y) Toner Cartridge	TONER Y LOW or TONER Y OUT	5,000 pages ¹	2.5 months
Drum Kit	DRUM KIT LOW or DRUM KIT OUT REPLACE DRUM KIT	25,000 black and white only pages, or 6,250 color pages.	12.5 months for black and white only pages, or 3 months for color pages.
Transfer Kit	TRANSFER KIT LOW or TRANSFER KIT OUT REPLACE KIT	100,000 black and white only pages, or 25,000 color pages.	50 months for black and white only pages, or 12.5 months for color pages.
Fuser Kit	FUSER KIT LOW or FUSER KIT OUT REPLACE KIT	100,000 black and white only pages, or 50,000 color pages.	50 months for black and white only pages, or 25 months for color pages.

1 Approximate average A4/letter-size page count based on 5% coverage of individual toner colors. Page counts are only estimations, and usage conditions and print patterns may cause results to vary.

2 Approximate lives are based on 2,000 pages per month.

CAUTION

Hewlett-Packard recommends the use of HP products in this printer. Use of non-HP products may cause problems requiring service that is not covered by the Hewlett-Packard warranty or service agreements.

Locating Consumables

The following figure illustrates the location of each consumable item.

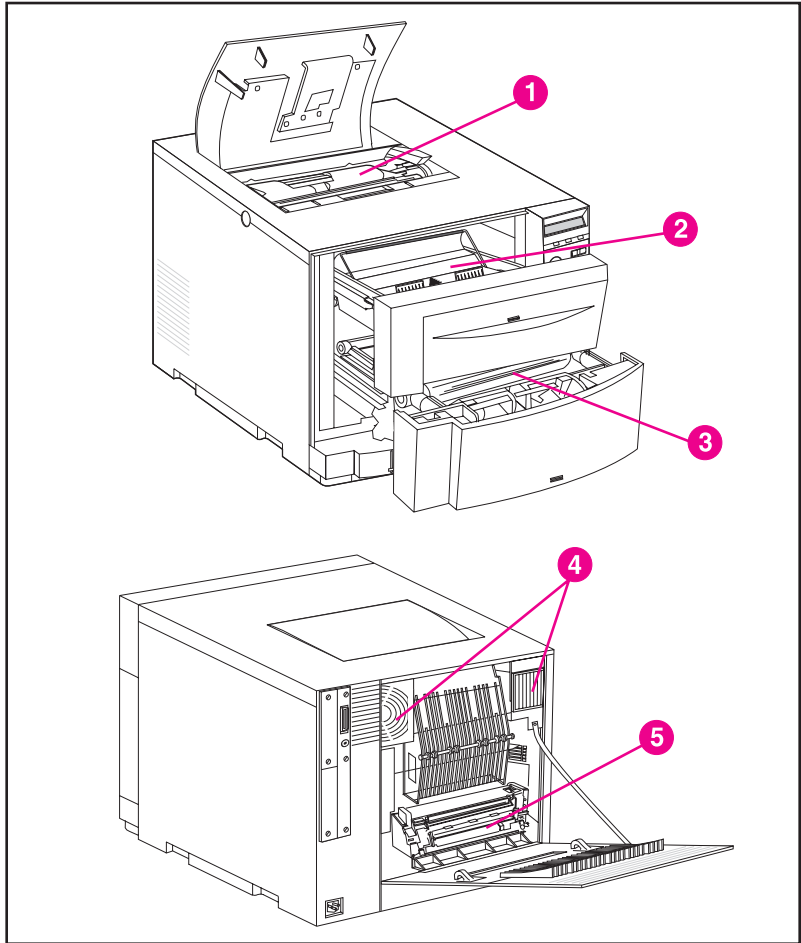

Figure 7-2 Consumable Item Locations

- 1 Toner Cartridges
- 2 Imaging Drum Cartridge
- 3 Transfer Belt
- 4 Air Filters
- 5 Fuser

Environmental Collection Program

Hewlett-Packard encourages responsible disposal of HP LaserJet printer consumable items through its Environmental Collection Program. For details on this program, see the recycling instruction guide enclosed with each consumable item. This program may not be available in all countries/regions.

The following consumable items can be disposed of through the Environmental Collection Program:

- Toner Cartridge
- Imaging Drum Cartridge
- Transfer Belt
- Fuser

Cleaning the Toner Density Sensor

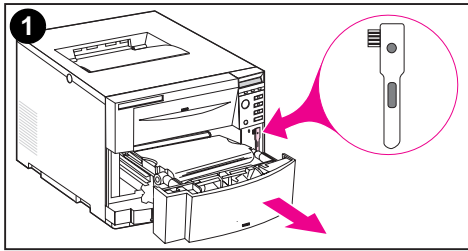

The toner density sensor should be cleaned whenever the imaging drum is replaced or whenever the control panel message DENSITY SENSOR OUT OF RANGE displays.

CAUTION

To avoid scratching the sensor, do not clean it with any paper products.

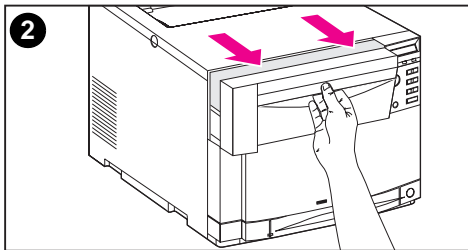

To clean the toner density sensor

- 1 Open the lower front drawer and remove the cleaning brush mounted inside.
- 2 Pull open the top front drawer.
- 3 Remove the imaging drum by the blue handle.
- 4 Use the cleaning brush to remove all dust and toner particles from the sensor as illustrated.

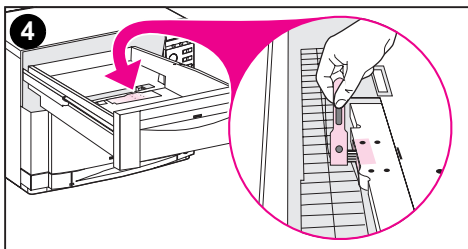
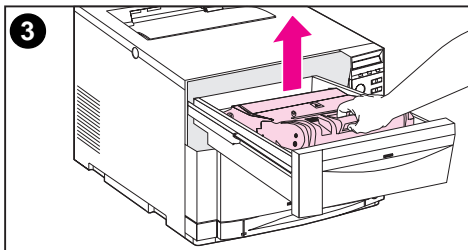

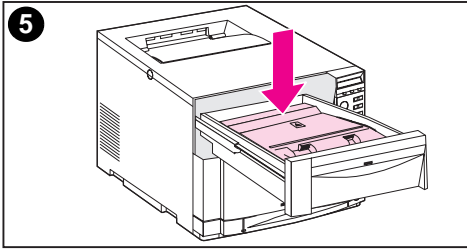

- 5 Re-insert the imaging drum.
- 6 Close the top front drawer.
- 7 Replace the cleaning brush and close the lower front drawer.

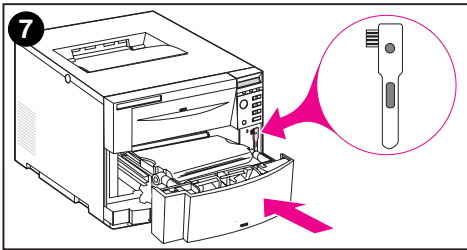
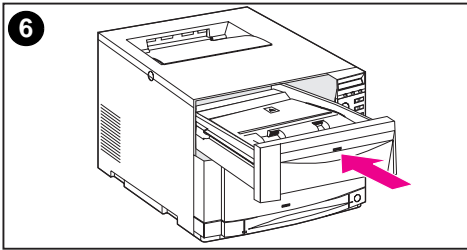

8 Printer Control Panel Messages

Overview

This chapter lists printer control panel messages and explains their meaning. The control panel displays four types of messages. These message types are:

- Status Messages
- Warning Messages
- Attention Messages
- Critical Error Messages

Message Types

Status Messages

Status messages reflect the current state of the printer. They inform the user of normal printer operation and do not require user interaction to clear them. They change as the state of the printer changes. Whenever the printer is ready, not busy, and has no pending warning messages, the status message READY is displayed if the printer is online. If the printer is offline, the message OFFLINE is displayed.

Warning Messages

Warning messages inform you of data and print errors. These messages typically alternate with the READY or OFFLINE messages and remain displayed until you press **Go**. If CLEARABLE WARNING is set to JOB in the printer's configuration menu, then these messages are cleared by the next print job.

Attention Messages

Attention messages inform you that some action must be taken, such as adding paper or clearing a paper jam. For certain errors, the printer continues printing without user intervention. If AUTO CONTINUE is set to ON in the configuration menu, the printer will automatically attempt to return online.

Critical Error Messages

Critical Error messages inform you of a device failure. You can clear some of these messages by turning the printer off and then on. These messages are not affected by the AUTO CONTINUE setting. If a condition persists, service is required.

Printer Control Panel Messages

The following table lists the printer control panel messages for this printer. Printer messages with numeric prefixes are listed in numerical order. Printer messages without numeric prefixes are listed in alphabetical order.

Note Except when the printer is initially turned on, messages are displayed in the display language selected in the printer control panel (such as English, French, or Spanish).

Printer Control Panel Messages

Message	Description	Recommended Action
ACCESS DENIED MENU LOCKED	Displayed for approximately 5 seconds when a user attempts to modify a menu value while control panel locking is enabled.	No action required.
BAD DUPLEXER CONNECTION	The duplex printing accessory is not correctly installed.	1. Check the duplex printing accessory power cord. 2. Turn the printer off and then back on. 3. If the error continues, verify that the duplex printing accessory is correctly installed.
CALIBRATION EXECUTING	The printer is executing an internal color calibration. This process should take approximately 90 seconds.	No action required.
CANCELING JOB	The printer is in the process of canceling a print job. Incoming data for the current job will be discarded.	No action required.
CANNOT DUPLEX CHECK REAR BIN alternates with CANNOT DUPLEX CHECK PAPER	The printer cannot duplex because the rear output bin is open or the media is not supported by the duplex printing accessory.	Close the rear output bin. If the bin is closed, verify that the media is supported by the duplex printing accessory. See Supported Media Weights and Sizes section in Chapter 3.

Printer Control Panel Messages (continued)

Message	Description	Recommended Action
CHECKING PRINTER	The printer is performing an internal test. This process should take approximately 30 seconds. When finished, the printer remains offline.	When the test has finished, press Go to return the printer to the READY state.
CLEARING PAPER FROM PRINTER	The printer has jammed or was turned on and media was detected in the paper path. The printer is attempting to clear these pages.	No action required.
CLOSE FRONT DUPLEX DRAWER	The duplex drawer is not completely closed.	Close the duplex drawer.
CLOSE MIDDLE FRONT DRAWER	The middle front drawer is not completely closed.	Close the middle front drawer.
CLOSE UPPER REAR DOOR	The upper rear door is not completely closed.	Close the upper rear door.
CLOSE TOP COVER	The top cover is not completely closed.	Close the top cover.
CLOSE UPPER FRONT DRAWER	The upper front drawer is not completely closed.	Close the upper front drawer.
CONTINUOUS PAGE PRESS CANCEL JOB	The printer configuration page is being printed continuously.	Press CANCEL JOB to terminate continuous configuration page printing and return the printer to the READY state.
DATA RECEIVED	The printer has received and processed data and is waiting for a formfeed.	Press Go to initiate a formfeed.

Printer Control Panel Messages (continued)

Message	Description	Recommended Action
DENSITY SENSOR OUT OF RANGE alternates with CLEAN DENSITY SENSOR	A density sensor out of range error was detected during a color calibration.	The density sensor may be dirty. Inspect and clean the sensor (see chapter 7 for cleaning instructions).
DRUM ERROR REPLACE DRUM KIT	An error has been detected with a component of the print drum kit.	Replace the print drum kit.
DRUM LIFE LOW REPLACE DRUM KIT	The imaging drum is near the end of its expected life.	Continue printing, or replace the drum kit.
DRUM LIFE OUT REPLACE DRUM KIT	The imaging drum has reached the end of its expected life.	Replace the drum kit.
DUPLEX ERROR CHECK DUPLEXER	An error has occurred in the duplex printing accessory.	Verify that the duplex printing accessory is correctly installed.
EIO X INITIALIZING YYY alternates with DO NOT POWER OFF	The EIO device in slot X is initializing. The YYY value will increment every 10 seconds during this process.	No action required.
EIO X NOT FUNCTIONAL	The EIO slot specified does not have a card installed or is not functional.	No action required.
EVENT LOG EMPTY	SHOW EVENT LOG was selected from the Information Menu, but the event log has no entries.	No action required.
FUSER LIFE LOW REPLACE KIT	The fuser is near the end of its expected life.	Continue printing, or replace the fuser kit.
FUSER LIFE OUT REPLACE KIT	The fuser has reached the end of its expected life.	Replace the fuser kit.

Printer Control Panel Messages (continued)

Message	Description	Recommended Action
INITIALIZING	This message is displayed when the printer is initially turned on.	No action required.
INSTALL DRUM KIT	The drum kit is not installed or is incorrectly installed.	Verify that the drum kit is correctly installed.
INSTALL TRAY 2	Tray 2 is not installed or is not completely closed, preventing media from being printed from Tray 3.	Verify that Tray 2 is completely closed.
MEMORY FULL STORED DATA LOST	The printer has no available memory. The current job may not print correctly. Some downloaded fonts may have been deleted.	Try printing simplified pages. If this does not resolve the problem, add printer memory.
MEMORY SETTINGS CHANGED	The I/O buffering settings were changed by the printer because there is not enough memory available to use the previous settings.	No action required. Adding printer memory may prevent this from occurring.
MEMORY SHORTAGE JOB CLEARED	The available memory was not enough to continue printing. The remainder of the job was canceled.	Adding printer memory may prevent this from occurring.
MEMORY SHORTAGE PAGE SIMPLIFIED	The image was too large for available printer memory. Therefore, the printer compressed the image, resulting in lost data.	Adding printer memory may prevent this from occurring.
NO JOB TO CANCEL	CANCEL JOB was pressed but there is no active job or buffered data to cancel. The printer automatically returns to the READY state.	No action required.
OFFLINE	The printer is offline and there are no error messages pending.	Press Go to return the printer to the READY state.

Printer Control Panel Messages (continued)

Message	Description	Recommended Action
PLEASE WAIT	The printer is in the process of purging data so that it can go offline or into the menus.	No action required.
POWERSAVE ON	The printer is in PowerSave mode. This message is cleared by pressing any key or by the receipt of a print job.	No action required.
PRESS GO TO PRINT alternates with PRESS SELECT TO CHANGE TONER	The top cover was opened and closed when the printer was not in toner cartridge replacement mode.	Press Go to resume printing or press SELECT to enter the toner replacement menu.
PRINTER LANGUAGE NOT AVAILABLE	The printer received a request for a language (personality) that does not exist in the printer.	No action required.
PRINTING CALIBRATION PAGE	The color calibration page is being generated. The printer returns to the READY state upon completion of this page.	No action required.
PRINTING CONFIGURATION	The configuration page is being printed. The printer returns to the READY state upon completion of this page.	No action required.
PRINTING FONT LIST	A typeface list for the available personalities is being printed. The printer returns to the READY state upon completion of these pages.	No action required.
PRINTING MENU MAP	The printer menu map is being printed. The printer returns to the READY state upon completion of this page.	No action required.

Printer Control Panel Messages (continued)

Message	Description	Recommended Action
PROCESSING JOB	The printer is processing the current job.	No action required.
READY	The printer is online and ready to receive data, and no status or device attendance messages are pending.	No action required.
REINSTALL TRANSFER BELT	The transfer belt is broken or incorrectly installed.	Inspect the transfer belt and replace it if necessary.
REMOVE PAPER TOP OUTPUT BIN	The top output bin is full.	Remove media from the top output bin.
RESETTING MEMORY	The printer is executing a memory reset. The printer returns to the READY state upon completion of this process.	No action required.
RESETTING VALUES FINISHED	The color calibration density values have been reset to their default values.	No action required.
RESTORING FACTORY SETTINGS	The printer is executing a RESTORE FACTORY SETTINGS or a COLD RESET.	No action required.
TONER CMYK LOW	The toner cartridge specified is low on toner.	Printing will continue until a TONER OUT message appears. To change the toner cartridge now, press SELECT .
TONER CMYK OUT	The toner cartridge specified is out of toner.	Change the specified toner cartridge now to ensure print quality.
TONER CMYK LOW alternates with PRESS SELECT TO CHANGE TONER	The toner cartridge specified is low on toner and must be replaced now.	Press SELECT to enter the toner replacement menu.
TONER CMYK OUT alternates with PRESS SELECT TO CHANGE TONER	The toner cartridge specified is out of toner. If the TONER OUT setting in the CONFIGURATION MENU is set to OVERRIDE, pressing Go will resume printing.	Press SELECT to enter the toner replacement menu. Press Go to resume printing without changing the cartridge.

Printer Control Panel Messages (continued)

Message	Description	Recommended Action
TONER POSITION [COLOR] = [STATE]	Indicates the current state of a particular toner cartridge. This message is displayed when SELECT is pressed while a TONER LOW/OUT message is displayed.	If necessary, replace the specified toner cartridge.
TRANSFER KIT LOW REPLACE KIT	The transfer kit is near the end of its expected life.	Continue printing, or replace the transfer kit.
TRANSFER KIT OUT REPLACE KIT	The transfer kit has reached the end of its expected life.	Replace the transfer kit.
TRAY X EMPTY [TYPE] [SIZE]	The specified tray is empty but the current job does not need this tray to complete the job.	No action required.
TRAY X LOAD [TYPE] [SIZE]	The specified media type and size need to be loaded into the requested tray.	Load the specified media type and size into the requested tray. Press Go to override this request and cause the page to be printed on different media.
TRAY X OPEN	The specified tray is not completely closed.	Close the specified tray.
WARMING UP	The printer fuser is heating up. Printing will continue when the fuser reaches the proper temperature.	No action required.
WASTE TONER FULL REPLACE DRUM KIT	The waste toner receptacle in the drum kit is full.	Replace the drum kit.

Printer Control Panel Messages (continued)

Message	Description	Recommended Action	
13.XX PAPER JAM	A jam has occurred. XX specifies the type of paper jam. <u>XX Description</u> 0 Paper jam in paper feed area 1 Paper jam in fusing unit area 2 Paper jam in fusing unit area 3 Paper jam in reversing area 4 Paper jam in reversing area 5 Paper jam in path to duplexer area 6 Paper jam in path to duplexer area 7 Paper jam in paper path area 8 Door open jam 9 Unexpected media type 10 Unexpected media type 11 Unexpected media type	See chapter 9 for instructions on clearing jams.	
	<i>13.XX PAPER JAM alternates with one of the following jam access messages:</i>		
	CHECK ALL REAR DOORS		Open the rear duplex cover (if installed) and remove any jammed media. Open the upper rear door and remove any jammed media from the rear paper path and fuser area.
	CHECK MIDDLE FRONT DRAWER		Open the middle front drawer and remove any jammed media.
	CHECK FRONT DUPLEX DRAWER	Open the front duplex drawer and remove any jammed media.	
13.1 JAM: OPEN MIDDLE DRAWER alternates with CHECK IN REAR OF DRAWER	A jam has occurred inside the middle front drawer area. The jam may be located in the fuser area.	Open the middle front drawer and carefully inspect for any media. Be sure to inspect the fusing area. You may need to access the fusing area through the rear door. Remove any jammed media.	

Printer Control Panel Messages (continued)

Message	Description	Recommended Action
20 INSUFFICIENT MEMORY alternates with PRESS GO TO CONTINUE	More data has been received from the computer than fits in the printer's internal memory.	To continue printing, press Go . Only the amount of data that fits in the printer's internal memory is printed. Adding more memory should resolve this problem.
22 EIO X BUFFER OVERFLOW alternates with PRESS GO TO CONTINUE	The I/O buffer for the EIO card in slot "X" has overflowed.	Press Go to resume printing and then resend the job.
22 PARALLEL I/O BUFFER OVERFLOW alternates with PRESS GO TO CONTINUE	The printer's parallel buffer has overflowed.	Press Go to resume printing and then resend the job.
40 EIO X DATA ERROR alternates with PRESS GO TO CONTINUE	A connection with the card in the specified slot has been broken.	Press Go to continue printing.
41.3 UNEXPECTED PAPER SIZE alternates with CHECK PAPER IN TRAY X	A tray is configured for a specific paper size, but the sheet loaded is a different size.	Load the proper size paper in the tray or reconfigure the tray for the paper size it contains. Then press Go to continue printing.
41.5 UNEXPECTED PAPER TYPE alternates with CHECK PAPER IN TRAY X	A tray is configured for a specific media type, but a different media type is loaded.	Load the proper media type in the tray or reconfigure the tray for the media type it contains.

Printer Control Panel Messages (continued)

Message	Description	Recommended Action
49 ERROR (XXXX) CYCLE POWER	A critical software error has occurred.	Turn the printer off and then on to clear the error. If this does not solve the problem try the following: 1) Cancel the current print job from your PC or server. Resend the print job. If this does not work, try sending a different job. 2) If your computer is connected to the printer through a parallel cable, verify that the cable is connected correctly and is of good quality. 3) If the problem persists, call service.
50.X FUSER ERROR	A fusing error has occurred. X indicates the error type as follows: <u>X</u> <u>Description</u> 1 Low fuser temperature 2 Fuser warm up service 3 High fuser temperature 4 Faulty fuser 5 Fuser voltage mismatch 6 Fuser heater cutoff 7 Fuser motor malfunction	Clear the error by turning the printer off and then on. If the problem persists, call service. For 50.5 Fuser Errors (Fuser voltage mismatch), verify that the fuser is the same voltage type as the printer.
51 LASER ERROR	A laser error has occurred due to a beam detect error or laser failure.	Clear the error by turning the printer off and then on. If the problem persists, call service.
52 SCANNER ERROR	A scanner failure has occurred.	Clear the error by turning the printer off and then on. If the problem persists, call service.

Printer Control Panel Messages (continued)

Message	Description	Recommended Action
53.XY.ZZ PRINTER ERROR	<p>Indicates a memory error. If a DIMM caused the error, the DIMM will not be recognized. Values of X, Y, and Z are as follows:</p> <p>X <u>Memory Type</u></p> <p>0 ROM</p> <p>1 RAM</p> <p>Y <u>Device Location</u></p> <p>0 On board</p> <p>1 DIMM Slot 1</p> <p>2 DIMM Slot 2</p> <p>3 DIMM Slot 3</p> <p>ZZ <u>Error Number</u></p> <p>0 Unsupported memory</p> <p>1 Unrecognized memory</p> <p>3 Failed RAM test</p>	<p>Clear the error by turning the printer off and then on. Verify that the DIMM is correctly installed. If the DIMM is correctly installed, replace the DIMM. See appendix A for DIMM installation instructions. If the problem persists, call service.</p>
54.X PRINTER ERROR	<p>An error has occurred where X is indicated below.</p> <p>X <u>Description</u></p> <p>1 Internal power failure</p> <p>2 Carousel rotation failure</p> <p>3 Density sensor out of range</p> <p>4 Optional equipment not available</p> <p>5 Waste toner sensor malfunction</p>	<p>Clear the error by turning the printer off and then on. If the problem persists, call service.</p>
55 DC CONTROLLER ERROR	<p>The print engine is not communicating with the formatter.</p>	<p>Clear the error by turning the printer off and then on. If the problem persists, call service.</p>

Printer Control Panel Messages (continued)

Message	Description	Recommended Action
57.X FAN ERROR	An error has occurred where X is indicated below: X <u>Description</u> 1 Fan motor 1 malfunction 2 Fan motor 2 malfunction	Clear the error by turning the printer off and then on. If the problem persists, call service.
57.3 FAN ERROR alternates with CLOSE UPPER FRONT DRAWER	The upper front drawer may not be completely closed preventing a connection to fan motor 3.	Verify that the upper front drawer is completely closed.
62 NO SYSTEM	There is a printer firmware error.	Clear the error by turning the printer off and then on. If the problem persists, call service.
62.X PRINTER ERROR	Indicates a problem with internal memory. X indicates the location as follows: X <u>Description</u> 0 Internal memory 1 Memory in DIMM slot 1 2 Memory in DIMM slot 2 3 Memory in DIMM slot 3	Clear the error by turning the printer off and then on. If the problem persists, call service.
68 NVRAM ERROR CHECK SETTINGS alternates with PRESS GO TO CONTINUE	One or more settings saved in the non-volatile storage device are invalid. Some settings may have been reset to factory defaults.	Check printer settings to determine which values have changed. Clear the message by pressing Go . If the problem persists, call service.
68 NVRAM FULL CHECK SETTINGS alternates with PRESS GO TO CONTINUE	Indicates that a non-volatile storage device is full. Some settings may have been reset to factory defaults.	Check printer settings to determine which values have changed. Clear the message by pressing Go . If the problem persists, call service.
79 SERVICE (XXXX) PRINTER ERROR	A hardware error has occurred. The XXXX indicates the error type.	Clear the error by turning the printer off and then on. If the problem persists, call service.
8X SERVICE (XXXX) EIO ERROR	A critical EIO failure has occurred. X indicates the slot number of the device. XXXX indicates the error type.	Clear the error by turning the printer off and then on. If the problem persists, call service.

9 Solving Problems with the Printer

Overview

This chapter provides information on solving and preventing printer problems such as paper jams and image defects. The chapter includes the following sections:

- Basic Troubleshooting Checklist
- Paper Jam Locations
- Paper Jam Recovery
- Common Causes of Paper Jams
- Paper Jam Messages
- Clearing Paper Jams
- Media-Handling Problems
- Printer Response Problems
- Printer Control Panel Problems
- Solving Print Quality Problems
- Color Printing Problems
- Incorrect Printer Output
- Software Application Problems

Basic Troubleshooting Checklist

If you are experiencing problems with the printer, this checklist may help identify the cause of the problem.

- Is the printer connected to power?
- Is the printer in the READY state?
- Are all necessary cables connected?
- Are any messages displayed on the control panel?
- Were recently replaced toner cartridges installed correctly? Was the pull tab on the cartridge removed?
- Were recently installed consumable items (fuser kit, transfer kit, imaging drum kit) installed correctly?
- Is the power switch (standby button) pushed in?

If you cannot find solutions to printer problems in this guide, contact an HP service and support center. (See the Warranty and Support Information appendix in this guide.)

For additional information on installation and setup of the printer, see the getting started guide for this printer.

Paper Jam Locations

Use this illustration to troubleshoot paper jams in the printer. For instructions on clearing paper jams, see the sections later in this chapter.

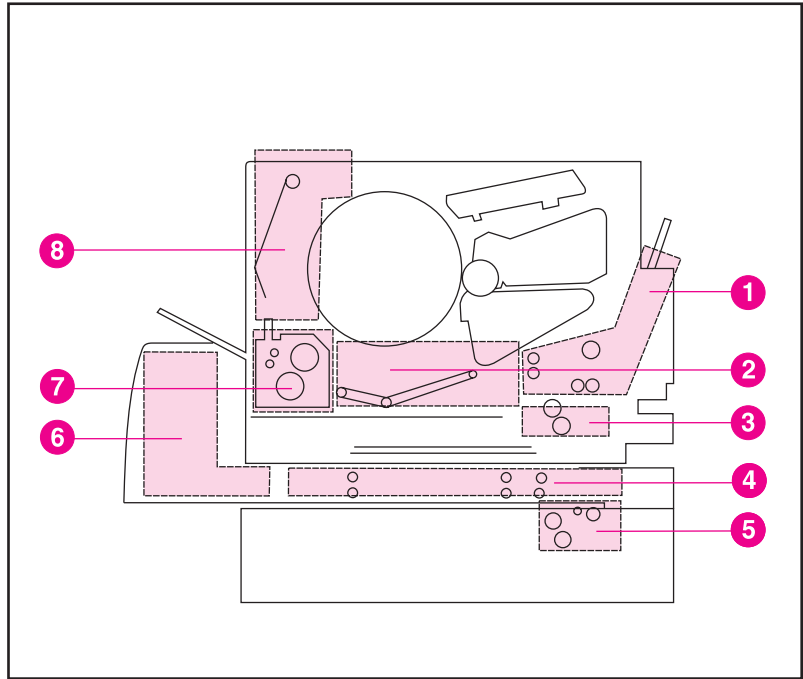

Figure 9-1

Paper Jam Locations (shown with the optional 500-sheet paper feeder and duplex printing accessory installed)

- 1 Input Tray 1 area
- 2 Transfer Belt area
- 3 Input Tray 2 area
- 4 Front Duplex Drawer area
- 5 Tray 3 (500-sheet paper feeder) area
- 6 Rear Duplex Cover area
- 7 Fuser area
- 8 Rear Paper Path area

Paper Jam Recovery

This printer provides Paper Jam Recovery, a feature that allows you to set whether the printer should attempt to automatically recover from paper jams. If Paper Jam Recovery is enabled, when a paper jam occurs, all pages affected by the jam will be reprinted. The options are:

ON	Printer will attempt to reprint jammed pages.
OFF	Printer will not attempt to reprint jammed pages.

Note

During the recovery process, the printer may reprint several good pages that were printed before the paper jam occurred. Be sure to remove any duplicated pages.

To enable Paper Jam Recovery

- 1 Press **MENU** until CONFIGURATION MENU displays.
- 2 Press **ITEM** until JAM RECOVERY displays.
- 3 Press **VALUE** until ON displays.
- 4 Press **SELECT** to save the setting.
- 5 Press **GO** to return the printer to the READY state.

To improve print speed, you may want to disable Paper Jam Recovery. To disable Paper Jam Recovery, select OFF in step 3 above. If Paper Jam Recovery is disabled, the pages involved in a jam will not be reprinted.

Common Causes of Paper Jams

The following table lists common causes of paper jams and suggested solutions for resolving them.

Cause	Solution
Print media does not meet HP-recommended media specifications.	See chapter 3 for supported media specifications.
A consumable item is installed incorrectly, causing repeated jams.	Verify that the consumable item is correctly installed.
You are reloading paper that has already passed through a printer or copier.	Do not load media that has been printed or copied.
An input tray is loaded incorrectly.	Remove any excess media from the input tray. Press media down in the input tray so it fits below the tabs. See chapter 3 for instructions on loading media.
Input tray guides are not adjusted correctly.	Adjust input tray guides so they hold media firmly in place without bending it.
Print media is binding or sticking together.	Remove media, flex it, rotate it 180 degrees or flip it over. Reload media into the input tray. Do not fan media.
Media size specified in software does not match the input tray's media size configuration.	Verify that the media size selected in your software application or printer driver matches the media size specified in the printer control panel for the tray you are printing from.
Print media is in poor condition.	Replace the print media.
Printer consumable items have reached the end of their useful life.	Check the printer control panel for messages prompting you to replace consumable items, or print a configuration page to verify the remaining life of the consumable items. See chapter 3 for information on consumable items.
Media was not stored correctly.	Replace the print media. Media should be stored in its original packaging in a dry area.

Paper Jam Messages

The following table lists printer jam messages and their corresponding recommended actions. Instructions for clearing these jams are provided in the following pages.

Message	Description	Recommended Action
13.XX PAPER JAM alternates with CHECK ALL REAR DOORS	Media is jammed in the rear paper path or rear duplexing area.	Open the rear duplex cover (if installed) and remove any jammed media. Open the upper rear door and remove any jammed media.
13.XX PAPER JAM alternates with CHECK MIDDLE FRONT DRAWER	Media is jammed in the transfer belt area.	Open the middle front drawer and remove any jammed media.
13.XX PAPER JAM alternates with CHECK FRONT DUPLEX DRAWER	Media is jammed in the front duplexing area.	Open the front duplex drawer and remove any jammed media.
13.1 JAM: OPEN MIDDLE DRAWER alternates with CHECK IN REAR OF DRAWER	A jam has occurred inside the middle front drawer area. The jam may be located in the fuser area.	Open the middle front drawer and carefully inspect for any media. Be sure to inspect the fusing area. You may need to access the fusing area through the rear door. Remove any jammed media.

These messages indicate probable jam locations. If the recommended action does not resolve the problem, the printer will display another suggested jam location.

Clearing Paper Jams

The following pages illustrate how to clear paper jams in specific areas of the printer.

Tips for Avoiding Paper Jams

- Verify that media is correctly loaded in the input trays and that all length and width guides are correctly set.
- Try turning over the stack of media in the tray.
- Do not print on torn, worn, or irregular media.
- Do not print on previously printed media.
- Verify that the media you are using is within the maximum and minimum specifications that the printer supports. See the media specifications table in the chapter on common printing tasks.
- Verify that the input tray is configured for the type of media loaded. (When Tray 1 is in TRAY 1 MODE=CASSETTE mode, verify that the tray is configured for the size of media loaded.)
- Verify that input trays are not overloaded.
- Avoid fanning media. Fanning media causes static electricity, which can lead to media jams.
- Remove all portions of jammed media to avoid repeated jams.
- After removing media that has jammed, inspect other areas of the printer to verify that all media has been removed.
- Reassemble all pieces of torn media to confirm that you have the entire sheet.
- If the printer still continues to jam, contact HP Customer Support or your authorized HP service provider. See the Warranty and Support Information appendix for worldwide customer support numbers.

Clearing Jams in the Middle Front Drawer Area

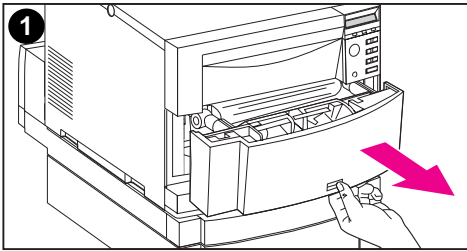

- 1 Pull open the middle front drawer to access jammed media.

Note

When removing the transfer belt assembly, do not touch the transfer belt material.

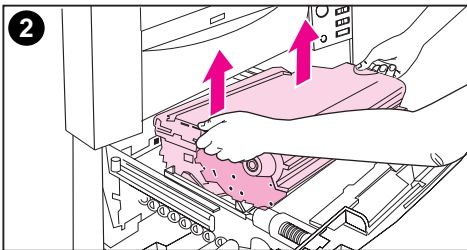

- 2 Remove the transfer belt assembly by lifting up on its blue handles.

- 3 Remove any jammed or torn media. Be sure to lift the metal flap by its green tab and remove any jammed media.

Note

Be sure to inspect the rear area inside the drawer and remove jammed or torn media.

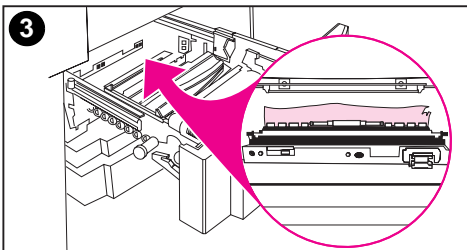

- 4 Reinstall the transfer belt.

- 5 Close the drawer. The printer will warm up and return to the READY state.

Note

If this action does not resolve the problem, the printer will display an alternate message.

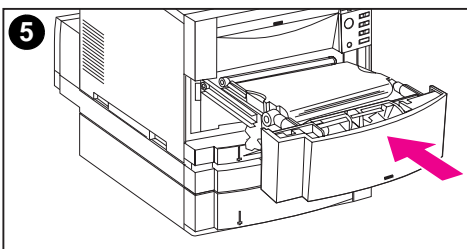
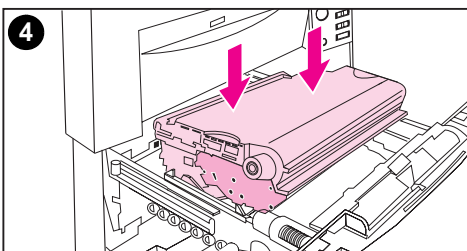

Clearing Jams in the Tray 2 Area

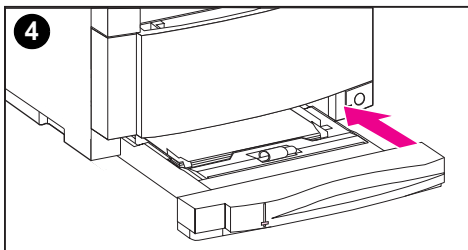
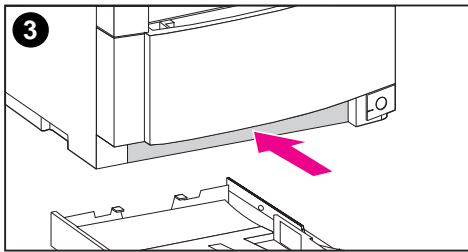
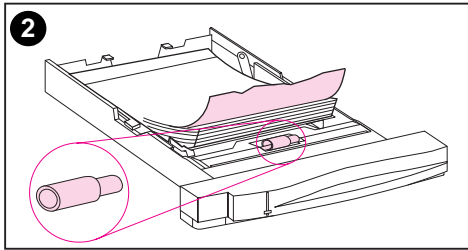
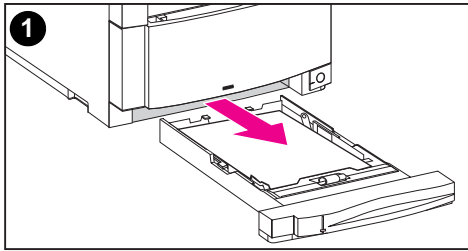

Note

It is a good idea to inspect the input trays when clearing paper jams. However, opening and closing input trays has no effect on clearing paper jam messages.

- 1 Pull out Tray 2 and place it on a flat surface.
- 2 Inspect the pickup rollers and remove jammed media. Be sure to remove any torn pieces of media.
- 3 Inspect inside the printer and remove all jammed or torn media.
- 4 Close Tray 2.

Clearing Jams in the Optional Tray 3 Area

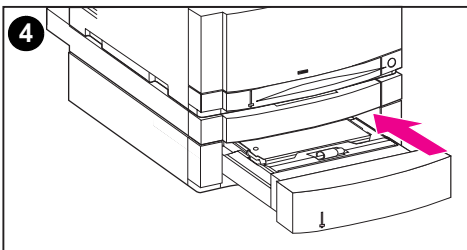
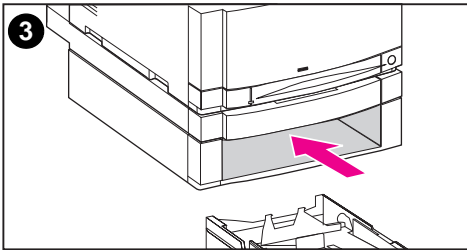
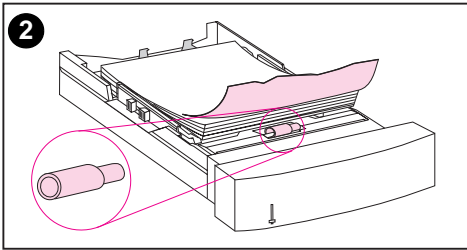
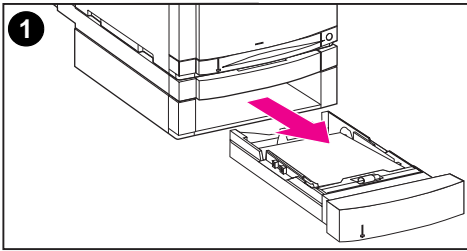

Note

It is a good idea to inspect the input trays when clearing paper jams. However, opening and closing input trays has no effect on clearing paper jam messages.

- 1 Pull out Tray 3 and place it on a flat surface.
- 2 Inspect the pickup rollers and remove jammed media. Be sure to remove any torn pieces of media.
- 3 Inspect inside the printer and remove all jammed or torn media.
- 4 Close Tray 3.

Clearing Jams in the Rear Door Areas

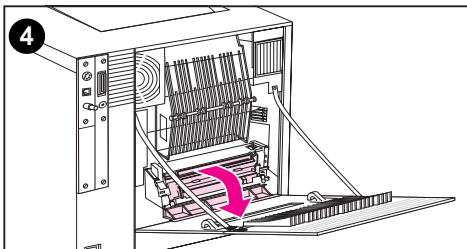
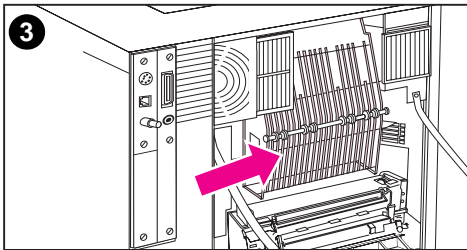
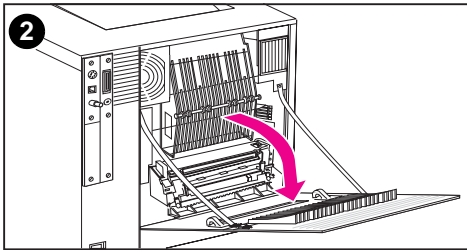
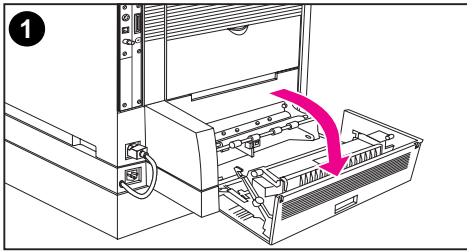

WARNING!

Do not touch the fuser: it is hot and could cause burns! The fuser's operating temperature is 190° C (374° F). Wait 30 minutes to allow the fuser to cool down before working in this area.

- 1 If the duplex printing accessory is installed, open the rear duplex cover.
- 2 Open the upper rear door.
- 3 Inspect the upper paper path area inside the rear door and remove any jammed or torn media.
- 4 Open the fuser door and remove any jammed media.

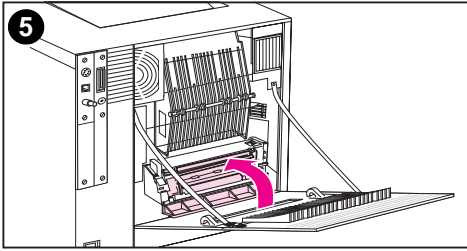

5 Close the fuser door.

6 Close the upper rear door.

7 Close the rear duplex cover if it was opened. The printer will warm up and return to the READY state.

Note

If these actions do not resolve the problem, the printer will display an alternate jam message.

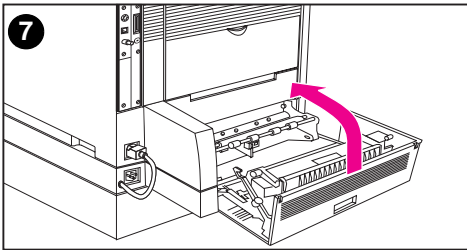
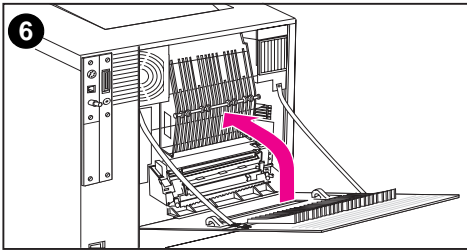

Clearing Jams in the Front Duplex Drawer Area

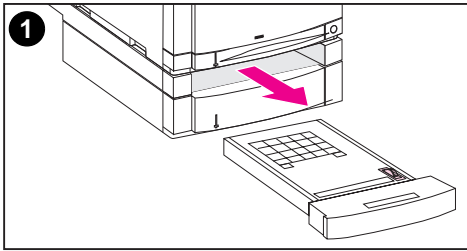

1 Pull out the duplex drawer and place it on a flat surface.

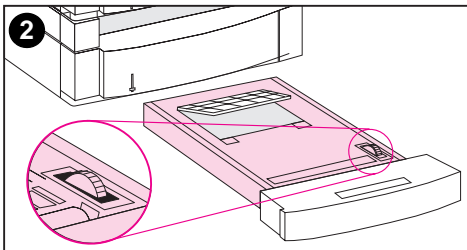

2 Remove jammed media from the duplex drawer. Rotate the thumbwheel to eject jammed media. Be sure to remove any torn pieces of media.

3 Inspect inside the printer and remove jammed media. Be sure to remove any torn pieces of media.

4 Close the duplex drawer. The printer will return to the READY state within a few minutes.

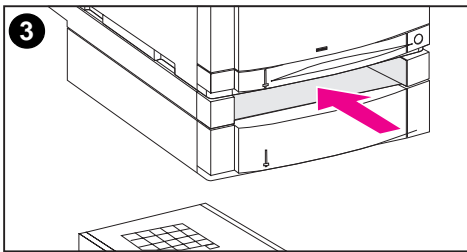

Note

If these actions do not resolve the problem, the printer will display an alternate jam message.

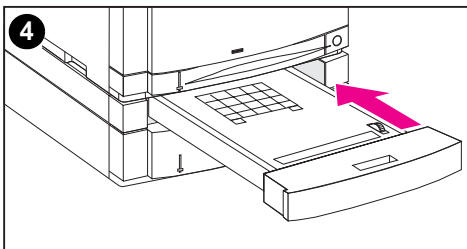

Media-Handling Problems

Use only media that meets the specifications outlined in the *HP LaserJet Printer Family Paper Specification Guide*.

For media specifications for this printer, see the “Supported Media Weights and Sizes” section in chapter 3.

Printer feeds multiple sheets

Cause	Solution
The input tray is overfilled.	Remove excess media from the input tray.
The media is not under the tabs in the input tray (Trays 2 and 3).	Open the input tray and verify that the media is seated under the metal tabs.
Print media is sticking together.	Remove media, flex it, rotate it 180 degrees or flip it over, and then reload it into the tray. Note: Do not fan media. Fanning can cause static electricity, which can cause media to stick together.
Media does not meet the specifications for this printer.	Only use media that meets the media-use specifications for this printer (see the supported media weights and sizes section in chapter 3).

Printer feeds incorrect page size

Cause	Solution
The correct media size is not loaded in the input tray.	Load the correct size media in the input tray.
The correct media size is not selected in your software application or printer driver.	Select the correct media size from your software application or printer driver.
The correct media size for Tray 1 is not selected in the printer control panel.	From the control panel, select the correct media size for Tray 1.

Media does not feed automatically

Cause	Solution
Manual feed is selected in the software application.	This printer does not support manual feed. Do not select manual feed in your software application.
The correct size of media is not loaded.	Load the correct size of media.
The input tray is empty.	Load media into the input tray.
Media from a previous jam has not been completely removed.	Open the printer and remove any media in the paper path. Closely inspect the fuser area for jams. See the section in this chapter for information on clearing paper jams.

Media does not feed from Input Trays 2 or 3

Cause	Solution
Manual feed is selected in the software application.	This printer does not support manual feed. Do not select manual feed in your software application.
The correct size of media is not loaded.	Load the correct size of media.
The input tray is empty.	Load media in the input tray.
The correct media type for the input tray is not selected in the printer control panel.	From the printer control panel, select the correct media type for the input tray.
Media from a previous jam has not been completely removed.	Open the printer and remove any media in the paper path. Closely inspect the fuser area for jams. See the section earlier in this chapter on clearing paper jams.
Media-size knob is incorrectly set (Tray 3).	Verify that the media-size knob on the side of Tray 3 is set to the proper media size.
Tray 3 (500-sheet paper feeder) does not appear as an input tray option.	Tray 3 only displays as an option if it is installed. Verify that Tray 3 is correctly installed. Verify that the printer driver has been configured to recognize Tray 3.

Transparencies or glossy paper will not feed

Cause	Solution
The correct media type is not specified in your software or printer driver.	Verify that the correct media type is selected in your software or printer driver.
The input tray is overfilled.	Remove excess media from the input tray. Do not load more than 50 transparencies in any tray.
Media in another input tray is the same size as the transparencies and the printer is defaulting to the other tray.	Make sure that the input tray containing the transparencies or glossy paper is selected in your software application or printer driver. Use the printer control panel to configure the tray to the media type loaded.

Envelopes jam or will not feed in the printer

Cause	Solution
Envelopes are loaded in an unsupported tray. Envelopes should only be printed from Tray 1.	Load envelopes into Tray 1.
Envelopes are curled or damaged.	Try using different envelopes.
Envelopes are sealing because the moisture content is too high.	Try using different envelopes.
Envelope orientation is incorrect.	Verify that the envelope is loaded correctly. See the section on loading envelopes in chapter 3.
The envelopes being used are not supported by this printer.	See the section on supported media weights and sizes in chapter 3 or the <i>HP LaserJet Printer Family Paper Specification Guide</i> .

Output is curled or wrinkled

Cause	Solution
Media does not meet the specifications for this printer.	Only use media that meets the media-use specifications for this printer (see the supported media weights and sizes section in chapter 3).
Media is damaged or in poor condition.	Remove media from the input tray and load media that is in good condition.
Printer is operating in an excessively humid environment.	Verify that the printing environment is within humidity specifications.
You are printing large, solid-filled areas.	Large, solid-filled areas can cause excessive curl. Try using a different pattern.
Media used was not stored correctly and may have absorbed moisture.	Remove media and replace it with media from a fresh, unopened package.
Media has poorly cut edges.	Remove media, flex it, rotate it 180 degrees or turn it over, and then reload it into the input tray. If the problem persists, replace the media.

Printer Response Problems

No display message

Cause	Solution
The printer's power switch (standby button) is in the standby position.	Verify that the printer is on. Fans may run while the printer is in standby mode (off).
The printer's memory DIMMs are defective or installed incorrectly.	Verify that the printer's memory DIMMs are correctly installed and are not defective. See Appendix A for DIMM installation instructions.
The power cord is not firmly plugged into both the printer and the power receptacle.	Turn off the printer and then disconnect and reconnect the power cord. Turn the printer back on.
The line voltage is incorrect for the printer power configuration.	Connect the printer to a proper voltage source, as specified on the Power Rating Label on the back of the printer.
The power cord is damaged or excessively worn.	Replace the power cord.
The power source receptacle is not working correctly.	Connect the printer to a different power receptacle.

Printer is on, but nothing prints

Cause	Solution
The printer's READY indicator light is not lit.	Press Go to return the printer to the READY state.
The top cover is not closed properly.	Close the top cover firmly, verifying that it is properly latched.
The Data indicator is flashing.	The printer is probably still receiving data. Wait for the Data indicator to stop flashing.
TONER [CMYK] OUT appears on the printer display.	Replace the toner cartridge specified on the printer display.
A printer message other than READY appears on the printer control panel.	See chapter 8 for an explanation of printer control panel messages.
Your parallel port may have a DOS timeout error.	Add a MODE command to your AUTOEXEC.BAT file. See your DOS manual for additional information.

Printer is on, but is not receiving data

Cause	Solution
The printer's READY indicator light is not lit.	Press Go to return the printer to the READY state.
The top cover is not closed properly.	Close the top cover firmly.
A printer message other than READY appears on the printer control panel.	See chapter 8 for troubleshooting information.
The interface cable is not correct for this configuration.	Select the correct interface cable for your configuration. See the chapter on printer interfaces for more information.
The interface cable is not securely connected to both the printer and the computer.	Disconnect and reconnect the interface cable.
The printer is not configured correctly.	See chapter 6 for configuration information.
The interface configurations on the printer's configuration page do not match the configurations on the host computer.	Configure the printer to match your computer configuration.
Your computer is not working properly.	Try using an application that you know works properly to check your computer, or, in DOS, type <code>Dir > Prn</code> at the DOS prompt.
The computer port that the printer is connected to is not configured or is not working properly.	Run another peripheral connected to this port to check the port operation.
The printer has not been correctly named for your network or Macintosh computer.	Use the appropriate utility to name the printer on the network. For Macintosh computers, name the printer from within the Chooser menu.

Printer will not duplex

Cause	Solution
Printer is not recognizing the duplex printing accessory.	Print a configuration page to verify configuration. Set up the printer driver to recognize the duplex printing accessory. Verify that the duplex printing accessory power cord is plugged in.
You are trying to duplex on an unsupported media.	Verify that the media you are using is supported for duplex printing.
The door to the rear output bin is open.	Close the door to the rear output bin.

Tray 3 is incorrectly installed

Cause	Solution
Verify that the tray is correctly installed.	Print a configuration page to confirm that Tray 3 is configured properly.

Printer is on, but will not print a PostScript file

Cause	Solution
The PS (PostScript Emulation) personality is not selected.	Select PS or AUTO for the printer language. See the chapter on using the printer control panel.
The correct driver is not selected in your software application or printer driver.	Select the driver for PostScript Emulation for this printer in your software application or printer driver.
The printer is not properly configured.	See chapter 6 for configuration information.
The computer port is not configured or is not working properly.	Run another peripheral connected to this port to verify that the port is working properly.
The printer has not been correctly named for your network or for a Macintosh computer.	Use the appropriate utility to name the printer on the network. For Macintosh computers, name the printer from within the Chooser menu.

Unable to select the printer from the computer

Cause	Solution
If you are using a switch box, the printer may not be selected for your computer.	Select the correct printer through your switch box.
The printer's READY indicator light is not lit.	Press Go to return the printer to the READY state.
The input tray specified is empty.	Load the correct size media into the input tray.
A printer message other than READY appears on the printer control panel.	See the chapter on printer control panel messages.
The correct printer driver is not installed in your computer.	Install the correct printer driver.
The correct printer and port are not selected on your computer.	Select the correct printer and port.
Your network is not configured properly for this printer.	Use your network software to verify the printer's network configuration, or consult with your network administrator.
The power source receptacle is not working correctly.	Connect the printer to a different power receptacle.

Printer Control Panel Problems

Control panel settings work incorrectly

Problem	Solution
The printer control panel display is blank or is not lit even when the fan is running.	Fans may run while the printer is in standby mode (off). Press the printer's power switch to turn the printer on.
Printer settings in your software application or printer driver are different from the printer control panel settings.	Settings in your software application or printer driver override printer control panel settings. Verify that the settings in your software application or printer driver are correct.
Control panel settings were not correctly saved after they were changed.	Reselect the control panel settings and then press [Select]. An asterisk (*) should appear to the right of the setting.
The Data indicator is lit and there are no pages printing.	Buffered data exists in the printer. Pressing [Go] prints the buffered data using current control panel settings and then activates the new control panel settings.
If you are on a network, another user may have changed printer control panel settings.	Consult your network administrator to coordinate changes to printer control panel settings.

Unable to select Tray 3 (optional 500-sheet paper feeder)

Problem	Solution
Tray 3 (500-sheet paper feeder) does not appear as an input tray option.	Tray 3 only displays as an option if it is installed. Verify that Tray 3 is correctly installed. Verify that the printer driver has been configured to recognize Tray 3.

Solving Print Quality Problems

This section provides solutions for various print quality problems.

Print quality problems could be caused by consumable items that are past their rated life. If you are experiencing print quality problems, verify that there are no consumable replacement messages displayed on the printer control panel. Then print out a printer configuration page to verify the remaining life of consumables items. See chapter 2 for instructions on printing a configuration page.

Toner smear

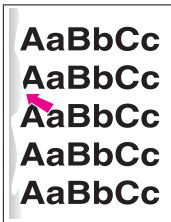

Problem	Solution
Toner smears appear on the back of pages.	The transfer belt may be dirty. This problem should correct itself within 5 or 10 printed pages. If the message TRANSFER KIT LOW REPLACE KIT is displayed on the printer control panel, replace the transfer kit. See chapter 7 for the location of the transfer belt.
You recently changed media size.	Print 5 to 10 pages to clear any smearing.
The printer recently had a media jam or the printer fed multiple sheets of media.	Print 5 to 10 pages to clear any smearing.

Vertical lines or streaks

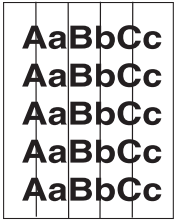

Problem	Solution
White lines or streaks appear only in the black areas of print.	Print several configuration pages. The lines or streaks should clear within a few pages. Try reprinting your print job. If the problem persists, replace the black toner cartridge.
White lines or streaks appear only in a particular color.	Print several configuration pages. The lines or streaks should clear within a few pages. Try reprinting your print job. If the problem persists, replace the toner cartridge for the color with the lines or streaks.

Vertical bands or very dark backgrounds



Problem	Solution
Vertical colored bands or dark black or brown backgrounds appear on the page.	If the problem persists after 10 pages, print out a configuration page to verify the remaining life of the imaging drum. Replace the imaging drum if necessary.

Faded print, random faded areas, or speckles



Problem	Solution
The message TRANSFER KIT LOW REPLACE TRANSFER KIT appears on the printer control panel.	Print out a configuration page to verify the remaining life of the transfer belt. Replace the transfer belt if necessary.
The moisture content of your paper is uneven or too low.	Use paper from a different source or from an unopened ream of paper.
Some areas of the paper reject toner.	Use paper from a different source or from an unopened ream of paper.
Your paper is excessively rough.	Use a smoother, xerographic paper.
The letterhead you are using is printed on rough paper.	Try a smooth xerographic paper. If this solves your problem, consult with the printer of your letterhead to verify that the paper used meets the specifications for this printer.
Media does not meet the specifications for this printer.	Only use media that meets the media specifications for this printer (see chapter 3).
The printer is operating in excessively humid or dry conditions.	Verify that the printing environment is within humidity specifications.
Print is faded.	If a TONER LOW or TONER OUT message is displayed on the printer control panel, replace the appropriate toner cartridge. If the problem persists, call for service.
The transfer belt may be contaminated.	Use a lint-free cloth to clean any contaminants from the transfer belt surface.

Irregular, raised spots or stray toner

Problem	Solution
Toner is smudged on the back of pages.	Toner collected on the transfer belt can cause smudging on the back of a page. Smudges commonly appear on the edges of pages after media size is changed. The belt is self-cleaning and the smudging will normally clear within a few pages. Print 5 to 10 pages to clear the smudge.
The printer recently had a media jam or the printer fed multiple sheets of media.	Print 5 to 10 pages to clear any smearing.
Toner is smeared on the edge of the media.	Toner on the edge of the media is usually caused by toner collecting on paper guides. Inspect the paper guides and clean with a lint-free cloth if necessary.
You are refeeding paper that has already passed through the printer or through a copier.	Do not re-feed paper. Re-feeding paper contaminates the fuser, causing stray toner defects.
The fuser roller is dirty.	Print 5 to 10 pages to clean the fuser roller.

Banding

Problem	Solution
Dark and light bands appear in large areas of halftone areas.	If the problem persists, the imaging drum may be past its useful life. Print a configuration page to verify the remaining life of the imaging drum. Replace the imaging drum if necessary.
Consumable items may be beyond their useful life.	Print a configuration page to verify the remaining life of the consumable item. Replace any consumable items that are past their rated life.
Certain halftone patterns exaggerate banding.	Try a different halftone pattern.

Wavy characters

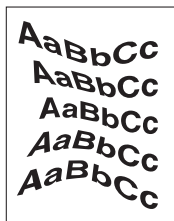

Problem	Solution
Characters appear wavy for several pages.	The printer's laser scanner needs service. Contact your authorized HP dealer or HP service representative.

Dull or dark colors on transparencies

Problem	Solution
You are using transparencies that do not meet the media specifications for this printer.	Use only transparencies that meet the specifications for this printer (see chapter 3).
The selected colors are undesirable when printed.	Select different colors in your software application or printer driver.
Spots and smudges appear in the background areas of transparencies when they are projected.	Oil from your hands can cause spots or smudges on transparencies. Reprint the transparencies, being careful not to touch the surface of the transparencies.
You are using a reflective overhead projector.	Use a standard overhead projector.

Rippled or wavy transparencies

Problem	Solution
You are using transparencies that do not meet the specifications for this printer.	Use only transparencies that meet the media specifications for this printer.

Horizontal streaks on transparencies

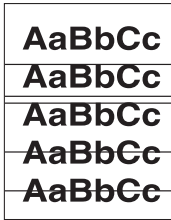

Problem	Solution
The printer's imaging drum is past its useful life.	Print a configuration page to verify the remaining life of the imaging drum. Replace the imaging drum if necessary.
You are using transparencies that do not meet the media specifications for this printer.	Use only transparencies that meet the media specifications for this printer. See the <i>HP LaserJet Printer Family Paper Specification Guide</i> .

Smudges

Problem	Solution
The printer recently jammed.	Print 5 to 10 pages to clean the printer.
You recently changed to a different media size.	Print 5 to 10 pages to clean the printer.

Uneven dark areas or lines in solid fill areas on transparencies

Problem	Solution
You are using transparencies that do not meet the media specifications for this printer.	Use only transparencies that meet the media specifications for this printer. See the Printing on Transparencies section of chapter 3
The imaging drum has exceeded its useful life.	Print out a configuration page to verify the remaining life of the imaging drum. If the printer control panel displays DRUM KIT OUT REPLACE DRUM KIT, replace the imaging drum.

Repetitive defects

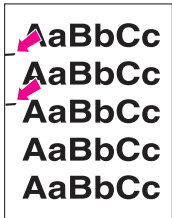

Problem	Solution
Unwanted marks of the same size and shape appear in the same vertical area on most pages.	Print out a configuration page to verify the remaining life of the imaging drum. If the printer control panel displays DRUM KIT OUT REPLACE DRUM KIT, replace the imaging drum.
Unwanted marks of the same size and shape appear more than once in the same vertical area on transparencies or glossy media only.	The fuser roller is damaged or the fuser is beyond its useful life. Print out a configuration page to verify the remaining life of the fuser. If the printer control panel displays FUSER LIFE OUT REPLACE KIT, replace the fuser.
Repetitive defects appear only in one color.	Check the corresponding toner cartridge.

Color Printing Problems

Printing black instead of color

Problem	Solution
Color mode is not selected in your software application or printer driver.	Select color mode instead of grayscale or monochrome mode in your software application or printer driver.
The correct printer driver is not selected in your software application.	Select the correct printer driver.
The printer is not properly configured.	Verify the printer configuration by printing a configuration page.
No color appears on the configuration page.	Consult your service representative.

Missing color or incorrect shade

Problem	Solution
Your media does not meet the specifications for this printer.	See the <i>HP LaserJet Printer Family Paper Specification Guide</i> .
You are operating the printer in excessively humid conditions.	Verify that the printer's environment is within humidity specifications.
The color density and balance are not set properly.	See the adjusting color balance section in chapter 4.
The toner density sensor may need cleaning.	Clean the toner density sensor (see chapter 7 for cleaning instructions).

Inconsistent colors after loading toner

Problem	Solution
Another toner color may be low.	Check the printer control panel for a TONER LOW message and replace the toner cartridge if necessary.
Toner cartridges may be improperly installed.	Verify that each toner cartridge is installed properly.

Printed colors do not match screen colors

Problem	Solution
Extremely light screen colors are not being printed.	Your software application may interpret extremely light colors as white. If so, avoid using extremely light colors.
Extremely dark screen colors are being printed in black.	Your software application may interpret extremely dark colors as black. If so, avoid using extremely dark colors.
The colors on your computer monitor differ from the printer output.	Try selecting Screen Match in the color control tab of your printer driver.
Color density and balance are not set correctly.	For instructions on adjusting color density, see the chapter 4.
The toner density sensor may need cleaning.	See chapter 7 for instructions on cleaning the toner density sensor.

Note

Several factors can influence your ability to match printed colors to those on your monitor. These factors include print media, overhead lighting, software applications, operating system palettes, monitors, and video cards and drivers.

Incorrect Printer Output

Incorrect fonts are printed

Problem	Solution
The font has not been correctly selected in your software application.	Re-select the font in your software application.
The font is not available to the printer.	Download the font to the printer or use another font.
The correct printer driver is not selected.	Select the correct printer driver.

Unable to print all characters in a symbol set

Problem	Solution
The correct font is not selected.	Select the correct font.
The correct symbol set is not selected.	Select the correct symbol set.
The selected character is not supported by your software application.	See the documentation for your software application.
The selected symbol is not supported by the font.	Use a font that supports the selected symbol.

Drifting text between printouts

Problem	Solution
Your software application is not resetting the printer to the top of the page.	See the user guide for your software application or the <i>PCL Technical Reference Manual</i> for specific information.

Erratic, missing characters or interrupted printout

Problem	Solution
The interface cable is of poor quality.	Try using a different, higher-quality, IEEE-compliant cable. Parallel cables can be no longer than 10 meters (30 feet).
The interface cable is loose.	Disconnect and reconnect the interface cable.
The interface cable is damaged or bad.	Try using a different interface cable.
The power cable is loose.	Disconnect and reconnect the power cable.
You are attempting to print a PCL job with the printer configured for PostScript Emulation.	From the printer control panel, select the correct printer personality and then resend the print job.
You are attempting to print a PostScript job with the printer configured for PCL.	From the printer control panel, select the correct printer personality and then resend the print job.

Partial printout

Problem	Solution
A memory error message appears on the printer control panel.	1) Free up printer memory by deleting unneeded downloaded fonts, style sheets, and macros from printer memory; or 2) Add more memory to the printer.
The file you are printing contain errors.	Check your software application to verify that the file does not contain errors. To do so: 1) Print another file that you know is error-free from within the same application; or 2) Print the file from another application.

Software Application Problems

Unable to change system selections through software

Cause	Solution
System software changes are locked out by the printer control panel.	See the chapter on printer interfaces. Consult with your network administrator.
Your software application does not support system changes.	See the documentation for your software application.
The correct printer driver is not loaded.	Load the correct printer driver.
The correct application driver is not loaded.	Load the correct application driver.

Unable to select a font from the software

Cause	Solution
The correct printer driver is not selected.	Select the correct printer driver.
The font is not available in your software application.	See the documentation for your software application.

Unable to select colors from the software

Cause	Solution
Your software application does not support color.	See the documentation for your software application.
Color mode is not selected in your software application or printer driver.	Select color mode instead of grayscale or monochrome mode.
The correct printer driver is not loaded.	Load the correct printer driver.

Printer driver does not recognize Tray 3 or the Duplex Printing Accessory

Cause	Solution
The printer driver has not been configured to recognize Tray 3 or the duplex printing accessory.	See the online Help for the printer driver for instructions on how to configure the driver to recognize printer accessories.
The accessory may not be installed.	Verify that the accessory is properly installed.

A

DIMM Installation

Overview

The printer is designed for easy installation of additional memory. This chapter provides information on installing memory.

DIMM Configuration

This printer supports up to 208 MB of memory. You can add additional Random Access Memory (RAM) to this printer by installing Dual Inline Memory Modules (DIMMs). The printer uses 100-pin, non-parity, synchronous DRAM memory modules. Extended Data Output (EDO) DIMMs are not supported.

Note

Do not exceed 208 MB of total printer memory.

You can install 4, 8, 16, 32 or 64 MB DIMMs into the printer's three DIMM slots. Synchronous DRAM modules do not need to be configured in pairs (in corresponding left and right slots).

CAUTION

Do not attempt to remove the DIMM in slot #4 (see figure A-1). The DIMM in slot #4 is part of the printer's firmware. Removing it will affect printer operation.

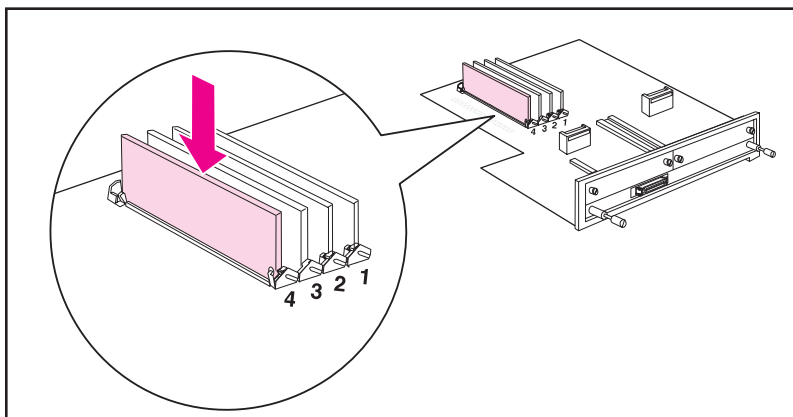
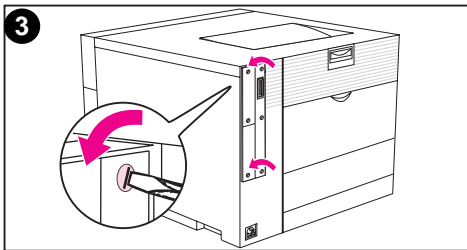
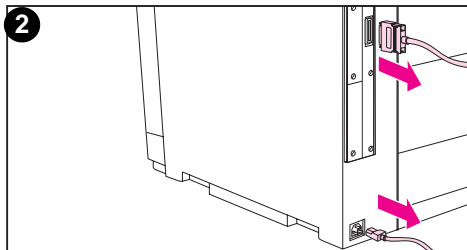
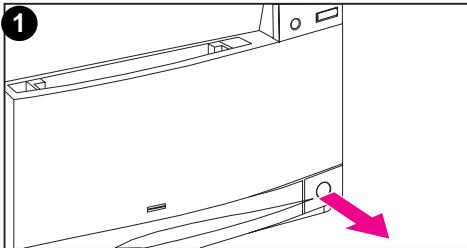
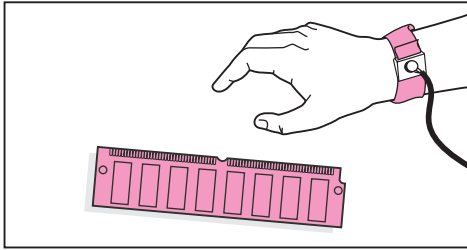

Figure A-1

Do not remove the DIMM in slot #4.

Installing DIMMs



To install a DIMM

CAUTION

To reduce the possibility of damage caused by static electricity, always wear an electrostatic discharge (ESD) wrist strap or touch the surface of the antistatic package before handling DIMMs. When handling the formatter board, wear an antistatic wrist strap or frequently touch bare metal on the printer.

- 1 Turn the printer off and wait for the fans to stop.

CAUTION

Wait for the printer's fans to turn off before unplugging the printer.

- 2 Disconnect all power and interface cables.
- 3 Locate the formatter board in the upper-left corner of the rear of the printer and loosen the two screws.

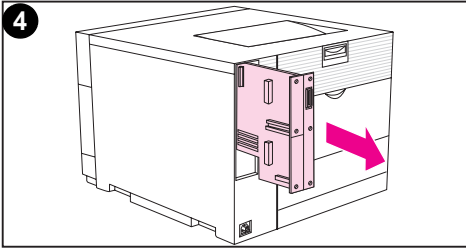

4 Slide out the formatter board and set it on a clean, flat, grounded surface.

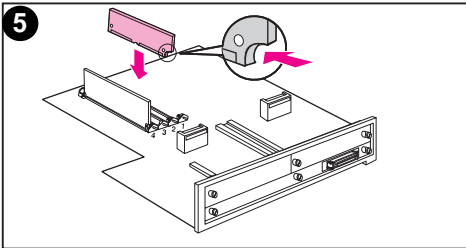

5 Align the connectors on the DIMM with the notches in the DIMM slot. Insert the DIMM into the slot and then firmly push the DIMM until the levers lock into place.

Note

Repeat step 5 for each DIMM you are installing.

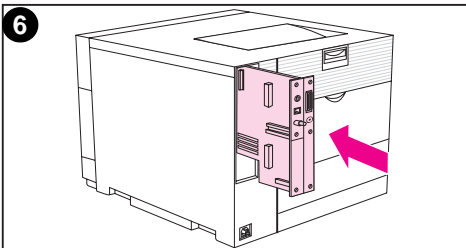

6 Insert the formatter board into the printer.

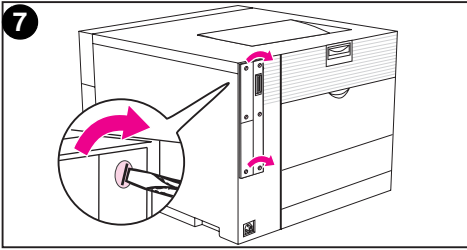

- 7 Tighten the screws.
- 8 Reconnect the power and interface cables.
- 9 Turn the power on. The printer automatically updates the memory configuration to include the newly installed DIMMs.

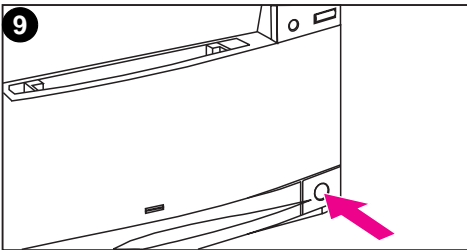
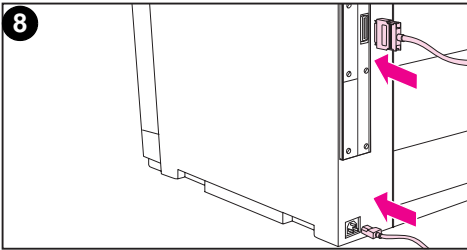

Verifying DIMM Installation

To verify that the DIMM installation was successful, print out a configuration page (see the chapter on using the printer control panel). If the DIMM has been installed properly, the figure in the Memory section of the configuration page will reflect the new total amount of memory.

If the printer control panel displays an error message, see chapter 8 for descriptions of printer control panel messages.

B

PCL Commands

Overview

This printer supports the use of the Printer Control Language (PCL). Most software applications provide the printer with necessary language information. However, some applications do not provide the printer with language information and require the user to enter printer commands. See your software application documentation for instructions on entering printer commands.

This appendix is not intended to provide comprehensive information about PCL commands. Rather, it provides a quick reference for users who are already familiar with the PCL command structure. For more information, see the *PCL Technical Reference Manual*.

PCL Commands

PCL printer commands instruct the printer which tasks to perform or which fonts to use for specific print jobs.

PJL Commands

The HP Printer Job Language (PJM) provides control above PCL and other printer languages. The four major functions provided by PJL are:

- printer language switching
- job separation
- printer configuration
- status feedback from the host

PJL commands can be used to change printer default settings.

Interpreting PCL Printer Command Syntax

Before using printer commands, compare the following characters:

Lowercase L:	ℓ	Uppercase O:	O
Number one:	1	Number zero:	Ø

Note

You must use the exact character and case specified for PCL printer commands.

Many printer commands use the lowercase letter L (ℓ) and the number one (1), or the uppercase letter O (O) and the number zero (Ø). These characters may not appear on your screen as shown here.

Figure B-1 shows the elements of a typical printer command (in this example, a command for page orientation).

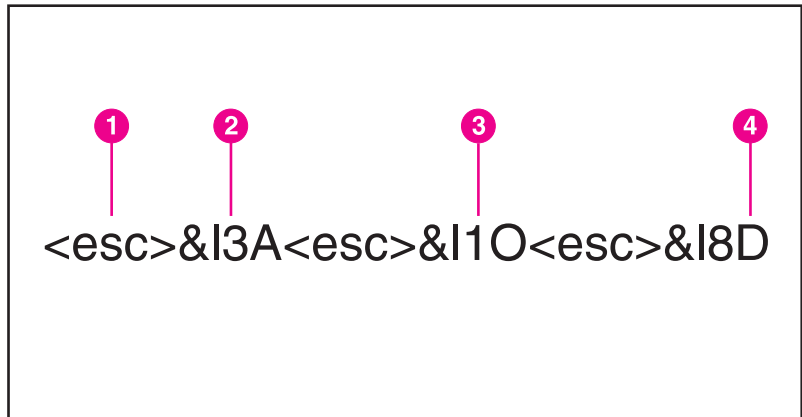

Figure B-1

Printer Command Elements

- 1 Escape Character (begins the escape sequence)
- 2 Value Field (contains both alpha and numeric characters)
- 3 Category of Command
- 4 Uppercase Letter (terminates the escape sequence)

Combining Escape Sequences in PCL Printer Command Syntax

Escape sequences can be combined into one escape-sequence string. There are three important rules to follow when combining code:

- The first two characters after the <esc> character must be the same.
- When combining sequences, change the uppercase (termination) character in each individual escape sequence to lowercase.
- The final character of the escape sequence must be in uppercase.

The following escape sequence would be sent to the printer to select legal paper, landscape orientation, and eight lines per inch:

```
<esc>&l3A<esc>&l1O<esc>&l8D
```

The following escape sequence sends the same printer commands by combining them into a shorter sequence:

```
<esc>&l3a1o8D
```

Entering Escape Characters

Note

PCL printer commands always begin with the escape character (<esc>).

The following table lists the escape character entries for various applications.

Application	Escape Character Entry	What Appears
Lotus 1-2-3 and Symphony	Type \027	027
Microsoft Word for DOS	Hold down ALT and type 027	<—
WordPerfect for DOS	Type <27>	<27>
MS-DOS Editor	Hold down CTRL-P then ESC	<—
MS-DOS Edlin	Hold down CTRL-V then [^[
dBase	?? CHR(27)+“command”	?? CHR(27)+“ ”
UNIX VI Editor	Hold down CTRL-V then Esc	^[

Selecting PCL Fonts

The printer font list provides PCL printer commands for selecting fonts. (See the section on printing a list of available fonts.) A sample section of a font list is shown below.

There is one variable box for entering symbol sets and one for entering point size. Unless these variables are entered, the printer will use defaults. For example, if you want a symbol set that contains line-draw characters, select the 10U (PC-8) or 12U (PC-850) symbol set. Other common symbol set codes are listed in the “Common PCL Printer Commands” section of this chapter.

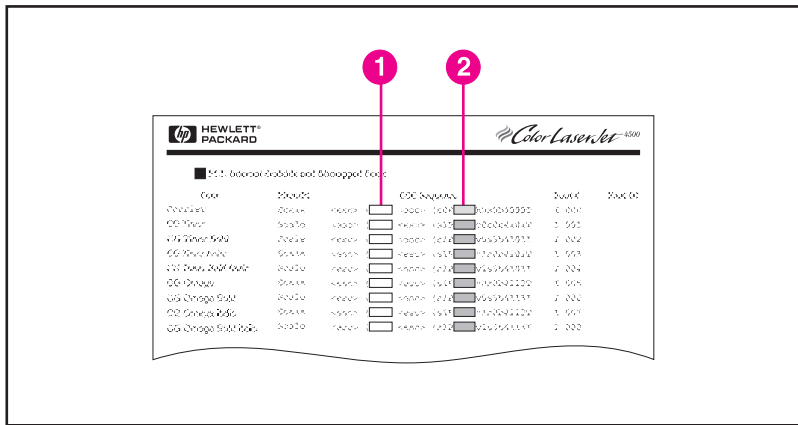

Figure B-2 Font List

- 1 Symbol Set
- 2 Point Size

Note

Fonts are either fixed or proportional in spacing. This printer supports fixed fonts (Courier, Letter Gothic, and Lineprinter) and proportional fonts, including CG Times, Arial®, and Times New Roman.

Fixed-space fonts are best used in applications such as spreadsheets and databases, where it is important for columns to line up vertically. Proportional-spaced fonts are generally used in word processing applications.

Common PCL Commands

The following table lists the most common PCL commands.

PCL Commands

Function	Command	Option(s)
Job Control Commands		
Reset	<esc> E	n/a
Number of Copies	<esc> &l#X	1 to 999
Duplex/Simplex	<esc> &l#S	0 = Simplex (single-sided) printing 1 = Duplex (two-sided) with long-edge binding 2 = Duplex (two-sided) with short-edge binding

PCL Commands (continued)

Page Control Commands		
Paper Destination	<esc> &l#G	0 = Automatic Selector 1 = Top Output Bin (face-down) 2 = Rear Output Bin (face-up)
Paper Source	<esc> &l#H	0 = Prints or ejects current page 1 = Tray 2 4 = Tray 1 5 = Tray 3 (500-sheet paper feeder)
Paper Size	<esc> &l#A	1 = Executive 2 = Letter 3 = Legal 25 = A5 26 = A4 100 = B5 101 = Custom 80 = Monarch 81 = Commercial 10 90 = DL 91 = International CS
Paper Type	<esc> &n#	5WdBond = Bond 6WdPlain = Plain 6WdColor = Color 7WdLabels = Labels 9WdRecycled = Recycled 10WdCardstock = Cardstock 11WdLetterhead = Letterhead 11WdPrepunched = Prepunched 11WdPreprinted = Preprinted 13WdTransparency = Transparency #WdCustompapertype = Custom

PCL Commands (continued)

Orientation	<esc> &l#O	0 = Portrait 1 = Landscape 2 = Reverse Portrait 3 = Reverse Landscape
Top Margin	<esc> &l#E	# = Number of lines
Text Length (bottom margin)	<esc> &l#F	# = Number of lines from top margin
Left Margin	<esc> &a#L	# = Column number
Right Margin	<esc> &a#M	# = Column number from left margin
Horizontal Motion Index	<esc> &k#H	1/120 inch increments (compresses print horizontally)
Vertical Motion Index	<esc> &l#C	1/48 inch increments (compresses print vertically)
Line Spacing	<esc> &l#D	# = lines per inch (1, 2, 3, 4, 5, 6, 12, 16, 24, 48)
Perforation Skip	<esc> &l#L	D = Disable 1 = Enable
Cursor Positioning		
Vertical Position (Rows)	<esc> &a#R	# = Row number
Vertical Position (Dots)	<esc> *p#Y	# = Dot number (300 dots = 1 inch)
Vertical Position (Decipoints)	<esc> &a#V	# = Decipoint number (720 decipoints = 1 inch)
Horizontal Position (Columns)	<esc> &a#C	# = Column number
Horizontal Position (Dots)	<esc> *p#X	# = Dot number (300 dots = 1 inch)
Horizontal Position (Decipoints)	<esc> &a#H	# = Decipoint number (720 decipoints = 1 inch)

PCL Commands (continued)

Programming Hints		
End of Line Wrap	<esc> &s#C	0 = Enable 1 = Disable
Display Functions On	<esc> Y	n/a
Display Functions Off	<esc> Z	n/a
Vector Graphics Switching		
Enter PCL Mode	<esc> %#A	0 = Use previous PCL cursor position 1 = Use current HP-GL/2 pen position
Enter HP-GL/2 Mode	<esc> %#B	0 = Use previous HP-GL/2 pen position 1 = Use current PCL cursor position
Font Selection		
Symbol Sets	<esc> (#U etc.	8U = HP Roman-8 Symbol Set 10U = IBM Layout (PC-8) (code page 437) Default Symbol Set 12U = IBM Layout for Europe (PC-850) (code page 850) 8M = Math-8 19U = Windows 3.1 Latin 1 9E = Windows 3.1 Latin 2 (commonly used in Eastern Europe) 5T = Windows 3.1 Latin 5 (commonly used in Turkey) 579L = Wingdings Font
Primary Spacing	<esc> (s#P	0 = Fixed 1 = Proportional

PCL Commands (continued)

Primary Pitch	<esc> (s#H	# = Characters/Inch
Set Pitch Mode	<esc> &k#S	0 = 10 4 = 12 (elite) 2 = 16.5 - 16.7 (compressed)
Primary Height	<esc> (s#V	# = Points
Primary Style ¹	<esc> (s#S	0 = Upright (solid) 1 = Italic 4 = Condensed 5 = Condensed Italic
Primary Stroke Weight ¹	<esc> (s#B	0 = Medium (book or text) 1 = Semi-bold 3 = Bold 4 = Extra Bold
Color Text	<esc> *r3U <esc> *v#S (*r3U - selects RGB palette, *v#S - selects foreground color)	0 = Black 1 = Red 2 = Green 3 = Yellow 4 = Blue 5 = Magenta 6 = Cyan
Typeface ¹	<esc> (s#T	Print the font list to find the command for each internal font.
¹ Order the <i>PCL/PJL Technical Reference Package</i> if you require symbol sets or want additional information.		

C

Specifications

Electrical Specifications

	110-Volt Models	220-Volt Models
Power Requirements	100/127V (+/- 10%) 50-60 Hz (+/- 2 Hz)	220/240V (+/- 10%) 50-60 Hz (+/- 2 Hz)
Power Consumption (typical) During printing During standby PowerSave mode	470 W (average) 80 W (average) <45 W	480 W (average) 90 W (average) <45 W
Minimum recommended circuit capacity for typical product	16.0 Amps at 120V	7.1 Amps at 220V

Operating Environment Specifications

Temperature Recommended Allowed	20 to 26° C/68 to 79° F 15 to 30° C/59 to 86° F
Humidity Recommended Allowed	20 to 50% RH 10 to 80% RH
Altitude Allowed	0 to 3100 m (0 to 10,000 ft)

Acoustic Emissions

Operation Position Printing Standby	Per ISO 9296, DIN 45635,T.19 L_{PA} 58 dB(A) L_{PA} 49 dB(A)
Bystander 1m Printing Standby	Per ISO 7779, DIN 45635,T.19 L_{PA} 52 dB(A) L_{PA} 45 dB(A)
Sound Power Printing Standby	Per ISO 9296 L_{WAD} =6.6 bels(A) L_{WAD} =5.8 bels(A)

Environmental Product Stewardship Program

Protecting the Environment

Hewlett-Packard Company is committed to providing quality products in an environmentally sound manner. This HP LaserJet printer has been designed with several attributes to minimize impacts on our environment.

This HP LaserJet printer design eliminates:

- **Ozone Emissions**—This product has been designed to minimize ozone emissions and avoid the need for an ozone filter.
- **CFC Usage**—Class I U.S. Clean Air Act stratospheric ozone-depleting chemicals (chlorofluorocarbons [CFCs], for example) have been eliminated from the manufacturing sites that produce this printer. This practice coincides with the 1987 “Montreal Protocol on Substances that Deplete the Ozone Layer” and its subsequent amendments. CFCs are not used in manufacturing of the packaging.

This HP LaserJet printer design reduces:

- **Energy Consumption**—Energy usage drops from 120 watts (W) during printing to as low as 30W (45W for a printer with optional accessories) while in low-power (PowerSave) mode. Not only does this save natural resources, but it also saves money without affecting the high performance of this printer. This product qualifies for the ENERGY STAR Program (U.S. and Japan). ENERGY STAR is a voluntary program established to encourage the development of energy-efficient office products. ENERGY STAR is a U.S. registered service mark of the U.S. EPA.



As an ENERGY STAR partner, Hewlett-Packard Company has determined that this product meets ENERGY STAR Guidelines for energy efficiency.

- **Paper Use**—The printer's optional duplex printing accessory provides two-sided printing, reducing paper usage and the resulting demands on natural resources.

The design of this HP LaserJet printer facilitates the recycling of:

- **Plastics**—Major plastic parts have markings that enhance the ability to identify plastics for recycling purposes at the end of the printer's life. The plastics used in the printer housing and chassis are technically recyclable.
- **HP Toner Cartridges/Photoconductive Drum**—In many countries/regions, this product's toner cartridge/drum can be returned to HP at the end of its useful life. A prepaid shipping label and instructions on how to return the toner cartridge/drum are included with the replacement toner cartridge/drum. If your country/region is not listed in the replacement's brochure, call your local HP Sales and Service Office for further instructions.

HP Cartridge Recycling Program Information:

Since 1990, the HP LaserJet Toner Cartridge Recycling Program has collected more than twelve million cartridges that otherwise would have been discarded into landfills or similar facilities. This rapidly growing program returns used cartridges to the manufacturing process, thus conserving a variety of resources. Once a cartridge is returned through the prepaid return program, it is disassembled. The reusable components and the plastic housing are cleaned and inspected for quality conformance. After passing strict inspection procedures, materials such as nuts, screws, and clips are reclaimed and used to produce new cartridges. Remaining materials, like the photoconductive drum, are melted down and used as raw materials for a variety of other products. By the weight of the materials returned, over 95 percent (%) are recycled. All HP LaserJet Toner Cartridges are shipped in recycled boxes with the entire box being recyclable through the returns program. Styrofoam end caps, which were used to support HP LaserJet Toner Cartridges during shipping, have been replaced with molded end caps made from 100% post-consumer paper products. For more information in the U.S., call (1) (800) 340-2445 or visit the HP LaserJet website at <http://www.ljsupplies.com/planetpartners>. International customers can call the local HP Sales and Service Office for further information regarding the HP Toner Cartridge Recycling Program.

- **Printer and Parts**—Design for recycling has been incorporated into this printer and its accessories. The number of materials has been kept to a minimum while ensuring proper functionality and high product reliability. Dissimilar materials have been designed to separate easily. Fasteners and other connections are easy to locate, access, and remove with common tools. High priority parts have been designed to be accessed quickly for efficient disassembly and repair. Plastic parts have been primarily designed in two colors to enhance recycling options. A few small parts are colored specifically to highlight customer access points. HP provides a product return system for customers in Germany. Many of the functional parts are recovered, tested, and reused as fully-warranted service parts. Used parts are not placed into new product manufacturing. The remainder of the product parts are recycled, if possible. For product return information, call (49) (070) 3114-1936 or Fax (49) (070) 3114-4195.

- **Paper**—This printer is suited for the use of recycled papers when the paper meets the guidelines outlined in the *HP LaserJet Printer Family Paper Specification Guide*. This printer is suited for the use of recycled paper according to DIN 19 309.

The user guide is provided on compact disc, which allows the same high-quality information to be provided without consuming the large quantities of energy and natural resources required to produce traditional paper manuals.

To ensure longevity of your HP LaserJet printer, HP provides the following:

- **Extended Warranty**—HP SupportPack provides coverage for the HP hardware product and all HP-supplied internal components. The hardware maintenance covers a three-year period from date of the HP product purchase. HP SupportPack must be purchased by the customer within 90 days of the HP product purchase. Information on HP SupportPack is available in a fax format by calling the U.S. HP FIRST (Fax Information Retrieval Support Technology) at (1) (800) 333-1917. The document number is 9036. International customers can contact the nearest HP-authorized reseller about this service.
- **Spare Parts and Consumables Availability**—Spare parts and consumable supplies for this product will be made available for at least five years after production has stopped.

Regulatory Statements

FCC Regulations

This equipment has been tested and found to comply with the limits for a Class B digital device, pursuant to Part 15 of the FCC rules. These limits are designed to provide reasonable protection against harmful interference in a residential installation. This equipment generates, uses, and can radiate radio frequency energy. If it is not installed and used in accordance with the instructions, it may cause harmful interference to radio communications. However, there is no guarantee that interference will not occur in a particular installation. If this equipment does cause harmful interference to radio or television reception, which can be determined by turning the equipment off and on, the user is encouraged to try to correct the interference by one or more of the following measures:

- Reorient or relocate the receiving antenna.
- Increase separation between equipment and receiver.
- Connect equipment to an outlet on a circuit different from that to which the receiver is located.
- Consult your dealer or an experienced radio/TV technician.

Note

Any changes or modifications to the printer that are not expressly approved by HP could void the user's authority to operate this equipment.

Use of a shielded interface cable is required to comply with the Class B limits of Part 15 of FCC rules.

Canadian DOC Regulations

Complies with Canadian EMC Class B requirements.

« Conforme à la classe B des normes canadiennes de compatibilité électromagnétiques « CEM ». »

VCCI Statement (Japan)

この装置は、情報処理装置等電波障害自主規制協議会（VCCI）の基準に基づく第二種情報技術装置です。この装置は、家庭環境で使用することを目的としていますが、この装置がラジオやテレビジョン受信機に近接して使用されると、受信障害を引き起こすことがあります。
取り扱い説明書に従って正しい取り扱いをして下さい。

Korean EMI Statement

사용자 안내문 (B급 기기)

이 기기는 비업무용으로 전자파장해검정을 받은 기기로서, 주거지역에서는 물론 모든 지역에서 사용할 수 있습니다.

Declaration of Conformity

according to ISO/IEC Guide 22 and EN 45014

Manufacturer's Name: Hewlett-Packard Company
Manufacturer's Address: 11311 Chinden Boulevard
Boise, Idaho 83714-1021 USA

declares that the product

Product Name: HP Color LaserJet 4500, 4500 N, 4500 DN
Model Number: C4084A, C4089A, C4094A
Product Options: ALL

conforms to the following Product Specifications:

Safety: IEC 950:1991+A1+A2+A3+A4 / EN 60950:1992+A1+A2+A3+A4
IEC 825-1:1993+A11 / EN 60825-1:1994+A11 Class 1 (Laser/LED)

EMC: CISPR 22:1993+A1 / EN 55022:1994 Class B1
EN 50082-1:1992

IEC 801-2:1991 / prEN 55024-2:1992 - 4 kV CD, 8 kV AD
IEC 801-3:1984 / prEN 55024-3:1991 - 3 V/m
IEC 801-4:1988 / prEN 55024-4:1992 - 0.5kV Signal Lines,
1.0kV Power Lines

IEC 1000-3-2:1995 / EN61000-3-2:1995
IEC 1000-3-3:1994 / EN61000-3-3:1995

FCC Title 47 CFR, Part 15 Class B2 / ICES-003, Issue 2 / VCCI-21
AS / NZS 3548:1992 / CISPR 22:1993 Class B1)

Supplementary Information:

The product herewith complies with the requirements of the following Directives and carries the CE-marking accordingly:

- the EMC Directive 89/336/EEC
- the Low Voltage Directive 73/23/EEC

¹ The product was tested in a typical configuration with Hewlett-Packard Personal Computer Systems.

² This Device complies with Part 15 of the FCC Rules. Operation is subject to the following two conditions: (1) this device may not cause harmful interference, and (2) this device must accept any interference received, including interference that may cause undesired operation.

*This printer contains Local Area Network (LAN) options. When the interface cable is attached to either of the IEEE 802.3 connectors, the printer meets the requirements of EN 55022A Class A.

February 9, 1998

For Compliance Information ONLY, contact:

Australia Contact: Product Regulations Manager, Hewlett-Packard Australia Ltd., 31.41 Joseph Street, Blackburn, Victoria 3130, Australia.

European Contact: Your local Hewlett-Packard Sales and Service Office or Hewlett-Packard GmbH, Department HQ-TRE / Standards Europe, Herrenberger Strasse 130, D-71034 Böblingen, Germany (FAX: 49-7031-14-3143).

USA Contact: Product Regulations Manager, Hewlett-Packard Company, P.O. Box 15, Mail Stop 160, Boise, ID 83707-0015 (Phone: 208-396-6000).

Safety Information

Laser Safety

The Center for Devices and Radiological Health (CDRH) of the U.S. Food and Drug Administration has implemented regulations for laser products manufactured since August 1, 1976. Compliance is mandatory for products marketed in the United States. This printer is certified as a "Class 1" laser product under the U.S. Department of Health and Human Services (DHHS) Radiation Performance Standard according to the Radiation Control for Health and Safety Act of 1968. Since radiation emitted inside this printer is completely confined within protective housings and external covers, the laser beam cannot escape during any phase of normal user operation.

WARNING!

Using controls, making adjustments, or performing procedures other than those specified in this guide may result in exposure to hazardous radiation.

Material Safety Data Sheet (MSDS)

The Toner Material Safety Data Sheet (MSDS) can be obtained in the U.S. by calling HP FIRST at (800) 231-9300, or by visiting the website at <http://www.ljsupplies.com/planetpartners/datasheets.html>. International customers should see support information in this guide for appropriate phone numbers and information.

Laser Statement for Finland

LASERTURVALLISUUS

Luokan 1 laserlaite

Klass 1 Laser Apparat

HP LaserJet 4500 -laserkirjoitin on käyttäjän kannalta turvallinen luokan 1 laserlaite. Normaalisissa käytössä kirjoittimen suojakotelointi estää lasersäteen pääsyn laitteen ulkopuolelle.

Laitteen turvallisuusluokka on määritetty standardin EN 60825-1 (1994) mukaisesti.

VAROITUS !

Laitteen käyttäminen muulla kuin käyttöohjeessa mainitulla tavalla saattaa altistaa käyttäjän turvallisuusluokan 1 ylittävälle näkymättömälle lasersäteilylle.

VARNING !

Om apparaten används på annat sätt än i bruksanvisning specificerats, kan användaren utsättas för osynlig laserstrålning, som överskrider gränsen för laserklass 1.

HUOLTO

HP LaserJet 4500 -kirjoittimen sisällä ei ole käyttäjän huollettavissa olevia kohteita. Laitteen saa avata ja huoltaa ainoastaan sen huoltamiseen koulutettu henkilö. Tällaiseksi huoltotoimenpiteeksi ei katsota väriainekasetin vaihtamista, paperiradan puhdistusta tai muita käyttäjän käsikirjassa lueteltuja, käyttäjän tehtäväksi tarkoitettuja ylläpitotoimia, jotka voidaan suorittaa ilman erikoistyökaluja.

VARO !

Mikäli kirjoittimen suojakotelo avataan, olet alttiina näkymättömälle lasersäteilylle laitteen ollessa toiminnassa. Älä katso säteeseen.

VARNING !

Om laserprinterns skyddshölje öppnas då apparaten är i funktion, utsätts användaren för osynlig laserstrålning. Betrakta ej strålen.

Tiedot laitteessa käytettävän laserdiodin säteilyominaisuuksista:

Aallonpituus 770-795 nm

Teho 5 mW

Luokan 3B laser

D

Warranty and Support Information

Hewlett-Packard Warranty Statement

HP Color LaserJet 4500,
4500 N, 4500 DN Printer

One-year limited warranty

- 1** HP warrants HP hardware, accessories and supplies against defects in materials and workmanship for the period specified above. If HP receives notice of such defects during the warranty period, HP will, at its option, either repair or replace products which prove to be defective. Replacement products may be either new or like-new.
- 2** HP warrants that HP software will not fail to execute its programming instructions, for the period specified above, due to defects in material and workmanship when properly installed and used. If HP receives notice of such defects during the warranty period, HP will replace software media which does not execute its programming instructions due to such defects.
- 3** HP does not warrant that the operation of HP products will be uninterrupted or error free. If HP is unable, within a reasonable time, to repair or replace any product to a condition as warranted, customer will be entitled to a refund of the purchase price upon prompt return of the product.
- 4** HP products may contain remanufactured parts equivalent to new in performance or may have been subject to incidental use.
- 5** The warranty period begins on the date of delivery or on the date of installation if installed by HP. If customer schedules or delays HP installation more than 30 days after delivery, warranty begins on the 31st day from delivery.
- 6** Warranty does not apply to defects resulting from (a) improper or inadequate maintenance or calibration, (b) software, interfacing, parts or supplies not supplied by HP, (c) unauthorized modification or misuse, (d) operation outside of the published environmental specifications for the product, or (e) improper site preparation or maintenance.

- 7** TO THE EXTENT ALLOWED BY LOCAL LAW, THE ABOVE WARRANTIES ARE EXCLUSIVE AND NO OTHER WARRANTY OR CONDITION, WHETHER WRITTEN OR ORAL, IS EXPRESSED OR IMPLIED AND HP SPECIFICALLY DISCLAIMS THE IMPLIED WARRANTIES OR CONDITIONS OF MERCHANTABILITY, SATISFACTORY QUALITY, AND FITNESS FOR A PARTICULAR PURPOSE.
- 8** HP will be liable for damage to tangible property per incident up to the greater of \$300,000 or the actual amount paid for the product that is the subject of the claim, and for damages for bodily injury or death, to the extent that all such damages are determined by a court of competent jurisdiction to have been directly caused by a defective HP product.
- 9** TO THE EXTENT ALLOWED BY LOCAL LAW, THE REMEDIES IN THIS WARRANTY STATEMENT ARE CUSTOMER'S SOLE AND EXCLUSIVE REMEDIES. EXCEPT AS INDICATED ABOVE, IN NO EVENT WILL HP OR ITS SUPPLIERS BE LIABLE FOR LOSS OF DATA OR FOR DIRECT, SPECIAL, INCIDENTAL, CONSEQUENTIAL (INCLUDING LOST PROFIT OR DATA), OR OTHER DAMAGE, WHETHER BASED IN CONTRACT, TORT, OR OTHERWISE.
- 10** FOR CONSUMER TRANSACTIONS IN AUSTRALIA AND NEW ZEALAND: THE WARRANTY TERMS CONTAINED IN THIS STATEMENT, EXCEPT TO THE EXTENT LAWFULLY PERMITTED, DO NOT EXCLUDE, RESTRICT OR MODIFY AND ARE IN ADDITION TO THE MANDATORY STATUTORY RIGHTS APPLICABLE TO THE SALE OF THIS PRODUCT TO YOU.

HP Maintenance Agreements

HP has several types of maintenance agreements that meet a wide range of support needs.

On-Site Service Agreements

To provide you with the support level best suited to your system usage and support budget, HP has on-site service agreements with three response times:

Priority On-Site Service is designed for production-critical applications, giving you four-hour service response to your site for calls made during normal HP business hours.

Next Day On-Site Service provides on-site support by the next working day following your service request. Extended coverage hours and extended travel beyond HP designated service zones are available for additional charges on most on-site service agreements.

Weekly (Volume) On-Site Service Agreement, for organizations with many HP LaserJet printers, provides economical, scheduled on-site coverage. Designated for customer sites using 25 or more workstation products, this service provides scheduled weekly repair visits to your central location. HP can write an agreement for any combination of 25 or more workstation products including printers, plotters, computers, and disk drives.

Support Information

HP support

Online Services: for 24-hour access to information over your modem, we suggest these services:	World Wide Web URL —Printer drivers, updated HP printer software, plus product and support information may be obtained from the following URLs: in the U.S. http://www.hp.com in Europe http://www2.hp.com Printer drivers may be obtained from the following sites: in Japan ftp://www.jpn.hp.com/drivers/ in Korea http://www.hp.co.kr in Taiwan http://www.hp.com.tw or the local driver website http://www.dds.com.tw	
	America Online America Online/Bertelsmann is available in the U.S., France, Germany, and U.K.—Printer drivers, updated HP printer software, and support documentation to help answer your questions about HP products are available. Use Keyword HP to start your tour or call 1-800-827-6364 preferred customer # 1118 to subscribe. In Europe, call the appropriate number below: Austria 0222 58 58 485 France ++353 1 704 90 00 Germany 0180 531 31 64 Switzerland 0848 80 10 11 United Kingdom 0800 279 1234	
	CompuServe —Printer drivers, updated HP printer software, and interactive sharing of technical information with other members is available on CompuServe's "HP User's forums" (GO HP), or call 1-800-524-3388 and ask for representative #51 to subscribe. (CompuServe is also available in the U.K., France, Belgium, Switzerland, Germany, and Austria.)	
Obtaining software utilities and electronic information for U.S. and Canada:	Phone: (1) (970) 339-7009	Mail: Hewlett-Packard Co. P.O. Box 1754 Greeley, CO 80632 U.S.A.
	Fax: (1) (970) 330-7655	
For Asia-Pacific countries/regions:	Contact Mentor Media at (65) 740-4477 (Hong Kong, Indonesia, Philippines, Malaysia, or Singapore). For Korea, call (82) (2) 3270-0805 or (82) (2) 3270-0893.	
For Australia, New Zealand, and India:	For Australia and New Zealand, call (61) (2) 565-6099. For India, call (91) (11) 682-6035.	
For European English:	For U.K., call (44) (142) 986-5511. For Ireland and outside U.K., call (44) (142) 986-5511.	

HP support (continued)

HP direct ordering for accessories or supplies:	Call 1-800-538-8787 (U.S.) or 1-800-387-3154 (Canada).		
HP Support Assistant compact disc:	This support tool offers a comprehensive online information system designed to provide technical and product information on HP products. To subscribe to this quarterly service in the U.S. or Canada, call 1-800-457-1762. In Hong Kong, Indonesia, Malaysia, or Singapore, call Mentor Media at (65) 740-4477.		
HP Service Information:	To locate HP-authorized Dealers, call 1-800-243-9816 (U.S.) or 1-800-387-3867 (Canada)		
HP Service Agreements:	Call 1-800-835-4747 (U.S.) or 1-800-268-1221 (Canada). Extended Service 1-800-446-0522		
HP FIRST: HP FIRST Fax will deliver detailed troubleshooting information on common software and troubleshooting tips for your HP product. Call from any touch tone phone and request up to three documents per call. These documents will be sent to the fax of your choice.			
Australia	+61 (0) 3 9272 2627	Korea	+82 (0) 02 769 0543
Austria	0660-8218	Malaysia	+60 (0) 3 298 2478
Belgium (Dutch)	0800 1 1906	Netherlands	0800-0222420
Belgium (French)	0800 1 7043	New Zealand	+64 (0) 09 356 6642
Canada	1-800-333-1917	Norway	800-11319
China	+86 (0) 10 6505 5280	Portugal	05 05 313342
Denmark	800-10453	Philippines	+65 275 7251
English (outside of U.K.)	+31 20 681 5792	Singapore	+65 275 7251
Finland	800-13134	Spain	900-993123
France	0800-905900	Sweden	020-79-5743
Germany	0130-810061	Switzerland (German)	0800-551527
Hong Kong	852-2506-2422	Switzerland (French)	0800-551526
Hungary	(36) (1) 252-4647	Taiwan	(886) (2) 719-5589
India	+91 (0) 11 682 6031	Thailand	+66 (0) 2 661 3511
Indonesia	+62 (0) 21 352 2044	United Kingdom	0800-960271
Italy	1678-59020	United States	1-800-333-1917
Japan	+81 (0) 3 3335 8622		

Customer Support Options Worldwide

In addition to the phone numbers listed below, this guide contains worldwide sales and service addresses and phone numbers for countries/regions not listed here.

Customer Support Worldwide

<p>Customer Support and Product Repair Assistance for the U.S. and Canada:</p>	<p>Call 1-208-323-2551 Monday through Friday from 6 am to 10 pm, Saturday 9 am to 4 pm (Mountain Time) free of charge during the warranty period. However, your standard long-distance phone charges still apply. Have your system nearby and your serial number ready when calling.</p> <p>If you know your printer needs repair, call 1-800-243-9816 to locate your nearest HP-authorized service provider, or call 1-208-223-2551 for HP centralized service dispatch.</p> <p>Post-warranty telephone assistance is available to answer your product questions. Call 1-900-555-1500 (\$2.50* per minute, U.S. only) or call 1-800-999-1148 (\$25* per call, Visa or MasterCard, U.S. and Canada) Monday through Friday from 7 am to 6 pm and Saturday from 9 am to 3 pm (Mountain Time). <i>Charges begin only when you connect with a support technician. *Prices subject to change.</i></p>
---	--

European Customer Support Center Language and In-Country Options Available

Open Monday through Friday 8:30 to 18:00 CET

HP provides a free telephone support service during the warranty period. By calling a telephone number listed below, you will be connected to a responsive team waiting to help you. If you require support after your warranty has expired, you can receive support for a fee through the same telephone number. The fee is charged on a per-incident basis. When calling HP, have the following information ready: product name and serial number, date of purchase, and description of the problem.

English	Ireland: (353) (1) 662-5525 U.K.: (44) (171) 512-5202 International: (44) (171) 512-5202	German	Germany (49) (180) 525-8143 Austria: (43) (1) 0660-6386
Dutch	Belgium: (32) (2) 626-8806 Netherlands: (31) (20) 606-8751	Norwegian	Norway: (47) 2211-6299
French	France: (33) (01) 43-62-3434 Belgium: (32) (2) 626-8807 Switzerland: (41) (84) 880-1111	Danish	Denmark: (45) 3929-4099
		Finnish	Finland: (358) (9) 0203-47288
		Swedish	Sweden: (46) (8) 619-2170
		Italian	Italy: (39) (2) 264-10350
		Spanish	Spain: (34) (90) 232-1123
		Portuguese	Portugal: (351) (1) 441-7199

Customer Support Worldwide (continued)

In-country/region support numbers: If you require support after your warranty has expired, additional product repair services, or if your country/region is not listed below, see "Worldwide Sales and Service Offices."			
Argentina	787-8080	Japan	(81) (3) 3335-8333
Australia	(61) (3) 272-8000	Malaysia	(60) (3) 295-2566
Brazil	022-829-6612	Mexico (Mexico City)	01 800-22147
Canada	(1) (208) 323-2551	Mexico (outside Mexico City)	01 800-90529
China	(86) (10) 65053888-5959	New Zealand	(64) (9) 356-6640
Chile	800-360999	Philippines	(63) (2) 894-1451
Czech Republic	(420) (2) 471-7321	Poland	(48) (22) 37-5065
Greece	(30) (1) 689-6411	Portugal	(351) (1) 301-7330
Hong Kong	(852) 800-96-7729	Russia	(7) (95) 923-5001
Hungary	(36) (1) 343-0310	Singapore	(65) 272-5300
India	(91) (11) 682-6035	Taiwan	(886) (02) 717-0055
	(91) (11) 682-6069	Thailand	+66 (0) 2 661-4011
Indonesia	(62) (21) 350-3408	Turkey	(90) (1) 224-5925
Korea	(82) (2) 3270-0700		
Korea (outside Seoul)	(82) (080) 999-0700		

Worldwide Sales and Service Offices

Note

Before calling an HP Sales and Service office, be sure to contact the appropriate Customer Support Center number listed in the “HP support” section. Products should not be returned to these offices. Product return information is also available through the appropriate Customer Support Center in “HP support” on page 204.

Argentina

Hewlett-Packard Argentina S.A.
Montañeses 2140/50/60
1428 Buenos Aires
Phone: (54) (1) 787-7100
Fax: (54) (1) 787-7213

Australia

Hewlett-Packard Australia Ltd.
31-41 Joseph Street
Blackburn, VIC 3130
Phone: (61) (3) 272-2895
Fax: (61) (3) 898-7831
Hardware Repair Center:
Phone: (61) (3) 272-8000
Extended Warranty Support:
Phone: (61) (3) 272-2577
Customer Information Center:
Phone: (61) (3) 272-8000

Austria

Hewlett-Packard GmbH
Lieblgasse 1
A-1222 Vienna
Phone: (43) (1) 25000-555
Fax: (43) (1) 25000-500

Belgium

Hewlett-Packard Belgium S.A. NV
Boulevard de la Woluwe-Woluwedal
100-102
B-1200 Brussels
Phone: (32) (2) 778-31-11
Fax: (32) (2) 763-06-13

Brazil

Edisa Hewlett-Packard SA
Alameda Rio Negro 750
06454-050 Alphaville - Barueri-SP
Phone: (55) (11)- 7296-8000

Canada

Hewlett-Packard (Canada) Ltd.
17500 Trans Canada Highway
South Service Road
Kirkland, Québec H9J 2X8
Phone: (1) (514) 697-4232
Fax: (1) (514) 697-6941

Hewlett-Packard (Canada) Ltd.
5150 Spectrum Way
Mississauga, Ontario L4W 5G1
Phone: (1) (905) 206-4725
Fax: (1) (905) 206-4739

Chile

Hewlett-Packard de Chile
Avenida Andres Bello 2777 of. 1
Los Condes
Santiago, Chile

China

China Hewlett-Packard Co. Ltd.
Level 5, West Wing Office
China World Trade Center
No. 1, Jian Guo Men Wai Avenue
Beijing 100004
Phone: (86) (10) 6505-3888,x. 5450
Fax: (86) (10) 6505-1033
Hardware Repair Center and Extended
Warranty Support:
Phone: (86) (10) 6262-5666x. 6101/2
(86) (10) 6261-4167

Colombia

Hewlett-Packard Colombia
Calle 100 No. 8A -55
Torre C Oficina 309
Bogota, Colombia

Czech Republic

Hewlett-Packard s. r. o.
Novodvorská 82
CZ-14200 Praha 4
Phone: (420) (2) 613-07111
Fax: (420) (2) 471-7611

Denmark

Hewlett-Packard A/S
Kongevejen 25
DK-3460 Birkerød
Denmark
Phone: (45) 3929 4099
Fax: (45) 4281-5810

Far East Region

Hewlett-Packard Asia Pacific Ltd.
17-21/F Shell Tower, Times Square
1 Matheson Street, Causeway Bay
Hong Kong
Phone: (852) 2599-7777
Fax: (852) 2506-9261
Hardware Repair Center:
Phone: (852) 2599-7000
Extended Warranty Support:
Phone: (852) 2599-7000
Customer Information Center:
Phone: (852) 2599-7066

Finland

Hewlett-Packard Oy
Piispankalliontie 17
FIN-02200 Espoo
Phone: (358) (9) 887-21
Fax: (358) (9) 887-2477

France

Hewlett-Packard France
42 Quai du Point du Jour
F-92659 Boulogne Cedex
Phone: (33) (146) 10-1700
Fax: (33) (146) 10-1705

Germany

Hewlett-Packard GmbH
Herrenberger Strasse 130
71034 Böblingen
Phone: (49) (180) 532-6222
(49) (180) 525-8143
Fax: (49) (180) 531-6122

Greece

Hewlett-Packard Hellas
62, Kifissias Avenue
GR-15125 Maroussi
Phone: (30) (1) 689-6411
Fax: (30) (1) 689-6508

Hungary

Hewlett-Packard Magyarország Kft.
Erzsébet királyné útja 1/c.
H-1146 Budapest
Phone: (36) (1) 343-0550
Fax: (36) (1) 122-3692
Hardware Repair Center:
Phone: (36) (1) 343-0312
Customer Information Center:
Phone: (36) (1) 343-0310

India

Hewlett-Packard India Ltd.
Paharpur Business Centre
21 Nehru Place
New Delhi 110 019
Phone: (91) (11) 647-2311
Fax: (91) (11) 646-1117
Hardware Repair Center and Extended
Warranty Support:
Phone: (91) (11) 642-5073
(91) (11) 682-6042

Italy

Hewlett-Packard Italiana SpA
Via Giuseppe di Vittorio, 9
Cernusco Sul Naviglio
I-20063 (Milano)
Phone: (39) (2) 921-21
Fax: (39) (2) 921-04473

Japan

Hewlett-Packard Japan, Ltd.
3-29-21 Takaido-higashi
Suginami-ku, Tokyo 168
Phone: (81) (3) 3335-8333
Fax: (81) (3) 3335-8338
Hardware Repair Center:
Phone: (81) (4) 7355-6660
Fax: (81) (4) 7352-1848

Korea

Hewlett-Packard Korea
25-12,
Yoido-dong, Youngdeungpo-ku
Seoul 150-010
Phone: (82) (2) 769-0114
Fax: (82) (2) 784-7084
Hardware Repair Center:
Phone: (82) (2) 3270-0700
(82) (2) 707-2174 (DeskJet)
(82) (2) 3270-0710 (Hardware)
Extended Warranty Support:
Phone: (82) (2) 3770-0365 (Bench)
(82) (2) 769-0500 (Onsite)

Latin American Headquarters

5200 Blue Lagoon Drive Suite 950
Miami, FL 33126, USA
Phone: (1) (305) 267-4220

México

Hewlett-Packard de México, S.A. de C.V.
Prolongación Reforma No. 700
Lomas de Santa Fe
01210 México, D.F.
Phone: 01-800-22147
Outside Mexico City
Phone: 01 800-90529

Middle East/Africa

ISB HP Response Center
Hewlett-Packard S.A.
Rue de Veyrot 39
P.O. Box 364
CH-1217 Meyrin - Geneva
Switzerland
Phone: (41) (22) 780-4111

Netherlands

Hewlett-Packard Nederland
BV Startbaan 16
NL-1187 XR Amstelveen
Postbox 667
NL-1180 AR Amstelveen
Phone: (31) (020) 606-87-51
Fax: (31) (020) 547-7755

New Zealand

Hewlett-Packard (NZ) Limited
Ports of Auckland Building
Princes Wharf, Quay Street
P.O. Box 3860
Auckland
Phone: (64) (9) 356-6640
Fax: (64) (9) 356-6620
Hardware Repair Center and Extended
Warranty Support:
Phone: (64) (9) 0800-733547
Customer Information Center:
Phone: (64) (9) 0800-651651

Norway

Hewlett-Packard Norge A/S
Postboks 60 Skøyen
Drammensveien 169
N-0212 Oslo
Phone: (47) 2273-5600
Fax: (47) 2273-5610

Poland

Hewlett-Packard Polska
Al. Jerozolimskic 181
02-222 Warszawa
Phone: (48-22) 608-7700
Fax: (48-22) 608-76-00

Russia

AO Hewlett-Packard
129223, Moskva, Olimpiyskiy prospekt, 16
Phone: (7) (95) 916-9811
Fax: (7) (95) 974-7829

Singapore

Hewlett-Packard Singapore
(Sales) Pte Ltd
450 Alexandra Road
Singapore (119960)
Phone: (65)275-3888
Fax: (65)275-6839
Hardware Repair Center and
Customer Information Center:
Phone: (65) 272-5300
Extended Warranty Support:
Phone: (65) 272-5333

Spain

Hewlett-Packard Española, S.A.
Carretera de la Coruña km 16.500
E-28230 Las Rozas, Madrid
Phone: (34) (1) 626-1600
Fax: (34) (1) 626-1830

Sweden

Hewlett-Packard Sverige AB
Skalholtsgatan 9
S-164 97 Kista
Phone: (46) (8) 444-2000
Fax: (46) (8) 444-2666

Switzerland

Hewlett-Packard (Schweiz) AG
In der Luberzen 29
CH-8902 Urdorf/Zürich
Phone: (41) (084) 880-11-11
Fax: (41) (1) 753-7700
Warranty Support:
0800-55-5353

Taiwan

Hewlett-Packard Taiwan Ltd.
8th Floor
337, Fu-Hsing North Road
Taipei, 10483
Phone: (886)(02)717-0055
FAX : (886)(02)514-0276
Hardware Repair Center, call :
North (886)(02) 717-9673
Central (886)(04) 327-0153
South (886)(080)733-733
Extended Warranty Support Contact :
Phone: (886)(02) 714-8882

Thailand

Hewlett-Packard (Thailand) Ltd.
23-25/f Vibulthani Tower II
2199 Rama 4 Rd, Klongton
Klintoey, Bangkok 10110
Thailand
Phone: (66) (2) 666-3900-34
Fax: (66) (2) 666-3935-37
Hardware Repair Center and Extended
Warranty Support Contact:
Phone: (66) (2) 661-3900 ext. 6001/
6002
Customer Information Center:
Phone: (66) (2) 661-3900 ext. 3211
Fax: (66) (2) 661-3943

Turkey

Hewlett-Packard Company
Bilgisayar Ve ölçüm Sistemleri AS
19 Mayıs Caddesi Nova
Baran Plaza Kat: 12
80220 Sisli-Istanbul
Phone: (90) (212) 224-5925
Fax: (90) (212) 224-5939

United Kingdom

Hewlett-Packard Ltd.
Cain Road
Bracknell
Berkshire RG12 1HN
Phone: (44) (134) 436-9222
Fax: (44) (134) 436-3344

Venezuela

Hewlett-Packard de Venezuela S.A.
Los Ruices Norte
3A Transversal
Edificio Segre Caracas 1071
Phone: (58) (2) 239-4244
Fax: (58) (2) 239-3080

Index

Numerics

- 500-sheet paper feeder
 - See also Tray 3
 - ordering 23

A

- accessories
 - See also consumables
 - description 23
 - duplexer 70
 - ordering 23, 205
 - Tray 3 66
- acoustic emissions 188
- adjusting color balance 79
- advanced functions, setting 45
- attention light, interpreting 29
- attention messages 120
- auto continue 35
- avoiding paper jams 139

B

- banding 158
- bidirectional parallel cable
 - pin configuration 99
 - specifications 98

C

- cable
 - See parallel cable
- Calibration Menu
 - description 38
 - items 38
 - values 38
- Canadian DOC regulations 194
- Cancel Job 28
- cartridge
 - See toner cartridges
- color
 - See color printing
- color matching 78
- color printing
 - adjusting color balance 79
 - control options 77
 - controlling color 79
 - customizing 76
 - Detail option 76
 - grayscale 77
 - halftones 76

- matching colors 78
- PANTONE® colors 78
- problems 163
- Screen Match 77
- colored paper
 - using 52
- commands 175
- components, printer 20
- Configuration Menu
 - description 35
 - items 35
 - values 35
- configuration settings, changing 41
- configuring
 - DIMMs 170
 - input trays 57
 - LocalTalk 102
 - parallel cable pin 99
- consumables
 - availability 192
 - disposing 116
 - drum kit 114
 - error messages 114
 - fuser kit 114
 - ordering 23
 - overview 111
 - replacing 114
 - toner cartridges 114
 - transfer kit 114
- control panel
 - indicator lights 29
 - PowerSave settings 41
 - printer personalities 42
- control panel menus
 - Calibration Menu 38
 - Configuration Menu 35
 - I/O Menu 37
 - Information Menu 30
 - menu map 31
 - Paper Handling Menu 34
 - Resets Menu 39
 - using 30
- control panel, printer
 - configuration 41
 - default settings 41
 - features 27
 - help with 28
 - I/O Timeout, setting 43
 - indicator lights 29

- keys 28
- locking 103
- menu locking 30
- menu map 31
- menus, descriptions 30
- messages, description 121
- messages, troubleshooting 121
- messages, types 120
- options 26
- problems 154
- selecting PCL fonts 88
- settings 22, 154
- shared environments 40
- stopping a print job 74
- using 28
- controlling print jobs 22, 55
- critical error messages, defining 120
- customer support 206
 - HP First Fax 205
 - obtaining software 204
 - worldwide 206
- custom-size media 73

D

- data light, interpreting 29
- Declaration of Conformity 195
- default settings
 - changing 41
 - resetting 46
- density sensor 123
- DIMMs (Dual Inline Memory Modules)
 - adding 19
 - configuring 170
 - installing 172
 - verifying installation 174
- DIN-8 printer cable 102
- display panel
 - See control panel 154
- driver
 - See printer driver
- Dual Inline Memory Modules (DIMMs)
 - See DIMMs
- duplex printing
 - accessory 70
 - settings 71

E

- EIO (Enhanced Input Output)
 - configuring 37
- electrical specifications 187
- energy consumption 189, 190
- ENERGY STAR Program 190
- Enhanced Input Output (EIO)
 - configuring 37, 100

- envelopes
 - avoiding printer jams 62
 - jamming 148
 - precautions 53
 - printing on 53, 61
 - using 53
 - weight 53
 - wrinkled 53
- environmental features 17
- Environmental Product Stewardship Program 189
- error messages
 - action 121
 - blank display panel 150
 - consumables 114
 - description 121
 - interpreting 114
 - paper jams 138

F

- factory default settings, resetting 46
- faded print 157
- FCC regulations 193
- Finnish laser statement 198
- font #, description 91
- fonts
 - adding support 94
 - custom 96
 - default font 86
 - HP FontSmart 84
 - list of 91
 - on a network 93
 - PCL fonts 88
 - pitch 91
 - PostScript emulation, using 92
 - printing font list 90
 - printing guidelines 93
 - problems 165
 - selecting 87
 - selecting default font 86
 - TrueType, internal 85
 - typeface 91
 - using 84

G

- glossy paper
 - ordering 23
 - using 52
- grayscale, printing in 77

H

- heavy paper
 - using 54
- HP custom font services 96

- HP First Fax 205
- HP FontSmart
 - accessing 84
 - using 84
- HP JetAdmin software 101
- HP JetDirect print server 100, 101, 102
- HP Service Agreements 205
- HP Service Information 205
- HP Worldwide Sales and Service Offices 208– 211

I

- I/O cards 100
- I/O Menu 37
 - description 37
 - setting bidirectional communication 45
- I/O Timeout, setting 43
- indicator lights, interpreting 29
- input trays, configuring 34, 57
- interfaces, printer
 - Enhanced I/O configuration 100
 - parallel cable pin configuration 99

J

- Japanese VCCI statement 194
- job cancel 28

K

- Korean EMI statement 194

L

- laser safety 197
- letterhead
 - precautions 54
 - printing on 73
- loading
 - 500-sheet paper feeder 67
 - Tray 1 60
 - Tray 2 64
 - Tray 3 67
- LocalTalk interface 102
- locating control panel features 27
- locking 56

M

- Macintosh
 - DIN-8 printer cable 102
 - LocalTalk interface 102
 - LocalTalk Network Configuration 102
- maintenance
 - space required for 112

- Material Safety Data Sheet (MSDS) 197
- media

- See also* paper
- colored paper 52
- configuring input trays 57
- curled output 149
- custom-size, printing on 73
- envelopes jamming 148
- envelopes, printing on 53
- glossy paper 52
- heavy paper 54
- letterhead 54
- loading Tray 1 60
- loading Tray 2 64
- loading Tray 3 67
- ordering 23
- precautions 54
- preprinted forms 54
- printing guidelines 51
- problems 137
- selecting 48, 56
- sizes, setting 34
- types to avoid 51
- weights 49

- memory 16
 - adding 169
 - managing 19

- Memory Enhancement Technology (MEt) 19

- Menu

- EIO 37
- I/O Menu 37
- Printing 36
- Resets 39

- menu

- Calibration 38
- Configuration 35
- locking 30, 103
- Paper Handling 34

- menu map, printing 31

- messages

- control panel 120
- error 120
- service 120
- warning 120

- MEt (Memory Enhancement Technology) 19

- MSDS (Material Safety Data Sheet) 197

N

- network
 - securing 103
- network interface settings, adjusting 37

O

- online help 28
- operating environment specifications 187
- ordering
 - 500-sheet paper feeder 23
 - accessories 23
 - cables 23
 - consumables 23
 - media 23
 - memory 23
 - network connectivity 23
 - reference materials 23
 - toner 23
- output bins
 - capacity 55
 - selecting 55
- output, incorrect 165

P

- PANTONE® colors 78
- paper
 - See also* media
 - curled output 149
 - custom-size, printing 73
 - glossy 52
 - handling 16
 - heavy 54
 - input trays, configuring 57
 - jams, locating 135
 - loading Tray 1 60
 - loading Tray 2 64
 - loading Tray 3 67
 - ordering 23
 - output 16
 - precautions 48
 - printing guidelines 51
 - recycling 192
 - selecting 48
 - sizes 49
 - trays, configuring 34
 - types to avoid 51
 - weights 50
- Paper Handling Menu values 34
- paper handling menu items 34
- Paper Jam Recovery enabling 136
- paper jam recovery
 - description 136
- paper jams
 - avoiding 139
 - causes 133, 137
 - clearing 138
 - frequent 139

- front duplex drawer 145
- locating 135
- messages 133
- troubleshooting 128
- upper rear door 143
- parallel cable
 - connecting 98
 - illustration 98
 - ordering 23
 - pin configuration 99
 - specifications 98
- parallel configuration 98
- parallel interface, disabling 44
- parts, ordering 23, 204
- PCL (Printer Control Language) 175
 - command syntax 177
 - commands 181
 - escape sequences 178
 - fonts, selecting 180
- PCL fonts, selecting 88
- pitch 91
- PJL (Printer Job Language) 176
- point size 91
- PostScript Emulation typefaces 92
- PostScript emulation
 - font list 91
- power requirements 187
- PowerSave
 - changing settings 41
 - description of 35
- prepunched paper
 - loading 60
- print jobs
 - controlling 22, 55
 - output bins, selecting 55
 - stopping 74
- print media
 - See* envelopes
 - See* media
 - See* paper
 - See* transparencies
- print quality problems 156
- print quality, problems 155
- printer
 - accessories 23
 - adding memory 19
 - cable pin configuration 99
 - commands 22
 - components 20, 21
 - configuration page, interpreting 32
 - configuration page, printing 32
 - connectivity 17
 - control panel 25
 - default settings 46
 - driver, ordering 204

- energy consumption 189
- environmental features 17
- feeding problems 146
- fonts 16
- in shared environment 16
- incorrect output 165
- input 16
- interface settings, changing 37
- interfaces 99
- languages 42
- maintenance 111
- memory 16, 18
- memory, adding 19, 170
- memory, managing 19
- memory, resetting 45
- messages 114, 121
- network security 103
- output problems 165
- paper handling 16
- paper jams 139
- parallel cable 98
- parallel interface, disabling 44
- parts, recycling 191
- PCL commands 175, 181
- performance 16
- personalities, supported 16
- personalities, switching 42
- power consumption 187
- power requirements 187
- resetting factory defaults 46
- response problems 150
- settings 35
- settings, selecting 22
- shared environment 16
- shared environments 40
- software, ordering 204
- supplies 23
- troubleshooting 32
- warranty 201
- Printer Control Language (PCL)
 - command syntax 177
 - commands 175, 181
 - escape sequences 178
 - fonts, selecting 180
- printer driver
 - settings 22
 - verifying 94
- printer fonts
 - See* fonts
- printer interfaces
 - parallel configuration 98
- Printer Job Language (PJM) 176
- printer messages
 - See* error messages
- printer personalities 42
- printer problems
 - See* troubleshooting
- printing
 - See also* color printing
 - See also* duplex printing
 - color, using 75
 - controlling print jobs 22
 - envelopes 61
 - font guidelines 93
 - HP FontSmart, using 84
 - internal TrueType fonts 85
 - on custom-size media 73
 - on letterhead 73
 - printer default fonts 86
 - problems 163
 - selecting fonts 87
 - selecting symbol sets 87
 - stopping a print job 74
 - using Tray 3 66
 - using type fonts 85
- Printing Menu
 - descriptions 36
 - items 36
 - selections 36
- problems
 - See* error messages
 - See* troubleshooting
- product 189
 - acoustic emissions 188
 - customer support 206
 - extended warranty 192
 - features 16
 - maintenance agreements 203
 - recycling 191
 - safety 197
 - specifications 187
 - stewardship 189
 - warranty 201
 - worldwide sales and service 208

R

- RAM (random access memory) 16
- random access memory (RAM) 16
- ready light, interpreting 29
- recycled paper, using 192
- recycling toner cartridges 190
- reference materials, ordering 23
- regulatory information 193
- repairs 203, 206
- repetitive defects 162
- Resets Menu
 - description of 39
 - items 39

S

- safety information
 - laser safety 197
 - toner material safety 197
- sales and service offices 208–211
- Screen Match 77
- securing network 103
- selecting
 - default font 86
 - fonts 87
 - media 48, 56
 - output bins 55
 - PCL fonts 88
 - printer settings 22
- service agreements
 - customer support
 - types 203
- sizes
 - media 49
 - paper 49
- smear 155
- smudges 161
- soft fonts, availability 96
- software application problems 167
- software, ordering 204
- specifications
 - acoustic emissions 188
 - electrical 187
 - operating environment 187
- stopping a print job 74
- stray toner 158
- supplies, ordering 23, 205

T

- throughput 18
- toner 155
 - See also* toner cartridges
 - densities, setting 38
 - density sensor 117
 - low 35
 - ordering 23
 - out 35
 - problems 158
- toner cartridges
 - replacement intervals 114
- toner cartridges, recycling 190
- transparencies
 - feeding problems 148
 - ordering 23
 - print quality problems 160
 - printing problems 162
 - tray capacities 50
- tray
 - capacities 49
 - priority, configuring 58

- Tray 1
 - configuring 57
 - loading 60
 - printing from 60
- Tray 2
 - configuring 58
 - feeding problems 147
 - loading 64
- Tray 3
 - configuring 58
 - feeding problems 147
 - illustration 66
 - loading 67
 - ordering 23
 - troubleshooting 152
- trays 56
 - locking 56
 - multipurpose 59
- troubleshooting
 - See also* paper jams 135
 - checklist 134
 - color printing problems 163
 - control panel problems 154
 - envelopes jamming 148
 - faded print 157
 - paper jam recovery 136
 - paper jams 128, 135, 138, 139
 - print quality problems 155
 - printer output 165
 - printer response problems 150
 - repetitive defects 162
 - slow print speed 18
 - smudges 161
 - stray toner 158
 - toner smear 155
 - Tray 1 139
 - Tray 2 147
 - Tray 3 147, 152
 - vertical lines 156
- type
 - See also* fonts
 - available printer fonts 90
 - Postscript typefaces 92
 - printer default fonts 86
 - special effects 95

V

- vertical bands 156
- vertical lines 156

W

- warning messages, defining 120
- warranty 201
- wavy characters 159
- worldwide sales and service 208

Copyright© 1998
Hewlett-Packard Co.
Printed in USA

**Manual Part No.
C4084-90937**



Printed on at least
50% Total Recycled Fiber with
at least 10% Post-Consumer Paper



C4084-90937