



32X (Max) SCSI-2 CD-ROM Drive Installation and User's Guide

Note

Before you install this product and use this information, be sure to read the product warranties and notices information included with the system unit in which you are installing the product.

First Edition (October 1998)

The following paragraph does not apply to the United Kingdom or any country where such provisions are inconsistent with local law: THIS PUBLICATION IS PROVIDED "AS IS" WITHOUT WARRANTY OF ANY KIND, EITHER EXPRESS OR IMPLIED, INCLUDING, BUT NOT LIMITED TO, THE IMPLIED WARRANTIES OF MERCHANTABILITY OR FITNESS FOR A PARTICULAR PURPOSE. Some states do not allow disclaimer of express or implied warranties in certain transactions, therefore, this statement may not apply to you.

This publication could include technical inaccuracies or typographical errors. Changes are periodically made to the information herein; these changes will be incorporated in new editions of the publication. The manufacturer may make improvements and/or changes in the product(s) and/or the program(s) described in this publication at any time, without notice.

It is possible that this publication may contain reference to, or information about, products (machines and programs), programming, or services that are not announced in your country. Such references or information must not be construed to mean that these products, programming, or services will be announced in your country. Any reference to a specific licensed program in this publication is not intended to state or imply that you can use only that licensed program. You can use any functionally equivalent program instead.

Requests for technical information about products should be made to your authorized reseller or marketing representative.

© International Business Machines Corporation 1998. All rights reserved.

Note to U.S. Government Users -- Documentation related to restricted rights -- Use, duplication or disclosure is subject to restrictions set forth in GSA ADP Schedule Contract with IBM Corp.

Contents

Safety Information	v
Handling the 32X SCSI-2 CD-ROM Drive	vii
Electrostatic Discharge Protection	vii
About This Book	ix
ISO 9000	ix
Related Publications	ix
Trademarks and Acknowledgments	ix
Laser Safety Information	x
Chapter 1. Overview	1-1
Front View of CD-ROM Drive	1-1
Rear View of CD-ROM Drive	1-2
Understanding the Status Lights	1-2
Other Handling Considerations	1-3
Handling Compact Discs	1-3
Loading a Compact Disc Horizontally	1-4
Loading a Compact Disc Vertically	1-5
Opening the Tray Manually	1-5
Playing an Audio CD	1-6
Chapter 2. Preparing to Install the 32X SCSI-2 CD-ROM Drive	2-1
Verifying Your Hardware Requirements	2-1
Verifying Your Software Requirements	2-1
Checking Your Package	2-1
Gathering Tools and Documentation	2-2
Planning Your SCSI Device Layout	2-2
Determining Your SCSI Device Address	2-2
Setting the SCSI Address	2-4
Rear View and Jumper Pin Positions on the 32X SCSI-2 CD-ROM Drive	2-6
Chapter 3. Installing the 32X SCSI-2 CD-ROM Drive	3-1
Installing and Connecting the Drive	3-1
Configuring the 32X SCSI-2 CD-ROM Drive	3-2
Verifying the Installation	3-2
Extending the Vertical Retaining Tabs	3-3
Chapter 4. Installing Device Drivers	4-1
Installing Device Drivers on an AIX System	4-1

Appendix A. Communications Statements	A-1
Federal Communications Commission (FCC) Statement	A-1
European Union (EU) Statement	A-2
International Electrotechnical Commission (IEC) Statement	A-2
United Kingdom Telecommunications Safety Requirements	A-2
Avis de conformité aux normes du ministère des Communications du Canada	A-4
Canadian Department of Communications Compliance Statement	A-4
VCCI Statement	A-4
Radio Protection for Germany	A-4
 Reader's Comments — We'd Like to Hear From You	 X-1

Safety Information

DANGER

An electrical outlet that is not correctly wired could place hazardous voltage on metal parts of the system or the devices that attach to the system. It is the responsibility of the customer to ensure that the outlet is correctly wired and grounded to prevent an electrical shock.

Before installing or removing signal cables, ensure that the power cables for the system unit and all attached devices are unplugged.

When adding or removing any additional devices to or from the system, ensure that the power cables for those devices are unplugged before the signal cables are connected. If possible, disconnect all power cables from the existing system before you add a device.

Use one hand, when possible, to connect or disconnect signal cables to prevent a possible shock from touching two surfaces with different electrical potentials.

During an electrical storm, do not connect cables for display stations, printers, telephones, or station protectors for communication lines.

Handling the 32X SCSI-2 CD-ROM Drive

Attention: Static electricity can damage your equipment. Leave the 32X SCSI-2 CD-ROM Drive in its bag until you are ready to install it in your system unit.

Electrostatic Discharge Protection

Take the following precautions whenever you handle the 32X SCSI-2 CD-ROM Drive or other static-sensitive devices:

- Use an anti-static wrist strap if you have one.
- Limit your movement. Movement can cause static electricity to build up around you.
- Hold the drive carefully by its frame or edges. Avoid touching solder joints, pins, or other printed circuitry.
- Do not place the drive on the system unit cover or on a metal table. If you must set it aside, put it back into its bag.
- Be very careful when you handle the drive during cold weather, as low humidity and heating increase static electricity.

About This Book

This book provides information about the 32X SCSI-2 CD-ROM Drive, and how to plan your SCSI device layout, set the SCSI address (also called a SCSI ID), install the CD-ROM drive, and use the CD-ROM drive. Use this book along with your specific system unit and operating system documentation.

ISO 9000

ISO 9000 registered quality systems were used in the development and manufacturing of this product.

Related Publications

Refer to your system unit and operating system documentation for information specific to your hardware and software configuration.

Trademarks and Acknowledgments

AIX is a registered trademark of International Business Machines Corporation

Laser Safety Information

This CD-ROM drive contains an optical laser. A label, which is attached to the drive and identifies its classification, is shown below:

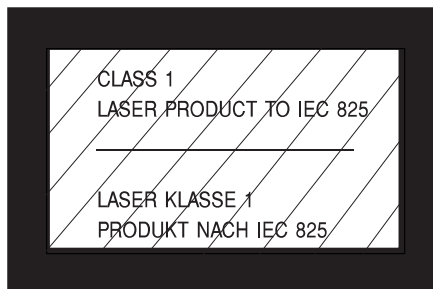

This CD-ROM drive is certified in the U.S. to conform to the requirements of the Department of Health and Human Services 21 Code of Federal Regulations (DHHS 21 CFR) Subchapter J for Class 1 laser products. Elsewhere, the drive is certified to conform to the requirements of the International Electrotechnical Commission (IEC) 825 (1st edition 1984) and CENELEC EN 60 825:1991 for Class 1 laser products.



CAUTION:

A class 1 laser is contained in this device. Do not attempt to operate the drive while it is disassembled. Do not attempt to open the covers of the drive as it cannot be serviced and is replaced as a unit.

Class 1 laser products are not considered to be hazardous. The optical laser contains internally a Class 1 gallium-arsenide laser that has a power output of 5mW maximum at 760 to 810 nanometers. The design incorporates a combination of enclosures, electronics, and redundant interlocks such that there is no exposure to laser radiation above a Class 1 level during normal operation, user maintenance, or servicing conditions.

Chapter 1. Overview

This chapter describes the features of the 32X SCSI-2 CD-ROM Drive and provides instructions for handling the drive and CD-ROM discs. The CD-ROM is a half-high, 5.25", 8-bit, single-ended, tray-loading drive. Its distinctive features include the following:

- SCSI-2 interface supports both synchronous and asynchronous data transfer
- High-speed data transfer rate of 2100KB per second (14X) at inner diameter and 4800KB per second (32X) at outer diameter due to constant RPM spin rate
- High-speed synchronous burst rate of 10MB per second
- Average random access time of 90ms
- Can be installed in either a vertical or horizontal orientation
- Loading tray accommodates both 8cm discs (in the horizontal orientation only) and 12cm discs
- Reads multi-session discs
- Reads CD-recordable discs
- Reads CD-RW discs
- Supports all major CD-ROM formats: Mode 1, Mode 2, XA, CDDA, and audio
- Contains headphone output and line output for audio

Front View of CD-ROM Drive

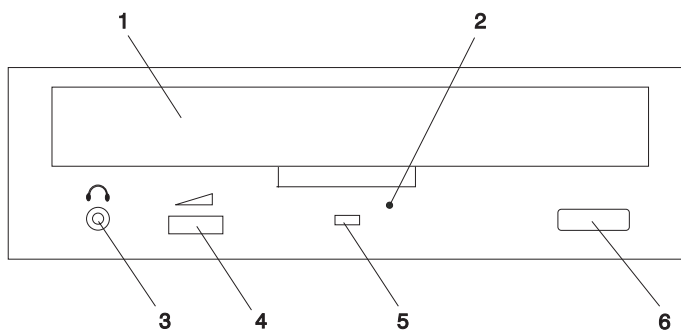

- 1 Compact Disc Tray
- 2 Emergency Eject Hole
- 3 Headphone Jack
- 4 Volume Control
- 5 Status Light
- 6 Load/Unload Button

Rear View of CD-ROM Drive

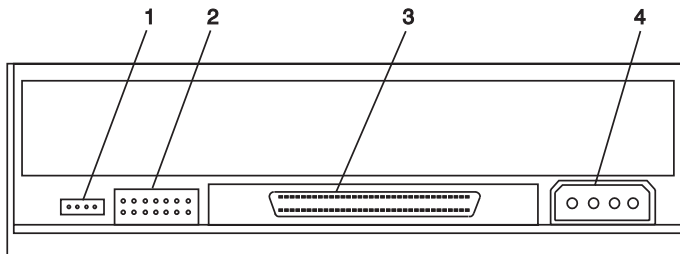

- 1 Audio Line Out Connector
- 2 Jumper Block and Pins
- 3 68-pin SCSI Interface Connector
- 4 Power Connector

Understanding the Status Lights

The status lights indicate information about the operational status of the drive. The various conditions are explained below.

If light is:	Condition is:
Off	Drive is in standby mode with or without a disc loaded.
Blinking (green)	Any of the following: <ul style="list-style-type: none">• Drive tray is inserted. The light blinks while the drive completes the initialization checkout.• Drive is reading data. The light blinks while data is being read.• Drive is in Play Audio Mode. The light blinks while the audio is playing.
On (amber)	Hardware error condition found during initialization. Note: If this occurs, contact your service representative.

Other Handling Considerations

Be sure to take the following additional precautions when you use the CD-ROM drive:

1. Remove compact discs from the tray before you move the drive anywhere.
2. Do not place the drive where any of the following conditions exist:
 - High temperature
 - High humidity
 - Excessive dust
 - Excessive vibration or sudden shock
 - Inclined surface
 - Direct sunlight
3. Do not insert foreign objects into the drive.
4. Do not stack objects on the drive.
5. Do not remove the drive covers or attempt to service the drive yourself.

Handling Compact Discs

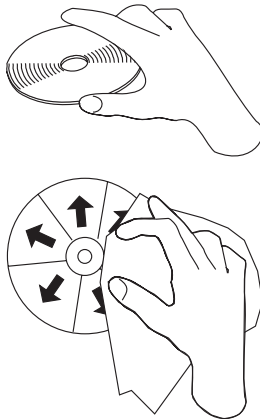

Compact discs are high-density media that must be handled with care and kept clean to ensure that they remain readable. Use the following precautions to ensure reliability:

- Hold the compact disc by the edges. Do not touch the surface of the compact disc.
- To remove dust or fingerprints, wipe the compact disc from the center to the outside of the compact disc, as shown.

Attention: Wiping the compact disc in a circular direction can cause loss of data.

- Do not write on the surface.
- Do not store or place the compact disc in direct sunlight.
- Do not use benzene, thinners, or other cleaners to clean the compact disc.
- Do not bend the compact disc.

Loading a Compact Disc Horizontally

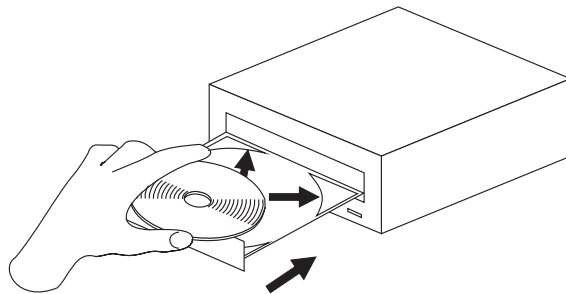

To load a compact disc into a horizontally mounted drive:

1. Press the Load/Unload button to open the tray. The tray slides out of the drive.
2. Place the compact disc in the tray with the label facing up.
3. Press the Load/Unload button, or gently push in the tray, to close the tray.

Note: Be sure that none of the vertical retaining tabs are extended when you use the drive in the horizontal position. See “Extending the Vertical Retaining Tabs” on page 3-3.

Loading a Compact Disc Vertically

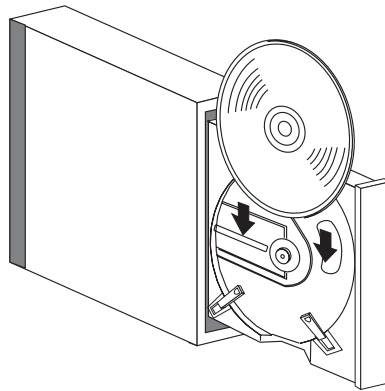

Note: The CD-ROM drive must be in the horizontal position if you are using an 8cm disc.

To load a compact disc into a vertically mounted drive:

1. Press the Load/Unload Button to open the tray. The tray slides out of the drive. Make sure the lower vertical retaining tabs are extended. See “Extending the Vertical Retaining Tabs” on page 3-3.
2. Insert the compact disc behind the tabs, label side out.
3. Press the Load/Unload button, or gently push in the tray, to close the tray.

Opening the Tray Manually

The tray should automatically open when you press the Load/Unload button. If it does not automatically open, follow these steps to force it open manually:

1. Shut down and turn the power off to your system unit.
2. Insert the straightened end of a paper clip into the emergency eject hole until you feel some resistance. See “Front View of CD-ROM Drive” on page 1-1 if you are not sure where the emergency eject hole is located.
3. Continue to push in the paper clip while you pull out the tray with your fingernail.
4. Pull the tray completely open and remove the disc. It is normal for the tray to make a clicking sound while you are pulling it open.

Playing an Audio CD

To play an audio CD, you must either have headphones connected to the headphone jack located on the front of the drive or an audio card connected to the line out connector located on the back of the drive. You must also have an audio software application installed.

The headphone jack provides the connection for headphones using a 3.5mm (1/8") stereo mini-plug. The volume control adjusts the audio output level for the headphones.

Chapter 2. Preparing to Install the 32X SCSI-2 CD-ROM Drive

This chapter covers all the things you need to do before you install your 32X SCSI-2 CD-ROM Drive. Preparing to install the drive involves the following tasks:

- Verifying your hardware requirements
- Verifying your software requirements
- Making sure your package is complete
- Gathering tools and documentation
- Planning your SCSI device layout
- Determining your SCSI device address

Verifying Your Hardware Requirements

The 32X SCSI-2 CD-ROM Drive requires the following hardware:

- ___ An available bay large enough to hold a 5-1/4 inch half-high device
- ___ A SCSI-2 adapter, which is either *built into* or *on a separate adapter card inside* your system unit
- ___ A SCSI interface cable

Verifying Your Software Requirements

The 32X SCSI-2 CD-ROM Drive is supported on several operating systems, including AIX 3.2.5 or later. Please ensure that your operating system supports this CD-ROM drive before you install it. Contact your support representative for assistance.

Checking Your Package

Check that your package contains the following items:

- ___ The 32X SCSI-2 CD-ROM Drive
- ___ Mounting screws
- ___ A CD-ROM test disc
- ___ An 50 to 68 pin interposer
- ___ A registration card
- ___ 7 jumpers (included on the jumper block)

Contact the place of purchase if an item is missing or damaged.

Important: Be sure to retain your proof of purchase as it might be required to receive warranty service.

Gathering Tools and Documentation

To install the drive, you need the following items:

- ___ A flat-blade screwdriver
- ___ Your system unit documentation, including any service documentation
- ___ Your operating system documentation

Planning Your SCSI Device Layout

SCSI devices include such hardware as disk drives, tape drives, CD-ROM drives, scanners, and printers. Some SCSI devices can be connected to or installed inside your system unit, while others can be installed externally. The devices are attached, in a daisy-chain configuration, to a SCSI adapter installed inside the system unit.

Each device in the chain has a unique SCSI address (also called a SCSI ID). When you connect more than one SCSI device, it is important that you plan the location and address of each device in the chain. You must also be sure to connect a terminator at each end of the chain. If you are using an internally connected device the SCSI adapter provides the termination for that end. The last attached device must terminate the other end of the chain.

If your configuration includes both internal and external devices, you must connect a terminator to the last external device and terminate the internal SCSI cable. The adapter terminates one end of the chain and the last device terminates the other end.

Determining Your SCSI Device Address

Before you install the 32X SCSI-2 CD-ROM Drive, you must set the SCSI address on the drive. First, you must determine which SCSI addresses are available to use. Then you choose an address and install jumpers on the drive to set the selected address. You can use any available SCSI address as long as no two SCSI devices on the same chain use the same address. No device can use address 7, which is reserved for the SCSI adapter.

SCSI addresses are in sequential order from highest to lowest priority. Refer to Table 2-1 on page 2-3 below for the priority associated with each SCSI address. For the best performance, choose the highest unused SCSI address between 6 and 0.

Note: Use only SCSI addresses 6 through 0 for this device.

Table 2-1. Data Access Priorities for SCSI Addresses		
Priority	SCSI Address	SCSI Device Name
Highest Priority	7	Adapter
↓	6	
↓	5	
↓	4	
↓	3	
↓	2	
↓	1	
↓	0	
↓	15	
↓	14	
↓	13	
↓	12	
↓	11	
↓	10	
↓	9	
Lowest Priority	8	

To find an available SCSI address on an AIX system:

1. At a system prompt, type:

```
lsdev -Cs scsi
```

then press Enter. Information such as that contained in the following example displays:

```
hdisk1 Available 00-01-00-1,0 1.0 GB SCSI Disk Drive
```

This information is interpreted as follows:

Column 1: device name (hdisk1)
 Column 2: device status (Available)
 Column 3: SCSI information (00-01-00-1,0)
 Column 4: device type (1.0 GB SCSI Disk Drive)

In this example, the SCSI address for the device name (*hdisk1*) is 1 as shown in the 1,0 portion of the string in column 3. The 0 in the 1,0 portion of the string is the SCSI bus number for that device.

2. Find an available SCSI address for the CD-ROM drive and choose the highest-priority unused address for yours. On Table 2-1, record the address you

picked for your CD-ROM drive and the names and addresses of any other installed SCSI devices. Save this information for future reference.

Setting the SCSI Address

After you choose an available SCSI address for your CD-ROM drive, you can install the jumpers on the drive to match the selected address. The SCSI address can be set from 0 to 6. Address 7 is reserved for the adapter. The 32X SCSI-2 CD-ROM Drive SCSI address is factory set at 5. Refer to “Determining Your SCSI Device Address” on page 2-2 if you need instructions for selecting another SCSI address.

To set a SCSI address, you install jumpers onto pin positions 1, 2, and/or 3, located on the jumper block, to set each position to *On* or *Off*. (See Table 2-2 on page 2-5 below.) To set a position to *On*, insert a jumper onto both the top and bottom pins. To set a position to *Off*, insert the jumper onto the top pin only.

Note: Jumpers are also installed in other positions on the jumper block to enable or disable other functions.

Refer to the figure on page 2-6 and to Table 2-2 on page 2-5 below as you go through the following steps to set the SCSI address on this drive:

Attention

Be sure to read “Handling the 32X SCSI-2 CD-ROM Drive” on page vii before you begin.

- ___ 1. Remove the drive from its bag.
- ___ 2. Place the drive on top of the bag on a flat surface.
- ___ 3. Refer to the figure on page 2-6. Locate pin positions **1**, **2**, and **3** on the drive. They are the first three positions on the left-hand side of the jumper block as you view the drive from the back. The SCSI address is factory set to 5.
- ___ 4. Using Table 2-2 on page 2-5 below as your guide, install jumpers in the correct positions to set the SCSI address you previously chose.

SCSI Address	Position 1	Position 2	Position 3
0	Off	Off	Off
1	On	Off	Off
2	Off	On	Off
3	On	On	Off
4	Off	Off	On
5	On	Off	On
6	Off	On	On

- ___ 5. Make sure the jumper on position **4** is set to On. This position enables proper parity.
- ___ 6. The jumper in position **5** should be set to Off. This sets the drive's default sector size to 2K bytes. (Setting this position to On would make the default sector size 512 bytes.)
- ___ 7. Make sure the jumper in position **6** is set to Off. Since this position does not enable or disable any function, you can use it as a spare jumper.
- ___ 8. The jumper in position **7** should be set to Off. Since this position does not enable or disable any function, you can use it as a spare jumper.

You can remove spare jumpers and store them in a safe place or install them in the Off position on any unused pin position.

Rear View and Jumper Pin Positions on the 32X SCSI-2 CD-ROM Drive

The following figure shows the jumpers as they are set at the factory.

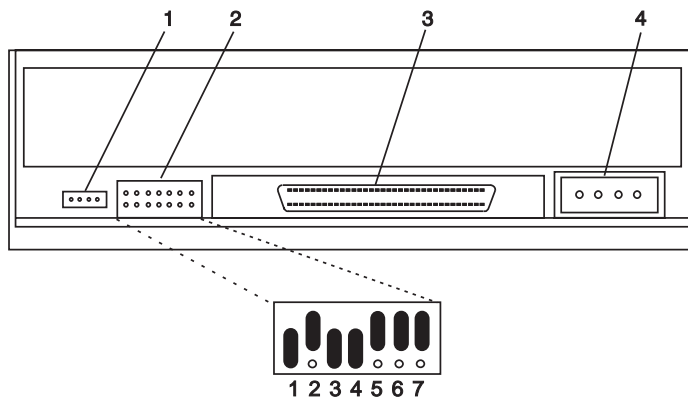

- 1 Audio Line Out Connector
- 2 Jumper Block and Jumper Pins
- 3 68-pin SCSI Interface Connector
- 4 Power Connector

Chapter 3. Installing the 32X SCSI-2 CD-ROM Drive

This chapter takes you through the steps of installing your 32X SCSI-2 CD-ROM Drive, which involves the following tasks:

- Setting the SCSI address (if necessary) see “Setting the SCSI Address” on page 2-4
- Installing the drive in your system unit
- Connecting the CD-ROM drive
- Setting the vertical retaining tabs for a vertically mounted drive (optional installation)
- Configuring the device driver software
- Verifying a successful installation

Installing and Connecting the Drive

After you set the SCSI address on your drive, you can install it into your system unit. The 32X SCSI-2 CD-ROM Drive must be installed into an available system unit bay and connected to a SCSI cable and power cable. Refer to “Rear View and Jumper Pin Positions on the 32X SCSI-2 CD-ROM Drive” on page 2-6 as you go through the following steps to install and connect the drive:

1. Follow your operating system instructions for shutting down your system, then turn off the power to your system unit. On an AIX system, type:

```
shutdown -F
```

at the system prompt, then press Enter. When `halt` completed displays, turn the system unit power off and unplug the power cord from the wall outlet.
2. Remove the covers of your system unit. Follow the instructions provided in your system unit documentation.
3. Install the drive in an available bay in your system unit. See the instructions in your system unit documentation for installing an internal device.
Important: Be sure to use the screws provided with this drive. Using the wrong size screws might cause damage to the drive.
Note: If you are installing the drive into a vertical bay, see “Extending the Vertical Retaining Tabs” on page 3-3 for important additional instructions before using.
4. Plug the SCSI interface cable into the SCSI interface connector located on the back of the drive.

- ___ 5. Plug the power cable into the power connector located on the back of the drive.
- ___ 6. If an audio card is installed in your system unit, plug the audio cable into the audio connector located on the back of the drive.
- ___ 7. Follow the directions provided in your system unit documentation to reinstall the covers of your system unit.
- ___ 8. Plug the power cord back into the wall outlet.
- ___ 9. Turn on the power to your system unit so that the operating system can update the system configuration.

Save this book and store any extra parts in a safe place in case you ever change your configuration.

Configuring the 32X SCSI-2 CD-ROM Drive

To configure the CD-ROM drive after installation, reboot your system unit. Device drivers are provided in AIX and other operating systems that support the 32X SCSI-2 CD-ROM Drive. Your operating system should recognize the drive and should automatically update your system unit configuration.

Verifying the Installation

See the instructions provided in your system unit documentation for verifying the successful installation of the drive. To verify the installation on an AIX system, type:

```
lsdev -Cs scsi
```

at the system prompt, then press Enter. A list of SCSI devices displays. An *Available* status indicates that the drive is installed and ready to use.

Extending the Vertical Retaining Tabs

You can install the drive so that it operates in either a horizontal or vertical orientation. When the drive is operated in a vertical orientation, two retaining tabs on the CD-ROM tray must be extended to hold the compact disc during loading and unloading.

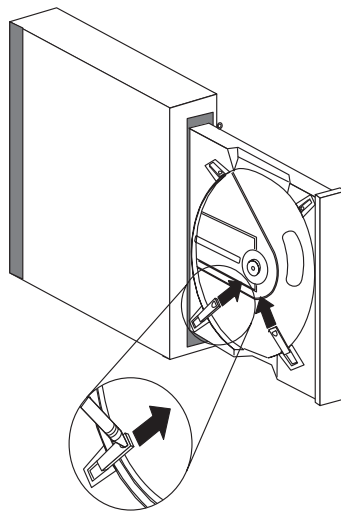

To extend the retaining tabs:

- ___ 1. Press the Load/Unload button on the drive to eject the tray. The system unit power should be on when you do this.
- ___ 2. Extend the two lower vertical retaining tabs with a ball point pen or similar object.

Note: Do not extend the two upper tabs when you operate the drive in the vertical position. Do not extend *any* of the tabs when you operate the drive in the horizontal position.

Chapter 4. Installing Device Drivers

Device driver software is provided in AIX and other operating systems that support this CD-ROM drive. However, if you should have to install device drivers, follow the installation procedures provided in your operating system documentation. Instructions for installing device drivers on an AIX system are provided in this chapter.

Installing Device Drivers on an AIX System

To install device drivers:

1. At the system prompt, log in as a root user.
2. Insert the device driver media into the appropriate media device.
3. To start SMIT, type:

```
smit devinst
```

at the prompt, then press Enter. The Install Additional Device Software panel displays. The **INPUT device/directory for software** option is highlighted for selection.
4. Press F4 to display a list of input devices from which you can select. The cursor is already positioned on the input device entry field.
5. Either type the name of the input device in the entry field or select the appropriate device, then press Enter. The Install Additional Device Software panel displays the device you selected in the **INPUT device/directory for software** field. The **SOFTWARE to install** option is highlighted.
6. Press F4 to display a list of the device packages you can install.
7. To display a Find dialog box, type:

```
/
```

in the field where the cursor is positioned.
8. Type the following device package name:

```
devices.scsi.disk.rte
```

then press Enter.
9. Press F7 to select the device package name, then press Enter. The Install Additional Device Software panel displays the completed required fields.
10. Press Enter. The **ARE YOU SURE** list displays.

11. Press Enter. The COMMAND STATUS panel displays. The term RUNNING is highlighted, indicating that the software is being installed and configured.
12. When RUNNING changes to OK, scroll down to the bottom of the panel and locate the Installation Summary. If the installation was successful, SUCCESS appears at the bottom of the panel in the Result column of the Installation Summary.
13. Remove the device driver software media from the media device.
14. Press F10 to exit SMIT.
15. To shut down and restart your system, type:
 shutdown -Fr
 then press Enter.

If you want to verify the installation, follow the steps provided in "Verifying the Installation" on page 3-2.

Appendix A. Communications Statements

The following statement applies to this product. The statement for other products intended for use with this product appears in their accompanying documentation.

Federal Communications Commission (FCC) Statement

Note: The 32X SCSI-2 CD-ROM Drive has been tested and found to comply with the limits for a Class B digital device, pursuant to Part 15 of the FCC Rules. These limits are designed to provide reasonable protection against harmful interference in a residential installation. This equipment generates, uses, and can radiate radio frequency energy and, if not installed and used in accordance with the instructions, may cause harmful interference to radio communications. However, there is no guarantee that interference will not occur in a particular installation. If this equipment does cause harmful interference to radio or television reception, which can be determined by turning the equipment off and on, the user is encouraged to try to correct the interference by one or more of the following measures:

- Reorient or relocate the receiving antenna.
- Increase the separation between the equipment and receiver.
- Connect the equipment into an outlet on a circuit different from that to which the receiver is connected.
- Consult an authorized dealer or service representative for help.

Properly shielded and grounded cables and connectors must be used in order to meet FCC emission limits. Proper cables and connectors are available from authorized dealers. Neither the provider nor the manufacturer are responsible for any radio or television interference caused by using other than recommended cables and connectors or by unauthorized changes or modifications to this equipment. Unauthorized changes or modifications could void the user's authority to operate the equipment.

This device complies with Part 15 of the FCC Rules. Operation is subject to the following two conditions: (1) this device may not cause harmful interference, and (2) this device must accept any interference received, including interference that may cause undesired operation.

Responsible Party:

International Business Machines Corporation
New Orchard Road
Armonk, New York 10504
Telephone: (919) 543-2193



Tested to Comply
With FCC Standards

FOR HOME OR OFFICE USE

European Union (EU) Statement

This product is in conformity with the protection requirements of EU Council Directive 89/336/EEC on the approximation of the laws of the Member States relating to electromagnetic compatibility. The manufacturer cannot accept responsibility for any failure to satisfy the protection requirements resulting from a non-recommended modification of the product, including the fitting of option cards supplied by third parties. Consult with your dealer or sales representative for details on your specific hardware.

This product has been tested and found to comply with the limits for Class B Information Technology Equipment according to CISPR 22 / European Standard EN 55022. The limits for Class B equipment were derived for typical residential environments to provide reasonable protection against interference with licensed communication devices.

International Electrotechnical Commission (IEC) Statement

This product has been designed and built to comply with IEC Standard 950.

United Kingdom Telecommunications Safety Requirements

This equipment is manufactured to the International Safety Standard EN60950 and as such is approved in the UK under the General Approval Number NS/G/1234/J/100003 for indirect connection to the public telecommunication network.

The network adapter interfaces housed within this equipment are approved separately, each one having its own independent approval number. These interface adapters, supplied by the manufacturer, do not use or contain excessive voltages. An excessive voltage is one which exceeds 70.7 V peak ac or 120 V dc. They interface with this equipment using Safe Extra Low Voltages only. In order to

maintain the separate (independent) approval of the manufacturer's adapters, it is essential that other optional cards, not supplied by the manufacturer, do not use main voltages or any other excessive voltages. Seek advice from a competent engineer before installing other adapters not supplied by the manufacturer.

Avis de conformité aux normes du ministère des Communications du Canada

Cet appareil numérique de la classe B est conform à la norme NMB-003 du Canada.

Canadian Department of Communications Compliance Statement

This Class B digital apparatus complies with Canadian ICES-003.

VCCI Statement

この装置は、情報処理装置等電波障害自主規制協議会（VCCI）の基準に基づきクラスB情報技術装置です。この装置は、家庭環境で使用することを目的としていますが、この装置がラジオやテレビジョン受信機に近接して使用されると、受信障害を引き起こすことがあります。
取扱説明書に従って正しい取り扱いをして下さい。

The following is a summary of the VCCI Japanese statement in the box above.

This product is a Class B Information Technology Equipment and conforms to the standards set by the Voluntary Control Council for Interference by Information Technology Equipment (VCCI). This product is aimed to be used in a domestic environment. When used near a radio or TV receiver, it may become the cause of radio interference. Read the instructions for correct handling.

Radio Protection for Germany

Dieses Gerät ist berechtigt in Übereinstimmung mit dem deutschen EMVG vom 9.Nov.92 das EG-Konformitätszeichen zu führen.

Der Aussteller der Konformitätserklärung ist die IBM Germany.

Dieses Gerät erfüllt die Bedingungen der EN 55022 Klasse B.

Reader's Comments — We'd Like to Hear From You

32X (Max) SCSI-2 CD-ROM Drive Installation and User's Guide

Order Number: 08L0385

Overall how satisfied are you with the information in this book?

	Very Satisfied	Satisfied	Neutral	Dissatisfied	Very Dissatisfied
Overall Satisfaction	<input type="checkbox"/>	<input type="checkbox"/>	<input type="checkbox"/>	<input type="checkbox"/>	<input type="checkbox"/>

How satisfied are you that the information in this book is:

	Very Satisfied	Satisfied	Neutral	Dissatisfied	Very Dissatisfied
Accurate	<input type="checkbox"/>	<input type="checkbox"/>	<input type="checkbox"/>	<input type="checkbox"/>	<input type="checkbox"/>
Complete	<input type="checkbox"/>	<input type="checkbox"/>	<input type="checkbox"/>	<input type="checkbox"/>	<input type="checkbox"/>
Easy to find	<input type="checkbox"/>	<input type="checkbox"/>	<input type="checkbox"/>	<input type="checkbox"/>	<input type="checkbox"/>
Easy to understand	<input type="checkbox"/>	<input type="checkbox"/>	<input type="checkbox"/>	<input type="checkbox"/>	<input type="checkbox"/>
Well organized	<input type="checkbox"/>	<input type="checkbox"/>	<input type="checkbox"/>	<input type="checkbox"/>	<input type="checkbox"/>
Applicable to your tasks	<input type="checkbox"/>	<input type="checkbox"/>	<input type="checkbox"/>	<input type="checkbox"/>	<input type="checkbox"/>

Please tell us how we can improve this book:

Thank you for your response. May we contact you? Yes No

When you send comments to us, you grant us a nonexclusive right to use or distribute your comments in any way we believe appropriate without incurring any obligation to you.

Name

Address

Company or Organization

Phone Number

Cut or Fold
Along Line

Fold and Tape

Please do not Staple

Fold and Tape



NO POSTAGE
NECESSARY
IF MAILED IN THE
UNITED STATES

BUSINESS REPLY MAIL

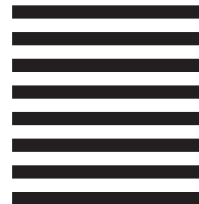

POSTAGE WILL BE PAID BY ADDRESSEE

Information Development
Department H6DS-9561
11400 Burnet Road
Austin, TX 78758-3493



Fold and Tape

Please do not Staple

Fold and Tape

Cut or Fold
Along Line



Part Number: 08L0385



Printed in the United States of America
on recycled paper containing 10%
recovered post-consumer fiber.

08L0385

