



MINI SYSTEMS INC.

20 DAVID ROAD

NORTH ATTLEBORO, MA 02760

(508) 695-0203

THIN FILM PRODUCT CATALOG

Precision Thin Film Chip Resistors

Thin Film Chip Capacitors

Microwave Chip Resistors

Microwave Couplers

Chip Attenuators

Wilkinson Power Dividers

Resistor Arrays

RC Networks

Custom Patterned Substrates

www.Mini-SystemsInc.com

MSIThin@Mini-SystemsInc.com



**Mini-Systems, INC.
Corporate Headquarters
20 David Road
North Attleboro, MA 02760**

**Tel: (508) 695-0203
Fax: (508) 695-6076**

**msithin@Mini-SystemsInc.com
www.Mini-SystemsInc.com**



**Wafer Fabrication
Thin Film Division
Attleboro, MA 02703**



**Electronic Packaging Division
168 East Bacon Street
Plainville, MA 02762
Tel: (508) 695-0203**

Thin Film Products	Page
<i>Process Capabilities.....</i>	3
<i>Thin Film Materials.....</i>	4
<i>Wire Bondable Chip Resistors.....</i>	5
<i>High Value Wire Bondable Resistors.....</i>	7
<i>Surface Mount Resistors.....</i>	9
<i>Dual Chip Resistors.....</i>	11
<i>Top Contact Microwave Chip Resistors.....</i>	13
<i>Surface Mount Microwave Chip Resistors.....</i>	15
<i>Wire Bondable High Power Chip Resistors.....</i>	17
<i>Surface Mount High Power Chip Resistors.....</i>	19
<i>Back Contact Chip Resistors.....</i>	21
<i>Thin Film Jumpers.....</i>	23
<i>Top Contact Thin Film Attenuators.....</i>	25
<i>Surface Mount Thin Film Attenuators.....</i>	27
<i>Thin Film Resistor Arrays.....</i>	29
<i>Multi-Tap Resistors.....</i>	31
<i>MINI-SMT™ Surface Mount Resistors.....</i>	33
<i>Surface Mount Resistor Networks.....</i>	35
<i>M.O.S. Chip Capacitors.....</i>	37
<i>RC Networks.....</i>	39
<i>Custom Patterned Substrates.....</i>	40
<i>Available Testing.....</i>	41
<i>Resource Page.....</i>	42

PROCESS CAPABILITIES

COMPANY PROFILE

MINI-SYSTEMS, INC. (MSI) was founded in 1968 by GLEN E. ROBERTSON.

MSI is committed to customer satisfaction through on-time deliveries, exceeding customer expectations, and offering new and innovative products and technologies. MSI ensures this through training and a unified teamwork approach. Dedication, integrity, honesty, professionalism and constant improvement to quality when dealing with customers and vendors is the responsibility of every employee. MSI strives to be the industry leader in thin film resistor technology.

MINI-SYSTEMS, INC.

- **Thick Film Division** - Thick Film Precision Chip Resistors, QPL Resistors
- **Thin Film Division** - Thin Film Precision Resistors and Capacitors
- **Electronic Package Division** - Glass Wall and Microwave Packages

APPLICATIONS

- High Reliability Microelectronics
- Medical Implantable Devices & Life Support
- Military Hardware
- Space Exploration
- Satellite Communications
- Biotelemetry
- Microwave Communications
- Surface Mount Technology
- Hybrid Designs
- Broad Research Applications
- Communications: Land and Wireless
- MCM's
- Cryogenics Technology
- Data Exchange

PRODUCTS

- Chip Resistors: Single, Back Contact, Center Tap, Dual, Multitaps, Arrays and Networks
- Microwave Resistors, Terminations, and Attenuators
- MOS, Binary Chip Capacitors and RC Network Capability
- Packaged Resistors: RSMT and RSMA LCC Replacements for Conventional Leaded Packages
- Metallized Substrates: Single or Double Sided, Polished or as Fired
- Custom Resistor Networks, Patterned Substrates and Circuits
- SMT Resistors and Resistor Arrays
- Wilkinson Power Dividers
- Microwave Couplers
- Chip Jumpers
- Chip Inductors
- One, Two, or Six-Sided Metallizations, Thru-Hole Vias Available
- Laser Cutouts, Preferred Via Diameter to Substrate Thickness Ratio 1:1

*Note: All Styles are Available in Array Combinations

EQUIPMENT

Sputtering	RF Diode and DC Magnetron, PECVD SiO ₂ and Si ₃ N ₄ Deposition
Annealing	Oxidation Furnace, Vacuum Assisted Annealing Furnace
Electroplating	Nickel and Gold. Meets Requirements MIL-G-45204C, Amendment 2, Type I and Type III, Grade A
Photoresist Systems	Negative and Positive Photoresist Systems. Spray and Spin Coating. Wet and Dry Etch Fabrication Techniques
Line Width Definition	Resistor Geometries to 0.1 Mils Conductor - Gold; 0.2 Mils, ±0.05 Mils
Photo Mask	Size 5" X 5"
Mask Tones	Resistor Level: Dark Image / Clear Field Conductor Level: Dark Field / Clear Image Clear Field / Dark Image Glassivation Level: Dark Image / Clear Field Registration Accuracy "A" to "B" Side : ±0.002"
Laser Trimming	ESI Model 44 YAG Thin Film Laser Trimmers - Spot Size to 0.0003" Trim Tolerances to ±0.01% or 2 Milliohms Resolution
Separation	Diamond Saw Separation of Silicon, Alumina, Quartz, Beryllium Oxide, and Aluminum Nitride. Laser Machining Available
Die Handling	Automatic Test and Ink Marking System Semi-Automatic Tape to Waffle Pack Die Pickers High Power Metallurgical Inspection Microscopes Tape and Reel, Waffle Pack, Gel Pack Visual Inspection per Class H and K
Quality Assurance	ISO 9001 Certified 100% Visual and DC Electrical Inspection per MIL-STD-883 Complete MIL-R-55342 Testing Capabilities Element Evaluation per MIL-H-38534, Class H and K SPC Process Monitoring, PFMEA Mini Systems Inc. Reliability Program, MSIRP™
Engineering	Autocad, File Formats Handled Include DXF & IGES. Comprehensive Design Review and Testing

THIN FILM MATERIALS

SUBSTRATE MATERIALS

Material	Size	Thickness	Surface Finish	Dielectric Constant (@ 1MHz)	Coefficient of Thermal Expansion ($\times 10^{-6}/^{\circ}\text{C}$)	Thermal Conductivity (W/m•K)
Silicon (Si) (with 12kÅ SiO ₂)	3" Dia.	0.005" - 0.015"	Chemical Polish	N/A (SiO ₂ 1.38)	2.49 - 4.44 (25°C to <1000°C)	149 (SiO ₂ 1.38)
Alumina (Al ₂ O ₃)	To 4" Sq.	0.005" - 0.025"	2μ"-3μ"	9.9	7 (25°C to 300°C)	26.9
Polished Alumina (Al ₂ O ₃)	To 4" Sq.	0.005" - 0.025"	To < 2 μ"	9.9	7 (25°C to 300°C)	26.9
Quartz (Fused Silica)	3" Dia.	0.005" - 0.010"	60/40 Optical Polish	3.826	0.55 (25°C to 320°C)	1.38
Beryllium Oxide (BeO)	2.25" Sq.	0.010" - 0.025"	4μ"-6μ"	6.76	9 (25°C to <1000°C)	285
Aluminum Nitride (AlN)	2.25" Sq.	0.010" - 0.025"	6μ"-8μ"	8 - 9.1	4.6 - 5.7 (25°C to <1000°C)	170

RESISTOR MATERIALS

Material	Passivation	Sheet Resistivity (Ω/Sq)	Abs. Tolerance	Ratio Tolerance	T.C.R. (ppm/°C)	T.C. Tracking (ppm/°C)
NiChrome (NiCr)	SiO ₂ or Si ₃ N ₄	5 to 200	From ±0.01%	From ±0.01%	To ±5	To ±2
Tantalum Nitride (TaN)	Self Passivating Ta ₂ O ₅	5 to 300	From ±0.01%	From ±0.01%	To ±10	To ±2
SiChrome (SiCr)	SiO ₂ or Si ₃ N ₄	500 to 2500	From ±0.01%	From ±0.01%	To ±100	To ±5

CONDUCTOR MATERIALS

Material	Typical Thickness	Line Width Resolution	Process Technology	Lithography
Sputtered Gold (Au)	5 kÅ	0.2 mil	Sputtered	Wet Etched
Plated Gold (Au)	25 kÅ on Silicon 30 kÅ on Alumina	0.2 mil	Electroplated	Selective Plating
Aluminum (Al)	15 kÅ	0.2 mil	Sputtered	Wet Etched

ADHESION MATERIALS

Material	Typical Thickness
Palladium (Pd)	1.5kÅ
Titanium (Ti)	500Å
Titungsten (TiW)	600Å

The role of these materials is to form an adhesion layer between resistor element and the termination material. Various metals are employed to form the ideal bond for the desired resistor / conductor system used.



THIN FILM DIVISION

ISO 9001 CERTIFIED
20 DAVID ROAD

NORTH ATTLEBORO, MA 02760

EMAIL: msithin@Mini-SystemsInc.com

WEB: www.Mini-SystemsInc.com

PHONE: 508-695-0203 FAX:508-695-6076

WIRE BONDABLE CHIP RESISTORS

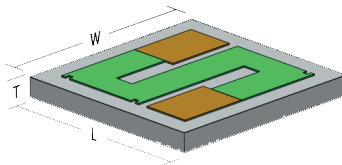

Mini-Systems Inc. **Wire Bondable Chip Resistor** series offers the design engineer a wide variety of styles with **high stability, low TCR** and **low noise** of Thin Film materials to meet the demands of cutting edge design requirements. Electrical connection to associated circuitry is accomplished through wire bonding to terminations located on the top side of the chip. Suitable die attachment methods are epoxy or eutectic attach.

GENERAL CHARACTERISTICS

Resistance Range	1Ω to 70MΩ
Resistance Tolerance	±0.01% to ±10%
Termination Material	Gold (Standard), Aluminum (Optional)
Termination Size	0.0035" Square Min. - Value Dependent
Backing Material	Bare Substrate (Standard), Gold (Optional)
Operating/Storage Temp.	-55°C to +150°C/-65°C to +150°C
Thickness	MSTF101,21: 0.006"
Voltage Rating	100VDC Max
Operating Frequency	DC to 500MHz

SUBSTRATE CHARACTERISTICS

SUBSTRATE MATERIAL	Available Thickness	Dielectric Constant @ 1MHz	Thermal Conductivity W/m•K	Current Noise		Lowest Tolerance Available
				101Ω to 250kΩ	≤ 100Ω > 250kΩ	
99.6% Alumina (Al ₂ O ₃)	0.005" - 0.025"	9.9	28	-35 dB	-30 dB	0.05%
Silicon (Si) (with 12kÅ SiO ₂)	0.005" - 0.015"	N/A (SiO ₂ 3.9)	149 (SiO ₂ 1.38)	-40 dB	-30 dB	0.01%
Quartz	0.005" - 0.010"	3.75	1.3	-40 dB	-30 dB	0.01%
Beryllium Oxide (BeO)	0.010" - 0.025"	6.7	300	-30 dB	-20 dB	0.1%
Aluminum Nitride (AlN)	0.010" - 0.025"	9.0	140 - 177	-30 dB	-20 dB	0.1%

RESISTOR CHARACTERISTICS

RESISTOR FILM	Passivation	Standard TCR	TCR Optional To (Si, Quartz, Al ₂ O ₃ , Only)
Tantalum Nitride	Ta ₂ O ₅ (Self Passivating)	±150 ppm/°C	±10 ppm/°C
NiChrome	SiO ₂	±25 ppm/°C	±5 ppm/°C

PART NUMBER DESIGNATION

MSTF	110	A	N	10001	F	GB
STYLE	TYPE	SUBSTRATE	RESISTOR FILM	OHMIC VALUE	TOLERANCE	OPTION
MSTF	See Table	A = Alumina S = Silicon Q = Quartz B = BeO N = AlN	T = Tantalum Nitride N = NiChrome	5-Digit Number: 1st 4 digits are significant with "R" as decimal point when required. 5th digit represents number of zeros.	S = ±0.01% Q = ±0.05% B = ±0.1% D = ±0.5% F = ±1% G = ±2% J = ±5% K = ±10%	D = ±5ppm/°C C = ±10ppm/°C B = ±25ppm/°C A = ±50ppm/°C F = ±100ppm/°C E = Aluminum Pads G = Gold Bond Pads GB = Gold Back TR = Tape & Reel

EXAMPLE: MSTF-110 AN - 10001F - GB

MSTF-110 Series, Alumina, NiChrome, 10kΩ, ±1% Tol., ±25ppm/°C, Gold Backside



MINI SYSTEMS INC.
MADE IN AMERICA
SINCE 1968

THIN FILM DIVISION

ISO 9001 CERTIFIED
20 DAVID ROAD

NORTH ATTLEBORO, MA 02760

EMAIL: msithin@Mini-SystemsInc.com

WEB: www.Mini-SystemsInc.com

PHONE: 508-695-0203 FAX:508-695-6076



RoHS Compliant

WIRE BONDABLE CHIP RESISTORS

CASE SIZE	TYPE	DIMENSIONS		RESISTANCE RANGE			POWER RATING ¹			
		L (±0.003") [±0.076mm]	W (±0.003") [±0.076mm]	Low Values (Std. TCR Only) (Tol. ≥0.50%)	NiCr or [TaN] on Si or Quartz	NiCr or [TaN] on Al ₂ O ₃ , BeO or AlN	Quartz	Si Al ₂ O ₃	AlN	BeO
0101	101	0.012" [0.305]	0.009" [0.229]	1Ω < 4Ω	4Ω - 200kΩ [300kΩ]	4Ω - 20kΩ [25kΩ]	10mW	50mW	200mW	400mW
0201	21	0.020" [0.508]	0.010" [0.254]	1Ω < 3Ω	3Ω - 350kΩ [500kΩ]	3Ω - 55kΩ [71.5kΩ]	10mW	50mW	200mW	400mW
0202	1	0.015" [0.381]	0.015" [0.381]	1Ω < 2Ω	2Ω - 700kΩ [1MΩ]	2Ω - 60kΩ [75kΩ]	10mW	50mW	200mW	400mW
0202	122	0.020" [0.508]	0.016" [0.406]	1Ω < 3Ω	3Ω - 1MΩ [1.3MΩ]	3Ω - 75kΩ [97.5kΩ]	25mW	125mW	500mW	1W
0202	2	0.020" [0.508]	0.020" [0.508]	1Ω < 3Ω	3Ω - 1.2MΩ [1.6MΩ]	3Ω - 130kΩ [169kΩ]	50mW	250mW	1W	2W
0302	32	0.030" [0.762]	0.020" [0.508]	1Ω < 3Ω	3Ω - 1.5MΩ [2MΩ]	3Ω - 200kΩ [250kΩ]	50mW	250mW	1W	2W
0303	33	0.030" [0.762]	0.030" [0.762]	1Ω < 2Ω	2Ω - 2.5MΩ [4MΩ]	2Ω - 250kΩ [325kΩ]	50mW	250mW	1W	2W
0402	110	0.037" [0.940]	0.017" [0.432]	1Ω < 3Ω	3Ω - 2MΩ [3MΩ]	3Ω - 200kΩ [250kΩ]	25mW	125mW	500mW	1W
0404	35	0.035" [0.889]	0.035" [0.889]	-----	1Ω - 4.5MΩ [6.5MΩ]	1Ω - 325kΩ [420kΩ]	50mW	250mW	1W	2W
0404	4	0.040" [1.016]	0.040" [1.016]	-----	1Ω - 7.5MΩ [11MΩ]	1Ω - 500kΩ [650kΩ]	70mW	350mW	1.4W	2.8W
0502	53	0.045" [1.143]	0.030" [0.762]	1Ω < 3Ω	3Ω - 4.5MΩ [6.5MΩ]	3Ω - 325kΩ [420kΩ]	100mW	500mW	2W	4W
0502	115	0.050" [1.270]	0.025" [0.635]	1Ω < 3Ω	3Ω - 4.5MΩ [6.5MΩ]	3Ω - 325kΩ [420kΩ]	50mW	250mW	1W	2W
0505	112	0.050" [1.270]	0.050" [1.270]	-----	1Ω - 10MΩ [14MΩ]	1Ω - 750kΩ [975kΩ]	100mW	500mW	2W	4W
0603	63	0.060" [1.524]	0.030" [0.762]	1Ω < 3Ω	3Ω - 7.5MΩ [11MΩ]	3Ω - 500kΩ [650kΩ]	100mW	500mW	2W	4W
0606	6	0.060" [1.524]	0.060" [1.524]	-----	1Ω - 30MΩ [40MΩ]	1Ω - 2.5MΩ [3.25MΩ]	100mW	500mW	2W	4W
0805	85	0.075" [1.905]	0.050" [1.270]	-----	1Ω - 30MΩ [40MΩ]	1Ω - 2.5MΩ [3.25MΩ]	100mW	500mW	2W	4W
1005	120	0.100" [2.540]	0.050" [1.270]	-----	1Ω - 35MΩ [45MΩ]	1Ω - 3MΩ [3.9MΩ]	100mW	500mW	2W	4W
1010	121	0.100" [2.540]	0.100" [2.540]	-----	1Ω - 60MΩ [70MΩ]	1Ω - 4MΩ [5MΩ]	150mW	750mW	3W	6W
1206	126	0.126" [3.200]	0.063" [1.524]	-----	1Ω - 40MΩ [50MΩ]	1Ω - 3.5MΩ [4.5MΩ]	150mW	750mW	3W	6W

MSTF 118 will continue to be available, size and characteristics similar to MSTF 122

MSPR 1 will continue to be available, size and characteristics same as MSTF 53

MSMR 1 will continue to be available, size and characteristics same as MSTF 101

¹ Power Rating at 70°C derated linearly to 0% at 150°C

PERFORMANCE SPECIFICATIONS

PROPERTY	TEST CONDITION	REQUIRED LIMITS	MSI TYPICAL LIMITS
SHORT TERM OVERLOAD	2.5xWVDC(6.25xRATED POWER)MIL-PRF-55342, +25°C, 5 SEC	±0.25 MAX ΔR/R	±0.10 MAX ΔR/R
HIGH TEMP EXPOSURE	+150°C, 100HRS	±0.20 MAX ΔR/R	±0.03 MAX ΔR/R
THERMAL SHOCK	MIL-STD 202, METHOD 107	±0.25 MAX ΔR/R	±0.10 MAX ΔR/R
MOISTURE RESISTANCE	MIL-STD 202, METHOD 106	±0.40 MAX ΔR/R	±0.10 MAX ΔR/R
STABILITY	MIL-STD 202 METHOD 108, 2000 HRS, +70°C, RATED POWER	±0.50 MAX ΔR/R	±0.10 MAX ΔR/R

All MSTF Series parts are produced on the same manufacturing line using the same materials and processes as parts manufactured to MIL-PRF-55342

HIGH VALUE WIRE BONDABLE RESISTORS

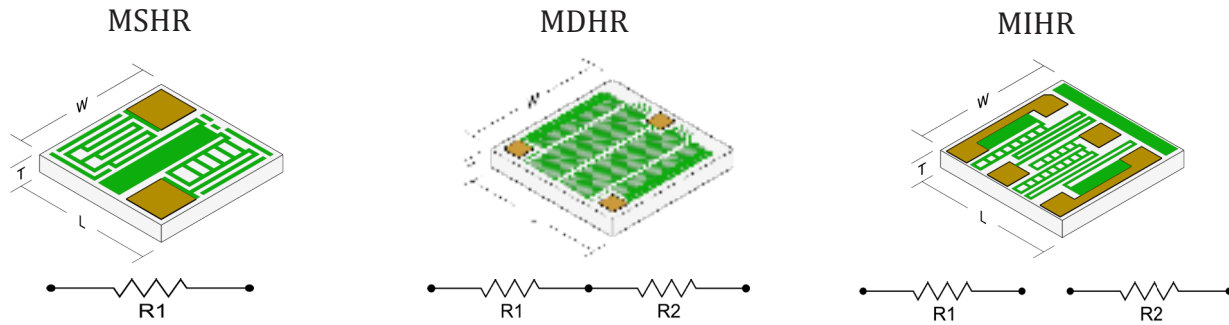

Mini-Systems Inc. **High Value Wire Bondable Chip Resistor** series offers the design engineer a wide variety of styles with the **high stability** of Thin Film materials to meet the demands of cutting edge design requirements. Electrical connection to associated circuitry is accomplished through wire bonding to terminations located on the top side of the chip. Suitable die attachment methods are epoxy or eutectic attach.

GENERAL CHARACTERISTICS

Resistance Range	301kΩ to 100MΩ ¹
Resistance Tolerance	±0.1% to ±10%
Termination Material	Gold (Standard) Aluminum (Optional)
Termination Size	0.0035" Square Min. - Value Dependent
Backing Material	Bare Substrate (Standard) Gold (Optional)
Operating Temperature	-55°C to +150°C
Storage Temperature	-65°C to +150°C
Voltage Rating	100VDC Max

¹Consult Engineering if higher valued resistors are required

SUBSTRATE CHARACTERISTICS

SUBSTRATE MATERIAL	Available Thickness	Dielectric Constant @ 1MHz	Thermal Conductivity W/m•K
Silicon (Si) (with 12kÅ SiO ₂)	0.005" - 0.015"	N/A (SiO ₂ 3.9)	149 (SiO ₂ 1.38)
Quartz	0.005" - 0.010"	3.75	1.3

RESISTOR CHARACTERISTICS

RESISTOR FILM	Passivation	Standard TCR	TCR Optional To	TCR Tracking
SiChrome	SiO ₂	±150 ppm/°C	±100 ppm/°C	±5ppm/°C

PART NUMBER DESIGNATION

MIHR	3	S	S	30003 ¹ 30003/40003 ²	F	RN	GB
STYLE	TYPE	SUBSTRATE	RESISTOR FILM	OHMIC VALUE R1/R2	TOLERANCE	RATIO ³	OPTION
MSHR	See Table	S = Silicon	S = SiChrome	5-Digit Number: 1st 4 digits are significant with "R" as decimal point when required. 5th digit represents number of zeros.	B = ±0.1% D = ±0.5% F = ±1% G = ±2% J = ±5% K = ±10%	RB = ±0.05% RC = ±0.10% RE = ±0.25% RD = ±0.50% RN = No Ratio	F = ±100ppm/°C E = Aluminum Pads G = Gold Bond Pads GB = Gold Back TR = Tape & Reel
MDHR		Q = Quartz					
MIHR							

EXAMPLE: MIHR-3-SS-30003/40003F-RN-GB

MIHR-3 Series, Silicon, SiChrome, 3MΩ/4MΩ, ±1% Tol., No Ratio, Gold Backside

¹ Use for single resistors

^{2,3} Use for dual resistors



THIN FILM DIVISION

20 DAVID ROAD

NORTH ATTLEBORO, MA 02760

EMAIL: msithin@Mini-SystemsInc.com

WEB: www.Mini-SystemsInc.com

PHONE: 508-695-0203 FAX:508-695-6076



HIGH VALUE WIRE BONDABLE RESISTORS

HIGH VALUE WIRE BONDABLE CHIP RESISTORS

CASE SIZE	TYPE	DIMENSIONS			RESISTANCE RANGE ²	POWER RATING ¹	
		L (±0.003") [±0.076mm]	W (±0.003") [±0.076mm]	T (±0.003") [±0.076mm]		Quartz	Si
0101	101	0.012" [0.305]	0.009" [0.229]	0.006" [0.152]	301kΩ - 2MΩ	10mW	50mW
0201	21	0.020" [0.508]	0.010" [0.254]	0.006" [0.152]	451kΩ - 1.8MΩ	10mW	50mW
0202	1	0.015" [0.381]	0.015" [0.381]	0.010" [0.254]	1.1MΩ - 7MΩ	10mW	50mW
0202	122	0.020" [0.508]	0.016" [0.406]	0.010" [0.254]	1.1MΩ - 2MΩ	25mW	125mW
0202	2	0.020" [0.508]	0.020" [0.508]	0.010" [0.254]	1.7MΩ - 12MΩ	50mW	250mW
0302	32	0.030" [0.762]	0.020" [0.508]	0.010" [0.254]	2.1MΩ - 15MΩ	50mW	250mW
0303	33	0.030" [0.762]	0.030" [0.762]	0.010" [0.254]	4.1MΩ - 25MΩ	50mW	250mW
0402	110	0.037" [0.940]	0.017" [0.432]	0.010" [0.254]	3.1MΩ - 20MΩ	25mW	125mW
0404	35	0.035" [0.889]	0.035" [0.889]	0.010" [0.254]	6.6MΩ - 45MΩ	50mW	250mW
0404	4	0.040" [1.016]	0.040" [1.016]	0.010" [0.254]	11.1MΩ - 50MΩ	70mW	350mW
0502	53	0.045" [1.143]	0.030" [0.762]	0.010" [0.254]	6.6MΩ - 45MΩ	100mW	500mW
0502	115	0.050" [1.270]	0.025" [0.635]	0.010" [0.254]	6.6MΩ - 45MΩ	50mW	250mW
0505	112	0.050" [1.270]	0.050" [1.270]	0.010" [0.254]	14.1MΩ - 75MΩ	100mW	500mW
0603	63	0.060" [1.524]	0.030" [0.762]	0.010" [0.254]	11.1MΩ - 50MΩ	100mW	500mW
0606	6	0.060" [1.524]	0.060" [1.524]	0.010" [0.254]	40.1MΩ - 100MΩ	100mW	500mW
0805	85	0.075" [1.905]	0.050" [1.270]	0.010" [0.254]	40.1MΩ - 100MΩ	100mW	500mW

¹ Power Rating at 70°C derated linearly to 0% at 150°C

² Consult Engineering if higher valued resistors are required

DUAL HIGH VALUE WIRE BONDABLE CHIP RESISTORS

CASE SIZE	STYLE	LAYOUT	VALUES	DIMENSIONS			RESISTANCE RANGE ²	POWER RATING ¹ Per Resistor	
				L (±0.003") [±0.076mm]	W (±0.003") [±0.076mm]	T (±0.003") [±0.076mm]		Quartz	Si
0303	MDHR 3	Center Tapped	R1 ≤ R2	0.030" [0.762]	0.030" [0.762]	0.010" [0.254]	1.3MΩ - 15MΩ Per Res	25mW	125mW
0303	MIHR 3	Isolated	R1 ≤ R2	0.030" [0.762]	0.030" [0.762]	0.010" [0.254]	1.3MΩ - 15MΩ Per Res	25mW	125mW
0404	MDHR 4	Center Tapped	R1 ≤ R2	0.040" [1.016]	0.040" [1.016]	0.010" [0.254]	6.1MΩ - 25MΩ Per Res	25mW	125mW
0404	MIHR 4	Isolated	R1 ≤ R2	0.040" [1.016]	0.040" [1.016]	0.010" [0.254]	6.1MΩ - 25MΩ Per Res	25mW	125mW

¹ Power Rating at 70°C derated linearly to 0% at 150°C

² Consult Engineering if higher valued resistors are required

All MSHR, MSDR, MIHR Series parts are produced on the same manufacturing line using the same materials and processes as parts manufactured to MIL-PRF-55342

SURFACE MOUNT RESISTORS

Wrap Around (WATF)

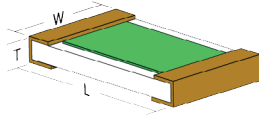

Solderable gold with nickel barrier
OR Nickel barrier pre-soldered

Half-Wrap (HWTF)

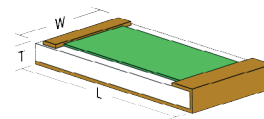

Solderable gold with nickel barrier
OR Nickel barrier pre-soldered
Isolated pad is wire bondable

Mini-Systems, Inc. **Surface Mount Chip Resistors** are available in a wide range of case sizes, with each size offered in wrap around and half wrap termination styles. All solderable terminations have a nickel barrier for enhanced solder performance. This series is designed to be connected to associated circuitry through wire-bonding, conductive epoxy or soldering. Mini-Systems, Inc. time tested materials produce chip resistors with high stability, low noise and low TCR to provide the hybrid electronics industry resistor products with the highest standards available.

GENERAL CHARACTERISTICS

Resistance Range	1Ω to 6MΩ
Resistance Tolerance	±0.01% to ±10%
Termination Material	(NU) Solderable Gold with Nickel Barrier, (NT) Nickel with Solder
Operating Temperature	-55°C to +150°C
Storage Temperature	-65°C to +150°C
Operating Frequency	DC to 500 MHz

SUBSTRATE CHARACTERISTICS

SUBSTRATE MATERIAL	Available Thickness	Dielectric Constant @ 1MHz	Thermal Conductivity W/m•K	Current Noise	
				101Ω to 250kΩ	≤ 100Ω > 250kΩ
99.6% Alumina	0.010" - 0.025"	9.9	28	-35dB	-30dB
Beryllium Oxide	0.010" - 0.025"	6.7	300	-30dB	-20dB
Aluminum Nitride	0.010" - 0.025"	9.0	140 - 177	-30dB	-20dB

RESISTOR CHARACTERISTICS

RESISTOR FILM	Passivation	Standard TCR	TCR Optional To:
Tantalum Nitride	Ta ₂ O ₅ (Self Passivating)	±150 ppm/°C	±10 ppm/°C
NiChrome	SiO ₂	±25 ppm/°C	±5 ppm/°C

PART NUMBER DESIGNATION

WATF	5	A	T	100R0	F	NT3
STYLE	TYPE	SUBSTRATE	RESISTOR FILM	OHMIC VALUE	TOLERANCE	OPTION
WATF	SEE	A = Alumina	T = Tantalum Nitride	5-Digit Number:	S = ±0.01%	D = ±5ppm/°C
HWTF	TABLE	B = BeO	N = NiChrome	1st 4 digits are significant with "R" as decimal point when required.	Q = ±0.05%	C = ±10ppm/°C
		N = AlN		5th digit represents number of zeros.	B = ±0.1%	B = ±25ppm/°C
					D = ±0.5%	A = ±50ppm/°C
					F = ±1%	F = ±100ppm/°C
					G = ±2%	NU = Solderable Au w/ Ni barrier
					J = ±5%	NT3 = Nickel w/ SAC305 Solder
					K = ±10%	NT = Nickel w/ Sn62 Solder
						TR = Tape and Reel

EXAMPLE: WATF-5-AT-100R0F-NT3

WATF-5 Series, Alumina, Tantalum Nitride, 100Ω, ±1% Tol., Nickel w/ SAC305 Solder, RoHS Compliant



THIN FILM DIVISION

ISO 9001 CERTIFIED
20 DAVID ROAD

NORTH ATTLEBORO, MA 02760

EMAIL: msithin@Mini-SystemsInc.com

WEB: www.Mini-SystemsInc.com

PHONE: 508-695-0203 FAX:508-695-6076



SURFACE MOUNT RESISTORS

CASE SIZE	TYPE	DIMENSIONS			RESISTANCE RANGE		POWER RATING ¹		
		L (±0.003") [±0.076mm]	W (±0.003") [±0.076mm]	T ² (±0.003") [±0.076mm]	Low Values NiCr or TaN (Std. TCR Only) (Tol. ≥0.5%)	Standard Values NiCr or [TaN]	Alumina	AlN	BeO
0201	21	0.020" [0.508]	0.010" [0.254]	0.006" [0.152]	1Ω < 3Ω	3Ω - 55kΩ [80kΩ]	50mW	200mW	400mW
0202	7	0.020" [0.508]	0.020" [0.508]	0.010" [0.254]	1Ω < 3Ω	3Ω - 130kΩ [190kΩ]	125mW	500mW	1W
0302	32	0.030" [0.762]	0.020" [0.508]	0.010" [0.254]	1Ω < 3Ω	3Ω - 200kΩ [300kΩ]	125mW	500mW	1W
0402	1	0.040" [1.016]	0.020" [0.508]	0.010" [0.254]	1Ω < 3Ω	3Ω - 200kΩ [300kΩ]	125mW	500mW	1W
0404	2	0.035" [0.889]	0.035" [0.889]	0.010" [0.254]	-----	1Ω - 325kΩ [500kΩ]	250mW	1W	2W
0502	8	0.055" [1.397]	0.025" [0.635]	0.010" [0.254]	1Ω < 3Ω	3Ω - 250kΩ [400kΩ]	250mW	1W	2W
0505	4	0.050" [1.270]	0.050" [1.270]	0.010" [0.254]	-----	1Ω - 750kΩ [1.25MΩ]	350mW	1.4W	2.8W
0603	63	0.060" [1.524]	0.030" [0.762]	0.010" [0.254]	1Ω < 3Ω	3Ω - 300kΩ [500kΩ]	250mW	1W	2W
0805	3	0.075" [1.905]	0.050" [1.270]	0.010" [0.254]	-----	1Ω - 2.5MΩ [4MΩ]	500mW	2W	4W
1005	6	0.100" [2.54]	0.050" [1.270]	0.010" [0.254]	-----	1Ω - 3.5MΩ [5MΩ]	500mW	2W	4W
1206	5	0.126" [3.20]	0.063" [1.60]	0.010" [0.254]	-----	1Ω - 4MΩ [3.5MΩ]	750mW	3W	6W
1505	9	0.153" [3.886]	0.050" [1.270]	0.010" [0.254]	-----	1Ω - 4MΩ [6MΩ]	750mW	3W	6W

¹ Power Rating at 70°C derated linearly to 0% at 150°C

² Thickness does not include solder

PERFORMANCE SPECIFICATIONS

PROPERTY	TEST CONDITION	REQUIRED LIMITS	MSI TYPICAL LIMITS
SHORT TERM OVERLOAD	2.5xWVDC(6.25xRATED POWER)MIL-PRF-55342, +25°C, 5 SEC	±0.25 MAX ΔR/R	±0.10 MAX ΔR/R
HIGH TEMP EXPOSURE	+150°C, 100HRS	±0.20 MAX ΔR/R	±0.03 MAX ΔR/R
THERMAL SHOCK	MIL-STD 202, METHOD 107	±0.25 MAX ΔR/R	±0.10 MAX ΔR/R
MOISTURE RESISTANCE	MIL-STD 202, METHOD 106	±0.40 MAX ΔR/R	±0.10 MAX ΔR/R
STABILITY	MIL-STD 202 METHOD 108, 2000 HRS, +70°C, RATED POWER	±0.50 MAX ΔR/R	±0.10 MAX ΔR/R

All WATF, HWTF Series parts are produced on the same manufacturing line using the same materials and processes as parts manufactured to MIL-PRF-55342

80/41 Rev. A



THIN FILM DIVISION
ISO 9001 CERTIFIED
20 DAVID ROAD
NORTH ATTLEBORO, MA 02760
EMAIL: msithin@Mini-SystemsInc.com
WEB: www.Mini-SystemsInc.com
PHONE: 508-695-0203 FAX:508-695-6076



DUAL CHIP RESISTORS

MSIR

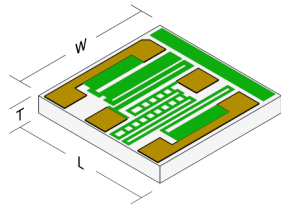

MSTF,MSDR

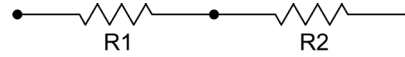
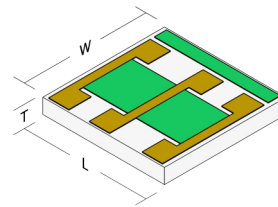

Mini-Systems, Inc. **Dual Resistor** series supplies the design engineer with two discrete resistors on a single chip with either a common or isolated node. This configuration is ideal for applications where a **closely matched tolerance, TCR and tracking** are critical and space is a premium. This series provides the **high stability, low noise, tight tolerance, ratio tracking, low TCR** and TC tracking of Mini-Systems, Inc. proven Thin Film process. Connection to associated circuitry is accomplished by wire bonding to terminations located on the top side.

CASE SIZE	STYLE	LAYOUT	VALUES	DIMENSIONS		RESISTANCE RANGE			POWER RATING ¹ Per Resistor			
				L (±0.003") [±0.076mm]	W (±0.003") [±0.076mm]	Low Values All Substrates NiCr or TaN (Std. TCR Only) (Tol.≥0.1%)	NiCr or [TaN] on Si or Quartz	NiCr or [TaN] on Al ₂ O ₃ , BeO or AlN	Quartz	Si, Al ₂ O ₃	AlN	BeO
0303	MSTF 3	Center Tapped	R1 = R2	0.030" [0.762]	0.030" [0.762]	2Ω < 4Ω Total	4Ω - 2MΩ [2.5MΩ] Total	2Ω - 250kΩ [325kΩ] Total	25mW	125mW	500mW	1W
0303	MSDR 3	Center Tapped	R1 ≤ R2	0.030" [0.762]	0.030" [0.762]	1Ω < 2Ω Per Res	2Ω - 1MΩ [1.2MΩ] Per Res	1Ω - 125kΩ [160kΩ] Per Res	25mW	125mW	500mW	1W
0303	MSIR 3	Isolated	R1 ≤ R2	0.030" [0.762]	0.030" [0.762]	1Ω < 2Ω Per Res	2Ω - 1MΩ [1.2MΩ] Per Res	1Ω - 125kΩ [160kΩ] Per Res	25mW	125mW	500mW	1W
0404	MSDR 4	Center Tapped	R1 ≤ R2	0.040" [1.016]	0.040" [1.016]	1Ω < 2Ω Per Res	2Ω - 4MΩ [6MΩ] Per Res	1Ω - 125kΩ [160kΩ] Per Res	25mW	125mW	500mW	1W
0404	MSIR 4	Isolated	R1 ≤ R2	0.040" [1.016]	0.040" [1.016]	1Ω < 2Ω Per Res	2Ω - 4MΩ [6MΩ] Per Res	1Ω - 125kΩ [160kΩ] Per Res	25mW	125mW	500mW	1W

¹ Power Rating at 70°C derated linearly to 0% at 150°C

PART NUMBER DESIGNATION

MSDR	4	A	N	10001 ¹ 10001/20001	F	RD	CG
STYLE	TYPE	SUBSTRATE	RESISTOR FILM	OHMIC VALUE	TOLERANCE	RATIO	OPTION
MSDR	SEE	A = Alumina	T = Tantalum Nitride	R1 / R2	S = ±0.01%	RA = ±0.01%	D = ±5ppm/°C
MSIR	TABLE	S = Silicon	N = NiChrome	5-Digit Number:	Q = ±0.05%	RB = ±0.05%	C = ±10ppm/°C
MSTF		Q = Quartz		1st 4 digits are significant	B = ±0.1%	RC = ±0.10%	B = ±25ppm/°C
		B = BeO		with "R" as decimal point	D = ±0.5%	RE = ±0.25%	A = ±50ppm/°C
		N = AlN		when required. 5th digit	F = ±1%	RD = ±0.50%	F = ±100ppm/°C
				represents number of zeros.	G = ±2%	RF = ±1%	E = Aluminum Pads
					J = ±5%	RN = No Ratio	G = Gold Bond Pads
					K = ±10%		GB = Gold Back
							TR = Tape & Reel

EXAMPLE: MSDR-4-AN - 10001/20001F -RD- CG

MSDR-4 Series, Alumina, NiChrome, 10kΩ / 20kΩ, ±1% Tol., ±0.50% Ratio, ±10ppm/°C, Gold

¹ Use for MSTF 3 where R1 = R2. All other styles R1 ≤ R2



THIN FILM DIVISION

ISO 9001 CERTIFIED
20 DAVID ROAD

NORTH ATTLEBORO, MA 02760

EMAIL: msithin@Mini-SystemsInc.com

WEB: www.Mini-SystemsInc.com

PHONE: 508-695-0203 FAX:508-695-6076



DUAL CHIP RESISTORS

SUBSTRATE CHARACTERISTICS

SUBSTRATE MATERIAL	Available Thickness	Dielectric Constant @ 1MHz	Thermal Conductivity W/m•K	Current Noise	
				101Ω to 250kΩ	≤ 100Ω > 250kΩ
99.6% Alumina	0.005" - 0.025"	9.9	28	-35 dB	-30 dB
Silicon (with 12kÅ SiO ₂)	0.005" - 0.015"	N/A (SiO ₂ 3.9)	149 (SiO ₂ 1.38)	-40 dB	-30 dB
Quartz	0.005" - 0.010"	3.75	1.3	-40 dB	-30 dB
Beryllium Oxide	0.010" - 0.025"	6.7	300	-30 dB	-20 dB
Aluminum Nitride	0.010" - 0.025"	9.0	140 - 177	-30 dB	-20 dB

RESISTOR CHARACTERISTICS

RESISTOR FILM	Passivation	Standard TCR	TCR Optional To	TCR Tracking
Tantalum Nitride	Ta ₂ O ₅ (Self Passivating)	±150 ppm/°C	±10 ppm/°C	±2ppm/°C
NiChrome	SiO ₂	±25 ppm/°C	±5 ppm/°C	±2ppm/°C

GENERAL CHARACTERISTICS

Resistance Range	1Ω to 6MΩ
Resistance Tolerance	±0.01% to ±10%
Termination Material	Gold (Standard) Aluminum (Optional)
Termination Size	0.0035" Square Min. - Value Dependent
Backing Material	Bare Substrate (Standard) Gold (Optional)
Standard Thickness	0.010" ±0.003"
Operating Temperature	-55°C to +150°C
Storage Temperature	-65°C to +150°C
Operating Frequency	DC to 500MHz
Thickness	0.010" (0.254mm)

PERFORMANCE SPECIFICATIONS

PROPERTY	TEST CONDITION	REQUIRED LIMITS	MSI TYPICAL LIMITS
SHORT TERM OVERLOAD	2.5xWVDC(6.25xRATED POWER)MIL-PRF-55342, +25°C, 5 SEC	±0.25 MAX ΔR/R	±0.10 MAX ΔR/R
HIGH TEMP EXPOSURE	+150°C, 100HRS	±0.20 MAX ΔR/R	±0.03 MAX ΔR/R
THERMAL SHOCK	MIL-STD 202, METHOD 107	±0.25 MAX ΔR/R	±0.10 MAX ΔR/R
MOISTURE RESISTANCE	MIL-STD 202, METHOD 106	±0.40 MAX ΔR/R	±0.10 MAX ΔR/R
STABILITY	MIL-STD 202 METHOD 108, 2000 HRS, +70°C, RATED POWER	±0.50 MAX ΔR/R	±0.10 MAX ΔR/R

All MSDR, MSTF, MSIR Series parts are produced on the same manufacturing line using the same materials and processes as parts manufactured to MIL-PRF-55342

8041 Rev. A



THIN FILM DIVISION
ISO 9001 CERTIFIED
20 DAVID ROAD
NORTH ATTLEBORO, MA 02760
EMAIL: msithin@Mini-SystemsInc.com
WEB: www.Mini-SystemsInc.com
PHONE: 508-695-0203 FAX:508-695-6076



MICROWAVE CHIP RESISTORS

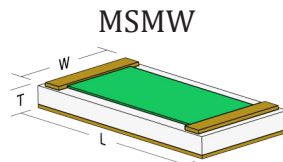

Wire bondable gold
OR Solderable gold with nickel barrier
OR Nickel barrier pre-soldered

Mini-Systems, Inc. **Top Contact Microwave Chip Resistor** series is designed to fit a wide variety of applications operating in the Microwave Bands. All sizes offer the **high stability, flat frequency response** and **low noise** of Mini-Systems, Inc. Thin Film materials. **Specialized LASER trim** techniques specifically designed for this series guarantee operation up to **40 GHz**. Microwave Chip Resistors can be attached to associated circuitry through ribbon or wire bonding, conductive epoxy, soldering to terminations or mounted as flip-chips.

GENERAL CHARACTERISTICS

Resistance Range	2Ω to 5kΩ		
Resistance Tolerance	±0.5% to ±10%		
Termination ¹	(G) Non-Solderable Gold, (NU) Solderable Au w/ Ni barrier, (NT) Nickel with Solder		
Backing Material	Bare Substrate (Standard), Gold (Optional)		
Operating Temperature	-55°C to +150°C		
Storage Temperature	-65°C to +150°C		
Operating Voltage	100V Max.		
VSWR ²	DC to 10GHz	10 to 20GHz	20-40GHz
	1.2:1	1.3:1	1.5:1

¹ Soldered or Solderable Gold require a Nickel Barrier

² Achieving operating characteristics is dependent on attachment methods in order to minimize parasitics

SUBSTRATE CHARACTERISTICS

SUBSTRATE	Available Thickness	Dielectric Constant @ 1MHz	Thermal Conductivity W/m•K	Current Noise	
				101Ω to 5kΩ	≤ 100Ω
99.6% Alumina	0.005" - 0.025"	9.9	28	-35dB	-30dB
Beryllium Oxide	0.010" - 0.025"	6.7	300	-35dB	-30dB
Aluminum Nitride	0.010" - 0.025"	9.0	140 - 177	-35dB	-30dB
Quartz	0.005" - 0.010"	3.75	1.3	-40dB	-30dB

RESISTOR CHARACTERISTICS

RESISTOR FILM	Passivation	Standard TCR	TCR Optional to:
Tantalum Nitride	Ta ₂ O ₅ (Self Passivating)	±150 ppm/°C	±25 ppm/°C
NiChrome	SiO ₂	±25 ppm/°C	±5 ppm/°C

PART NUMBER DESIGNATION

MSMW	110	A	N	10000	F	GGB
STYLE	TYPE	SUBSTRATE	RESISTOR FILM	OHMIC VALUE	TOLERANCE	OPTION
MSMW	SEE TABLE	A = Alumina B = BeO N = AlN Q = Quartz ³	T = Tantalum Nitride N = NiChrome	5-Digit Number: 1st 4 digits are significant with "R" as decimal point when required. 5th digit represents number of zeros.	D = ±0.5% F = ±1% G = ±2% J = ±5% K = ±10%	D = ±5ppm/°C C = ±10ppm/°C B = ±25ppm/°C A = ±50ppm/°C F = ±100ppm/°C G = Non-Solderable Gold NU = Solderable Au w/ Ni barrier NT = Nickel w/ Sn62 Solder NT3 = Nickel w/ SAC305 Solder GB = Gold Back TR = Tape & Reel

EXAMPLE: MSMW-110 - AN - 10000F - GGB

MSMW-110 Series, Alumina Substrate, NiChrome Resistor Film, 1kΩ, ±1% Tol., Non-Solderable Gold, Gold Backside

³ Quartz available as wire bondable only



THIN FILM DIVISION

ISO 9001 CERTIFIED
20 DAVID ROAD

NORTH ATTLEBORO, MA 02760

EMAIL: msithin@Mini-SystemsInc.com

WEB: www.Mini-SystemsInc.com

PHONE: 508-695-0203 FAX:508-695-6076



TOP CONTACT MICROWAVE CHIP RESISTORS

CASE SIZE	TYPE	DIMENSIONS			Resistance Range	Max. Operating Frequency ¹ GHz	POWER RATING ²			
		L (±0.002") [±0.051mm]	W (±0.002") [±0.051mm]	T ³ (±0.002") [±0.051mm]			Quartz	Alumina	AlN	BeO
0101	101	0.012" [0.304]	0.009" [0.228]	0.006" [0.152]	3Ω - 200Ω	40	10mW	50mW	200mW	400mW
0201	21	0.020" [0.508]	0.010" [0.254]	0.006" [0.152]	3Ω - 400Ω	40	10mW	50mW	200mW	400mW
0202	1	0.015" [0.381]	0.015" [0.381]	0.010" [0.254]	2Ω - 300Ω	40	10mW	50mW	200mW	400mW
0202	122	0.020" [0.508]	0.016" [0.406]	0.010" [0.254]	2Ω - 360Ω	40	25mW	125mW	500mW	1W
0202	7	0.020" [0.508]	0.020" [0.508]	0.010" [0.254]	2Ω - 400Ω	40	50mW	250mW	1W	2W
0302	32	0.030" [0.762]	0.020" [0.508]	0.010" [0.254]	2Ω - 500Ω	40	50mW	250mW	1W	2W
0402	110	0.037" [0.90]	0.017" [0.432]	0.010" [0.254]	2Ω - 1kΩ	40	25mW	125mW	500mW	1W
0404	2	0.035" [0.889]	0.035" [0.889]	0.010" [0.254]	2Ω - 1kΩ	26	50mW	250mW	1W	2W
0502	115	0.050" [1.270]	0.025" [0.635]	0.010" [0.254]	2Ω - 2kΩ	26	50mW	250mW	1W	2W
0505	112	0.050" [1.270]	0.050" [1.270]	0.010" [0.254]	2Ω - 2kΩ	26	100mW	500mW	2W	4W
0603	8	0.055" [1.397]	0.025" [0.635]	0.010" [0.254]	2Ω - 2kΩ	26	50mW	250mW	1W	2W
0805	3	0.075" [1.905]	0.050" [1.270]	0.010" [0.254]	2Ω - 3kΩ	26	100mW	500mW	2W	4W
1005	120	0.100" [2.540]	0.050" [1.270]	0.010" [0.254]	5Ω - 5kΩ	26	100mW	500mW	2W	4W
1010	121	0.100" [2.540]	0.100" [2.540]	0.010" [0.254]	10Ω - 5kΩ	26	150mW	750mW	3W	6W
1206	5	0.126" [3.200]	0.063" [1.600]	0.010" [0.254]	2Ω - 5kΩ	26	150mW	750mW	3W	6W

MSMW 118 will continue to be available, size and characteristics similar to MSMW122

¹ Achieving operating characteristics in this frequency range is dependent on attachment methods in order to minimize parasitics

² Power rating at 70°C derated linearly to 0% at 150°C

³ Thickness does not include solder

PERFORMANCE SPECIFICATIONS

PROPERTY	TEST CONDITION	REQUIRED LIMITS	MSI TYPICAL LIMITS
SHORT TERM OVERLOAD	2.5xVVDC(6.25xRATED POWER)MIL-PRF-55342, +25°C, 5 SEC	±0.25 MAX ΔR/R	±0.10 MAX ΔR/R
HIGH TEMP EXPOSURE	+150°C, 100HRS	±0.20 MAX ΔR/R	±0.03 MAX ΔR/R
THERMAL SHOCK	MIL-STD 202, METHOD 107	±0.25 MAX ΔR/R	±0.10 MAX ΔR/R
MOISTURE RESISTANCE	MIL-STD 202, METHOD 106	±0.40 MAX ΔR/R	±0.10 MAX ΔR/R
STABILITY	MIL-STD 202 METHOD 108, 2000 HRS, +70°C, RATED POWER	±0.50 MAX ΔR/R	±0.10 MAX ΔR/R

All MSMW Series parts are produced on the same manufacturing line using the same materials and processes as parts manufactured to MIL-PRF-55342

8041 Rev. A



THIN FILM DIVISION
ISO 9001 CERTIFIED
20 DAVID ROAD
NORTH ATTLEBORO, MA 02760
EMAIL: msithin@Mini-SystemsInc.com
WEB: www.Mini-SystemsInc.com
PHONE: 508-695-0203 FAX:508-695-6076



MICROWAVE CHIP RESISTORS

Wrap Around (WAMT)

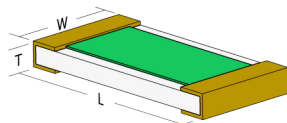

Solderable gold with nickel barrier
OR Nickel barrier pre-soldered

Half Wrap (HWMT)

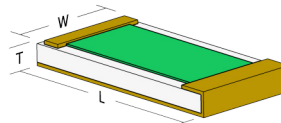

Solderable gold with nickel barrier
OR Nickel barrier pre-soldered
Isolated pad is wire bondable

Mini-Systems, Inc. **Surface Mount Microwave Chip Resistor** series is designed to fit a wide variety of applications operating in the Microwave Bands. All sizes are offered in wrap around and half wrap configurations and offer the **high stability, flat frequency response and low noise** of Mini-Systems, Inc. Thin Film materials. **Specialized LASER trim** techniques specifically designed for this series guarantee operation up to **40 GHz**. Microwave Chip Resistors can be attached to associated circuitry through ribbon or wire bonding, conductive epoxy, or soldering to terminations.

GENERAL CHARACTERISTICS

Resistance Range	2Ω to 5kΩ		
Resistance Tolerance	±0.5% to ±10%		
Termination ¹	(NU) Solderable Au w/ Ni barrier, (NT) Nickel with Solder		
Operating Temperature	-55°C to +150°C		
Storage Temperature	-65°C to +150°C		
Operating Voltage	100V Max.		
VSWR ²	DC to 10GHz	10 to 20GHz	20-40GHz
	1.2:1	1.3:1	1.5:1

¹ Soldered or Solderable Gold require a Nickel Barrier

² Achieving operating characteristics is dependent on attachment methods in order to minimize parasitics

SUBSTRATE CHARACTERISTICS

SUBSTRATE	Available Thickness	Dielectric Constant @ 1MHz	Thermal Conductivity W/m•K	Current Noise	
				101Ω to 5kΩ	≤ 100Ω
99.6% Alumina	0.005" - 0.025"	9.9	28	-35dB	-30dB
Beryllium Oxide	0.010" - 0.025"	6.7	300	-35dB	-30dB
Aluminum Nitride	0.010" - 0.025"	9.0	140 - 177	-35dB	-30dB

RESISTOR CHARACTERISTICS

RESISTOR FILM	Passivation	Standard TCR	TCR Optional to:
Tantalum Nitride	Ta ₂ O ₅ (Self Passivating)	±150 ppm/°C	±25 ppm/°C
NiChrome	SiO ₂	±25 ppm/°C	±5 ppm/°C

PART NUMBER DESIGNATION

WAMT	4	A	N	10000	F	GB
STYLE	TYPE	SUBSTRATE	RESISTOR FILM	OHMIC VALUE	TOLERANCE	OPTION
WAMT	SEE	A = Alumina	T = Tantalum Nitride	5-Digit Number:	D = ±0.5%	D = ±5ppm/°C
HWMT	TABLE	B = BeO	N = NiChrome	1st 4 digits are significant	F = ±1%	C = ±10ppm/°C
		N = AlN		with "R" as decimal point	G = ±2%	B = ±25ppm/°C
				when required. 5th digit	J = ±5%	A = ±50ppm/°C
				represents number of zeros.	K = ±10%	F = ±100ppm/°C

EXAMPLE: WAMT-4-AN-10000F-NT

WAMT-4 Series, Alumina Substrate, NiChrome Resistor Film, 1kΩ, ±1% Tol., Nickel w/ Sn62 Solder

NU = Solderable Au w/ Ni barrier
NT = Nickel w/ Sn62 Solder
NT3 = Nickel w/ SAC305 Solder
TR = Tape & Reel



THIN FILM DIVISION

ISO 9001 CERTIFIED
20 DAVID ROAD

NORTH ATTLEBORO, MA 02760

EMAIL: msithin@Mini-SystemsInc.com

WEB: www.Mini-SystemsInc.com

PHONE: 508-695-0203 FAX:508-695-6076



8041 Rev. A

SURFACE MOUNT MICROWAVE CHIP RESISTORS

CASE SIZE	TYPE	DIMENSIONS			Resistance Range	Max. Operating Frequency ¹ GHz	POWER RATING ²		
		L (±0.002") [±0.051mm]	W (±0.002") [±0.051mm]	T ³ (±0.002") [±0.051mm]			Alumina	AlN	BeO
0201	21	0.020" [0.508]	0.010" [0.254]	0.006" [0.152]	3Ω - 400Ω	20	50mW	200mW	400mW
0202	122	0.020" [0.508]	0.016" [0.406]	0.010" [0.254]	2Ω - 360Ω	20	125mW	500mW	1W
0202	7	0.020" [0.508]	0.020" [0.508]	0.010" [0.254]	2Ω - 400Ω	20	250mW	1W	2W
0302	32	0.030" [0.762]	0.020" [0.508]	0.010" [0.254]	2Ω - 500Ω	20	250mW	1W	2W
0402	1	0.040" [1.016]	0.020" [0.508]	0.010" [0.254]	2Ω - 1kΩ	20	250mW	1W	2W
0404	2	0.035" [0.889]	0.035" [0.889]	0.010" [0.254]	2Ω - 1kΩ	13	250mW	1W	2W
0502	115	0.050" [1.270]	0.025" [0.635]	0.010" [0.254]	2Ω - 2kΩ	13	250mW	1W	2W
0505	4	0.050" [1.270]	0.050" [1.270]	0.010" [0.254]	2Ω - 2kΩ	13	500mW	2W	4W
0603	8	0.055" [1.397]	0.025" [0.635]	0.010" [0.254]	2Ω - 2kΩ	13	250mW	1W	2W
0805	3	0.075" [1.905]	0.050" [1.270]	0.010" [0.254]	2Ω - 3kΩ	13	500mW	2W	4W
1005	6	0.100" [2.540]	0.050" [1.270]	0.010" [0.254]	5Ω - 5kΩ	13	500mW	2W	4W
1010	121	0.100" [2.540]	0.100" [2.540]	0.010" [0.254]	10Ω - 5kΩ	13	750mW	3W	6W
1206	5	0.126" [3.200]	0.063" [1.600]	0.010" [0.254]	2Ω - 5kΩ	13	750mW	3W	6W

¹ Achieving operating characteristics in this frequency range is dependent on attachment methods in order to minimize parasitics

² Power rating at 70°C derated linearly to 0% at 150°C

³ Thickness does not include solder

PERFORMANCE SPECIFICATIONS

PROPERTY	TEST CONDITION	REQUIRED LIMITS	MSI TYPICAL LIMITS
SHORT TERM OVERLOAD	2.5xWVDC(6.25xRATED POWER)MIL-PRF-55342, +25°C, 5 SEC	±0.25 MAX ΔR/R	±0.10 MAX ΔR/R
HIGH TEMP EXPOSURE	+150°C, 100HRS	±0.20 MAX ΔR/R	±0.03 MAX ΔR/R
THERMAL SHOCK	MIL-STD 202, METHOD 107	±0.25 MAX ΔR/R	±0.10 MAX ΔR/R
MOISTURE RESISTANCE	MIL-STD 202, METHOD 106	±0.40 MAX ΔR/R	±0.10 MAX ΔR/R
STABILITY	MIL-STD 202 METHOD 108, 2000 HRS, +70°C, RATED POWER	±0.50 MAX ΔR/R	±0.10 MAX ΔR/R

All WAMT, HWMT Series parts are produced on the same manufacturing line using the same materials and processes as parts manufactured to MIL-PRF-55342

80/41 Rev. A



THIN FILM DIVISION
ISO 9001 CERTIFIED
20 DAVID ROAD
NORTH ATTLEBORO, MA 02760
EMAIL: msithin@Mini-SystemsInc.com
WEB: www.Mini-SystemsInc.com
PHONE: 508-695-0203 FAX:508-695-6076



TOP CONTACT HIGH POWER CHIP RESISTORS

PTWB

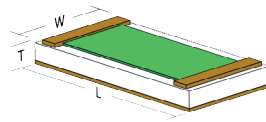

Non-solderable gold
OR Solderable gold with nickel barrier
OR Nickel barrier pre-soldered

Mini-Systems, Inc. **Wire Bondable High Power Chip Resistor** series is constructed with **high current density** Thin Film materials to fit the rigorous demands that operating **high power** have on performance. Connection methods to associated circuitry are made through either wire bonding, conductive epoxy or soldering to the terminations.

GENERAL CHARACTERISTICS

Resistance Range	2Ω to 1kΩ
Resistance Tolerance	±0.5% to ±10%
Termination Material	(G) Non-Solderable Gold, (NU) Solderable Au w/ Ni barrier, (NT) Nickel with Solder
Backing Material	Bare Substrate (Standard), Gold (Optional)
Operating Temperature	-55°C to +150°C
Storage Temperature	-65°C to +150°C
Operating Voltage	100 V Max.
Insulation Resistance	10 ¹² Ω Min.

SUBSTRATE CHARACTERISTICS

SUBSTRATE	Available Thickness	Dielectric Constant @ 1MHz	Thermal Conductivity W/m• K	Current Noise	
				101Ω to 1kΩ	≤ 100Ω
99.6% Alumina	0.005" - 0.025"	9.9	28	-35 dB	-30 dB
Beryllium Oxide	0.010" - 0.025"	6.7	300	-30 dB	-20 dB
Aluminum Nitride	0.010" - 0.025"	9.0	140 - 177	-30 dB	-20 dB

RESISTOR CHARACTERISTICS

RESISTOR FILM	Passivation	TCR
Tantalum Nitride	Ta ₂ O ₅ (Self Passivating)	±150 ppm/°C
NiChrome	SiO ₂	±25 ppm/°C

PART NUMBER DESIGNATION

PTWB	110	A	T	100R0	F	GB
STYLE	TYPE	SUBSTRATE	RESISTOR FILM	OHMIC VALUE	TOLERANCE	OPTION
PTWB	SEE TABLE	A = Alumina B = BeO N = AlN	T = Tantalum Nitride N = NiChrome	5-Digit Number: 1st 4 digits are significant with "R" as decimal point when required. 5th digit represents number of zeros.	D = ±0.5% F = ±1% G = ±2% J = ±5% K = ±10%	G = Non-Solderable Gold GB = Gold Back NU = Solderable Au w/ Ni barrier NT = Nickel w/ Sn62 Solder NT3 = Nickel w/SAC305 Solder TR = Tape and Reel

EXAMPLE: PTWB-110-AT-100R0F - GGB
PTWB-110 Series, Alumina, Tantalum Nitride, 100Ω, ±1% Tol., Non-Solderable Terminations, Gold Back



THIN FILM DIVISION

ISO 9001 CERTIFIED
20 DAVID ROAD
NORTH ATTLEBORO, MA 02760
EMAIL: msithin@Mini-SystemsInc.com
WEB: www.Mini-SystemsInc.com
PHONE: 508-695-0203 FAX:508-695-6076



TOP CONTACT HIGH POWER CHIP RESISTORS

CASE SIZE	TYPE	DIMENSIONS			RESISTANCE RANGE	POWER RATING ¹		
		L (±0.002") [±0.051mm]	W (±0.002") [±0.051mm]	T ⁴ (±0.002") [±0.051mm]		Alumina	AlN ^{2,3}	BeO ^{2,3}
0201	21	0.020" [0.508]	0.010" [0.254]	0.006" [0.152]	2Ω - 1kΩ	100mW	400mW	800mW
0202	122	0.020" [0.508]	0.016" [0.406]	0.010" [0.254]	2Ω - 1kΩ	250mW	1W	2W
0202	7	0.020" [0.508]	0.020" [0.508]	0.010" [0.254]	2Ω - 1kΩ	250mW	1W	2W
0302	32	0.030" [0.762]	0.020" [0.508]	0.010" [0.254]	2Ω - 1kΩ	250mW	1W	2W
0402	110	0.037" [0.940]	0.017" [0.432]	0.010" [0.254]	2Ω - 1kΩ	500mW	2W	4W
0404	2	0.035" [0.889]	0.035" [0.889]	0.010" [0.254]	2Ω - 1kΩ	1W	2W	4W
0502	115	0.050" [1.270]	0.025" [0.635]	0.010" [0.254]	2Ω - 1kΩ	500mW	2W	4W
0505	112	0.050" [1.270]	0.050" [1.270]	0.010" [0.254]	2Ω - 1kΩ	1W	2.8W	5.6W
0603	63	0.060" [1.524]	0.030" [0.762]	0.010" [0.254]	2Ω - 1kΩ	1W	4W	8W
0805	3	0.075" [1.905]	0.050" [1.270]	0.010" [0.254]	2Ω - 1kΩ	1W	4W	8W
1005	120	0.100" [2.54]	0.050" [1.270]	0.010" [0.254]	2Ω - 1kΩ	2W	4W	8W
1010	121	0.100" [2.54]	0.100" [2.54]	0.010" [0.254]	2Ω - 1kΩ	2W	6W	12W
1206	5	0.126" [3.20]	0.063" [1.60]	0.010" [0.254]	2Ω - 1kΩ	2W	6W	12W
1505	9	0.153" [3.89]	0.050" [1.270]	0.010" [0.254]	2Ω - 1kΩ	2W	6W	12W

¹ Power rating at 70°C derated linearly to 0% at 150°C

² Power ratings for resistors manufactured on AlN and BeO are based on adequate heat sinking to maintain the case temperature below 90°C

³ MSI recommends the gold back option for adequate heat sinking to maintain case temperature below 90°C

⁴ Thickness does not include solder

PERFORMANCE SPECIFICATIONS

PROPERTY	TEST CONDITION	REQUIRED LIMITS	MSI TYPICAL LIMITS
SHORT TERM OVERLOAD	2.5X RATED POWER, +25°C, 5 SEC	±0.25 MAX ΔR/R	±0.10 MAX ΔR/R
HIGH TEMP EXPOSURE	+150°C, 100HRS	±0.20 MAX ΔR/R	±0.03 MAX ΔR/R
THERMAL SHOCK	MIL-STD 202, METHOD 107	±0.25 MAX ΔR/R	±0.10 MAX ΔR/R
MOISTURE RESISTANCE	MIL-STD 202, METHOD 106	±0.40 MAX ΔR/R	±0.10 MAX ΔR/R
STABILITY	MIL-STD 202 METHOD 108, 2000 HRS, +70°C, RATED POWER	±0.50 MAX ΔR/R	±0.10 MAX ΔR/R

All PTWB Series parts are produced on the same manufacturing line using the same materials and processes as parts manufactured to MIL-PRF-55342

8041 Rev. A



THIN FILM DIVISION
ISO 9001 CERTIFIED
20 DAVID ROAD
NORTH ATTLEBORO, MA 02760
EMAIL: msithin@Mini-SystemsInc.com
WEB: www.Mini-SystemsInc.com
PHONE: 508-695-0203 FAX:508-695-6076



SURFACE MOUNT HIGH POWER CHIP RESISTORS

Extended Wrap (PTSM)

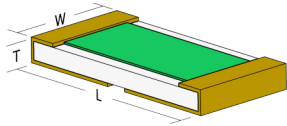

Solderable gold with nickel barrier
OR Nickel barrier pre-soldered

Wrap Around (PTSM)

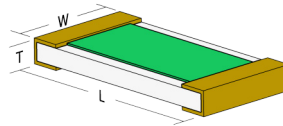

Solderable gold with nickel barrier
OR Nickel barrier pre-soldered

Half Wrap (PTHW)

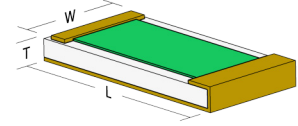

Solderable gold with nickel barrier
OR Nickel barrier pre-soldered
Isolated pad is wire bondable

Mini-Systems, Inc. **Surface Mount High Power Chip Resistor** series is constructed with **high current density** Thin Film materials to fit the rigorous demands that operating **high power** have on performance. All sizes are offered in wrap around and half wrap styles to meet your design needs. Connection methods to associated circuitry are made through either wire bonding, conductive epoxy or soldering to the terminations.

GENERAL CHARACTERISTICS

Resistance Range	2Ω to 1kΩ
Resistance Tolerance	±0.5% to ±10%
Termination Material	(NU) Solderable Gold with Nickel Barrier, (NT) Nickel with Solder
Operating Temperature	-55°C to +150°C
Storage Temperature	-65°C to +150°C
Operating Voltage	100 V Max.
Insulation Resistance	10 ¹² Ω Min.

SUBSTRATE CHARACTERISTICS

SUBSTRATE	Available Thickness	Dielectric Constant @ 1MHz	Thermal Conductivity W/m• K	Current Noise	
				101Ω to 1kΩ	≤ 100Ω
99.6% Alumina	0.005" - 0.025"	9.9	28	-35 dB	-30 dB
Beryllium Oxide	0.010" - 0.025"	6.7	300	-30 dB	-20 dB
Aluminum Nitride	0.010" - 0.025"	9.0	140 - 177	-30 dB	-20 dB

RESISTOR CHARACTERISTICS

RESISTOR FILM	Passivation	TCR
Tantalum Nitride	Ta ₂ O ₅ (SelfPassivating)	±150 ppm/°C
NiChrome	SiO ₂	±25 ppm/°C

PART NUMBER DESIGNATION

PTSM	3	A	T	100R0	F	NT3
STYLE	TYPE	SUBSTRATE	RESISTOR FILM	OHMIC VALUE	TOLERANCE	OPTION
PTSM	SEE	A = Alumina	T = Tantalum Nitride	5-Digit Number:	D = ±0.5%	NU = Solderable Au w/ Ni Barrier
PTHW	TABLE	B = BeO	N = NiChrome	1st 4 digits are significant	F = ±1%	NT = Nickel w/Sn62 Solder
		N = AlN		when required. 5th digit	G = ±2%	NT3 = Nickel w/ SAC305 Solder
				represents number of zeros.	J = ±5%	K = Extended Wrap
					K = ±10%	TR = Tape and Reel

EXAMPLE: PTSM-3-AT-100R0F - NT3
PTSM-3 Series, Alumina, Tantalum Nitride, 100Ω, ±1% Tol., Nickel with SAC305 Solder



THIN FILM DIVISION

ISO 9001 CERTIFIED
20 DAVID ROAD
NORTH ATTLEBORO, MA 02760

EMAIL: msithin@Mini-SystemsInc.com
WEB: www.Mini-SystemsInc.com
PHONE: 508-695-0203 FAX:508-695-6076



8041 Rev. A

SURFACE MOUNT HIGH POWER CHIP RESISTORS

CASE SIZE	TYPE	DIMENSIONS			RESISTANCE RANGE	POWER RATING ¹		
		L (±0.002") [±0.051mm]	W (±0.002") [±0.051mm]	T ⁴ (±0.002") [±0.051mm]		Alumina	AlN ^{2,3}	BeO ^{2,3}
0201	21	0.020" [0.508]	0.010" [0.254]	0.006" [0.152]	2Ω - 1kΩ	100mW	400mW	800mW
0202	122	0.020" [0.508]	0.016" [0.406]	0.010" [0.152]	2Ω - 1kΩ	250mW	1W	2W
0202	7	0.020" [0.508]	0.020" [0.508]	0.010" [0.254]	2Ω - 1kΩ	250mW	1W	2W
0302	32	0.030" [0.762]	0.020" [0.508]	0.010" [0.254]	2Ω - 1kΩ	250mW	1W	2W
0402	1	0.040" [1.016]	0.020" [0.508]	0.010" [0.254]	2Ω - 1kΩ	500mW	2W	4W
0404	2	0.035" [0.889]	0.035" [0.889]	0.010" [0.254]	2Ω - 1kΩ	1W	2W	4W
0502	115	0.050" [1.270]	0.025" [0.635]	0.010" [0.254]	2Ω - 1kΩ	500mW	2W	4W
0505	4	0.050" [1.270]	0.050" [1.270]	0.010" [0.254]	2Ω - 1kΩ	1W	2.8W	5.6W
0603	63	0.060" [1.524]	0.030" [0.762]	0.010" [0.254]	2Ω - 1kΩ	1W	4W	8W
0805	3	0.075" [1.905]	0.050" [1.270]	0.010" [0.254]	2Ω - 1kΩ	1W	4W	8W
1005	6	0.100" [2.54]	0.050" [1.270]	0.010" [0.254]	2Ω - 1kΩ	2W	4W	8W
1010	121	0.100" [2.54]	0.100" [2.54]	0.010" [0.254]	2Ω - 1kΩ	2W	6W	12W
1206	5	0.126" [3.20]	0.063" [1.60]	0.010" [0.254]	2Ω - 1kΩ	2W	6W	12W
1505	9	0.153" [1.270]	0.050" [0.254]	0.010" [0.254]	2Ω - 1kΩ	2W	6W	12W

¹ Power rating at 70°C derated linearly to 0% at 150°C

² Power ratings for resistors manufactured on AlN and BeO are based on adequate heat sinking to maintain the case temperature below 90°C

³ MSI recommends the extended wrap, or half wrap options for adequate heat sinking to maintain case temperature below 90°C

⁴ Thickness does not include solder

PERFORMANCE SPECIFICATIONS

PROPERTY	TEST CONDITION	REQUIRED LIMITS	MSI TYPICAL LIMITS
SHORT TERM OVERLOAD	2.5X RATED POWER, +25°C, 5 SEC	±0.25 MAX ΔR/R	±0.10 MAX ΔR/R
HIGH TEMP EXPOSURE	+150°C, 100HRS	±0.20 MAX ΔR/R	±0.03 MAX ΔR/R
THERMAL SHOCK	MIL-STD 202, METHOD 107	±0.25 MAX ΔR/R	±0.10 MAX ΔR/R
MOISTURE RESISTANCE	MIL-STD 202, METHOD 106	±0.40 MAX ΔR/R	±0.10 MAX ΔR/R
STABILITY	MIL-STD 202 METHOD 108, 2000 HRS, +70°C, RATED POWER	±0.50 MAX ΔR/R	±0.10 MAX ΔR/R

All PTSM, PTHW Series parts are produced on the same manufacturing line using the same materials and processes as parts manufactured to MIL-PRF-55342

8041 Rev. A



THIN FILM DIVISION
ISO 9001 CERTIFIED
20 DAVID ROAD
NORTH ATTLEBORO, MA 02760
EMAIL: msithin@Mini-SystemsInc.com
WEB: www.Mini-SystemsInc.com
PHONE: 508-695-0203 FAX:508-695-6076



BACK CONTACT CHIP RESISTORS

DRBC3

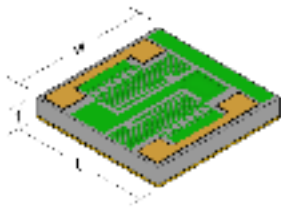

DRBC4

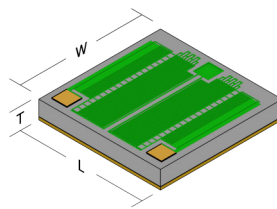

EMSBC

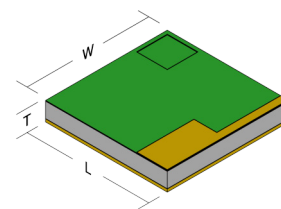

Mini-Systems, Inc. **Back Contact chip resistors** offer the **high stability, low noise and low TCR** of Mini-Systems proven Thin Film technology while providing the design engineer with a space saving alternative in hybrid designs. Each Back Contact Resistor requires only a **single wire bond to the top** side of the chip with the bottom connection made by eutectic or conductive epoxy attachment to associated circuitry. The EMSBC configurations are single resistors available in several case sizes and a wide resistance range. The DRBC configuration offers **two resistors** on a single chip and is ideal for use in applications where divider networks with closely matched tolerances and TCR are critical.

GENERAL CHARACTERISTICS

Resistance Range	5Ω to 70MΩ ¹	
Resistor Material	Tantalum Nitride	
Substrate Material	Silicon	
Passivation	Ta ₂ O ₅ (Self Passivating)	
Resistance Tolerance	±0.05% to ±10%	
Termination Material	Aluminum or Gold	
Termination Size	0.0035" Square Min. - Value Dependent	
Operating Temperature	-55°C to +125°C	
Storage Temperature	-65°C to +150°C	
Insulation Resistance	10 ¹² Ω Min.	
Dielectric Breakdown	400V Min.	
Operating Voltage	100V Max.	
Thermal Conductivity (W/m•K)	149 (Silicon) 1.38 (12kÅ SiO ₂)	
TCR	±150 ppm/°C (Standard) Optional to: ±100 ppm/°C	
TCR Tracking (Dual Resistors Only)	±2ppm/°C	
Current Noise	101Ω to 250kΩ	-35dB
	≤ 100Ω > 250kΩ	-20dB

¹ Consult Engineering if lower valued resistors are required

PART NUMBER DESIGNATION

EMSBC	110	S	T	300R0 / 500R0 ² 10001	F	RN	E
STYLE	TYPE	SUBSTRATE	RESISTOR FILM	OHMIC VALUE	TOLERANCE	RATIO	OPTION
EMSBC DRBC	See Tables	S = Silicon	T = Tantalum Nitride	5-Digit Number: 1st 4 digits are significant with "R" as decimal point when required. 5th digit represents number of zeros.	Q = 0.05% B = 0.1% C = 0.25% D = 0.5% F = ±1% G = ±2% J = ±5% K = ±10%	RA = ±0.01% RB = ±0.05% RC = ±0.10% RE = ±0.25% RD = ±0.50% RF = ± 1% RN = No Ratio	F = ±100ppm/°C E = Aluminum Bond Pads G = Gold Bond Pads TR = Tape & Reel

EXAMPLE: EMSBC-110-ST-10001F-E

EMSBC -110 Series, Silicon, Tantalum, 10kΩ ±1% Tol., ±150 ppm/°C, Aluminum Bond Pads

² Use for Dual Resistors Only - (R1 ≤ R2)



THIN FILM DIVISION

ISO 9001 CERTIFIED
20 DAVID ROAD

NORTH ATTLEBORO, MA 02760

EMAIL: msithin@Mini-SystemsInc.com

WEB: www.Mini-SystemsInc.com

PHONE: 508-695-0203 FAX:508-695-6076



BACK CONTACT CHIP RESISTORS



SINGLE RESISTOR BACK CONTACT SERIES

CASE SIZE	STYLE EMSBC	DIMENSIONS			RESISTANCE RANGE			POWER RATING ¹
		L (±0.003") [±0.076mm]	W (±0.003") [±0.076mm]	T (±0.002") [±0.051mm]	MIN	MAX OPT TCR ±100ppm/°C	MAX STD TCR ±150ppm/°C	
0201	21	0.020" [0.508]	0.010" [0.254]	0.006" [0.152]	5Ω	60kΩ	300kΩ	50mW
0202	1	0.015" [0.381]	0.015" [0.381]	0.010" [0.254]	5Ω	200kΩ	1MΩ	50mW
0202	122	0.020" [0.508]	0.016" [0.406]	0.010" [0.254]	5Ω	200kΩ	1MΩ	125mW
0202	2	0.020" [0.508]	0.020" [0.508]	0.010" [0.254]	5Ω	320kΩ	1.6MΩ	250mW
0302	32	0.030" [0.762]	0.020" [0.508]	0.010" [0.254]	5Ω	400kΩ	2MΩ	250mW
0303	3	0.030" [0.762]	0.030" [0.762]	0.010" [0.254]	5Ω	800kΩ	4MΩ	250mW
0402	110	0.037" [0.940]	0.017" [0.432]	0.010" [0.254]	5Ω	600kΩ	3MΩ	125mW
0404	35	0.035" [0.889]	0.035" [0.889]	0.010" [0.254]	5Ω	1.3MΩ	6.5MΩ	250mW
0404	4	0.040" [1.060]	0.040" [1.060]	0.010" [0.254]	10Ω	2.4MΩ	11MΩ	350mW
0502	115	0.050" [1.270]	0.025" [0.635]	0.010" [0.254]	5Ω	1.3MΩ	6.5MΩ	250mW
0505	112	0.050" [1.270]	0.050" [1.270]	0.010" [0.254]	5Ω	2.8MΩ	14MΩ	500mW
0603	63	0.060" [1.524]	0.030" [0.762]	0.010" [0.254]	5Ω	2.4MΩ	11MΩ	500mW
0606	6	0.060" [1.524]	0.060" [1.524]	0.010" [0.254]	20Ω	8MΩ	40MΩ	500mW
1005	120	0.100" [2.540]	0.050" [1.270]	0.010" [0.254]	5Ω	9MΩ	45MΩ	500mW
1010	121	0.100" [2.540]	0.100" [2.540]	0.010" [0.254]	10Ω	14MΩ	70MΩ	750mW
1206	126	0.126" [3.200]	0.063" [1.524]	0.010" [0.254]	10Ω	10MΩ	50MΩ	750mW

MSBC2 will continue to be available, size and characteristics match EMSBC2. Available with aluminum bond pads only

¹ Power Rating at 70°C Derated Linearly to 0% at 150°C

² Consult Engineering if lower valued resistors are required

DUAL RESISTOR BACK CONTACT SERIES

Case Size	STYLE DRBC	DIMENSIONS			RESISTANCE RANGE ² Per Resistor			POWER RATING ¹ Per Resistor
		L (±0.003") [±0.076mm]	W (±0.003") [±0.076mm]	T (±0.002") [±0.051mm]	MIN	MAX OPT TCR ±100ppm/°C	MAX STD TCR ±150ppm/°C	
0303	3	0.030" [0.762]	0.030" [0.762]	0.010" [0.254]	5Ω	400kΩ	2MΩ	125mW
0404	4	0.040" [1.060]	0.040" [1.060]	0.010" [0.254]	5Ω	1.2MΩ	6MΩ	125mW

¹ Power Rating at 70°C Derated Linearly to 0% at 150°C

² Consult Engineering if lower valued resistors are required

PERFORMANCE SPECIFICATIONS

PROPERTY	TEST CONDITION	REQUIRED LIMITS	MSI TYPICAL LIMITS
SHORT TERM OVERLOAD	2.5xWVDC(6.25xRATED POWER)MIL-PRF-55342, +25°C, 5 SEC	±0.25 MAX ΔR/R	±0.10 MAX ΔR/R
HIGH TEMP EXPOSURE	+150°C, 100HRS	±0.20 MAX ΔR/R	±0.03 MAX ΔR/R
THERMAL SHOCK	MIL-STD 202, METHOD 107	±0.25 MAX ΔR/R	±0.10 MAX ΔR/R
MOISTURE RESISTANCE	MIL-STD 202, METHOD 106	±0.40 MAX ΔR/R	±0.10 MAX ΔR/R
STABILITY	MIL-STD 202 METHOD 108, 2000 HRS, +70°C, RATED POWER	±0.50 MAX ΔR/R	±0.10 MAX ΔR/R

All EMSBC, DRBC Series parts are produced on the same manufacturing line using the same materials and processes as parts manufactured to MIL-PRF-55342

THIN FILM JUMPERS

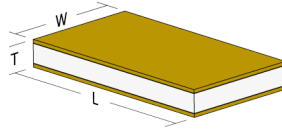

MSJC SERIES

Mini-Systems, Inc. **MSJC Series Chip Jumpers** are ideal for use as zero ohm jumpers, bonding islands, and stand-offs for specific applications. Available in a variety of standard, as well as custom sizes for your applications.

MSJC SERIES

CASE SIZE	TYPE	DIMENSIONS			MAX RESISTANCE (mΩ)
		L (±0.003") [±0.076mm]	W (±0.003") [±0.076mm]	T (±0.003") [±0.076mm]	
0101	1	0.010" [0.254]	0.010" [0.254]	0.005" [0.152]	10
0201	21	0.020" [0.508]	0.010" [0.254]	0.005" [0.152]	20
0202	2	0.020" [0.508]	0.020" [0.508]	0.010" [0.254]	10
0303	3	0.030" [0.762]	0.030" [0.762]	0.010" [0.254]	10
0303	35	0.035" [0.889]	0.035" [0.889]	0.010" [0.254]	10
0404	4	0.040" [1.060]	0.040" [1.060]	0.010" [0.254]	10
0505	5	0.050" [1.270]	0.050" [1.270]	0.010" [0.254]	10
0805	75	0.075" [1.905]	0.050" [0.889]	0.010" [0.254]	15
1010	10	0.100" [2.540]	0.100" [2.540]	0.010" [0.254]	10

CUSTOM SIZES AVAILABLE, CONSULT SALES

GENERAL CHARACTERISTICS

Substrate Materials	99.6% Alumina, other substrate materials available upon request
Metallization	Gold
Available Thickness	0.005", 0.010", 0.015", 0.020", 0.025"
Resistance	10 Milliohms per square, typical

MSJC PART NUMBER DESIGNATION

MSJC	—	10	—	AT	—	GB10
STYLE		TYPE		MATERIAL		OPTION
MSJC		See Table		AT = Alumina Substrate		G = One Side Gold GB = Gold Back 5 = 0.005" Thick 10 = 0.010" Thick 15 = 0.015" Thick 20 = 0.020" Thick 25 = 0.025" Thick

EXAMPLE: MSJC-10-AT-GB10

MSJC-10, 0.100" x 0.100", 0.010" Thick Alumina with Gold Back



MINI SYSTEMS INC.
MADE IN AMERICA
SINCE 1968

THIN FILM DIVISION

ISO 9001 CERTIFIED
20 DAVID ROAD

NORTH ATTLEBORO, MA 02760

EMAIL: msithin@Mini-SystemsInc.com

WEB: www.Mini-SystemsInc.com

PHONE: 508-695-0203 FAX: 508-695-6076



THIN FILM JUMPERS

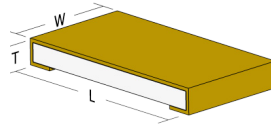

WAJC SERIES

Mini-Systems, Inc. **WAJC Series Chip Jumpers** with nickel barrier are ideal for use as zero ohm jumpers, bonding islands, and stand-offs for specific applications. Available in a variety of standard, as well as custom sizes for your applications.

WAJC SERIES

CASE SIZE	TYPE	DIMENSIONS			MAX RESISTANCE (mΩ)
		L (±0.003") [±0.076mm]	W (±0.003") [±0.076mm]	T ¹ (±0.003") [±0.076mm]	
0201	21	0.020" [0.508]	0.010" [0.254]	0.005" [0.152]	20
0202	7	0.020" [0.508]	0.020" [0.508]	0.010" [0.254]	10
0402	1	0.040" [1.016]	0.020" [0.508]	0.010" [0.254]	20
0404	2	0.035" [0.889]	0.035" [0.889]	0.010" [0.254]	10
0502	8	0.055" [1.397]	0.025" [0.635]	0.010" [0.254]	20
0505	4	0.050" [1.270]	0.050" [1.270]	0.010" [0.254]	10
0805	3	0.075" [1.905]	0.050" [1.270]	0.010" [0.254]	15
1005	6	0.100" [2.540]	0.050" [1.270]	0.010" [0.254]	20
1206	5	0.126" [3.200]	0.063" [1.600]	0.010" [0.254]	20
1505	9	0.153" [3.886]	0.050" [1.270]	0.010" [0.254]	30

¹ Thickness does not include solder
CUSTOM SIZES AVAILABLE, CONSULT SALES

GENERAL CHARACTERISTICS

Substrate Material	99.6% Alumina, other substrate materials available upon request
Metallization	(NU) Solderable Au w/ Ni barrier, (NT) Nickel with Solder
Available Thickness ¹	0.005", 0.010", 0.015", 0.020", 0.025"
Resistance	10 Milliohms per square, typical

¹ Thickness does not include solder

WAJC PART NUMBER DESIGNATION

WAJC	—	6	—	AT	—	NT10
STYLE		TYPE		MATERIAL		OPTION
WAJC		See Table		AT = Alumina Substrate		NU = Solderable Au w/ Ni barrier NT = Nickel with Sn62 Solder NT3 = Nickel with SAC305 Solder 5 = 0.005" Thick 10 = 0.010" Thick 15 = 0.015" Thick 20 = 0.020" Thick 25 = 0.025" Thick

EXAMPLE: WAJC-6-AT-NT10
WAJC-6, 0.100" x 0.100", 0.010" Thick Alumina Wraparound

8041 Rev. A



THIN FILM DIVISION
ISO 9001 CERTIFIED
20 DAVID ROAD
NORTH ATTLEBORO, MA 02760
EMAIL: msithin@Mini-SystemsInc.com
WEB: www.Mini-SystemsInc.com
PHONE: 508-695-0203 FAX:508-695-6076



THIN FILM ATTENUATORS

GENERAL CHARACTERISTICS

Resistor Material	Tantalum Nitride, NiChrome		
Bond Pads	Gold Pads, Wire or Ribbon Bondable		
Backside Surface	Bare Substrate (Standard), Gold (Optional)		
Attenuation Ranges	0dB Through -24dB; (0.5dB Steps Available)		
DC Attenuation Tolerance	±0.1dB (-0.5dB to -6dB), ±0.2dB (-0.5dB to -24dB)		
Impedance	50Ω		
Frequency Range	DC Through 40 GHz		
Current Noise	-20dB Typical		
Operating Temperature	-55°C to +150°C		
Storage Temperature	-65°C to +150°C		
VSWR ¹	DC to 10GHz	10GHz to 20GHz	20GHz to 40GHz
	1.2:1	1.3:1	1.5:1

¹ Achieving operating characteristics is dependent on attachment methods in order to minimize parasitics

SUBSTRATE CHARACTERISTICS

SUBSTRATE MATERIAL	Dielectric Constant @ 1MHz	Thermal Conductivity W/m• K
99.6% Alumina	9.9	28
Quartz (Fused Silica)	3.75	1.3
Beryllium Oxide	6.7	300
Aluminum Nitride ²	9.0	140 - 177

² Discrete Elements Only

RESISTOR CHARACTERISTICS

RESISTOR FILM	Passivation	Standard TCR	TCR Optional To
Tantalum Nitride	Ta ₂ O ₅ (Self Passivating)	±150 ppm/°C	-----
NiChrome	SiO ₂	±25 ppm/°C	±5 ppm/°C

PART NUMBER DESIGNATION

MSAT	21	A	T	5dB	G	G
STYLE	TYPE	SUBSTRATE	RESISTOR FILM	dB	TOLERANCE	OPTION
MSAT	SEE TABLE	A = Alumina B = BeO N = AlN ³ Q = Quartz	T = Tantalum Nitride N = NiChrome	0dB-24dB	F = ±0.1dB G = ±0.2dB	C = ±10ppm/°C D = ±5ppm/°C G = Wire Bondable Gold GB = Gold Back TR = Tape & Reel

EXAMPLE: MSAT-21-AT - 5DBG - G
MSAT-21 Series, Alumina, Tantalum Nitride, 5dB, ±0.2dB, Wire Bondable Gold

³ AlN Substrate is not available on Lumped Element Attenuators



THIN FILM DIVISION
ISO 9001 CERTIFIED
20 DAVID ROAD
NORTH ATTLEBORO, MA 02760
EMAIL: msithin@Mini-SystemsInc.com
WEB: www.Mini-SystemsInc.com
PHONE: 508-695-0203 FAX:508-695-6076



TOP CONTACT THIN FILM ATTENUATORS

MSAT 1

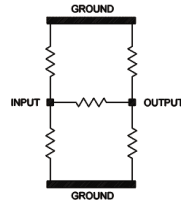
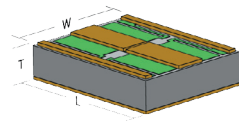

MSAT 5, 21

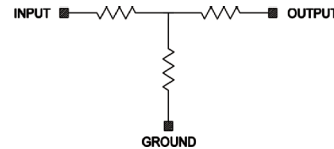
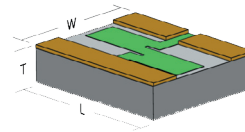

Mini-Systems, Inc. **MSAT** series discrete element Thin Film **chip attenuators** provide the design engineer with attenuators that are very accurate over operating frequencies from **DC through 40 GHz**. They offer the **low noise, low stray capacitance and tight tolerance** of Mini-Systems, Inc. Thin Film materials in compact sizes that make them ideal for applications where small footprints are required. MSAT series is offered in balanced pi or T-type styles.

MSAT SERIES

CASE SIZE	TYPE	LAYOUT	DIMENSIONS			POWER RATING ¹				ATTENUATOR TYPE	ELEMENT TYPE
			L (±0.003") [±0.076mm]	W (±0.003") [±0.076mm]	T (±0.003") [±0.076mm]	Quartz	Al ₂ O ₃	AlN	BeO		
0806	21	Top Contact	0.077" [1.956]	0.061" [1.549]	0.015" [0.381]	50 mW	250 mW	Not Available	2 W	T	Lumped
1008	1	Top Contact	0.100" [2.540]	0.080" [2.032]	0.010" [0.254]	25 mW	125 mW	500 mW	1 W	Pi	Discrete
1512	5	Top Contact	0.148" [3.759]	0.122" [3.099]	0.025" [0.635]	400 mW	2 W	Not Available	8 W	T	Lumped

¹ Power Rating at 70°C Derated Linearly to 0% at 150°C

PERFORMANCE SPECIFICATIONS

PROPERTY	TEST CONDITION	REQUIRED LIMITS	MSI TYPICAL LIMITS
HIGH TEMP EXPOSURE	+150°C, 100HRS	±0.20 MAX ΔR/R	±0.03 MAX ΔR/R
THERMAL SHOCK	MIL-STD 202, METHOD 107	±0.25 MAX ΔR/R	±0.10 MAX ΔR/R
STABILITY	MIL-STD 202 METHOD 108, 2000 HRS, +70°C, RATED POWER	±0.50 MAX ΔR/R	±0.10 MAX ΔR/R

All MSAT Series parts are produced on the same manufacturing line using the same materials and processes as parts manufactured to MIL-PRF-55342



MINI SYSTEMS INC.
MADE IN AMERICA
SINCE 1968

THIN FILM DIVISION

ISO 9001 CERTIFIED
20 DAVID ROAD
NORTH ATTLEBORO, MA 02760
EMAIL: msithin@Mini-SystemsInc.com
WEB: www.Mini-SystemsInc.com
PHONE: 508-695-0203 FAX:508-695-6076



THIN FILM ATTENUATORS

GENERAL CHARACTERISTICS

Resistor Material	Tantalum Nitride, NiChrome		
Bond Pads	(NU) Solderable Gold with Nickel Barrier, (NT) Nickel with Solder		
Attenuation Ranges	0dB Through -24dB; (0.5dB Steps Available)		
DC Attenuation Accuracy	±0.1dB (-0.5dB to -6dB), ±0.2dB (-0.5dB to -24dB)		
Impedance	50Ω		
Frequency Range	DC Through 40 GHz		
Current Noise	-20dB Typical		
Operating Temperature	-55°C to +150°C		
Storage Temperature	-65°C to +150°C		
VSWR ¹	DC to 10GHz	10GHz to 20GHz	20GHz to 40GHz
	1.2:1	1.3:1	1.5:1

¹ Achieving operating characteristics is dependent on attachment methods in order to minimize parasitics

SUBSTRATE CHARACTERISTICS

SUBSTRATE MATERIAL	Dielectric Constant @ 1MHz	Thermal Conductivity W/m• K
99.6% Alumina	9.9	28
Beryllium Oxide ¹	6.7	300
Aluminum Nitride ²	9.0	140 - 177

¹ Not Available on MSAT 3, 7, or 23

² Discrete Elements Only

RESISTOR CHARACTERISTICS

RESISTOR FILM	Passivation	Standard TCR	TCR Optional To
Tantalum Nitride	Ta ₂ O ₅ (Self Passivating)	±150 ppm/°C	-----
NiChrome	SiO ₂	±25 ppm/°C	±5 ppm/°C

PART NUMBER DESIGNATION

MSAT	—	23	—	A	—	T	—	5dB	—	G	—	NT
STYLE		TYPE		SUBSTRATE		RESISTOR FILM		dB		TOLERANCE		OPTION
MSAT		SEE TABLE		A = Alumina B = BeO ³ N = AlN ⁴		T = Tantalum Nitride N = NiChrome		0dB-24dB		F = ±0.1dB G = ±0.2dB		C = ±10ppm/°C D = ±5ppm/°C NU = Solderable Au w/ Ni Barrier NT = Nickel w/Sn62 Solder NT3= Nickel w/SAC305 Solder TR = Tape & Reel

EXAMPLE: MSAT-23-AT - 5DBG - NT

MSAT-23 Series, Alumina, Tantalum Nitride, 5dB, ±0.2dB, Nickel w/Sn62 Solder

³ BeO Substrate is not available on MSAT 3, 7, or 23

⁴ AlN Substrate is not available on Lumped Element Attenuators



MINI SYSTEMS INC.
MADE IN AMERICA
SINCE 1968

THIN FILM DIVISION
20 DAVID ROAD
NORTH ATTLEBORO, MA 02760

EMAIL: msithin@Mini-SystemsInc.com
WEB: www.Mini-SystemsInc.com
PHONE: 508-695-0203 FAX:508-695-6076



8041 Rev. A

SURFACE MOUNT THIN FILM ATTENUATORS

MSAT 2, 10

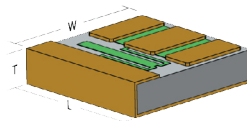

MSAT 3

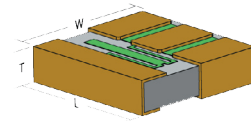

MSAT 6, 22

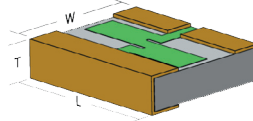

MSAT 7, 23

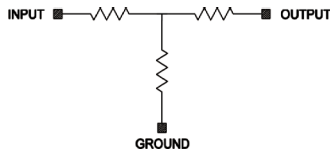
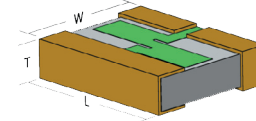

Mini-Systems, Inc. **MSAT** series discrete element Thin Film **chip attenuators** provide the design engineer with attenuators that are very accurate over operating frequencies from **DC through 40 GHz**. They offer the **low noise, low stray capacitance and tight tolerance** of Mini-Systems, Inc. Thin Film materials in compact sizes that make them ideal for applications where small footprints are required.

MSAT SERIES

CASE SIZE	TYPE	LAYOUT	DIMENSIONS			POWER RATINGS ¹			ATTENUATOR TYPE	ELEMENT TYPE
			L (±0.003") [±0.076mm]	W (±0.003") [±0.076mm]	T ² (±0.003") [±0.076mm]	Al ₂ O ₃	AlN	BeO		
0505	2	Half Wrap	0.050" [1.270]	0.050" [1.270]	0.020" [0.508]	250 mW	1 W	2 W	T	Discrete
0505	3	Surface Mount	0.050" [1.270]	0.050" [1.270]	0.020" [0.508]	250 mW	1 W	Not Available	T	Discrete
0505	10	Half Wrap	0.050" [1.270]	0.050" [1.270]	0.010" [0.254]	250 mW	1 W	2 W	T	Discrete
0806	22	Half Wrap	0.077" [1.956]	0.061" [1.549]	0.015" [0.381]	250 mW	Not Available	2 W	T	Lumped
0806	23	Surface Mount	0.077" [1.956]	0.061" [1.549]	0.015" [0.381]	250 mW	Not Available	Not Available	T	Lumped
1512	6	Half Wrap	0.148" [3.759]	0.122" [3.099]	0.025" [0.635]	2 W	Not Available	8 W	T	Lumped
1512	7	Surface Mount	0.148" [3.759]	0.122" [3.099]	0.025" [0.635]	2 W	Not Available	Not Available	T	Lumped

¹ Power Rating at 70°C Derated Linearly to 0% at 150°C

² Thickness does not include solder

PERFORMANCE SPECIFICATIONS

PROPERTY	TEST CONDITION	REQUIRED LIMITS	MSI TYPICAL LIMITS
HIGH TEMP EXPOSURE	+150°C, 100HRS	±0.20 MAX ΔR/R	±0.03 MAX ΔR/R
THERMAL SHOCK	MIL-STD 202, METHOD 107	±0.25 MAX ΔR/R	±0.10 MAX ΔR/R
STABILITY	MIL-STD 202 METHOD 108, 2000 HRS, +70°C, RATED POWER	±0.50 MAX ΔR/R	±0.10 MAX ΔR/R

All MSAT Series parts are produced on the same manufacturing line using the same materials and processes as parts manufactured to MIL-PRF-55342

80/41 Rev. A



MINI SYSTEMS INC.
MADE IN AMERICA
SINCE 1968

THIN FILM DIVISION
20 DAVID ROAD
NORTH ATTLEBORO, MA 02760

EMAIL: msithin@Mini-SystemsInc.com
WEB: www.Mini-SystemsInc.com
PHONE: 508-695-0203 FAX:508-695-6076



THIN FILM RESISTOR ARRAYS

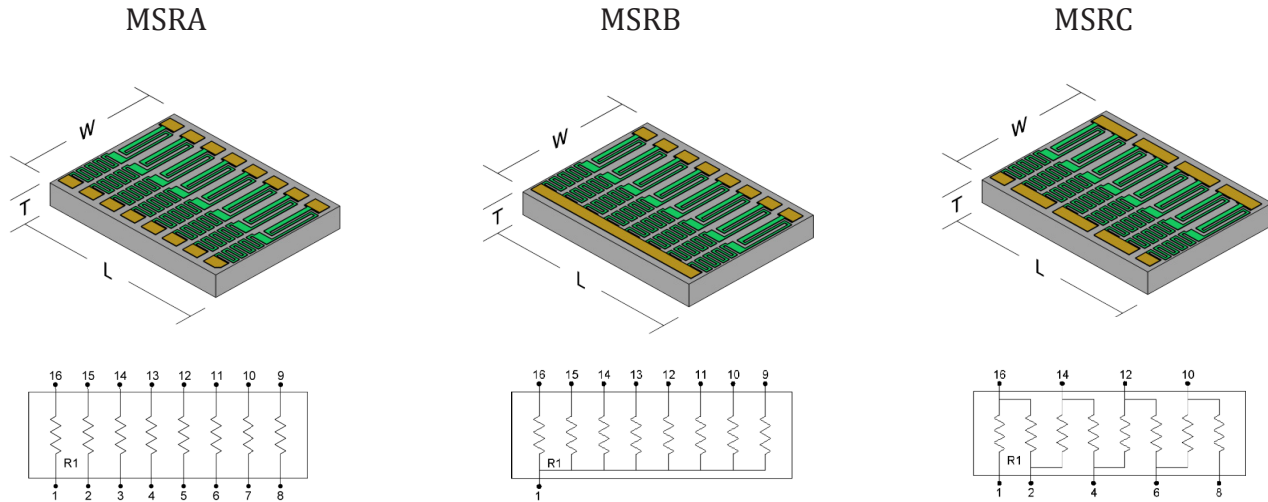

Mini-Systems, Inc. **Resistor Arrays** are ideal for the hybrid designer seeking a SIP or DIP configuration in chip form. This series has three configurations, MSRA - **isolated**, MSRB - **common bussed**, and MSRC - **series array**. Arrays are offered in 3 to 12 resistor combinations. All resistors are the same value and tolerance. They feature excellent resistance ratio tracking, **low T.C.R.**, and **T.C. tracking**, and are of optimum use when space is a premium. Custom configurations available upon request.

DIMENSIONS

# Resistors	Dimensions									
	3	4	5	6	7	8	9	10	11	12
L (±0.003") [±0.076mm]	0.040" [1.016]	0.050" [1.270]	0.060" [1.524]	0.070" [1.778]	0.080" [2.032]	0.090" [2.286]	0.100" [2.54]	0.110" [2.794]	0.120" [3.048]	0.130" [3.302]
W (±0.003") [±0.076mm]	0.060" [1.524]	0.060" [1.524]	0.060" [1.524]	0.060" [1.524]	0.060" [1.524]	0.060" [1.524]	0.060" [1.524]	0.060" [1.524]	0.060" [1.524]	0.060" [1.524]
T (±0.002") [±0.051mm]	0.010" [0.254]	0.010" [0.254]	0.010" [0.254]	0.010" [0.254]	0.010" [0.254]	0.010" [0.254]	0.010" [0.254]	0.010" [0.254]	0.010" [0.254]	0.010" [0.254]

PART NUMBER DESIGNATION

MSRA	8	S	N	10001	F	RA	AE
STYLE	# Res	SUBSTRATE	RESISTOR FILM	OHMIC VALUE	TOLERANCE	RATIO	OPTION
MSRA	3-12	A = Alumina S = Silicon	T = Tantalum Nitride N = NiChrome	5-Digit Number: 1st 4 digits are significant with "R" as decimal point when required. 5th digit represents number of zeros.	S = ±0.01% Q = ±0.05% B = ±0.1% D = ±0.5% F = ±1% G = ±2% J = ±5% K = ±10%	RA = ±0.01% RB = ±0.05% RC = ±0.10% RE = ±0.25% RD = ±0.50% RF = ±1% RN = No Ratio	D = ±5ppm/°C C = ±10ppm/°C B = ±25ppm/°C A = ±50ppm/°C F = ±100ppm/°C E = Aluminum Pads G = Gold Bond Pads GB = Gold Back

EXAMPLE: MSRA-8-SN-10001F-RA-AE
MSRA Style - 8 Resistors, Silicon, NiChrome Resistor Element 10kΩ each resistor,
±1% Tol., ±0.01% Ratio, Aluminum Bond Pads



THIN FILM DIVISION
ISO 9001 CERTIFIED
20 DAVID ROAD
NORTH ATTLEBORO, MA 02760
EMAIL: msithin@Mini-SystemsInc.com
WEB: www.Mini-SystemsInc.com
PHONE: 508-695-0203 FAX: 508-695-6076



THIN FILM RESISTOR ARRAYS

GENERAL CHARACTERISTICS

Resistance Range	5Ω to 1MΩ
Resistance Tolerance	±0.01% to ±10%
Ratio Tolerance	Available to ±0.01%
Termination Material	Gold (Standard) Aluminum (Optional)
Termination Size	0.0035" Square Min. - Value Dependent
Backing Material	Bare Substrate (Standard) Gold (Optional)
Operating Temperature	-55°C to +150°C
Storage Temperature	-65°C to +150°C
Insulation Resistance	10 ¹² Ω Min.
Dielectric Breakdown	400V Min.
Operating Frequency	DC to 500MHz
Operating Voltage	100 V

SUBSTRATE CHARACTERISTICS

SUBSTRATE MATERIAL	Resistance Range (Per Resistor)	Power ¹ Rating	Dielectric Constant @ 1MHz	Thermal Conductivity W/m•K	Current Noise	
					101Ω to 250kΩ	≤ 100Ω > 250kΩ
99.6% Alumina	5Ω to 100kΩ	50 mW / Res	9.9	28	-35 dB	-30 dB
Silicon (with 12kÅ SiO ₂)	5Ω to 1MΩ	50 mW / Res	N/A (SiO ₂ 3.9)	149 (SiO ₂ 1.38)	-40 dB	-30 dB

¹ Power Rating at 70°C Derated Linearly to 0% at 150°C

RESISTOR CHARACTERISTICS

RESISTOR FILM	Passivation	Standard TCR	TCR Optional To	TCR Tracking
Tantalum Nitride	Ta ₂ O ₅ (Self Passivating)	±150 ppm/°C	±10 ppm/°C	±2ppm/°C
NiChrome	SiO ₂	±25 ppm/°C	±5 ppm/°C	±2ppm/°C

PERFORMANCE SPECIFICATIONS

PROPERTY	TEST CONDITION	REQUIRED LIMITS	MSI TYPICAL LIMITS
SHORT TERM OVERLOAD	2.5xWVDC(6.25xRATED POWER)MIL-PRF-55342, +25°C, 5 SEC	±0.25 MAX ΔR/R	±0.10 MAX ΔR/R
HIGH TEMP EXPOSURE	+150°C, 100HRS	±0.20 MAX ΔR/R	±0.03 MAX ΔR/R
THERMAL SHOCK	MIL-STD 202, METHOD 107	±0.25 MAX ΔR/R	±0.10 MAX ΔR/R
MOISTURE RESISTANCE	MIL-STD 202, METHOD 106	±0.40 MAX ΔR/R	±0.10 MAX ΔR/R
STABILITY	MIL-STD 202 METHOD 108, 2000 HRS, +70°C, RATED POWER	±0.50 MAX ΔR/R	±0.10 MAX ΔR/R

All MSRA, MSRB, MSRC Series parts are produced on the same manufacturing line using the same materials and processes as parts manufactured to MIL-PRF-55342

8041 Rev. A



THIN FILM DIVISION
ISO 9001 CERTIFIED
20 DAVID ROAD
NORTH ATTLEBORO, MA 02760
EMAIL: msithin@Mini-SystemsInc.com
WEB: www.Mini-SystemsInc.com
PHONE: 508-695-0203 FAX:508-695-6076



MULTI-TAP RESISTORS

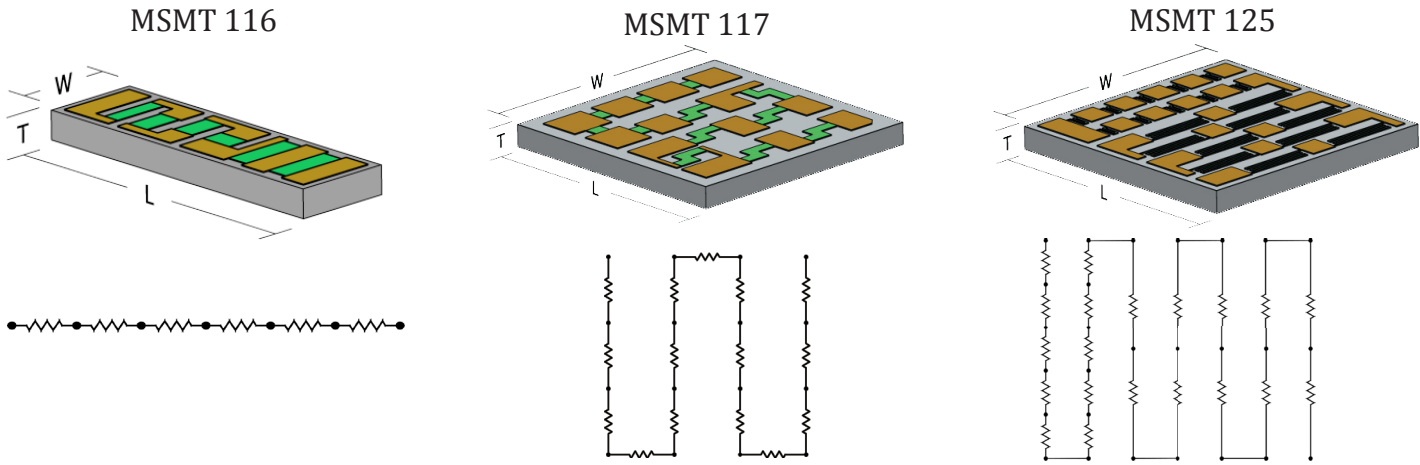

Mini-Systems, Inc. **MSMT** series chip Multi-Tap resistor arrays provide the design engineer a wide range of resistance values on a single chip. These chips are often used in circuits where **precision adjustments** are required. Connection to associated circuitry is accomplished using wire bonding. The MSMT series offers **high stability, low noise, and low T.C.R.** of Mini-Systems, Inc. proven thin film technology.

RESISTANCE DISTRIBUTION

MSMT116*	(R1 = R2 = Rt / 24), (R3 = Rt / 12), (R4 = R5 = Rt / 4.8), (R6 = Rt / 2.4)
MSMT117*	(R1 to R7 = Rt / 8), (R8 to R12 = Rt / 40)
MSMT125*	(R1 to R10 = Rt / 110), (R11 to R20 = Rt / 11)

Rt = Total Resistance

*= Individual values are by design

DIMENSIONS

CASE SIZE	STYLE	TYPE	DIMENSIONS			RESISTANCE RANGE ²		POWER RATING ¹
			L (±0.003") [±0.076mm]	W (±0.003") [±0.076mm]	T (±0.002") [±0.051mm]	Silicon	Alumina	
0602	MSMT	116	0.057" [1.448]	0.017" [0.432]	0.010" [0.254]	80Ω to 2kΩ	80Ω to 2kΩ	125mW
0303	MSMT	117	0.030" [0.762]	0.030" [0.762]	0.010" [0.254]	80Ω to 240kΩ	80Ω to 50kΩ	250mW
0303	MSMT	125	0.034" [0.864]	0.034" [0.864]	0.010" [0.254]	550Ω to 500kΩ	80Ω to 50kΩ	250mW

¹ Power Rating at 70°C Derated Linearly to 0% at 150°C

² Total Resistance

PART NUMBER DESIGNATION

MSMT	—	125	—	S	—	T	—	550R0	—	K	—	G
STYLE		TYPE		SUBSTRATE		RESISTOR FILM		OHMIC VALUE		TOLERANCE		OPTION
MSMT		116 117 125		S = Silicon A = Alumina		T = Tantalum Nitride		5-Digit Number: 1st 4 digits are significant with "R" as decimal point when required. 5th digit represents number of zeros.		J = ±5% K = ±10%		G = Gold Bond Pads E = Aluminum Pads GB = Gold Backside

EXAMPLE: MSMT-125-ST-550R0K-G

MSMT-125 Series, Silicon, Tantalum Nitride, 550Ω, ±10% Tol., Gold Bond Pads, Bare Backside



THIN FILM DIVISION

ISO 9001 CERTIFIED

20 DAVID ROAD

NORTH ATTLEBORO, MA 02760

EMAIL: msithin@Mini-SystemsInc.com

WEB: www.Mini-SystemsInc.com

PHONE: 508-695-0203 FAX: 508-695-6076



MULTI-TAP RESISTORS

GENERAL CHARACTERISTICS

Tolerance	±5% or ±10% (Applies to Total Resistance)
Current Noise	-30dB Max.
Voltage Rating	100V
Bond Pads	Gold (Standard), Aluminum (Optional)
Backside	Bare Substrate (Standard) Gold Back (Optional)
Operating Temperature	-55°C to +150°C
Storage Temperature	-65°C to +150°C

SUBSTRATE CHARACTERISTICS

SUBSTRATE MATERIAL	Dielectric Constant @ 1MHz	Thermal Conductivity W/m•K
99.6% Alumina	9.9	28
Silicon (with 12kÅ SiO ₂)	N/A (SiO ₂ 3.9)	149 (SiO ₂ 1.38)

RESISTOR CHARACTERISTICS

RESISTOR FILM	Passivation	TCR
Tantalum Nitride	Ta ₂ O ₅ (Self Passivating)	±150 ppm/°C

PERFORMANCE SPECIFICATIONS

PROPERTY	TEST CONDITION	REQUIRED LIMITS	MSI TYPICAL LIMITS
SHORT TERM OVERLOAD	2.5xWVDC(6.25xRATED POWER)MIL-PRF-55342, +25°C, 5 SEC	±0.25 MAX ΔR/R	±0.10 MAX ΔR/R
HIGH TEMP EXPOSURE	+150°C, 100HRS	±0.20 MAX ΔR/R	±0.03 MAX ΔR/R
THERMAL SHOCK	MIL-STD 202, METHOD 107	±0.25 MAX ΔR/R	±0.10 MAX ΔR/R
MOISTURE RESISTANCE	MIL-STD 202, METHOD 106	±0.40 MAX ΔR/R	±0.10 MAX ΔR/R
STABILITY	MIL-STD 202 METHOD 108, 2000 HRS, +70°C, RATED POWER	±0.50 MAX ΔR/R	±0.10 MAX ΔR/R

All MSMT Series parts are produced on the same manufacturing line using the same materials and processes as parts manufactured to MIL-PRF-55342

MINI-SMT™ SURFACE MOUNT RESISTORS

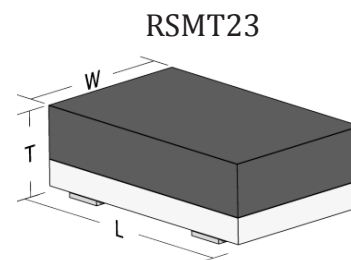
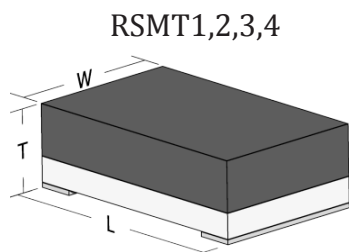

Terminations are palladium silver or pre-tinned with solder

Mini-Systems, Inc. **MINI-SMT™** surface mount thin film resistors are designed to extend the range of standard surface mount thin film resistors well into the **mega-ohm range**. They offer maximum benefits in ohmic value ranges from 5Ω through 10MΩ. T.C.R.'s to **±5ppm/°C** - and absolute tolerances to **±0.05%**. Available in 0505, 0603, 0805 and 1206 case sizes, these resistors provide Mini-Systems, Inc. proven thin film performance in a surface mount solderable style.

GENERAL CHARACTERISTICS

Resistance Tolerance	±0.5% to ±10%	
Termination Material	Palladium/Silver, or Pre-Tinned with Solder	
Resistor Film	Tantalum Nitride	NiChrome
TCR	±150ppm/°C (Standard)	±5ppm/°C to ±100ppm/°C
Substrate	Alumina	
Voltage Rating	100 V	
Current Noise	1Ω to 250kΩ	-40dB
	≤ 100Ω > 250kΩ	-30dB
Operating Temperature	-55°C to +150°C	
Storage Temperature	-65°C to +150°C	
Insulation Resistance	10 ¹² Ω Min.	
Dielectric Breakdown	400V Min.	

¹ Power Rating at 70°C Derated Linearly to 0% at 150°C

PART NUMBER DESIGNATION

RSMT	1	A	P	50003	G	CT
STYLE	TYPE	SUBSTRATE	RESISTOR FILM	OHMIC VALUE	TOLERANCE	OPTION
RSMT	See Table	A = Alumina	NiCr or TaN Dependant upon TCR requirements	5-Digit Number: 1st 4 digits are significant with "R" as decimal point when required. 5th digit represents number of zeros.	D = ±0.5% F = ±1% G = ±2% J = ±5% K = ±10%	D = ±5ppm/°C C = ±10ppm/°C B = ±25ppm/°C A = ±50ppm/°C F = ±100ppm/°C U = Pd/Ag Untinned T = Pd/Ag w/ Sn62 Solder T3 = Pd/Ag w/ SAC305 Solder TR = Tape & Reel

EXAMPLE: RSMT-1 AP-50003G-CT
0505, 5MΩ, ±2% Tol., 10ppm/°C with Solder Termination



THIN FILM DIVISION

ISO 9001 CERTIFIED
20 DAVID ROAD
NORTH ATTLEBORO, MA 02760

EMAIL: msithin@Mini-SystemsInc.com
WEB: www.Mini-SystemsInc.com
PHONE: 508-695-0203 FAX:508-695-6076



MINI-SMT™ SURFACE MOUNT RESISTORS

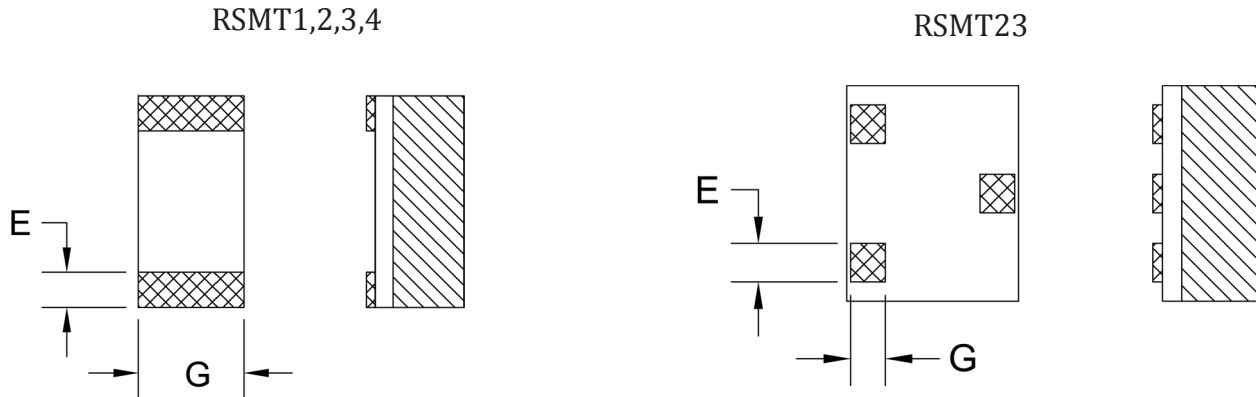

DIMENSIONS

CASE SIZE	STYLE RSMT	CHIP DIMENSIONS			BOND PAD DIMENSIONS			RESISTANCE RANGE	POWER RATING
		L (±0.005") [±0.127mm]	W (±0.005") [±0.127mm]	T ¹ Max	# Pads	E (±0.005") [±0.127mm]	G (±0.005") [±0.127mm]		
0505	1	0.050" [1.270]	0.050" [1.270]	0.050" [1.270]	2	0.015" [0.381]	0.050" [1.270]	5Ω - 2.5MΩ	250mW
0603	4	0.060" [1.524]	0.030" [0.762]	0.050" [1.270]	2	0.010" [0.254]	0.030" [0.762]	5Ω - 2MΩ	125mW
0805	3	0.080" [2.032]	0.050" [1.270]	0.050" [1.270]	2	0.015" [0.381]	0.050" [1.270]	5Ω - 7.5MΩ	350mW
1206	2	0.120" [3.048]	0.060" [1.524]	0.050" [1.270]	2	0.020" [0.508]	0.060" [1.524]	5Ω - 7.5MΩ	350mW
1109	23 (dual)	0.112" [2.845]	0.090" [2.286]	0.050" [1.270]	3	0.018" [0.457]	0.020" [0.508]	5Ω - 5MΩ/Resistor	125mW/Resistor

¹ Thickness does not include solder

PERFORMANCE SPECIFICATIONS

PROPERTY	TEST CONDITION	REQUIRED LIMITS	MSI TYPICAL LIMITS
SHORT TERM OVERLOAD	2.5xWVDC(6.25xRATED POWER)MIL-PRF-55342, +25°C, 5 SEC	±0.25 MAX ΔR/R	±0.10 MAX ΔR/R
HIGH TEMP EXPOSURE	+150°C, 100HRS	±0.20 MAX ΔR/R	±0.03 MAX ΔR/R
THERMAL SHOCK	MIL-STD 202, METHOD 107	±0.25 MAX ΔR/R	±0.10 MAX ΔR/R
MOISTURE RESISTANCE	MIL-STD 202, METHOD 106	±0.40 MAX ΔR/R	±0.10 MAX ΔR/R
STABILITY	MIL-STD 202 METHOD 108, 2000 HRS, +70°C, RATED POWER	±0.50 MAX ΔR/R	±0.10 MAX ΔR/R

8041 Rev. A



THIN FILM DIVISION
 ISO 9001 CERTIFIED
 20 DAVID ROAD
 NORTH ATTLEBORO, MA 02760
 EMAIL: msithin@Mini-SystemsInc.com
 WEB: www.Mini-SystemsInc.com
 PHONE: 508-695-0203 FAX:508-695-6076



SURFACE MOUNT RESISTOR NETWORKS

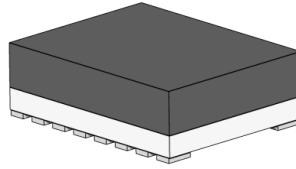

Mini-Systems, Inc. **RSMA** Style mini-surface mount thin film resistor networks feature a **smaller footprint** than QSOP packages. This series is offered in a 0.025" and 0.050" lead pitch. They provide **high stability, low noise, tight tolerance, and ratio tracking**, low TCR and TC tracking of Mini-Systems, Inc. proven thin film process. Combining resistors maximizes on available space and reduces the number of connections. They are available in 8, 14 and 16 lead configurations.

MECHANICAL DATA

Package Style	SMT, Epoxy Coated
Package Configuration	8, 14 or 16 Leads
Lead Pitch	0.025" (RSMA25) 0.050" (RSMA50)
Lead Material	Palladium Silver (Standard) - Solder Tinned (Optional)

GENERAL CHARACTERISTICS

TCR	Standard	Available To
		±150ppm/°C
Power Rating ¹	50 mW/Resistor	
Voltage Rating	100 V	
Resistance Range	5Ω to 1MΩ	
Resistance Tolerance	±0.5% to ±10%	
Current Noise	<-30dB Typical	
Storage Temperature	-65°C to +150°C	
Operating Temperature	-55°C to +150°C	
Insulation Resistance	10 ¹² Ω Min.	

¹ Power Rating at 70°C Derated Linearly to 0% at 150°C

PART NUMBER DESIGNATION

RSMA50	16	SA	10002	F	AU
STYLE	# LEADS	SCHEMATIC	OHMIC VALUE	TOLERANCE	OPTION
See Table	See Table	SA = Isolated SB = Common SC = Series SD = Divider	1st 4 digits are significant with "R" as decimal point when required. 5th digit represents number of zeros.	D = ±0.5% F = ±1% G = ±2% J = ±5% K = ±10%	D = ±5ppm/°C C = ±10ppm/°C B = ±25ppm/°C A = ±50ppm/°C F = ±100ppm/°C U = Pd/Ag Untinned T = Pd/Ag w/ Sn62 Solder T3 = Pd/Ag w/ SAC305 Solder TR = Tape & Reel

EXAMPLE: RSMA50-16SA-10002F-AU
16 Lead Pkg., 8 - 100kΩ Resistors, Isolated Connections, ±1% Tol., ±50ppm/°C, Pd/Ag Untinned

Custom Networks and Resistor Combinations Available Consult Sales



THIN FILM DIVISION
ISO 9001 CERTIFIED
20 DAVID ROAD
NORTH ATTLEBORO, MA 02760
EMAIL: msithin@Mini-SystemsInc.com
WEB: www.Mini-SystemsInc.com
PHONE: 508-695-0203 FAX:508-695-6076



SURFACE MOUNT RESISTOR NETWORKS

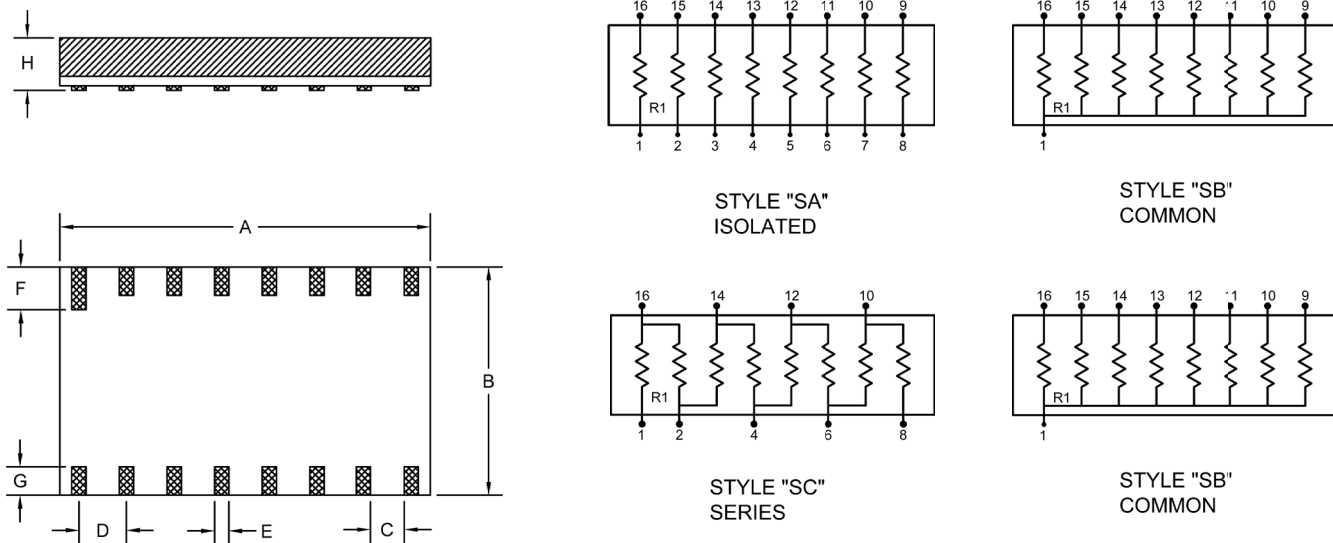

RSMA 25

CASE SIZE	LEADS	Dimensions							
		A (±0.005") [±0.127mm]	B (±0.005") [±0.127mm]	C	D	E (±0.002") [±0.050mm]	F	G	H (±0.005") [±0.127mm]
1515	8	0.150" [3.810]	0.150" [3.810]	0.010" [0.254]	0.025" [0.635]	0.015" [0.381]	0.045" [1.143]	0.025" [0.635]	0.050" [1.270]
1518	14	0.175" [4.445]	0.150" [3.810]	0.010" [0.254]	0.025" [0.635]	0.015" [0.381]	0.045" [1.143]	0.025" [0.635]	0.050" [1.270]
1520	16	0.200" [5.080]	0.150" [3.810]	0.010" [0.254]	0.025" [0.635]	0.015" [0.381]	0.045" [1.143]	0.025" [0.635]	0.050" [1.270]

RSMA 50

CASE SIZE	LEADS	Dimensions							
		A (±0.005") [±0.127mm]	B (±0.005") [±0.127mm]	C	D	E (±0.002") [±0.050mm]	F	G	H (±0.005") [±0.127mm]
2419	8	0.190" [4.826]	0.240" [6.096]	0.035" [0.889]	0.050" [1.270]	0.015" [0.381]	0.045" [1.143]	0.030" [0.762]	0.050" [1.270]
2434	14	0.340" [8.636]	0.240" [6.096]	0.035" [0.889]	0.050" [1.270]	0.015" [0.381]	0.045" [1.143]	0.030" [0.762]	0.050" [1.270]
2439	16	0.390" [9.906]	0.240" [6.096]	0.035" [0.889]	0.050" [1.270]	0.015" [0.381]	0.045" [1.143]	0.030" [0.762]	0.050" [1.270]

PERFORMANCE SPECIFICATIONS

PROPERTY	TEST CONDITION	REQUIRED LIMITS	MSI TYPICAL LIMITS
SHORT TERM OVERLOAD	2.5xWVDC(6.25xRATED POWER)MIL-PRF-55342, +25°C, 5 SEC	±0.25 MAX ΔR/R	±0.10 MAX ΔR/R
HIGH TEMP EXPOSURE	+150°C, 100HRS	±0.20 MAX ΔR/R	±0.03 MAX ΔR/R
THERMAL SHOCK	MIL-STD 202, METHOD 107	±0.25 MAX ΔR/R	±0.10 MAX ΔR/R
MOISTURE RESISTANCE	MIL-STD 202, METHOD 106	±0.40 MAX ΔR/R	±0.10 MAX ΔR/R
STABILITY	MIL-STD 202 METHOD 108, 2000 HRS, +70°C, RATED POWER	±0.50 MAX ΔR/R	±0.10 MAX ΔR/R

80/41 Rev. A



THIN FILM DIVISION

ISO 9001 CERTIFIED
20 DAVID ROAD

NORTH ATTLEBORO, MA 02760

EMAIL: msithin@Mini-SystemsInc.com

WEB: www.Mini-SystemsInc.com

PHONE: 508-695-0203 FAX:508-695-6076



M.O.S. CHIP CAPACITORS

MSBIN SERIES

MSBIN 1, 2

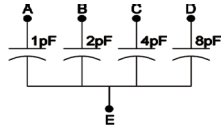
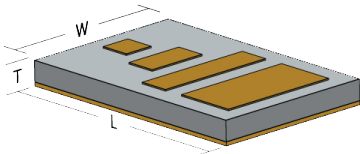

MSBIN 3

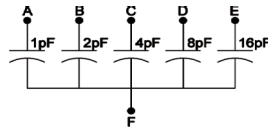
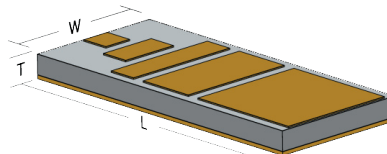

MSBIN 4

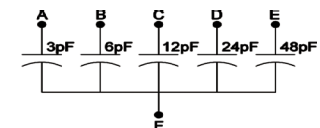
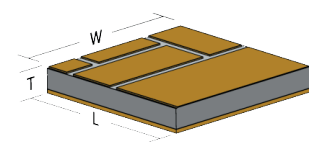

MSCC SERIES

MSCC 2,3,4,15

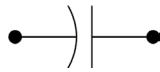
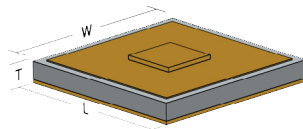

MSCC 5

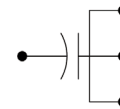
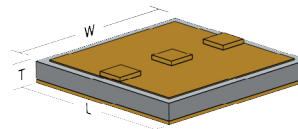

GENERAL CHARACTERISTICS

Substrate	Silicon
Dielectric	Silicon Dioxide
Bond Pad	Gold (Standard), Aluminum (Optional)
Backside	Gold
TCC	+45 ±25ppm/°C
Operating Temperature Range	-55°C to +150°C
Dissipation Factor	1kHz, 1Vrms, 25°C, ≤0.1%
Q-Factor	1MHz, 50Vrms, 25°C, 1000 Min.
Insulation Resistance	≥10 ¹² Ω

PART NUMBER DESIGNATION

MSBIN	1	S	A	3R750	K	G
STYLE	TYPE	SUBSTRATE	DIELECTRIC	CAPACITANCE VALUE	TOLERANCE	OPTION
MSCC	See Table	S = Silicon	A = SiO ₂	5-Digit Number: 1st 4 digits are significant with "R" as decimal point when required. 5th digit represents number of zeros.	A = ±0.5pF* H = ±2.5% J = ±5% K = ±10% M = ±20% P = ±25%	E = Aluminum Pads G = Gold Bond Pads Std
MSBIN				For MSBIN Series 3R750 = 3.75pF MSBIN1 15R00 = 15pF MSBIN2 31R00 = 31pF MSBIN3 93R00 = 93pF MSBIN4	* Use for MSCC-2 4.7pF to 10pF or 2.3pF to 10pF for MSCC-15	

EXAMPLE: MSBIN-1SA-3R750K-G
MSBIN-1 Series, Silicon, SiO₂, 3.75pF Total Capacitance, ±10% Tol., Gold Bond Pads



THIN FILM DIVISION

ISO 9001 CERTIFIED
20 DAVID ROAD
NORTH ATTLEBORO, MA 02760
EMAIL: msithin@Mini-SystemsInc.com
WEB: www.Mini-SystemsInc.com
PHONE: 508-695-0203 FAX:508-695-6076



M.O.S. CHIP CAPACITORS

MSBIN SERIES

Mini-Systems, Inc. **MSBIN** series thin film binary array chip capacitors are designed to established industry standards. The MSBIN series offer greater flexibility in capacitance value selection for Hybrid and Microwave circuits.

CASE SIZE	STYLE	TYPE	DIMENSIONS			TOTAL CAPACITANCE	INDIVIDUAL VALUES	TOLERANCE	RATED VOLTAGE
			L (±0.002") [±0.051mm]	W (±0.002") [±0.051mm]	T (±0.003") [±0.076mm]				
0203	MSBIN	1	0.019" [0.482]	0.030" [0.762]	0.010" [0.254]	3.75pF	0.25pF, 0.50pF, 1.0pF, 2.0pF	±25%	100VDC
0203	MSBIN	2	0.019" [0.482]	0.030" [0.762]	0.010" [0.254]	15pF	1pF, 2pF, 4pF, 8pF	±10%, ±20%	30VDC
0404	MSBIN	3	0.019" [0.482]	0.048" [1.219]	0.010" [0.254]	31pF	1pF, 2pF, 4pF, 8pF, 16pF	±10%, ±20%	75VDC
0505	MSBIN	4	0.044" [1.117]	0.044" [1.117]	0.010" [0.254]	93pF	3pF, 6pF, 12pF, 24pF, 48pF	±10%, ±20%	93VDC

MSCC SERIES

Mini-Systems, Inc. **MSCC** series MOS thin film chip capacitors are designed to established industry standards. The MSCC series is offered in a variety of sizes for both Hybrid and Microwave circuits. Connection to associated circuitry is completed by wire-bonding to the top and epoxy or eutectic attachment to the back.

CASE SIZE	STYLE	TYPE	DIMENSIONS			CAPACITANCE RANGE	TOLERANCE
			L (±0.002") [±0.051mm]	W (±0.002") [±0.051mm]	T (±0.003") [±0.076mm]		
0101	MSCC	15	0.015" [0.381]	0.015" [0.381]	0.010" [0.254]	2.3pF to 10pF 11pF to 20pF 21pF to 30pF	±0.5pF ±5%, ±10%, ±2.5%, ±5%, ±10%,
0202	MSCC	2	0.020" [0.508]	0.020" [0.508]	0.010" [0.254]	4.7pF to 10pF 11pF to 20pF 21pF to 70pF	±0.5pF ±5%, ±10%, ±2.5%, ±5%, ±10%,
0303	MSCC	3	0.030" [0.762]	0.030" [0.762]	0.010" [0.254]	13pF to 200pF	±2.5%, ±5%, ±10%,
0404	MSCC	4	0.040" [1.016]	0.040" [1.016]	0.010" [0.254]	25pF to 400pF	±2.5%, ±5%, ±10%,
0505	MSCC	5	0.055" [1.397]	0.055" [1.397]	0.010" [0.254]	50pF to 1000pF	±2.5%, ±5%, ±10%,

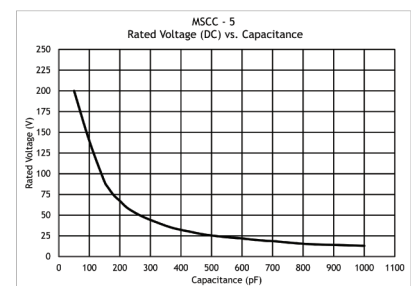
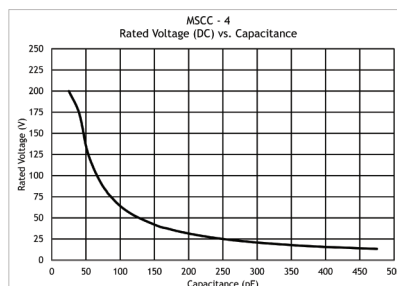
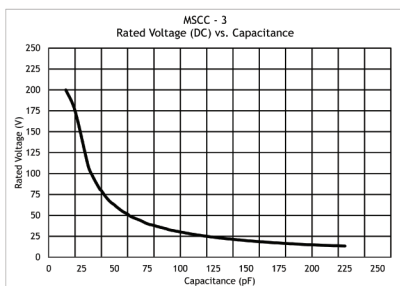
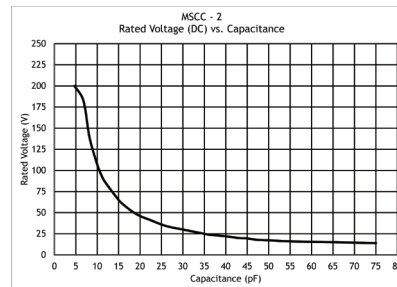
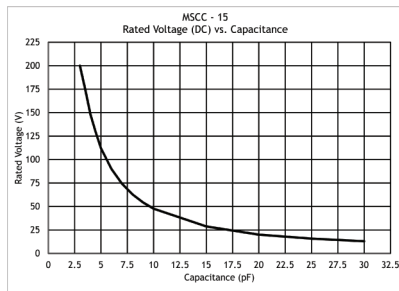

RC NETWORKS

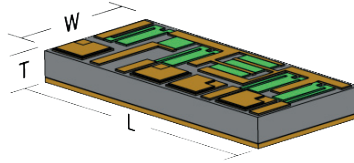

The **MRCN** series offers the **high stability, low noise, and low T.C.R./T.C.C. tracking** of thin film resistors combined with MOS capacitors. Designed to your specifications, this series provides the flexibility needed for your custom applications

GENERAL CHARACTERISTICS

Termination Material	Gold (Standard) Aluminum (Optional)
Backing Material	Gold
Substrate Material	Silicon
Operating Temperature	-55°C to +150°C
Storage Temperature	-65°C to +150°C
Insulation Resistance	10 ¹² Ω Min.
Dielectric Breakdown	400V Min.
Operating Frequency	DC to 500MHz

RESISTOR CHARACTERISTICS

Resistance Range	1Ω to 5MΩ
Resistance Tolerance	±0.1% to ±10%
Resistor	Tantalum Nitride
Passivation	Ta ₂ O ₅ (Self Passivating)
T.C.R	±150 ppm/°C
T.C.R Tracking	±2 ppm/°C

CAPACITOR CHARACTERISTICS

Capacitance Range	2.3pF to 1500pF
Capacitance Tolerance	±5% to ±20%
Dielectric	SiO ₂
Dielectric Constant @ 1MHz	3.9
T.C.C	+45 ±25 ppm/°C
Insulation Resistance (@ Working Voltage)	10 ⁹ Ω
Dissipation Factor (1kHz, 1Vrms, 25 °C)	0.1%
Q Factor (1MHz, 50Vrms, 25 °C)	1000 Min

SUBSTRATE CHARACTERISTICS

SUBSTRATE MATERIAL	Available Thickness	Dielectric Constant @ 1MHz	Thermal Conductivity W/m• K	Current Noise	
				101Ω to 250kΩ	≤ 100Ω > 250kΩ
Silicon (with 12kÅ SiO ₂)	0.005" - 0.015"	N/A (SiO ₂ 3.9)	149 (SiO ₂ 1.38)	-40 dB	-30 dB

PERFORMANCE SPECIFICATIONS

PROPERTY	COMPONENT	TEST CONDITION	REQUIRED LIMITS	MSI TYPICAL LIMITS
SHORT TERM OVERLOAD	RESISTOR	2.5xWVDC (6.25xRATED POWER)MIL-PRF-55342, +25°C, 5 SEC	±0.25 MAX ΔR/R	±0.10 MAX ΔR/R
	CAPACITOR	1.5X WORKING VOLTAGE, 5 SEC	±0.5pF or 1% OF ΔC MAX	±0.10pF
HIGH TEMP EXPOSURE	RESISTOR	+150°C, 100HRS	±0.20 MAX ΔR/R	±0.03 MAX ΔR/R
	CAPACITOR	+150°C, 100HRS	±0.5pF or 1% of ΔC MAX	±0.05pF
THERMAL SHOCK	RESISTOR	MIL-STD 202, METHOD 107	±0.25 MAX ΔR/R	±0.10 MAX ΔR/R
	CAPACITOR	MIL-STD 202, METHOD 107	±0.5pF MAX	±0.1pF
MOISTURE RESISTANCE	RESISTOR	MIL-STD 202, METHOD 106	±0.40 MAX ΔR/R	±0.10 MAX ΔR/R
	CAPACITOR	MIL-STD 202, METHOD 106	±1pF or 2% of ΔC MAX	-----
STABILITY	RESISTOR	1000 HRS, +70°C, @ RATED POWER	±0.50 MAX ΔR/R	±0.10 MAX ΔR/R
	CAPACITOR	1000 HRS, +70°C, @ WORKING VOLTAGE	±2.5pF or 2.5% MAX	-----



MINI SYSTEMS INC.
MADE IN AMERICA
SINCE 1968

THIN FILM DIVISION

ISO 9001 CERTIFIED
20 DAVID ROAD

NORTH ATTLEBORO, MA 02760

EMAIL: msithin@Mini-SystemsInc.com

WEB: www.Mini-SystemsInc.com

PHONE: 508-695-0203 FAX:508-695-6076



8041 Rev. A

CUSTOM PATTERNED SUBSTRATES

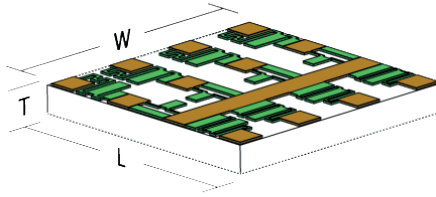

Advanced manufacturing methods insure superior sheet rho uniformity, metallization adhesion and thickness control. Our manufacturing capabilities allow us to meet and exceed your most demanding custom requirements.

GENERAL CHARACTERISTICS

Resistance Tolerance	±0.01% to ±10%
Resistance Ratio	±0.01% Available
T.C.R. Tracking	To ±2 ppm/°C
Termination Material	Gold, Aluminum
Size	Up to 4"x 4"
Line Width Definition Resistor	Resistor Patterning to 0.1 mils
Line Width Definition (Cond.)	0.2 mils
Metals Available	NiChrome, Tantalum, SiChrome, Palladium, TiTungsten, Gold, Nickel, Aluminum
Specialty Materials	Metalization available on 1-6 sides. Through-Holes, Edge Wraps and Custom Laser Cutouts

SUBSTRATE CHARACTERISTICS

SUBSTRATE MATERIAL	Available Thickness	Dielectric Constant @ 1MHz	Thermal Conductivity W/m•K	Current Noise	
				101Ω to 250kΩ	≤ 100Ω > 250kΩ
99.6% Alumina	0.005" - 0.025"	9.9	28	-35 dB	-30 dB
Silicon (with 12kÅ SiO ₂)	0.005" - 0.015"	N/A (SiO ₂ 3.9)	149 (SiO ₂ 1.38)	-40 dB	-30 dB
Quartz	0.005" - 0.010"	3.75	1.3	-40 dB	-30 dB
Beryllium Oxide	0.010" - 0.025"	6.7	300	-35 dB	-30 dB
Aluminum Nitride	0.010" - 0.025"	9.0	140 - 177	-35 dB	-30 dB

RESISTOR CHARACTERISTICS

RESISTOR FILM	Sheet Rho	Passivation	Standard TCR	TCR Optional To
Tantalum Nitride	5Ω/sq. to 250Ω/sq.	Ta ₂ O ₅ (Self Passivating)	±150 ppm/°C	±10 ppm/°C
NiChrome	5Ω/sq. to 200Ω/sq.	SiO ₂ or Si ₃ N ₄	±25 ppm/°C	±5 ppm/°C
SiChrome	500Ω/sq. to 2.5kΩ/sq.	SiO ₂ or Si ₃ N ₄	±150 ppm/°C	±100 ppm/°C

8041 Rev. A



THIN FILM DIVISION

ISO 9001 CERTIFIED
20 DAVID ROAD

NORTH ATTLEBORO, MA 02760

EMAIL: msithin@Mini-SystemsInc.com

WEB: www.Mini-SystemsInc.com

PHONE: 508-695-0203 FAX:508-695-6076



AVAILABLE TESTING

TEST	MILITARY STANDARD	NOTES
Group A		
Thermal Shock	MIL-PRF-55342, MIL-STD-202, Method 107	-65°C to +150°C, 5 Cycles, 100%
Element Electrical	MIL-PRF-55342, MIL-STD-202, Method 303	100%
Visual Inspection	MIL-PRF-55342	30X-60X Magnification
Solderability	MIL-PRF-55342, MIL-STD-202, Method 208	95% Coverage After 8 Hours Steam Aging
Resistance to Solvents	MIL-PRF-55342, MIL-STD-202, Method 215	Parts with Color Coded Dots Only
Power Conditioning (Space Level Only)	MIL-PRF-55342, MIL-STD-202, Method 108	100 Hours, 70°C, 1.5X Rated Power, 100%

Group B		
Resistance Temperature Characteristics	MIL-PRF-55342, MIL-STD-202, Method 304	-55°C, +25°C, +125°C
Short Time Overload	MIL-PRF-55342	5 Sec., 2.5X WVDC, 6.25X Power Rating
Solder Mounting Integrity	MIL-PRF-55342	Soldered Parts
Bondable Mounting Integrity	MIL-PRF-55342	Epoxy Bondable Parts
Wire Bonding Integrity	MIL-PRF-55342	Wire Bondable Parts

Group C		
Life Test	MIL-PRF-55342, MIL-STD-202, Method 108	2,000 Hours, 70°C, Rated Power
Thermal Shock	MIL-PRF-55342, MIL-STD-202, Method 107	-65°C to +150°C, 5 Cycles, Sample
Low Temperature Operation	MIL-PRF-55342	45 Minutes, -65°C, Rated Power
Resistance to Soldering Heat	MIL-PRF-55342, MIL-STD-202, Method 210	Soldered Parts
Resistance to Bonding Exposure	MIL-PRF-55342	Wire and Epoxy Bondable Parts
Moisture Resistance	MIL-PRF-55342, MIL-STD-202, Method 106	Unpowered
High Temperature Exposure	MIL-PRF-55342	100 Hours, 150°C

Class H & K		
Element Electrical	MIL-PRF-38534	Per acquisition document
Visual Inspection	MIL-STD-883, Method 2032, Class H & K	Class H: Sample Class K: 100%
Wire Bond Evaluation	MIL-STD-883, Method 2011	Wire Bondable Parts

Class K		
Temperature Cycling	MIL-STD-883, Method 1010	-65°C to +150°C, 10 Cycles, Sample
Constant Acceleration	MIL-STD-883, Method 2001, Condition B	10,000g
Voltage Conditioning or Aging	MIL-PRF-55342	100 Hours, 70°C, Rated Power
DC Leakage (Capacitors)	Not Applicable	<5 x 10 ⁻⁹ Amps at Working Voltage
Dielectric Withstanding Voltage (Capacitors)	MIL-STD-202, Method 301	1.5X Working Voltage, 5 Sec.
Dissipation Factor (Capacitors)	MIL-STD-202, Method 306	1KHz, 1Vrms, +25°C, ≤0.1%
Salt Atmosphere (Packages)	MIL-STD-883, Method 1009	Off Site Testing

Additional		
Current Noise	MIL-STD-202, Method 308	Requirements per Value and Material
Device Finish	MIL-PRF-38534	Per Acquisition Document
Die Shear	MIL-STD-883, Method 2019	Requirements per Die Size
Insulation Resistance (Capacitors)	MIL-PRF-49464	≤10 ¹² Ω at working voltage
Q- Factor (Capacitors)	MIL-STD-202, Method 306	1MHz, 50Vrms, 25°C, 1000 Min.
SEM Analysis	MIL-STD-883, Method 2018	Off Site Testing
Temperature Coefficient of Capacitance	MIL-PRF-49464	Per Acquisition Document
Visual Inspection	MIL-STD-883, Method 2017	Sample or 100%



THIN FILM DIVISION

ISO 9001 CERTIFIED
 20 DAVID ROAD
 NORTH ATTLEBORO, MA 02760
 EMAIL: msithin@Mini-SystemsInc.com
 WEB: www.Mini-SystemsInc.com
 PHONE: 508-695-0203 FAX:508-695-6076

RESOURCE PAGE

SUBSTRATE AND RESISTOR SELECTION GUIDE

Characteristics	SUBSTRATE					RESISTOR		
	Silicon	Alumina	Quartz	AlN	BeO	NiCr	TaN	SiCr
High Frequency	NR	2	③	2	2	3	③	NR
High Power	1	1	NR	2	③	3	③	NR
Noise	③	2	3	1	1	③	2	1
Low TCR	③	2	3	1	1	③	2	1
Tight Tolerance	③	2	2	1	1	③	3	1
High Resistance	③	1	3	NR	NR	1	2	③
Moisture Resistance	③	3	3	NR	3	1	③	2
Price	3	③	2	1	2	2	③	1

1= Good 2= Better 3= Best ○=Recommended NR=Not Recommended

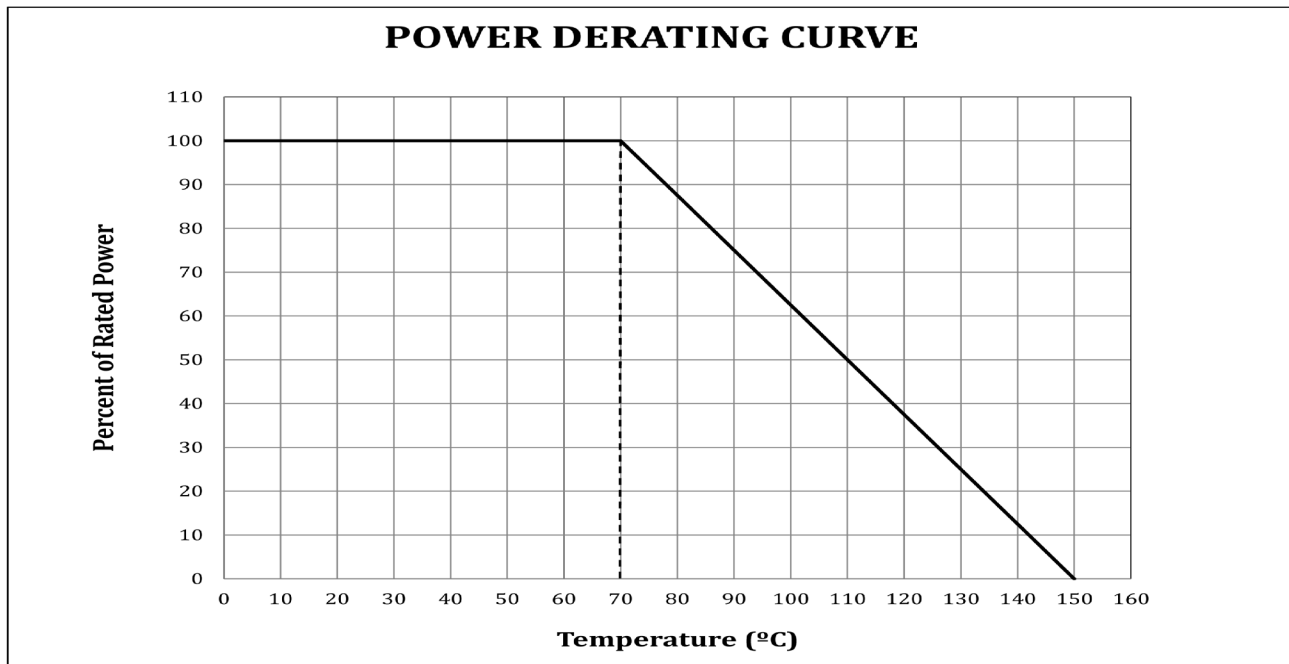

8041 Rev. A



THIN FILM DIVISION
 ISO 9001 CERTIFIED
 20 DAVID ROAD
 NORTH ATTLEBORO, MA 02760
 EMAIL: msithin@Mini-SystemsInc.com
 WEB: www.Mini-SystemsInc.com
 PHONE: 508-695-0203 FAX:508-695-6076

