

# EdrawMax User Guide

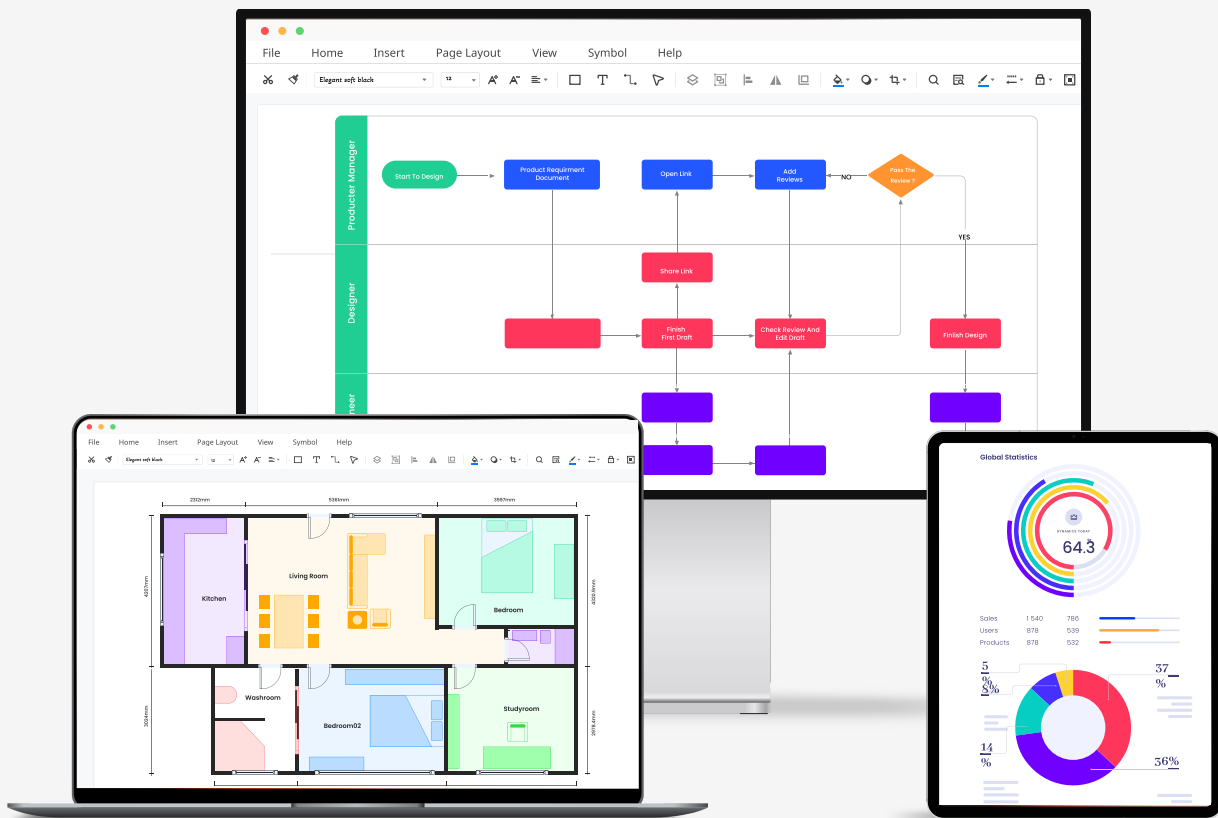

# Content

Chapter 1 Get Started with EdrawMax .....	5
EdrawMax Navigation .....	5
System Requirements .....	7
Download and Install EdrawMax .....	8
Register EdrawMax .....	8
Update EdrawMax .....	10
Activate and Deactivate EdrawMax .....	11
Chapter 2 File .....	14
Create New Diagrams .....	14
Open Files .....	15
Import Files .....	15
Save Files .....	16
File Recovery .....	17
Version History .....	19
Export Files .....	21
Share Files .....	25
Publish Files .....	26
Print Files .....	27
Encrypt Files .....	28
Create Personal Templates .....	29
Chapter 3 Page .....	31
Add Pages .....	31
Delete Pages .....	31
Reorder Pages .....	31
Preview Pages .....	32
Zoom Pages .....	32
Background and Layer .....	33
Page View Options .....	35
Snap and Glue .....	36
Page Layouts .....	38
Focus Mode .....	39
Spelling Check .....	40

Find and Replace .....	41
Capture Screen .....	42
Chapter 4 Presentation .....	43
Create Presentation Slides .....	43
Presentation Mode .....	45
Chapter 5 Symbol .....	46
Select Symbols .....	46
Move Symbols .....	49
Resize Symbols .....	49
Rotate and Flip Symbols .....	50
Connect Symbols .....	51
Replace Symbols .....	55
Protect Symbols .....	55
Reorder Overlapping Symbols .....	57
Align Symbols .....	58
Distribute Symbols .....	58
Group and Ungroup Symbols .....	59
Center Symbols .....	59
Draw Shape Tool .....	59
Path and Anchor Point .....	63
Pencil Tool .....	66
Pen Tool .....	67
Create Your Own Symbols .....	69
Create Your Own Library .....	73
Smart Shape .....	75
Shape Data .....	76
Chapter 6 Format .....	78
Format Symbols .....	78
Format Text .....	78
Format Connectors .....	79
Themes .....	80
Quick Formatting .....	81
Chapter 7 Insert .....	83

---

Insert Tables .....	83
Insert Charts .....	84
Insert Timelines .....	85
Insert Containers .....	87
Insert Pictures .....	88
Insert Formulas .....	89
Insert Hyperlinks .....	89
Insert Attachments .....	90
Insert Notes .....	91
Insert Comments .....	91
Chapter 8 Tips & Tricks .....	92
How to Make a Flowchart .....	92
How to Make a Swimlane Diagram .....	93
How to Make an Organizational Chart .....	95
How to Make a Gantt Chart .....	98
How to Make a Floor Plan .....	104
Keyboard Shortcuts .....	107



# Chapter 1 Get Started with EdrawMax

## EdrawMax Navigation

### The Home Page

When you launch [EdrawMax](#) on your computer, you will be navigated to the Home page. Here you can create and manage documents, search and use templates, import Visio or other files, and modify general options of the software. This page also works as an entrance to the Edraw workspace.

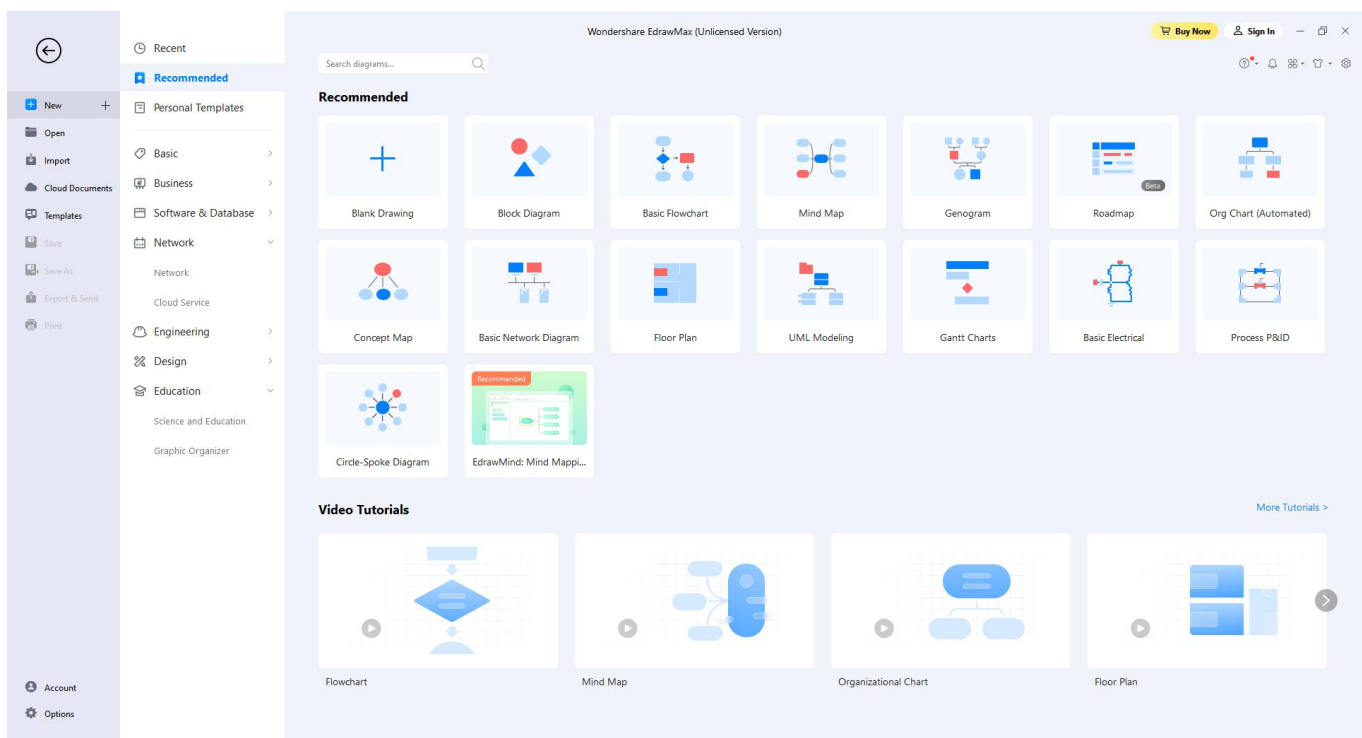

### Workspace

You will see **Quick Access Toolbar**, **Ribbon**, **Canvas**, **Context Pane**, **Symbol Library**, and **Footer** on the workspace. Getting familiar with these functional areas will help you complete your designs more efficiently.

- **Quick Access Toolbar:** One-click access to commonly used commands such as Undo, Redo, Open, Save, Print, and Export. You can also customize this area to fit your preference.

- **Ribbon:** There are main toolbars where all commands and controls are organized in different tabs and groups.
- **Canvas:** It is the heart of the user interface to create your diagrams.
- **Symbol Library:** By default, the symbol library will show the related shapes and symbols when choosing which diagram you would make in EdrawMax.
- **Footer:** You will find the footer underneath the canvas to manage documents' pages, adjust the zoom level and present the canvas in full-screen mode.

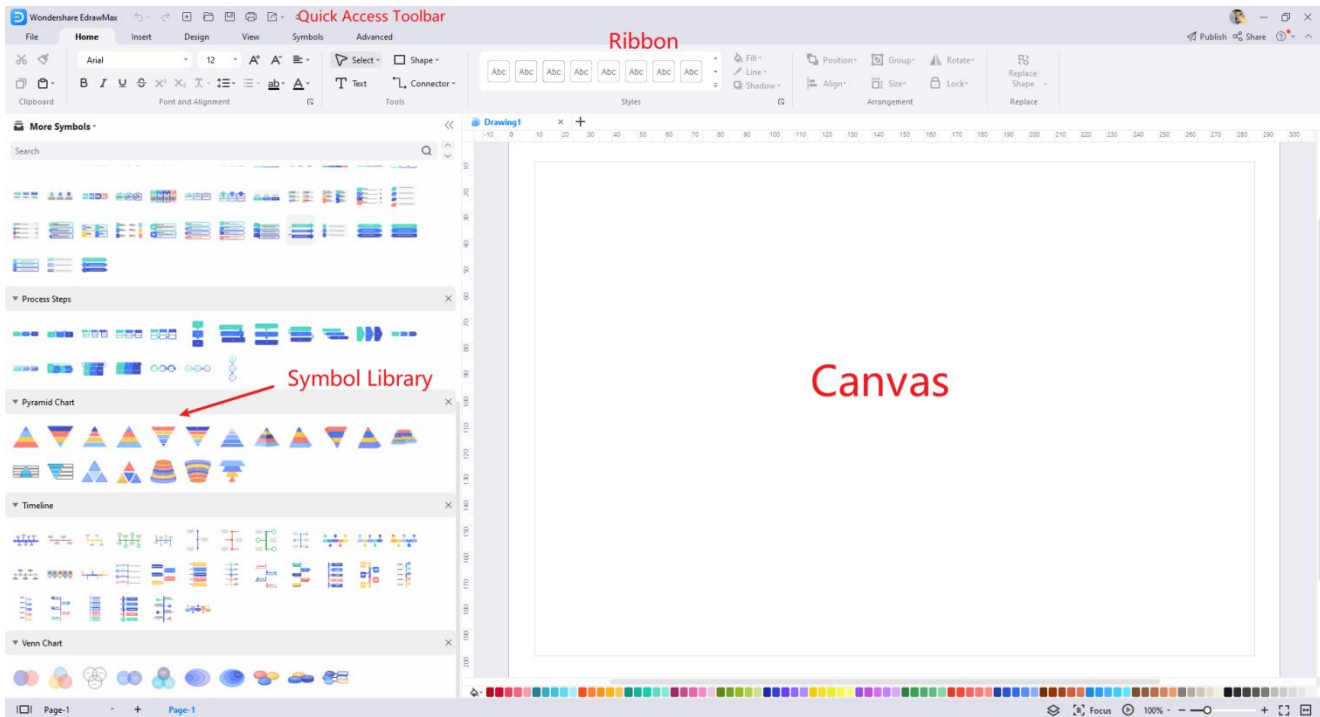

If you want to change the default settings, you can use the self-defined format settings to customize a shape's style. Now you can start diagramming simply and intuitively! Go to the **File** tab, click **Options > Default Setting**, and next, all you need to do is choose your favorite font, connector, theme color, and page size.

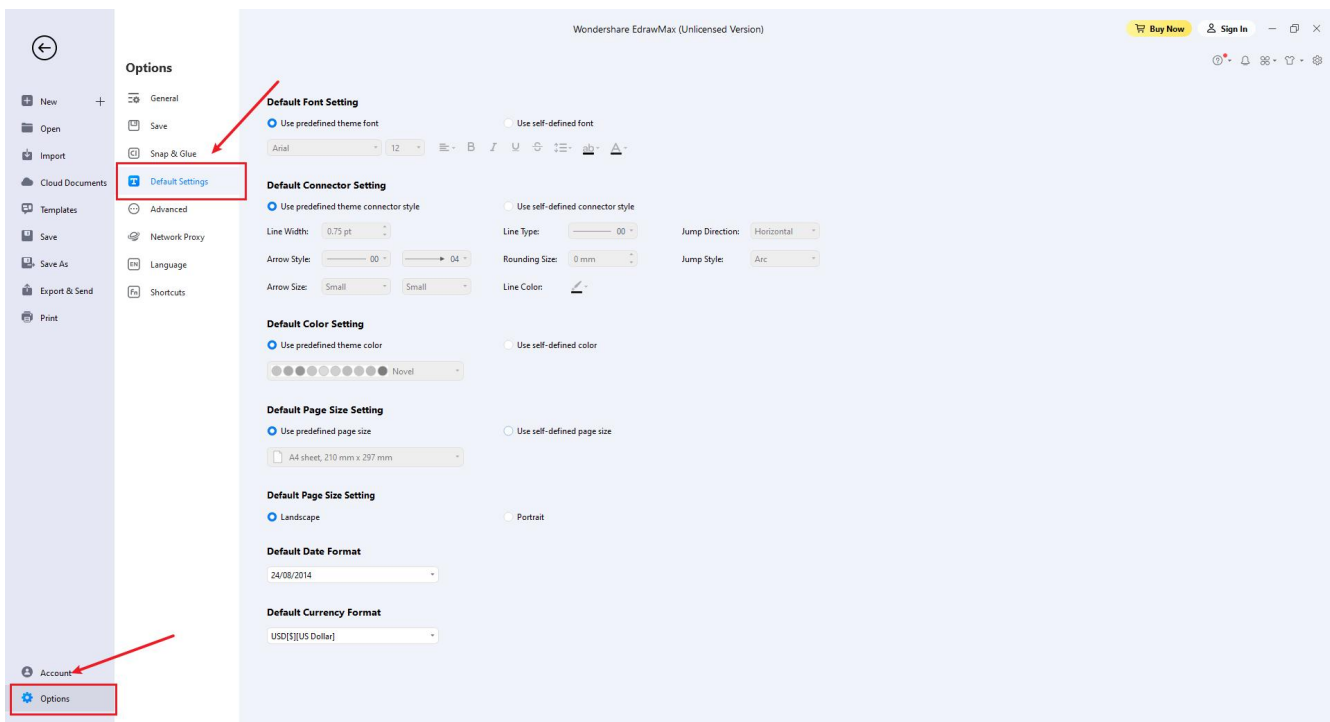

EdrawMax adds new theme colors for UI:

- **For Win:** Light and Dark.
- **For Mac:** Midnight blue and Dark.

Click the Style button in the upper right corner and choose the color you like.

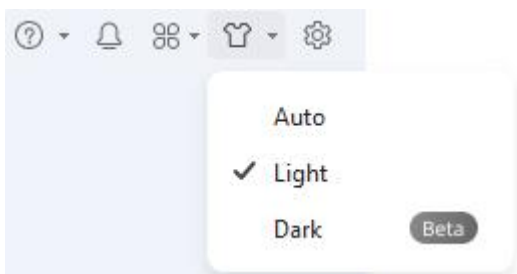

## System Requirements

- Windows 2000/2003/2008/Vista/7/8/10/11 (32bit/64 bit)
- macOS v10.11 to macOS v12; Work on M1 Macs
- Linux: Debian, Ubuntu, Fedora, CentOS, OpenSUSE, Mint, Knoppix, RedHat, Gentoo, and More
- Minimum 2 GB RAM and 4 GB disk space (not including the project space)
- High monitor resolution
- Mouse and keyboard

## Download and Install EdrawMax

If you don't have Wondershare EdrawMax yet, click the button below to obtain your copy of the program.

**Note:** A computer running Windows 11 is used here for illustrations.

Once done, go to the **Downloads** folder (or to the download location if it's other than the default one), and double-click the executable file you downloaded. Click **Install** on the main screen and follow the instructions to install EdrawMax on your PC.

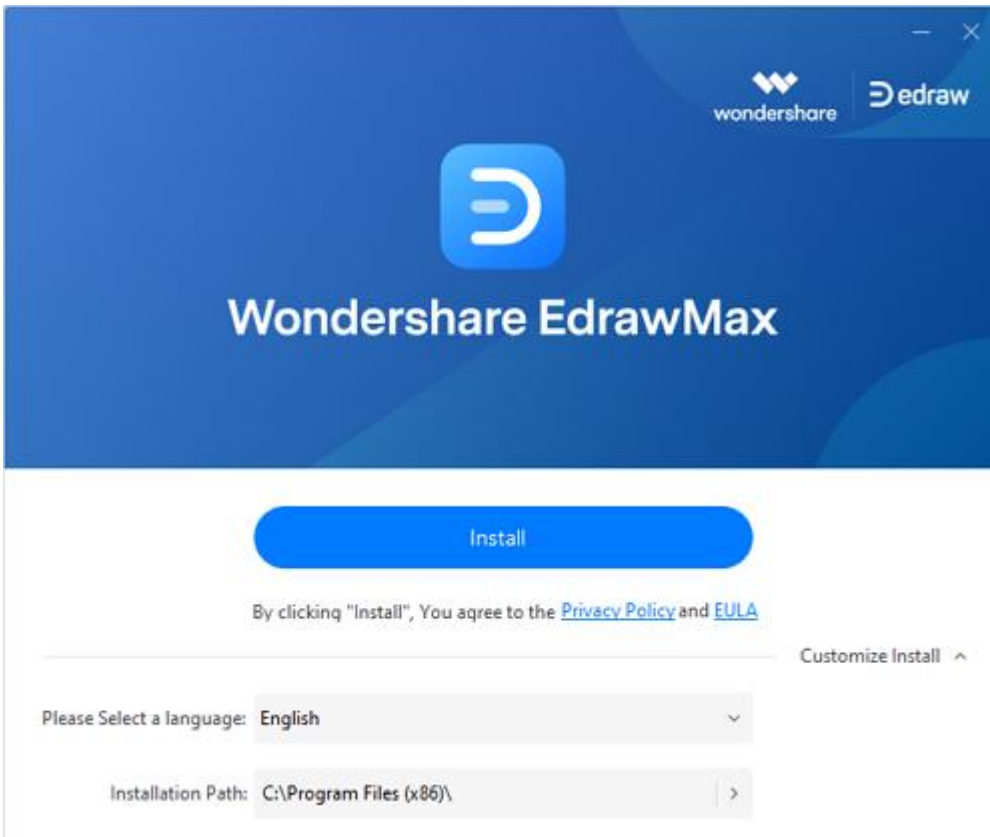

## Register EdrawMax

There are a couple of ways to register your instance of EdrawMax to access all its features for better productions. It is advisable to get this done right after installing the app.

### How to Register?

#### Method 1: From the File Screen

1. Click **Sign In** from the top-right corner of the Home page.
2. Click **Create account** on the **Login to your Wondershare ID** screen.

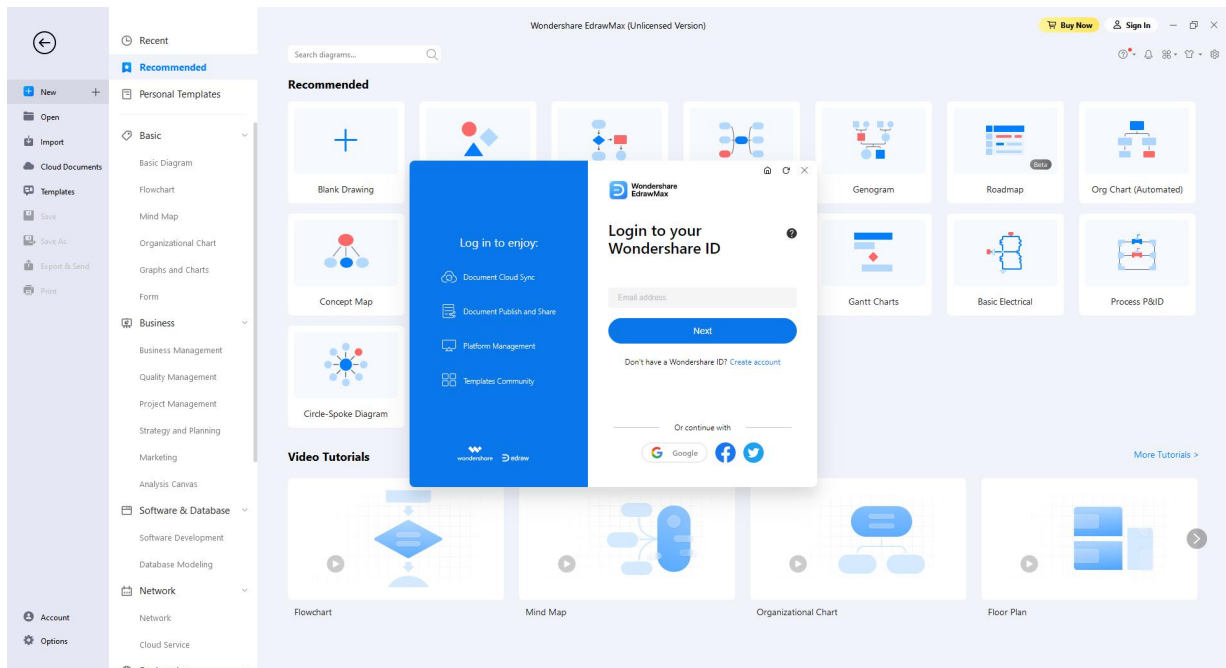

3. Populate the available input boxes on the **Create a Wondershare ID** screen with your email ID, a strong password, and region of residence, and click **Create Account**.

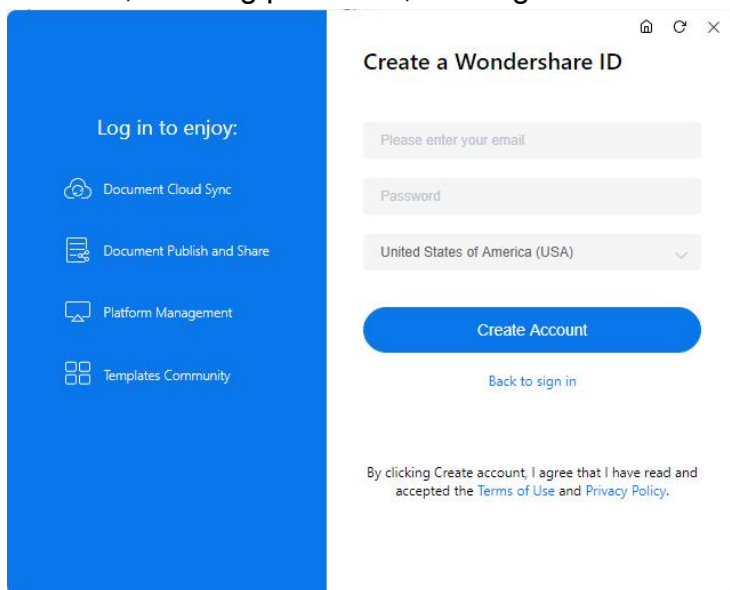

4. After registering, get back to the **Login to your Wondershare ID** screen, and use the account's credentials to sign in to the app.

## Method 2: From the Account Screen

1. Click **Account** from the bottom of the navigation bar present on the left side of the Home page.
2. Click **My Account** from the right window, and the **Login to your Wondershare ID** screen will appear. From there, you can follow the steps explained in the previous method to register and sign in.

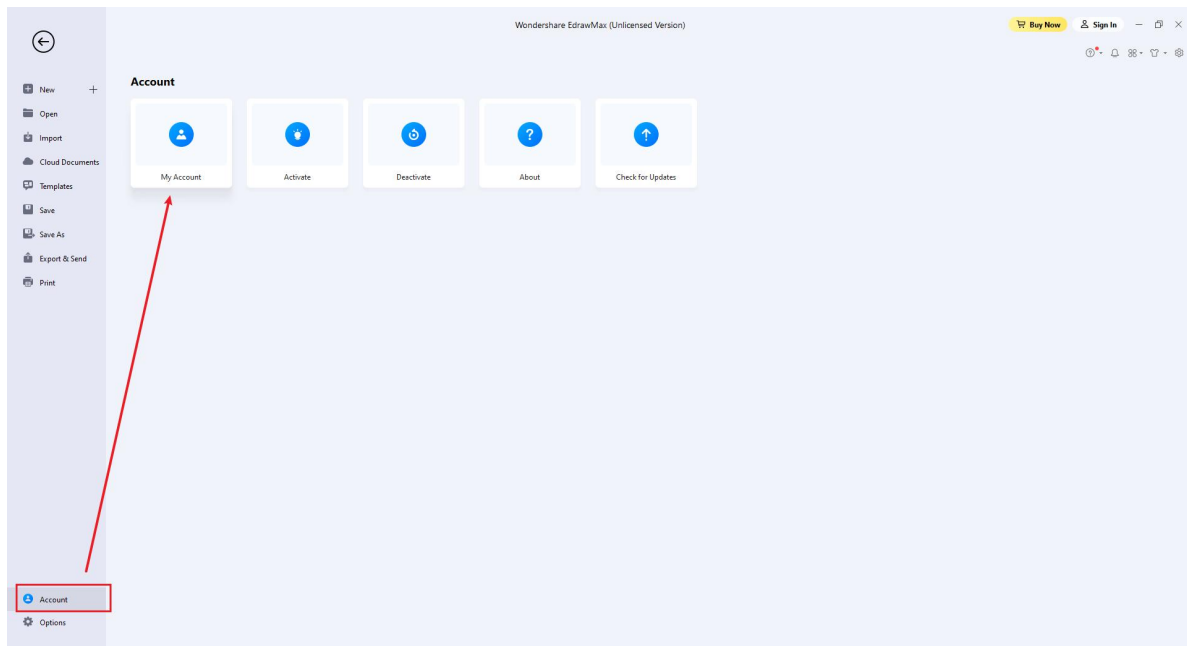

## How to Check Your Account?

After signing in, go to the **Account** screen as explained earlier.

Click **My Account**. Click to select **Orders** from the navigation pane on the left of the My Account box, and you can check your account details under the **Order History** section on the Purchase history tab on the right.

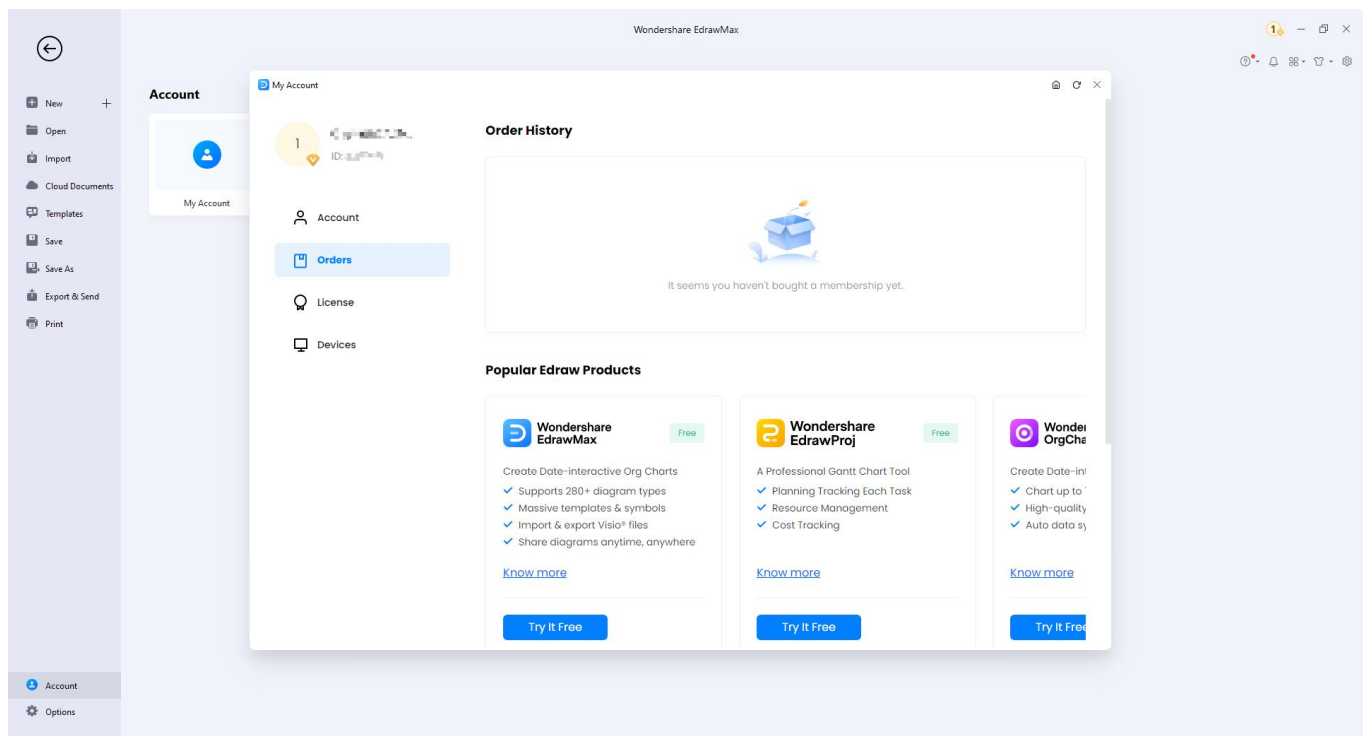

## Update EdrawMax

It is important to check for software updates regularly to ensure a flawless working experience and access all the new features added to the program. Because of this, by default, EdrawMax is configured to check for and install the updates automatically.

However, there might be instances when you don't want the application to install the updates automatically. In such a situation, you can turn off automatic updates and check for them manually whenever convenient for you.

To turn off automatic updates on EdrawMax, and update the software manually when needed:

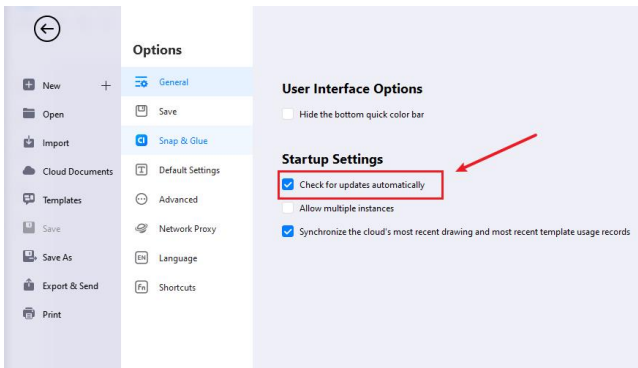

## Activate and Deactivate EdrawMax

### How to Activate?

To get the full features of our product, you can activate EdrawMax and use the premium version. Edraw Activation is an anti-piracy technology designed to verify that software products are legitimately licensed. It works by checking whether the valid license code is used in another device more than the permitted number.

Run EdrawMax with computer administrator privilege and navigate to **Account > Activate**.

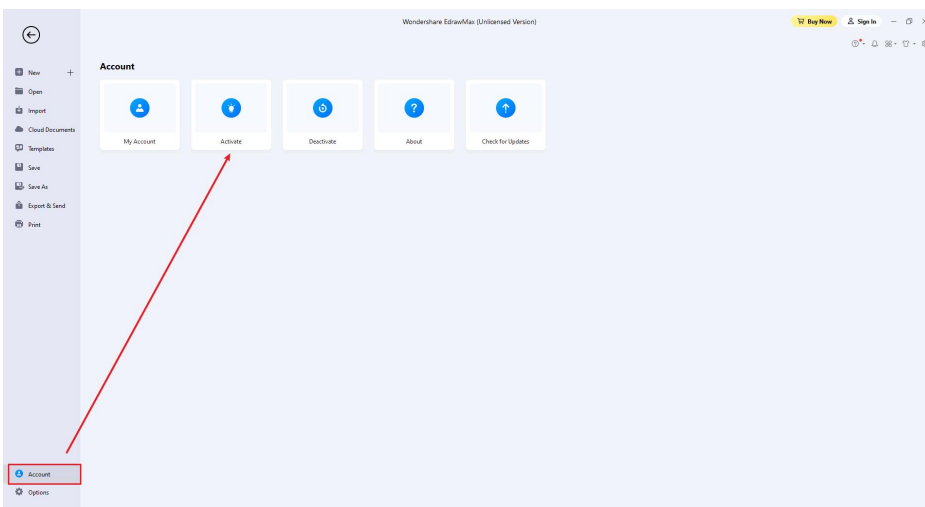

If you buy a subscription or lifetime plan of EdrawMax, you can sign in with your account to activate the software. If you get a license code, click Enter License Code to Activate

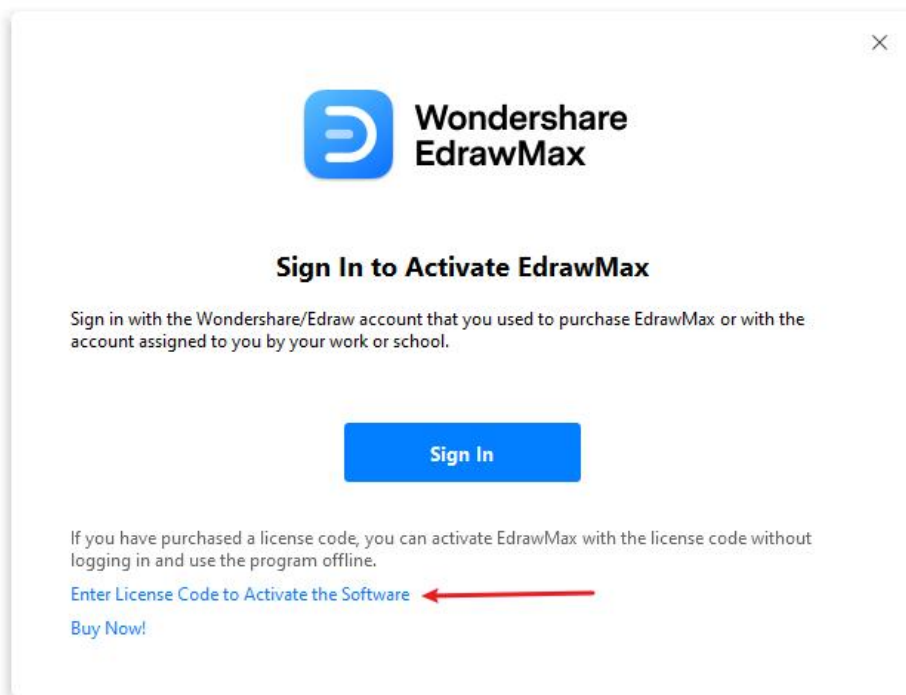

The **Activation** window will open. You can write your name and paste the valid license code in the input boxes. Then click **Activate** button.

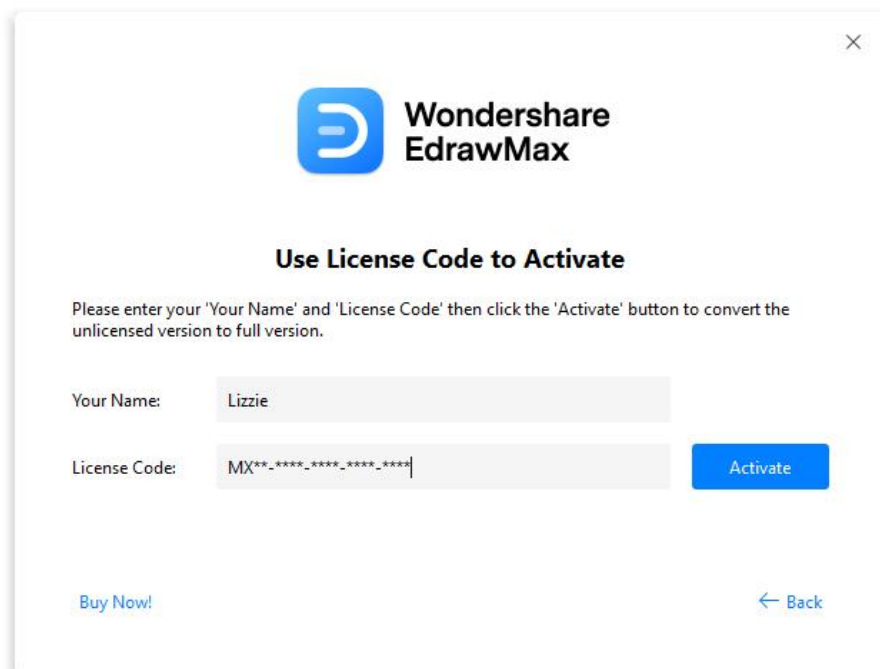

If you buy a subscription or lifetime plan of EdrawMax, you can sign in with your account to activate the software. If you get a license code, click Enter License Code to Activate



## How to Deactivate?

Deactivation is necessary if you want to activate Edraw programs on another computer. Go to the **Account** window and click **Deactivate**.

Once you deactivate the software, EdrawMax on this computer will turn into the unlicensed version, and you can activate it on another computer.

**Note:** Deactivation can only be done once every 30 days.

## The Limitation of Unlicensed Version

An unlicensed version allows you to use EdrawMax freely for 15 days. Using diagrams created by EdrawMax (unlicensed version) for commercial purposes is **NOT ALLOWED**.

The unlicensed EdrawMax will add watermarks when you want to export your designs, and there are also some other functional limitations. Refer to [EdrawMax FAQ](#).

# Chapter 2 File

## Create New Diagrams

You can start drawing with a new file or build from a pre-designed template. There are several ways as follows.

- Launch EdrawMax, choose **Recommended** in the pop-up window and click **Blank Drawing**.

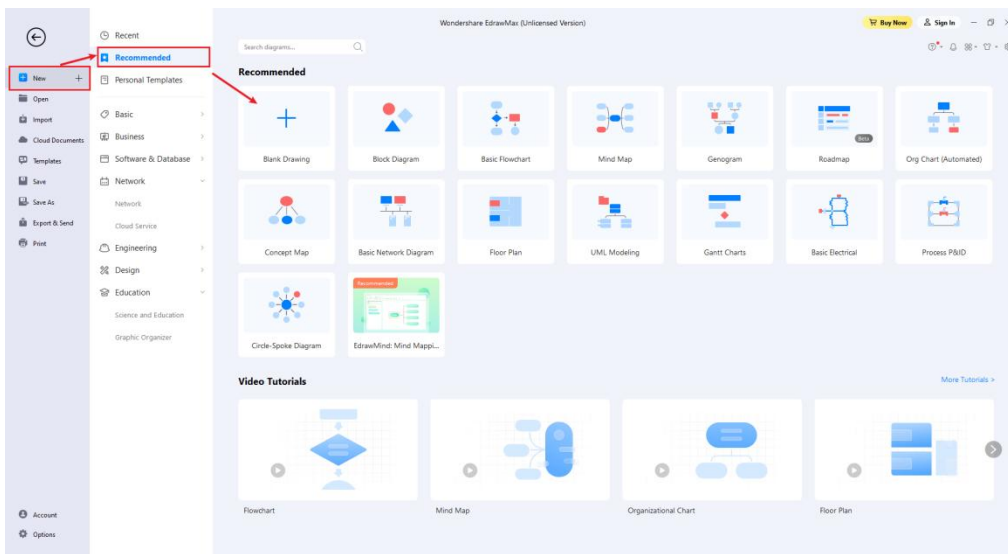

- Choose a pre-made template in the diagram collections window and click the template to open it.

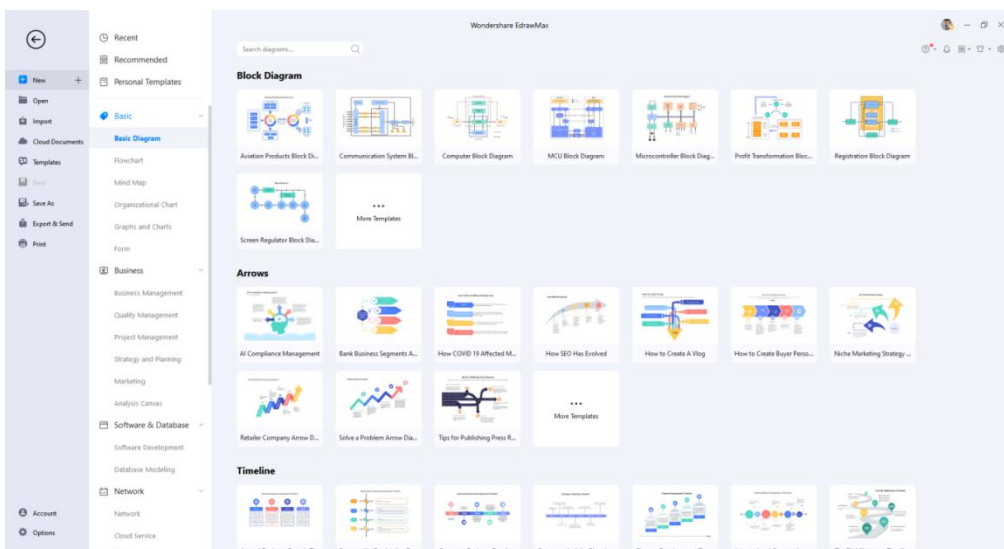

- Win: Use the shortcut **Ctrl + N** ( **Mac:** Use the shortcut **⌘ + N / cmd + N** )  
Or click the **New** button  on the Quick Access Toolbar in the workspace
- Right-click on the desktop, open the context menu, and select **New > Edraw.Document**.

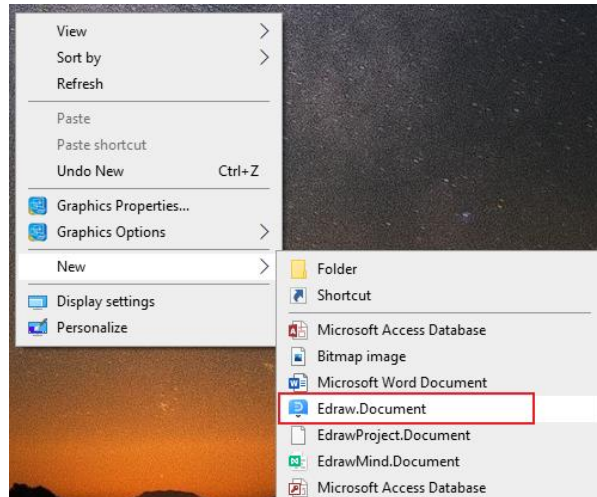

## Open Files

There are several ways to open a file as follows.

- Double-click the file, or right-click and choose **Open** in the context menu.
- Drag and drop the file into EdrawMax to open it.
- Use the shortcut (Win: **Ctrl+O** Mac: **⌘ + O / cmd + O**) or select **File > Open**, locate the file you want and open it.

## Import Files

EdrawMax supports importing multiple file formats, including **Visio (VSDX, VSD)** and **SVG**.

Open EdrawMax and select **File > Import**. You can easily import Visio files (VSDX, VSD) into EdrawMax one by one or in batch.

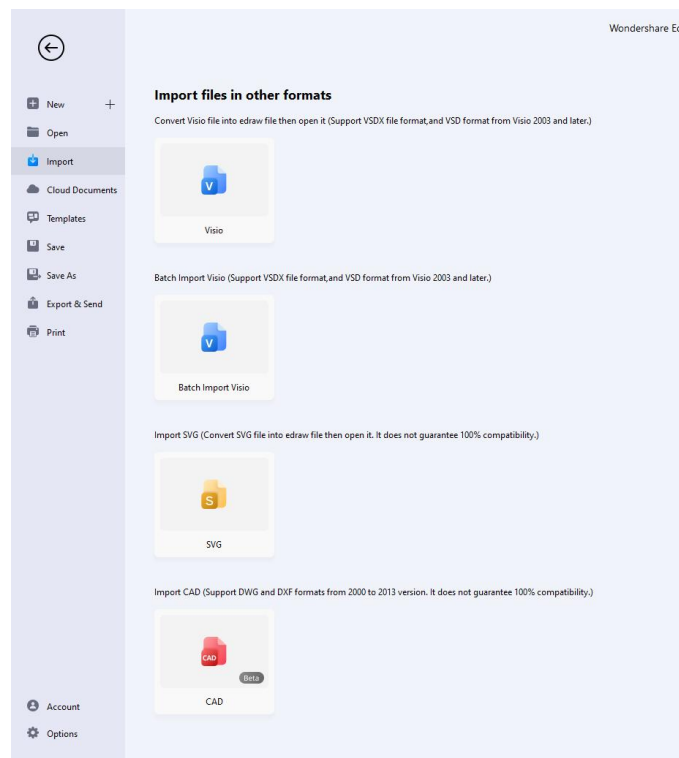

## Save Files

There are several ways to save a file as following.

- Use the shortcut **Ctrl + S** (Mac: **⌘ + S / cmd + S**).
- Select **File > Save**. If the file is saved for the first time, please follow the instructions to rename it and keep it on the right path.
- Select **File > Save As**. You can save the file to a new path or [create personal templates](#).

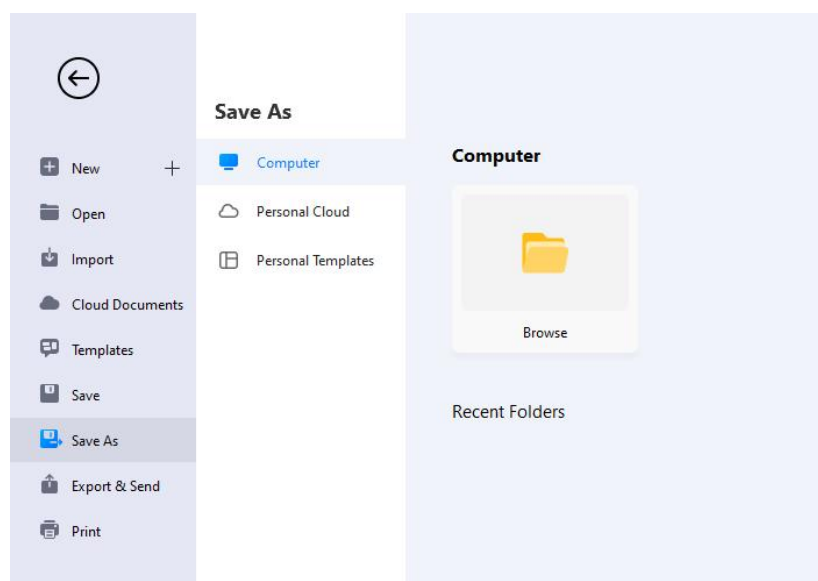

## File Recovery

**File Recovery** is not a replacement for saving your files manually. Save files frequently, and the software will recover files with more versions.

The **File Recovery** panel can be accessed by clicking the **Advanced** tab at the top of the workspace. In the tab you will see two buttons, namely **Version History** and **File Recovery**, where you can see all the available backup files.

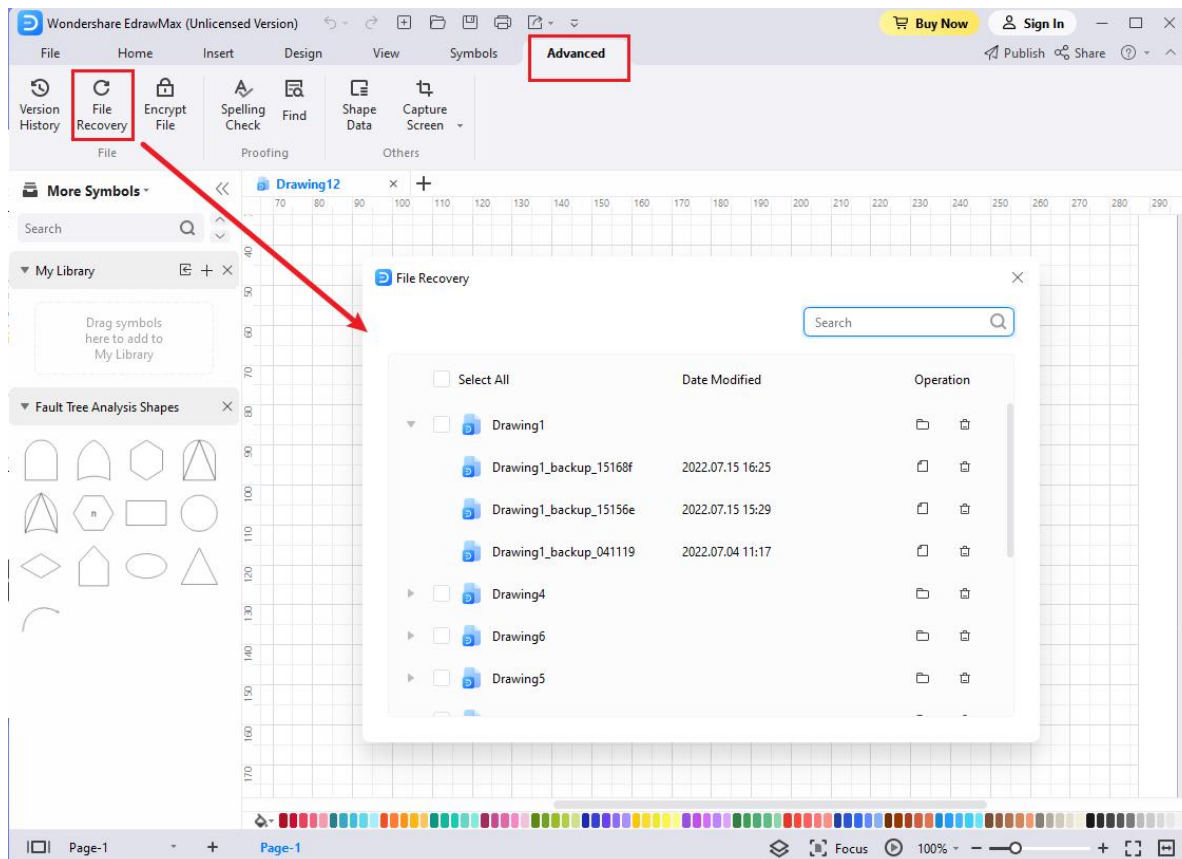

Win: Select **File > Options > Save** to set a time interval for saving backup files.

Mac: Select **File > Options > General** to set a time interval for saving backup files.

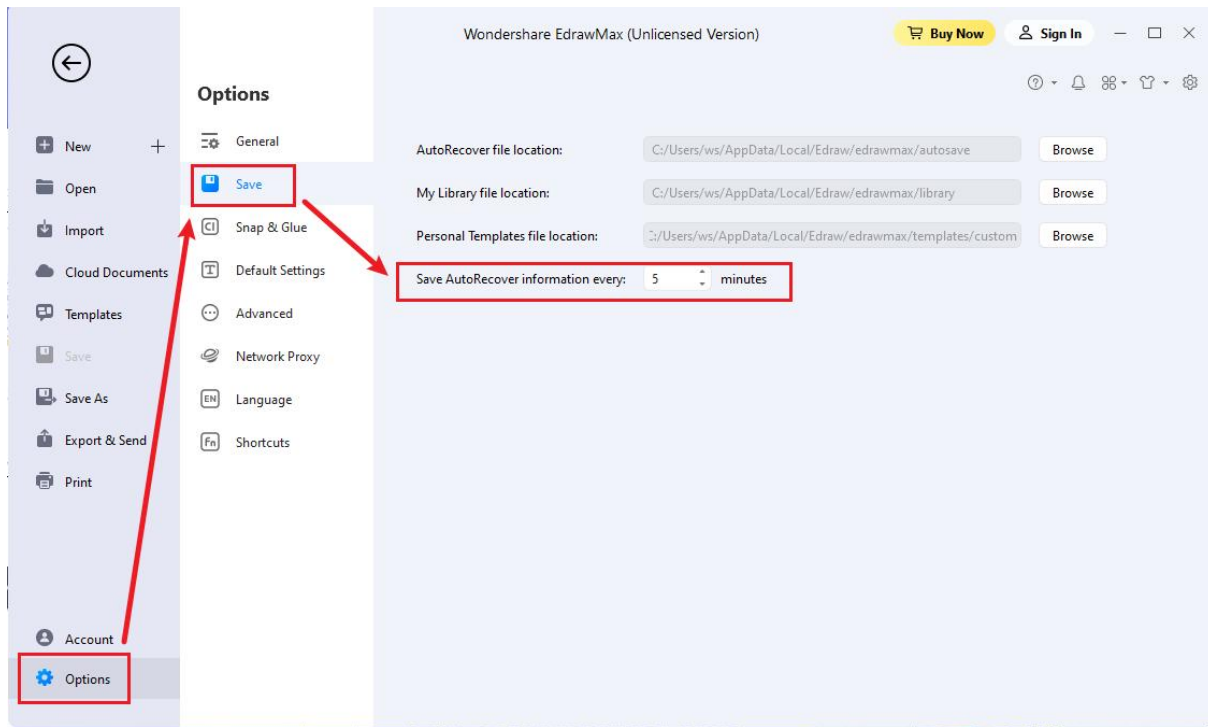

## How to Restore Files?

1. Win: Click the **Advanced** tab from the top of the workspace.  
 Mac: Click the **Version History & File Recovery** icon.
2. Click the **File Recovery** button.
3. Click the Open icon present next to the backup file you want to recover.

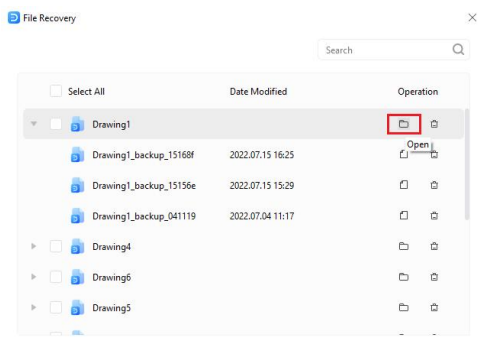

4. Save the file to your PC or Personal Cloud for future uses.

# Version History

**Version History** in EdrawMax allows you to view the change history of the file, revert a file to a previous version, and create a new copy from an earlier version. Version History will work after you have saved the file in the Cloud.

1. Win: Go to **Advanced** > **Version History** to open the **Version History** pane.

Mac: Click the **Version History & File Recovery** icon.

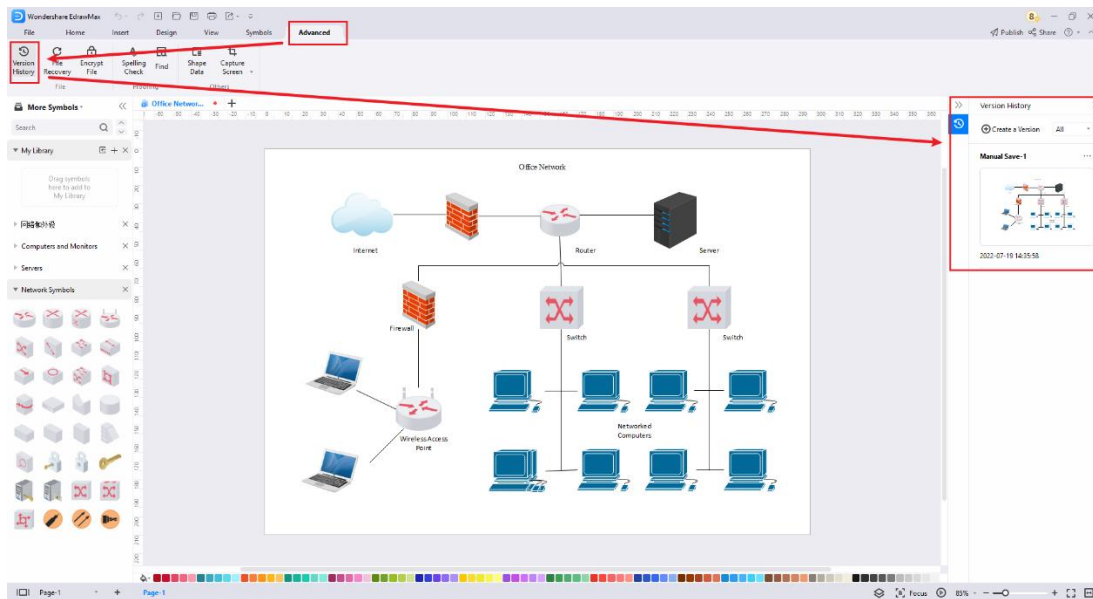

2. Click **Create a Version** to create a version manually for your file, which will be saved in the Cloud and your PC.

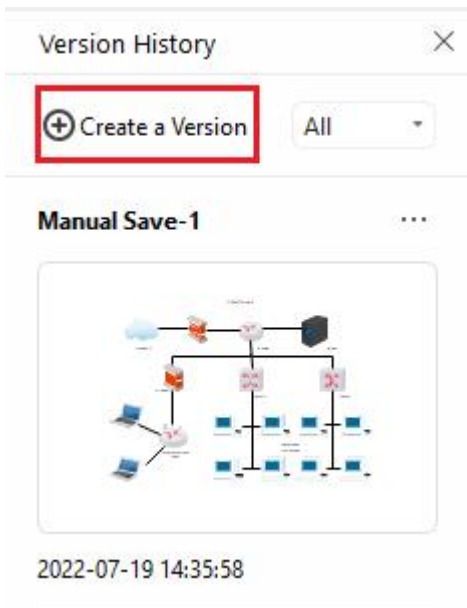

3. Name specific version by clicking on the title of the version.

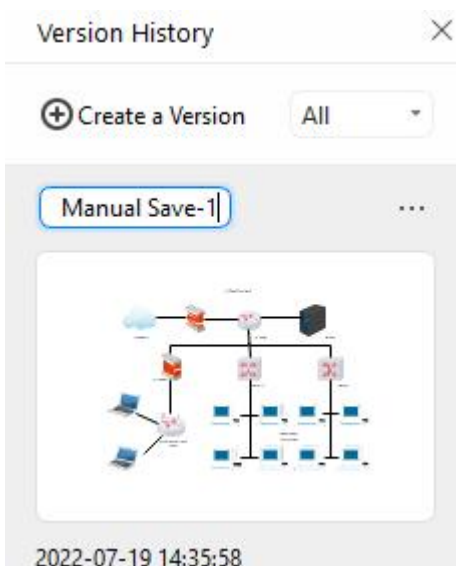

4. Click on the three dots to the right of each tile. A menu will display with three options. Click **Create a copy of this version** to create a new file from the previewed version and not replace the current version. Click **Revert to this version** to return the file to the previewed version, removing all edits made in between that version and the current version.



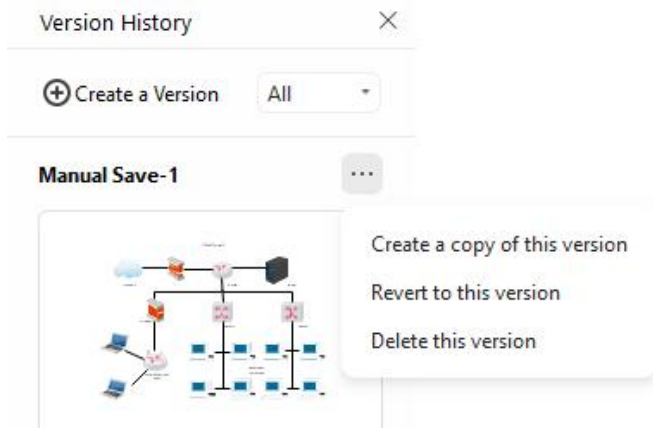

**Note:** EdrawMax automatically generates a new version to be saved in the Cloud and locally when a file is left unsaved for longer than the [set auto-save time](#).

## Export Files

EdrawMax currently supports exporting file formats such as PNG, JPG, SVG, PDF, Excel, Word, PowerPoint, Visio, HTML, etc.

Navigate to **File > Export & Send** or click the **Export** button on the Quick Access Toolbar. Then choose the desired export options.

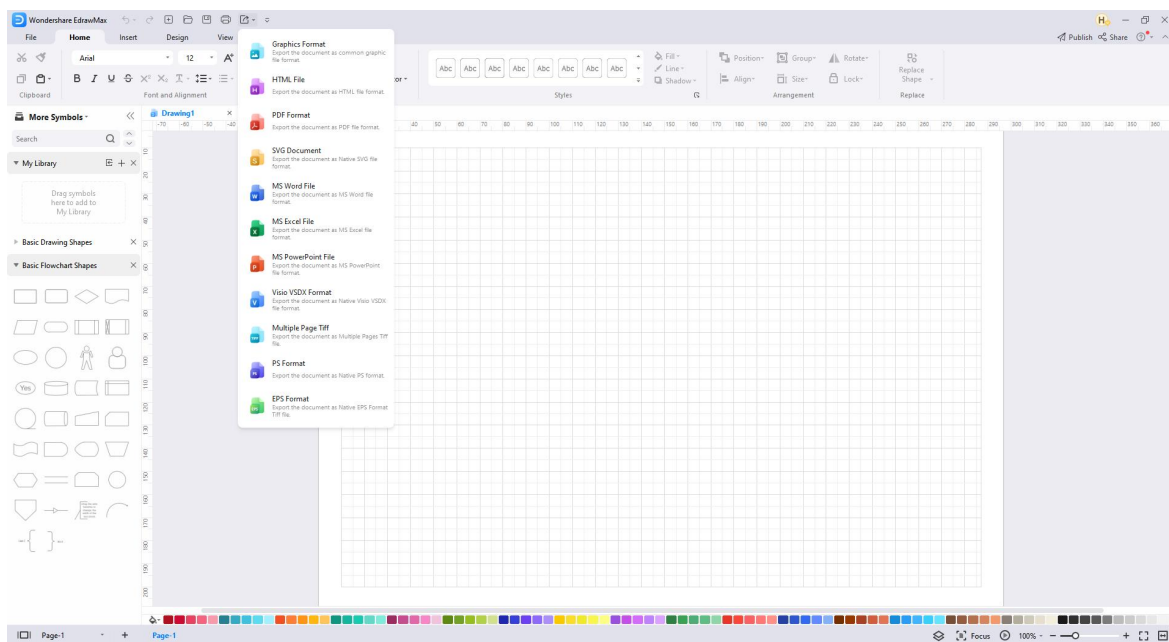

## Export to Graphic

EdrawMax supports exporting PNG, JPG, BMP, ICO, PPM, TIF, and TIFF.

1. Select **Export & Send > Graphics**. The **Export Graphics** window will appear.
2. Choose the size, which page(s) or shape(s) of your file to export, and the resolution.
3. Click **OK**.

4. Choose what type of graphic to export and save the exported graphic.

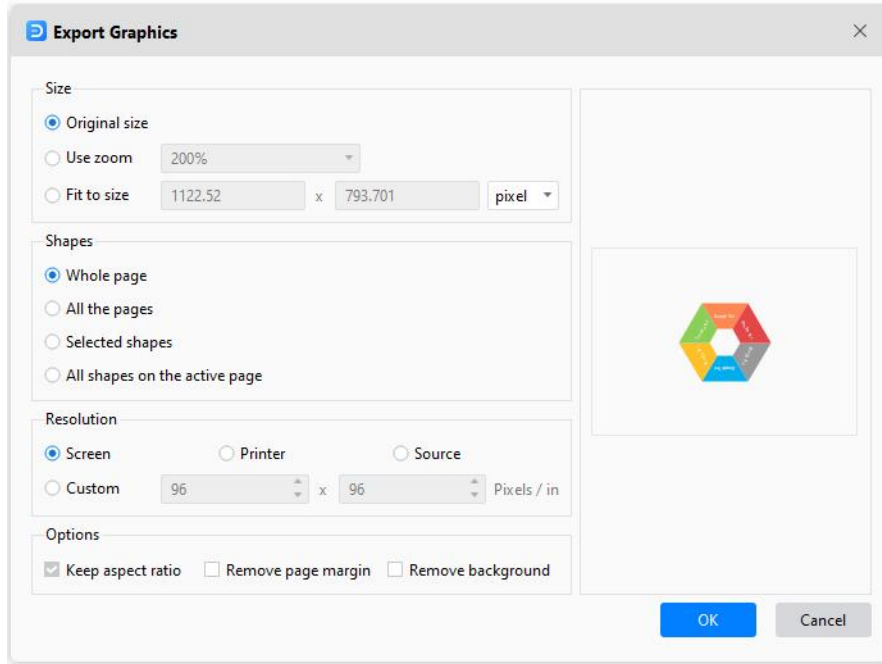

**Tip:** If you only need to export one or some shapes in the drawing, select them on the canvas before clicking the **Export** button. Otherwise, there will be no **"Selected Shapes"** for you to choose from.

## Export to PDF

EdrawMax supports exporting regular and image-based PDFs.

1. Navigate to **Export & Send > PDF, PS, EPS**.
2. Choose **Image-based PDF** or **Regular PDF** to export the document.
3. The **Export** window pops up.
4. The options under the **Documents** tab will be available only when **"All Pages"** or **"Selected Pages"** are selected.
5. Select to export the file as a single PDF file or multiple separated PDF files when the file contains multiple pages.

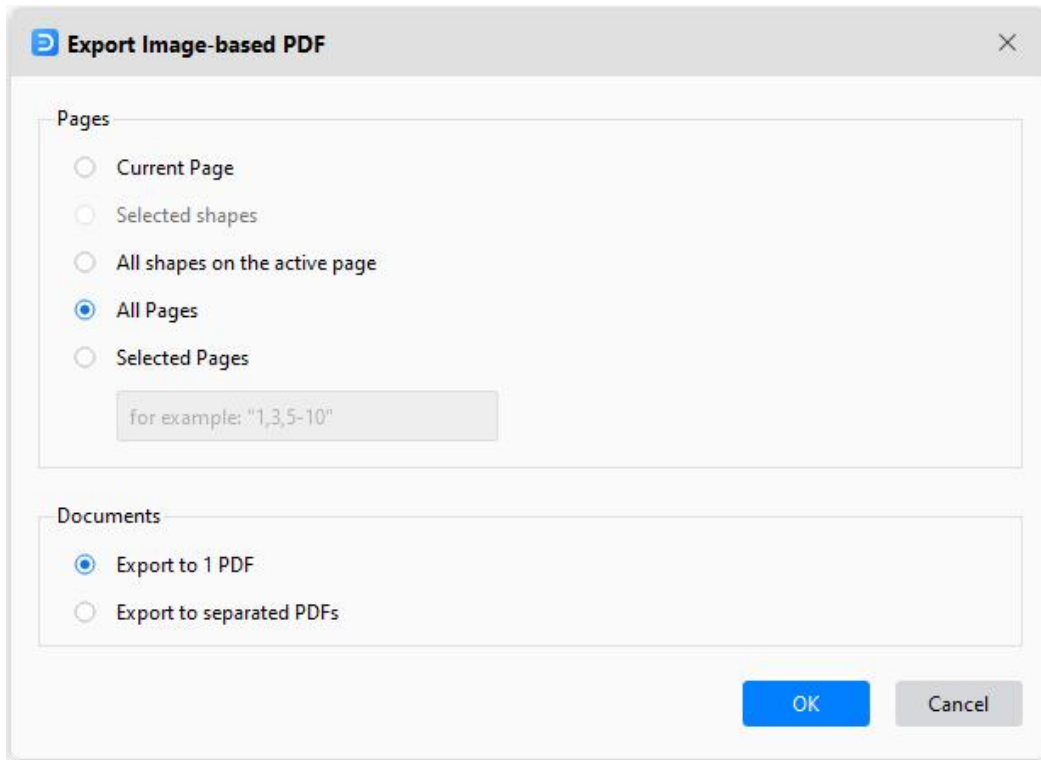

## Export to PS/EPS

EdrawMax supports exporting PS and EPS. Select **Export & Send > PDF, PS, EPS** and choose **PS Format** or **EPS Format** instead. Determine where to save the file and open it with Adobe Illustrator or Adobe Photoshop.

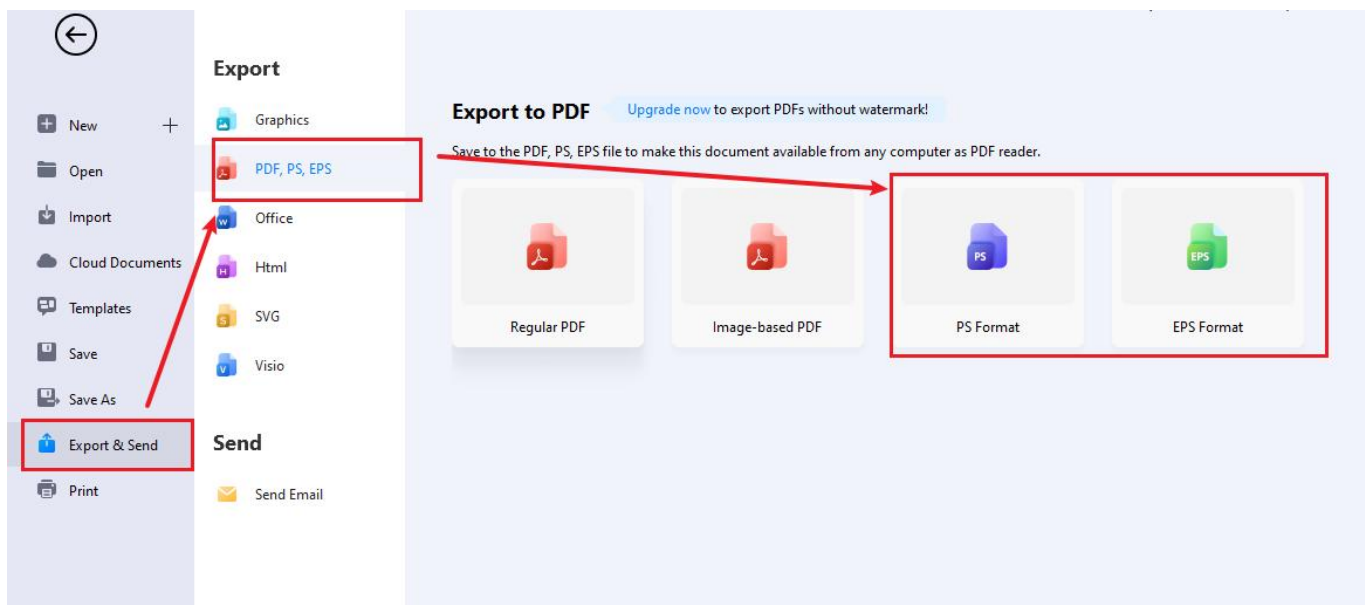

## Export to MS Office

EdrawMax supports exporting editable MS Office files, including Word, PowerPoint, and Excel.

1. Navigate to **Export & Send > Office**;
2. Choose the desired file formats (.docx, .pptx, .xlsx) and customize your export settings.
3. Save the file in the path.

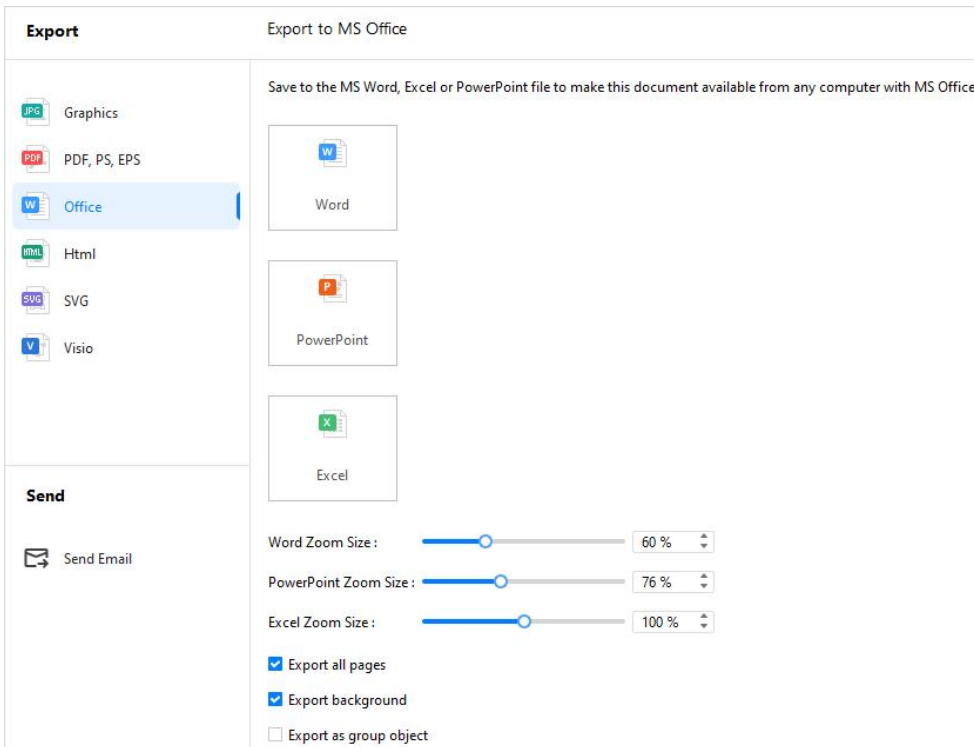

**Note:** For the export documents, we recommend you open and edit them in Microsoft Office 2013 and the advanced versions to get a better preview effect.

## Export to Html

1. Navigate to **Export & Send > Html**.
2. Choose **Html Format** and customize the export options.
3. Save the file in the path.

## Export to SVG

1. Navigate to **Export & Send > SVG**.
2. Choose **SVG Format** and select which page(s) or shape(s) to export.
3. Save the file in the path.

## Export to Visio

1. Navigate to **Export & Send > Visio**.
2. Choose **Visio VSDX Format**.

3. Save the file in the path.

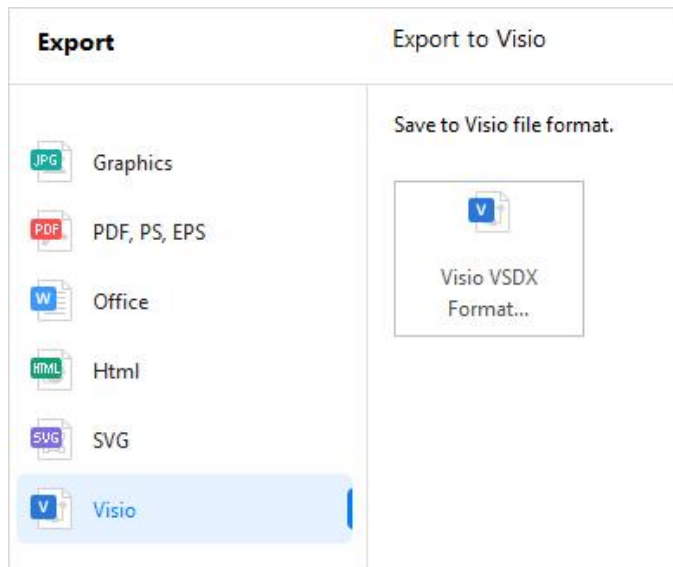

## Share Files

Click  on the top right corner of the workspace, and the **Share** window pops up.

- **Post on social media:** Share your files via Facebook, Twitter, LinkedIn, Pinterest, or Line directly from EdrawMax.
- **Share with link:** manage shared link permissions and allow others to read and edit files.

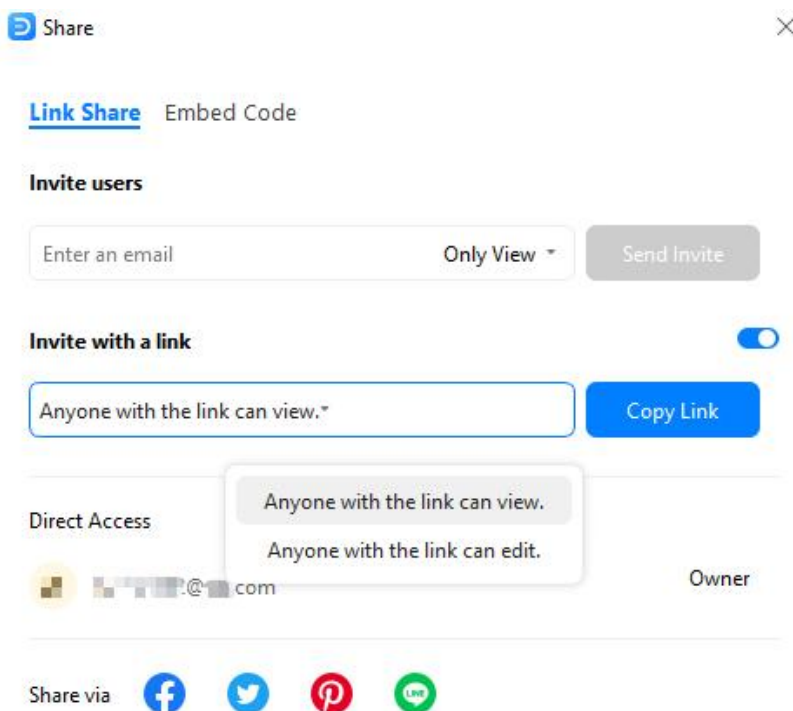

- **Embed into webpages:** copy the generated HTML code and paste it into your webpage.

Share ×

Link Share Embed Code

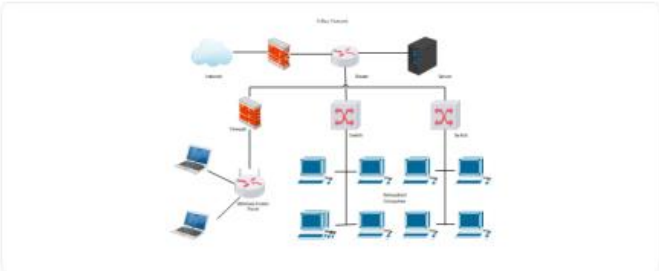

Use in HTML

```
<iframe frameborder= "no" border= "0" marginwidth= "0" marginheight= "0" width= 1133 height= 1603 src= "https://edrawcloudpublicus.s3.amazonaws.com/viewer/self/2503884/share/2022-7-19/1658213961/main.svg"></iframe>
```

[Copy Link](#)

## Publish Files

Click [Publish](#) on the top right corner of the interface, and the **Publish** window pops up.

1. Fill in the file name, file description, and tag, respectively.

**Publish** ×

Publish your work in EdrawMax Templates Gallery to share knowledge and inspire others.

Title

Description  0 / 1000

Tag

I agree to the [Privacy Policy](#), [Terms & Conditions](#) and [Community Guidelines](#).

[OK](#) [Cancel](#)

2. Read the terms & conditions, community guidelines and check the box to agree.
3. Click **OK** and wait for the pop-up window that indicates success.

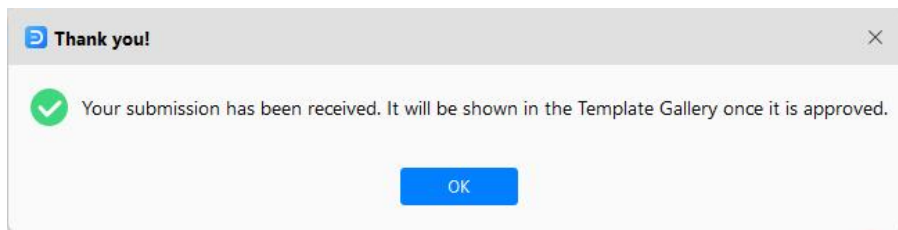

4. Go through your templates in [EdrawMax Templates Community](#).

## Print Files

Use the shortcut to open a print preview interface.

- Win: **Ctrl + P** or select **File > Print**
- Mac: **⌘ + P** (cmd + P) or select **File > Print**

By default, the copy number is 1, and you can choose printers or check printer status in **Printer Properties**. Specify the **Page Range**, **Collated/Uncollated**, **Orientation**, **Page Size**, and other print settings.



Click **More Print Setup** to see whether the sizes of the drawing page and the printer paper meet your requirements. You can add a grid or guideline and know the result in the preview window.

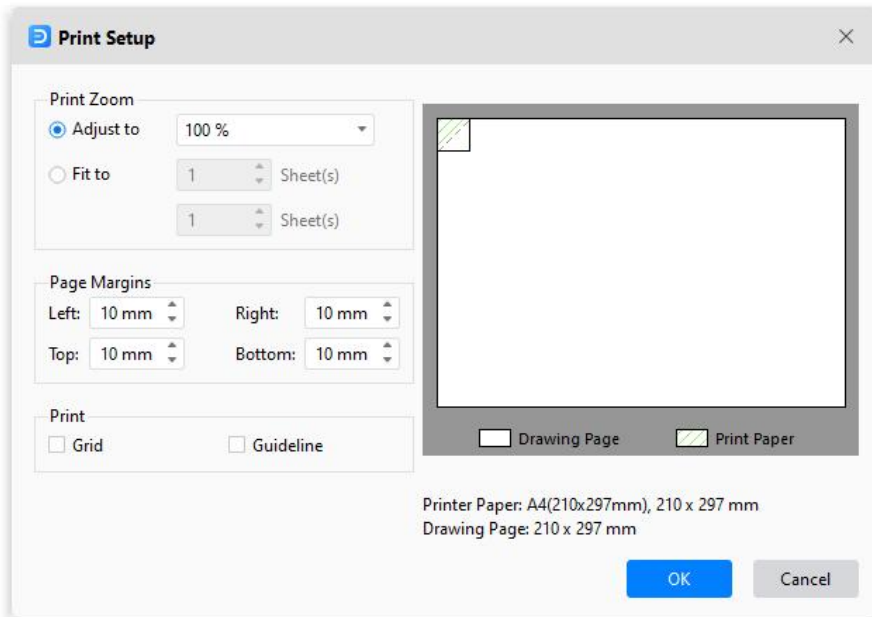

**Adjust to:** The percentage represents how the print size of the drawing page matches that of the printer paper(s). 100% means that the drawing will be printed exactly on paper. Less than 100% indicates that your drawing does not cover extra space on the print paper. For more than 100%, your drawing will be divided into sections and printed by several papers.

**Fit to:** The numbers will decide how many sheets will be used to print the whole drawings. The above means to add printer papers horizontally, while the below is to add papers vertically.

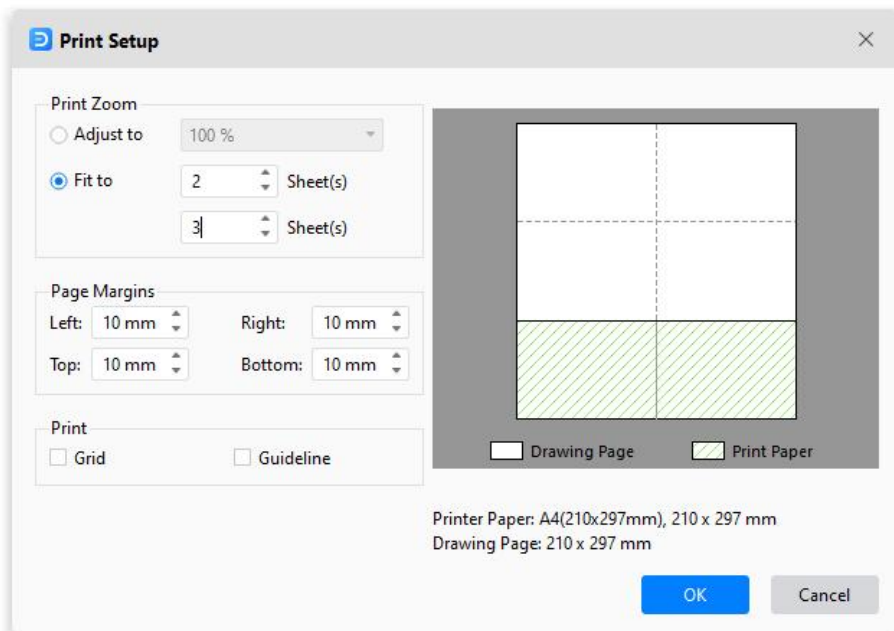

## Encrypt Files

You can add passwords to protect the file.



1. Select **Advanced > Encrypt File** ( Mac: **Select View > Encrypt File**).
2. Enter and confirm the password that contains at least four characters.

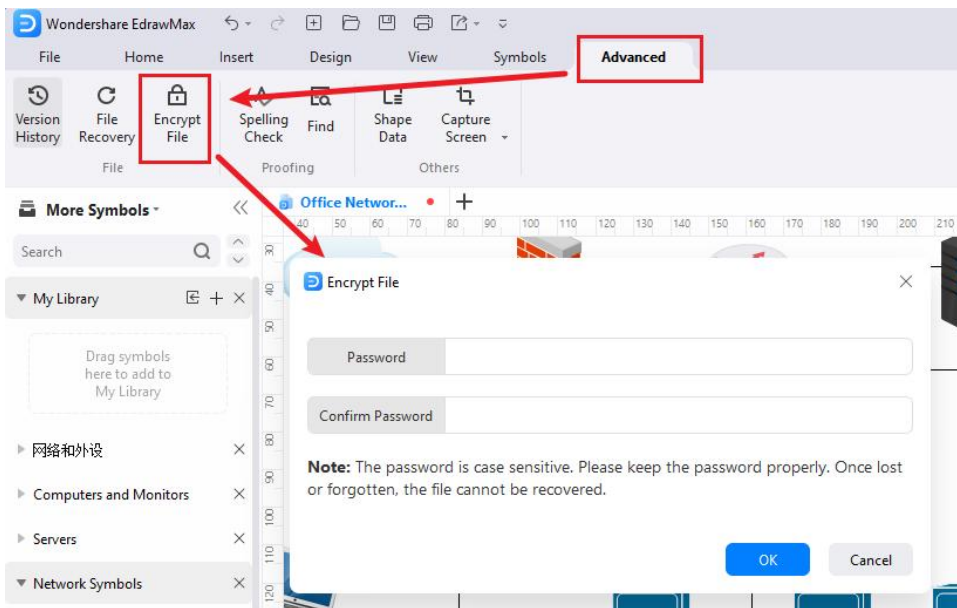

3. You can also change or remove the password.



## Create Personal Templates

If you and your team often use the same diagrams, you can easily convert the diagram into a template and share it. Creating personal templates can help you, and your team save more time and standardize the workflow.

1. Create the diagram, select the page size, background, theme that you want, and choose the commonly-used symbol libraries attached to the diagram.
2. Select **File > Save As > Personal Templates**, name the file, and click **OK**.

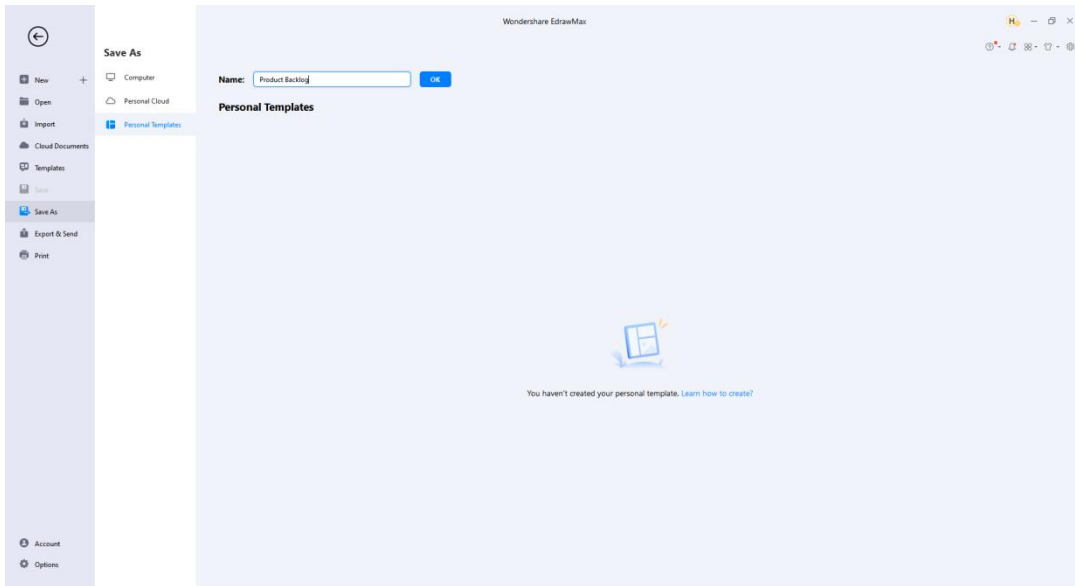

3. See the template thumbnail and the pop-up window if uploaded successfully.

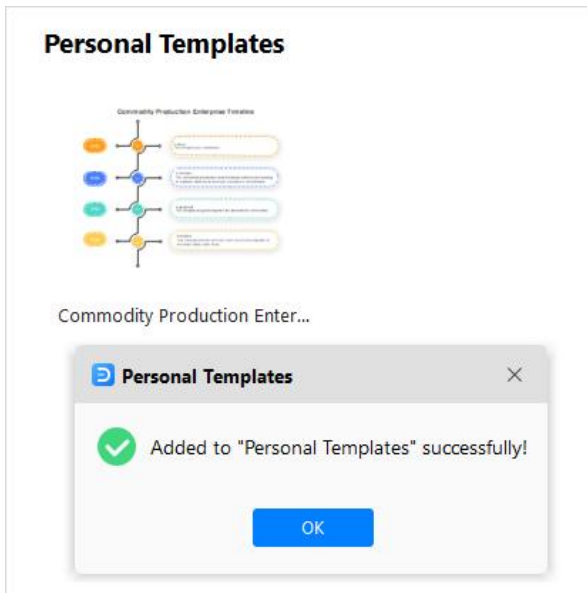

4. Access and use the self-designed template from the **Personal Templates** panel

# Chapter 3 Page

## Add Pages

There are several ways to add pages as follows.

- Select **Insert > Blank Page**.
- Click the plus icon next to the page number on the footer.
- Right-click on the page name and choose **Add Page** on the context menu.

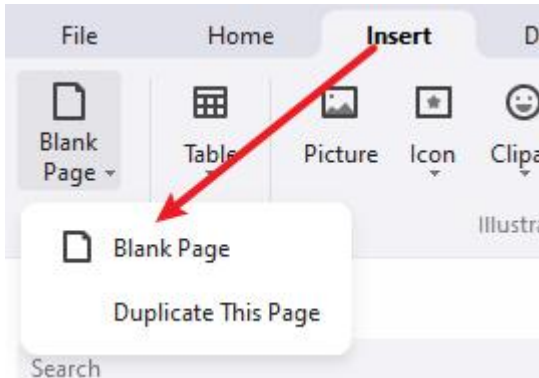

You can also duplicate a page in EdrawMax.

- Select **Insert > Blank Page > Duplicate This Page**.
- Right-click on the page name and choose **Duplicate Page** on the context menu.

## Delete Pages

- Right-click on the page name and choose **Remove Page** on the context menu.

## Reorder Pages

- Drag page tabs and rearrange pages.
- Right-click on the page name and choose **Reorder Pages** on the context menu. The **Reorder Pages** window pops up.

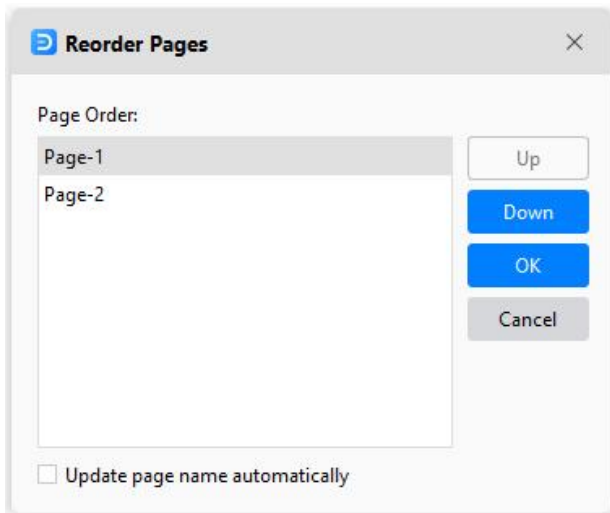

**Note:** If you check the **Update page name automatically**, EdrawMax will rename pages in numerical order.

## Preview Pages

- Select **View > Page Preview**.
- Click the **Preview Page** button on the footer.

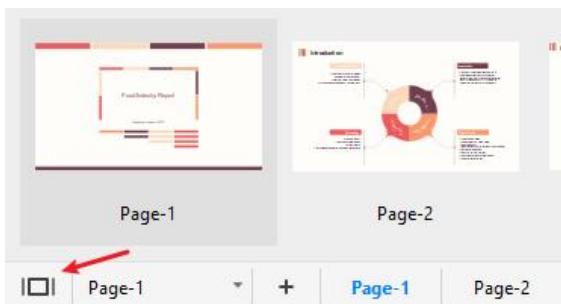

## Zoom Pages

- Use the zoom bar, click and drag the slider to the left or right to zoom out or in.
- Select **View > Zoom** and choose a suitable zoom level.

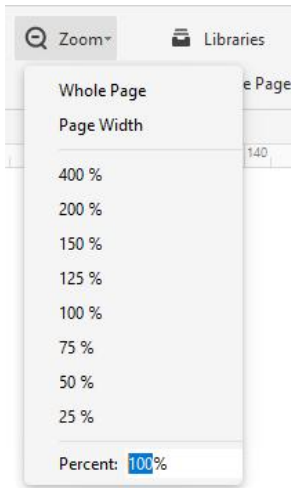

**Whole Page:** Adjust the page size to fit the window size.

**Page Width:** Adjust the page width to fit the window width.

**Note:** EdrawMax supports zoom in/out based on the current position of the cursor.

## Background and Layer

### Add or Change Backgrounds

- For Win: Select **Design > Background Color / Background Picture** and choose a color or a picture you want;
- For Mac: Select **Page Layout > Background Color / Background Picture** and choose a color or a picture you want.

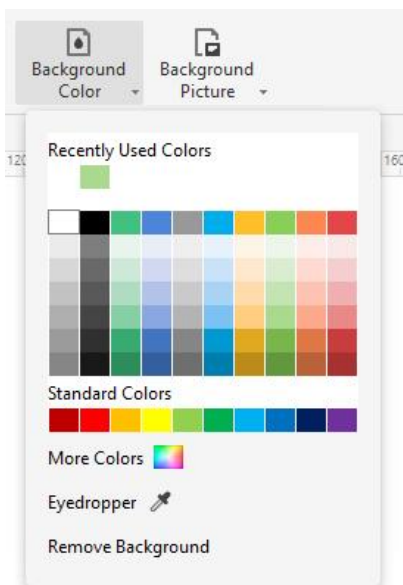

## Remove Backgrounds

1. Select **Design > Background Color/Background Picture**.
2. Click **Remove Background** on the menu.

## Add Layers

The Background is the default setting that you can't delete. When there are only Background and Layer-1, you can't delete Layer-1.

1. Open **Layer** pane on the bottom of the canvas ( Mac: on the right-side of the canvas)
2. Click **New Layer**.

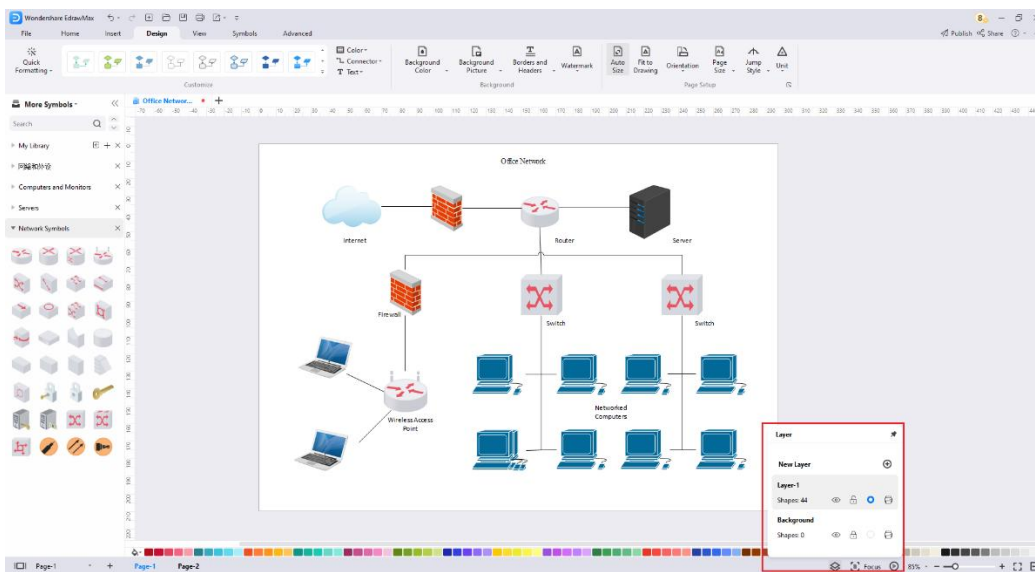

Click the **pen** icon, and you can rename the layers and background.

Click the **open-eye** icon, and the eye will be closed, which means you will not see any shapes on this layer.

Click the **lock** icon, the shapes in this layer will be locked and cannot be selected or changed if the lock is closed.

The **circle dot** icon indicates whether the layer is active or not, and it will tell you which layer you are editing.

Click the **printer** icon, and it shows banned; the shapes in this layer will not be printed.

## Add Watermark

**Watermark:** Add a pre-designed watermark on the drawing page, make your watermark or remove all watermarks.

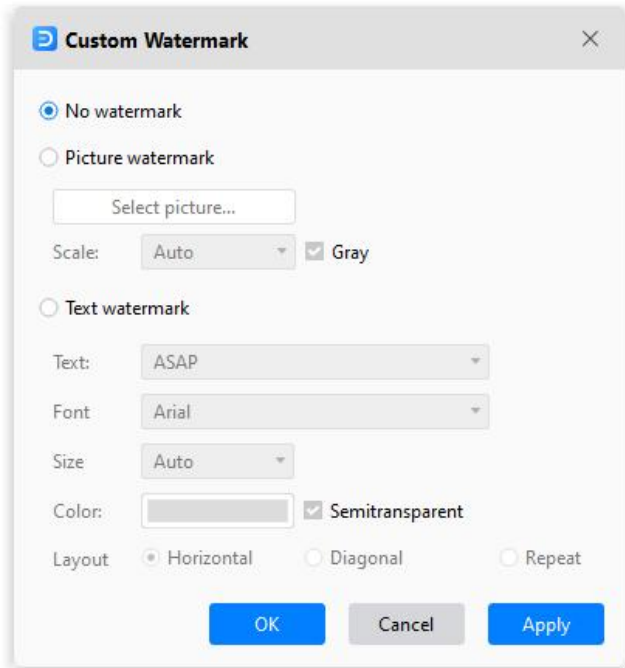

## Page View Options

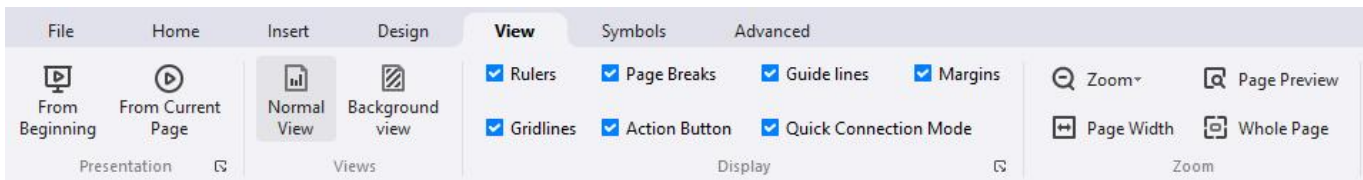

The **View** tab contains

**From Beginning:** Start the slide show from the first page.

**From Current Page:** Jump right into the show from this page.

**Normal View/Background View:** You can switch between two views. The grey button means it is active.

**Auxiliary view tools: Ruler, Page Break, Guide lines, Gridlines, Action Button, Connection Points.** You can use them to help you draw accurately and easily.

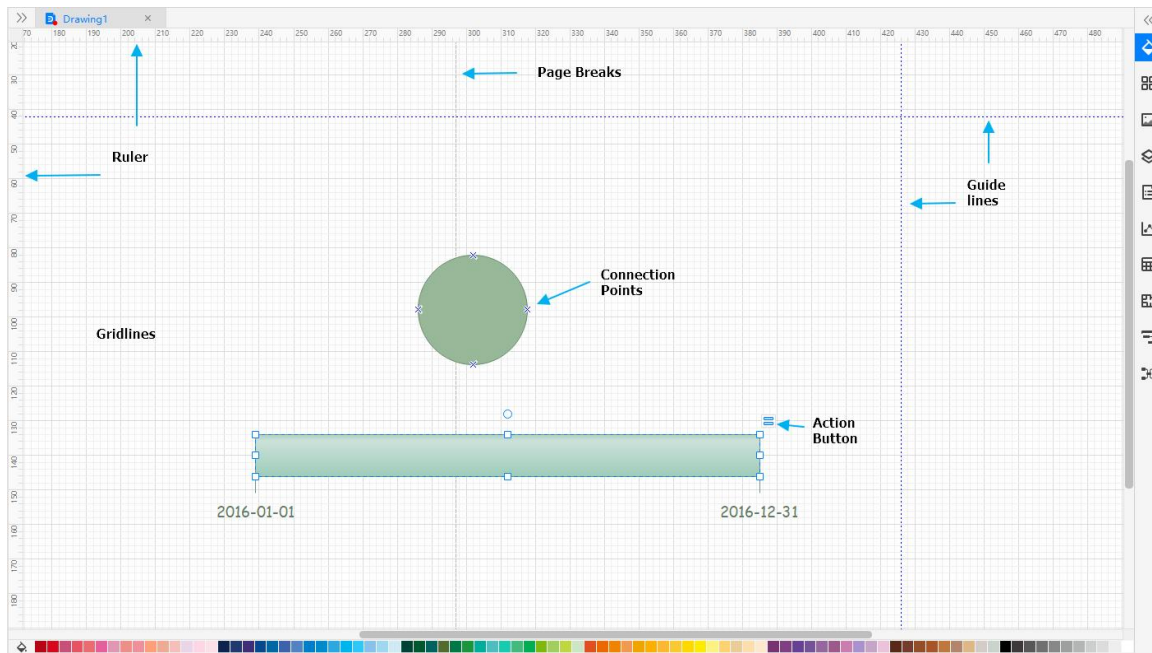

## Snap and Glue

### Turn Snap On/Off

When you create or move a symbol, **snap** pulls symbols and their edges into positions that align with other symbols, ruler subdivisions, grids, guidelines, or connection points. You can specify the types of drawing elements that symbols are snapped to.

1. Select **File > Options > Snap & Glue**.
2. Click **None** to clear all check boxes and turn snap off.
3. Click **All** or select the drawing elements you want to turn snap on.

**Note:** The snap settings you choose will apply to all symbols in the drawing.



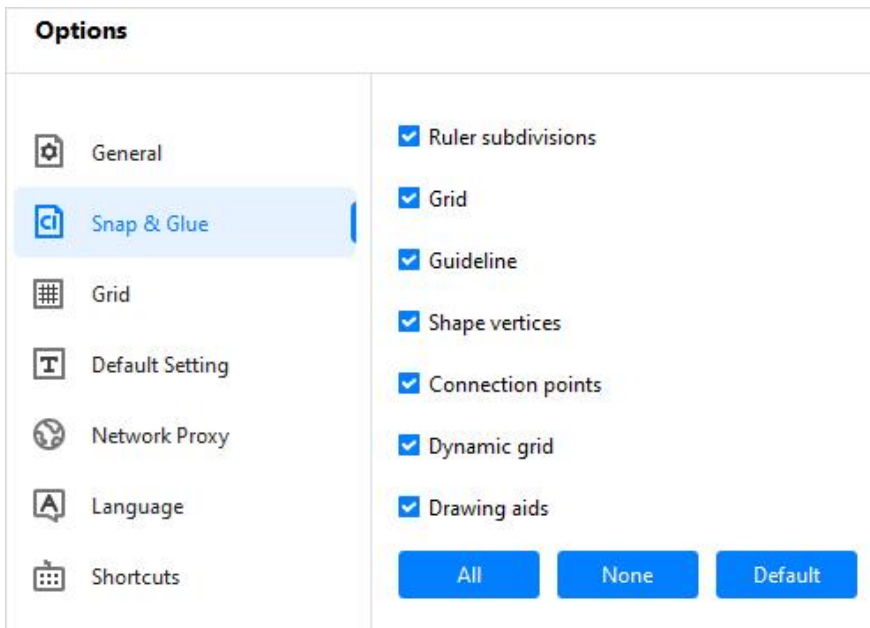

## Turn Glue On/Off

When you draw a connector, **glue** keeps symbols and connectors attached. If glue is turned off, you can move symbols while connectors are unattached.

1. Select **File > Options > Snap & Glue**.
2. Clear the **Connection points** check box to clear all check boxes and turn glue off.
3. Select the **Connection points** check box to turn glue on.

**Note:** The above procedures change the default glue setting for newly-created connectors but do not change the glue setting for existing connectors.

A glued connector shows **red** dots and circles at its end points when selected.

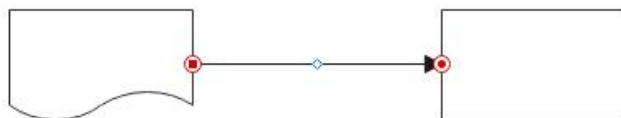

An unglued connector shows **blue** dots or circles at its end points when selected.



# Page Setup

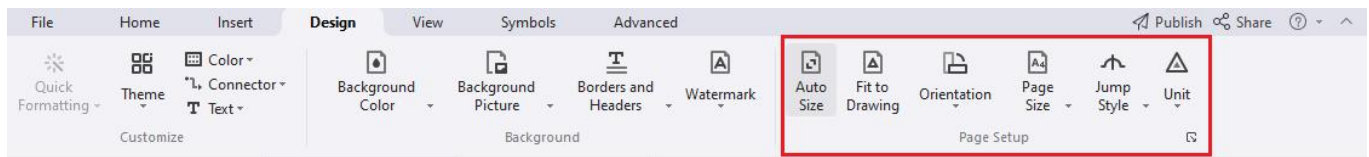

The **Page Setup** in **Design** tab contains

**Auto Size:** Extend the drawing page as needed to help you create larger diagrams than one printed page without changing the printer paper size. Combined with the **Page Break** option (View > Page Break), it shows you where page breaks would happen if you were to print the diagram.

**Page Size:** Choose a page size for your drawing, including A3 Sheet, A4 Sheet, A5 Sheet, B5 Sheet, Letter, Envelope, etc. You can customize page sizes in the **Page Setup** dialog box.

**Orientation:** Change page orientation to **Portrait** or **Landscape**.

**Unit:** Choose a unit of measurement for your drawing, including millimeters, inches, feet, yard, mile, pixel, etc.

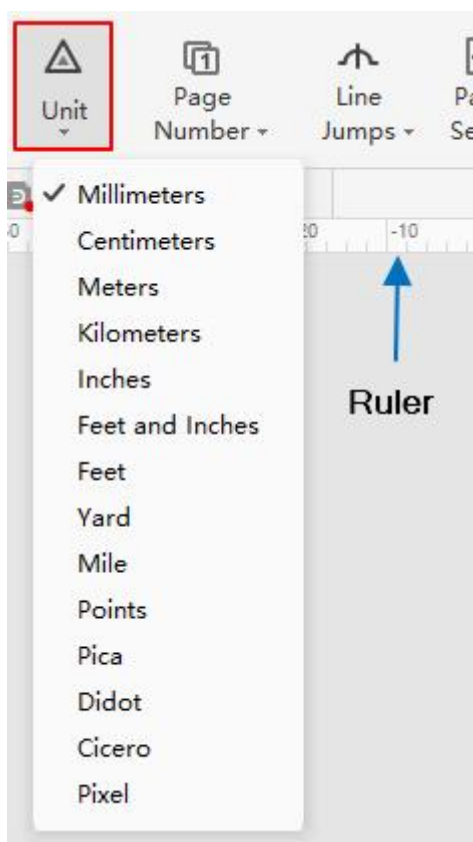

**Line Jumps:** Show or remove connector line jumps. You can change the line jumps setting to make connectors on a page intersect as straight crossing lines or line jumps. You can change line jump styles in the **Page Setup** dialog box.

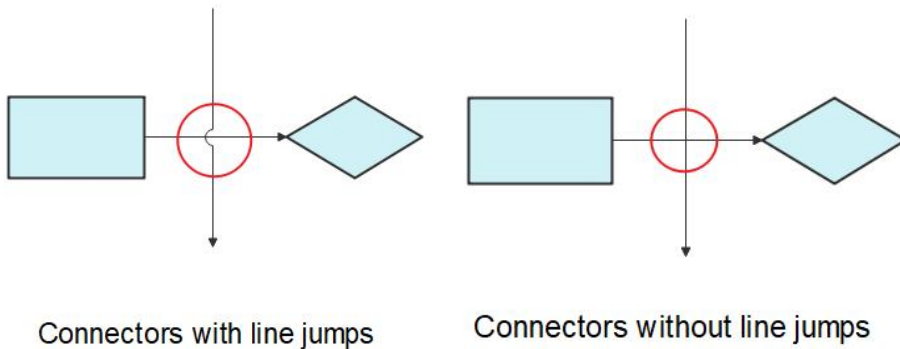

**Fit to Drawing:** Resize the drawing page to fit the symbols on the page.

## Focus Mode

**Focus Mode** keeps you away from distractions and enables you to focus only on the diagram by switching the interface to the full-screen view. All important tools and libraries can be accessed from the floating toolbar on the left of the screen in the Focus Mode.

**To turn on Focus Mode:**

1. Start a new document or open an existing one.
2. Click **Focus** from the bottom-right corner or use the shortcut **F11** (Mac:  $\Lambda + \text{fn} + F$  / **ctrl + cmd + F**).



**To turn off Focus Mode:**

- Click the **Exit** button present at the bottom of the toolbox.
- Use the shortcut **Esc**.

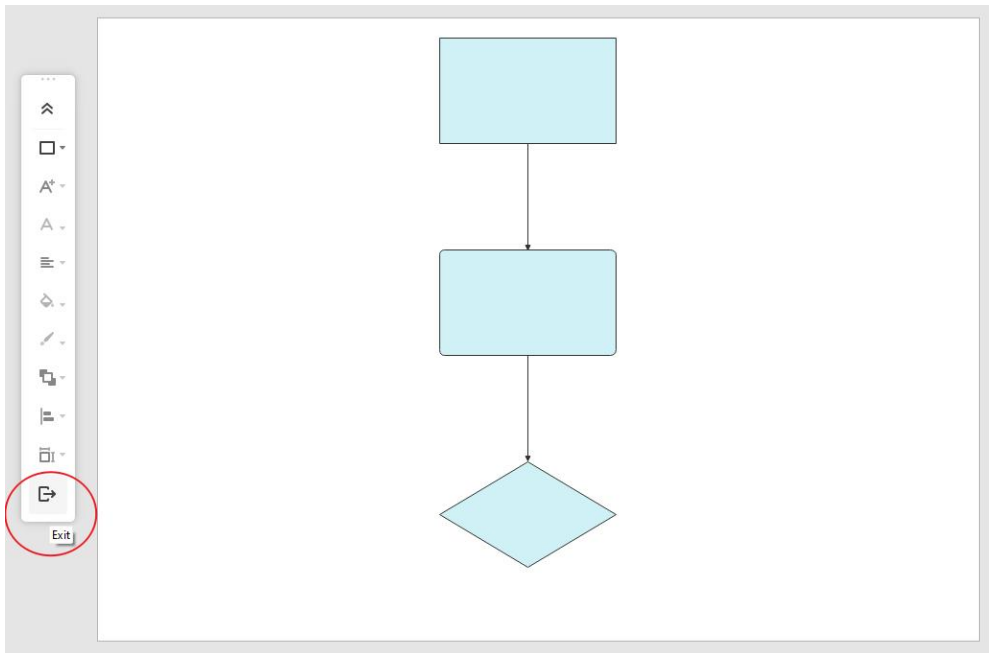

## Spelling Check

1. Open the file with a text or other content.
2. Win: Select **Advanced > Spelling Check** or use the shortcut **F7** to open the Spelling Check menu.

Mac: Select **Home > Spelling Check** or use the shortcut **Fn + F7**

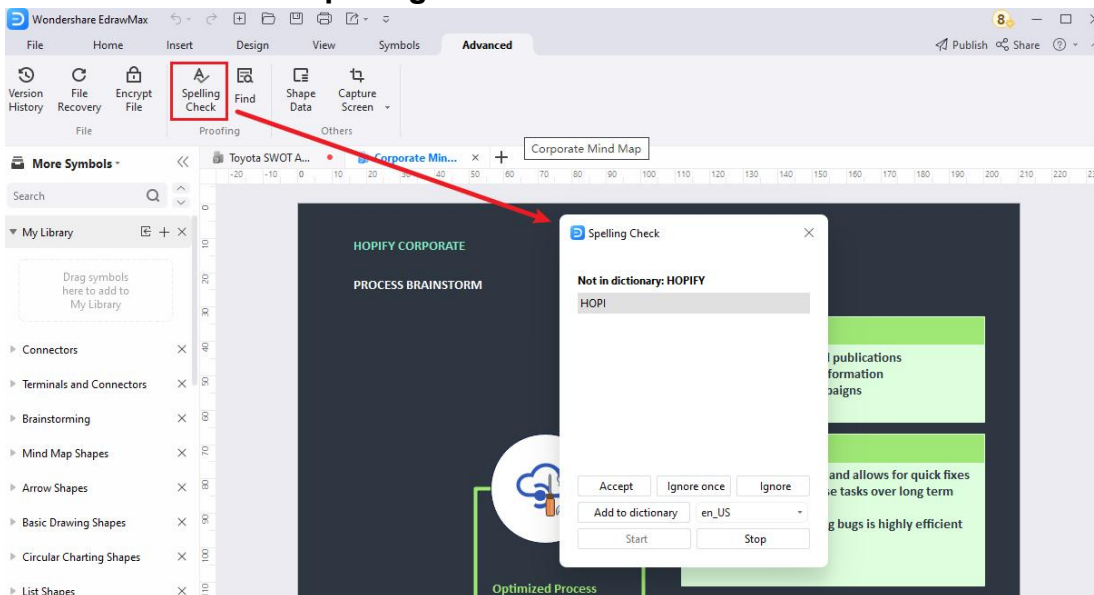

3. From the bottom of the panel, you can use the available buttons to manage the misspelled word

The buttons and their use are explained below:

- **Accept** – To replace the wrong word with the one that EdrawMax suggests. If there are multiple suggestions, you can click the one that you believe is contextually correct and then click the Accept button.

- **Ignore once** – To ignore the spelling error in the instance of the selected misspelled word and leave it unchanged.
- **Ignore** – To ignore the spelling error in all the instances of the misspelled word, regardless of the number of times it is present in the text.
- **Add to dictionary** – Add the misspelled word to EdrawMax's built-in dictionary, so the app doesn't consider the spelling incorrect anymore. The language of the dictionary can be selected from the drop-down list that is present next to the button.
- **Start** – To enable automatic spelling check.
- **Stop** – To stop automatic spelling check. In this case, you must check for the misspelled words manually.

## Find and Replace

1. Open the file with a text or other content.
2. Win: Select **Advanced > Find** or use the shortcut **Ctrl + F**

Mac: Select **Home > Find & Replace** or use the shortcut **⌘ + F (cmd + F)** to open the Find & Replace menu.

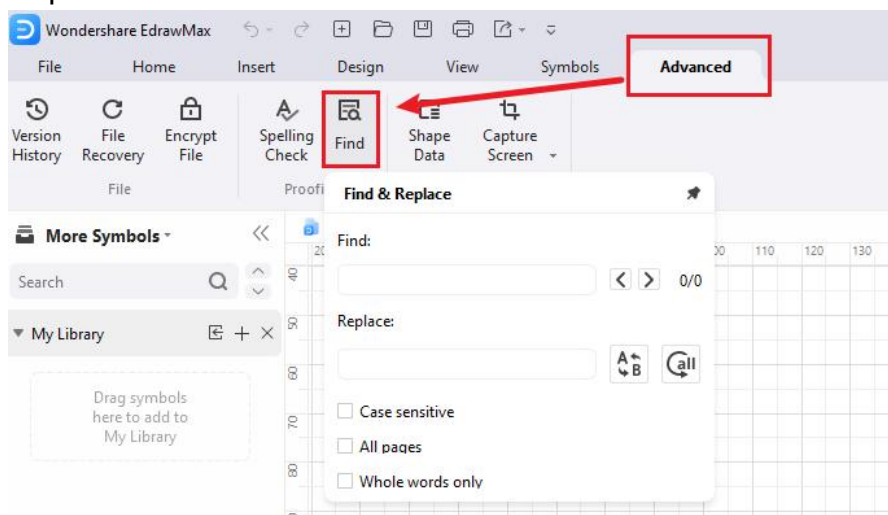

3. In the **Find** field, enter the word that you want to replace.
4. In the **Replace** field, type the word you want to replace with something else.
5. Press the **Replace** or **Replace all** button next to the Replace textbox to replace the first instance of the word or all its instances in the entire text, respectively.

You can fine-tune the replacement process with the help of the checkboxes that are present at the lower section of the Find and Replace panel. The following descriptions explain what these boxes do when checked:

- **Case sensitive** – Searches for and replaces the words that match the upper and lower cases. For instance, with this box checked, when you find the word 'Block,' it would ignore 'block' and find only the word with 'B' in the upper case.
- **All pages** – Searches and replaces the word across all the pages in the file.

- **Whole words only** – Searches only the entire word and not any part of it. For instance, if you search 'Block' with this box checked, the tool would ignore the words like 'Blocked,' 'Blocking,' etc.

## Capture Screen

1. Open the file or create a new one.
2. Win: Select **Advanced > Capture Screen** or use the shortcut **Ctrl + Shift + R** to open the snipping tool.

**Mac:** Select **Home > Capture Screen** or use the shortcut **⌘ + ⬆ + R** (cmd + shift + R)

3. Win: Alternatively, select **Advanced > Capture Screen > Capture Screen with Window Hidden** or use the shortcut **Ctrl + Shift + X** to hide EdrawMax's interface and capture anything else that is present underneath it.

(Mac: Select **Home > Capture Screen > Capture Screen with Window Hidden** or use

the shortcut **⌘ + ⬆ + X / cmd + shift + X**)

4. Drag the mouse pointer across the area on the screen you want to capture a screenshot.



Once the screen is captured, the options that are then available include:

- **Undo** – To discard the current capture and start over.
- **Shapes, Line, and Text Tools** – To draw shapes like rectangles, ellipse, etc., line, and add text to the captured snapshot.
- **Copy** – To copy the captured image to the clipboard.
- **Save** – To save the screenshot to your PC in PNG, JPG, or BMP format.
- **Cancel** – To discard the capture and exit the Capture Screen mode.
- **OK** – To accept the capture and place the screenshot on the canvas.

# Chapter 4 Presentation

## Create Presentation Slides

EdrawMax can automatically create presentation slides based on the project file's pages. It also helps you manually create slides out of different shapes or parts of a page, preview the slideshow, define the presentation's aspect ratio, and export the slideshow in PPTX format, which can then be opened in Microsoft PowerPoint for further inputs and slight modifications.

## Auto-create Presentation Slides

1. Open a file or create a new one.
2. Add your preferred diagram to the canvas of the first page.
3. Click the + (**Add Page**) button to add a new page and create the next diagram you want to have in the presentation.
4. Repeat the process to add as many pages and diagrams as you need.
5. Win: Go to **View** and click the launcher button of **Presentation** group Mac: Click the **Presentation** icon from the toolbox of the right pane.
6. Click **Auto-Create presentation by pages** to automatically create a presentation using each page as an individual slide.

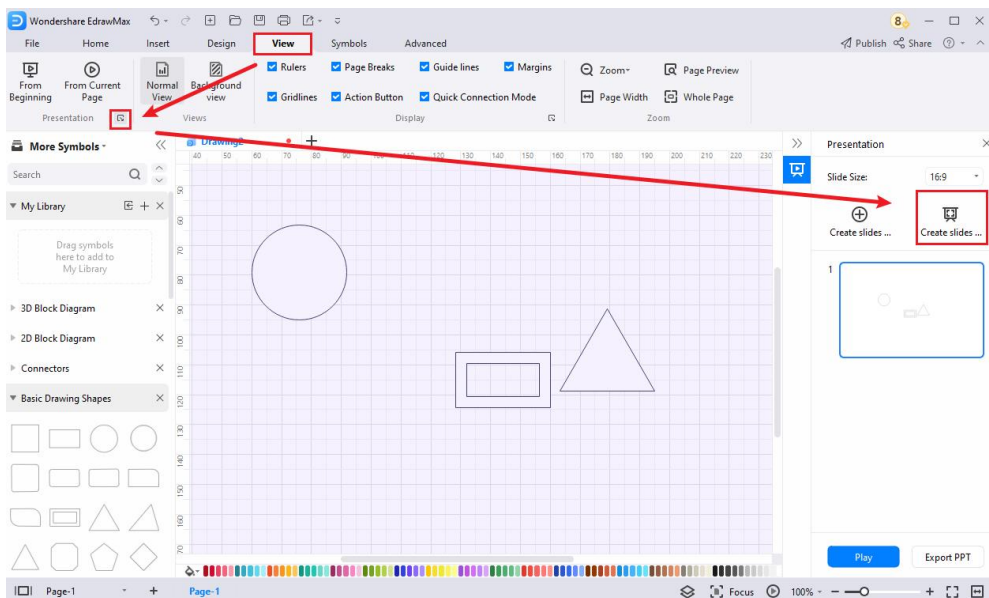

7. Click the **Play** button below the Auto-Create button to preview the slideshow before exporting.



## Create Slides Manually

Manual slide creation doesn't require you to have multiple pages, and you can even create them out of different sections of a diagram on any page. The method is as follows:

1. Open a file or create a new one and create a new diagram on the canvas.
2. Open the **Presentation** pane and click **Create a slide by selecting any area of the page** to add a section frame.
3. Drag the selection frame over the area or shape on the canvas that you want to create a slide. If need be, use the corner handles of the selection frame to resize and cover the area you want to capture for the slide.

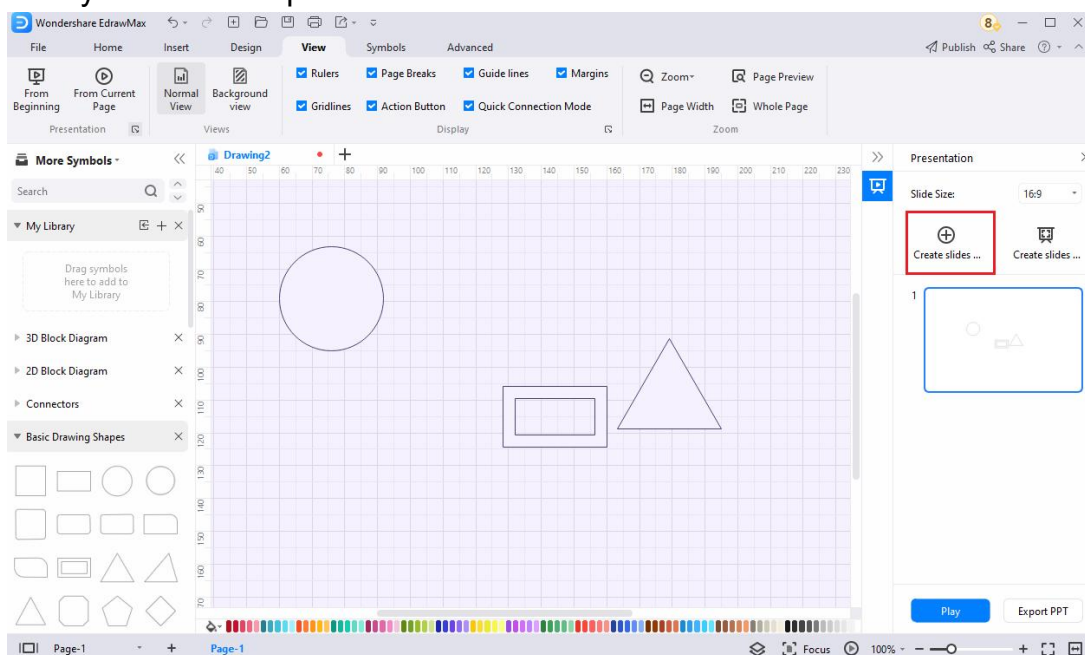

4. Repeat the process to create as many slides as you need.
5. Win: Change the slide size for the section frame.

Mac: Click the gear icon and change the aspect ratio for the section frame.

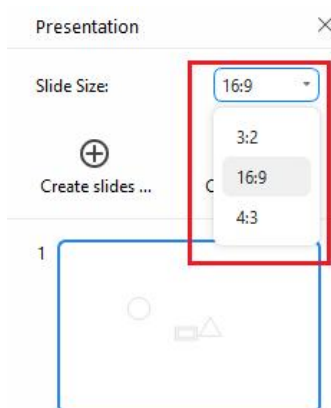



## Export Presentation Slides

Exporting to PPTX enables you to view and edit the presentation in MS PowerPoint. The good thing is, you can even edit the shapes and captions of the exported presentation in PowerPoint as well.

1. Create slides either manually or automatically.
2. Click **Export PPT** from the bottom of the **Presentation** pane.
3. Save the presentation in PPTX format.

## Presentation Mode

Presentation mode saves people the extra steps of exporting and leaving the software. It makes EdrawMax itself a great presentation tool.

Present from the current page and do one of the following:

- Use the shortcut **Shift + F5 (Mac: ⌘ + F5)**
- Select **View > From Current Page**.
- Click the play button on the footer.

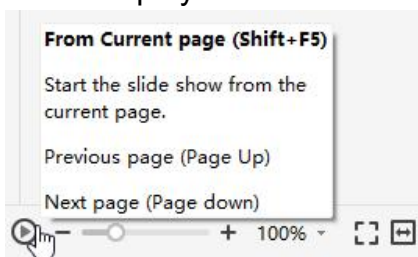

Present from the beginning and do one of the following:

- Use the shortcut **F5 (Fn + F5)**
- Select **View > From Beginning**.

The buttons in the presenter view and their use are explained below:



- **Auto Play** – Automatically display the pages.
- **Arrow Keys** – Move to the previous or next page.
- **Zoom In/Out** – Zoom in or out the page.
- **Fit in View** – Make a drawing fit on the screen.
- **Close** – Close and exit the presentation mode.

# Chapter 5 Symbol

## Select Symbols

### Where to Find Symbols?

Do one of the following to open the menu of libraries and choose symbols you want:

- Select **Symbols > Predefine Libraries** on the ribbon.
- Open the **Libraries** pane on the left side of the canvas.

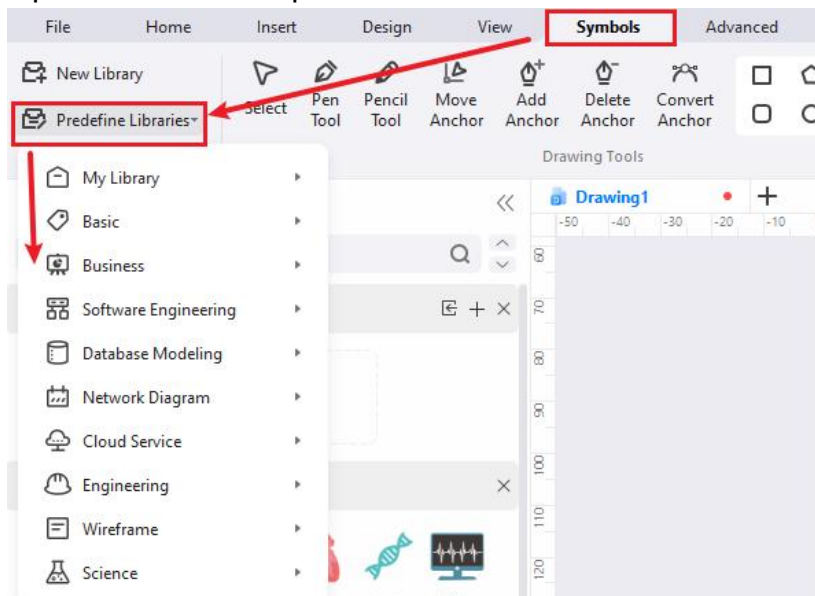

### Select One Symbol

**Note:** If you cannot select, move, resize, or rotate a symbol on your diagram, it might [be protected](#).

1. Open a file or create a new one.
2. Simply drag a symbol from the library and drop them on the drawing page.
3. Select **Home > Select > Select** to ensure the mouse cursor becomes an arrow.

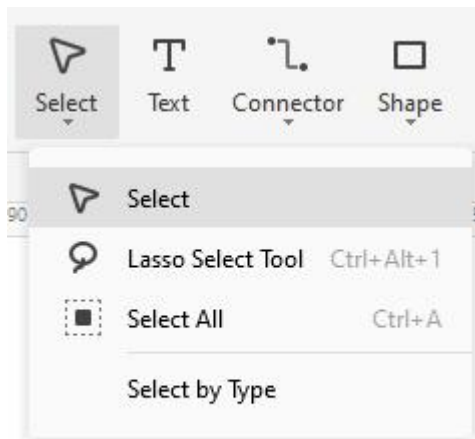

4. Click the symbol, and the cursor turns into a four-headed arrow.

## Select Multiple Symbols

**Note:** The *primary symbol* in the selection box has a thick magenta outline, and you can press the **Tab** key to switch the outline into another symbol.

Do one of the following ways:

- Use **area selection** by clicking and dragging the mouse pointer on the page.

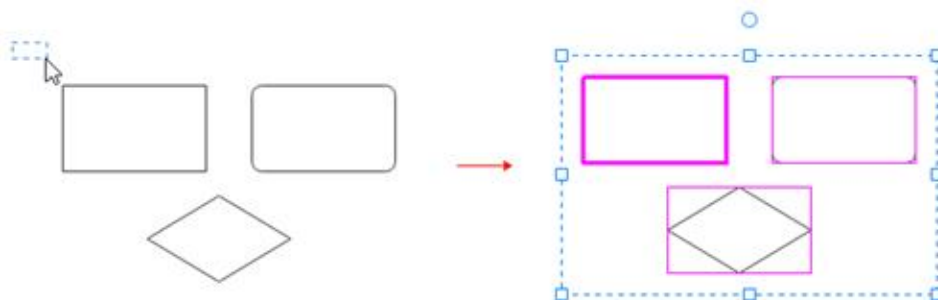

- Select **Home > Select > Lasso Select Tool** or use the shortcut **Ctrl + Alt + 1** (Mac: **⌘ + ⌥ + 1 / cmd + option + 1**) and drag a freeform lasso around the symbols that you want to select. Release the mouse point after you have surrounded symbols. The lasso doesn't need to be completely closed to select symbols.

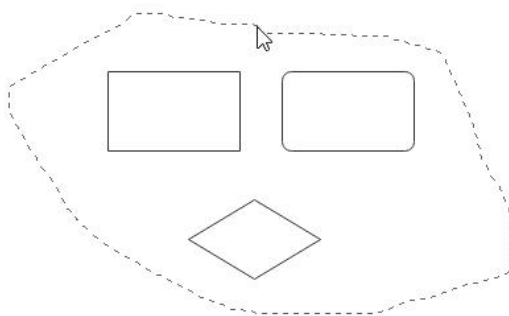

- Hold down **Shift** or **Ctrl** (Mac: **⇧** or **⌘** / **shift** or **cmd**) while clicking symbols to select multiple symbols at once. You can also use these keys to add another shape to a current selection without deselecting.

## Select All Symbols

- Select **Home > Select > Select All**.
- Use the shortcut **Ctrl + A** (Mac: **⌘ + A**)

## Select by Type

1. Select **Home > Select > Select by Type** to open the **Select by Type** dialog box. Check the type of objects you want to select, such as symbols, pictures, or connectors, and then click **OK**.

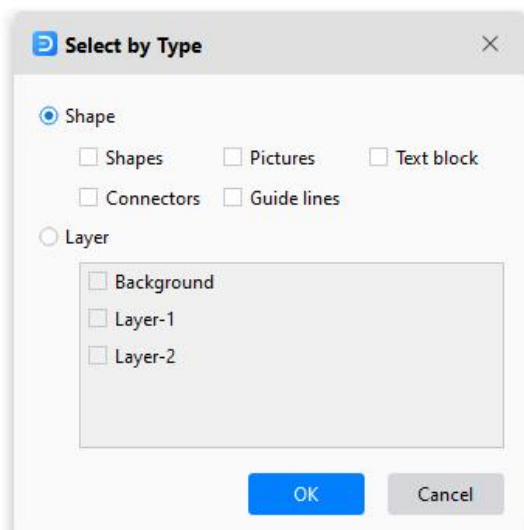

2. Right-click on a blank area on the diagram and choose objects in the context menu.

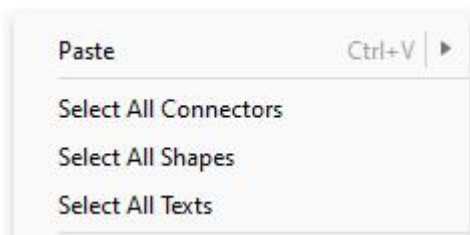

## Deselect Symbols

1. Deselect one or multiple symbols when several are selected: Press **Shift** or **Ctrl** (Mac: **⇧** or **⌘** / **shift** or **cmd**) and click a symbol to cancel its selection.
2. **Deselect all symbols**: Click a blank area on the diagram.

## Move Symbols

There are several ways to move symbols as follows.

- Select a symbol and drag it to a new position.
- Select a symbol and press an arrow key to nudge the symbol.
- Select a symbol, hold down **Shift** and press an arrow key to move a symbol one pixel at a time.
- Select a symbol, select **Home > Size**, and type in new values for **X** and **Y**.

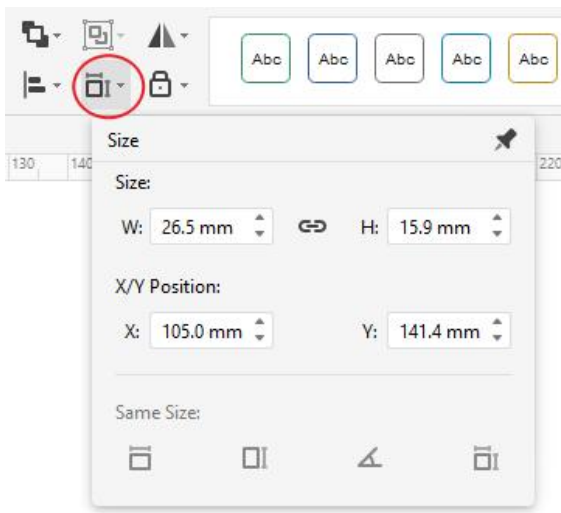

**Tip:** Use **Dynamic Grid** to help align with other symbols when moving a symbol. Select **File > Options > Snap & Glue** and select **Dynamic Grid** to turn it on.



## Resize Symbols

There are several ways to resize symbols as follows.

- Select a symbol and drag one of its control points or end points (for 1D shapes).

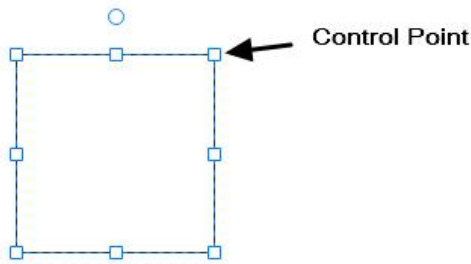

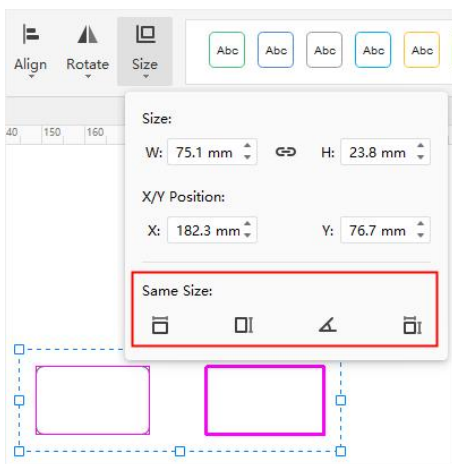

- Select a symbol, select **Home > Size**, and type in new values for **W** (width/length) and **H** (height).
- Select a symbol and drag a corner handle to resize it proportionally.
- Select a symbol and press the **Ctrl** key to resize the symbol without moving its center point.
- Select a symbol and press the **Shift** key to resize the symbol smoothly.

To make several symbols the same size, select the symbols, and the symbol as a reference has a thick magenta border. Select **Home > Size > Same Size**.



**Same Width**  - keep symbols in the same width with the reference symbol.

**Same Height**  - keep symbols in the same height with the reference symbol.

**Same Angle**  - keep symbols in the same angle with the reference symbol.

**Same Size**  - keep symbols in the same size with the reference symbol.

## Rotate and Flip Symbols

There are several ways to rotate and flip symbols as follows.

- Select a symbol and drag the rotation handle.

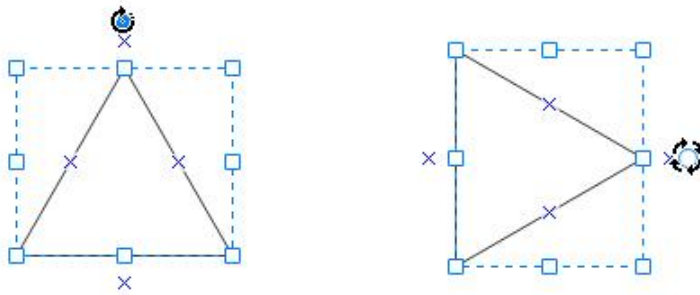

- Select a symbol, select **Home > Rotate**, and select either **Rotate 90° clockwise** (Win: **Ctrl + R**; Mac: **⌘ + R / cmd + R**) or **Rotate 90° counter clockwise** (Win: **Ctrl + L**; Mac: **⌘ + L / cmd + L**).
- Select a symbol, select **Home > Rotate**, and type in new values for **Angle**.
- Select a symbol, select **Home > Rotate > Flip Vertical**.
- Select a symbol, select **Home > Rotate > Flip Horizontal**.

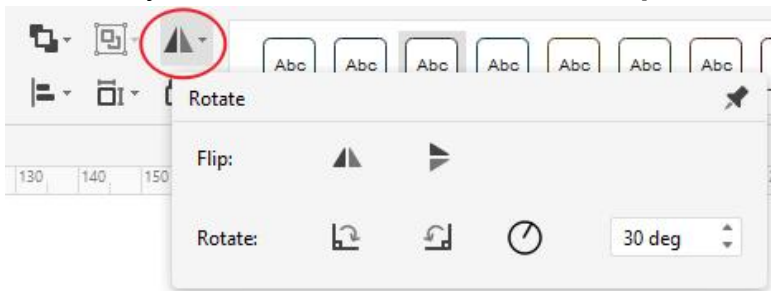

## Connect Symbols

### About Connectors

There are four different types of connectors: **(Right-angle) Connector**, **Curved Connector**, **Straight Connector**, and **Freeform Connector**. The connector means a connection line here.

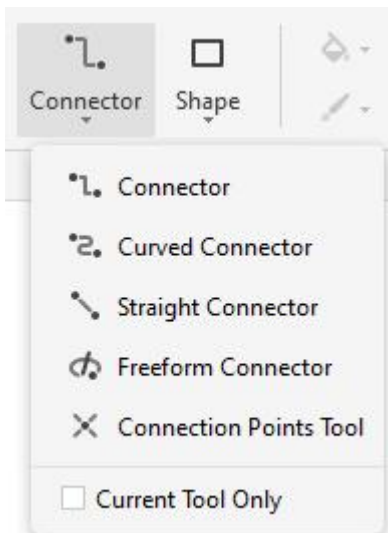

A **connection point** helps "glue" connectors and the symbol. When you move a symbol connected with another one via a connector, the line will be automatically adjusted to keep symbols connected and the end points of the line glued on symbols.

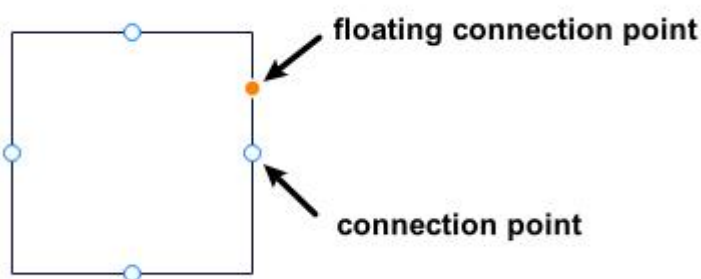

When you draw connectors, you will see two kinds of connection points – **connection points** and **floating connection points**. Both can be used to draw connectors from a symbol. The floating connection point changes position on the edge as the cursor moves, but the connection point is relatively fixed.

## Automatically Connect Symbols

1. Open the libraries of flowcharts, organizational charts, or mind maps and drag a symbol on the canvas.
2. Point to the symbol and position to the arrow or plus that indicates the direction of the next symbol you want to add.



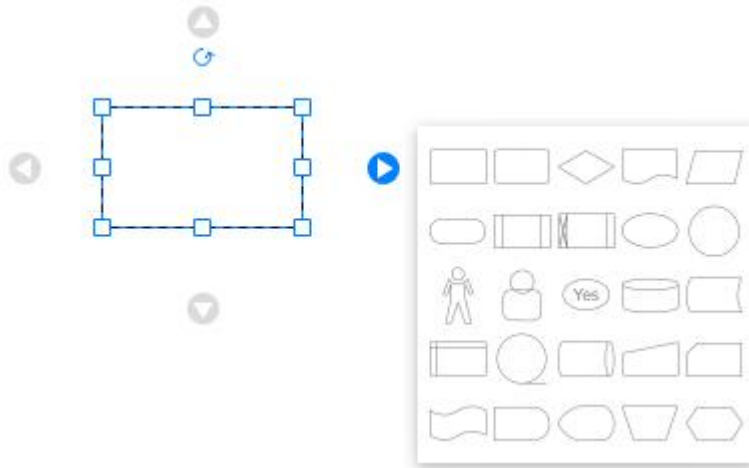

3. Select the symbol you want to add and connect.

## Manually Connect Symbols

1. Select **Home > Connector** and choose a kind of connector. Select **Current Tool Only** to keep drawing connectors.
2. Point to a symbol until you see the connection points around the edge.

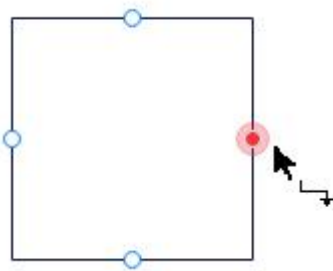

3. Select a connection point and drag to draw a line to a connection point on the symbol you want to connect to. The end points turn red when symbols are connected.

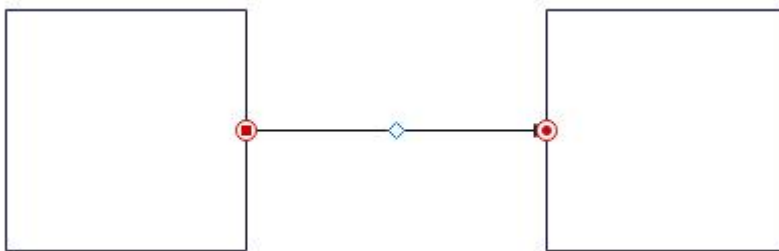

4. Release the mouse button and repeat drawing connectors.
5. Right-click on the canvas and choose **All Connectors** on the context menu to select all connectors.

## Connection Points Tool

### Add a connection point on a symbol

1. Select a symbol.

2. Select **Home > Connector > Connection Points tool**.
3. Position the point where you want to add and click.
4. Press the **Esc** key or select the select tool.

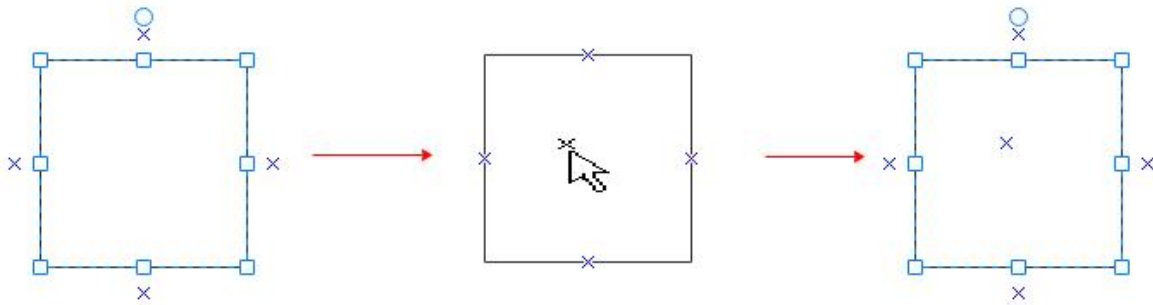

### Delete a connection point

1. Select a symbol.
2. Select **Home > Connector > Connection Points tool**.
3. Click and select the connection point (it turns magenta).
4. Press **Delete**.
5. Press the **Esc** key or select the select tool.

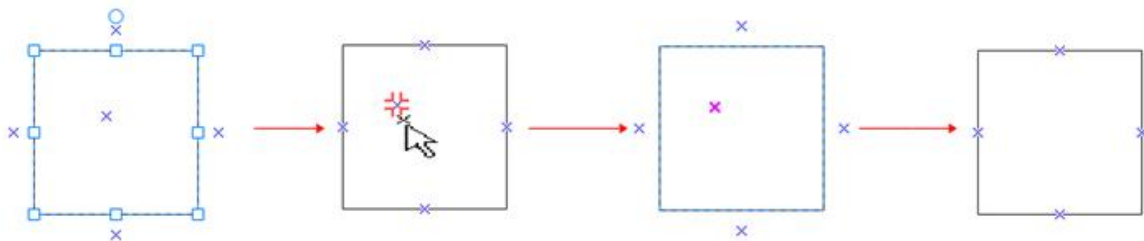

### Move a connection point

1. Select a symbol.
2. Select **Home > Connector > Connection Points tool**.
3. Click to select the connection point (it turns magenta).
4. Drag and move the connection point to the new spot.
5. Release the mouse button.
6. Press the **Esc** key or select the select tool.

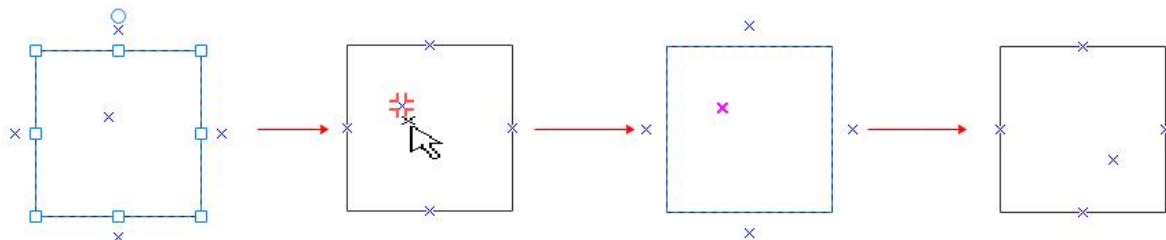

## Replace Symbols

1. Select the symbol you want to replace.
2. Select **Home > Change Shape**  or select **Replace Shape** on the right-click menu.

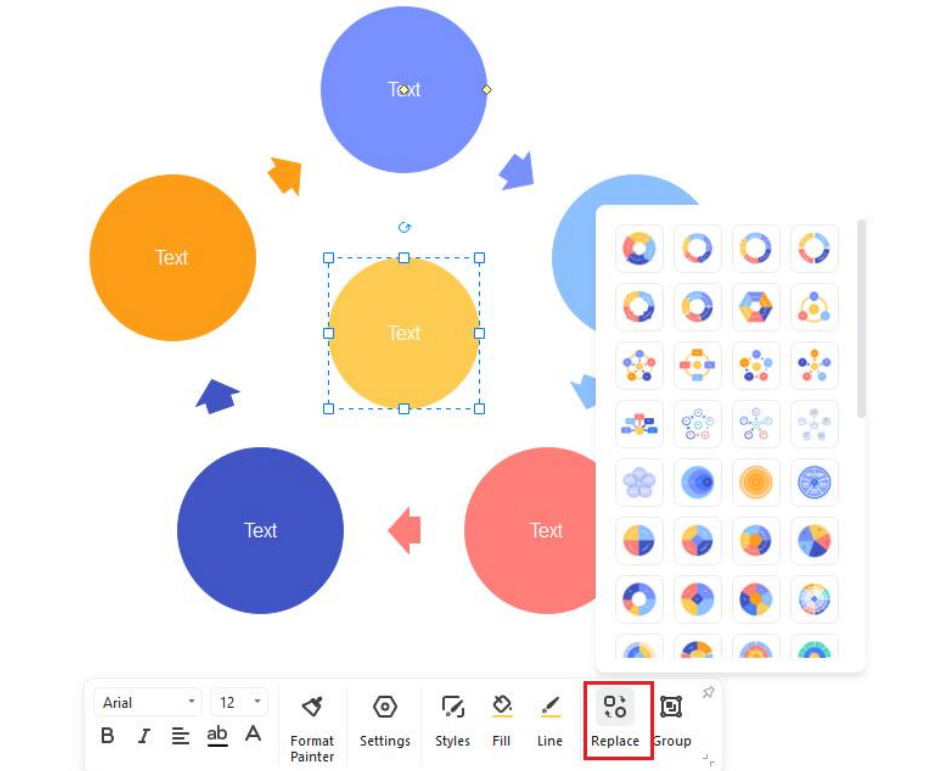

3. Choose the new symbol you need on the sub-menu.
4. All text and formatting applied to the original symbol are applied to the new one.

## Protect Symbols

Symbol protection allows you to prevent changes to symbol attributes and lock symbols from being selected. Thus, your diagrams can be protected from changes.

1. Select a symbol in your diagram.
2. Select **Home > Lock**  to open the protection menu.
3. Select the symbol attributes you want to lock or clear the check marks for the attributes you wish to unlock.

The following table specifies the attributes of a selected symbol that you can lock or prevent changes.

Symbol Attribute	Usage
Width	Lock the selected symbol's width to prevent resizing. To lock a 1D shape like a straight line against rotation, its width must be locked.
Height	Lock height of symbols to prevent resizing, and it's invalid for 1-D shapes.
Aspect Ratio	Lock the ratio between a symbol's height and width so its proportions won't change when you resize it.
X Position	Lock the X (horizontal) position of a symbol so it can't be moved.
Y Position	Lock the Y (vertical) position of a symbol so it can't be moved.
Rotation	Lock a symbol so that you can't rotate it. You can still rotate 1D shapes by dragging their end points, and you must lock their width to prevent rotation.
Begin Point	Lock the beginning point of a 1D shape to a specific location so it can't be moved.
End Point	Lock the end point of a 1D shape to a specific location so it can't be moved.
Ungroup	Lock the grouped symbol so that you can't ungroup it using the <b>Ungroup</b> command.
Edit Text	Lock the text in the symbol so that it can't be edited.
From Selection	Lock the symbol so it can't be selected.
From Deletion	Lock the symbol so it can't be deleted.
From Connector	Lock the symbol so it can't be connected.
Format	Lock the symbol so it can't be formatted.
From Group Formatting	Lock the formatting (color, fill, line, and shadow) in sub-symbols to not change if the grouped symbol is formatted. You can still format a sub-symbol by selecting it.
From Group Fill	Lock the fill in sub-symbols so that they do not change if the grouped symbol is formatted. You can still format a sub-symbol by selecting it.
From Theme	Lock the symbol, so it doesn't change if a theme is applied.
From Outline	Lock floating connection points of a symbol so they can't be glued.
None	Click <b>Unlock All</b> on the menu.

## Reorder Overlapping Symbols

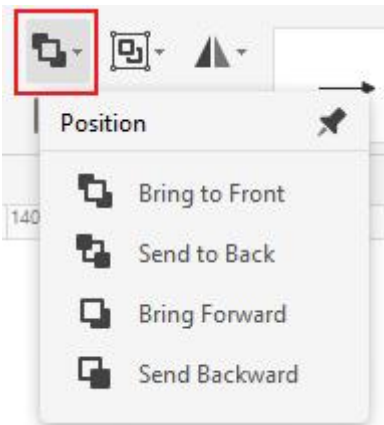

Do one of the following and bring the selected symbol in front of all other symbols.

- Go to **Home > Position > Bring to Front**;
- Win: Press **Ctrl + Shift+ ]** (right bracket).  
Mac: Press **⌘ + ⌃ + ]** (right bracket).
- Click **Bring to Front > Bring to Front** on the right-click context menu.

Do one following and send the selected symbol behind all other symbols.

- Go to **Home > Position > Send to Back**;
- Win: Press **Ctrl + Shift + [** (left bracket).  
Mac: Press **⌘ + ⌃ + [** (left bracket).
- Click **Send to Back > Send to Back** on the right-click context menu.

Do one of the following and bring the selected symbol forward.

- Select **Home > Position > Bring Forward**;
- Win: Press **Ctrl + ]** (right bracket).  
Mac: Press **⌘ + ]** (right bracket).
- Click **Bring to Front > Bring Forward** on the right-click context menu.

Do one of the following and send the selected shape backward.

- Go to **Home > Position > Send Backward**;
- Win: Press **Ctrl + [** (left bracket).  
Mac: Press **⌘ + [** (left bracket).
- Click **Send to Back > Send Backward** on the right-click context menu.

## Align Symbols

The commands align symbols evenly spaced. Do as following procedures and choose an alignment direction.

1. Select the primary symbol that you want the other symbols to align to.
2. Press and hold **Shift** or **Ctrl** (Mac: **⌘** or **⌘** / **shift** or **cmd**) while selecting the other symbols you want to align with the primary symbol.

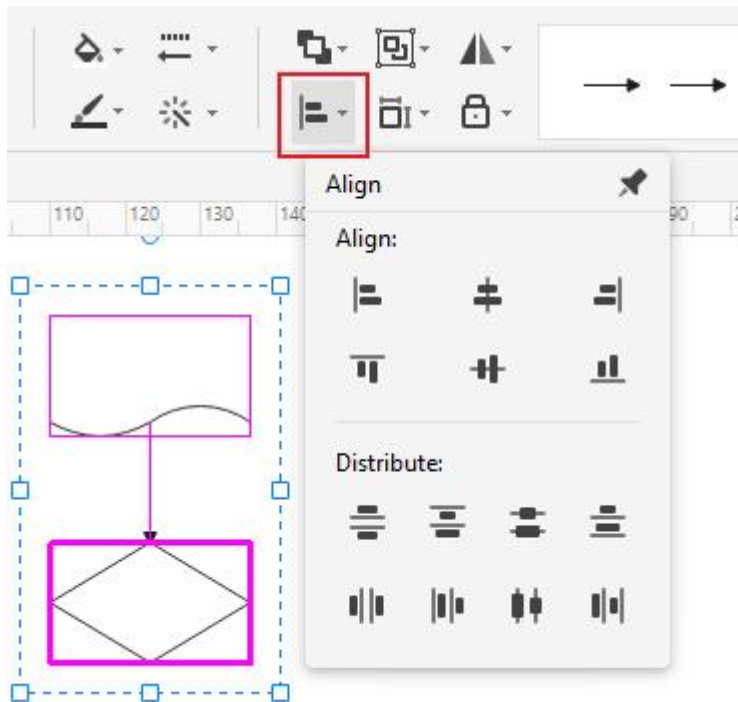

3. You can press **Tab** to switch the primary symbol to other selected symbols.
4. Click **Home > Align** and select the desired alignment direction.

## Distribute Symbols

**Note:** If you don't select three or more symbols, the commands for distributing symbols are unavailable.

1. Select three or more symbols by holding down **Shift** or **Ctrl** (Mac: **⌘** or **⌘** / **shift** or **cmd**) while clicking symbols.
2. You can press **Tab** to switch the primary symbol to other selected symbols.
3. Click **Home > Align** and select a distribution option.
  - For vertical distribution, the boundaries are defined by the top and bottom shapes in the selection box.
  - For horizontal distribution, the boundaries are defined by the leftmost and rightmost shapes in the selection box.

## Group and Ungroup Symbols

Select two or more symbols by holding down **Shift** or **Ctrl** (Mac: **⌘** or **⌘** / **shift** or **cmd**) while clicking symbols or using the area selection tool. Do one of the following and group symbols.

- Select **Home > Group > Group**.
- Right-click a selected symbol and click **Group > Group** on the menu.

Select the group and do one of the following to ungroup symbols.

- Select **Home > Group > Ungroup**.
- Right-click the group and click **Group > Ungroup** on the menu.

## Center Symbols

Do as following and center symbols on the drawing page.

1. Select symbols you want to center by holding down **Shift** or **Ctrl** (Mac: **⌘** or **⌘** / **shift** or **cmd**) while clicking symbols or using the area selection tool.
2. Right-click the symbol(s) and select **Center** on the menu.

**Note:** If there is only one symbol, it will be moved to the center of the page. If there are several shapes, they will act as a group, and the center point of the group will move to the center of the page.

## Draw Shape Tool

### Draw Shape Tool on Home Tab

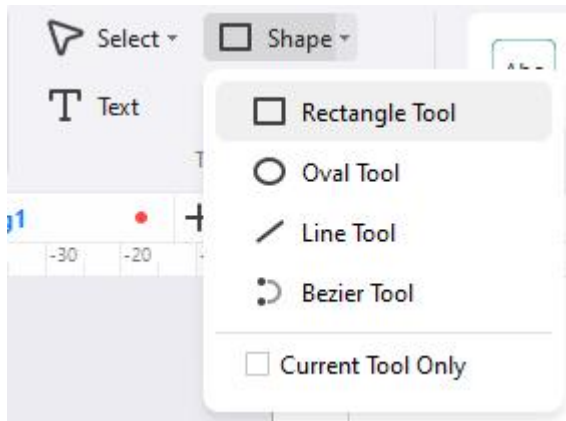

You can draw custom shapes using the rectangle, oval, line, and Bezier tools on the **Home** tab of EdrawMax. The shapes will contain default text blocks and connection points.

1. Select **Home > Shape** and click the tool for the kind of shape you want to draw.





2. Drag on the canvas to draw the shape.
3. Select **Current Tool Only**, and you will keep drawing one kind of shape continuously.
4. Click **Select** on the ribbon to stop drawing and turn the cursor into the arrow.

The following list specifies the usages of tools and what the cursor will be like.

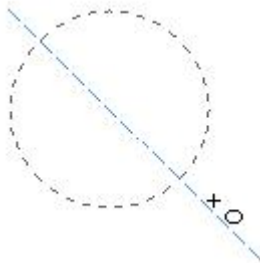
- **Rectangle Tool:** the cursor will be  ; you can draw rectangles or squares by dragging diagonally with the tool.
- **Oval Tool:** the cursor will be  ; you can draw ovals or circles by dragging diagonally with the tool.



- **Line Tool:** the cursor will be  ; the line will have a default arrow at the end, and you can change the styles.
- **Bezier Tool:** the cursor will be  ; the line will have a default arrow at the end, and you can change the styles. You can drag the end points of the curve to change the direction. The yellow squares are used for changing the radian of the curve.



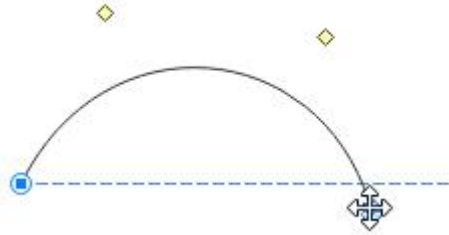

## Draw Shape Tool on Symbols Tab

You can draw more custom-sized shapes with the Draw Shape Tool on the **Symbols** tab of EdrawMax. The shapes **will not** contain any default text block or connection points.



1. Select **Symbol** and click the tools next to **Convert Anchor** for the kind of shape you want to draw.

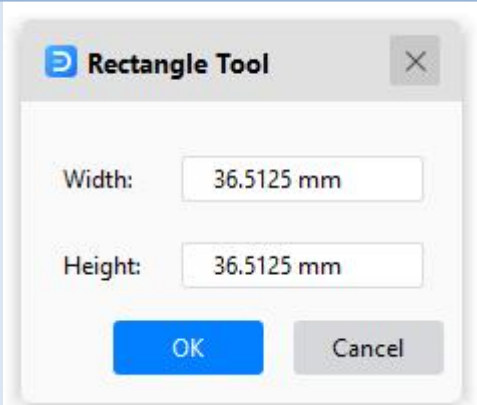

2. The cursor will be . Drag on the canvas to draw the shape.
3. Double-click where the shape will be to open the **property dialog box**. You can type in values for width, height, length, angle, etc.
4. Click **Select** on the ribbon or press **Esc** to stop drawing and turn the cursor into the arrow.

The following table specifies the usages of tools and what property dialog boxes would be like.

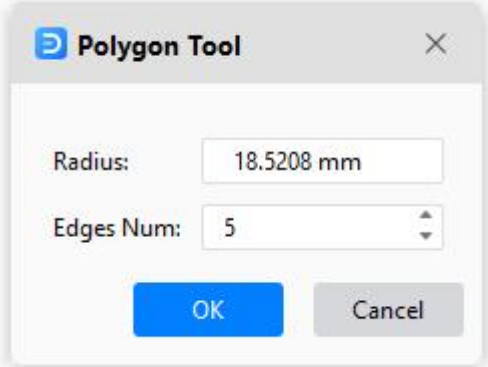
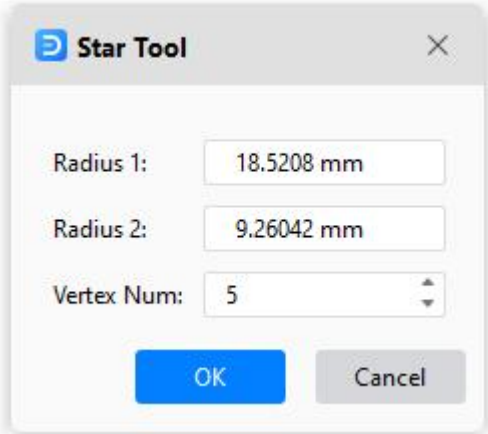
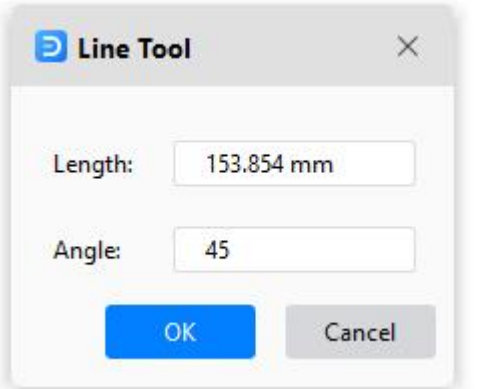
Shape Tool	Usage	Dialog Box
Rectangle Tool	<p>Draw rectangles.</p> <p>Draw squares by holding down <b>Shift</b> (Mac: ) while dragging on the canvas.</p>	

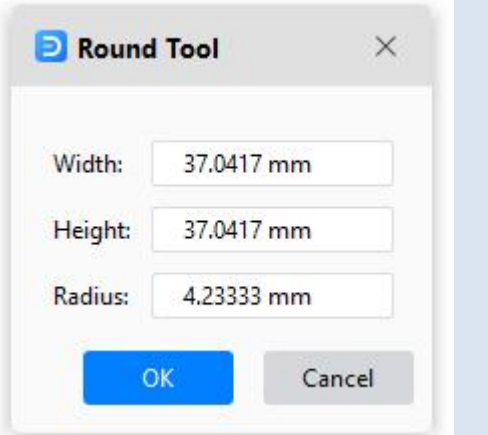
<p>Polygon Tool</p>	<p>Draw polygons.</p>	
<p>Star Tool</p>	<p>Draw stars.</p>	
<p>Line Tool</p>	<p>Draw straight lines.</p>	
<p>Round Tool</p>	<p>Draw rounded rectangles. Draw rounded squares by holding down <b>Shift</b> (Mac: ) while dragging on the canvas.</p>	

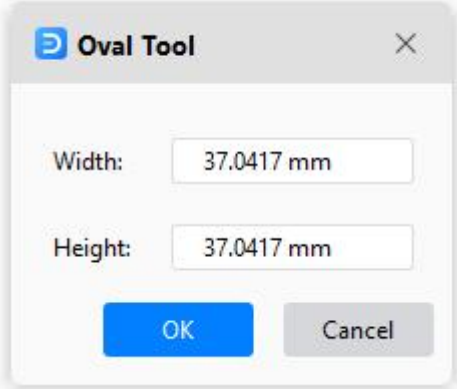
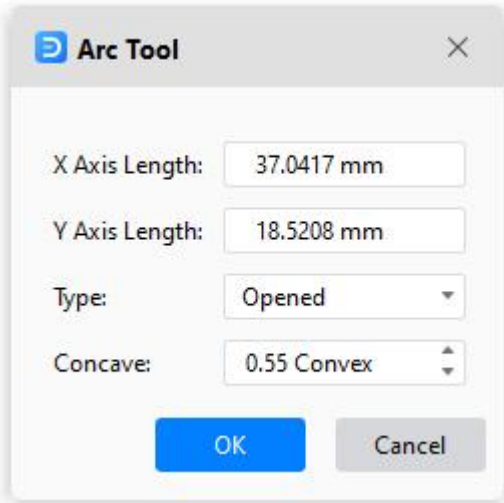
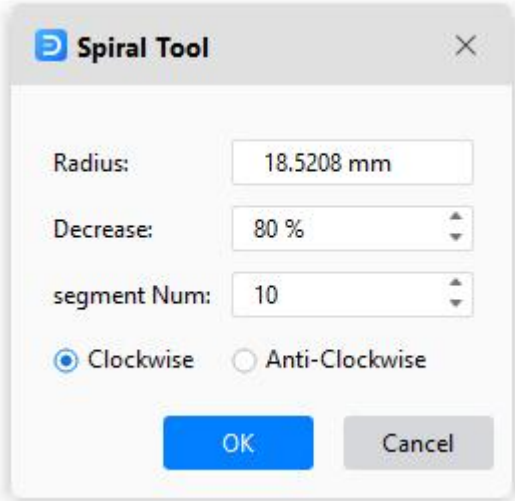
<p>Oval Tool</p>	<p>Draw ovals.</p> <p>Draw circles by holding down <b>Shift</b> (Mac: ) while dragging on the canvas.</p>	
<p>Arc Tool</p>	<p>Draw arcs or curved lines.</p>	
<p>Spiral Tool</p>	<p>Draw spirals.</p>	

## Path and Anchor Point

Before you use the **Pencil** or **Pen** tools, you need to know what paths and anchor points are, and then you will have more control over a graphic project.

## About Path

A **path** consists of one or more straight or curved segments. A basic path can be either open, like a wavy line, or closed, like a circle. You will see anchor points at the beginning and end of each segment. The starting and ending anchor points are called "**end points**" for an open path.

You change the direction and curvature by dragging the path's anchor points, the direction points at the end of direction lines that show at anchor points, or the path segment itself.

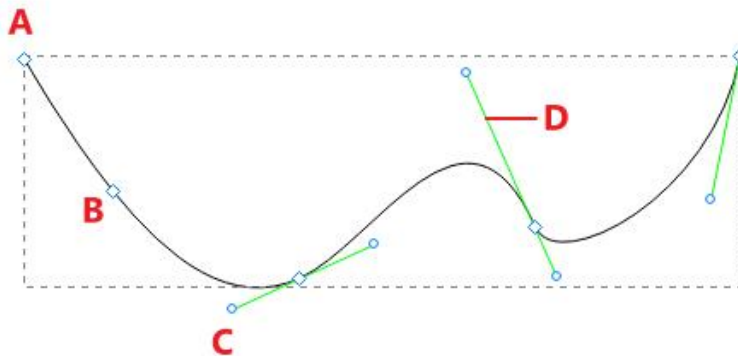

**A.** End point **B.** Anchor point **C.** Direction point **D.** Direction line

There are two types of anchor points: **corner points** and **smooth points**. You can draw paths using any combination of corner and smooth points. At a **corner point**, a path can change direction unexpectedly. At a **smooth point**, a path continues as one smooth line.

Corner points can connect straight segments, curved segments, or a combination of the two. While smooth points always connect curved segments.

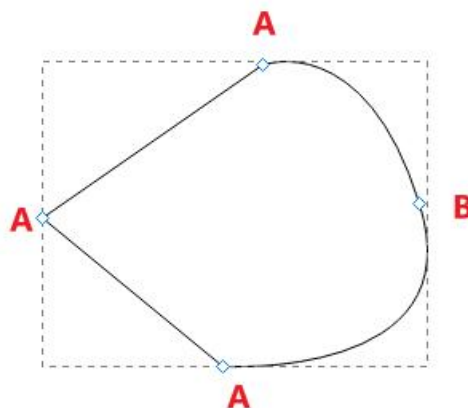

**A.** Corner point **B.** Smooth point

## Move Anchor Points

1. Select **Symbols > Move Anchor** or press **Ctrl + M** (Mac: **⌘ + M / cmd + M**);

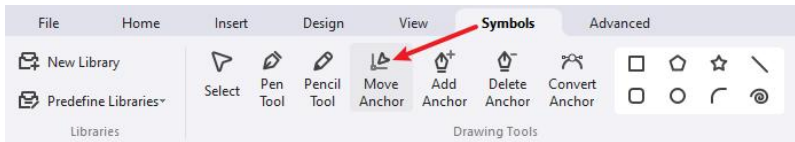

2. Select the path or shape to see all anchor points.
3. Click on the anchor point that you want to move.
4. Drag the point and move to another spot.

## Add Anchor Points

1. Select **Symbols > Add Anchor**;
2. Select the path or shape to see all anchor points.
3. Move the cursor to the spot where you want the new anchor point to appear.
4. Click on the spot and add a new anchor point.

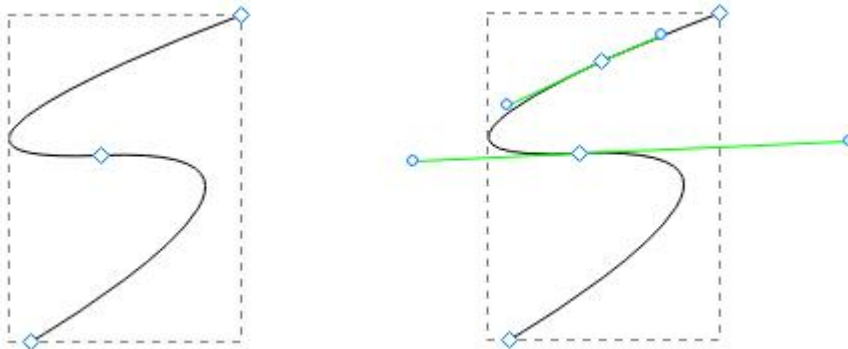

## Delete Anchor Points

1. Select **Symbols > Delete Anchor**;
2. Select the path or shape to see all anchor points.
3. Click on the unneeded anchor point, and it will disappear on the path.

## Convert Anchor Points

Using the **Convert Anchor Point** tool, you can convert anchor points on a path between corner points and smooth points precisely.

1. Select **Symbols > Convert Anchor** or press **Ctrl + Shift + M** (Mac: **⌘ + ⬆ + M**);
2. Select the path or shape to see all anchor points.
3. Move the cursor to the anchor point you want to convert and do one of the following:
  - **Convert a corner point to a smooth point:** Drag the direction point out of the corner point.

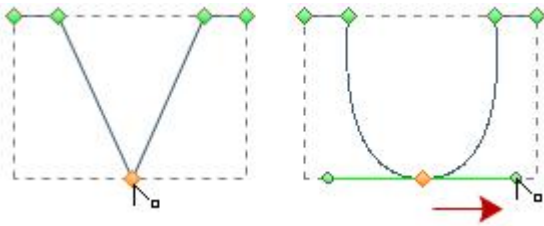

- **Convert a smooth point to a corner point without direction lines:** Click the smooth point.

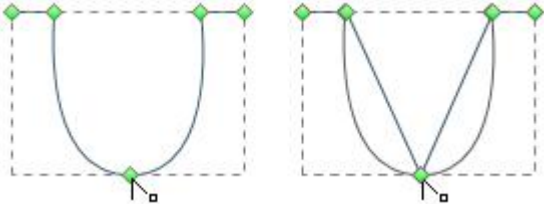

- **Convert a smooth point to a corner point with independent direction lines:** Drag either direction point.

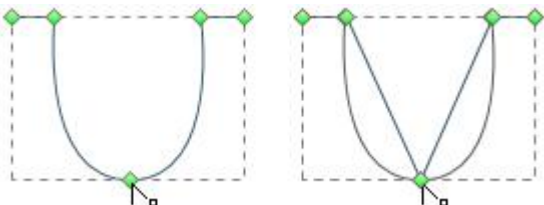

- **Convert a corner point without direction lines to a corner point with independent direction lines:** Firstly, drag a direction point out of a corner point (making it a smooth point with direction lines). Then, release the mouse only, but don't release any keys you may have pressed to activate the **Convert Anchor**. Last, drag either direction point.

## Pencil Tool

The **Pencil** tool lets you draw custom shapes as if you were drawing with a pencil on paper. It is useful for fast sketching or creating a hand-drawn look.

1. Select **Symbol > Pencil Tool**. The cursor will look like a pencil.

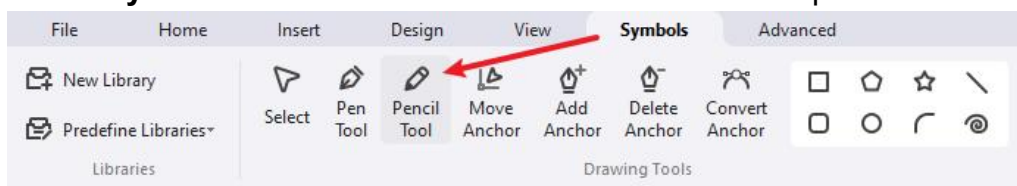

2. Drag on the canvas to draw the first segment of the shape.
3. After you draw the first segment, there display [anchor points](#).
4. Click the anchor point at the end of the first segment you added, and drag to draw the second segment.
5. Repeat the above process to get enough segments.
6. To close the shape, drag the end point of the last segment that you create over the anchor point at the beginning of the first segment.

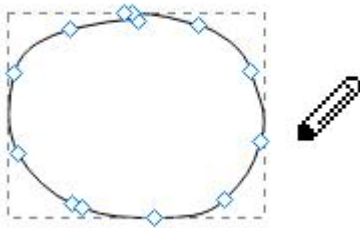

- Click **Select** on the ribbon or press **Esc** to stop drawing and turn the cursor into the arrow.

**Note:** Only a closed shape can be applied to fill colors.

## Pen Tool

The **Pen** tool allows you to create shapes or vector graphics with freeform paths. You can practice and duplicate most paths found in the real world by using the **Pen** tool.

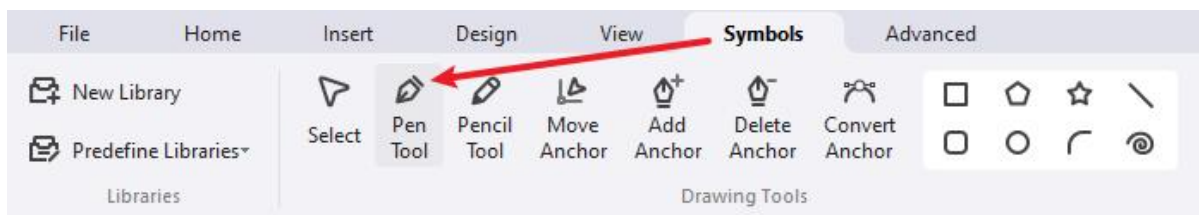

## Draw Straight Lines

- Select **Symbol > Pen Tool**. The cursor will look like a pen.
- Click and release on the canvas to create the first anchor point (do not drag).
- Move the pen, and you'll see a preview of the path you create. The first segment you draw will not be visible until you click a second anchor point.
- Keep clicking and releasing to create paths until you get what you want.

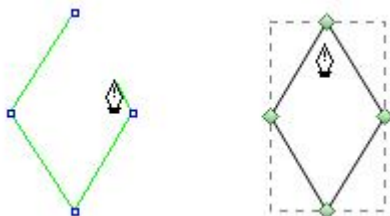

- Complete the path by doing one of the following:
  - Move the pen over the first anchor point. Click or drag to close the path.
  - To leave the path open, double-click anywhere on the canvas, select a different tool or choose **Select**.

## Draw Curves

You create a curve by adding an anchor point where a curve changes its direction and dragging the direction lines that shape the curve. The length and slope of the direction lines determine the shape of the curve.

Curves are easier to edit, display, and print if you draw them using as few anchor points as possible. Too many points can also introduce unwanted bumps in a curve. Instead, it's a good way to draw widely spaced anchor points and practice shaping curves by adjusting the length and angles of the direction lines.

1. Select **Symbol > Pen Tool**. The cursor will look like a pen.
2. Position the pen where you want the curve to begin. Hold down the mouse button, and the first anchor point will appear.
3. Drag to extend direction lines. In general, you can extend the direction line to one-third of the distance to the next anchor point you plan to draw. You can adjust one or both sides of the direction line later.
4. Release the mouse button but note that the first segment will not be visible until the second anchor point is drawn.
5. Position the pen where you want the curve to end, and do one of the following:

- To create a **C-shaped curve**, drag in the direction opposite to the previous direction line. Then release the mouse.

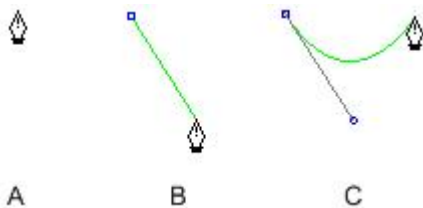

**A.** Position pen tool; **B.** Drag the direction line; **C.** Release the mouse and move to the next point position

- To create an **S-shaped curve**, drag in the same direction with the previous direction line. Then release the mouse.

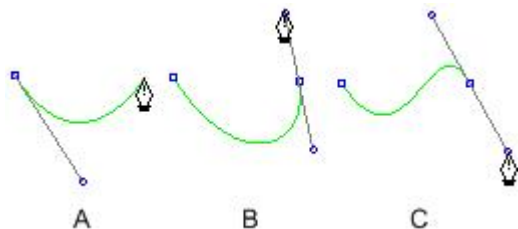

**A.** Create the second point; **B.** Drag away from the previous direction line to create a C curve; **C.** Drag in the same direction with the previous direction line to create an S curve

6. Continue dragging the **Pen** tool from different locations to create additional smooth curves. Note that you need to place anchor points at the beginning and end of each curve, not at the tip of the curve.
7. Complete the path by doing one of the following:



- Move the pen over the first anchor point. Click or drag to close the path.
- To leave the path open, double-click anywhere on the canvas, select a different tool or choose **Select**.

## Draw Straight Lines Followed by Curves

1. Select **Symbol > Pen Tool**.
2. Use the pen to click and create a straight segment.
3. Position the pen over the end point that the curve starts. Click the anchor point and drag the direction line that appears.
4. Position the pen where you want the next anchor point. Click and drag the new anchor point to complete the curve.

## Draw Curves Followed by Straight Lines

1. Select **Symbol > Pen Tool**.
2. Use the pen to drag and create the first smooth point of the curved segment and release the mouse button.
3. Reposition the pen where you want the curved segment to end, drag to complete the curve, and release the mouse button.
4. Position the pen over the end point that the straight segment starts, move, and click to complete the straight segment.

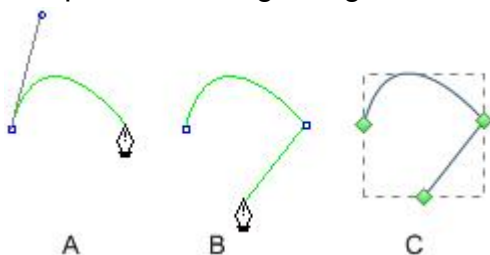

**A.** Complete the curve; **B.** Move to the straight segment end; **C.** Finish drawing

## Create Your Own Symbols

### Make New Symbols

If the built-in symbol library in EdrawMax can't meet your needs, let's start making your own symbol! Navigate to the Symbols tab and select 2 or more shapes. Some options are used for making combined shapes.

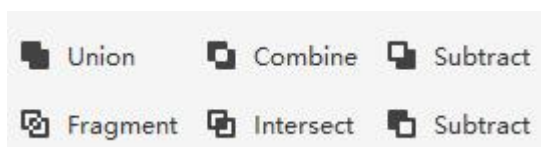

- **Union:** Make a symbol from several overlapping shapes, and the lines in the overlapped area will disappear.

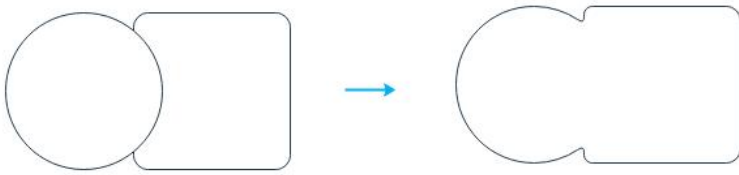

- **Combine:** Make a symbol from several overlapping shapes, and you can still see where these shapes are overlapped.



- **Subtract (on the first line):** Create a symbol by subtracting the overlapped area from the selected upper shape.



- **Fragment:** Divide multiple shapes into smaller parts based on intersecting lines or overlapping areas.

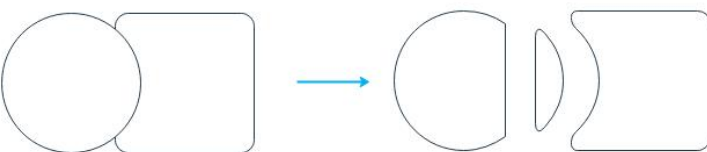

- **Intersect:** Create a symbol from the area where multiple selected shapes overlap.



- **Subtract (on the second line):** Create a symbol by subtracting the overlapped area from the selected lower shape.



## Add Text Blocks

Select the symbol and do one of the following.

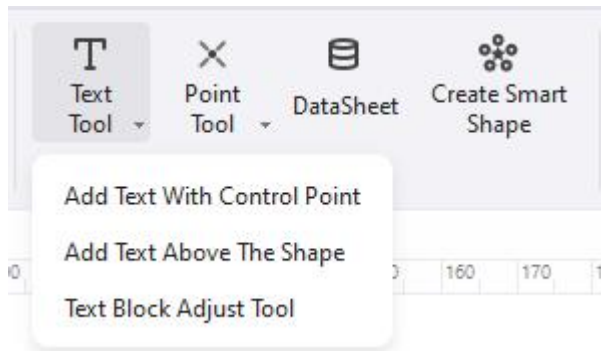

- Select **Symbols > Text Tool > Add Text with Control Point**, double-click the symbol, and a text block shows below. You can move the text box by dragging the **control point**.

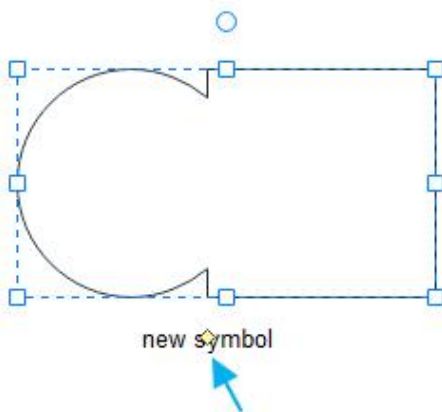

Control Point

- Select **Symbols > Text Tool > Add Text Above the Shape**; this option will add a text block above the symbol. You will not see the symbol, but the text block when you type words.
- Select **Symbols > Text Tool > Text Block Adjust Tool**, and you can move, rotate and resize the text block on the symbol.

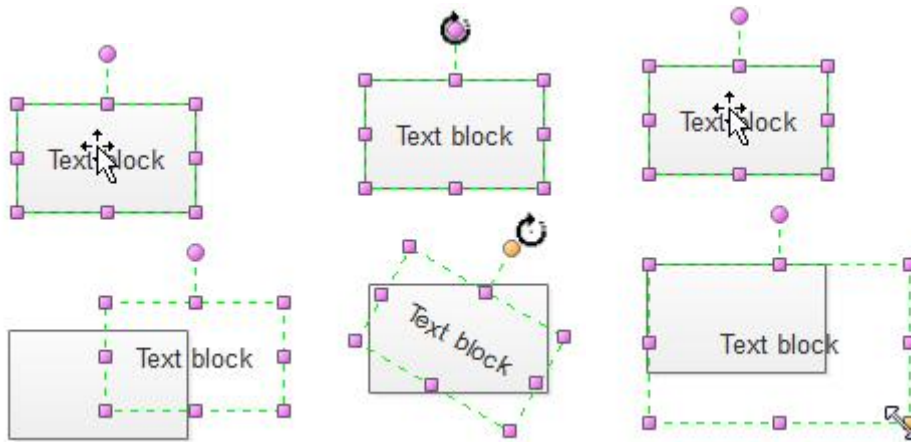

## Add Connection Point

Select the symbol and do one of the following.

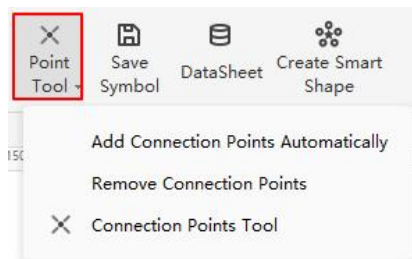

- Select **Symbols > Point Tool > Add Connection Points Automatically**, and four basic connection points will be added to the symbol.

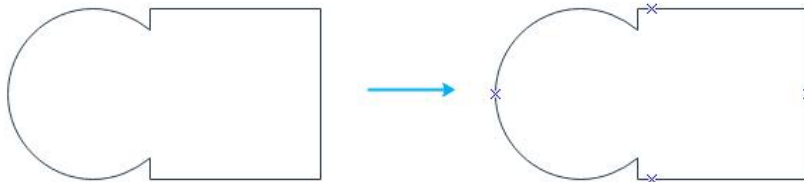

- Select **Symbols > Point Tool > Remove Connection Points**. All connection points on the symbols will be removed.
- Select **Symbols > Point Tool > Connection Points Tool**, the cursor will look like a connection point, and you can choose to add additional connection points on the symbol.

## Save Symbols

Don't forget to save your symbol when it is done!

1. Select **Symbols > Save Symbol**.
2. The window for saving the symbol will open.
3. Name the symbol and click **Save**.
4. You will see a **.ede** file and a **png** file to save symbols. You can also import them into your symbol library.

## Create Your Own Library

You can create your symbol library and add your favorite symbols to your editable libraries!

1. Select **Symbols > New Library**.
2. There will be a new blank library on the left library pane. (Rename it directly)

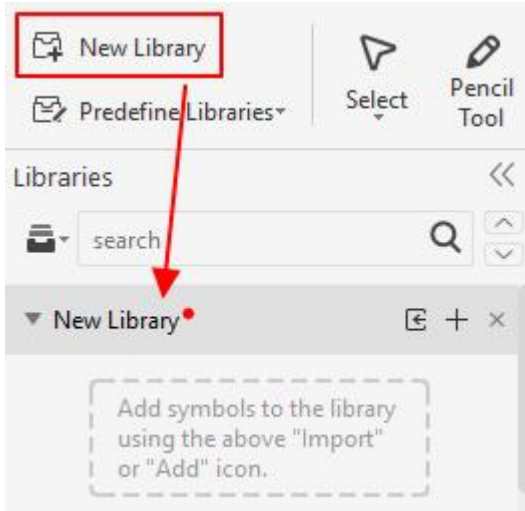

3. Import your symbols by doing one of the following.
  - Right-click the title and select **Import Symbol** on the context menu.

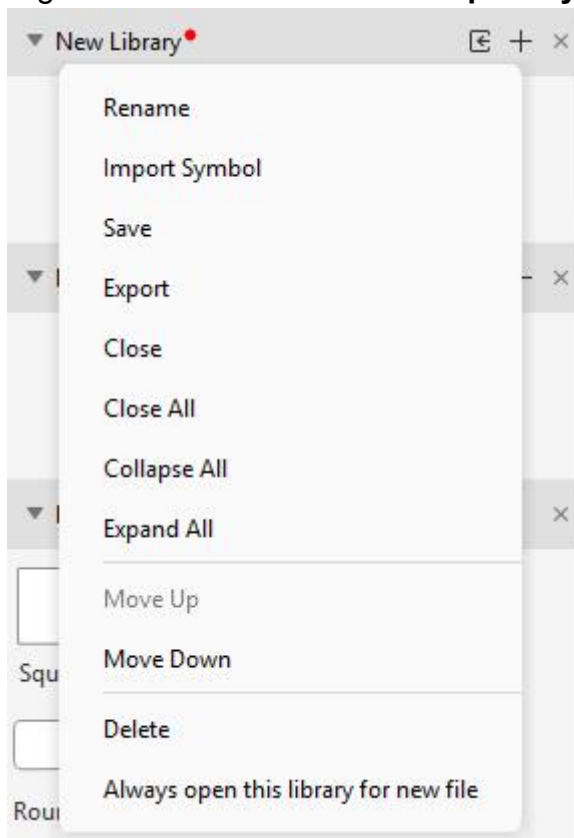

- Click the **Import Symbols** icon on the title bar to open the **Import Symbols** dialog box. In the **Import Symbols** dialog box, type the symbol's name, browse and select its .ede file and icon (.png). Click **OK**, and the new symbol will be added to the library. You can also import **images**, **SVG files**, and **EDT/EDL** files.

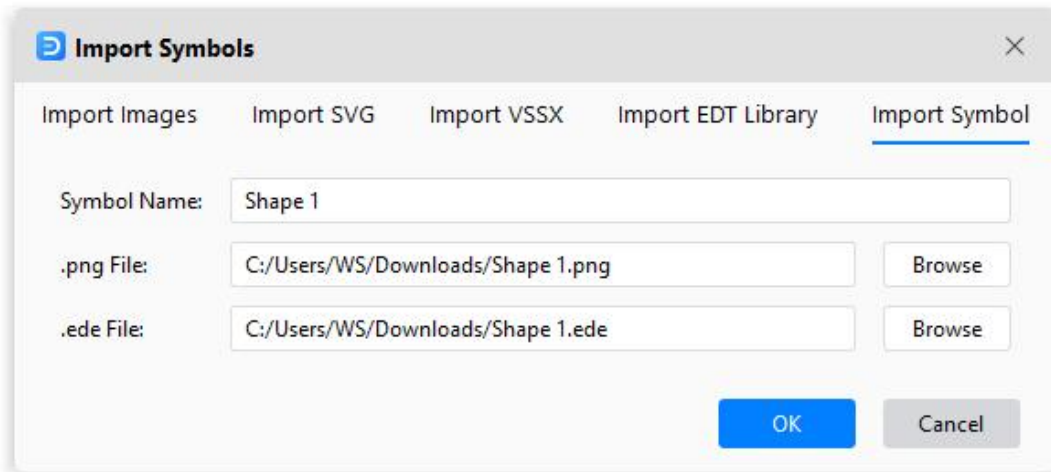

- Alternatively, another simple way is to add your symbols into the custom symbol library. Select the symbol, image, or SVG file on the canvas. Click the **Add** icon on the library pane.

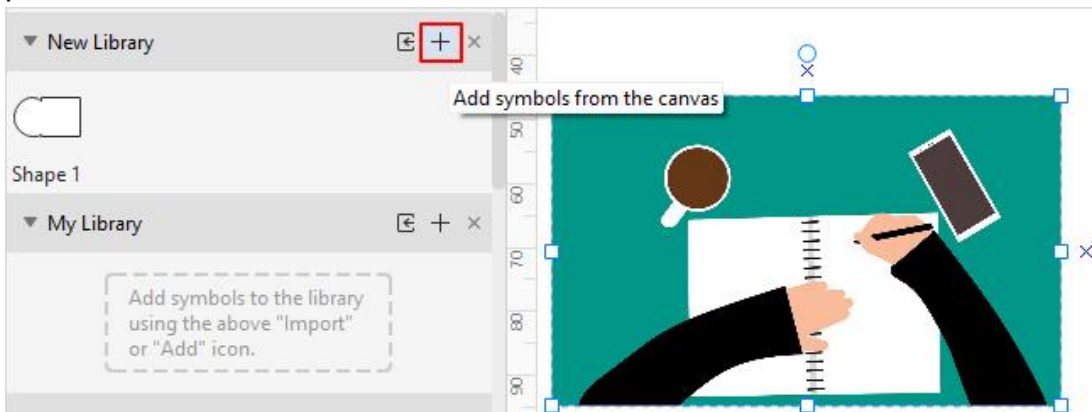

Here, you can easily add all the symbols you want into your library!

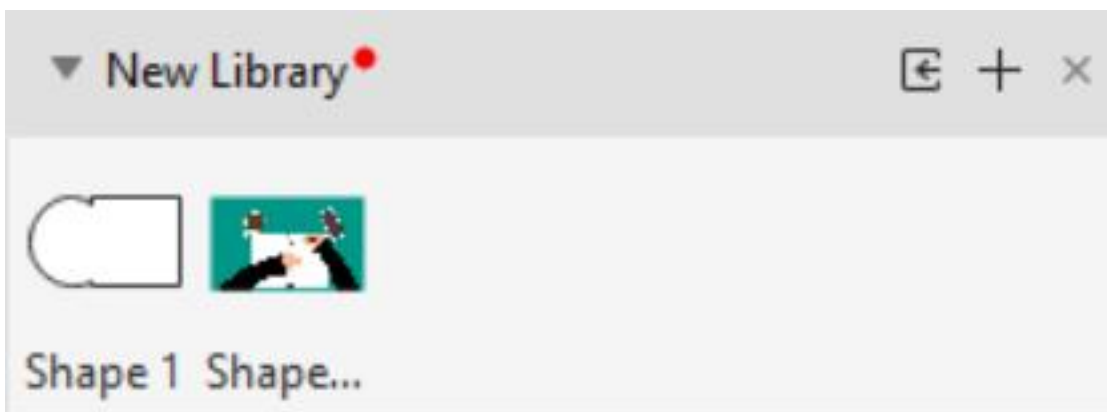

- Right-click the title of **New Library**, and you can save and export the library as .edt files.
- When you open EdrawMax, you will see your custom symbol library on the top of the pane so that you can put your commonly-used symbols into your library.

## Smart Shape

### Create Smart Shapes by Yourself

EdrawMax makes it easy to create original smart shapes to enhance creativity in your diagramming, except for using built-in smart shapes.

1. Choose a basic shape and select **Symbols > Create Smart Shape**.

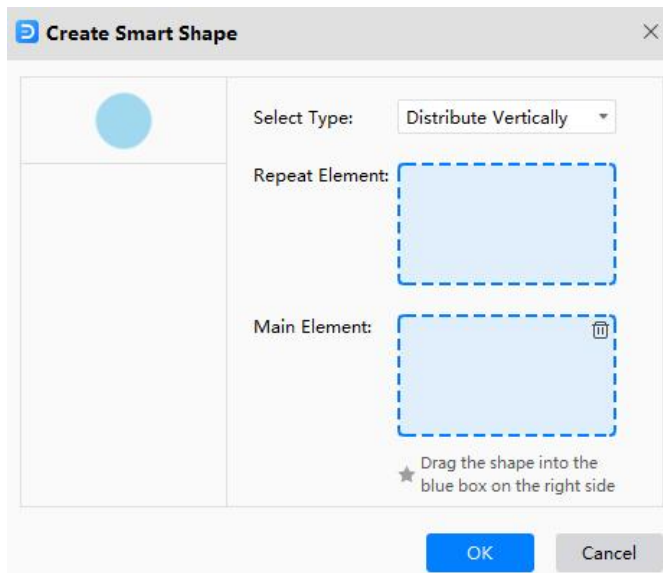

2. Drag the selected symbols in the boxes, respectively. The **Repeat Element** means that the circle will be used several times. The **Main Element** will serve as the center in the formed smart shape.
3. Choose a custom type for your smart shape. Here I select the fourth one – **Center surround**.

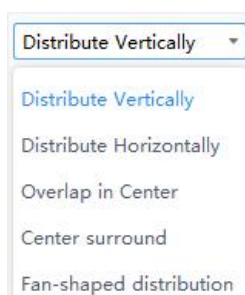

4. The new smart shape will look like the right part in the picture below. You can save it in your library when you finish making your smart shape.

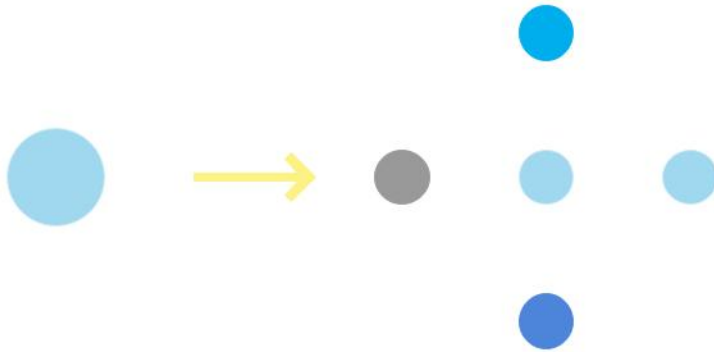

## Shape Data

You will use this feature to add data or important information to symbols, which is useful for providing details. Shape data can show steps in a process or pieces of equipment in the diagram without filling up the diagram with text.

1. Select a symbol on the drawing page.
2. Right-click on the symbols and select **Shape Data** on the menu or press **F8**.
3. The **Data Properties** pane opens.

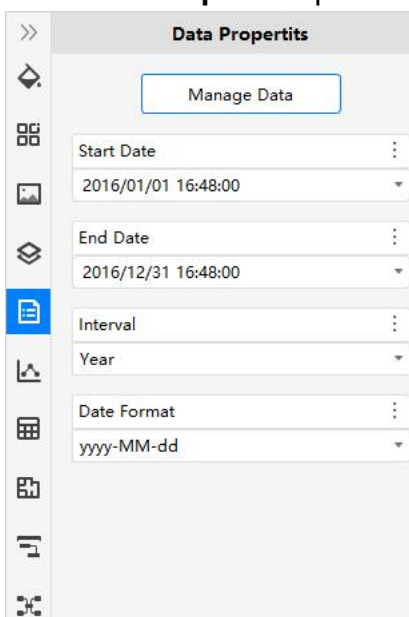

4. Click **Manage Data**, and the **Define Shape Data** window opens. Then you can build or change a data set for the selected symbol.



**Define Shape Data** [X]

Name:  Decimal places:

Type:   Use thousand separator

Format:  Unit/Currency

Value:

Binding text:

Prompt:

Data:

Name	Type	Format	Value	Prompt
Start Date	DateTime	dd/MM/yyyy	42370.7	
End Date	DateTime	dd/MM/yyyy	42735.7	
Interval	List	Year;Quarter;...	Year	
Date Format	List	EDDATEFORM...	yyyy-MM-dd	

# Chapter 6 Format

## Format Symbols

Select the symbol you want to format and do one of the following.

- Select style options on the **Home** tab.



- **Fill** - Select a color or no fill to fill the symbol.
  - **Line Style** – Select the line thickness or type of line.
  - **Line** – Select the line color.
  - **Quick formatting** – Quickly change the appearance of symbols in one click.
  - **Quick Style** - Select a line and fill combination.
- Select a style option on the menu of the color bar. Position the cursor on the color and click to change the colors of fill, line, or both.



- Select Home > Styles > Dialogue launcher button to open the Style pane.

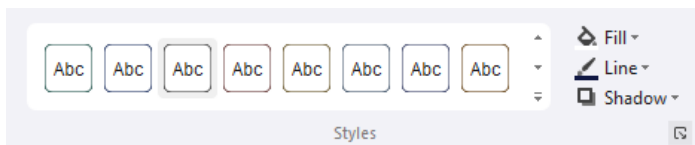

- **Fill** – Fill the selected symbol with a solid color, gradient, picture, or texture.
  - **Line** – Pick the color, width, and line style for the symbol's outline.
  - **Shadow** – Apply the shadow to the selected symbol.

## Format Text

Add text to the drawing page and do one of the following.

- Double-click the area where you want to add text and type the text.

- Select **Home > Text**, drag to draw a text box, and type the text.

For adding text to symbols, see [Add Text Blocks](#). Use these steps to set text formatting in a symbol, text box, or drawing page.

## Format Text in One Symbol

1. Double-click the text you want to edit.
2. Select the text or specific sections you want to apply format changes. The selected text will be highlighted.
3. Use the text format commands on the **Home** tab.

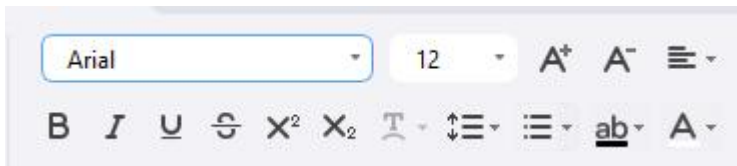

4. Click a blank area on the page or press **Esc** to finish.

## Format Text in Multiple Symbols

1. To format specific symbols, select the first symbol by holding down **Shift** or **Ctrl** (Mac: **⌘** or **⌘** / **shift** or **cmd**) and clicking others.
2. To format all the text, right-click on the canvas and choose **All Texts**.
3. Use the text format commands on the **Home** tab.
4. Click a blank area on the page or press **Esc** to finish.

## Format Connectors

### Format One Connector

1. Select the connector.
2. To change the look of the connector, do one of the following.
  - Select **Home > Quick Style** and choose a style you want.
  - Select **Home > Line** and choose a line color you want.
  - Select **Home > Line Style** and choose width, begin/end arrow type, begin/end arrow size, dash type, and connector type.
  - Open the **Line** tab on the **Style** pane and alter the look of connectors.

## Format Multiple Connectors

1. Win: To format specific connectors, select the first connector by holding down **Shift** or **Ctrl** and clicking others.  
Mac: To format all the text, right-click on the canvas and choose **All Texts**.
2. To format all connectors, right-click on the canvas and choose **All Connectors**.
3. Use the line format commands on the **Home** tab or **Style** pane.
4. Click a blank area on the page or press **Esc** to finish.

## Themes

### Apply a Theme to a Diagram

You can change colors and effects for all symbols at once by applying a theme.

1. Go to the Design tab.

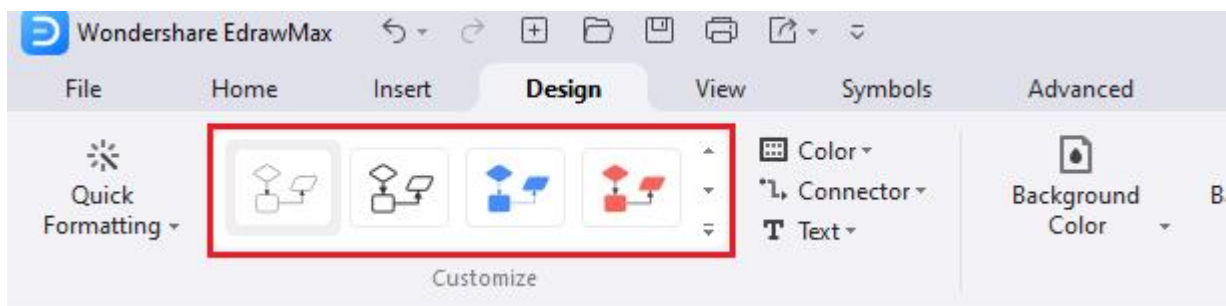

2. Hold your mouse pointer over a built-in theme to see a preview on the drawing page.
3. Click the theme to apply it.

For preventing a theme from applying to a symbol, see [Protect Symbols](#).

### Create a Custom Theme

EdrawMax provides a set of built-in themes, but you can also create and edit custom themes. For example, you can create a custom theme to match your company's logo and branding.

1. Select **Design tab > Color > Customize Colors**. In the **Create New Theme Colors** dialog box, select a combination of theme colors. In the **Name** box, type an appropriate name, and then click **OK**.
2. Select **Design tab > Color > Customize Connectors** and choose the preset connector style or create a new one.

3. Select **Design tab > Color > Customize Text** and choose the preset font style or create a new one.

## Quick Formatting

### Use Auto Formatting

The **Auto Formatting** feature enables you to automatically format your diagrams using the best possible theme style and colors.

1. Open a file with the diagram.
2. Select **Design > Quick Formatting > Auto Formatting**.

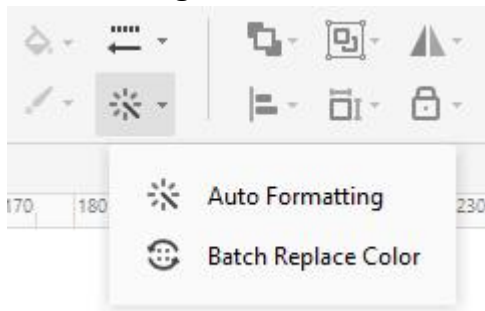

3. Click the **Auto Formatting** option repeatedly to switch between themes and colors until you find the one that suits the project.

### Batch Replace Colors

The **Batch Replace Color** enables you to change fill and line colors to all the symbols in the diagram in a single go. Furthermore, you can even choose whether the outlines (technically known as 'strokes') of the symbols should have the same or different colors than the one you used to fill symbols with.

1. Open a file with the diagram.
2. Select **Design > Quick Formatting > Batch Replace Color**.
3. Click and select a color from under the **Fill Color** section in the **Replace Color** dialog box. Optionally check the **Set the same color for lines** box to use the same color for the outlines of the symbols.
4. Click the **Bucket** icon from the right side of the **Fill Color** section. Pick a color from the swatch to fill all the shapes at once.

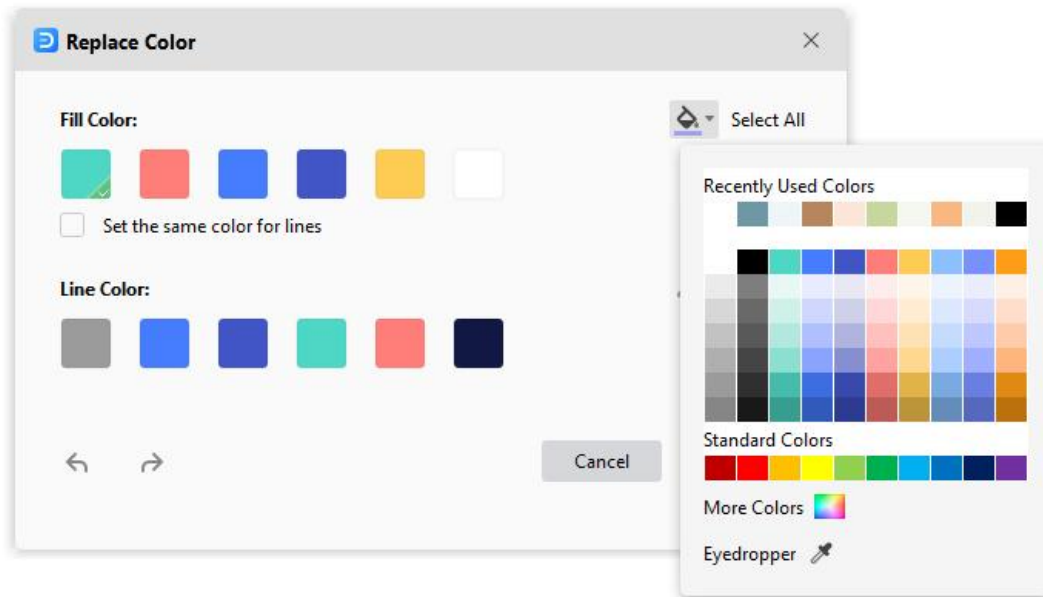

- If you didn't check the **Set the same color for lines** box earlier, you could choose a different color for outlines by following the same procedure but using the options under the **Line Color** section. You can click **Select All** to select all colors once.

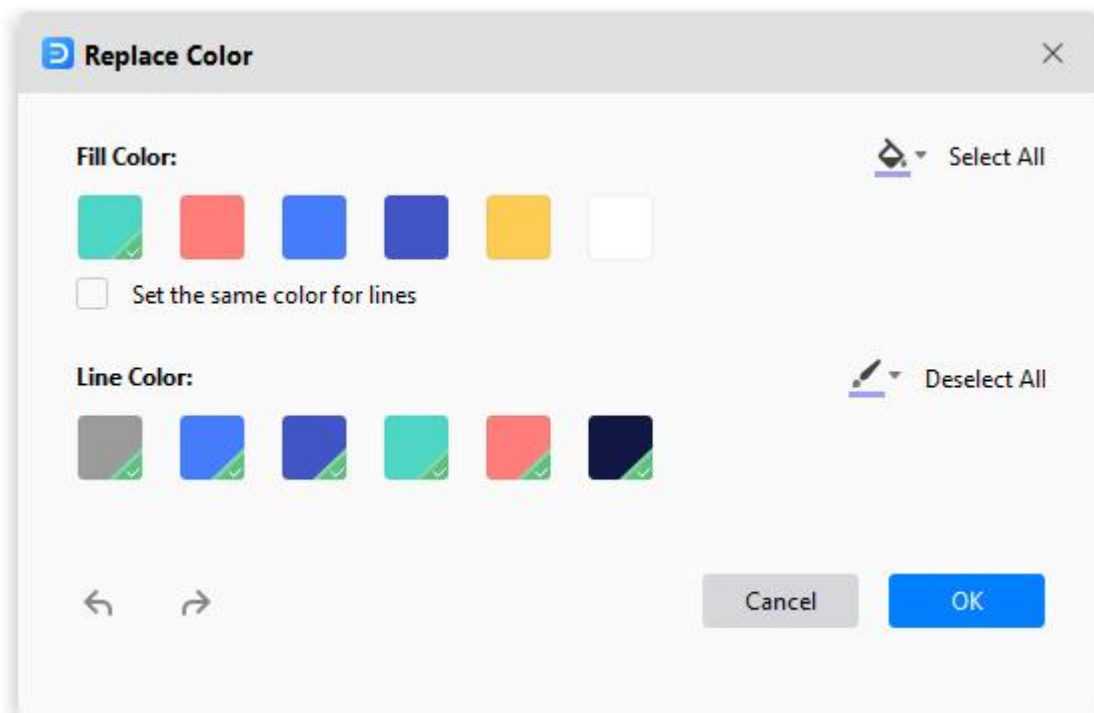

- Click **OK** to save the changes when done.

# Chapter 7 Insert

## Insert Tables

### Insert a Table

1. Select **Insert > Table**. Move the cursor over the grid until you highlight the number of columns and rows you want.

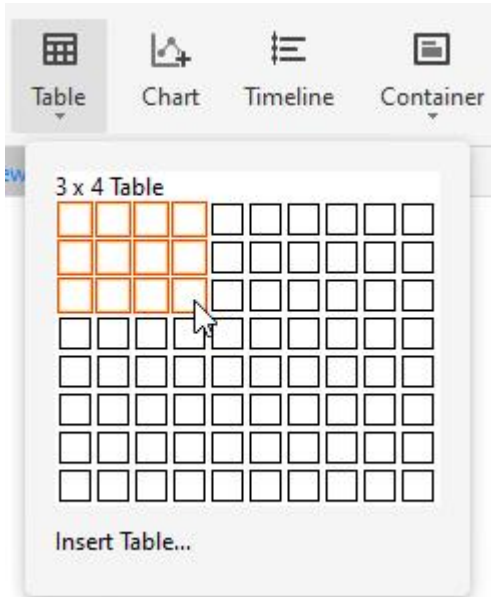

2. For a larger table or customize a table, select **Insert > Table > Insert Table**. In the **Insert Table** dialog box, type in the numbers of rows and columns you want.

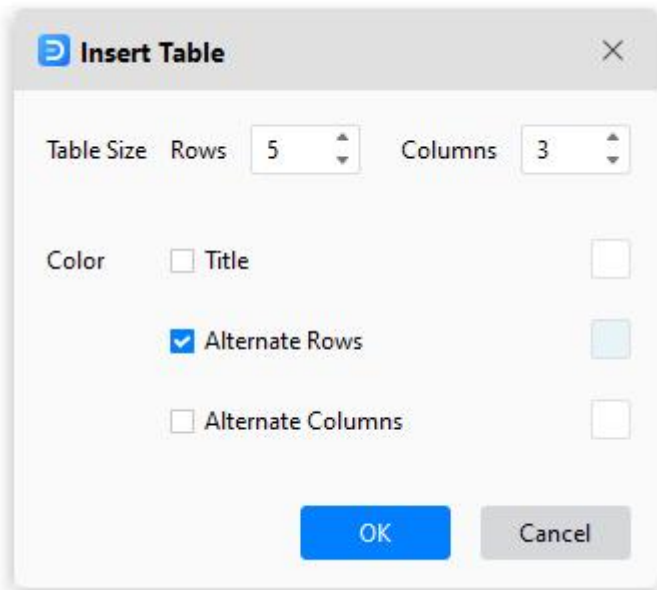

## Format a Table

Select the table, click the **More** icon on the mini toolbar, where you can

- Format the entire table by using options under **Table Styles**.
- Change table margins.
- Add or remove borders.
- Automatically add it up, calculate averages, pick up the maximum or minimum numbers.
- Add or delete a row or column.
- Merge or split cells.
- Distribute rows or columns.

## Table Data

Select the table, click the **More** icon on the mini toolbar, where you can

- Copy and paste data into the blank worksheet.
- Click cells of the worksheet and type numbers or text.
- Click **Import** to import the data file (XLSX, CSV).
- Click **Export** to export the table data into files (XLSX, CSV).

## Insert Charts

### Insert a Chart

1. Select **Insert > Chart**.
2. In the **Insert Chart** dialog box, choose a type of chart. These include column charts, bar charts, line charts, area charts, scatter charts, bubble charts, radar charts, pie charts, doughnut charts, rose charts, gauge charts, and funnel charts.
3. Click **OK**.

### Format a Chart

Select the chart, and you will see the mini toolbar where you can change the chart type, legend, axis color, label position and so on.



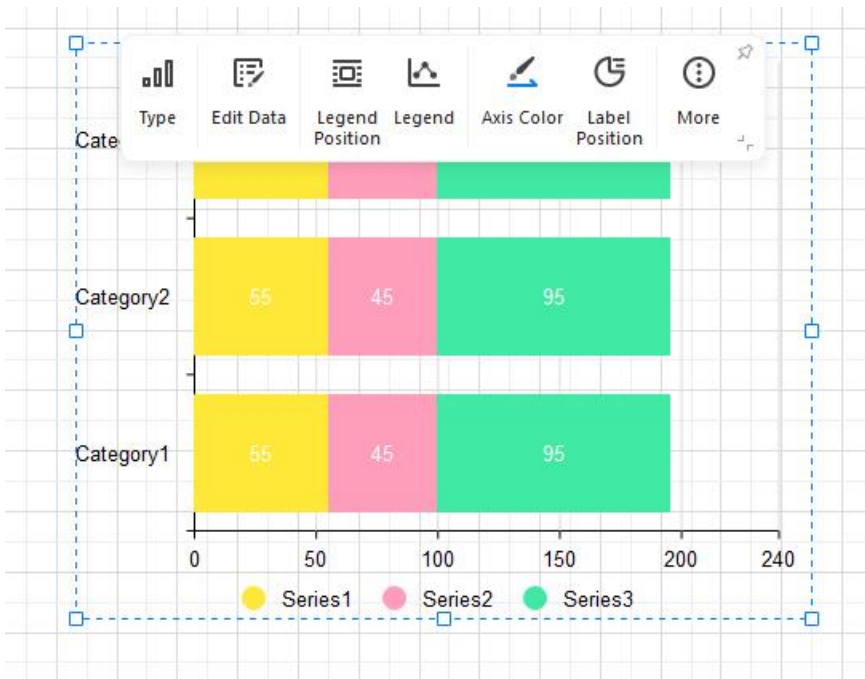

## Chart Data

Select the chart, click the **Chart** icon to open the **Data** pane where you can

- Copy and paste data into the blank worksheet.
- Click cells of the worksheet and type numbers or text.
- Click **Import** to import the data file (XLSX, CSV).
- Click **Export** to export the table data into files (XLSX, CSV).

## Insert Timelines

Inserting a timeline means creating a time-bound process workflow, where each date, month, or year in the timeline represented an instance when something noteworthy took place. For example, you can show how often the annual meetings were organized during the past decade.

### Insert a Timeline

1. Select **Insert > Timeline**.
2. In the **Insert Timeline** dialog box, choose a horizontal or vertical timeline you want.
3. Click **OK**.

### Format a Timeline

Select the timeline, and you will see the Timeline mini toolbar. Depending on the timeline you create, the menus and options in the **Timeline** mini toolbar may vary. Choose the style options you want.

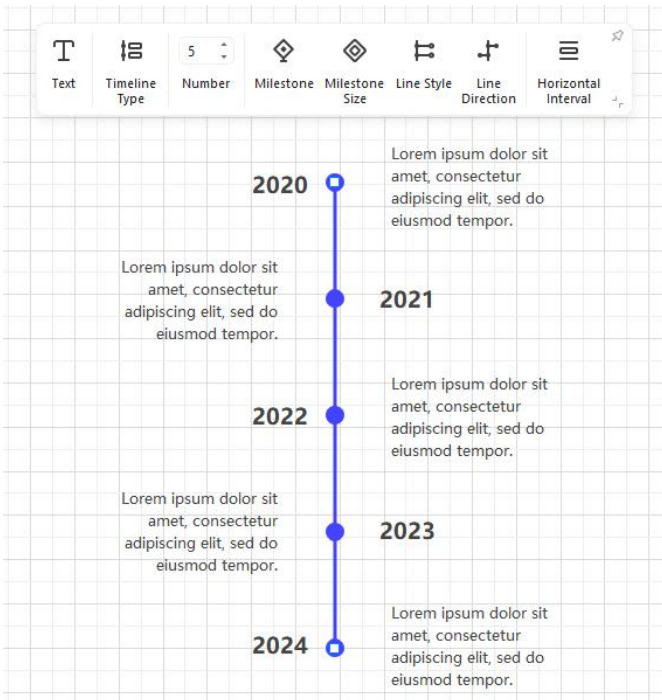

Nevertheless, some of the important input fields and menus that you can use include:

- **Shape Numbers:** This lets you add or remove the instances of the events from the timeline.
- **Timeline Type:** This lets you switch between horizontal and vertical timelines.
- **Milestone Style:** Enables you to choose between filled and hollow shapes representing milestones. This may vary. For instance, you will get the corresponding options if the diamonds represent milestones. Likewise, the 'Milestone Style' option will not be available if milestones are shown using other symbols or icons.
- **Horizontal Intervals:** These are available in some timelines and allow you to increase or decrease the horizontal spaces between the shapes that represent the instances.
- **Vertical Intervals:** Available in some timelines and let you increase or decrease the vertical spaces between the main Timeline and the labels or icons.
- **Central Axis:** This lets you choose the shape types for the instances in the relevant timelines.
- **Symbol Inserter:** This lets you choose the shapes of the symbols that represent the type of instances the timeline has. Some good examples of 'Symbol Inserter' would be an icon representing a Graduation degree, when a company was founded, etc.
- **Connection Line:** This lets you choose the type of connection lines used to connect the main timeline to the symbols representing the instances.
- **Data:** This option might be present under different labels and different names and lets you add or remove the instances from the timeline.

## Insert Containers

A **container** is a special symbol in EdrawMax that visually groups together logically-related symbols on the page. Visible grouping makes it easier to understand the structure of a complex diagram quickly.

### Insert a Container

1. Select the symbols you want to contain.
2. Select **Insert > Container**.

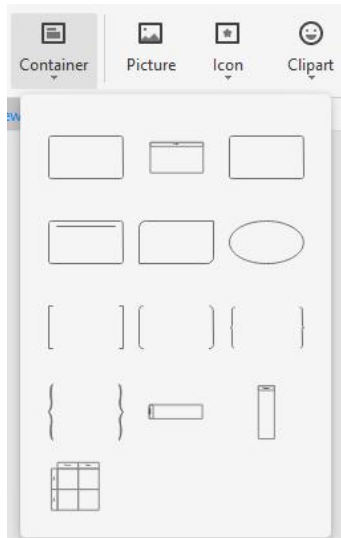

3. Hover the pointer over the container styles. Click to insert the container.
4. To add symbols to a container, drag the desired symbol into the container – notice the green border – then drop the symbol in the container. The container's border highlight in green indicates that the symbol will be confined when you release the mouse button.

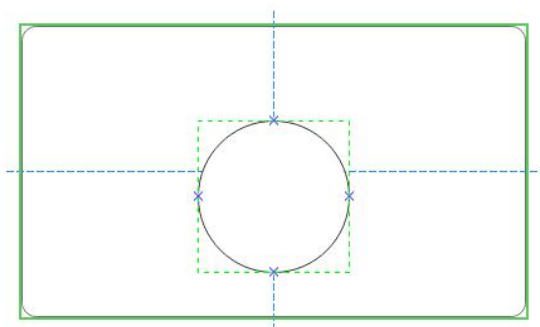

5. You can format a container using the style options on the **Home** tab.
6. Contained symbols have a specific relationship with the container and are affected by actions performed on the container.

### Delete a Container

- To delete a container only, click on the container and press **Delete**.

- To delete shapes only, click on the shape with the container's border highlighted in green and press **Delete**.
- To delete a container and its shapes, select them all and press **Delete**.

## Image Container

Except for the basic containers, EdrawMax also provides image containers (**Symbol Library > General > Image Container**), which will make it easy for you to make family trees and illustrate relationships between different people.

Simply add an image container on the page, select a picture and drag it into the container. The picture will fit into the container automatically.



## Insert Pictures

### Insert a Picture

1. Select **Insert > Picture**.
2. Locate the picture you want to insert, click the picture file, and click **Open** (the picture should be on your PC).
3. If the image is oversized, there will be a dialog box that lets you decide whether to compress the image or not.
4. Drag the picture to the location you want on the canvas.
5. Drag a resize handle until the picture is the size you want.

### Adjust a Picture

Select the picture and you will see the picture mini toolbar. You can change pictures, crop pictures to trim away unwanted parts, and adjust the picture's brightness, contrast, transparency, and color.

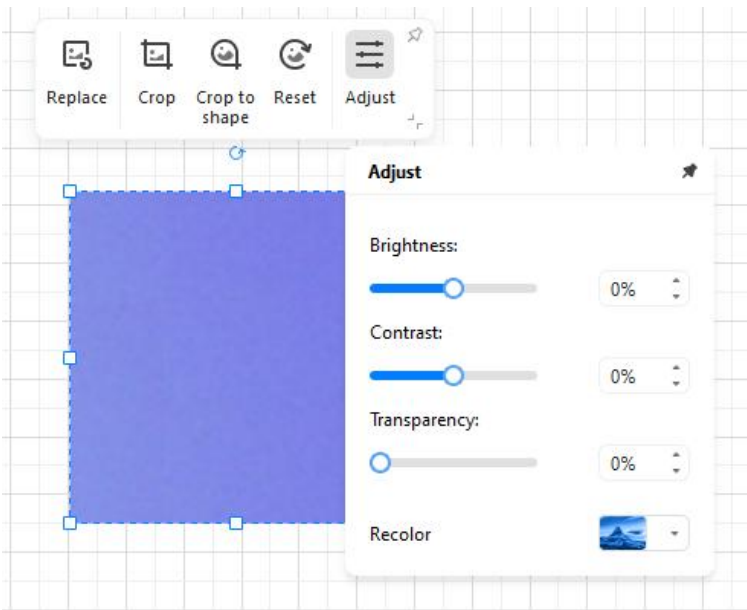

## Insert Formulas

1. Select **Insert > Formula**.
2. In the pop-up **Formula Editor** window, type and edit the formula you need.
3. Click **Confirm**.

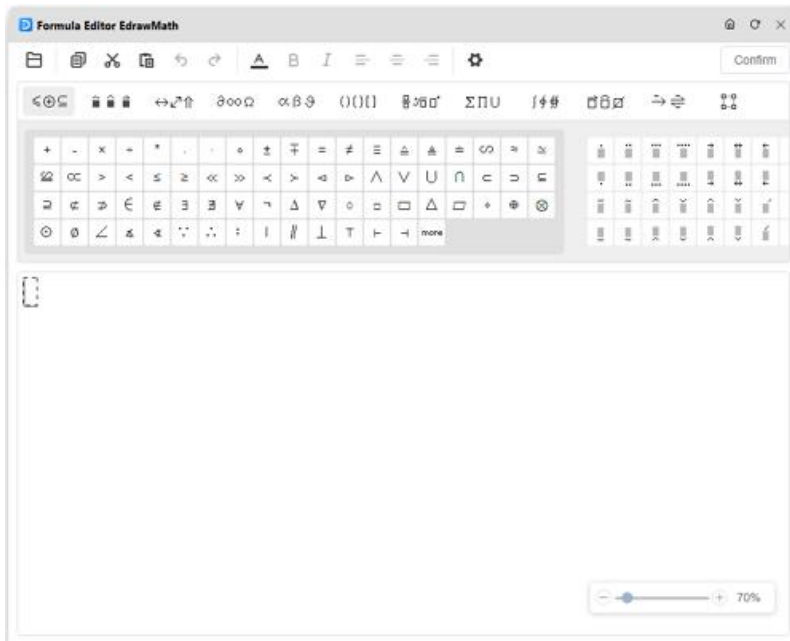

4. Double-click the formula on the canvas to open the editor again.

## Insert Hyperlinks

1. Select the symbol that you want to link.
2. Select **Insert > Hyperlink > Hyperlink** or right-click on the symbol and select **Insert > Hyperlink**.

3. In the pop-up **Hyperlink** dialog box, insert a hyperlink from the **Current Document**, **File or application**, **Internet address**, or **Folder**.
4. Click the plus icon to add new hyperlinks and click the delete icon to delete hyperlinks.

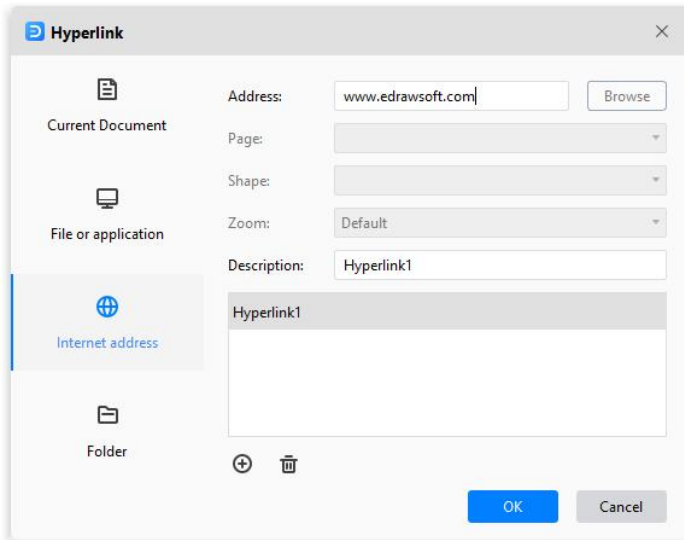

5. Click **OK**. You will see a web icon in the upper right corner of the symbol.

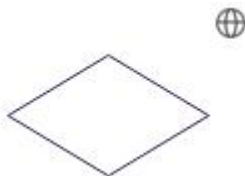

6. To change a hyperlink, select the hyperlink in the hyperlink list, make the changes you want in the dialog box, and click **OK**.

## Insert Attachments

1. Select the symbol that you want to insert a file.
2. Select **Insert > Attachment** or right-click on the symbol and select **Insert > Attachment**.
3. Click the folder icon, locate and click the file you want to insert, click the picture file, and click **Open** (the file should be on your PC).

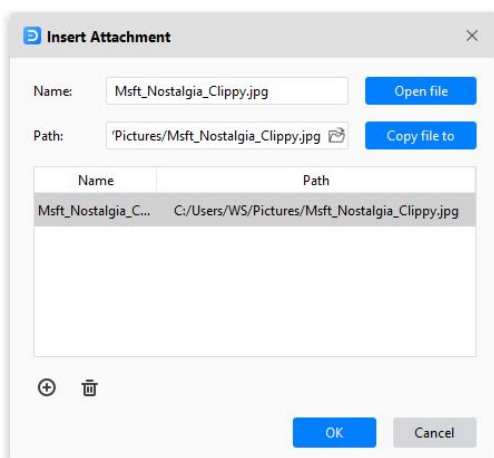

4. Click the plus icon to add new hyperlinks and click the delete icon to delete hyperlinks.

5. Click **OK**. You will see a clip icon in the upper right corner of the symbol.

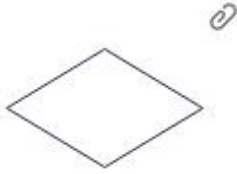

6. If you don't need the attachment, just right-click on the icon and choose **Remove**.

## Insert Notes

1. Select the symbol that you want to insert a note.
2. Select **Insert > Note** or right-click on the symbol and select **Insert > Note**.
3. Type and format the text.
4. Click **OK**. You will see a pencil icon in the upper right corner of the symbol.

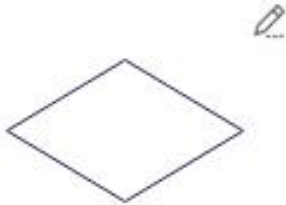

## Insert Comments

1. Select the symbol that you want to add a comment.
2. Select **Insert > Comment** or right-click on the symbol and select **Insert > Comment**.
3. Type your comment.
4. Click **Send**. You will see a comment icon in the upper right corner of the symbol.

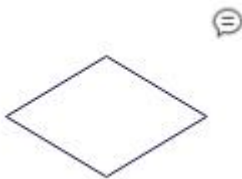

5. To read a comment, click the comment icon. The comment opens.
6. To close the comment, click on a blank area of the page.

# Chapter 8 Tips & Tricks

## How to Make a Flowchart

### Open a Flowchart Template

1. Select **File > Basic > Flowchart**.
2. Click a flowchart template.
3. Alternatively, click **File > Templates**. Type and search "Flowchart." Choose a flowchart template you want and click **Duplicate**.
4. To add text to a symbol or connector, select it, and then type. When you are finished typing, click on a blank area of the page.

### Add and Connect Flowchart Symbols

1. Select and open **the Basic Flowchart Shapes** library.
2. Select a flowchart symbol and drag it onto the drawing page.
3. To add or connect the next symbol, do one of the following.
  - Point to the symbol, and point to the arrow that indicates the direction of the next symbol you want to add. Select the symbol you want to add.

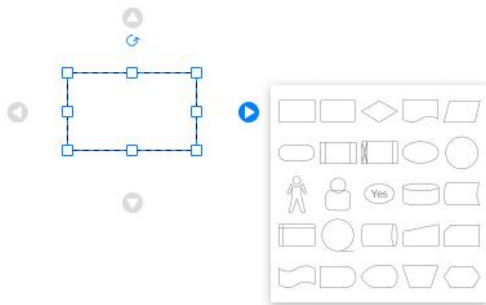

- Select **Home > Connector**. Point to the symbol until you see the connection points around the edge. Select a connection point and drag to draw a line to a connection point on the symbol you want to connect to.
- Drag a flowchart symbol from the library and move to the arrow that indicates the direction of the next symbol you want to add. Release the mouse button until the arrow turns blue.

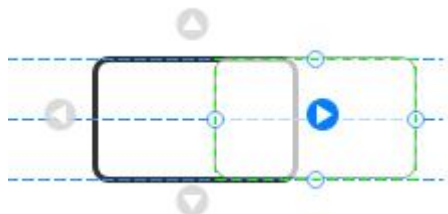

4. To change the look of the connector, select it, select **Line** or **Line Style** on the **Home** tab, and select a color, line weight, dash style, and arrow style.



# How to Make a Swimlane Diagram

## Add or Delete a Swimlane

Swimlanes are used to divide your flowchart into different sections. Choose a template from **Cross-Functional Flowchart** in EdrawMax, and you can use a pre-designed swimlane diagram directly.

- In the **Cross-Functional Flowchart** library, drag a swimlane symbol (either horizontal or vertical) onto the drawing page.

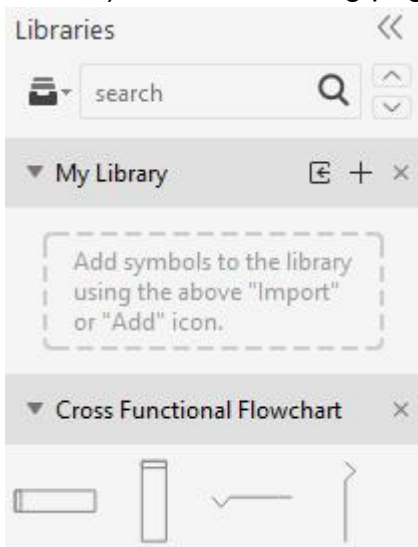

- Drag more swimlane symbols from the **Library** window. Drop and move them when you see the orange connection indicator appear where you want the swimlane to go. Release the mouse button.

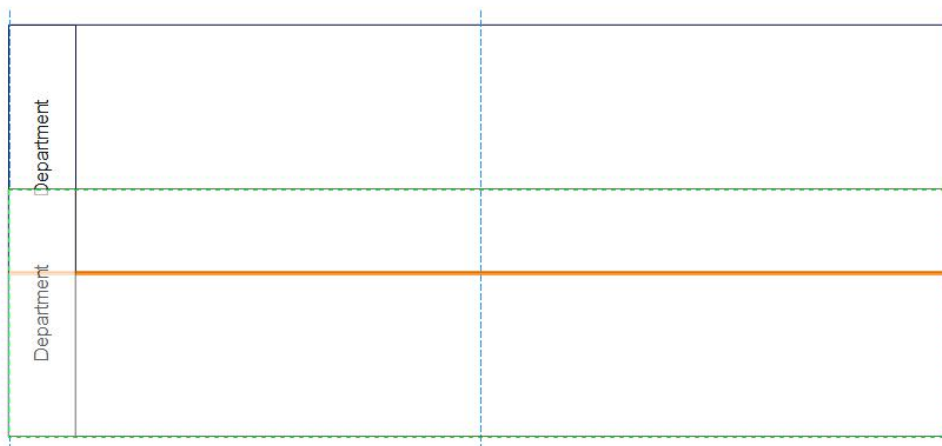

- Drag any basic flowchart symbols into the correct swimlanes. When the symbol is contained in the swimlane, the swimlane shows a green highlight.



8. If you drop a new swimlane onto a flowchart symbol that's already on your drawing, to group the symbol with a swimlane, move the symbol, so the EdrawMax highlights the swimlane, and then drop the symbol.
9. When you move the swimlane, the contained symbols automatically move with it.
10. To delete a swimlane, click it so that a blue dashed-line box appears inside the swimlane, then press **Delete**. Deleting a swimlane also deletes the symbols it contains.

## Format a Swimlane

1. Select a swimlane in the diagram so that the **Swimlane** pop-up menu appears.

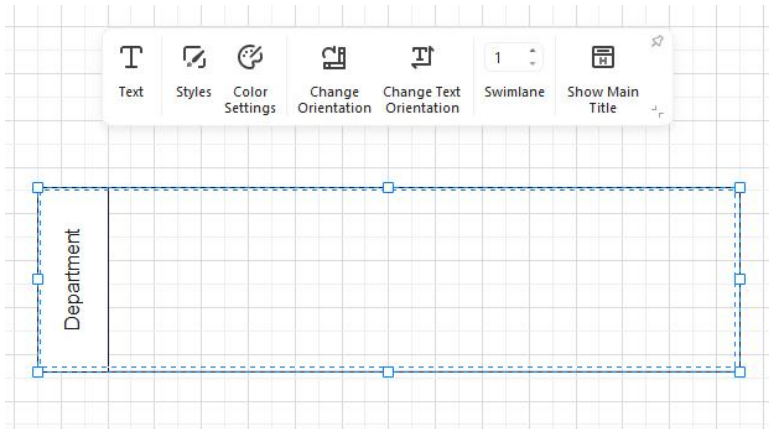

2. In the **Swimlane** mini toolbar, you can change a swimlane's orientation, text orientation, swimlane numbers, positions of the main title, colors, etc.
3. If you need to change the width of any swimlane, drag one of the swimlane's separator lines until it is the width you want.

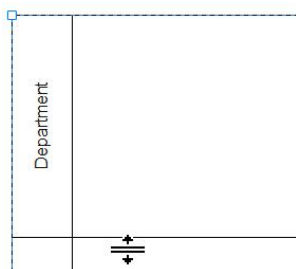

4. If you want to make any swimlane longer or shorter, drag its end line until it is the length you want.

# How to Make an Organizational Chart

## Create a Simple Organizational Chart

1. Select **File > Basic > Organizational Chart**.
2. Click an organizational chart template.
3. Alternatively, click **File > Templates**. Type and search "Organizational Chart" or "Org Chart." Choose an org chart template you want and click **Duplicate**.
4. Replace the sample text with your information.
5. To add a new person, do one of the following.
  - Select a symbol from the library, drag it onto the drawing page and place it on top of the symbol you want to connect the two. The green area indicates the direction of the next symbol you wish to add.

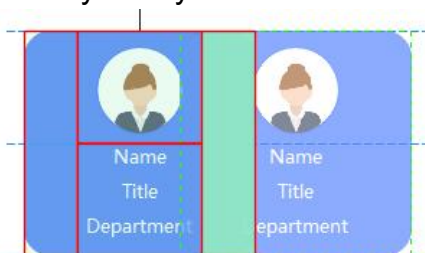

- Select the symbol on the drawing page and click the floating buttons to add the new person.

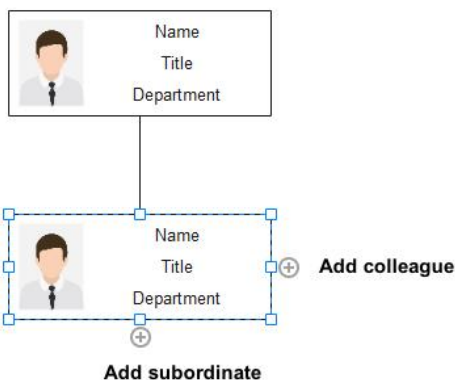

- Select the symbol on the drawing page, right-click and select **Add Subordinate**, **Add Colleague** and **Add Assistant**.
6. To insert and change photos, select the symbol, select content layouts that include the default photo (if the symbol has no default photo) on the **Organization Chart** pane, click **Change Photo**, and select the photo file.

## Create an Organizational Chart from Data

If all the employee information of your organization is saved in a document (.txt, .csv, .xls, .xlsx), you can use EdrawMax to create an org chart from the data file.

1. Select **File > Basic > Organizational Chart**. Click and open a blank org chart(automated) template.
2. Click **Import** on the **Organization Chart** mini toolbar.
3. On the first page of the pop-up dialog box, locate the data file that contains employee information from your local storage, and click **Next**. The data file must include employee names and whom the employee will report to.

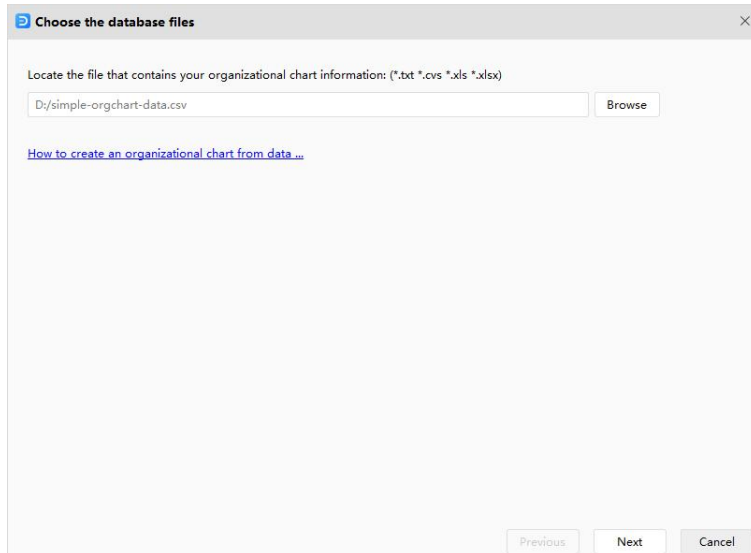

4. On the second page, you will see how your worksheet data is shown in the data import window.



5. On the final page, you need to select what information you want to show on the symbol and how the information is displayed. Besides, you can decide whether to show photos or not and choose the photo position. After you have made all your selections, click **Finish**.

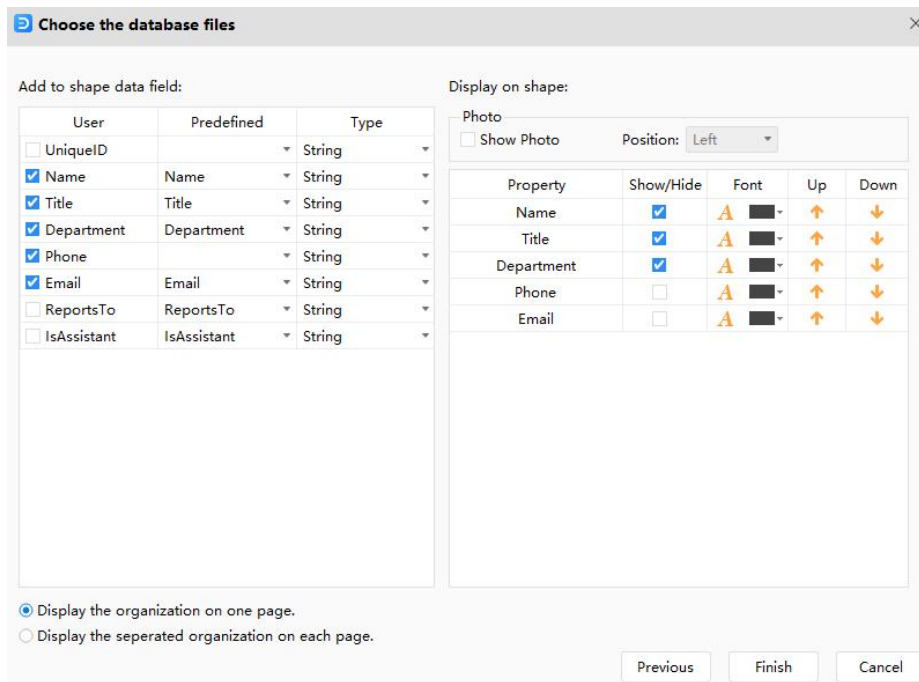

## Format an Organizational Chart

1. Select an org chart so that the **Organization Chart** mini toolbar appears.
2. You can arrange the layout of the org chart, space between symbols, the height, and width of symbols, using the various commands and options in the **Organization Chart** mini toolbar.
3. Before formatting the chart, remember to check the selected objects you will apply effects to in the **Select** tab.
4. To show or hide information in an org chart, do the following.
  - Select the checkboxes for the fields you want to show in the symbol.
  - Clear the checkboxes for the fields that you want to hide.
5. Click **Card Infomation** and select the checkboxes for the field you want to add into the **Card Field**. If there is no field you need, click **Define fields** and create a custom field.

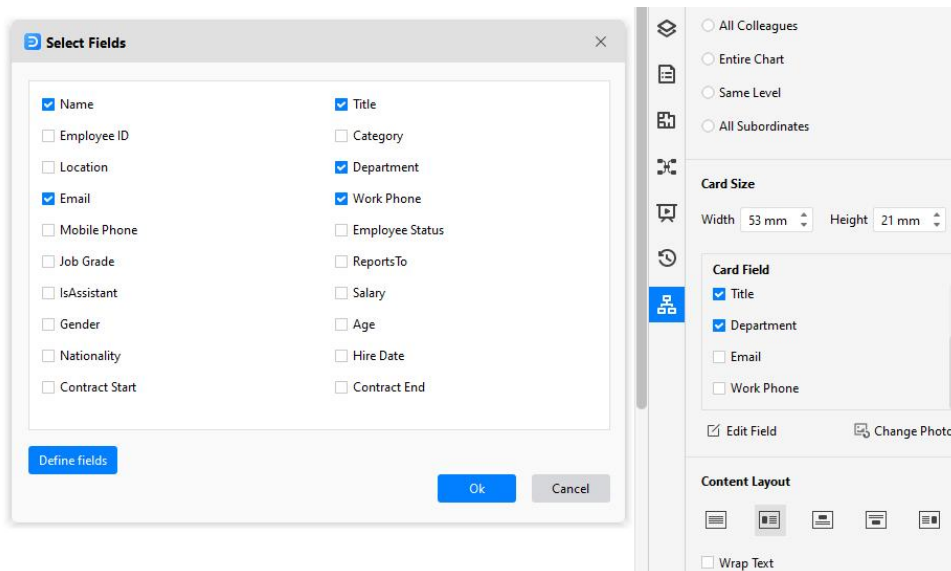

## How to Make a Gantt Chart

### Create a Gantt Chart

1. Select **File > Business > Project Management**.
2. Click a Gantt chart template.
3. Alternatively, select the **Gantt** library. Drag a Gantt chart onto the drawing page. In the **Gantt Options** dialog box, set the dates for the timescale. **Major Unit** is the longest unit of time you want to use in the Gantt chart, and **Minor Unit** is the smallest, e.g., month/day. Accept the default choices if you aren't sure of other formatting options. You can change them later.

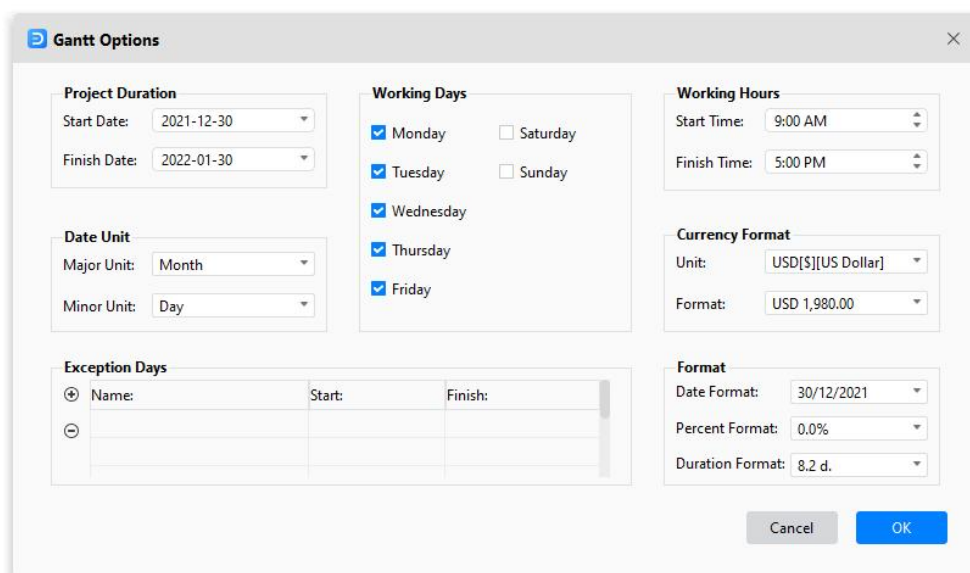

4. Replace the sample text with your information.

## Create a Gantt Chart from Data

Save project data in a document (.txt, .csv, .xls, and .xlsx) and is arranged in a fixed format.

1. Select **File > Business > Project Management**. Click and open a Gantt chart template.
2. Click **Import** on the **Gantt Chart** mini toolbar.
3. On the first page of the pop-up window, choose the file that contains the project plan data, and then click **Next**. The data file must have the task name, task start date, and task finish date.

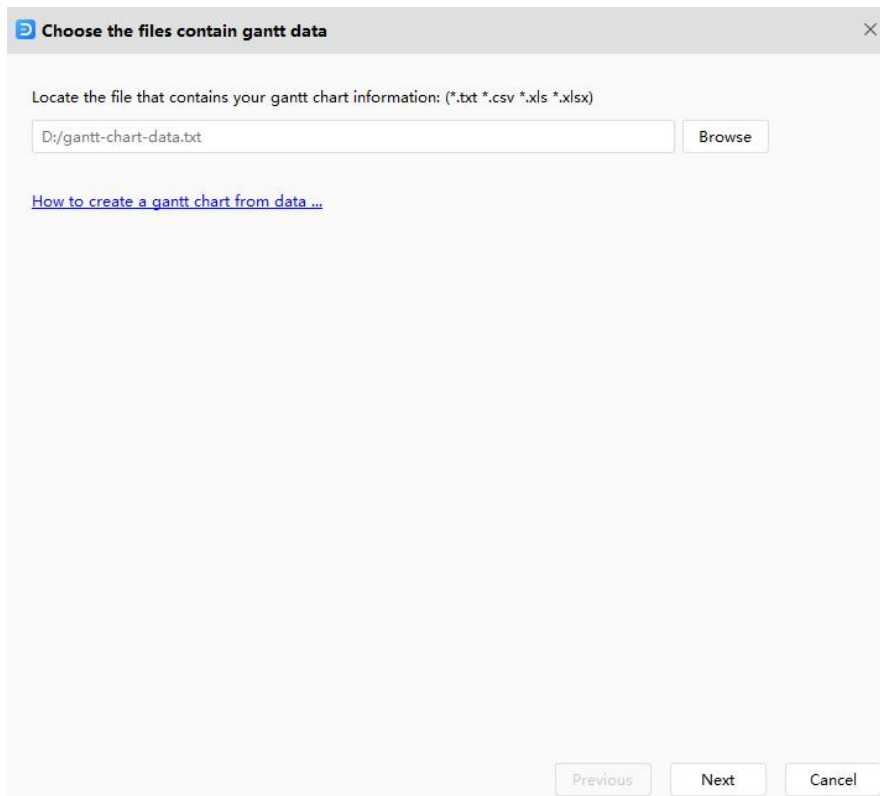

4. On the second page of the window, confirm the date format, column name, column type, and data type. There you can preview your data set in the worksheet of **Task List**.



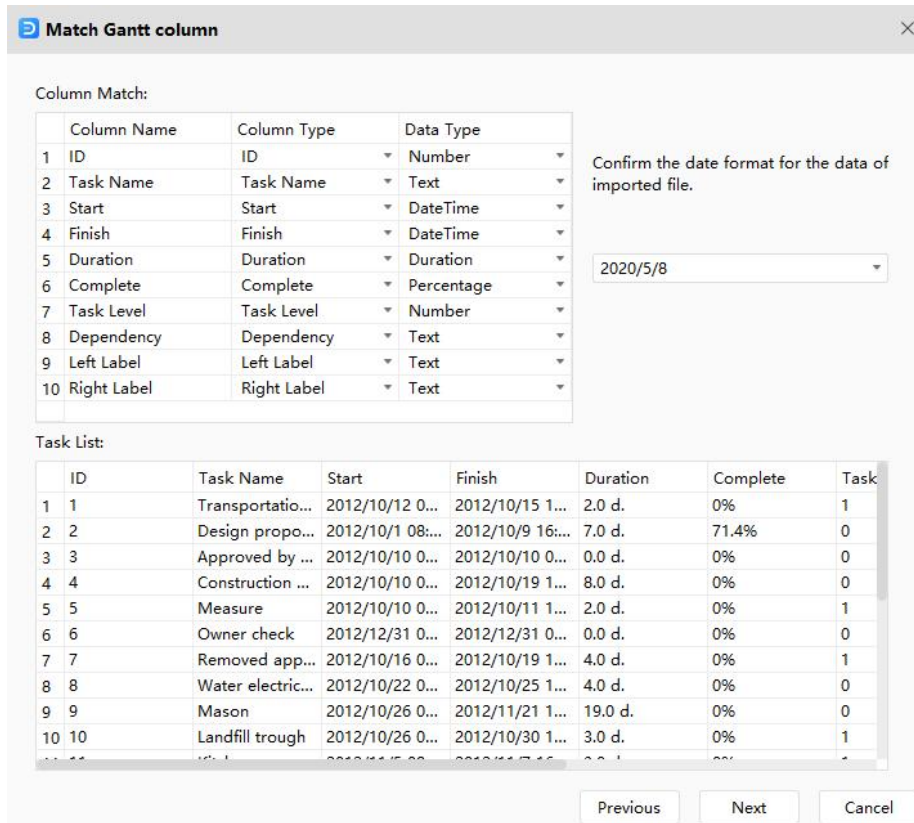

Column Name	Specification
<b>ID</b>	[Optional] Unique identifier of the task, if there is no column in your data file, EdrawMax will add a numbered list; this unique identifier is used for Dependency.
<b>Task Name</b>	The description of the task.
<b>Start</b>	The date that you start to work on the task.
<b>Finish</b>	The date that you finish working on the task.
<b>Duration</b>	[Optional] duration time of a task, if there is no column in your data, Edraw will calculate the duration value from Start and Finish.
<b>Complete</b>	[Optional] The percentage value of task complete.
<b>Task Level</b>	[Optional] Identify the task or sub-task with an integer value. Level 1 task is a sub-task of level 0 task.
<b>Dependency</b>	[Optional] Help define relationships between tasks.
<b>Resource</b>	[Optional] Task resource.
<b>Cost</b>	[Optional] Task cost.
<b>Hyperlink</b>	[Optional] Hyperlinks to other source files.
<b>Priority</b>	[Optional] Indicate task priority with an integer value from 0~5.
<b>Left Label</b>	[Optional] Text label for the task.
<b>Right Label</b>	[Optional] Text label for the task.

6. Set formats for your Gantt chart on the third page of the window. After you have made all your selections, click **Finish**.



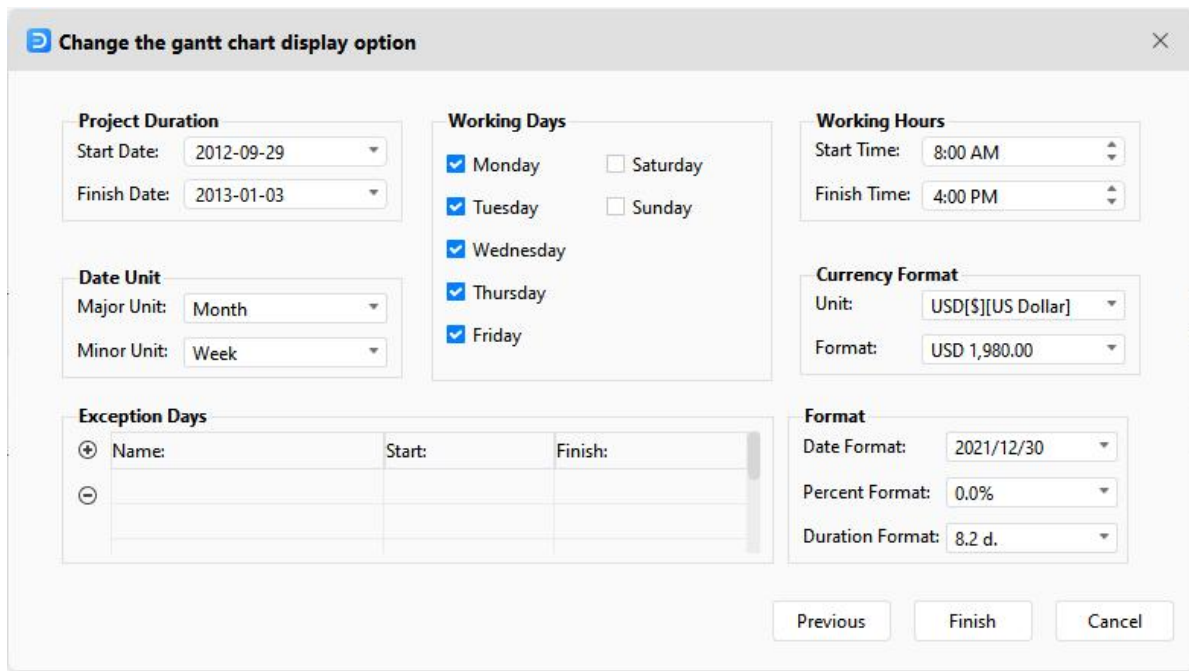

5. Get a Gantt chart that comes from your project data.

## Add Data to a Gantt Chart

### Tasks

Each task in a Gantt chart occupies a row in the chart frame.

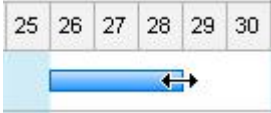
Goal	Action
Change a task name	<ul style="list-style-type: none"> <li>Double-click the cell in the <b>Task Name</b> column and type a new name.</li> </ul>
Change task start or finish date	<ul style="list-style-type: none"> <li>Double-click the cell in the <b>Start/Finish</b> column, then select the new date and ensure the new data format is the same as others.</li> <li>Click on the task bar, drag the bar. The start date and finish date determine the bar's length in the Gantt frame.</li> </ul> 
Set or change task duration	<ul style="list-style-type: none"> <li>Double-click the cells in the <b>Duration</b> column, type the new value.</li> </ul>
Add percent complete indicators to tasks	<ul style="list-style-type: none"> <li>Click on the left margin of the task bar, hold the mouse and move to the date you want.</li> </ul>

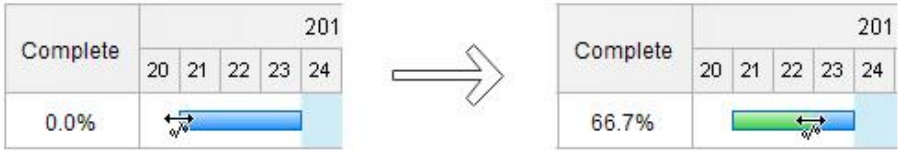
	 <ul style="list-style-type: none"> <li>Type the percentage of the task completed in the <b>Complete</b> column. A percent complete indicator appears in the task bar.</li> </ul>
Add a new task row	<ul style="list-style-type: none"> <li>Right-click a task and click <b>Add Task Before/After</b>.</li> <li>Select a task and click <b>Insert Before/After</b> on the <b>Gantt Chart</b> pane.</li> </ul>
Delete a task	<ul style="list-style-type: none"> <li>Right-click the task and click <b>Delete</b>.</li> </ul>
Change task style	<ul style="list-style-type: none"> <li>Select a task or multiple tasks, choose the fill color on the color bar of the footer or go to the <b>Style</b> pane.</li> </ul>

## Milestones

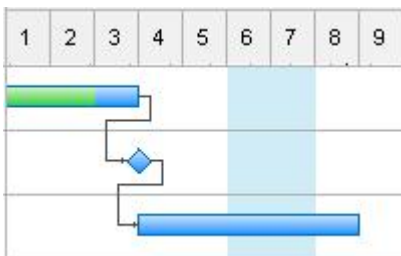

A milestone represents a significant event in a schedule. Its duration is set to zero.



Goal	Action
Convert a task to a milestone	<ul style="list-style-type: none"> <li>Select the task row that you want to convert to a milestone. Check <b>Milestone</b> box on <b>Gantt Chart</b> pane.</li> <li>Type a duration of zero (0) in the <b>Duration</b> column of the row representing the task that you want to convert to a milestone.</li> </ul>
Delete a milestone	<ul style="list-style-type: none"> <li>Select the row of the milestone and uncheck the <b>Milestone</b> box on the <b>Gantt Chart</b> pane.</li> <li>Delete the row of the milestone.</li> </ul>

## Summary Tasks

You can use a summary task to combine several subordinate tasks (sub tasks) under one umbrella task. A summary task summarizes the sub-tasks that are indented below it.

☐ Task 1	12/05/2020	22/05/2020	8.5 d.	0%	
Task 2	12/05/2020	19/05/2020	5.5 d.	0%	
Task 3	18/05/2020	22/05/2020	4.0 d.	0%	

Goal	Action
Add a subtask under a summary task	<ul style="list-style-type: none"> <li>Select a normal task row, right-click and select <b>Sub Task</b>. The normal task row becomes a summary task.</li> <li>Select a normal task row, click <b>Sub task</b> on the <b>Gantt Chart</b> pane.</li> </ul>
Convert a task to a subtask	<ul style="list-style-type: none"> <li>Select the task, click <b>Indent</b> on the <b>Gantt Chart</b> pane.</li> </ul>
Set the duration for a summary task	<ul style="list-style-type: none"> <li>After adding the task duration information for all the sub-tasks, the summary task duration fills in automatically.</li> </ul>
Promote (Outdent) a task	<ul style="list-style-type: none"> <li>Select the subtask, click <b>Outdent</b> on the <b>Gantt Chart</b> pane.</li> </ul>

### Dependencies (Linked tasks)

An arrow joins the two task bars in your Gantt chart when you make one task dependent upon another. If you change the date or duration of a task dependent upon another task, the dates of the dependent tasks change as well.

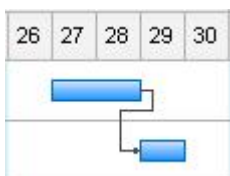

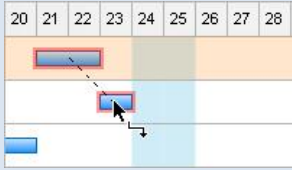
Goal	Action
<b>Set dependencies between tasks</b>	<ul style="list-style-type: none"> <li>Click on a task bar, drag and move to another task bar, release the mouse. The red boxes indicate that you can link tasks.</li> </ul>  <ul style="list-style-type: none"> <li>Select 2 or more tasks, click <b>Link Tasks</b> on the <b>Gantt Chart</b> pane.</li> </ul>
<b>Break dependencies</b>	<ul style="list-style-type: none"> <li>Select the linked tasks, click <b>Unlink Tasks</b> on the <b>Gantt Chart</b></li> </ul>

between tasks

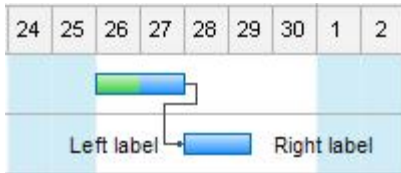

pane.

## Task Label



You can add text labels to the taskbar to have more descriptions of the task. Right-click the task, click **Add Left Label**, or **Add Right Label** on the context menu. Double-click the labels to edit the text, and move the label.

## Task Hyperlink (Link to Task Resource)

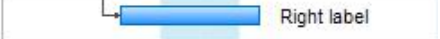
ID	Hyper link	Task Name	Start	Finish	Duration	Complete	2012/11/20												
							20	21	22	23	24	25	26	27	28	29	30		
1		Internet address	2012/11/20	2012/11/22	3.0 d.	33.3%													
2		Employee data	2012/11/23	2012/11/26	1.5 d.	0.0%													

Right-click the column name, click **Insert column**, and check **Hyperlink** to add a Hyperlink column. Right-click the task, click **Hyperlink** on the task context menu to add hyperlinks. Refer to [Insert Hyperlink](#) and see how to insert a hyperlink in the task.

## How to Make a Floor Plan

### Start a New Floor Plan

To make a floor plan in EdrawMax, you can choose its corresponding preset, pick a pre-populated template, or start with a blank document.

1. Select **File > Engineering > Building Plan**.
2. Click a floor plan template.
7. Alternatively, click **File > Templates**. Type and search "Floor Plan." Choose a template you want and click **Duplicate**.
3. To add floor plan symbols from **Wall Shell and Structure** library, drag them onto the canvas and resize them to create a blueprint.

### Change Drawing Scale

1. Select the floor plan or the symbol.
2. In the **Floor Plan** mini toolbar, select the **Drawing Scale** arrow.

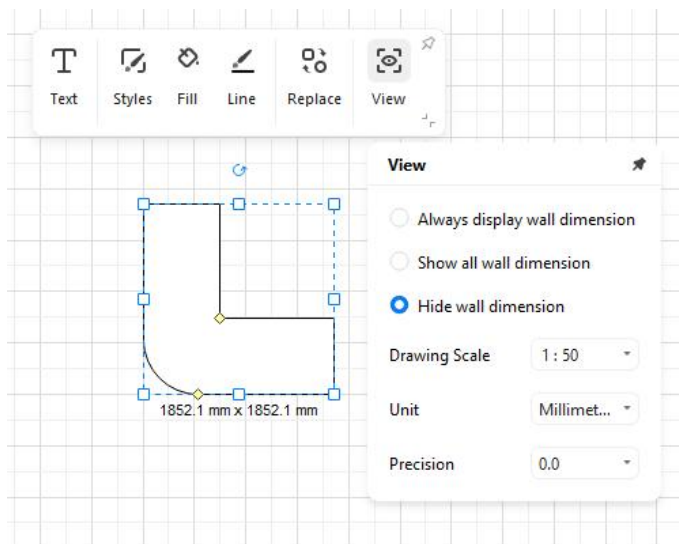

3. Choose a pre-defined scale and click.

The **Floor Plan** pane comprises various commands and options to fine-tune the blueprint of the building plan.

- **View** – The category lets choose whether you want to hide or view the thickness of the walls of the building plan.
- **Drawing Scale** – The drop-down menu can set the size ratio between the floor plan displayed on the screen and the hardcopy printout.
- **Unit** – The drop-down menu contains the units of measurements that you can switch to as needed.
- **Precision** – The drop-down menu allows you to set the minuteness (extreme size details) of the construction measurements, such as the thickness of the wall, carpet area, etc.
- **Wall** – The category lets you define the thickness of the wall and the shape you select on the canvas.

**Note:** You can check the **Apply to all walls** box to set the thickness of all the floor plan walls at once.

## Area Calculation

Calculating the area of a room or the entire floor plan is pretty simple in EdrawMax.

1. Drag the **Space** symbol from the **Wall Shell and Structure** library on the left to the portion of the floor plan you want to calculate the area.
2. Use the scaling handles of the symbol to cover the available space.
3. Specify your preferred unit of the area from the **Unit** drop-down list present in the **Floor Plan** mini toolbar.
4. Note the values that appear at the center of the **Space** symbol.

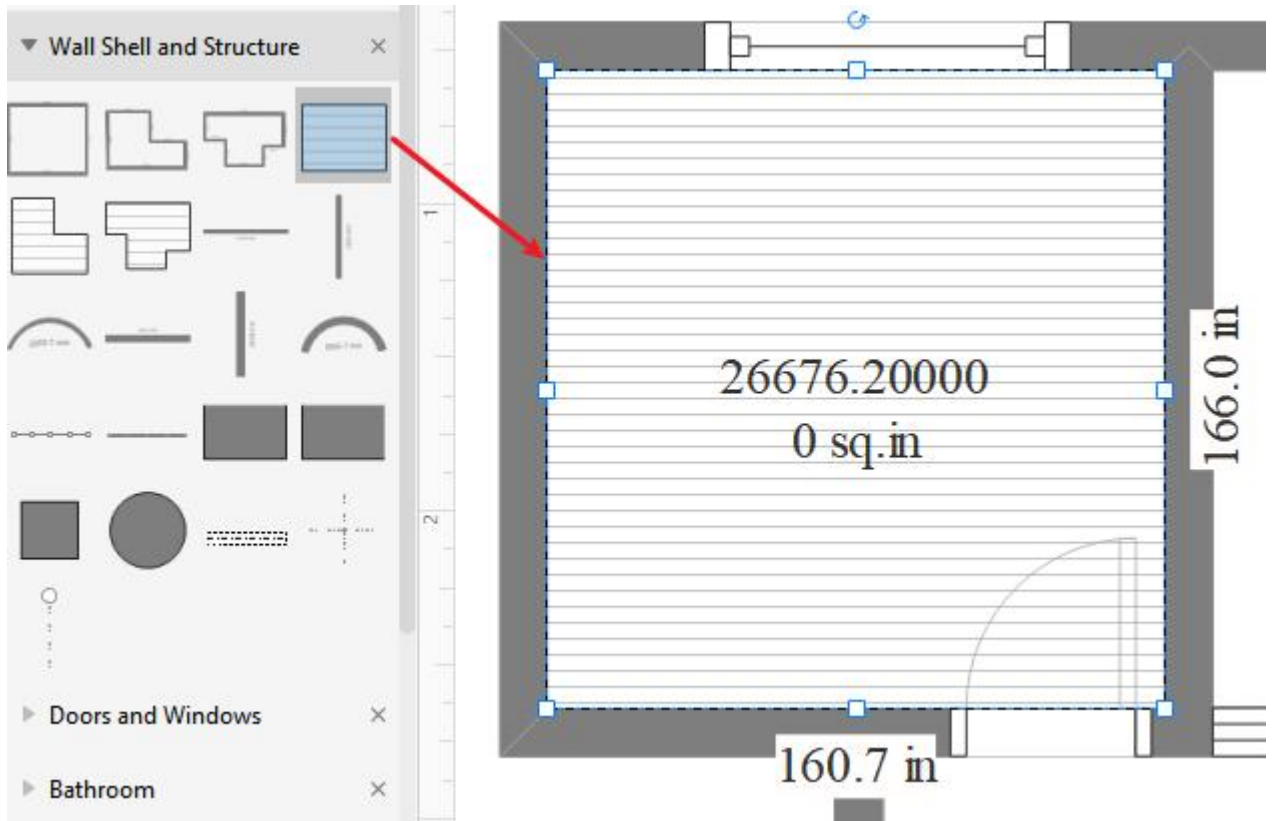

# Keyboard Shortcuts

Select **File > Options > Shortcuts**. You will see the inbuilt shortcut key list. Click **Customize Shortcuts**, and you can set custom shortcut keys for any function.

The keyboard shortcuts refer to the U.S. keyboard layout. Keys on other keyboard layouts may not correspond exactly to the keys on a U.S. keyboard.

Goal	Shortcuts: For Win (Mac)
<b>Quick Access Toolbar</b>	
Undo	Ctrl + Z (⌘ + Z)
Redo	Ctrl + Y; Ctrl + Shift + Z (⌘ + ⬆ + Z)
Create a new document	Ctrl + N (⌘ + N)
Open	Ctrl + O (⌘ + O)
Save	Ctrl + S (⌘ + S)
Save as	Ctrl + Shift + S (⌘ + ⬆ + S; Fn + F12)
Print	Ctrl + P (⌘ + P)
Close	Ctrl + W (⌘ + W)
<b>Home</b>	
Cut	Ctrl + X (⌘ + X)
Copy	Ctrl + C (⌘ + C)
Paste	Ctrl + V (⌘ + V)
Paste as special formats	Ctrl + Alt + V (⌘ + ⌥ + V)

Format painter	Ctrl + Shift + C (⌘ + ⬆ + C)
Increase font size	Ctrl + Shift + . (period) / ⌘ + ⬆ + . (period)
Decrease font size	Ctrl + Shift + ,(comma) / ⌘ + ⬆ + ,(comma)
Make the selected text bold	Ctrl + B (⌘ + B)
Italicize the selected text	Ctrl + I (⌘ + I)
Underline the selected text	Ctrl + U (⌘ + U)
Subscript	Ctrl + Alt + - (⌘ + ⌘ + -)
Superscript	Ctrl + Alt + = (⌘ + ⌘ + =)
Select tool	Ctrl + 1 (⌘ + 1)
Select all shapes	Ctrl + A (⌘ + A)
Text tool	T; Ctrl + 2 (⌘ + 2)
Text block adjust tool	Ctrl + Alt + 2 (⌘ + ⌘ + 2)
Add right-angle connectors	Ctrl + 3 (⌘ + 3)
Add curved connectors	Ctrl + 4 (⌘ + 4)
Add straight connectors	Ctrl + 5 (⌘ + 5)
Rectangle tool	R; Ctrl + 8 (R; ⌘ + 8)
Oval tool	O
Bezier tool	Ctrl + 7 (⌘ + 7)



Repeat a command	F4 (⌘ + Y)
Connection points tool	Ctrl + Shift + 1 (⌘ + ↑ + 1)
Bring to front	Ctrl + Shift + ] (⌘ + ↑ + ])
Bring forward	Ctrl + ] (⌘ + ])
Send to back	Ctrl + Shift + [ (⌘ + ↑ + [)
Send backward	Ctrl + [ (⌘ + [)
Group shapes	Ctrl + G (⌘ + G)
Ungroup shapes	Ctrl + Shift + G (⌘ + ↑ + G)
Make selected shapes in the same width	Ctrl + Shift + W (⌘ + ↑ + W)
Make selected shapes in the same height	Ctrl + Shift + H (⌘ + ↑ + H)
Make selected shapes at the same angle	Ctrl + Shift + A (⌘ + ↑ + A)
Make selected shapes in the same size	Ctrl + Shift + Z (⌘ + ↑ + Z)
Align shapes by left	Alt + L (⌘ + L)
Align shapes by center	Alt + C (⌘ + C)
Align shapes by right	Alt + R (⌘ + R)
Find & Replace	Ctrl + F (⌘ + F)
Spelling check	F7 (Fn + F7)
Capture screen	Ctrl + Shift + R (⌘ + ↑ + R)

Capture screen with the interface hidden	Ctrl + Shift + X (⌘ + ⇧ + X)
<b>Insert</b>	
Insert a blank page	Shift + F11 (⇧ + F11)
Insert a table	Ctrl + Alt + T (⌘ + ⌥ + T)
Insert a chart	Ctrl + Alt + P (⌘ + ⌥ + P)
Insert pictures from files	Ctrl + Alt + I (⌘ + ⌥ + I)
Insert a formula	Ctrl + Alt + E (⌘ + ⌥ + E)
Add vector text	Ctrl + Shift + V (⌘ + ⇧ + V)
Insert hyperlinks	Ctrl + K (⌘ + K)
Insert attachments	Ctrl + H (⌘ + H)
Insert notes	Ctrl + Alt + Z (⌘ + ⌥ + Z)
Insert comments	Ctrl + Alt + X (⌘ + ⌥ + X)
Insert QR codes	Ctrl + Alt + Q (⌘ + ⌥ + Q)
<b>Page Layout</b>	
Open page setup dialog box	F6 (Fn + F6)
<b>View</b>	
Present from the beginning	F5 (Fn + F5)
Present from the current page	Shift + F5 (⇧ + F5)
Zoom in	Ctrl + =; Ctrl + Mouse scroll wheel (⌘ + =)

Zoom out	Ctrl + -; Ctrl + Mouse scroll wheel (⌘ + -)
Show or hide shape data pane	F8
<b>Symbols</b>	
Open pencil tool	Alt + P (⌘ + P)
Open pen tool	P
Open move anchors tool	Ctrl + M (⌘ + M)
Open convert anchors tool	Ctrl + Shift + M (⌘ + ⬆ + M)
Save the selected shape as a new symbol	Ctrl + F11 (⌘ + F11)
Open or hide datasheet	F9



# Wondershare EdrawMax

Visualize, Innovate, And Collaborate With  
EdrawMax



[www.edrawsoft.com](http://www.edrawsoft.com)



[support@edrawsoft.com](mailto:support@edrawsoft.com)



[www.facebook.com/edrawsoft](http://www.facebook.com/edrawsoft)



[www.linkedin.com/company/edrawsoft](http://www.linkedin.com/company/edrawsoft)



[www.twitter.com/edrawsoft](http://www.twitter.com/edrawsoft)



[www.youtube.com/c/cutedrawedwin/videos](http://www.youtube.com/c/cutedrawedwin/videos)



[www.pinterest.com/edrawsoft/\\_created](http://www.pinterest.com/edrawsoft/_created)



[www.instagram.com/wondershare\\_edrawsoft](http://www.instagram.com/wondershare_edrawsoft)

---