

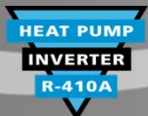

SUPER MULTI PLUS

For Residential & Light Commercial Applications



4-Ton 8 Zone Multi-Split Heat Pump System

EXPERTISE AND INNOVATION

The Super Multi PLUS Split System is the ultimate, flexible solution for individual zone comfort. Connecting up to 8 indoor units to a single outdoor unit reduces installation space and costs while maximizing comfort and energy savings. With a choice of three indoor unit types in a wide range of capacities, the Super Multi Plus allows mixed and matched combinations for absolute comfort in almost any residential application.



ENERGY EFFICIENCY

Up to

18.8 SEER
11.3 HSPF

Integrated with an inverter “variable speed” compressor, Daikin Super Multi PLUS systems deliver the capacity required to maintain desired room conditions, typically reducing energy consumption by 30% compared to traditional fixed speed systems. This technology minimizes temperature fluctuations and provides continuous cooling and heating comfort with maximum energy savings.

INDIVIDUAL COMFORT AND CONTROL

The standard wireless controller provides individual temperature control at the click of the button. Most Indoor units are also compatible with the new Daikin ENVi intelligent thermostat, offering a more advanced solution, designed with energy savings performance in mind. With the freedom to access, program and control the system from a smart phone, tablet, or computer, users can have peace of mind - anytime, anywhere.



Note: The Daikin ENVi thermostat is not compatible with the FFQ Indoor Units

BUILT-IN RELIABILITY



All major components are engineered and manufactured by Daikin, ensuring maximum performance, reliability and efficiency. The standard warranty provides a solid level of protection on the Super Multi PLUS system. Systems installed by an authorized Daikin Dealer who has completed Daikin’s advanced training can take advantage of Warranty Plus – the best warranty in the industry.

Find a Daikin Dealer near you at www.daikinac.com.

DESIGN FLEXIBILITY

The Super Multi PLUS Split System can be combined with a variety of ducted and ductless models with a total of 15 indoor unit variations.

| Indoor Unit Availability | | | | | | |
|--------------------------|----------|-------|--------|--------|--------|--------|
| | Capacity | | | | | |
| Indoor Type | 7 MBH | 9 MBH | 12 MBH | 15 MBH | 18 MBH | 24 MBH |
| Wall Mount | ● | ● | ● | ● | ● | ● |
| Slim Duct | | ● | ● | ● | ● | ● |
| 2' x 2' Cassette | | ● | ● | ● | ● | |

CTXS_H, CTXS_LV, FTXS_LV

Wall Mounted Unit

Blends with any décor with it's sleek and sophisticated design

Enhanced indoor air quality with the titanium apatite photocatalytic air purification filter which absorbs microscopic particles and decomposes odors

Increased energy savings with the intelligent eye function which reduces operation in unoccupied spaces



FDXS_LV, CDXS_LV

Concealed Slim Duct

Maximized floor and wall space with it's compact and concealed design

Undisturbed comfort with low operating sound levels

Cleaner air with the removal of airborne dust particles by the standard mold proof air filter

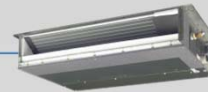

FFQ_LV **NEW!**

2' X 2' Ceiling Cassette

Enhanced comfort with uniform airflow and temperature distribution

Draught free protection with horizontal air discharge

Simple installation with an easy-to-fit decoration panel that blends with any interior design

Easy maintenance with an easy-to-clean grille and washable long life filter



BPMKS

Branch Provider Unit

Varies the refrigerant volume to meet the cooling or heating requirements of each room connected to the system.

Facilitates zone on/off and capacity control to operate rooms individually via zone temperature controls

Simple installation with flare nut connections

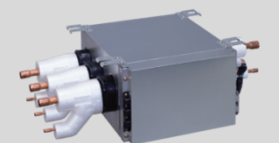

REFNET joint

Reduces the amount of work involved in installation and increases the reliability of the system.

LEADING TECHNICAL PERFORMANCE

Up to 8 indoor units can be connected to a single outdoor unit

A High Efficiency solution with optimum flexibility to provide zoning for with the connection of up to 8 indoor units utilizing long pipe lengths, ease of installation with standardized line-sets, simplified electrical requirements and staged installations

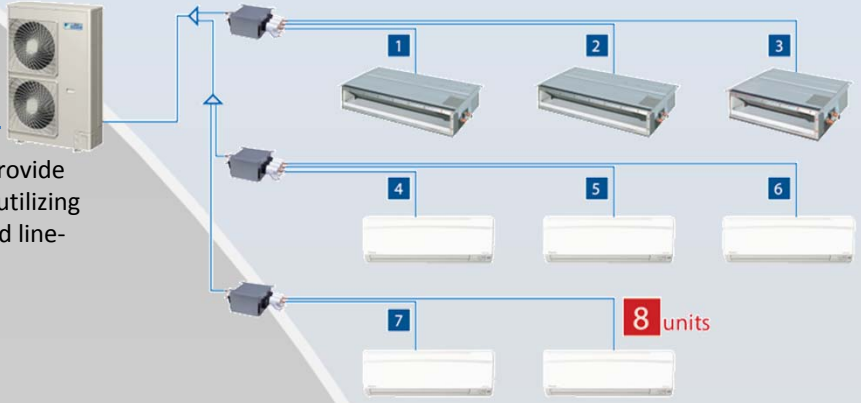

| Outdoor Units – RMXS48LVJU | | |
|---|----------------------|-----------------------------|
| Model Name | RMXS48LVJU | |
| Nominal Capacity (Cooling / Heating) | Btu/h | 48,000 / 54,000 |
| SEER / HSPF | Non Ducted | 18.8 / 11.3 |
| | Mixed | 16.5/10.5 |
| | Ducted | 14.1/9.6 |
| EER / COP | Non Ducted | 10.3/3.0 |
| | Mixed | 9.8/2.9 |
| | Ducted | 9.3/2.7 |
| Power Supply | 208/230V - 1Ø - 60Hz | |
| Minimum Circuit Amps | A | 27.0 |
| Maximum Overcurrent Protection | A | 30.0 |
| Sound Pressure - (Cooling/Heating) | dB(A) | 56/58 |
| Connection Ratio (Max Capacity for BPMKS Boxes) | 50 - 130% | |
| Number of Connectable Indoor Units | 2 to 8 | |
| Number of Connectable BP Units | 1 to 3 | |
| Total System Piping Length | ft. (m) | 440 (135) |
| Max. Piping Length(OU to BP Box) | ft. (m) | 180 (55) |
| Max. Piping Length(IU to BP Box) | ft. (m) | 49 (15) |
| Total Piping Length (OU to BP Box) | ft. (m) | 180 (55) |
| Total Piping Length (BP to IU) | ft. (m) | 262 (80) |
| Max. Piping Height (OU to IU) | ft. (m) | 98 (30) |
| Max. Piping Height (IU to BP Box) | ft. (m) | 98 (30) |
| Max. Piping Height (BP to BP Box) | ft. (m) | 49 (15) |
| Piping Connection Kit | KHRP26A22T | |
| Operating Range – (Cooling/Heating) | °F DB | 23 – 115/5 - 75 |
| Dimensions (H x W x D) | in. | 52-15/16 x 35-7/16 x 12-5/8 |
| Net Weight | lbs. | 283.0 |

| BP Units | | Up to 2 Zones | Up to 3 Zones | |
|------------------------------------|-----------------|----------------------------|---------------|-----------|
| Model Name | | BPMKS048A2U | BPMKS049A3U | |
| Power Supply | | Single phase 60Hz 208/230V | | |
| Power Consumption | W | 10 | 10 | |
| Running Current | A | 0.05 | 0.05 | |
| Sound Pressure - (Cooling/Heating) | dB(A) | 32/32 | 32/32 | |
| Number of Connectable Indoor Units | | 1 to 2 | 1 to 3 | |
| Min. Connection Combination | | 7,000 | 7,000 | |
| Max. Connection Combination | | 48,000 | 62,000 | |
| Piping Connections (O.D.) | Liquid | Outdoor Unit Side | in. Ø 1/4 x 2 | Ø 1/4 x 3 |
| | | Indoor Unit Side | in. Ø 1/4 x 2 | Ø 1/4 x 3 |
| | Gas | Outdoor Unit Side | in. Ø 5/8 x 2 | Ø 5/8 x 3 |
| | | Indoor Unit Side | in. Ø 5/8 x 2 | Ø 5/8 x 3 |
| | Connection Type | Flare | | |
| Dimensions (H x W x D) | in. | 7-1/16 x 11-9/16 x 13-3/4 | | |
| Net Weight | lbs. | 18.0 | 20.0 | |

Nominal Conditions:
 Cooling Mode: Indoor: 80 °F DB / 67 °F WB, Outdoor: 95 °F DB, Pipe Length: 25 ft, Level Difference: 0 ft.
 Heating Mode: Indoor: 70 °F DB, Outdoor: 47 °F DB / 43 °F WB, Pipe Length: 25 ft, Level Difference: 0 ft.

Note: Specifications are subject to change without notice.

| Indoor Units - CTXS_HVJU, CTXS_LVJU, and FTXS_LVJU Wall Mounted Units | | | 0.6-Ton | 0.75-Ton | 1.0-Ton | 1.25-Ton | 1.5-Ton | 2.0-Ton |
|---|------------------------------------|--------------------------|-----------------|---------------------------|---------------|-------------------------|-----------------|-----------------|
| Model Name | | | CTXS07LVJU | CTXS09HVJU | CTXS12HVJU | FTXS15LVJU | FTXS18LVJU | FTXS24LVJU |
| Airflow-Wet (H/M/L/SL) | CFM | | 332/261/194/145 | 388/335/283/- | 388/335/283/- | 568/477/385/360 | 583/484/385/360 | 643/494/350/328 |
| Airflow-Dry (H/M/L/SL) | CFM | | 350/290/233/219 | 400/357/314/- | 400/357/314/- | 593/505/417/371 | 625/526/431/399 | 699/572/445/403 |
| Sound Pressure - Cooling (H/M/L/SL) | dB(A) | | 38/32/25/22 | 44/40/35/- | 45/41/36/- | 45/40/35/32 | 46/41/36/33 | 51/44/37/34 |
| Sound Pressure - Heating (H/M/L/SL) | dB(A) | | 38/33/28/25 | 44/39/34/- | 45/40/35/- | 43/38/33/30 | 45/40/35/32 | 48/42/37/34 |
| Piping Connections | Liquid (O.D.) | in. | Ø 1/4 | Ø 1/4 | Ø 1/4 | Ø 1/4 | Ø 1/4 | Ø 1/4 |
| | Gas (O.D.) | in. | Ø 3/8 | Ø 3/8 | Ø 3/8 | Ø 1/2 | Ø 1/2 | Ø 5/8 |
| | Condensate Drain Connection (O.D.) | in. | Ø 5/8 | Ø 11/16 | Ø 11/16 | Ø 5/8 | Ø 5/8 | Ø 5/8 |
| Dimensions (H x W x D) | in. | 11-5/8 x 31-1/2 x 8-7/16 | | 11-7/16 x 31-5/16 x 9-3/8 | | 13-3/8 x 41-5/8 x 9-3/4 | | |
| Net Weight | lbs. | 20.0 | | 20.0 | | 31.0 | 31.0 | 31.0 |

| Indoor Units - FDXS_LVJU and CDXS_LVJU Slim Duct Units | | | 0.6-Ton | 0.75-Ton | 1.0-Ton | 1.25-Ton | 1.5-Ton | 2.0-Ton |
|--|------------------|---------------------------|-----------------|---------------------------|-----------------|-----------------|-----------------|---------|
| Model Name | | | FDXS09LVJU | FDXS12LVJU | CDXS15LVJU | CDXS18LVJU | CDXS24LVJU | |
| External Static Pressure | "W.G. | | 0.12 | 0.12 | 0.16 | 0.16 | 0.16 | |
| Airflow-Wet (H/M/L/SL) | CFM | | 305/280/260/235 | 305/280/260/235 | 424/388/353/297 | 424/388/353/297 | 424/388/353/297 | |
| Airflow-Dry (H/M/L/SL) | CFM | | 305/280/260/235 | 305/280/260/235 | 424/388/353/297 | 424/388/353/297 | 424/388/353/297 | |
| Sound Pressure - Cooling (H/M/L/SL) | dB(A) | | 35/33/31/- | 35/33/31/- | 37/35/33/31 | 37/35/33/31 | 37/35/33/31 | |
| Sound Pressure - Heating (H/M/L/SL) | dB(A) | | 35/33/31/- | 35/33/31/- | 37/35/33/31 | 37/35/33/31 | 37/35/33/31 | |
| Piping Connections | Liquid (O.D.) | in. | Ø 1/4 | Ø 1/4 | Ø 1/4 | Ø 1/4 | Ø 1/4 | |
| | Gas (O.D.) | in. | Ø 3/8 | Ø 3/8 | Ø 1/2 | Ø 1/2 | Ø 1/2 | |
| | Condensate Drain | in. | Ø 25/32 | Ø 25/32 | Ø 25/32 | Ø 25/32 | Ø 25/32 | |
| Dimensions (H x W x D) | in. | 7-7/8 x 27-9/16 x 24-7/16 | | 7-7/8 x 35-7/16 x 24-7/16 | | | | |
| Net Weight | lbs. | 47.0 | | 47.0 | | 60.0 | 60.0 | 60.0 |

| Indoor Units - FFQ_LVJU 2"x2" Duct Units | | | 0.6-Ton | 0.75-Ton | 1.0-Ton | 1.25-Ton | 1.5-Ton | 2.0-Ton |
|--|-------------------------|--------------------------|------------|------------|-------------|-------------|---------|---------|
| Model Name | | | FFQ09LVJU | FFQ12LVJU | FFQ15LVJU | FFQ18LVJU | | |
| Airflow Rate (H/L) | CFM | | 318/230 | 353/230 | 424/283 | 530/353 | | |
| Sound Pressure - Cooling (H/L) | dB(A) | | 35/33/31/- | 35/33/31/- | 37/35/33/31 | 37/35/33/31 | | |
| Sound Pressure - Heating (H/L) | dB(A) | | 35/33/31/- | 35/33/31/- | 37/35/33/31 | 37/35/33/31 | | |
| Piping Connections | Liquid (O.D.) | in. | Ø 1/4 | Ø 1/4 | Ø 1/4 | Ø 1/4 | | |
| | Gas (O.D.) | in. | Ø 3/8 | Ø 3/8 | Ø 1/2 | Ø 1/2 | | |
| | Condensate Drain (O.D.) | in. | Ø 1-1/32 | Ø 1-1/32 | Ø 1-1/32 | Ø 1-1/32 | | |
| Dimensions – Unit (H x W x D) | in. | 11-1/4 x 22-5/8 x 22-5/8 | | | | | | |
| Dimensions – Deco Panel (H x W x D) | in. | 2-1/4 x 27-5/8 x 27-5/8 | | | | | | |
| Net Weight | lbs. | 38.5 | | 38.5 | | 38.5 | 38.5 | |

TIME-SAVING INSTALLATION AND EASE

Longer Refrigerant Piping

Longer refrigerant piping capabilities offers much more flexibility in the choice of installation positions for the indoor units, and greatly simplifies system layout.

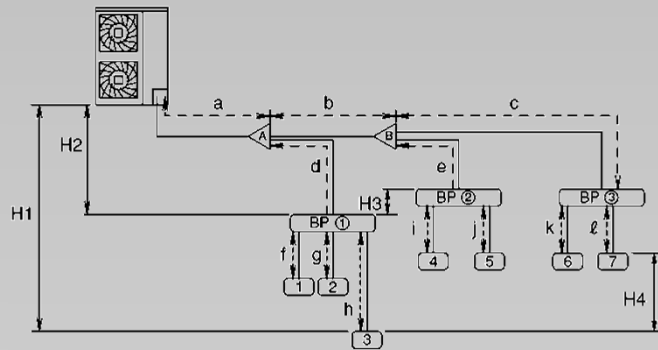

| Piping Requirements | | Allowable Length Details | |
|--|----------------------------------|--|---|
| Maximum allowable length | Between outdoor and BP units | Total piping length | Piping length between outdoor and BP units ≤ 180 ft (55 m) - [Example] $a+b+c+d+e \leq 180$ ft |
| | Between BP and indoor units | Total piping length | Piping length between BP and indoor units: 262 ft (80 m) - [Example] $f+g+h+i+j+k+l \leq 262$ ft |
| | Between BP and indoor unit | 1 room length | Piping length between BP and indoor unit ≤ 49 ft (15 m) - [Example] $f, g, h, i, j, k, l \leq 49$ ft |
| Allowable height | Between outdoor and indoor units | Difference in height | Difference in height between outdoor and indoor units ($H1$) ≤ 98 ft (30 m) |
| | Between outdoor and BP units | | Difference in height between outdoor and BP units ($H2$) ≤ 98 ft (30 m) |
| | Between BP and BP units | | Difference in height between BP and BP units ($H3$) ≤ 49 ft (15 m) |
| | Between indoor and indoor units | | Difference in height between indoor and indoor units ($H4$) ≤ 49 ft (15 m) |
| Minimum allowable length | Piping length | Pipe length between outdoor unit and first refrigerant branch kit (refnet joint) ≥ 16.4 ft [Example] $a \geq 16.4$ ft | |
| Allowable length after the REFNET branch | | Piping length from first refrigerant branch kit (REFNET joint) to indoor unit ≤ 131 ft (40 m) [Example] unit 6: $b+c+k \leq 131$ ft [Example] unit 5: $b+e+i \leq 131$ ft [Example] unit 3: $d+h \leq 131$ ft | |
| Additional refrigerant calculation | | $R = \left(\frac{\text{Total length (ft / m)}}{\text{of liquid piping size at } \phi 3/8 \text{ inch } (\phi 9.5 \text{ mm})} \right) \times 0.036 \text{ lb./ft. } (0.054 \text{ kg/m}) + \left(\frac{\text{Total length (ft / m)}}{\text{of liquid piping size at } \phi 1/4 \text{ inch } (\phi 6.4 \text{ mm})} \right)$ | |

Simplified Electrical Wiring

The outdoor unit and BP units operate from separate 208/230V single-phase power supplies. Indoor units are powered from the BP unit and wired as Daikin's current 4 wire single split systems reducing the wiring size and easing installation

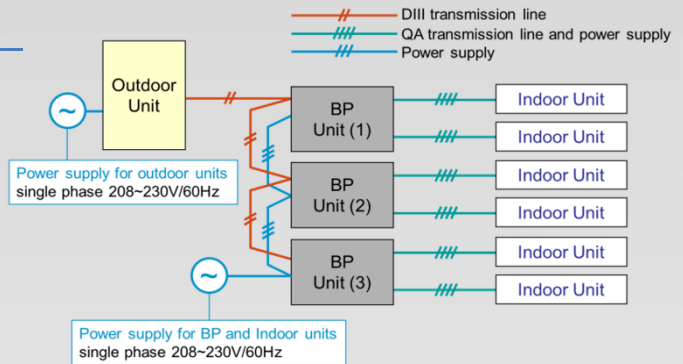

Space Saving Design

More than 60% in physical space savings
More than 80% in total (including clearances) space savings

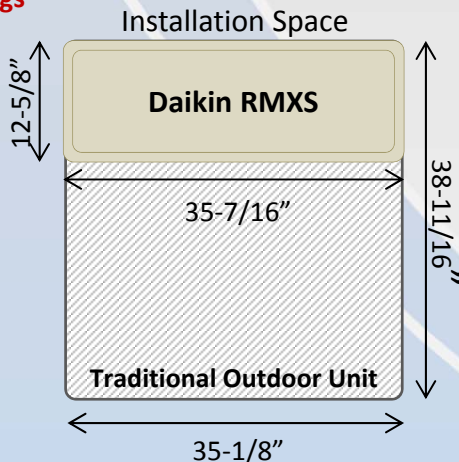

System Operation Range

| | |
|-------------------|--|
| Cooling Operation | 23 °FDB – 115 °FDB Ambient Temperature |
| | 57 °FWB – 82 °FDB Indoor Room Temperature |
| Heating Operation | 5 °FDB – 60 °FWB Ambient Temperature |
| | 50 °FDB – 82 °FDB Indoor Room Temperature |

Note: No low ambient option exists with this product line.

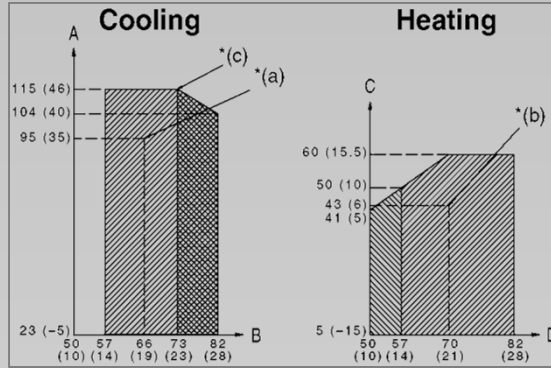

WARNINGS:

- Always use a licensed installer or contractor to install this product. Do not try to install the product yourself. Improper installation can result in water or refrigerant leakage, electrical shock, fire or explosion.
- Use only those parts and accessories supplied or specified by Daikin. Ask a licensed contractor to install those parts and accessories. Use of unauthorized parts and accessories or improper installation of parts and accessories can result in water or refrigerant leakage, electrical shock, fire or explosion.
- Read the User's Manual carefully before using this product. The User's Manual provides important safety instructions and warnings. Be sure to follow these instructions and warnings.

For any inquiries, contact your local Daikin sales office.



Use of the AHRI Certified™ mark indicates a manufacturer's participation in the certification program. For verification of certification for individual products, go to www.ahridirectory.org

© 2013 Daikin Industries, Limited.

Daikin, Daikin AC Absolute Comfort, and its design, VRV, REFNET, Quaternity, Daikin Altherma are trademarks of Daikin Industries, LTD.

www.likin-daikin.com

Distributor or Dealer Information:

Daikin AC (Americas), Inc.
1645 Wallace Drive, Suite 110
Carrollton, TX 75006
www.daikinac.com
866.4DAIKIN
972.245.1510

PFSMPUSE13-01R

For all equipment installation & application limitations please refer to the specific Engineering Data Books. Daikin's products are subject to continuous improvements. Daikin reserves the right to modify product design, specifications and information in this brochure without notice and without incurring any obligations.