

CONCRETE BASICS A Guide to Concrete Practice

CONTENTS

Foreword	page 2
CHAPTER 1 Concrete Materials	pages 3–5
CHAPTER 2 Concrete Properties	pages 6–9
CHAPTER 3 Concrete Testing	pages 10–13
CHAPTER 4 Ordering Concrete	page 14
CHAPTER 5 Proportioning and Mixing Concrete	pages 15–16
CHAPTER 6 Planning and Site Preparation	pages 17–19
CHAPTER 7 Transporting and Placing Concrete	pages 20–22
CHAPTER 8 Compacting Concrete	pages 23–25
CHAPTER 9 Finishing Concrete	pages 26–27
CHAPTER 10 Curing Concrete	pages 28–30
CHAPTER 11 Joints in Concrete	pages 31–33
CHAPTER 12 Hot and Cold Weather Concreting	pages 34–35
CHAPTER 13 Surface Finishes on Concrete	pages 36–39
CHAPTER 14 Defects in Concrete	pages 40–43
CHAPTER 15 Removing Stains from Concrete	pages 44–46
CHAPTER 16 Cracking in Concrete	pages 47–49
CHAPTER 17 Reinforced Concrete	pages 50–52
CHAPTER 18 Formwork	pages 53–54
MORE Information	pages 55–56

First Published July 1991
Second Edition 1992
Third Edition 1994
Fourth Edition 1996
Fifth Edition October 2002
Sixth Edition August 2004

Cement Concrete & Aggregates Australia

Cement Concrete & Aggregates Australia is a not for profit organisation sponsored by the cement concrete and aggregate industries in Australia to provide information on the many uses of cement and concrete. This publication is produced by CCAA for that purpose. Since the information provided is intended for general guidance only and in no way replaces the services of professional consultants on particular projects, no legal liability can be accepted by CCAA for its use.

Foreword

Concrete is widely used in domestic, commercial, recreational, rural and educational construction.

Communities around the world rely on concrete as a safe, strong and simple building material. It is used in all types of construction; from domestic work to multi-storey office blocks and shopping complexes.

Despite the common usage of concrete, few people are aware of the considerations involved in designing strong, durable, high quality concrete.

Concrete Basics aims to provide a clear, concise explanation of all aspects of making quality concrete; from the Materials and Properties involved through Planning, Preparation, Finishing and Curing.

Concrete Basics addresses the needs of unskilled and semi-skilled persons undertaking general concreting projects including home and handyman projects. *Concrete Basics* also assists owner builders in the supervision of construction. It aims to develop an understanding of highly technical terms through clear definition accompanied by simple illustrations. A general understanding of these terms will help to facilitate communication within the building industry.

Concrete Basics will help to generate a higher standard of workmanship on-site and facilitate better communication among construction workers, builders, engineers, building surveyors, architects and anyone interested in understanding the processes involved in making quality concrete.

CHAPTER 1 Concrete Materials

CONCRETE is made by mixing:
 CEMENT
 WATER
 COARSE AND FINE AGGREGATES
 ADMIXTURES (if required).

The aim is to mix these materials in measured amounts to make concrete that is easy to:
 TRANSPORT
 PLACE
 COMPACT
 FINISH

and which will set, and harden, to give a strong and durable product.

The amount of each material (ie cement, water and aggregates) affects the properties of hardened concrete.

(See CHAPTER 2 Concrete Properties)

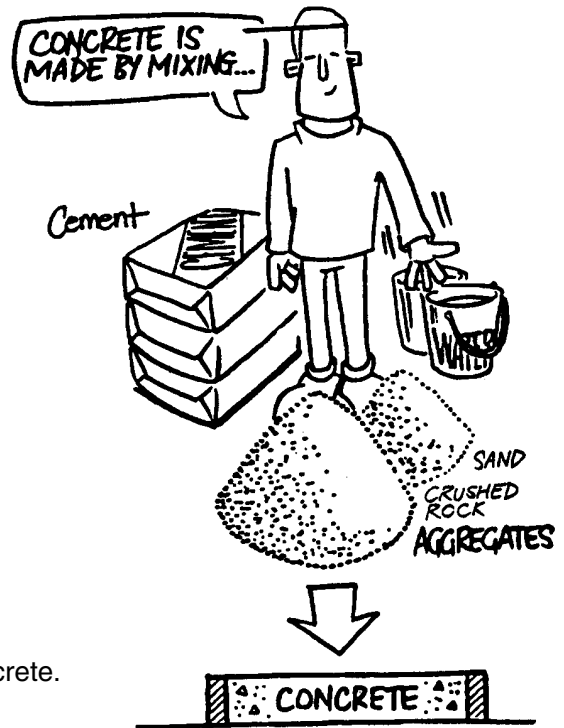

CEMENT The cement powder, when mixed with water, forms a paste.

This paste acts like glue and holds or bonds the aggregates together.

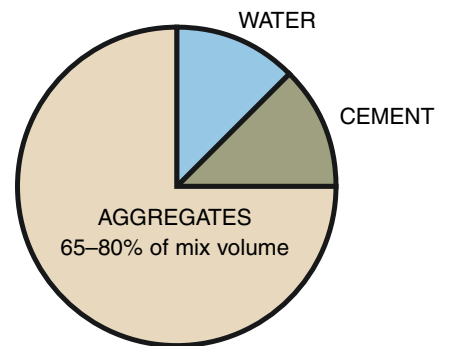
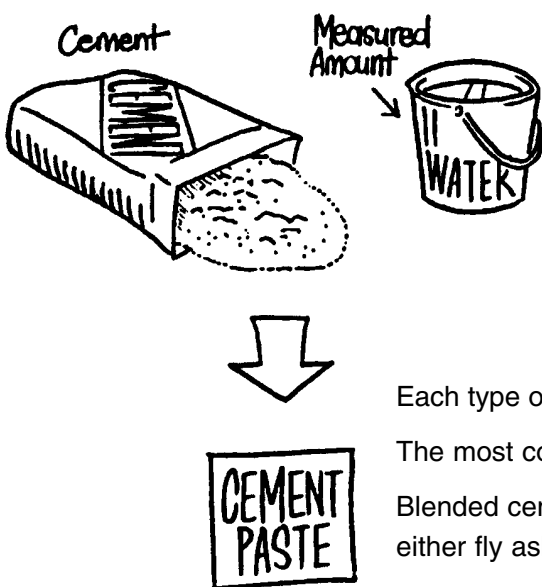

There are six major types of cement sold in Australia:

- Type GP (General Purpose Portland cement)
- Type GB (General Purpose Blended Cement)
- Type HE (High Early Strength cement)
- Type LH (Low Heat cement)
- Type SR (Sulfate Resisting cement)
- Type SL (Shrinkage Limited cement)

Each type of cement will produce concrete with different properties.

The most common types of cement are Type GP and Type GB.

Blended cements contain portland cement and more than 5% of either fly ash, ground slag, silica fume, or a combination of these.

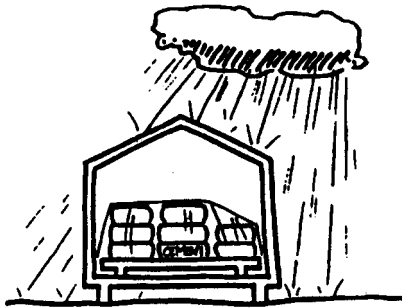

STORAGE Cement should be stored off the ground in a well-aired, clean, dry place.

Wrapping the cement bags in plastic sheets gives extra protection,

Bulk cement will normally be stored in silos.

AGGREGATES Aggregates are of two basic types:

COARSE: crushed rock, gravel or screenings.

FINE: fine and coarse sands and crusher fines.

Sand should be concreting sand and not brickies sand or plasterers sand.

Aggregates should be:

STRONG and HARD A stronger, harder aggregate will give a stronger final concrete. Never use a crumble or flakey rock like sandstone.

DURABLE to stand up to wear and tear and weathering.

CHEMICALLY INACTIVE so the aggregates don't react with the cement.

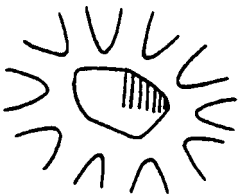
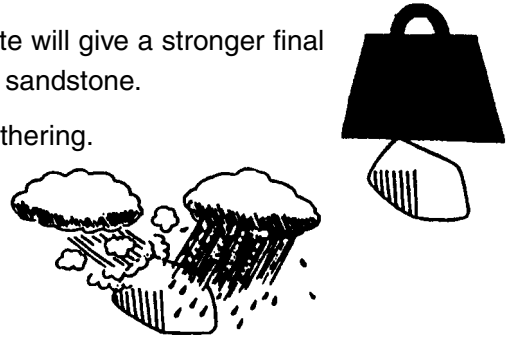

CLEAN Dirt or clay sticking to the aggregates will weaken the bond between paste and aggregates.

GRADED Aggregates should range in size so that they fit together well. This gives a stronger and denser concrete.



Rounded aggregates give a more workable mix. Angular aggregates make concrete harder to place, work and compact, but can make concrete stronger.

STORAGE Aggregates should be stored where they will stay clean, separated from other materials and dry. If the aggregates are very wet use less water in the mix.



WATER Water is mixed with the cement powder to form a paste which holds the aggregates together like glue.

Water must be clean, fresh and free from any dirt, unwanted chemicals or rubbish that may affect concrete.

Many concrete plants now use recycled water.



Always check bore water before use.

Don't use sea water as it may rust the steel reinforcement in the concrete.

ADMIXTURES Admixtures are mixed into the concrete to change or alter its properties, ie the time concrete takes to set and harden, or its workability.

HOW THE PROCESS WORKS Measured amounts of the coarse and fine aggregates are mixed together.

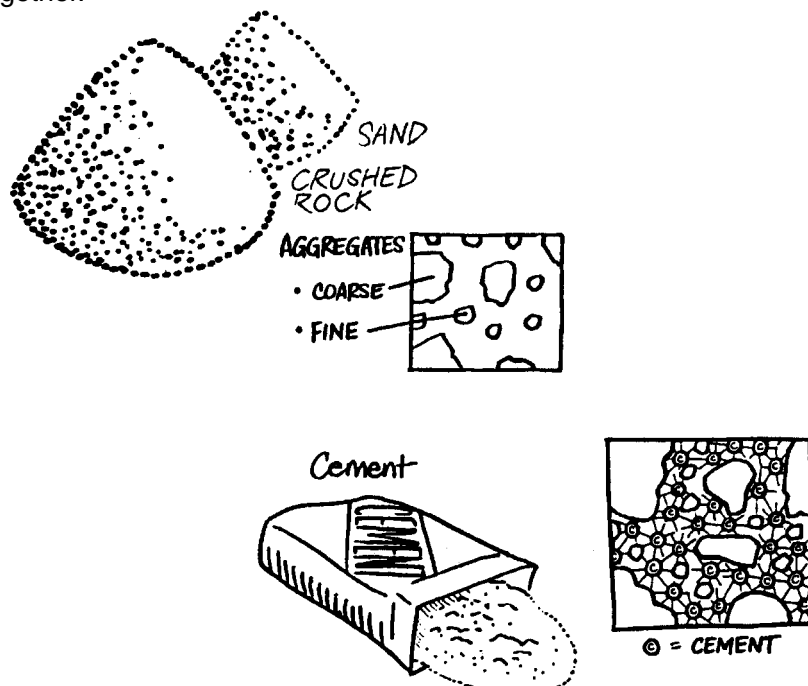

A measured amount of cement is added and mixed in.

Enough water is added to make the mix workable. All the materials are then mixed together well. The cement powder and water form a paste which bonds the aggregates together like glue.

CHAPTER 2 Concrete Properties

The Properties of Concrete are its characteristics or basic qualities.

The four main properties of concrete are:

WORKABILITY
COHESIVENESS
STRENGTH and
DURABILITY

Concrete has three different states:

PLASTIC
SETTING
HARDENING

In each state it has different properties.



CONCRETE STATES

Plastic State When the concrete is first mixed it is like 'bread dough'. It is soft and can be worked or moulded into different shapes. In this state concrete is called PLASTIC. Concrete is plastic during placing and compaction.

The most important properties of plastic concrete are workability and cohesiveness.

A worker will sink into plastic concrete.

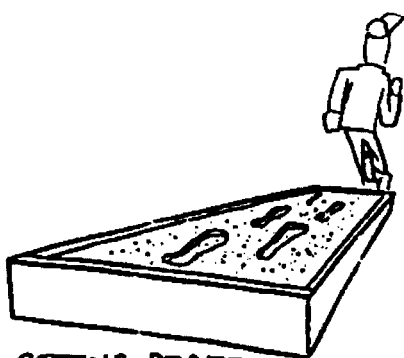
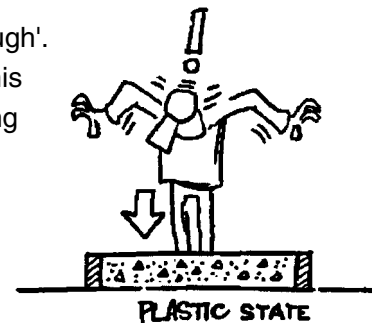

SETTING STATE

Setting State Concrete then begins to stiffen. The stiffening of concrete, when it is no longer soft, is called SETTING. Setting takes place after compaction and during finishing.

Concrete that is sloppy or wet may be easy to place but will be more difficult to finish.

A worker leaves footprints in setting concrete.

Hardening State After concrete has set it begins to gain strength and harden. The properties of hardened concrete are strength and durability.

Hardened concrete will have no footprints on it if walked on.

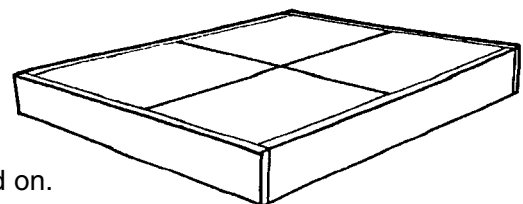

Strength and Durability Well made concrete is a naturally strong and durable material. It is DENSE, reasonably WATERTIGHT, able to resist changes in TEMPERATURE, as well as wear and tear from WEATHERING.

Strength and Durability are affected by the density of the concrete. Denser concrete is more watertight (or less permeable).

Concrete durability INCREASES with strength.

Well made concrete is very important to protect the steel in reinforced concrete.

See CHAPTER 17 Reinforced Concrete

Strength of concrete in the hardened state is usually measured by the COMPRESSIVE STRENGTH using the Compression Test.

See CHAPTER 3 Concrete Testing

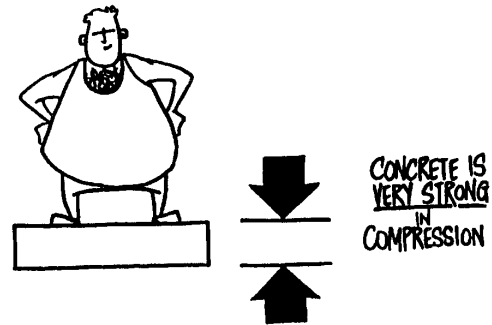

Strength and Durability are affected by:

COMPACTION Compaction is removing the air from concrete. Proper compaction results in concrete with an increased density which is stronger and more durable.

See CHAPTER 8 Compacting Concrete

CURING Curing is keeping concrete damp for a period, to allow it to reach maximum strength. Longer curing will give more durable concrete.

See CHAPTER 10 Curing Concrete

WEATHER Warmer weather will cause concrete to have a higher early strength.

See CHAPTER 12 Hot and Cold Weather Concreting

TYPE OF CEMENT Different types of cement will affect concrete properties: ie how quickly or slowly concrete gains strength.

THE WATER TO CEMENT RATIO Too much water and not enough cement means concrete will be weaker and less durable.

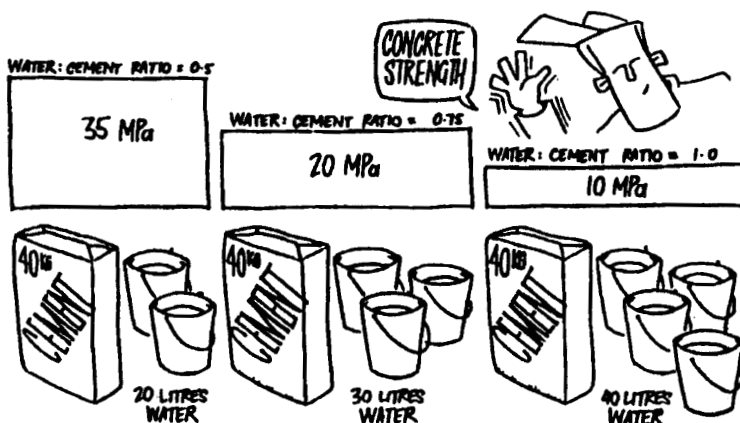

The water to cement ratio (W/C) is the weight of the water divided by the weight of cement.

$$W/C = \frac{\text{Water}}{\text{Cement}} \text{ ie } \frac{20 \text{ litres}}{40 \text{ kg}} = 0.5$$

Note: 1 litre of water weighs 1 kilogram.

The lower the ratio, the stronger the concrete.

Cohesiveness

Cohesiveness is how well concrete HOLDS TOGETHER when plastic.

Cohesiveness is affected by:

THE AGGREGATE GRADING

Graded Aggregate means that there is a range of size of aggregates, from large rocks to small sands. Well-graded aggregates give a more cohesive mix, too much coarse aggregate gives a boney mix.

WATER CONTENT

A mix that has too much water will not be cohesive and may separate and bleed.

CHAPTER 3 Concrete Testing

There are two main tests to be done on concrete:

The SLUMP test.

The SLUMP test shows the WORKABILITY of concrete.

Workability measures how easy the concrete is to place, handle and compact.

See CHAPTER 2 Concrete Properties

The COMPRESSION test.

The COMPRESSION test shows the best possible strength concrete can reach in perfect conditions.

The compression test measures concrete strength in the hardened state.

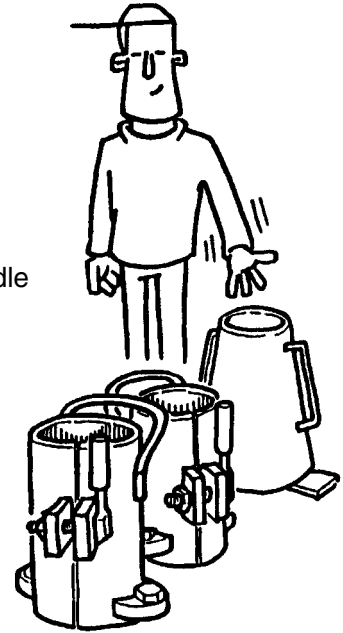

Testing should always be done carefully. Wrong test results can be costly.

SAMPLING The first step is to take a test sample from the large batch of concrete. This should be done as soon as discharge of the concrete commences. The sample should be representative of the concrete supplied.

The sample is taken in one of two ways:

For purposes of accepting or rejecting the load: Sampling after 0.2 m³ of the load has been poured.

For routine quality checks: Sampling from three places in the load.

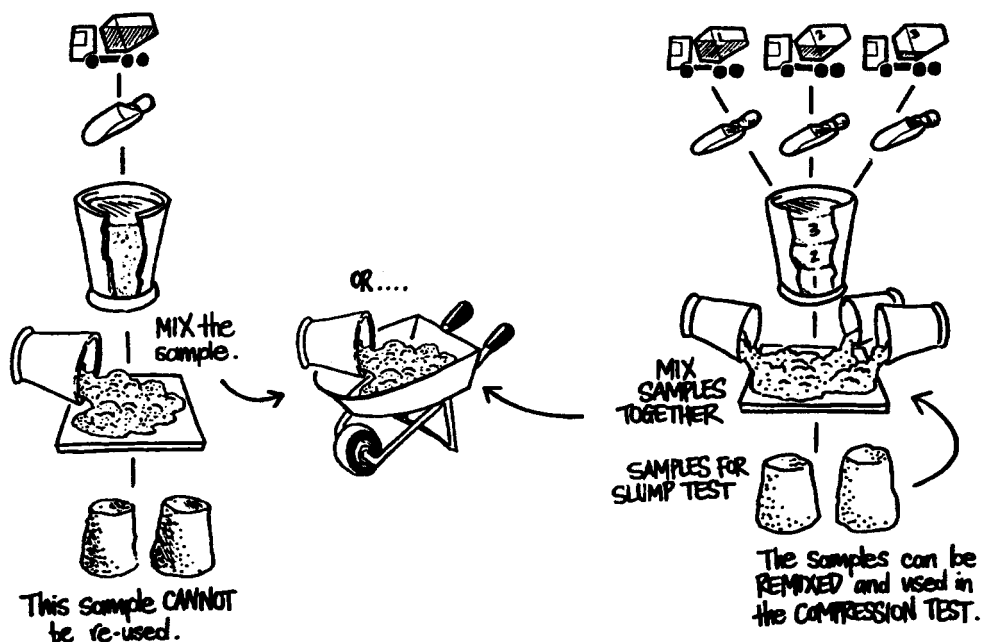

THE SLUMP TEST The slump test is done to make sure a concrete mix is workable. The measured slump must be within a set range, or tolerance, from the target slump.

Tools

Standard slump cone (100 mm top diameter x 200 mm bottom diameter x 300 mm high)

Small scoop

Bullet-nosed rod
(600 mm long x 16 mm diameter)

Rule

Slump plate (500 mm x 500 mm)

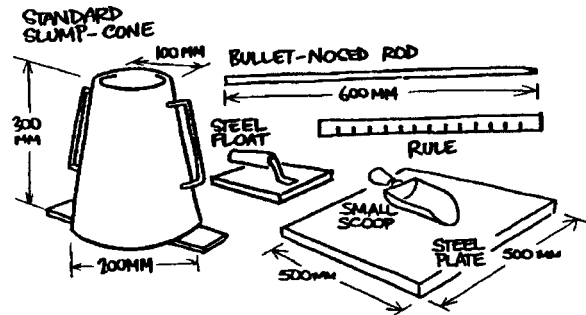

Method

1 Clean the cone. Dampen with water and place on the slump plate. The slump plate should be clean, firm, level and non-absorbent.

2 Collect a sample. [See Sampling](#)

3 Stand firmly on the footpieces and fill 1/3 the volume of the cone with the sample. Compact the concrete by 'rodding' 25 times.

Rodding Rodding means to push a steel rod in and out of the concrete to compact it into the cylinder, or slump cone. Always rod in a definite pattern, working from outside into the middle.

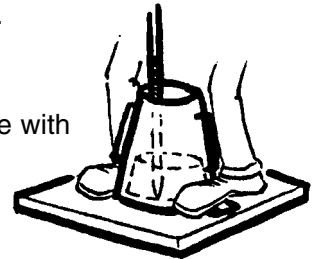

4 Now fill to 2/3 and again rod 25 times, just into the top of the first layer.

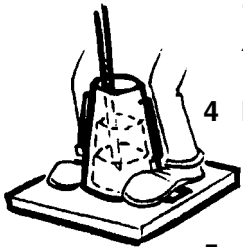

5 Fill to overflowing, rodding again this time just into the top of the second layer. Top up the cone till it overflows.

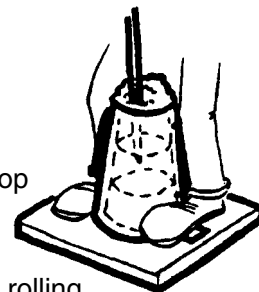

6 Level off the surface with the steel rod using a rolling action. Clean any concrete from around the base and top of the cone, push down on the handles and step off the footpieces.

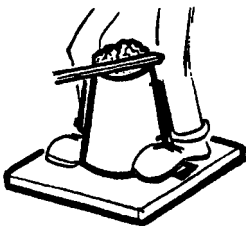

7 Carefully lift the cone straight up making sure not to move the sample.

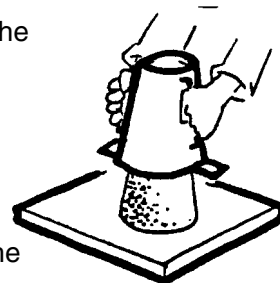

8 Turn the cone upside down and place the rod across the up-turned cone.

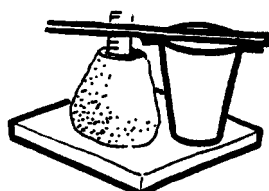

The Slump Test continues on the next page

- 9 Take several measurements and report the average distance to the top of the sample.

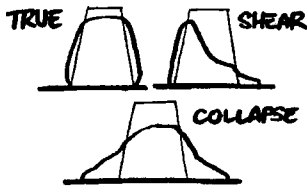
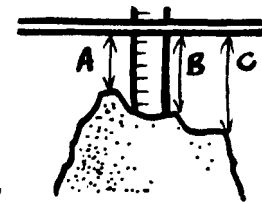

- 10 If the sample fails by being outside the tolerance (ie the slump is too high or too low), another must be taken. If this also fails the remainder of the batch should be rejected.

THE COMPRESSION TEST The compression test shows the compressive strength of hardened concrete. The testing is done in a laboratory off-site. The only work done on-site is to make a concrete cylinder for the compression test.

The strength is measured in Megapascals (MPa) and is commonly specified as a characteristic strength of concrete measured at 28 days after mixing. The compressive strength is a measure of the concrete’s ability to resist loads which tend to crush it.

Tools

Cylinders (100 mm diameter x 200 mm high or 150 mm diameter x 300 mm high)
 (The small cylinders are normally used for most testing due to their lighter weight)

Small scoop

Bullet-nosed rod (600 mm x 16 mm)

Steel float

Steel plate

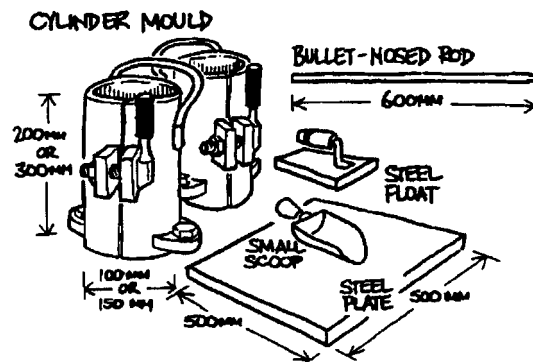

Method

- 1 Clean the cylinder mould and coat the inside lightly with form oil, then place on a clean, level and firm surface, ie the steel plate.
- 2 Collect a sample. [See Sampling](#)
- 3 Fill 1/2 the volume of the mould with concrete then compact by rodding 25 times. Cylinders may also be compacted by vibrating using a vibrating table.

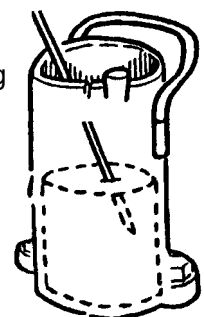

The Compression Test continues on the next page

CONTENTS

13

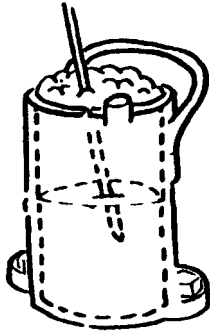

4 Fill the cone to overflowing and rod 25 times into the top of the first layer, then top up the mould till overflowing.

5 Level off the top with the steel float and clean any concrete from around the mould.

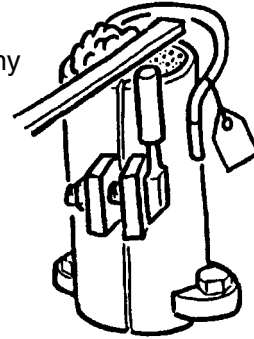

6 Cap, clearly tag the cylinder and put it in a cool dry place to set for at least 24 hours.

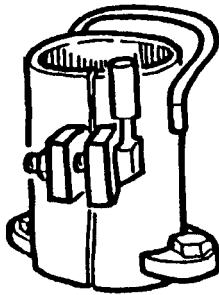
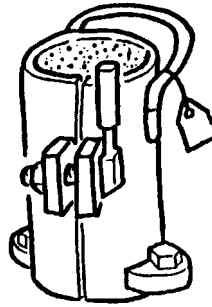

7 After the mould is removed the cylinder is sent to the laboratory where it is cured and crushed to test compressive strength.

CHAPTER 4 Ordering Concrete

WHEN ORDERING PRE-MIXED concrete you will need to tell the supplier:

Name and **address** for delivery

The **use** of the concrete (ie driveway, housing slab, commercial)

The **amount** you need in cubic metres

The **Class** of the concrete. There are two classes that concrete can be supplied as: Normal Class and Special Class.

NORMAL CLASS CONCRETE has a strength grade of N20, N25, N32, N40 and N50 with the corresponding characteristic strength of 20, 25, 32, 40 and 50 MPa at 28 days. The slump at the point of delivery should be 20–120 mm and the maximum size of coarse aggregate should be 10, 14 or 20 mm. Normal class concrete is suitable for most purposes. For most domestic applications such as driveways and paths grade N20 and N25 are the common grades ordered.

SPECIAL CLASS CONCRETE is specified when you have additional or alternative requirements to those for normal class concrete, eg lightweight aggregate, colour pigments, a non-standard strength grade. Special class concrete will not always be available from every concrete supplier.

The **slump** in millimetres (mm). The slump measured workability.

[See slump test in CHAPTER 3 Concrete Testing](#)

The **maximum aggregate size** (eg 20 mm).

How you want to **place** the concrete (eg pump, shovel, etc).

Time of the first truckload and the time between truckloads. There must be enough time to place and compact one load before the next arrives.

Any **admixtures** you may want in the concrete, though this is normally left to the pre-mixed concrete company.

Always **order more** concrete (ie 10%) than you need to allow for construction variations and/or some wastage. Concrete is ordered in 0.2 m³ increments.

Ensure you round up when ordering.

IF MIXING YOUR OWN concrete:

The cement powder is ordered in bags by weight (eg 20 kg) and type (eg Type GP).

The coarse and fine aggregates are ordered in cubic metres by maximum size (eg 20 m³ of size 20 mm).

Water is used by the litre or kilogram (1 litre of water = 1 kilogram).

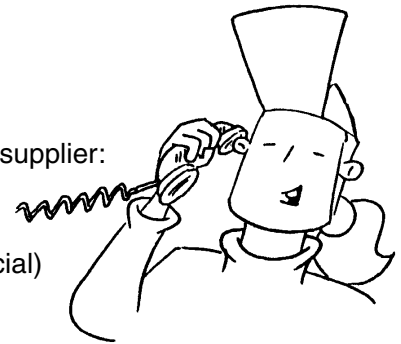

CHAPTER 5 Proportioning and Mixing Concrete

A CONCRETE MIX is designed to produce concrete that can be easily placed at the lowest cost.

The concrete must be workable and cohesive when plastic, then set and harden to give strong and durable concrete.

The mix design must consider the environment that the concrete will be in; ie exposure to sea water, trucks, cars, forklifts, foot traffic or extremes of hot and cold.

PROPORTIONING Concrete is a mixture of Cement, Water, Coarse and Fine Aggregates and Admixtures.

The proportions of each material in the mixture affects the properties of the final hardened concrete. These proportions are best measured by weight. Measurement by volume is not as accurate, but is suitable for minor projects.

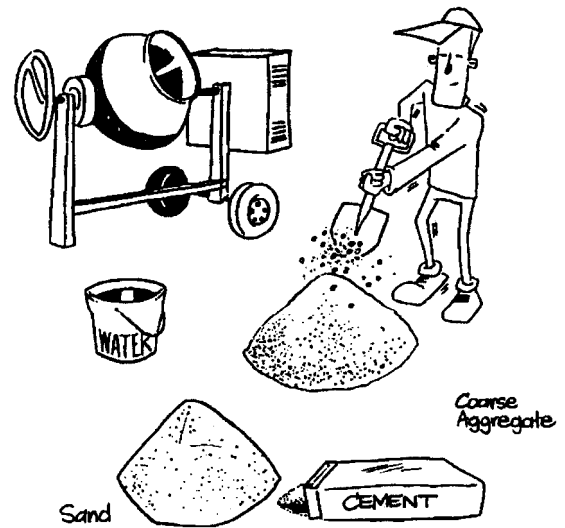

CEMENT CONTENT As the cement content increases, so does strength and durability. Therefore to increase the strength, increase the cement content of a mix.

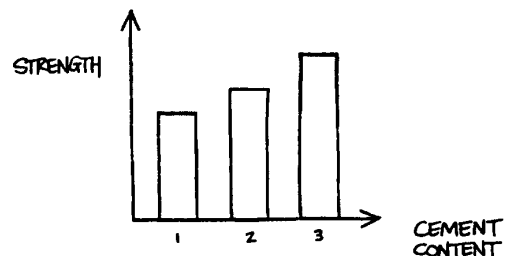

WATER CONTENT Adding MORE WATER to a mix gives a WEAKER hardened concrete. Always use as little water as possible, only enough to make the mix workable.

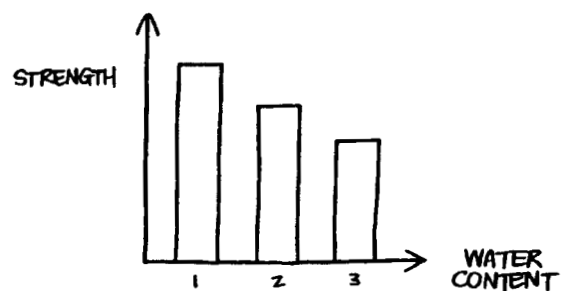

WATER TO CEMENT RATIO As the Water to Cement ratio INCREASES, the strength and durability of hardened concrete DECREASES. To increase the strength and durability of concrete, decrease the Water-Cement ratio.

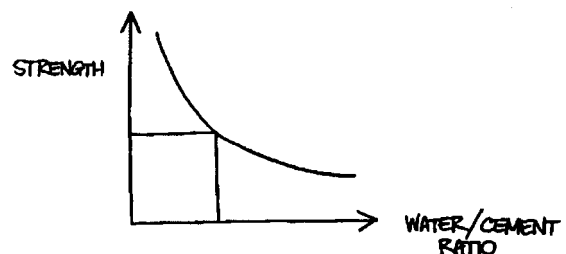

[See CHAPTER 2 Concrete Properties](#)

AGGREGATES Too much fine aggregate gives a sticky mix.

After compaction,
no stone in top few millimetres

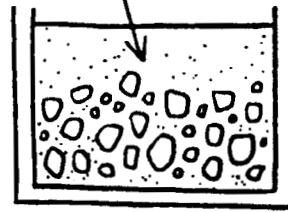

After compaction,
stones protrude

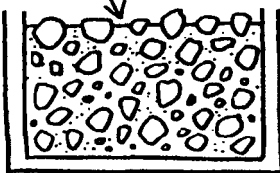

Too much coarse aggregate gives a harsh or boney mix.

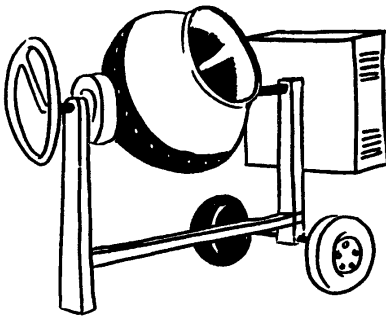

MIXING Concrete must be mixed so the Cement, Water, Aggregates and Admixtures blend into an even mix.

Concrete is normally mixed by MACHINE.

Machine mixing can be done on-site or be a Pre-Mixed concrete company. Pre-Mixed concrete is batched (proportioned) at the plant to the job requirements.

Truck Mixing The materials are normally added to the trucks at batching plants and mixed for required time and speed at the plant. The trucks drum continues to rotate to agitate the concrete as it is delivered to the site.

Site Mixing When site mixing begin by loading a MEASURED AMOUNT of coarse aggregate into the mixer drum. Add the sand before the cement, both in measured amounts.

NEVER USE A SHOVEL AS A MEASURE AS VOLUMES CAN VARY WIDELY.

Mix materials together until there is no visible sand in the mix.

Add enough water to get a workable mix.

Be careful not to overload the mixer. Too much concrete in the mixer means each batch takes longer to be properly mixed, which causes costly delays in the long run or it will not mix at all.

Always check how much the mixer holds so you know how much concrete can be produced at once.

Avoid delays between batches to get maximum output.

Small quantities of concrete may be mixed by hand with a shovel. Mixing should be done on a clean board, or plate, or in a wheelbarrow. Mix the materials together until they are even.

Then dish the material and add water. Use only enough water to get an even, workable mix. Finish mixing.

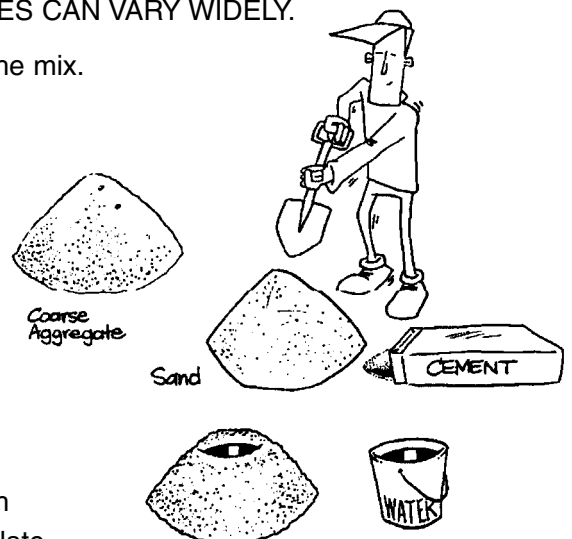

CHAPTER 6 Planning and Site Preparation



The most important step in placing concrete is planning.

Always plan every step before any concrete is delivered.

Proper planning avoids delays, wastage, segregation and problems which develop from these.

To eliminate problems of Delay, Segregation and Wastage,

see CHAPTER 7 Transporting and Placing Concrete

SAFETY Workers on the site should always wear protective clothing, strong boots and, if required, helmets or eye protection. Always avoid direct contact with cement and never kneel in or touch the concrete mix directly. Wear gloves or use barrier creams.

Ensure that anyone using heavy equipment, such as screeds or vibrators, has been properly trained.

The following steps should be taken before any concrete is placed.

MEASUREMENT Measure and stake out the area to be concreted and consider how thick the slab must be.

The thickness will depend on the weight the concrete must carry (ie driveway carries the weight of a car and needs to be thicker than a garden path).

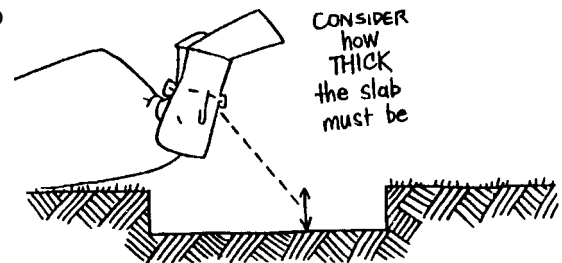

THE FINISHING LEVEL Once the thickness of concrete has been established, work out where the concrete will finish. Concrete cannot finish too high against steps or the external house wall and should not cover any part of weepholes in the wall. The finishing level shows how much digging or excavation must be done. Pavements must grade away from buildings and boundaries.

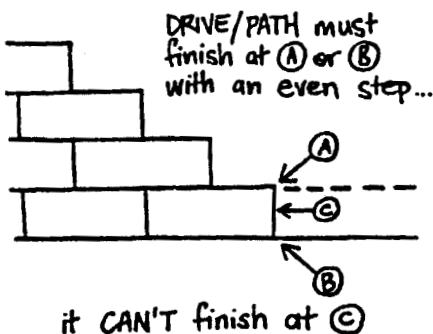

STEPS Steps must have even risers.

EXCAVATION The ground should be excavated as deep as is required by the finishing levels. Any roots or grass must be dug out until there is firm soil to place on. Always dig the hole wider than needed to allow for the formwork. Try to keep the edges and corners square.

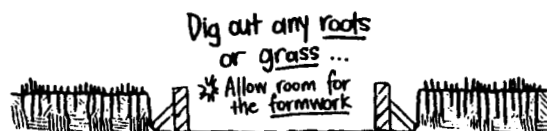

SUBGRADE The soil a concrete pavement or floor rests on is called the subgrade. If the soil is soft or varies in softness, a layer of crushed rock should be used. If there are only a few poor areas these can be dug out, refilled and compacted. It is important that the soil evenly supports the concrete.

Many later problems can be avoided by properly preparing the subgrade.

FORMWORK Formwork gives concrete its shape, Formwork must be properly braced so it is strong. It should not flex or move.

See CHAPTER 18 Formwork

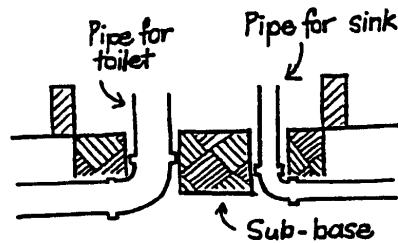
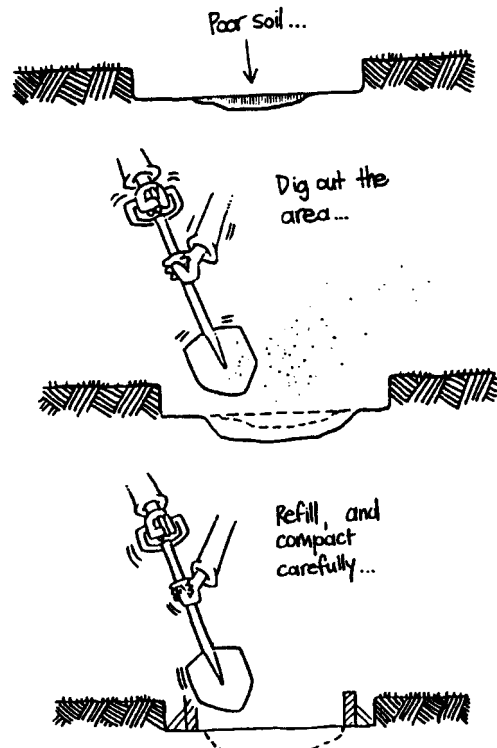

ANY SERVICES RUNNING THROUGH THE CONCRETE SHOULD BE IN PLACE

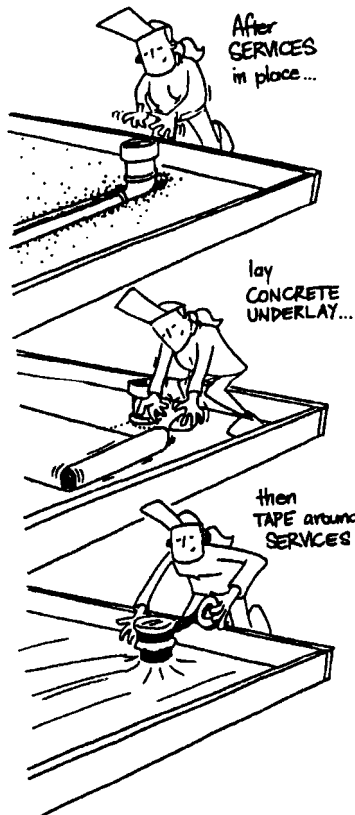

SERVICES Plumbing, heating or electrical services often run through a slab. These must be in place before any concrete is poured.

UNDERLAY AND SERVICES The underlay, or vapour barrier, is a heavy plastic covering the ground to minimise water vapour rising through the hardened concrete. Always overlap the sheets a minimum of 200 mm and do not tape them. Tape the edges of underlay only around drainage pipes or services which pass vertically through the concrete slab.

Termite protection may be required around service penetrations and round the perimeter of the slab.

REINFORCEMENT LOCATION Reinforcement can be used to increase the strength of concrete and/or to help control cracking.

For house floors resting on the ground it is placed in the top 1/3 of slabs and in the bottom of trenches and footings.

The reinforcement must be covered by a set amount of concrete which protects the steel from rusting. This is called cover. The amount of cover depends on whether it is inside or outside and is measured to the top or bottom of the outer surface.

Reinforcement should be securely held for slab on ground construction. It should overlap a set distance or from one piece of reinforcing bar, or wire fabric, to another and at the corners of a trench.

[See CHAPTER 17 Reinforced Concrete](#)

ACCESS Clear access must be provided to transport the concrete.

If concrete is to be delivered by trucks make sure they have unrestricted access to the site in all weather conditions.

PLACEMENT Ensure all planning and site preparation takes into account how concrete will be placed allowing room for trucks, ramps for wheelbarrows, space for a pump etc.

JOINTS The position, type and number of joints should be planned well before the concrete is placed.

[See CHAPTER 11 Joints in Concrete](#)

WASTAGE Good planning and site preparation reduces wastage. Reducing wastage can cut costs, since up to 15% of concrete can be lost this way.



CHAPTER 7 Transporting and Placing Concrete

When transporting and placing concrete, avoid:

DELAY
SEGREGATION and
WASTAGE.

TRANSPORTATION The method used to transport concrete depends on which one is the lowest cost and easiest for the job size.

Some ways to transport concrete include: a concrete truck, a concrete pump, a crane and bucket, a chute, a conveyor or a hoist. On small jobs a wheelbarrow is the easiest way to transport concrete.

Always transport concrete as little as possible to reduce problems of segregation and wastage.

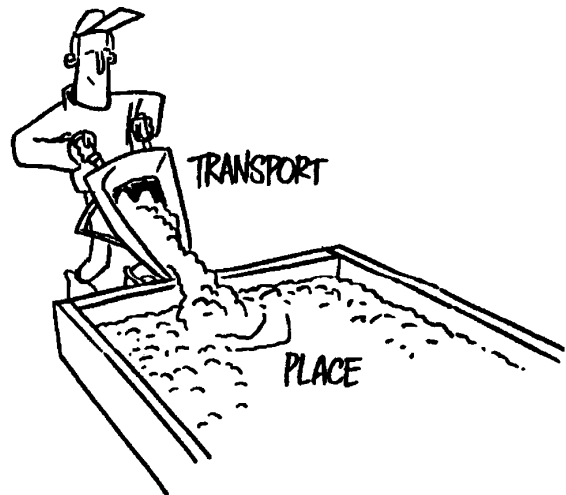

PLACING When placing concrete be careful not to damage or move the formwork and reinforcement.

Place concrete as near to its final position as possible.

Start placing from the corners of the formwork or, in the case of a sloping site, from the lowest level.

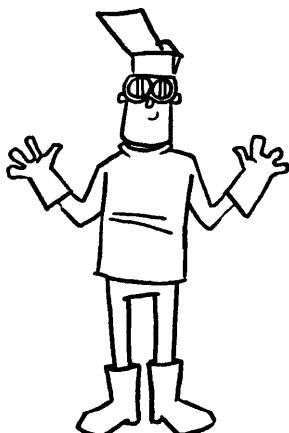
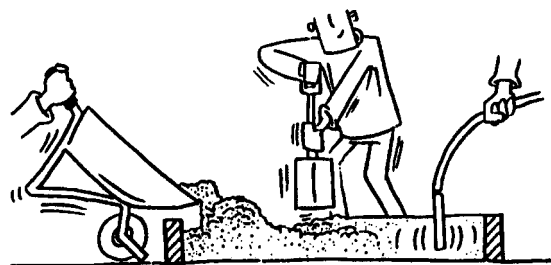

IMPORTANT SAFETY INFORMATION

When handling and using cement or fresh concrete, avoid skin contact. Wear suitable protective clothing.

DELAY Delay can cause the concrete to dry-out and stiffen.

Delay is more of a problem on a hot, and/or windy, day when the concrete will dry-out and stiffen more quickly.

To avoid delay plan ahead. Check that all labour, tools and containers are ready and that all preparations for placing have been

done before the concrete is delivered.



Never just add water to the concrete to make it more workable, always use a mix of cement paste (ie water AND cement).

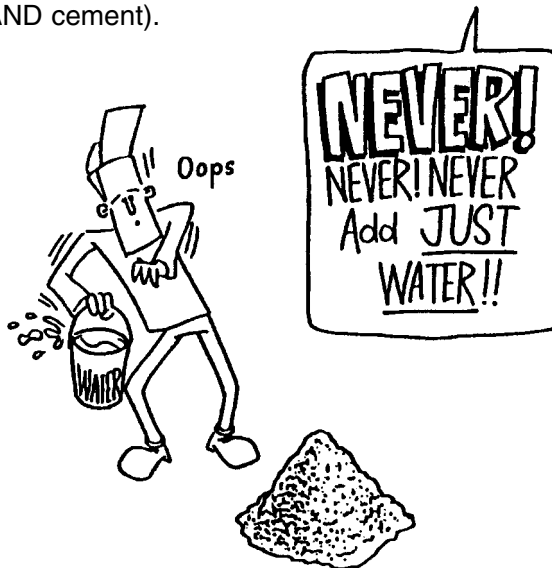
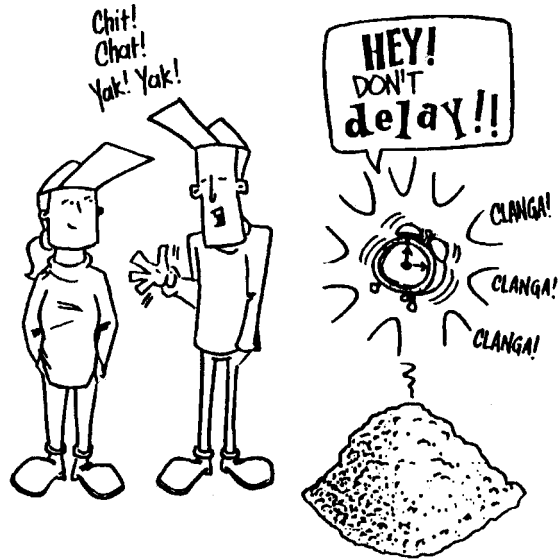

SEGREGATION Segregation is when the coarse and fine aggregate, and cement paste, become separated. Segregation may happen when the concrete is mixed, transported, placed or compacted.

Segregation makes the concrete:

WEAKER,
LESS DURABLE,
and will leave A POOR SURFACE FINISH.

To avoid segregation:

Check the concrete is not 'too wet' or 'too dry'.

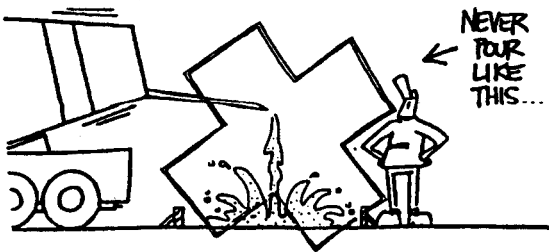
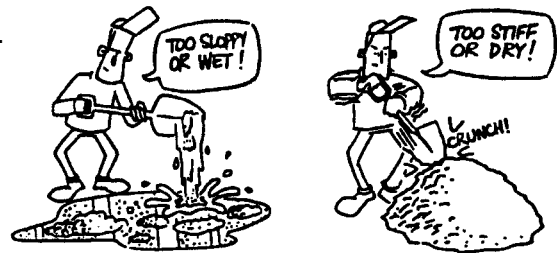

Make sure the concrete is properly mixed.

It is important that the concrete is mixed at the correct speed in a transit mixer for at least two minutes immediately prior to discharge. The concrete should be placed as soon as possible. When transporting the mix, load carefully.

If placing concrete straight from a truck, pour vertically and never let the concrete fall more than one-and-a-half metres.

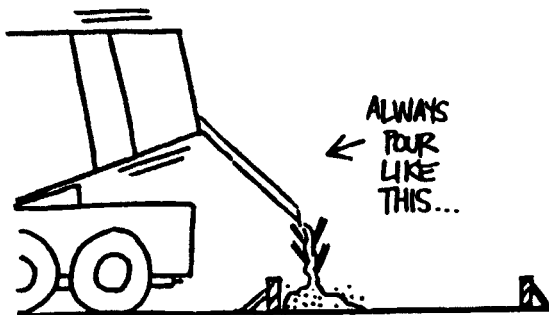

Always pour new concrete into the face of concrete already in place.

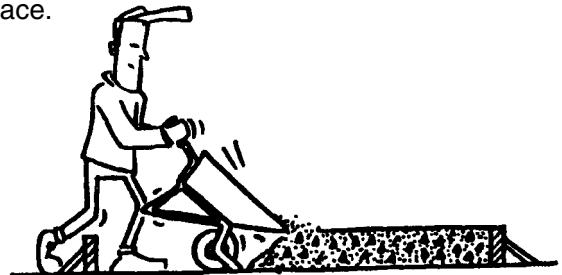

When compacting with a poker vibrator be sure to use it carefully.

See CHAPTER 8 Compacting Concrete

Never spread concrete sideways with a poker vibrator as this may cause segregation of the mix.

Always be sure to vibrate concrete evenly.

WASTAGE Wastage can be costly, especially on small jobs. To minimise wastage; mix, load, transport and place carefully.



CHAPTER 8 Compacting Concrete

WHAT IS COMPACTION Compaction is done by shaking, or vibrating, the concrete which liquefies it, allowing the trapped air to rise out.

The concrete settles, filling all the space in the forms.

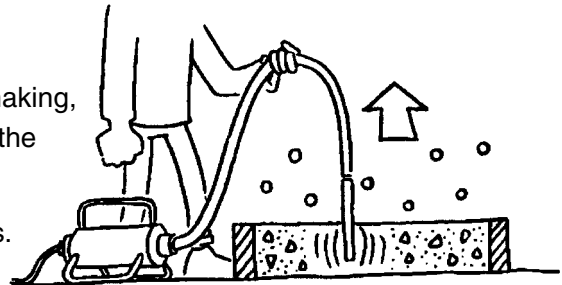

- As you shake & vibrate the concrete the AIR is pushed out.

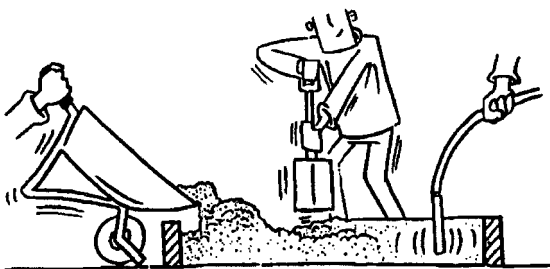

WHEN TO COMPACT Compaction must be done as concrete is placed, while it is still plastic. Never let concrete dry-out and stiffen because it will be too hard to compact.

WHY COMPACT Properly compacted concrete is more dense, strong and durable. Off-form finishes will also be better.

EXTERNAL VIBRATION

Screeding Screeding levels and compacts thin concrete slabs and the top layers of thicker slabs. A screed board will not compact the concrete very well. Mechanical vibration or hand rodding is required to provide adequate compaction.

The Mechanical Screed Concrete is screeded TWICE.

The first screed levels the concrete roughly and compacts it.

The second screed levels and compacts the concrete more.

The screed is pulled along the top of the forms by two workers.

Always keep a small amount, or surcharge, of concrete, in front of both beams of the screed to avoid holes forming in the surface. If a hollow develops, the screed will not compact the concrete.

The mechanical screed compacts the concrete as it vibrates.

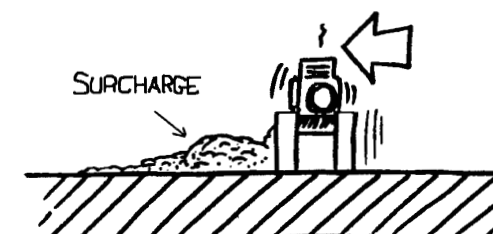
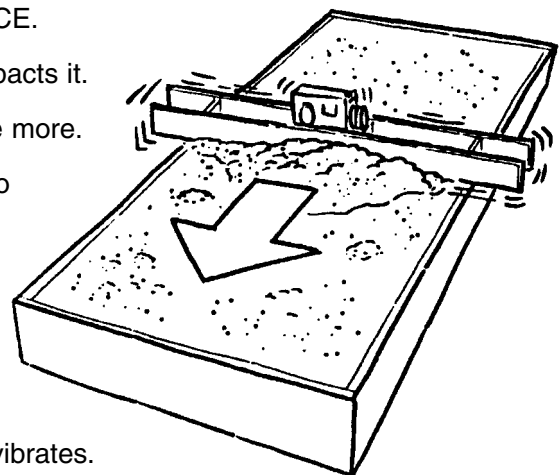

INTERNAL VIBRATION Internal vibration is done with a mechanical vibrator or poker vibrator. The POKER is put into concrete and vibrates it from the inside.

Method

Make sure there are enough workers so some can compact while others continue to place.

Put the poker into the concrete QUICKLY. Take the poker out very SLOWLY otherwise a hole, or weak spot, may be left in the concrete.

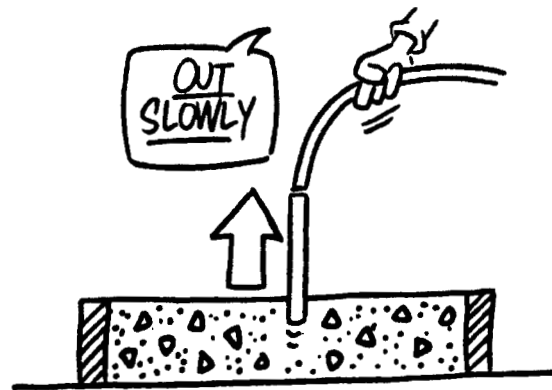
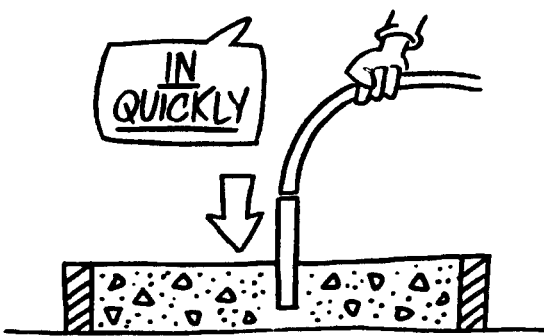
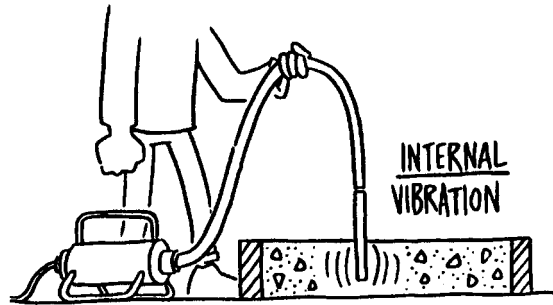

The SIZE of the poker determines how much concrete is vibrated at one time.

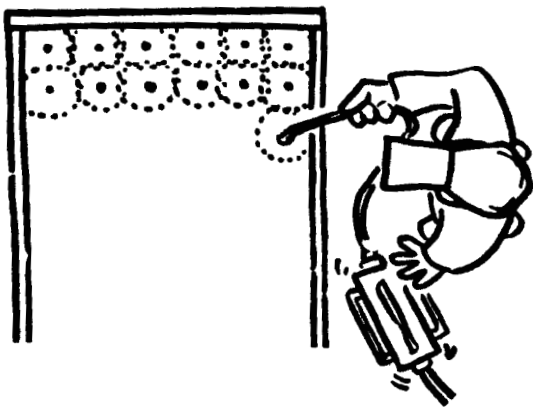

The area vibrated at one time is called the RADIUS OF ACTION. This can be seen by over what radius air bubbles rise to the surface.

The radius of action will be greater with a LARGER poker and more-workable concrete.

Always compact in a definite pattern so the radius of action overlaps and covers the whole area of the concrete.

The poker should be long enough to reach and enter into the layers of concrete under the one being compacted.

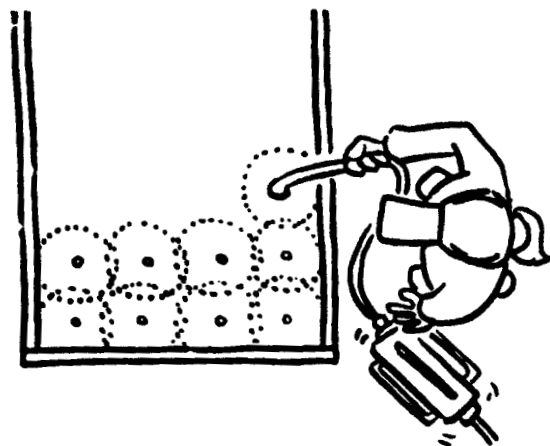
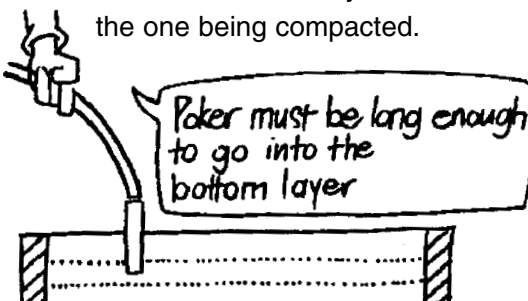

PRECAUTIONS Taking the poker out TOO QUICKLY will leave a hole in the concrete.

To close the hole, vibrate near the hole and take the poker out VERY SLOWLY.

NEVER touch the form face with the poker as it can damage the formwork and the concrete.

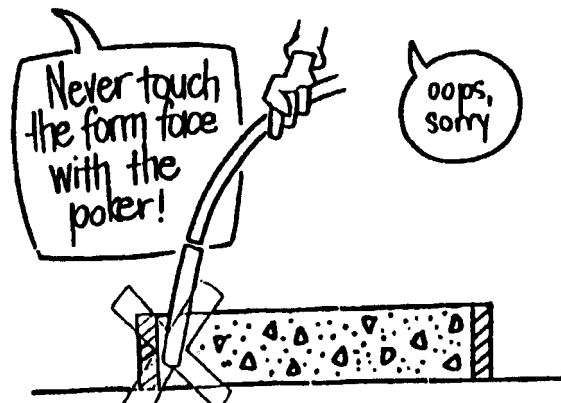

NEVER touch the reinforcement with the poker.

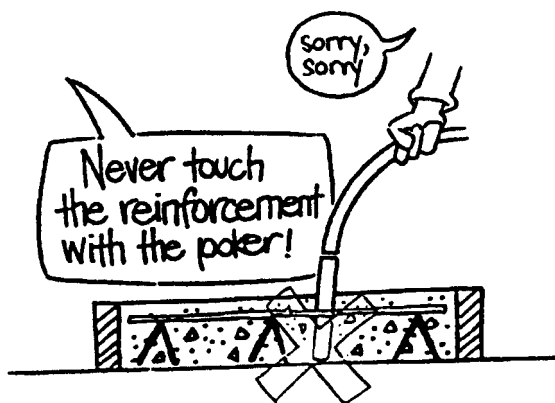

NEVER spread or move concrete sideways with the poker, always use a shovel.

NEVER leave the poker running when not in use.

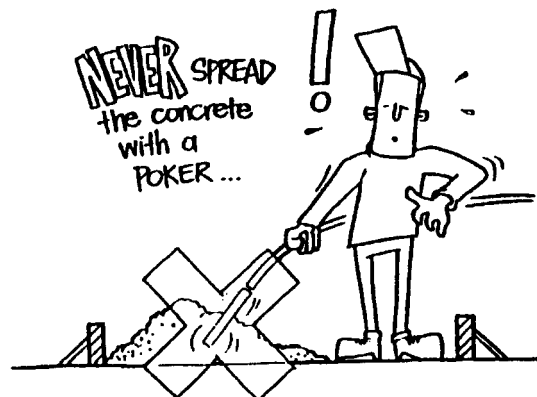

HOW LONG TO COMPACT For concrete of average workability (ie slump of 80 mm) with a poker size between 25–75 mm, concrete should usually be vibrated for between 5 and 15 seconds.

It is worse to UNDER-VIBRATE than to OVER-VIBRATE concrete.

CHAPTER 9 Finishing Concrete

WHAT IS FINISHING Finishing is screeding, floating or trowelling the concrete surface to densify and further compact the surface of concrete, as well as giving it the look you want.

Finishing takes place in two stages:

INITIAL and
FINAL finishing.

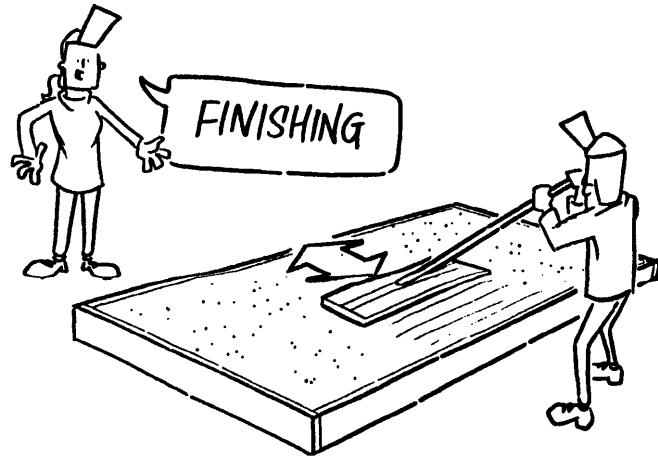

INITIAL FINISHING Concrete is first screeded to the level of the formwork, then bullfloated and left to set.

In some cases screeding leaves a good enough finish, especially if floor coverings are to be used over the concrete.

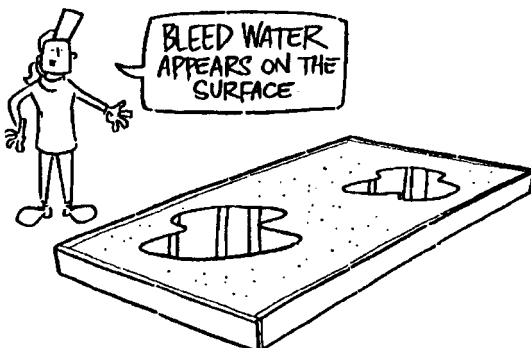

Water then appears on the surface of the concrete.

This water is called bleed water.

No final finishing can begin until the bleed water has dried up. Mixing bleed water with the surface paste will weaken it, possibly resulting in a dusty surface.

Excess bleed water can be removed by dragging an ordinary garden hose across the surface of the concrete.

Never try to dry up the bleed water using stone dust or cement as this will weaken the concrete surface in the long run.

Once the bleed water dries up and concrete can support a person's weight, with only a slight marking to the surface, the final finishing can begin.

FLOATING There may be two stages in floating:

The BULLFLOAT, which is part of the initial float.

The POWER or HAND FLOAT which is part of the final float.

Floating helps compact and level the surface and close minor cracks.

See CHAPTER 16 Cracking in Concrete

Floating can be done by hand or with a power float.

Power floating leaves a better finish than hand floating.

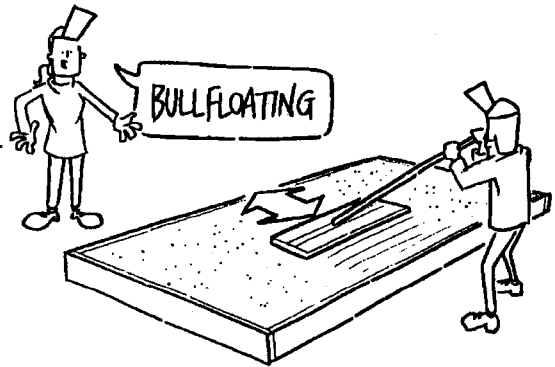
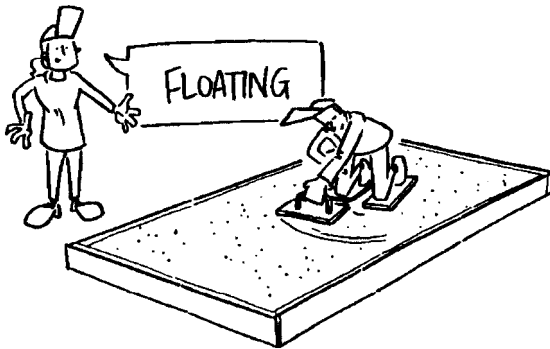

FINAL FINISHING This involves floating, trowelling, edging, jointing or patterning the concrete. Special finishes such as brooming, colouring or patterned finishes can be applied to the surface.

See CHAPTER 13 Surface Finishes on Concrete

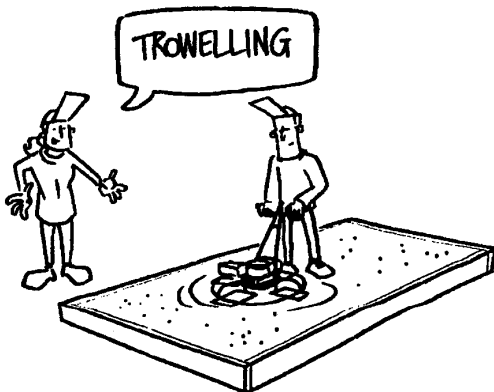

Trowelling Trowelling leaves a dense, hard, smooth and durable surface.

The surface should be trowelled TWICE. A well trowelled surface will be very smooth and can be slippery when wet. Trowelling can be done by hand or power trowel.

Edging and Grooving All the edges of a slab should be finished with a special edging tool. This gives a neater and stronger edge, less prone to chipping. Joints should be planned before placing and are usually formed into the concrete during finishing.

See CHAPTER 11 Joints in Concrete

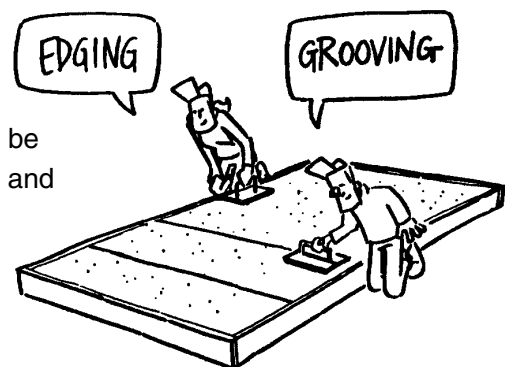

Once any surface has been finished it MUST be cured.

See CHAPTER 10 Curing Concrete

CHAPTER 10 Curing Concrete

WHAT IS CURING Curing means to cover the concrete so it stays MOIST.

By keeping concrete moist the bond between the paste and the aggregates gets stronger. Concrete doesn't harden properly if it is left to dry out.

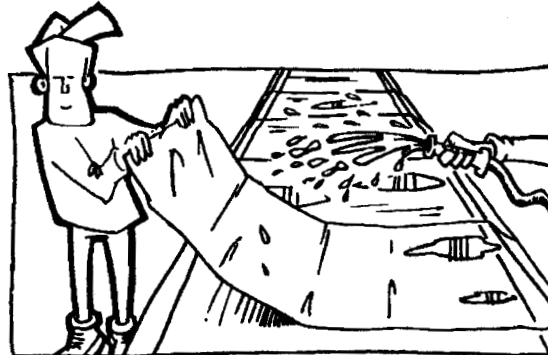

WHEN TO CURE Curing is done just after finishing the concrete surface, as soon as it will not be damaged.

Precautions When curing leave the formwork in place to help reduce water loss. In hot weather (above 30°C), or during high winds and low humidity, concrete can dry out easily. In these conditions take extra care while curing.

[See CHAPTER 12 Hot and Cold Weather Concreting](#)

WHY CURE Concrete that is cured is:

LESS LIKELY TO CRACK.
More DURABLE.

Cured concrete has a surface that wears better, lasts longer and better protects the steel reinforcement.



Stronger The concrete can carry more weight without breaking.



HOW TO CURE Concrete is cured by:

APPLYING EXTRA WATER to the surface of the concrete, or
STOPPING water loss from the concrete.

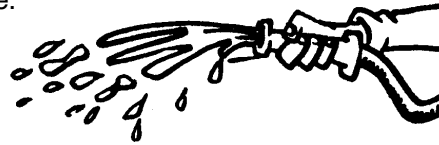
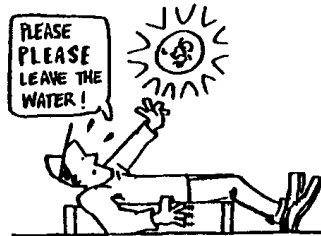

Methods The most common methods of curing are explained below.

The simplest method of APPLYING WATER is to put a continuous fine, misty spray of water over the concrete.

BEWARE: *The spray must be a very fine mist or else it will damage the surface of the concrete.*

Concrete will dry out more quickly in hot weather. Keep the concrete continuously moist.

The most important thing in curing is to keep the concrete moist at all times. Hosing in the morning and again at night and letting the concrete dry out in between is no good.

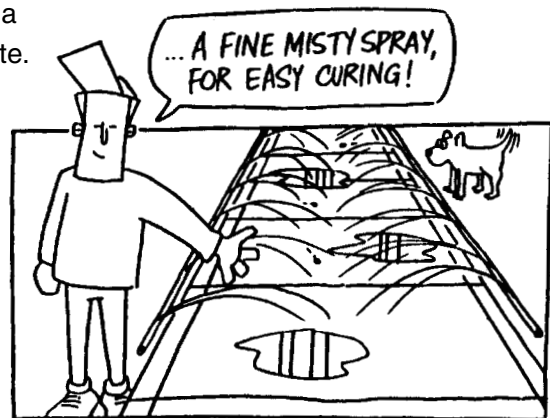

Another way to cure concrete is to cover with PLASTIC SHEETS to slow down water loss.

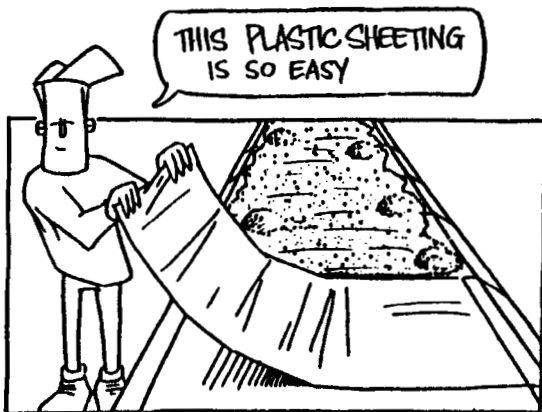

This method is easy and cheap. The only problem is that the sheets may cause concrete to become darker in places. To avoid this keep concrete EVENLY moist.

The sheets must be held down to stop them blowing away and the concrete surface drying out. The sheets can be overlapped and stuck together and/or held down with sand, timber or bricks.

Always check under the plastic from time to time to make sure the concrete is EVENLY moist. If it feels dry, sprinkle with water and put back the plastic sheets carefully. Condensation on the underside of the plastic is a good sign.

Concrete may also be cured by applying a CURING COMPOUND which slows water loss. This should be applied soon after finishing. Always follow the manufacturer's instructions carefully. Curing compounds may be sprayed or brushed on.

BEWARE: Some types of curing compounds may later make it harder or impossible to apply a surface finish to concrete such as paint, or to stick down floor coverings. When using a curing compound, check with the supplier to ensure compatibility with surface coatings or adhesives for future overlay finishes such as vinyl or tiles.

In rapid drying conditions (ie high wind, dry air and/or hot air) the use of an EVAPORATION RETARDANT minimises the rapid loss of surface moisture and as such reduces the incidence of early age plastic cracking.

See CHAPTER 16 Cracking in Concrete

These products contain a fugitive dye and are applied after initial screeding and floating, and reapplied after each successive surface working until finished. In severe conditions retardants will require reapplication. Evaporation retardants are not curing compounds; their effect is temporary therefore once the concrete is finished, normal curing techniques should still be used immediately.

HOW LONG TO CURE Concrete keeps getting HARDER AND STRONGER over TIME.

Household concrete jobs MUST be cured for at least 3 DAYS.

For better strength and durability, cure concrete for 7 DAYS.

The LONGER concrete is cured, the closer it will be to its best possible strength and durability.

See CHAPTER 2 Concrete Properties and

See CHAPTER 3 Concrete Testing)

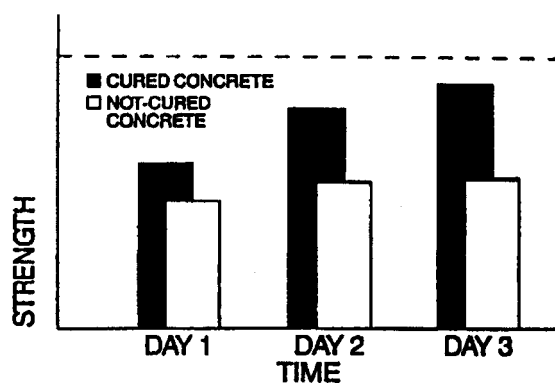

CHAPTER 11 Joints in Concrete

WHAT ARE JOINTS Joints are PLANNED BREAKS in concrete which allow it to move and prevent random cracking.

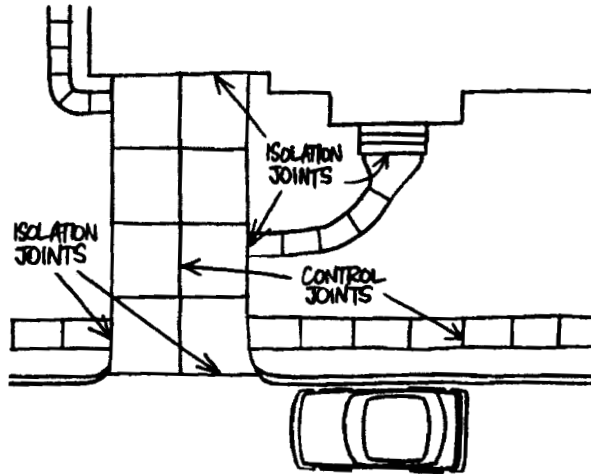

WHEN TO MAKE JOINTS Joints can be made at two different times:

BEFORE any concrete is poured. As for Construction joints or Isolation joints.

AFTER concrete has been placed and compacted, as for Control joints.

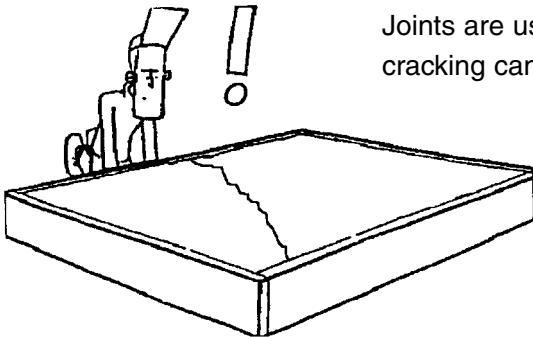

Joints are used to control CRACKING in concrete. Random cracking can weaken the concrete and spoil its appearance.

TYPES OF JOINTS

Control Joints Wet formed joints are inserted with the use of a grooving tool to create a plane of weakness which conceals where the shrinkage crack will occur. To be effective the joint must be tooled to a minimum depth of $\frac{1}{4}$ to $\frac{1}{3}$ the depth of the concrete, eg for 100 mm thick concrete – joint depth should be a minimum of 25 mm to 35 mm.

Control joints may be made while concrete is hardening by slicing it with a thin piece of metal. The edges of the joints should be finished with a grooving or edging tool.



[See CHAPTER 9 Finishing Concrete](#)

Alternatively a crack inducer may be cast, or pressed into, the concrete.

Control joints may also be sawn, but timing is very important.

Too early and the sawcut can ravel and too late the concrete will have already cracked randomly.

A joint may be filled with a flexible filler to minimise water entry and to prevent stones etc entering which may later cause spalling of the concrete.

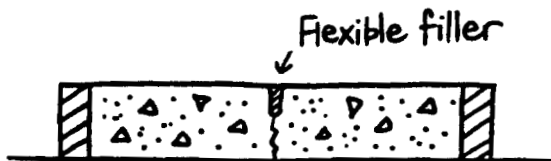
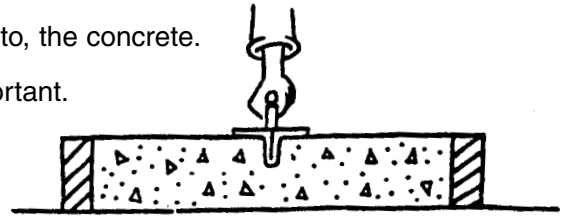

The position and number of control joints must be carefully planned. Control joints in an unreinforced concrete slab should divide it into roughly square areas. (ie A one-metre-wide path needs a control joint about every one metre).

Control joints in unreinforced concrete should be located at a spacing of a width to depth ratio of about 20 (to 25) to 1 ie a 100 mm deep slab should have joints every 2 to 2.5 m. In steel reinforced slabs the joint spacing is controlled by the area of steel. The more steel there is, the further apart the joints can be.

Isolation Joints An isolation joint totally separates a concrete element from another concrete element, or a fixed object such as a wall or column, so that each can move and not affect the other. The joint filling should be full depth and soft. It can be made of cork, foam rubber, or some other flexible material.

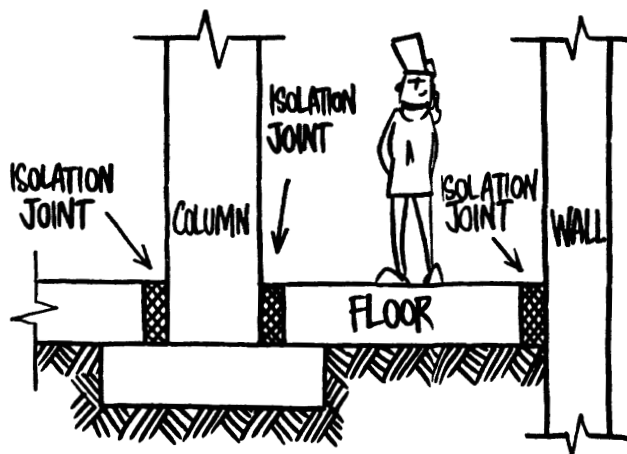

Construction Joints A construction joint is a place where work finishes temporarily. Formwork is used to support the edge of the concrete already in place so that it doesn't just collapse. Concrete is finished square and the reinforcement normally runs through the joint.

When placing begins again:

Remove the formwork and brush any loose material from the old surface.

Roughen the old surface, to expose the coarse aggregate, to help the new concrete bond properly.

Pour the new concrete against the old surface.

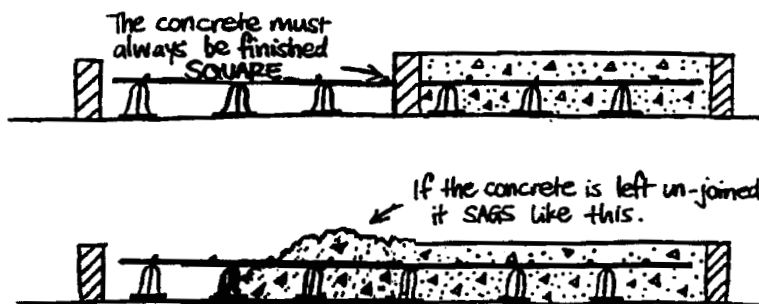

PLANS The position of ALL JOINTS should be shown on the plans for any concrete slab.

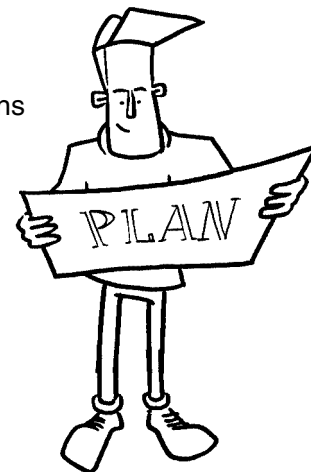

CHAPTER 12 Hot and Cold Weather Concreting

In extremes of heat and cold concrete must be:

HANDLED
PLACED
COMPACTED
FINISHED and
CURED carefully.



Extremes of heat and cold mainly cause problems of cracking. When conditions of heat and cold are expected some of the following precautions will improve the quality of your final concrete.

IN HOT WEATHER

Workability In hot and/or windy weather a concrete mix may stiffen rapidly and not be workable.

A 'set retarding' admixture may be added to the concrete during mixing to give a longer working time.

[See CHAPTER 2 Concrete Properties](#)

In hot and/or windy weather, if concrete stiffens quickly, a cold unbonded joint may form between concrete already in place and the new concrete.

If there is a chance of this happening you may need to make a construction joint.

[See CHAPTER 11 Joints in Concrete](#)

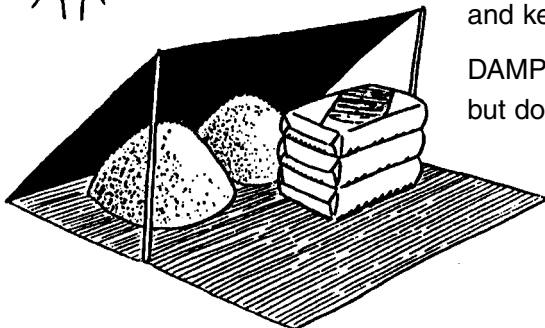
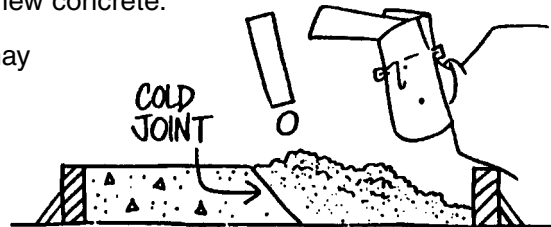

To Stop Concrete Drying out and Cracking

Use one or more of the following:

Use SHADE to keep all materials out of direct sun and keep the aggregates MOIST.

DAMPEN subgrade and formwork, but don't leave excess water lying around.

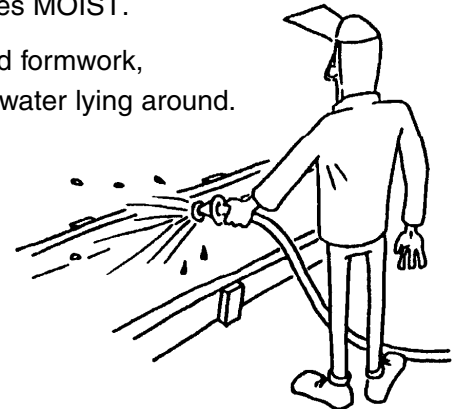

Put up SHADES and WINDBREAKS or try to place in the cooler parts of the day.

Avoid DELAYS once the job begins by planning ahead.

Use a 'Set-Retarding' ADMIXTURE.

SPRAY concrete with 'aliphatic Alcohol' after the initial finishing, which reduces EVAPORATION and CRACKING.

CURE concrete carefully.

See CHAPTER 10 Curing Concrete

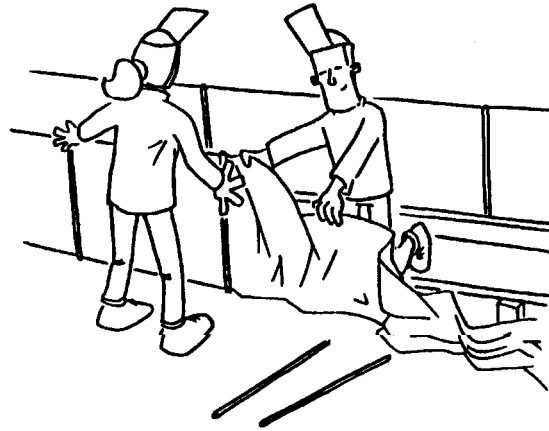

Keep it COOL. In extreme conditions iced water, or other methods, may be used in the mix to keep it cool. Do not apply cold water to a hot concrete surface as thermal cracking may result due to the sudden cooling.

IN COLD WEATHER Frozen or very cold water will also slow down the setting time which can cause costly delays.

In extremely cold weather water turns to ice, EXPANDS and can CRACK hardened concrete.

To Stop Water Freezing and Cracking Concrete Use one or more of the following:

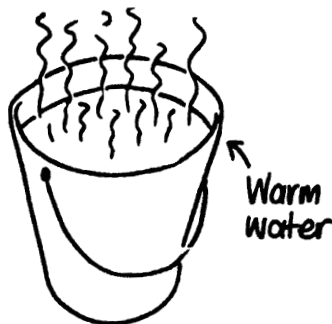

Keep all MATERIALS warm.

Use WARM WATER in the mix.

COVER the formwork and subgrade, to keep them free of frost and ice.

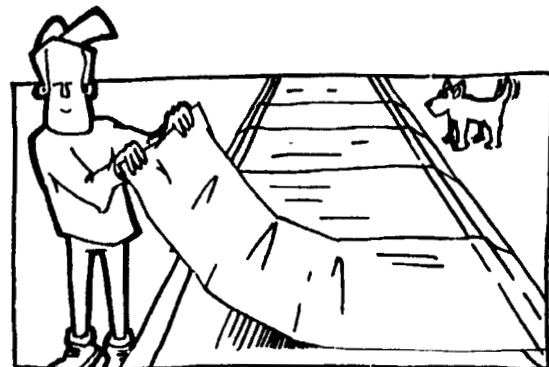

Use a 'Set-Accelerating' ADMIXTURE.

Try to keep concrete as much above 10°C as possible for the first few days.

NEVER lay concrete on frozen ground.

CURE concrete carefully to keep it warm. The best method will be one that KEEPS HEAT in the concrete. The curing methods should not cool the concrete. An insulating layer may be needed.

In cold climates with frequent freeze/thaw conditions the concrete may need an Air-Entraining Admixture for long term durability.

CHAPTER 13 Surface Finishes on Concrete

Concrete can be given many different surface finishes including:

BROOMING
COLOURING
PATTERNING or
POLISHING

A coloured or patterned surface finish can make concrete look more attractive and interesting.



CONCRETE In order to minimise problems arising when using any form of coloured concrete for domestic paving, either a minimum grade of 25 MPa or concrete containing not less than 280 kg of cement/m³ should be used. Other forms of decorative concrete, or in commercial work, will normally require a higher grade of concrete.

TEST PANELS To find out how a colour or pattern will look always do a small test area before beginning the bulk of the work.

CURING COLOURED CONCRETE Curing is the most important step in colouring concrete. The concrete surface must stay evenly moist or the colour will be uneven. Poorly cured concrete can even affect a painted concrete surface.

[See CHAPTER 10 Curing Concrete](#)

COLOURED FINISHES There are four ways to colour concrete.

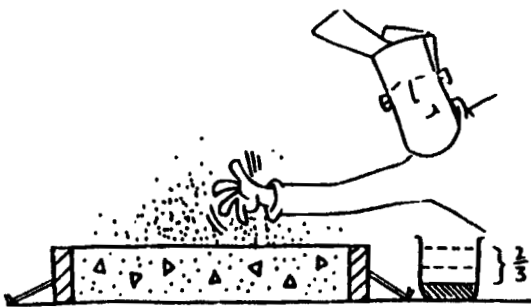

The Dry-Shake Method The dry-shake method uses a mixture of a mineral oxide pigment (or colour), cement and specially graded fine aggregates. The colour is added when compaction, screeding and bleeding has finished, as part of finishing. Uniform reliable results are best achieved if the concrete is supplied pre-mixed by the supplier using weight batched dry components.

Shake 2/3 of the dry material onto the concrete surface, spreading it evenly with a float. Leave for a minute or so to soak up some moisture.

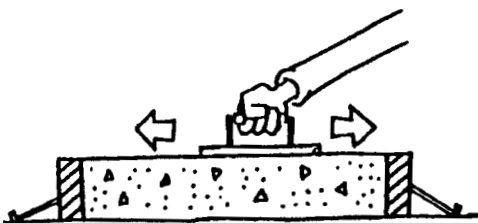

The Dry-Shake Method *continues on next page*

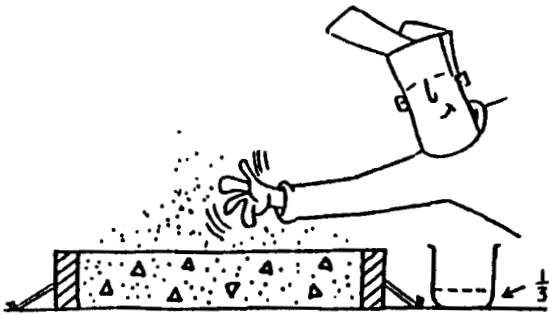

Shake the last 1/3 of the dry material onto the concrete at right angles to the first application and again after it has dampened up, spread evenly with a float. The two applications help to give a more uniform colour and thickness.

Re-tool any edges and joints.

[See CHAPTER 11 Joints in Concrete](#)

After a while the surface must be re-floated.

FULL DEPTH COLOUR The colour is added to the concrete during mixing so all the concrete is coloured, then the concrete is compacted and finished as for normal concrete.

The colour pigment additives should generally be in the range of 3–7% by weight of the cement. Higher quantities may affect the strength and durability of the concrete. Check manufacturer details for colour selection.

[See CHAPTER 2 Properties of Concrete](#)

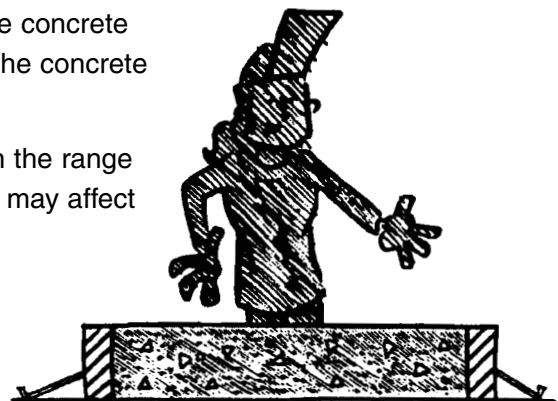

Each batch must be accurately proportioned, thoroughly mixed and well floated to give an even colour.

[See CHAPTER 9 Finishing Concrete](#)

The colour of the cement powder may effect the shade of the final colour, ie a dark grey cement may affect light colours.

APPLIED FINISHES Applied finishes, including paints, tinted sealers and trowelled-on coatings provide a wide range of colours and are easily applied to hardened dry concrete.

Paint finishes are either water-based or solvent based. They will wear easily and will need to be reapplied periodically.

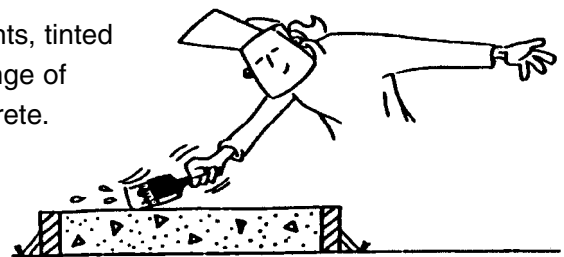

CHEMICAL STAINS A chemical stain soaks into the concrete surface and colours its, only wearing away as much as the surface does.

There is only a limited colour range in concrete stains.



STAMPED PATTERN FINISH A number of DIFFERENT PATTERNS can be stamped into the surface of setting concrete. This includes cobblestone, slate, tile, brick tile and timber finishes.

The concrete is placed and compacted normally, and floated once. A dry shake colour may also be used.

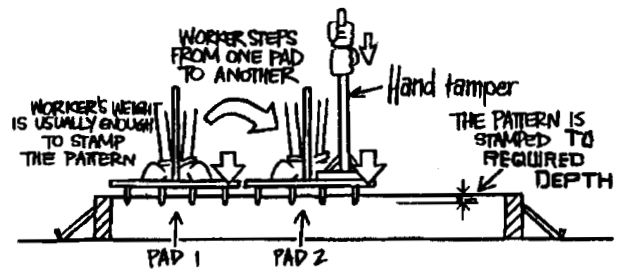

The padder stamps or pads/mats are then placed carefully on the concrete surface. When mats are used a release agent will be needed to allow the mat to be removed. At least two moulds are needed to step from one to another giving continuous and matching pattern. Step onto the moulds, pressing them into the concrete surface to the desired depth; up to 6–10 mm for cobblestones and less for other patterns. Deep patterns may be a hazard for pedestrians.

When using pads the grooves may be rounded by laying a sheet of plastic across the concrete surface before stamping. The surface must then be broomed to give a non-slip finish. Use small handstamps for the edges and any difficult to reach areas.

Brick, or tile finishes, (stencilled concrete) can be obtained by floating a paper template into the concrete surface before applying a dry shake. The template forms the mortar lines.

EXPOSED AGGREGATE FINISH An exposed aggregate finish can be an attractive decorative finish. Different sizes and colours of aggregates allow many different looks.

The concrete can be made as normal, and the coarse aggregate exposed. This is done by waiting until the surface is firm, but not dry, then brush, wash or broom away any cement paste until the aggregates are exposed. Then cure the concrete.

A surface retardant can be used to aid the process.

Alternatively, there are two ways to get an exposed aggregate finish by adding special aggregates to the surface.

Method A

Place, compact and level the concrete to about 10 mm below the top of the forms.

Spread selected aggregates over the concrete in a layer and press them into the concrete until completely covered.

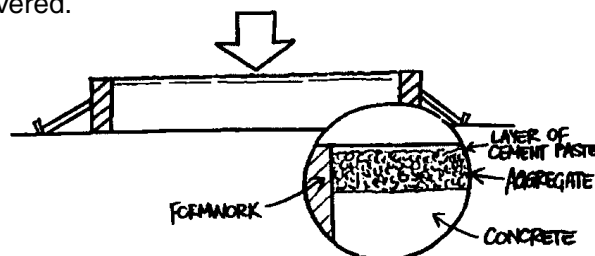

Method B

Place, compact and level concrete to about 5 mm below the top of the forms.

Mix a 'Topping Coat' – A mix of aggregates and cement paste in the ratio 2:1.

Use only enough water to make the coat workable.

[See CHAPTER 2 Concrete Properties](#)

Spread the topping over the concrete, level, tamp down and finish with a trowel.

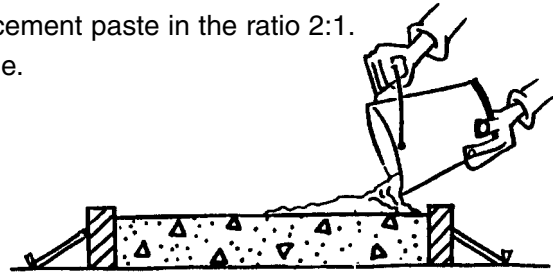

FOR BOTH METHODS leave the concrete until the cement paste on the surface is firm, but not dry, then brush or with a fine mist spray wash away some of the cement paste covering the aggregates.

In both cases extra cleaning can be done with a dilute solution of hydrochloric acid. The solution should be 1 part acid to 20 parts water. Wet the concrete first and rinse off thoroughly afterwards. Observe safety procedures.

[See CHAPTER 15 Removing Stains from Concrete](#)

To see what an aggregate finish will look like, do a test area first.

Different colours of cement can be used to get a better effect. For instance a white or off-white cement may be used with a light stone where a grey cement may create a clash of colours.

A BROOMED FINISH To give a skid-resistance surface a stiff, or soft, bristle broom can simply be drawn across the surface of concrete. The broom can be drawn in straight or 's' shape lines.

POLISHED CONCRETE Polished concrete is a finish used on the interior and exterior of dwellings. A variety of finishes can be achieved by using different techniques or products. The different finishes can be achieved by using liquid polishes, latex coatings, chemical sealers, grinding to expose the aggregates, colours, stains and special aggregates to achieve other desired effects.

[For further details please refer to Polished Concrete Floors – Briefing 05.](#)

CHAPTER 14 Defects in Concrete

Some defects are obvious only to a trained eye, others, such as cracking, are obvious to anyone. Some common defects, their causes and how to prevent and repair them are explained below. If in doubt please consult an expert.

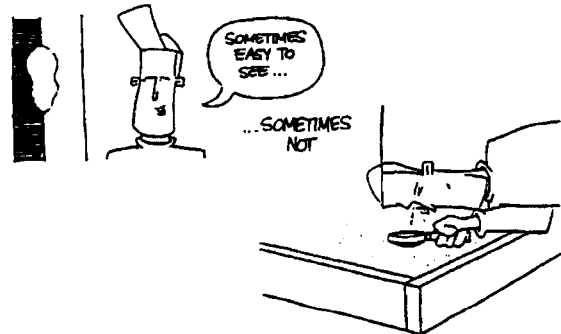

COLOUR VARIATION

Difference in colour across the surface of concrete. May appear as patches of light and dark.

Causes Uneven or variable curing conditions.

[See CHAPTER 10 Curing](#)

Applying a different brand or type of cement to the surface as a 'drier'.

Prevention Use an even concrete mix when placing, compacting and finishing and keep concrete evenly moist. Do not use driers.

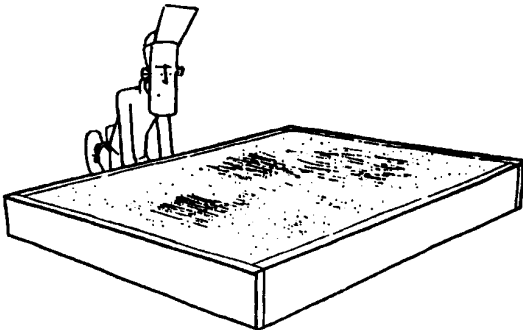

Repair Many colour variations from workmanship will be permanent. To hide the variation a SURFACE COATING can be applied.

Rectification of colour variation from stains is a very difficult operation and may need repeated gentle treatments with a weak acid.

[See CHAPTER 15 Removing Stains from Concrete.](#)

CRAZING

A network of fine cracks across the surface of concrete.

Causes Crazeing is caused by minor surface shrinkage in rapid drying conditions. (ie Low humidity and hot temperatures, or alternate wetting and drying.)

Prevention Finish and cure concrete correctly.

[See CHAPTER 9 Finishing Concrete](#) and

[See CHAPTER 10 Curing Concrete](#)

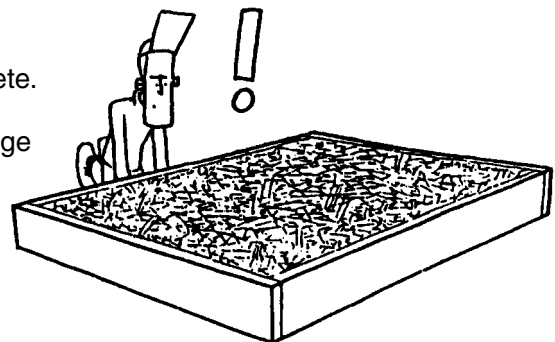

Repair Repair may not be necessary because crazing will not weaken concrete. If the crazing looks too bad then a surface coating of a paint or other overlay sealer can be applied to cover and/or minimise the effect of the cracks.

[See CHAPTER 13 Surface Finishes on Concrete](#)

DUSTING

A fine powder on the concrete surface which comes off on your fingers.

Causes Finishing before the bleed water has dried.
Also finishing during the rain.

See CHAPTER 9 Finishing Concrete

Not curing properly, or the surface is drying too quickly.

See CHAPTER 10 Curing Concrete

Concrete subject to severe abrasion or of too low a grade for the end use.

Prevention Let any bleed water dry up before trowelling or in cold conditions remove the water. Cure correctly.

See CHAPTER 10 Curing Concrete

Protect concrete from drying out too quickly in hot or windy conditions.

For harsh conditions use a stronger concrete.

Repair As previously detailed, dusting concrete surfaces result from inadequate attention to prescribed placement and finishing practices namely, the addition of excess water, working in of bleedwater, the inadequate compaction and curing of concrete. Where surface dusting is minimal the application of a surface hardener can be beneficial. If the surface is showing significant wear distress it is essential to remove all loose material by grinding or scrapping the surface to a sound base and then applying a suitable topping.

RAIN DAMAGE

The surface has bits washed away or many small dents.

Causes Heavy rain while concrete is setting or rainwater being allowed to run across the concrete surface.

Prevention Cover the concrete if it is raining or it looks like it might rain. Don't lay concrete if it looks like it might rain.

Repair If the concrete has not hardened and damage is minimal the surface can be refloated and re-trowelled taking care not to overwork excess water into the surface.

See CHAPTER 9 Finishing Concrete

If the concrete has hardened it may be possible to grind or scrape the minimal amount of the surface layer and apply a topping layer of new concrete or a repair compound. This may not always be possible and should only be done with expert advice.

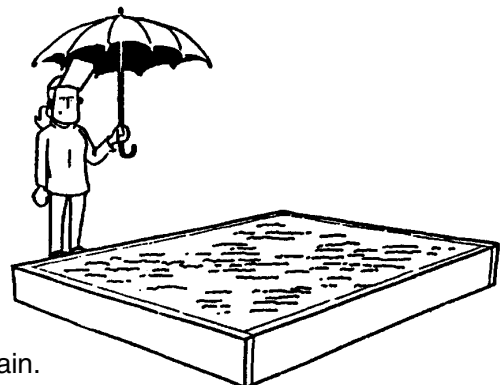
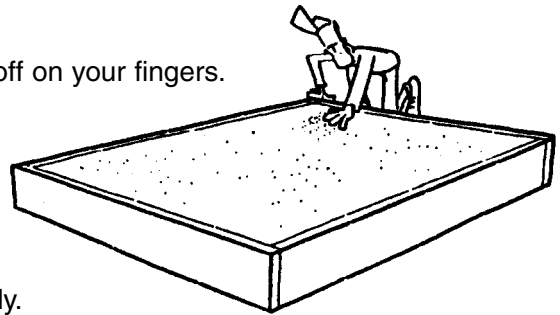

SPALLING

When the slab edges and joints chip or break leaving an elongated cavity.

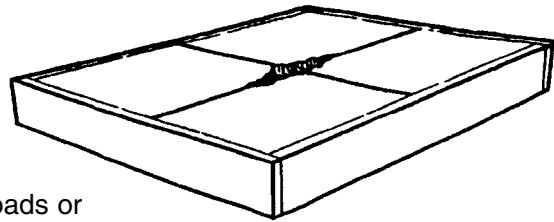

Causes Edges of joints break because of heavy loads or impact with hard objects. As concrete expands and contracts the weak edges may crack and break.

Entry of hard objects, such as stones, into joints may cause spalling when the concrete expands.

Poor compaction of concrete at joints.

Prevention Design the joints carefully. Keep joints free from rubbish. Keep heavy loads away from the joints and edges until they have properly hardened.

Ensure proper compaction.

Repair For small spalled areas: scrape, chip or grind away the weak areas until you reach sound concrete, making sure you brush the old concrete clean of any loose material. Then refill the area with new concrete or repair mortar. Compact, finish and cure the new patch carefully. Care should be taken that all joints be maintained and not filled.

For large spalled areas: seek expert advice

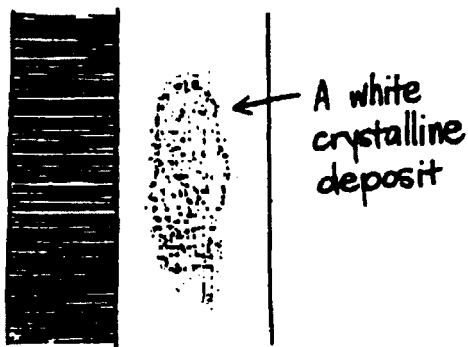
**EFFLORESCENCE**

A white crystalline deposit sometimes found on the surface of concrete soon after it is finished.

Causes Sometimes mineral salts are dissolved in water. If water with dissolved mineral salts collect on the concrete surface as water evaporates salt deposits are left on the surface.

Excess bleeding can also result in efflorescence.

Prevention Use clean, salt-free water and washed sands. Avoid excessive bleeding.

Repair Remove efflorescence by dry brushing and washing with clean water. Do not use a wire brush. Wash with a dilute solution of hydrochloric acid.



HONEYCOMBING

When too much coarse aggregate appears on the surface.

Causes Poor compaction, segregation during placing or paste leakage from forms. A poor concrete mix with not enough fine aggregate causing a rocky mix.

Prevention Use a better mix design. Take care during placing concrete to avoid segregation. Compact concrete properly. Good watertight formwork.

Repair If honeycombing happens only on the surface it can be rendered. If honeycombing happens throughout the concrete it may need to be removed and replaced. The surface may require rendering. Rendering means to cover the surface with a layer of mortar.

BLISTERING

Blisters are hollow, low profile bumps on the concrete surface filled with either air or bleed water.

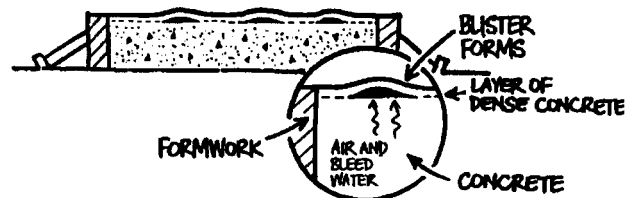

Causes They are caused when the fresh concrete surface is sealed by trowelling while trapping air or bleed water under the surface. This may particularly occur in thick slabs or on hot, windy days when the surface is prone to drying out.

Prevention After placing, screeding and floating leave the concrete as long as possible before trowelling, which seals the surface. Cure to prevent evaporation.

If blisters are forming delay trowelling as long as possible and take steps to reduce evaporation.

Repair Grind off the weakened layer to an even finish.

CHAPTER 15 Removing Stains from Concrete

Simple stains and everyday grime can be removed by washing and scrubbing. Water jet washing may also be successful. Stains from oil, rust or paint leave ugly marks on concrete, ruining its appearance. These stains soak into the concrete surface and can often be very difficult to remove.

A stain may be removed using a special chemical stain remover, or a specially prepared chemical mix. In extreme cases if a stain cannot be removed chemically, it may be sand blasted. This removes the surface of the concrete and may expose the aggregates.

Some types of stains can be covered by simply painting over with a concrete paint. However oil based stains may soak through a paint and must be removed first.

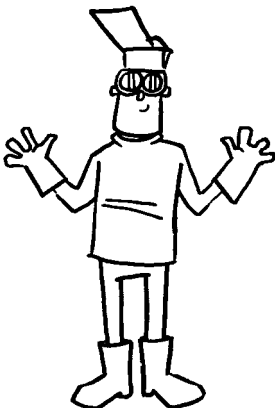
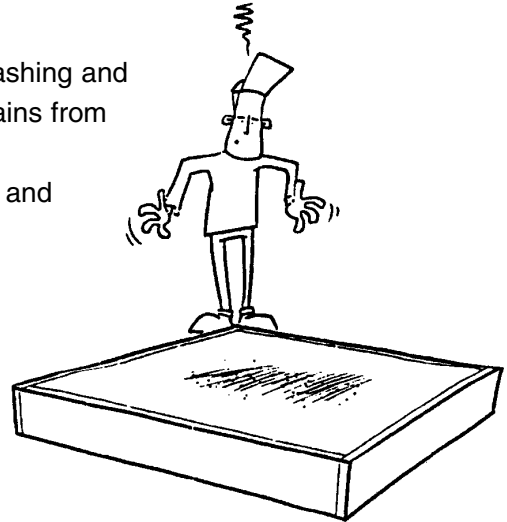

SAFETY

When using any chemicals mentioned in this chapter always wear protective clothing, gloves and shoes. Protective eye goggles and face masks may also be necessary.

Don't breathe in fumes from any of these chemicals.

If chemicals come in contact with skin or eyes, wash the area with plenty of cold water, and seek doctor's advice.

Always read the safety directions on the label of any chemical container prior to starting work.

Ways to remove specific stains are:

OIL AND GREASE STAINS These can be difficult to remove completely because they tend to soak into the concrete surface. If the oil or grease has hardened it can simply be scraped off. If an oil or grease spill has just occurred, stop it spreading by encircling it with sand, dirt, sawdust or cat litter. These can also be used to assist in soaking up or removing as much of the oil and grease as possible.

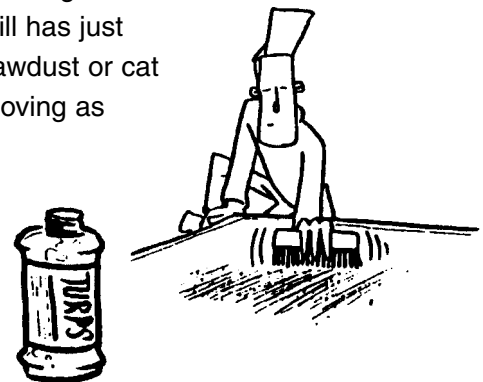

Cover residue stain with a poultice made of 1 part lime to 2 parts mineral turpentine. Spread a 5 mm layer of the paste over the stained area ensuring the spread is 50–100 mm beyond the edge of the stained area. Cover with plastic sheeting and leave for 24 hours.

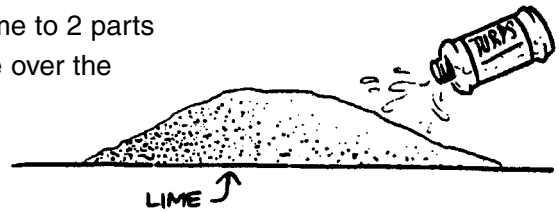

Remove the cover and scrape off the powder. It may be necessary to repeat this process again within a day or so to remove any deeply ingrained oil or grease. Scrub with warm water and laundry detergent then rinse with clean water at the end of the treatment.

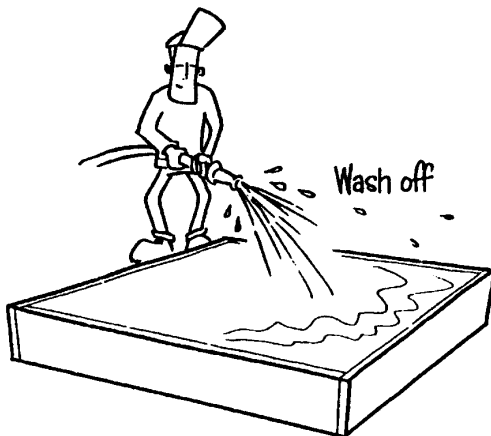
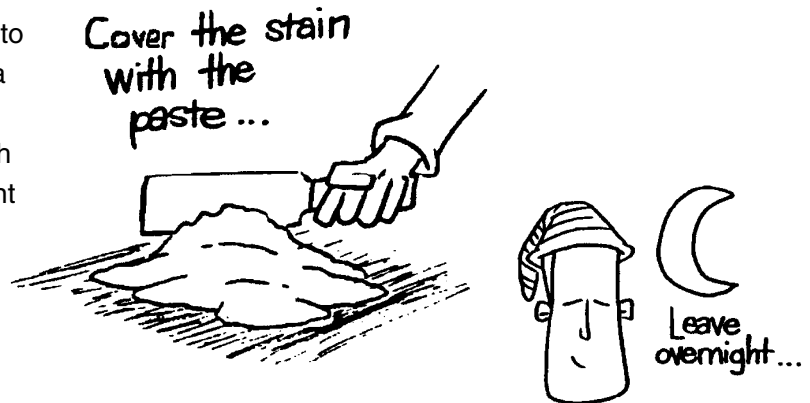

RUST External rust, from objects placed on the concrete, may be removed with a detergent based concrete cleaner or a weak solution (1:25) of hydrochloric acid (if this is not successful please seek professional advice). Prior to applying the acid solution, wet the concrete first and always wash down the surface with clean water afterwards. Be careful where the run off goes as it may create problems on other concrete surfaces or gardens. A poultice method may also be used.

Stains from rusting of the embedded steel reinforcement, if this type of stain is present, seek professional advice.

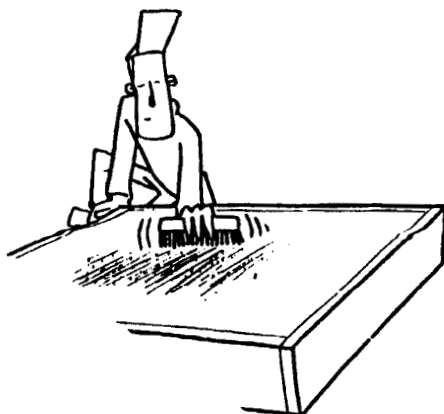

TIMBER Timber stains wash off with a domestic chlorine bleach.

Scrub the area with bleach.

Wash with water.

If this does not work well, mix 120 grams of oxalic acid with 4 litres of hot water. Apply, wash off and neutralise with a solution of bicarbonate of soda and water.

PAINT Paint spillage stains come off best with a paint remover.

ALGAL AND FUNGAL GROWTH Algal and fungal stains are removed with domestic chlorine bleach.

Wash and scrub the area with bleach.

Leave for a few days.

Scrub or scrape growth off.

Wash with water.

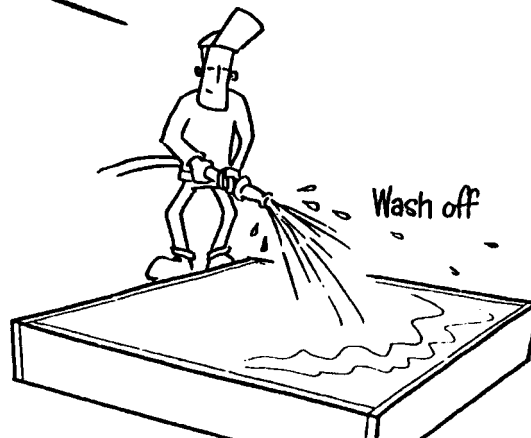
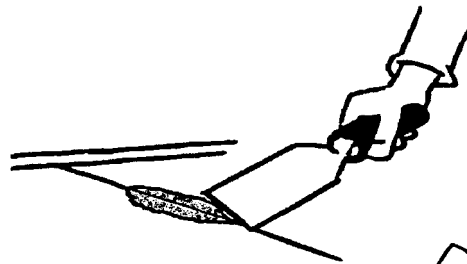
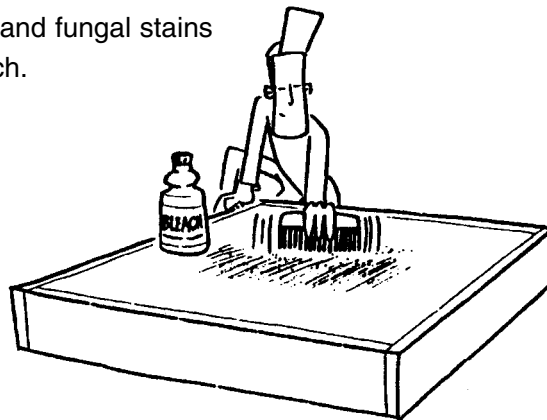

CHAPTER 16 Cracking in Concrete

Random cracking in concrete is not desirable, it can make your concrete look ugly and lead to structural weakness of the concrete.

Reinforcement and joints are used to control cracking. Bad cracking leaves the reinforcement exposed to air and moisture, which may cause it to rust and weaken concrete.

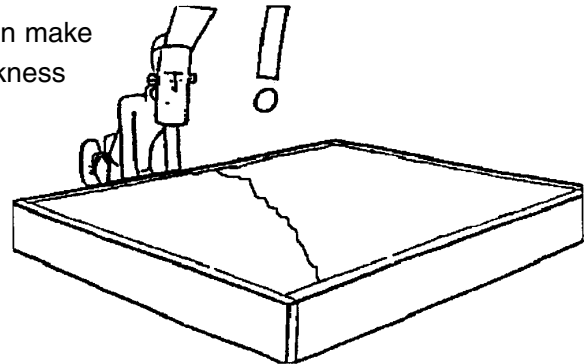

[See CHAPTER 11 Joints in Concrete](#) and

[See CHAPTER 17 Reinforced Concrete](#)

TYPES OF CRACKS

Two types of cracks happen in reinforced concrete:

PRE-SETTING CRACKS Cracks that happen **BEFORE** concrete hardens, while it is still workable.

HARDENED CRACKING Cracks which happen **AFTER** concrete hardens.

PRE-SETTING CRACKS

Pre-setting cracks are cracks which form during placing, compaction and finishing caused by movement of concrete before it is dry.

There are three types of pre-setting cracks:

PLASTIC SETTLEMENT cracks

PLASTIC SHRINKAGE cracks, and

Cracks caused by **MOVEMENT OF THE FORMWORK**.

Pre-setting cracks can be prevented by looking for them as they happen, while the concrete is still setting.

If they are detected early on they can be easily fixed by re-compacting, re-trowelling or re-floating the concrete surface.

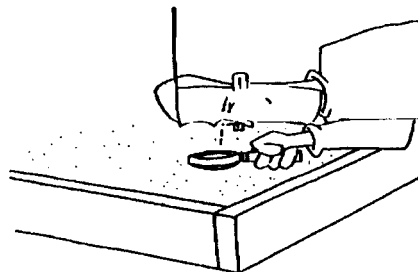

Plastic Settlement Cracks

When do they form? They form soon after concrete is placed, while it is still plastic. They get bigger as concrete dries and shrinks and tend to follow the lines of reinforcement.

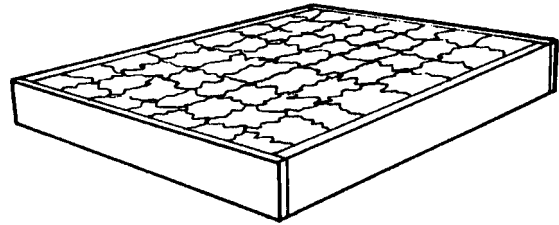
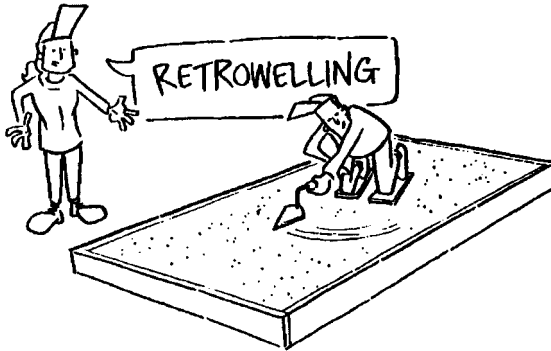

Prevention

Revibrate the concrete.

Re-trowel the surface.

Look for cracks as the concrete is setting. At this stage they can easily be fixed.

Plastic Shrinkage Cracks

When do they form? On very hot days or in low humidity and moderate winds. Cracking is more common in summer but may occur during winter.

See CHAPTER 12 Hot and Cold Weather Concreting

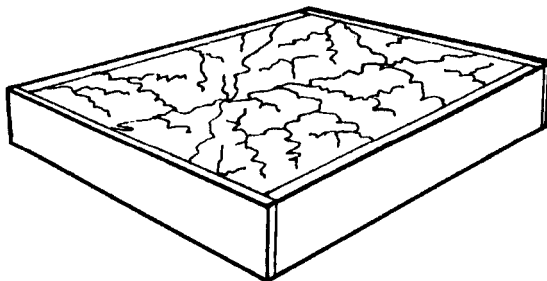

Plastic shrinkage cracks appear in lines, roughly parallel or in a crazed haphazard way. They are usually 300–600 mm long but may be between 25 mm and 2 m in length.

Prevention

Dampen the subgrade and forms and protect concrete from the wind.

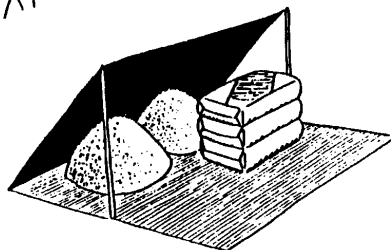
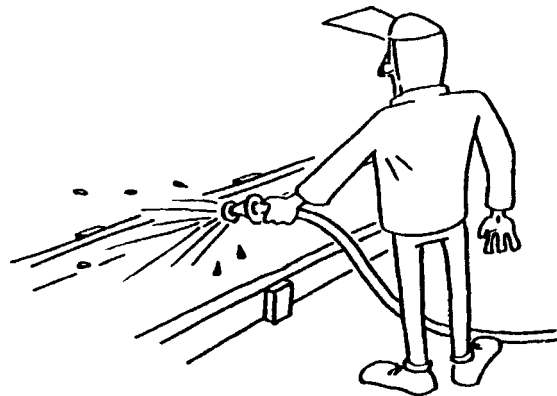

Keep all materials cool on hot days.

Place, compact and cure as quickly as possible on hot days so concrete won't dry out.

Once the concrete has been compacted, screeded and floated apply a uniform spray film of EVAPORATIVE RETARDANT (Aliphatic Alcohol) to prevent rapid loss of surface moisture, then continue with finishing.

Try to place at the cooler times of the day.

Repair Cracks may be closed by reworking the plastic concrete.

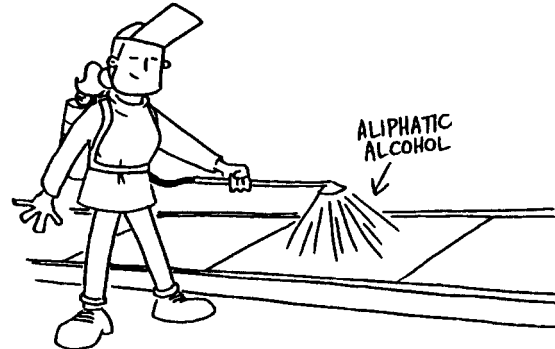

Formwork Movement

If formwork is not strong enough it may bend or bulge. Formwork movement may happen at any time during placement and compaction.

Prevention Make sure formwork is strong.

If the concrete collapses, strengthen the formwork and re-vibrate the concrete.

Thermal Shock

Applying cold water, as curing, over concrete on a hot day can result in cracks from the sudden contraction.

Prevention Use warm water.

CRACKS AFTER HARDENING

Cracks after hardening may be caused by drying shrinkage, movement or settling of the ground, or placing higher loads on the concrete than it was designed to carry.

Little can be done with cracks after hardening. Careful and correct placement helps prevent serious cracking after hardening.

Only uncontrolled cracks are a possible problem. Cracks at control joints or controlled by steel reinforcing is expected and acceptable.

CHAPTER 17 Reinforced Concrete

The steel found in many concrete structures is called REINFORCEMENT.

Reinforcement helps concrete resist TENSILE and SHEAR forces, and helps control CRACKING in concrete.

CONCRETE PROPERTIES

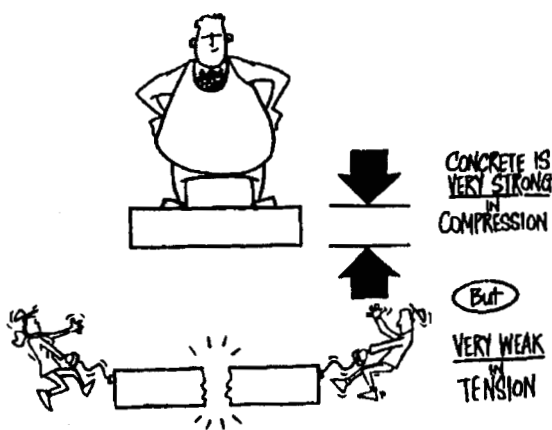
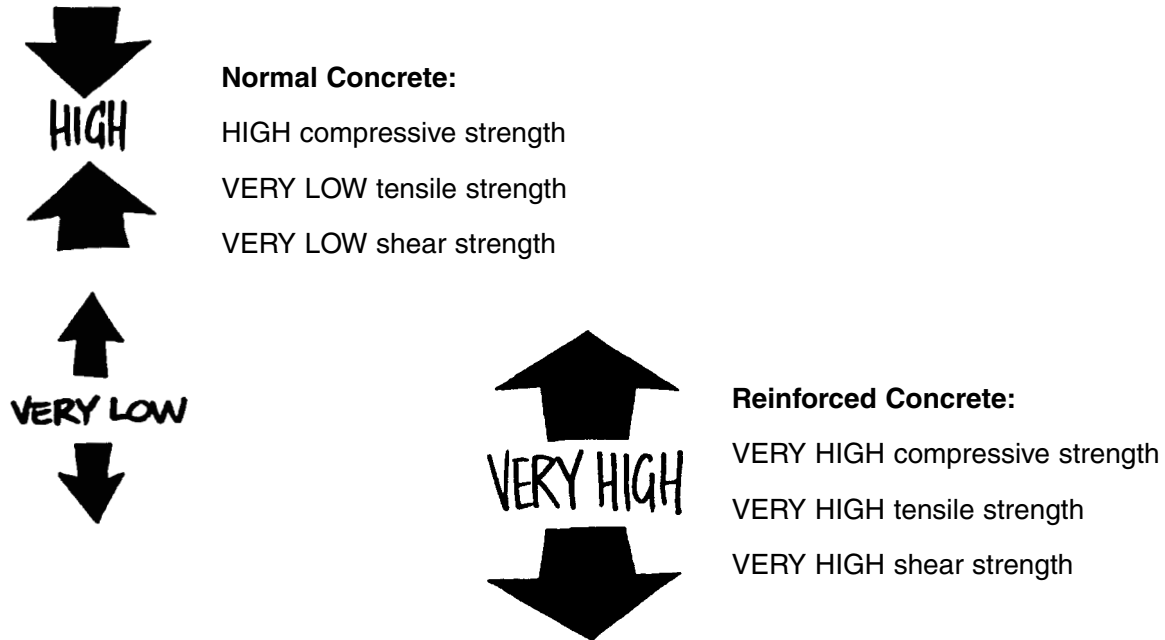

WHY USE REINFORCEMENT?

As a force is applied to concrete there will be compressive, tensile and shear forces acting on the concrete. Concrete naturally resists compression (squashing), very well, but is relatively weak in tension (stretching).

Horizontal and/or vertical reinforcement is used in all types of concrete structures where tensile or shear forces may crack or break the concrete. HORIZONTAL reinforcement helps resist tension forces. VERTICAL reinforcement helps resist shear forces.

Below are some examples of reinforcement use:

In a SUSPENDED (off-the-ground) concrete slab, horizontal reinforcement resists tension and vertical reinforcement (in say supporting beams) resists shear forces.

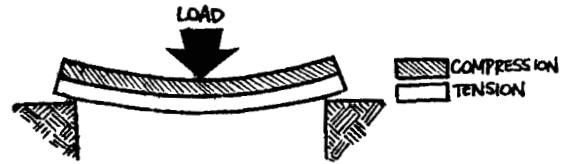

In a SLAB-ON-GROUND, reinforcement increases the tensile strength and helps control the width of shrinkage cracks.

See CHAPTER 16 Cracking in Concrete

It does not prevent cracks but controls the width that cracks can open.

Uses of reinforcement include:

- Increasing the spacing of control joints
- Odd shaped slabs
- Slabs with re-entrant corners.

REINFORCEMENT POSITION

The position of reinforcement will be shown in the plans. Reinforcement must be fixed in the right position to best resist compressive, tensile and shear forces and help control cracking.

The reinforcement in trenches and slabs rests on BAR CHAIRS and must be securely fixed to the bar chairs so it won't move when concrete is placed around it.

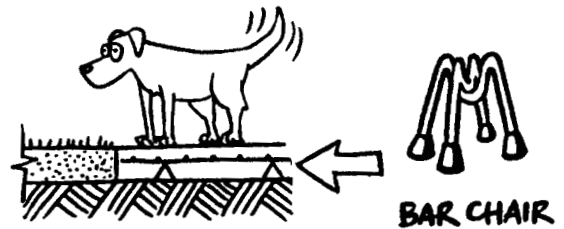

Concrete Cover The reinforcement must be placed so there is enough concrete covering it to protect it from rusting.

Typical covers are shown in the diagram. To ensure durability, both the concrete cover and strength should be shown in the plans.

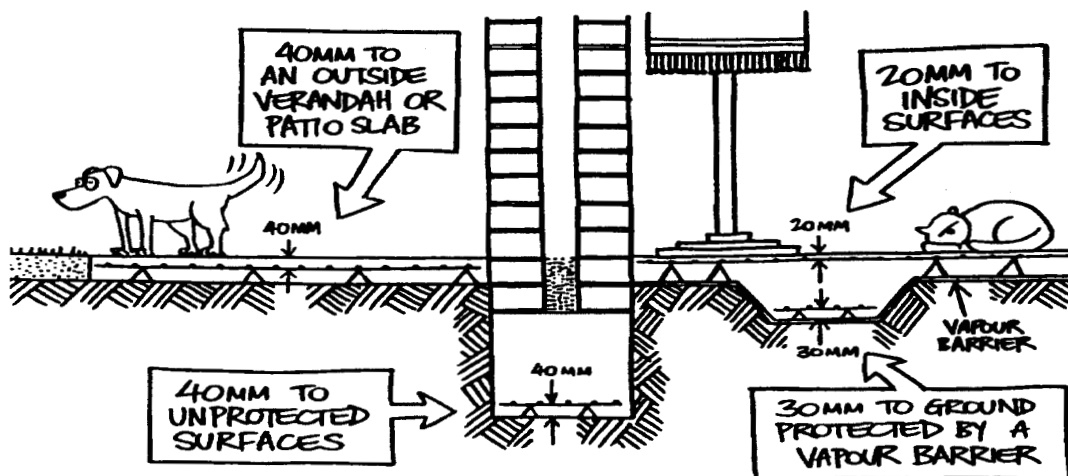

Cracking and Reinforcement Reinforcement alone WILL NOT STOP cracking, but helps control cracking. It is used to control the width of shrinkage cracks.

See CHAPTER 16 Cracking in Concrete

Concrete Reinforcement Bond To help control the width of cracks, or their location (at joints), there must be a strong bond between concrete and reinforcement. This allows the tensile forces (which concrete has a very low ability to resist) to be transferred to the reinforcement.

To help achieve a strong bond:

The reinforcement should be CLEAN (free from flakey rust, dirt or grease).

The concrete should be PROPERLY COMPACTED around the reinforcement bars.

Reinforcing bars and mesh should be located so that there is enough room between the bars to place and compact the concrete.

To improve the transfer of tensile forces to the steel, the reinforcement is often anchored by:

BENDING,
HOOKING, or
LAPPING the bars.

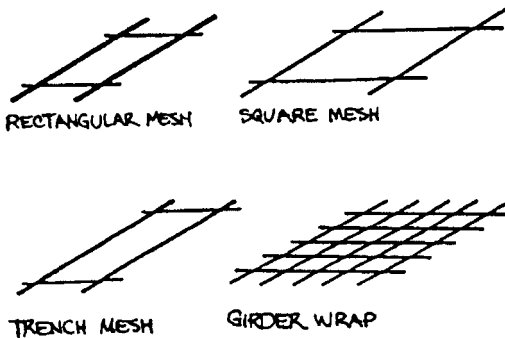
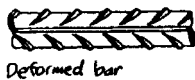
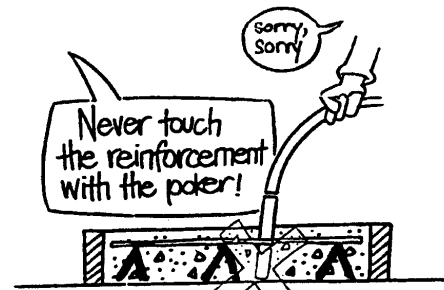

Types of Reinforcement Two types of steel reinforcement used are mesh sheets or loose bars.

Loose bars are normally deformed, while mesh may be made from either smooth or deformed bars. Typical bar diameters are 12, 16, 20 and 24 mm.

Typical mesh sizes are SL42, 52, 62, 72 and 82. The SL stands for Square mesh Low Ductility and the numbers represent meanings as well. For example for SL42 the 4 is the nominal bar size and the 2 refers to the wire spacing (200 mm).

Fibre Reinforcement Synthetic fibres can be added to concrete to aid in minimising early age plastic shrinkage and can reduce the presence of excessive bleedwater. However, synthetic fibres are not a replacement for fabric or steel reinforcement. In slab on ground construction the control joint spacing is the same as plain concrete.

Steel fibres are used for the above and to improve the toughness of concrete. However they can be used to control drying shrinkage cracking over limited spacings and for odd-shaped slabs. They also increase the flexural, or bending, strength of concrete.

CHAPTER 18 Formwork

Formwork gives concrete its SHAPE.

Formwork provides a mould, into which concrete is placed. When concrete has hardened the formwork is removed.

Formwork must be:

ACCURATE
STRONG, and
WELL MADE.

Formwork that is not will leak from the joints, may sag, bulge or move and, especially in large construction, will not be safe.

The surface of the forms in contact with concrete affects how concrete will look. If the final look of the concrete is important choose a material which will leave the surface texture wanted.

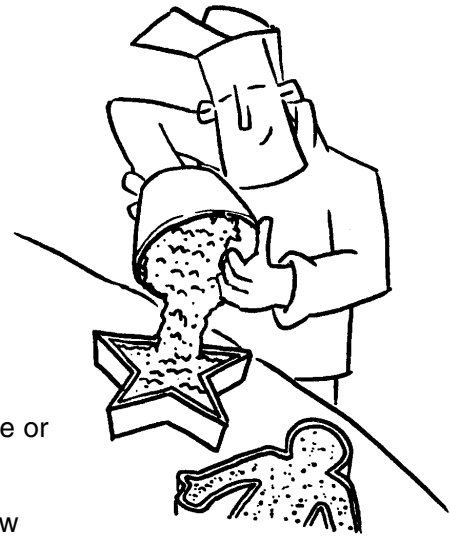

PLACEMENT Be sure that formwork is placed so it can be removed. If formwork is placed in awkward positions or tight corners it may be difficult to remove when the concrete had hardened.

It is helpful if formwork is:

SIMPLE to build,
EASY to hand, and
RE-USEABLE.

Formwork sections should be of simple design, not too big and of standard sizes if they are to be re-used.

MATERIALS Formwork is normally made from steel or timber. Timber is easy to make into formwork while steel will allow a greater number of re-uses.

Formwork can be made on site or bought from formwork suppliers. Special forms made from various materials can be purchased for forming waffle slabs, circular columns and other special profiles.

REMOVAL TIMES Form Oil should be applied to the inside of the formwork to stop it sticking to the concrete and make removal easier. Coat **BEFORE** the reinforcement is put in place. Formwork may be left in place to help curing.

See CHAPTER 10 Curing Concrete

Removal time may vary according to the weather,

In cold weather, concrete may take longer to gain strength than in warmer weather, therefore removal times will be longer.

In normal conditions (around 20°C) 7 days is long enough to leave the forms in place unless the concrete is suspended when other conditions apply.

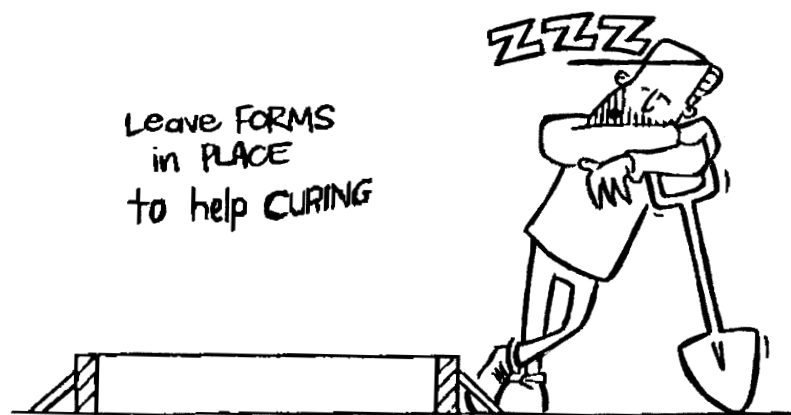

MORE Information

Table 1 METRIC MEASUREMENTS, some useful approximations

10 millimetres (mm)	0.4 inch (in)
25 mm	1 in
100 mm	4 in
300 mm	1 foot (ft)
1 metre (1000 mm)	3 ft 3.37 in
1 square metre (1 m ²)	10.76 ft ² or 1.2 yard ² (yd ²)
1 cubic metre (1 m ³)	35 ft ³ or 1.3 yd ³
1 litre	1.75 pint (pt)
4.5 litres	1 gallon
1 kilograms (kg)	2.2 pounds (lb)

If you found *Concrete Basics* to be useful you may also find the following Cement Concrete & Aggregates Australia publications available for sale through Standards Australia (1300 654 646 or www.standards.com.au) to be of interest:

Guide to Concrete Construction C&CAA T41 – 2002

A valuable guide for anyone involved in concrete construction projects of any size. Provides a guide to the materials, manufacture, testing and properties of concrete and details techniques and practices for carrying out various operations involved in concrete construction.

Concrete Practice on Building Sites C&CAA T43 – 1995

Provides a guide to good practice regarding all aspects of concreting activities on building sites. This user-friendly guide advises on forming, reinforcing, handling, placing, compacting, finishing and curing of concrete.

The following FREE OF CHARGE publications and data sheets may also be useful to you. These can be downloaded from www.concrete.net.au.

The Housing Concrete Handbook Supported by the Housing Industry Association of Australia this publication is designed for house-builders and on-site workers. Providing more detailed information than *Concrete Basics* it acts as a solid reference guide to understanding, ordering and handling concrete and other cement-based materials to ensure good quality concreting practices.

[The Housing Concrete Handbook](#)

DATA SHEETS

Assessing Concrete Volumes

Curing of Concrete

Compaction of Concrete

Avoiding Surface Imperfections in Concrete – *a series of data sheets covering*
Crazing, Popouts, Honeycombing, Dusting *and* Flaking

Plastic Shrinkage Cracking

Plastic Settlement Cracking

Cleaning Concrete

Cement Concrete & Aggregates Australia is committed to being the major source of information on cement, concrete and aggregates in Australia. For a complete listing of all retail and free publications please visit and bookmark the CCAA website www.concrete.net.au.