



fitlet3



Owner's Manual

Safety instructions

Use the following safety guidelines to help protect your computer from potential damage and to help to ensure your personal safety. Unless otherwise noted, each procedure included in this document assumes that you have read the safety information that shipped with your computer



WARNING: Disconnect all power sources before opening the computer cover or panels. After you finish working inside the computer, replace all covers, panels, and screws before connecting to the power source.



CAUTION: Some repairs may only be done by a certified service technician. You should only perform troubleshooting and simple repairs as authorized in your product documentation, or as directed by the online or telephone service and support team. Damage due to servicing that is not authorized by C-LAB is not covered by your warranty. Read and follow the safety instructions that came with the product.



CAUTION: To avoid electrostatic discharge and prevent internal components damage from electrostatic discharge when touching computer or its parts, ground yourself by using a wrist grounding strap or by periodically touching an unpainted metal surface, such as a connector on the back of the computer.



CAUTION: Handle components and cards with care. Do not touch the components or contacts on a card. Hold a card by its edges or by its metal mounting bracket. Hold a component such as a processor by its edges, not by its pins.



CAUTION: When you disconnect a cable, pull on its connector or on its pull-tab, not on the cable itself. Some cables have connectors with locking tabs; if you are disconnecting this type of cable, press in on the locking tabs before you disconnect the cable. As you pull connectors apart, keep them evenly aligned to avoid bending any connector pins. Also, before you connect a cable, ensure that both connectors are correctly oriented and aligned.



CAUTION: This equipment is not suitable for use in locations where children are likely to be present.

Consignes de sécurité

Utilisez les consignes de sécurité suivantes pour protéger votre ordinateur contre les dommages potentiels et pour garantir votre sécurité personnelle. Sauf indication contraire, chaque procédure incluse dans ce document suppose que vous avez lu les consignes de sécurité fournies avec votre ordinateur.



AVERTISSEMENT: Débranchez toutes les sources d'alimentation avant d'ouvrir le capot ou les panneaux de l'ordinateur. Une fois que vous avez fini de travailler à l'intérieur de l'ordinateur, remettez en place tous les capots, panneaux et vis avant de vous connecter à la source d'alimentation.



PRÉCAUTION: Certaines réparations ne peuvent être effectuées que par un technicien de maintenance agréé. Vous ne devez effectuer le dépannage et les réparations simples que comme autorisé dans la documentation de votre produit ou comme indiqué par l'équipe de service et d'assistance en ligne ou par téléphone. Les dommages dus à une intervention non autorisée par C-Lab ne sont pas couverts par votre garantie. Lisez et respectez les consignes de sécurité fournies avec le produit..



PRÉCAUTION: Pour éviter les décharges électrostatiques et éviter d'endommager les composants internes du fait des décharges électrostatiques, lorsque vous touchez l'ordinateur ou ses composants, mettez-vous à la terre à l'aide d'un bracelet antistatique ou en touchant périodiquement une surface métallique non peinte, telle qu'un connecteur à l'arrière de l'ordinateur.



PRÉCAUTION: Manipulez les composants et les cartes avec précaution. Ne touchez pas les composants ou les contacts d'une carte. Tenez une carte par ses bords ou par son support de montage en métal. Tenez un composant tel qu'un processeur par ses bords et non par ses broches.



PRÉCAUTION: Lorsque vous déconnectez un câble, tirez sur son connecteur ou sur sa languette, et non sur le câble lui-même. Certains câbles ont des connecteurs avec des languettes de verrouillage ; si vous déconnectez ce type de câble, appuyez sur les languettes de verrouillage avant de déconnecter le câble. Lorsque vous séparez les connecteurs, maintenez-les alignés uniformément pour éviter de plier les broches du connecteur. De plus, avant de connecter un câble, assurez-vous que les deux connecteurs sont correctement orientés et alignés.

PRÉCAUTION: Cet équipement n'est pas adapté à une utilisation dans des endroits où des enfants sont susceptibles d'être présents.



Table of contents

SAFETY INSTRUCTIONS	2
INTRODUCTION	5
SPECIFICATIONS	6
FEATURES	6
DIMENSIONS	7
INTERFACES	7
EXPANSION BOARDS	8
OPTIONAL ACCESSORIES	8
CONNECTORS LAYOUT	9
QUICK START GUIDE	10
MINIMUM REQUIREMENTS	10
IDENTIFYING FITLET3 CONFIGURATION	10
OPENING FITLET3	10
INSTALLING RAM	12
M.2 COOLING PLATE AND SSD	13
RTC BATTERY	18
INSTALLING RTC BATTERY	18
RE-ASSEMBLING FITLET3	19
CONNECTING FITLET3	20
ENTERING BIOS SETUP	21
INSTALLING AND BOOTING OPERATING SYSTEM	21
SERVICE	22
SUPPORT	22
WARRANTY	22
RMA	22

For more information and to obtain the latest revision of this document, please visit: www.fit-iot.com

For technical support and product related questions, please email: support@fit-pc.com

Introduction

Thank you for purchasing **fitlet3**. It is a miniature PC designed to be tough, capable, versatile and user-friendly. With proper installation, we expect fitlet3 to serve you for many years. The unique fanless design of fitlet3 eliminates the need for any maintenance after installation.

Please consult this owner's manual for getting started with fitlet3. You are welcome to contact fitlet3 manufacturer - C-LAB at www.fit-iot.com or support@fit-pc.com should you have any technical questions.

fitlet3 features

- Intel Elkhart Lake CPU
- Up to 32 GB DDR4 RAM
- NVMe | M.2 SATA | 2.5" storage*
- Dual head 4K display
- Up to 4 Gbit Ethernet ports* | WiFi* | cellular communication*
- USB 3.1, USB 2.0, audio, optional Isolated serial + GPIO ports, indicator LED
- Supports Windows 10, Windows 11 and Linux
- Can be extended with **Function And Connectivity Extension T-Cards** (FACET Cards)
- All-metal fanless housing 132.8 mm X 100 mm X 34.8 mm
- Operating temperature range is from -40°C to 85°C (depending on ordered configuration, power supply unit not included)

** Feature may require an extension FACET card*

Package contents

1. fitlet3 computer
2. Power supply: input 100-240VAC 50/60Hz, output 12VDC 3A with universal AC plugs
3. Antennas, according to configuration
4. Owner's manual

NOTES

- Additional accessories can be purchased separately here: <https://fit-iot.com/web/products/fitlet3/buy-fitlet3/>
- Some fitlet3 configurations come pre-installed with additional devices and accessories

Specifications

Features

- IOT gateway / Fanless industrial PC
- Intel® Atom Elkhart Lake processor
- NVMe + SATA storage
- 2x/4x Gigabit LAN
- Optional Wi-Fi/BT + LTE/5G modem
- Optional Isolated serial + GPIO ports
- 9V - 42V DC power input

CPU	Intel® Atom x6425E	4 Core Base: 2.0 GHz, Boost: 3.0 GHz TDP: 12 W
	Intel® Celeron J6413	4 Core Base: 1.8 GHz, Boost: 3.0 GHz TDP: 10 W
	Intel® Atom x6211E	2 Core Base: 1.3 GHz, Boost: 3.0 GHz TDP: 6 W
Memory	Type	S0-DIMM DDR4 up to 3200MT/s
	Max. capacity	32 GB
Storage	M.2 Key-M	PCIe x4 / SATA for M.2 NVMe or SATA, size up to 2280
	M.2 Key-B	SATA for M.2 SATA, size up to 2260
	2.5" HDD/SSD	Optional M.2 to SATA expansion for 2.5" HDD / SSD
Display	HDMI	HDMI 1.4b (up to 3840 x 2160 @ 30Hz)
	Mini-Display Port	DP 1.2 (up to 4096 x 2160 @ 60Hz) Dual mode
Ethernet	Type	2x Gigabit Ethernet on RJ45
	Controllers	Internal MAC with discreet PHY
	Speed	1000 Mbps / 100 Mbps / 10 Mbps
	Optional FC3-LAN	Additional 2x GbE LAN on RJ45
	Optional FC3-OPLN	Additional 1x GbE LAN on SFP+ for optical LAN
Wireless Connectivity	On-board	Optional On-board module with Wi-Fi 6E, BT 5.2
	M.2 Key-E ¹	For M.2 2230 module with Wi-Fi 6E, BT 5.2
	M.2 Key-B	For M.2, LTE/5G modem, with micro-SIM tray
USB	USB 2.0	4x USB 2.0 on USB Type-A
	USB 3.1	2x USB 3.1 on USB Type-A
Serial/GPIO	Type	Isolated serial and GPIO, up to 24V, on terminal block
	Serial port	Optional isolated RS-232/422/485
	GPIO	2x isolated GPI + 2x isolated GPO
Audio	Codec	Optional audio codec
	Interfaces	Optional analog output, analog input on 3.5 mm jacks
Power	Input power	9V - 42V, up to 36W, DC input supply (The user can use any other approved AC/DC adapter that limited to 9-42Vdc, 36W max)
	Connector	5.5 mm power jack w/ locking
	Power supply unit	Including universal AC wall mount power (0 - 40°C)
	Optional FC3-PoE	Input power by PoE, GbE LAN on RJ45
TPM	Internal fTPM	Intel® PTT
	Discreet TPM	Optional discreet TPM 2.0
OS support	Windows 10	Windows 10 Pro / Windows 10 LTSC 2021 IoT Enterprise
	Windows 11	Windows 11 Pro
	Linux	Linux Mint / Ubuntu
Operating Environment	Commercial temperature	0°C to 45°C
	Extended temperature	-20°C to 70°C
	Industrial temperature	-40°C to 85°C
	* fitlet3 power supply unit is suitable for up to 40°C	
Humidity	5% - 95% non-condensing	
Physical Characteristics	Cooling	Fanless, passive cooling
	Dimensions	132.8 mm X 100 mm X 34.8 mm
	Weight	~ 420 gr.
	Mounting	Side / bottom VESA / DIN Rail mount

Dimensions

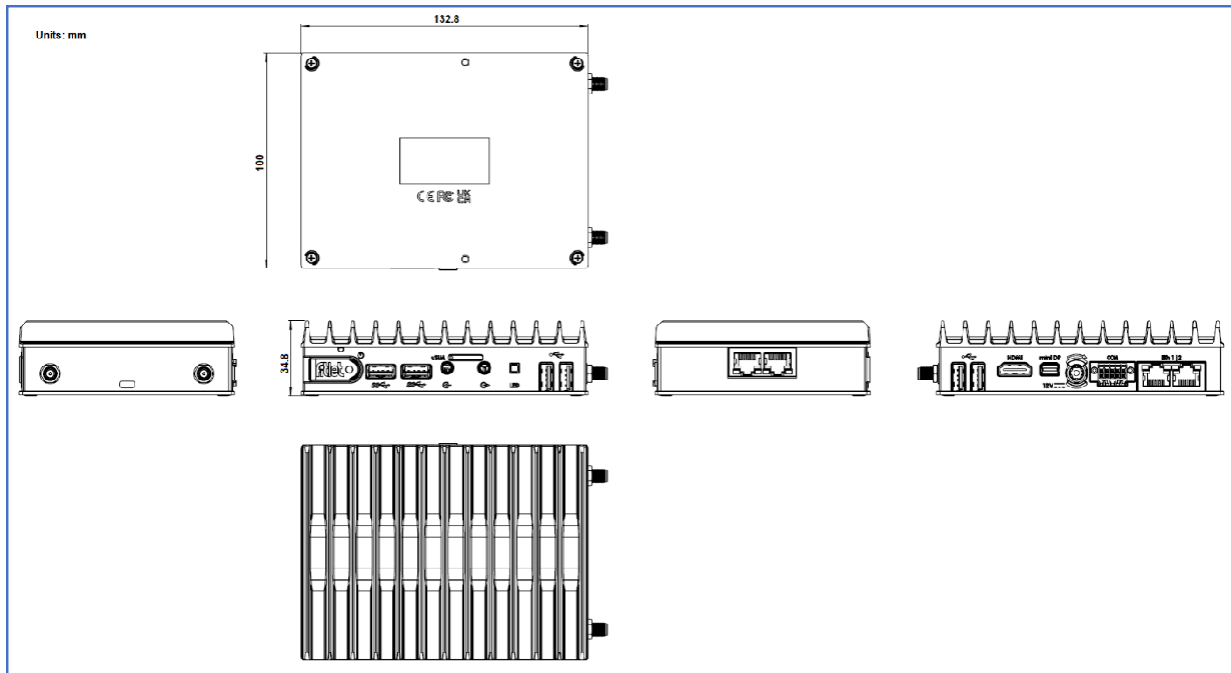

Interfaces

Location	Connector	Interface		
Front Panel	2x USB Type-A	2x USB 2.0		
	1x HDMI	HDMI 1.4b (up to 3840 x 2160 @ 30Hz)		
	1x mini-DP	DP 1.2 (up to 4096 x 2160 @ 60Hz) Dual mode		
	1x 5.5 mm power jack	9V - 42V DC power input		
	1x terminal block (Optional)	Isolated RS-232/422/485 + 2x GPI + 2x GPO		
	2x RJ45	2x 10/100/1000 Mbps Ethernet		
Rear Panel	Power button	On/Off push button w/ power LED		
	2x USB Type-A	2x USB 3.1		
	2x 3.5 mm jacks (Optional)	Analog output, analog input audio		
	Micro-SIM tray	Micro-SIM Tray for M.2 LTE/5G modem		
	LED	Debug/programmable LED		
	2x USB Type-A	2x USB 2.0		
Right Panel	2x SMA (Optional)	2x SMA antennas for Wi-Fi/BT or cellular modem		
Left Panel	FACET card connectors (Optional)	Ethernet, serial, etc. from FACET expansion card		
	2x SMA (Optional)	2x SMA antennas for Wi-Fi/BT or cellular modem		
Location	Connector	Form factor	Interface	Usage
Internal Top	SO-DIMM	DDR4 SO-DIMM	DDR4	DDR4 module
Internal Bottom	M.2 Key-M	M.2 up to 2280 or Optional 2.5" SATA storage ¹	PCIe Gen 3 x4 / SATA	- NVMe/SATA storage - M.2 PCIe x1x HDMI
	M.2 Key-B	M.2 Up to 3060 or Optional 2.5" SATA storage ¹	PCIe Gen 3 x1 /SATA USB 2.0	- LTE/5G modem - SATA storage
	M.2 Key-E	M.2 2230 or FACET expansion card ²	PCIe Gen 3 x2 USB 2.0	- Wi-Fi/BT module - FACET card

Notes:

- Up to 1 unit of 2.5" SATA storage expansion (EB-M2SATA) is possible
- FACET expansion card and Wi-Fi/BT card are mutually exclusive. For Wi-Fi/BT on systems with FACET cards, on-board Wi-Fi/BT module must be selected.

Expansion boards

Name	Description	Compatible connector
FC3-LAN	2x GbE LAN on RJ45	M.2 Key-E (FACET) ¹
FC3-POED	GbE LAN PoE device on RJ45	M.2 Key-E (FACET) ¹
FC3-OPLN	GbE on SFP+ for optic LAN	M.2 Key-E (FACET) ¹
EB-M2SATA	SATA expansion for 2.5" HDD / SSD ^{2,3}	M.2 Key-M or M.2 Key-B

Notes:

1. FACET expansion card and Wi-Fi/BT card are mutually exclusive. For Wi-Fi/BT on systems with FACET cards, on-board Wi-Fi/BT module must be selected.
2. Up to 1 unit of EB-M2SATA is possible, and up to two storage devices in total.
3. EB-M2SATA expansion requires deep bottom that will enlarge the fitlet3 size.

Optional accessories

Name	Description
FITLET3-ACC-PSU	Universal power supply unit (one units is included in fitlet3 package)
FITLET3-ACC-BRKT	VESA mounting bracket
FITLET3-ACC-DIN	DIN rail mounting kit (Requires VESA mounting bracket)
FITLET3-ACC-DINSD	Side DIN rail mounting kit (does not require VESA mounting bracket)
FITLET3-ACC-POWBTN	Remote power button with LED with 25cm wire

Connectors layout

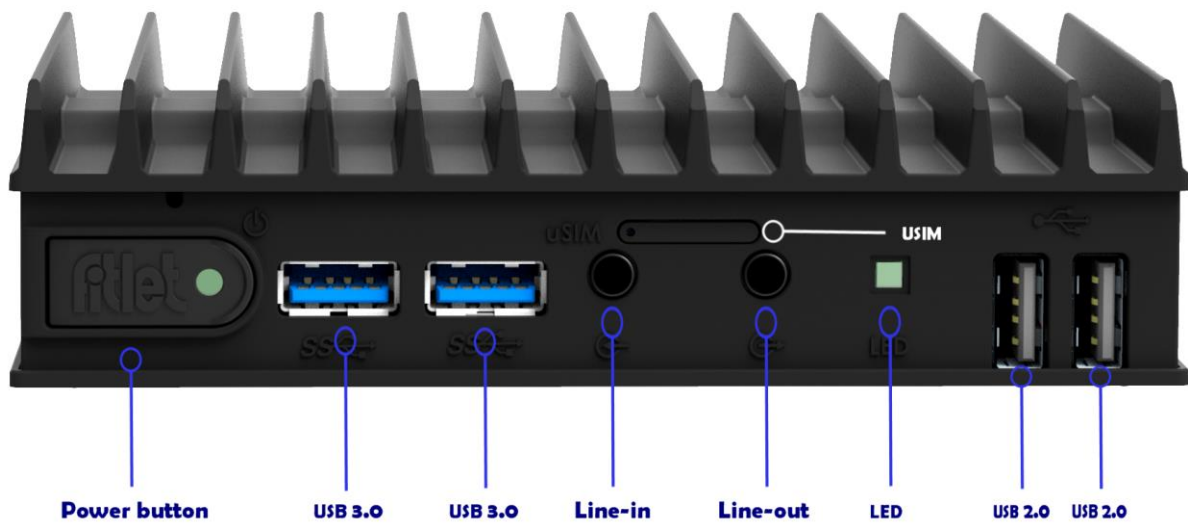
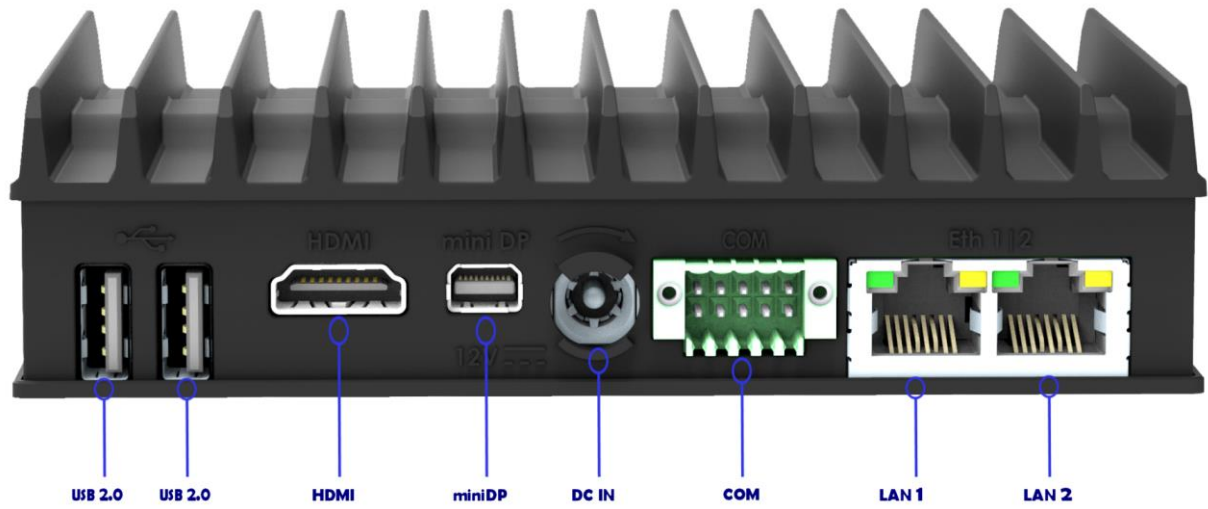

Quick start guide

Minimum requirements

To use fitlet3 you will need:

- RAM and storage device (if not pre-installed)
- A display with HDMI or DisplayPort input + HDMI or mini-DisplayPort cable
- USB keyboard and mouse

Identifying fitlet3 configuration

fitlet3 configuration is detailed on the label attached to the bottom side of the computer.

Note

Pay attention to RAM and storage. If **not installed**, fitlet3 will not boot. You will have to install these devices firstly.

Opening fitlet3

You will need to open fitlet3 in order to install RAM, storage and RTC battery.
 Required tool: Phillips screwdriver.

To open fitlet3 please follow these steps:

1. Place fitlet3 on a flat surface bottom-up.
2. Open the four screws using the Phillips screwdriver (counter clock-wise).
3. Lift the bottom cover to remove it. Side panels should fall-off.

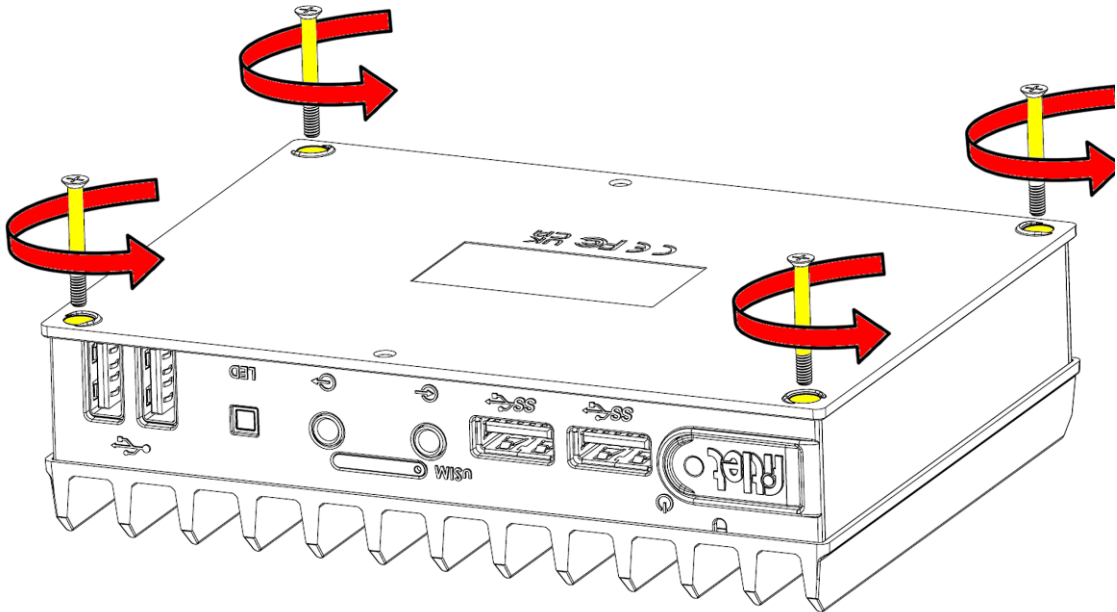

4. Lift fitlet3 from the top cover

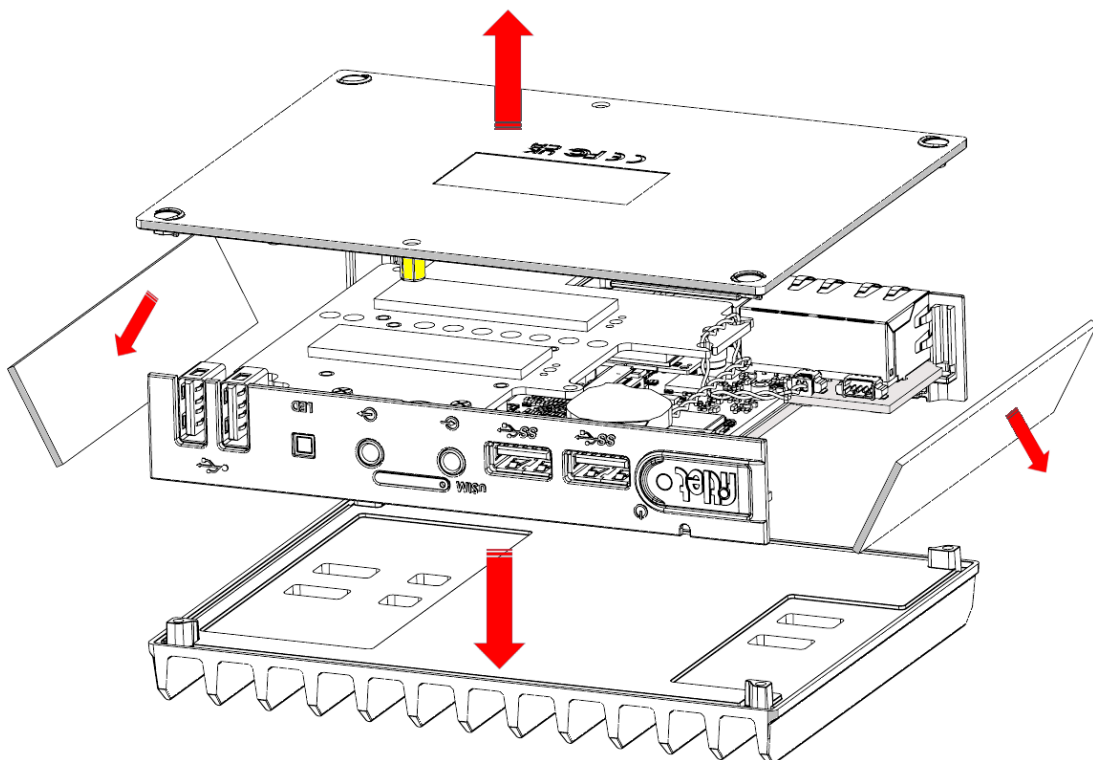

Installing RAM

RAM socket is positioned on the top side of the motherboard.
fitlet3 accepts a single SODIMM DDR4.

Insert DDR4 SODIMM module and press it down until it is latching firmly on both sides

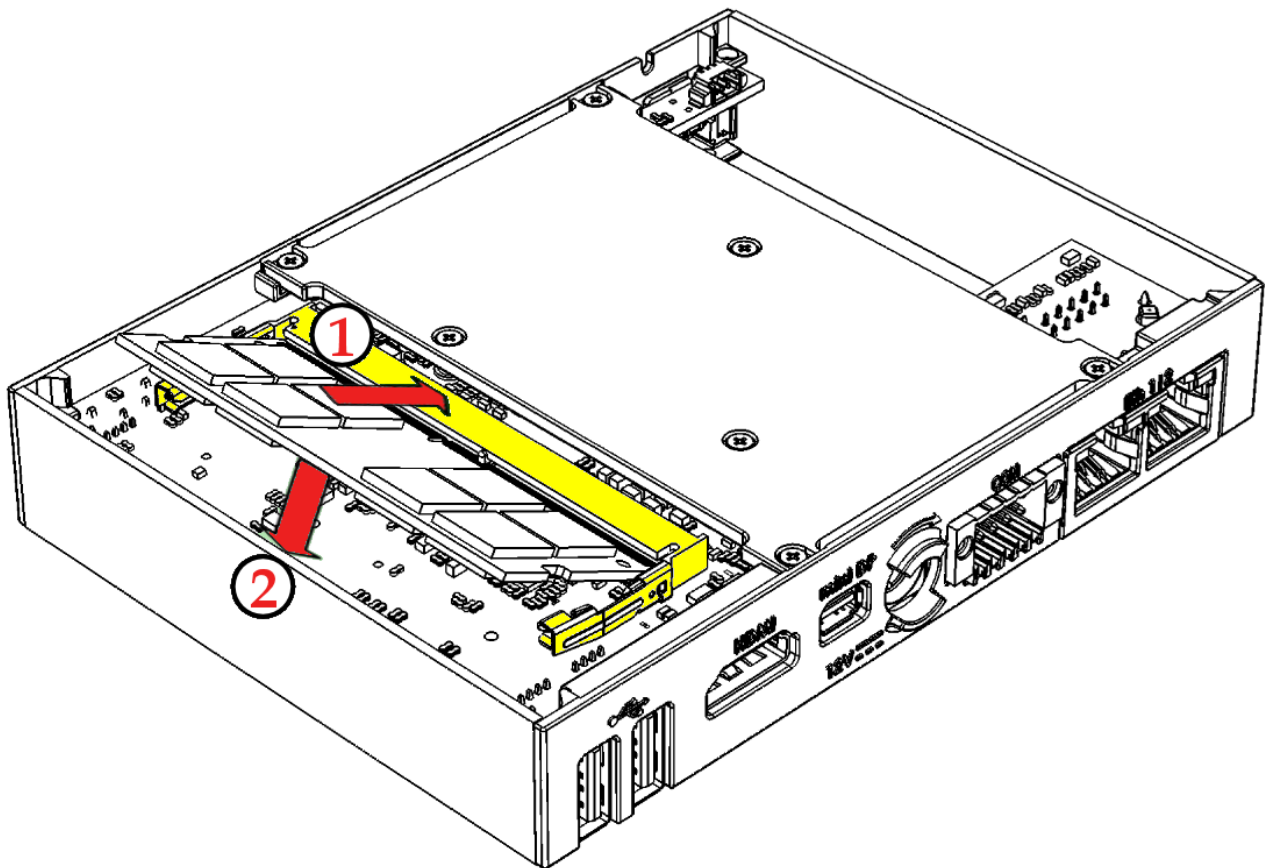

M.2 cooling plate and SSD

The M.2 cooling plate has several purposes:

- Allow installation of multiple form factor M.2 devices and FACET Cards
- Provide cooling to M.2 devices
- Assist in battery placement
- Provide proper cable management inside fitlet3

M.2 Key-M accepts SATA or NVME modules, 2230, 2242, 2260 or 2280.

M.2 Key-B accepts SATA M.2 modules or modems, with lengths of 30mm, 42mm, 52mm or 60mm and widths 22mm or 30mm

The SSD has to be fastened to the M.2 cooling plate. Then the M.2 cooling plate is then placed on the underside of the motherboard and fastened to the front and back panel

To install SSD onto M.2 cooling plate

1. Peel-off protective film from the two thermal pads.
2. Place the red M.2 spacer according to the length of the M.2 SSD as depicted below. Note orientation of the spacer: The recessed side should face the alignment screws. Insert M.2 fastening screw but **do not tighten!**

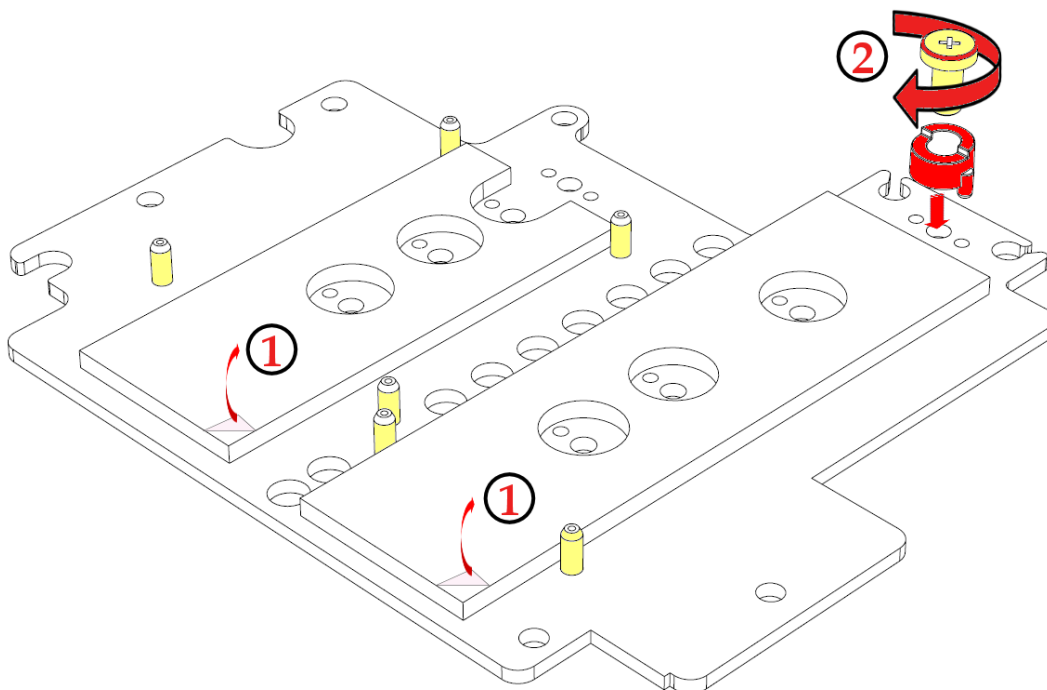

3. Place edge of M.2 SSD against the fastening screw
 - a. Press the SSD firmly against the thermal pad until its connector edge is seated between the alignment pins.
 - b. Once positioned correctly the connector edge should stick out above the edge of the M.2 cooling plate.
4. Tighten the fastening screw

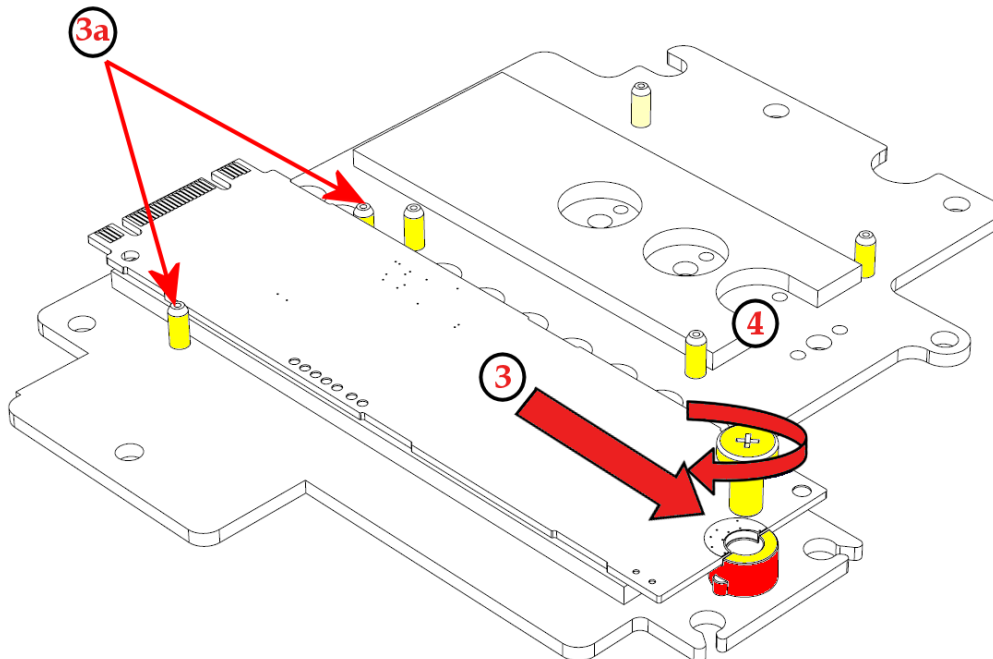

5. Turn over the M.2 cooling plate and push the M.2 SSD into its socket at the underside of the motherboard.

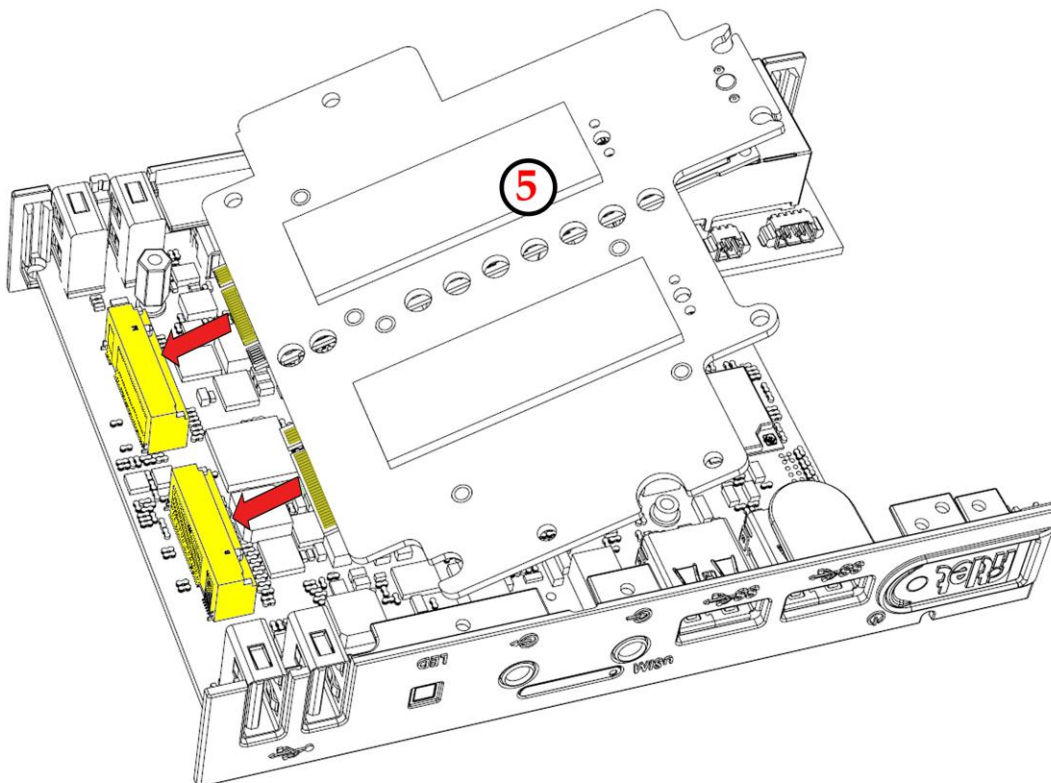

6. Push down the M.2 cooling plate and tighten the 3 panel screws

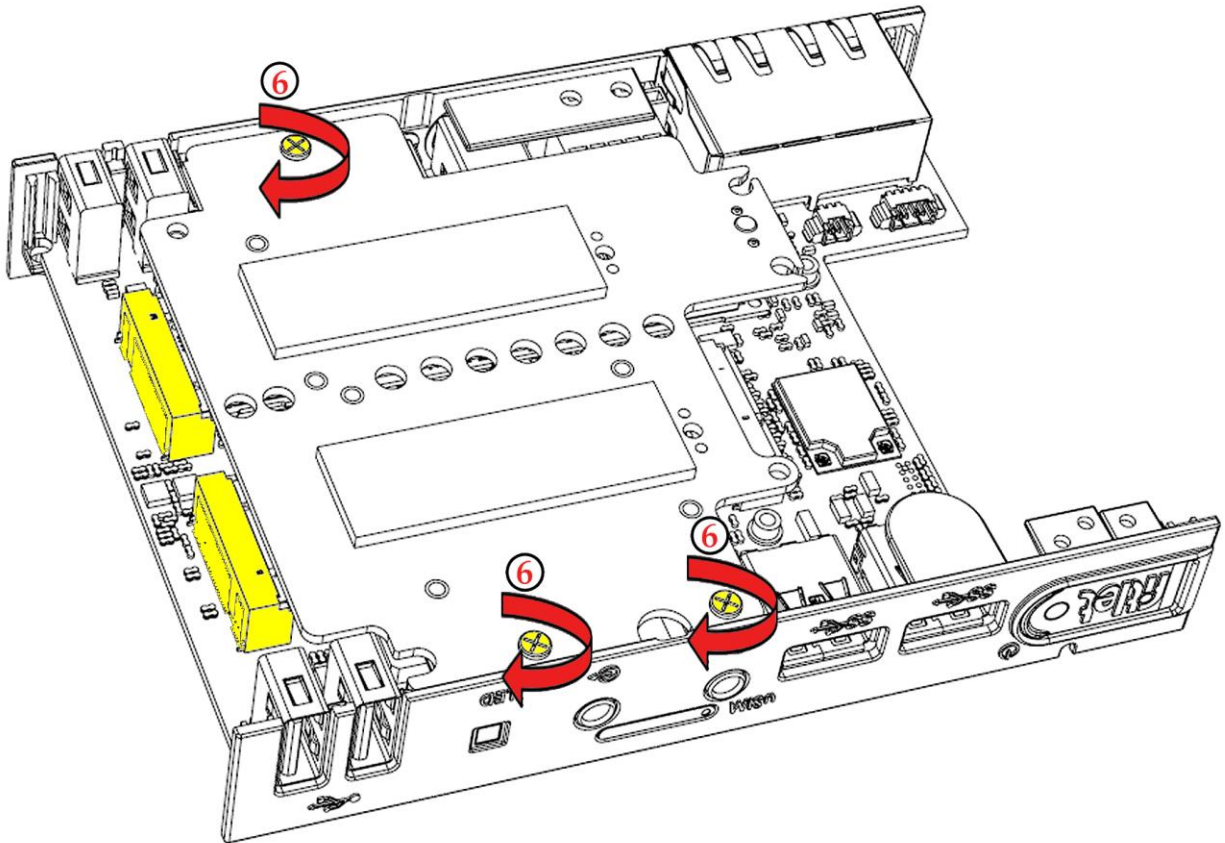

Optional WiFi/BT Module

By default the WiFi/BT module is not installed.

Installing WiFi/BT module

1. Assemble the adapter
2. Tighten the appropriate screws
3. Insert the red spacer and fastening screw but don't tighten it.

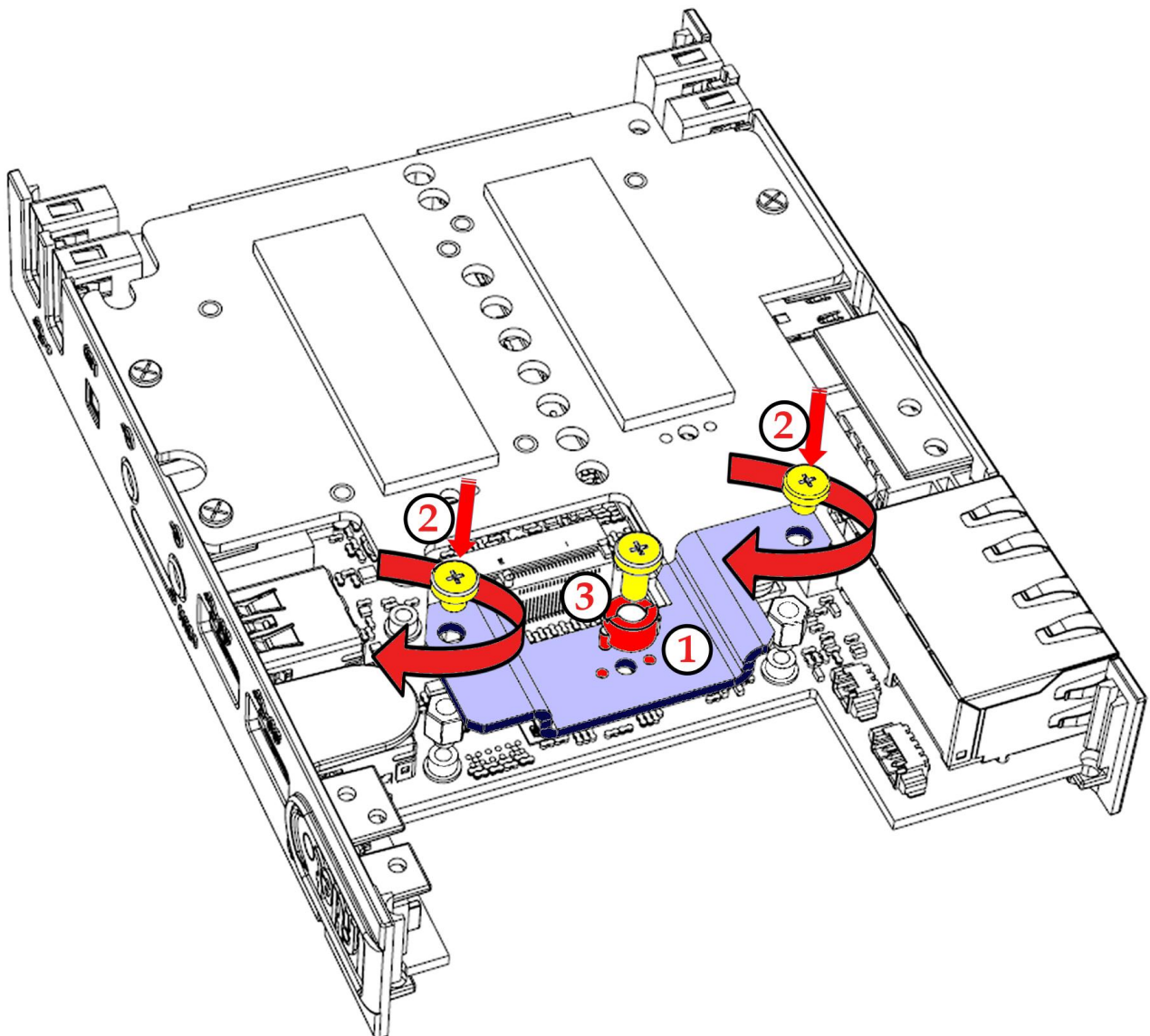

4. Insert the WiFi/BT module into an appropriate socket in an angle.
5. Press it down until latching the spacer.
6. Tighten the fastening screw.

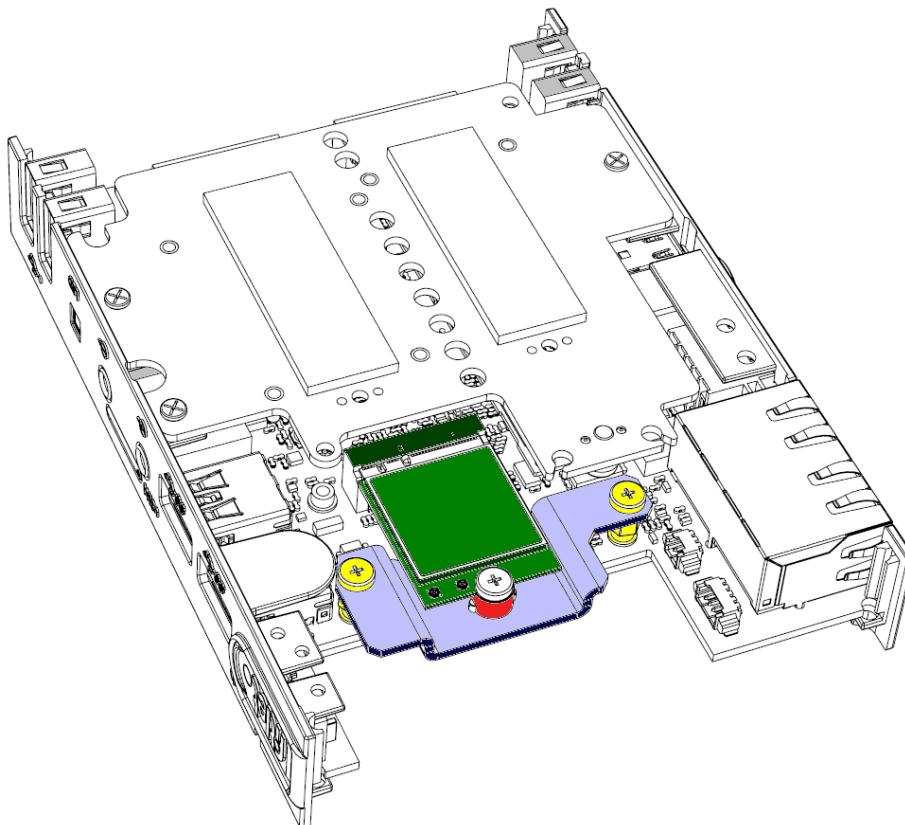
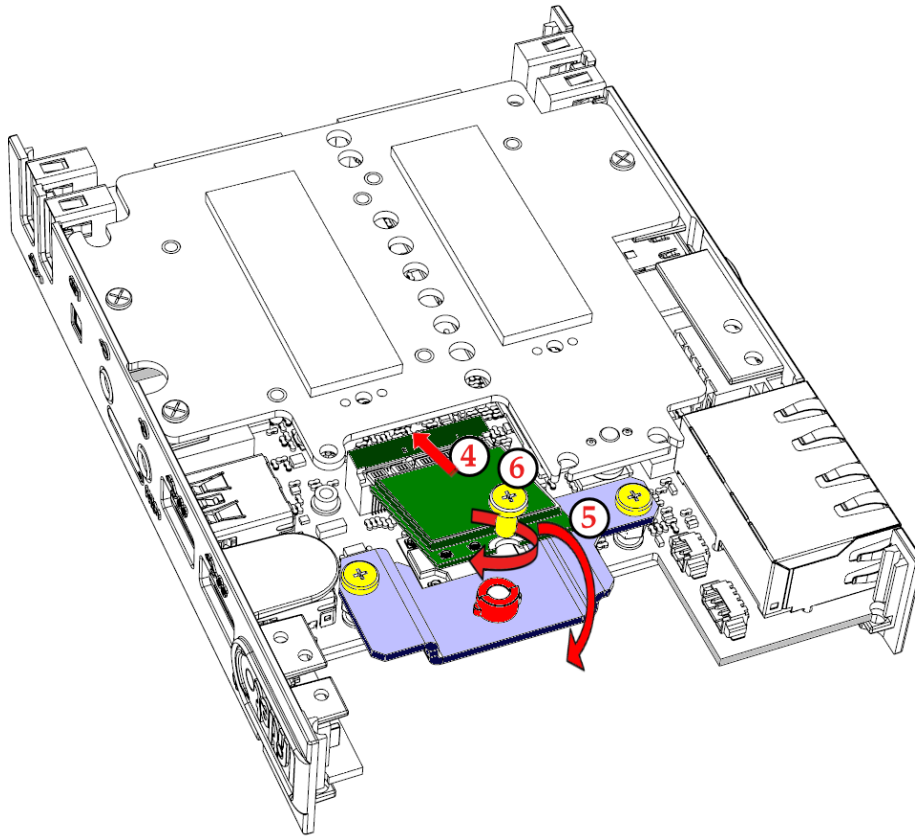

RTC battery

The RTC battery is used for keeping time and date while fitlet3 is disconnected from power. BIOS settings and power-up policy is independent of battery. fitlet3 normally ships with the battery unplugged to ensure that the battery is not discharged during warehousing.

The battery can keep charge for approx. 5 years when fitlet3 is disconnected and significantly longer when fitlet3 is connected to power. Battery can be purchased separately to be replaced by the user.

Installing RTC battery

1. Connect the battery plug to the corresponding socket (see illustration).
2. Place the wire as shown inside the slots of the M.2 cooling plate to minimize clutter.
3. Place the battery in the marked pocket. Once fitlet3 bottom cover is assembled - the battery is secured in place.

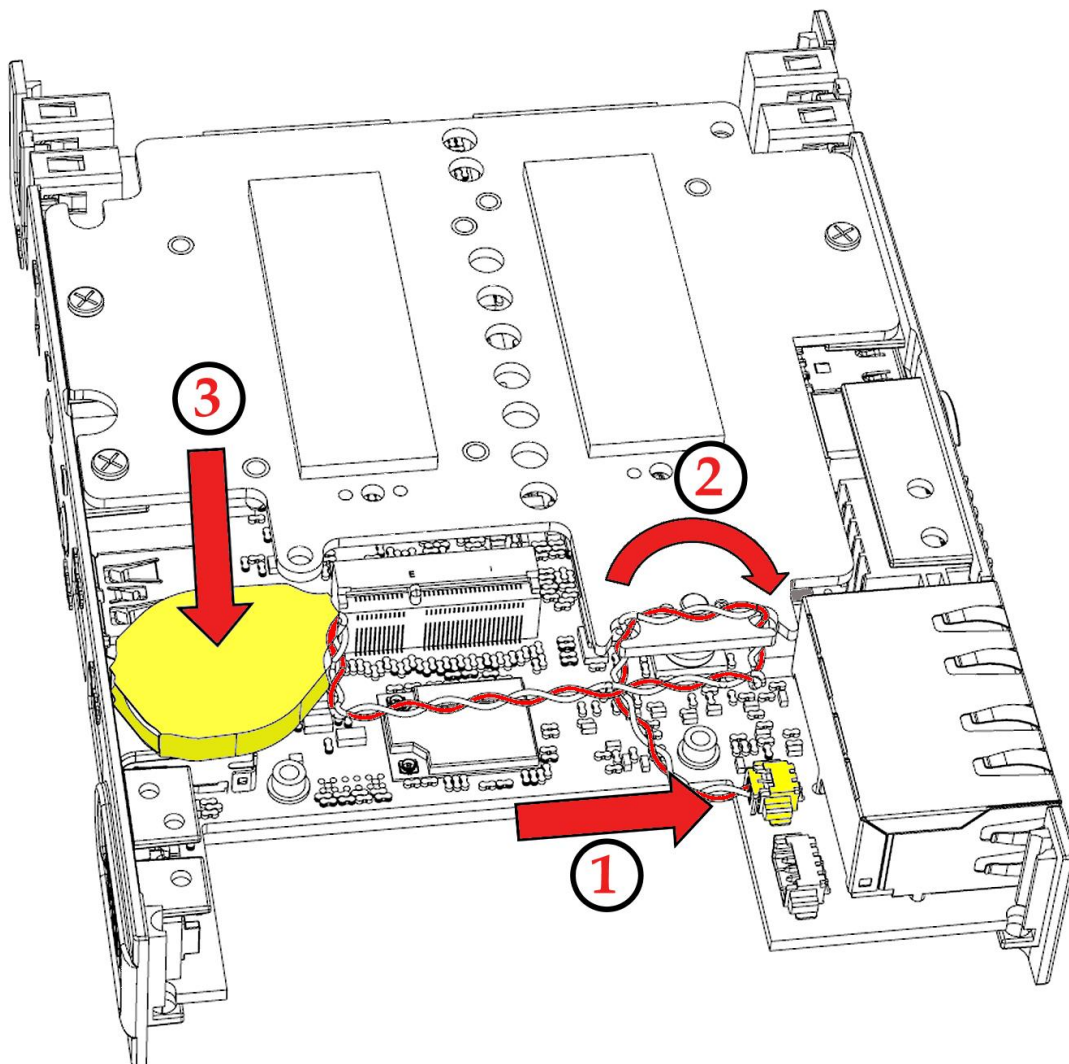

Re-assembling fitlet3

1. Place the fitlet3 onto the top cover.
 Note: The top cover is symmetric - direction does not matter.
2. Place the bottom cover onto the fitlet3.
Important note: The tall U-shaped boss (!) has to be near the M.2 sockets. Otherwise, the bottom cover will not fit!
3. Click both side panels into place
4. Tighten the 4 screws

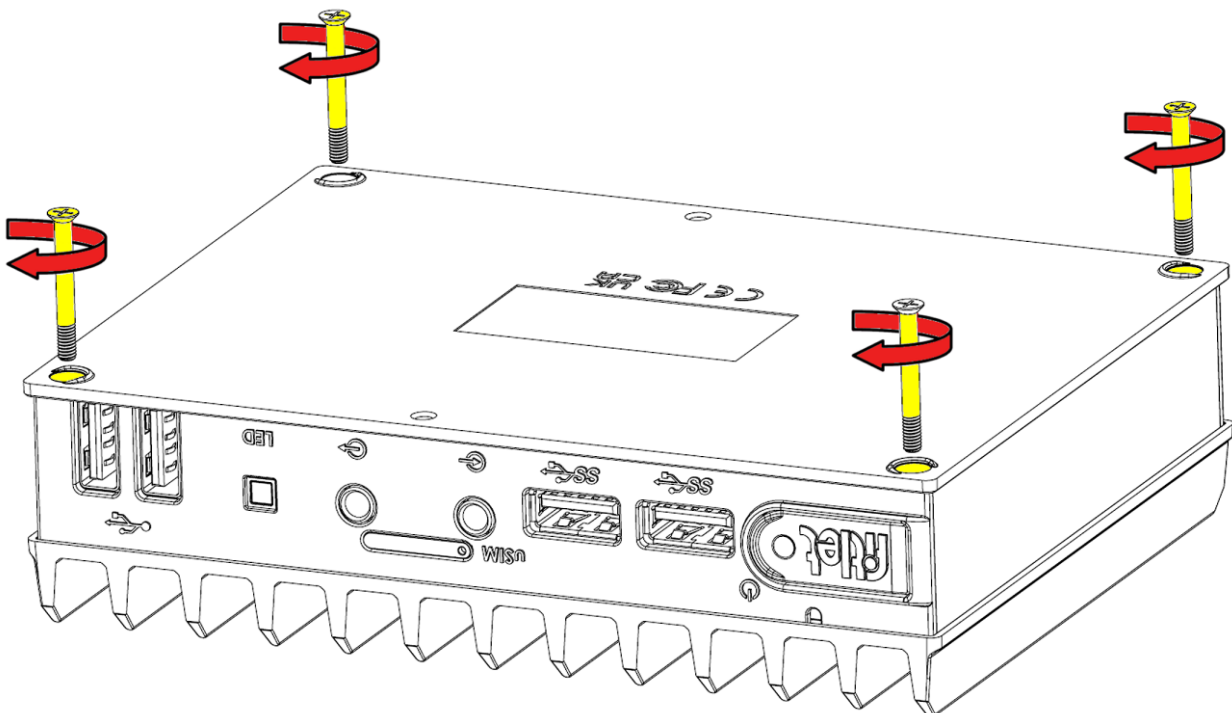
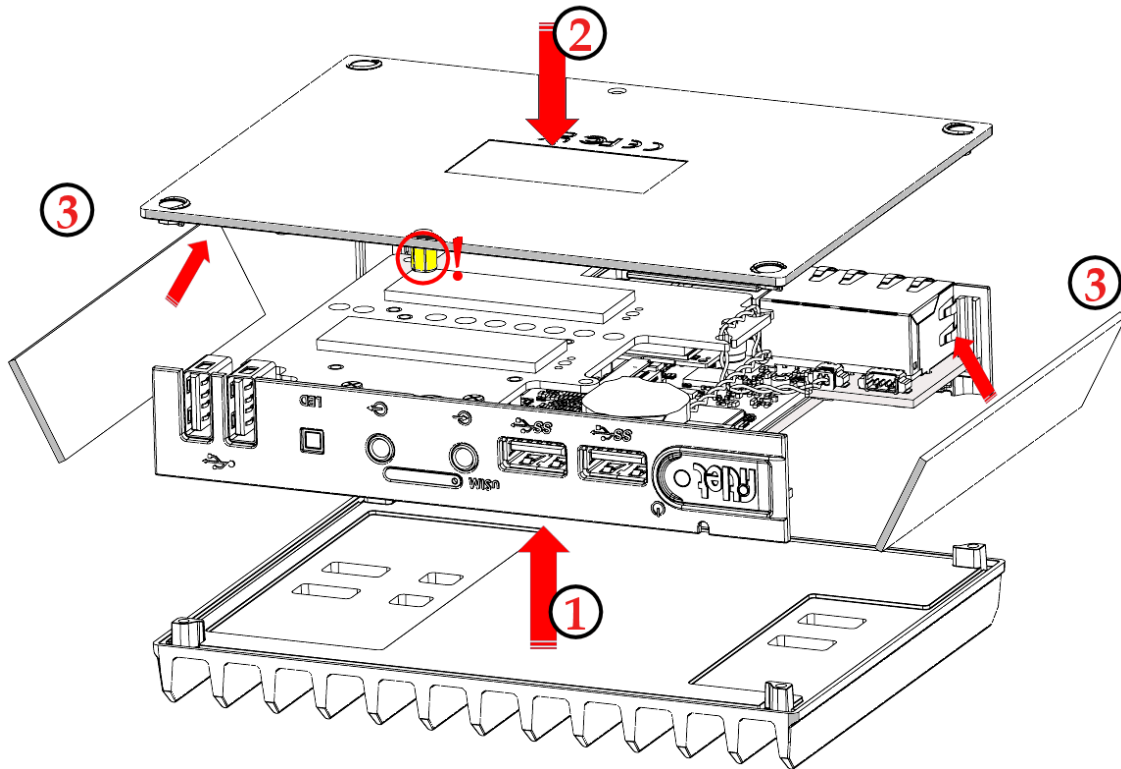

Connecting fitlet3

1. Before connecting fitlet3 please ensure that RAM and storage device are installed as detailed in the above sections.
2. Connect the display to fitlet3 using HDMI or mini-DP cable.
3. Connect to fitlet3 USB keyboard and mouse.
4. Insert the DC plug into the fitlet3 DC-in jack. Rotate clockwise 90° to secure.
5. Slide into the power-supply the AC blade correct to your country and plug the power-supply into an AC-outlet. The power button on fitlet3 should turn green, in a few seconds an image should appear on the display.
6. Connect Ethernet cable as needed. When link is established, the link LED on RJ45 should light.
7. If fitlet3 has WiFi adapter installed you will observe two SMA connectors (gold color screws) on the side panel. Connect the included antennas by screwing them clockwise onto the SMA connectors to enable WiFi communication.

Entering BIOS Setup

Turn off the fitlet3.

Turn on while holding down the Del key, until access into AMI Inc. BIOS utility.

See http://www.fit-pc.com/wiki/index.php/Main_Page.

Installing and booting operating system

Please consult <https://www.fit-iot.com/web/products/fitlet3/os> for instructions.

Service

Support

For technical support and product related questions, please email: support@fit-pc.com

For fitlet3 on support wiki please visit: <http://fit-pc.com/wiki/index.php/Fitlet3>

Warranty

- C-LAB guarantees products against defects in workmanship and material for a period of 60 months from the date of shipment.
- Your sole remedy and C-LAB's sole liability shall be for C-LAB, at its sole discretion, to either repair or replace the defective product at no charge.
- This warranty is void if the product has been altered or damaged by accident, misuse or abuse.

RMA

- Keep the original package for shipping.
- Please contact the seller of that fitlet3.
- When issuing an RMA please provide the following required information:
 - o fitlet3 serial number
 - o Name and address of buyer
 - o Invoice number
 - o Problem description
- If fitlet3 was purchased directly from C-LAB, please email: rma@fit-pc.com



Fitlet3

Manufacturer: C-LAB Ltd.

This device complies with Part 15 of the FCC Rules.

FCC ID: PD98260NG, IC ID: IC 1000M-8260NG; Intel[™]

Operation is subject to the following two conditions:

- (1) This device may not cause harmful interference, and
- (2) This device must accept any interference received, including interference that may cause undesired operation.

Statement

Changes or modifications to this equipment not expressly approved by the party responsible for compliance (C-LAB Ltd.) could void the user's authority to operate the equipment

WEEE



Statement

NOTE: This equipment has been tested and found to comply with the limits for a Class B digital device, pursuant to part 15 of the FCC Rules. These limits are designed to provide reasonable protection against harmful interference in a residential installation. This equipment generates uses and can radiate radio frequency energy and, if not installed and used in accordance with the instructions, may cause harmful interference to radio communications. However, there is no guarantee that interference will not occur in a particular installation. If this equipment does cause harmful interference to radio or television reception, which can be determined by turning the equipment off and on, the user is encouraged to try to correct the interference by one or more of the following measures:

- Reorient or relocate the receiving antenna.
- Increase the separation between the equipment and receiver.
- Connect the equipment into an outlet on a circuit different from that to which the receiver is connected.
- Consult the dealer or an experienced radio/TV technician for help.

This symbol means that you must dispose of an electrical item AND/OR containing in it Li-Mn battery separately from general household waste when they reach the end of their useful life. Take your PC or the battery to your local waste collection point or center. This applies to all countries of the European Union, and to other countries with a separate waste collection system.



Tensor-I22
Fabricant: C-Lab Ltd.

Cet appareil est conforme à la partie 15 des règles de la FCC.

ID FCC : PD98260NG, ID IC : IC 1000M-8260NG ; Intel™

Le fonctionnement est soumis aux deux conditions suivantes :

(1) Cet appareil ne doit pas causer d'interférences nuisibles, et

(2) Cet appareil doit accepter toute interférence reçue, y compris les interférences susceptibles de provoquer un fonctionnement indésirable.

Déclaration

Les changements ou modifications apportés à cet équipement non expressément approuvés par la partie responsable de la conformité (C-Lab Ltd.) pourraient annuler l'autorité de l'utilisateur à utiliser l'équipement.

WEEE



Déclaration

REMARQUE : cet équipement a été testé et déclaré conforme aux limites d'un appareil numérique de classe B, conformément à la partie 15 des règles de la FCC. Ces limites sont conçues pour fournir une protection raisonnable contre les interférences nuisibles dans une installation résidentielle. Cet équipement génère des utilisations et peut émettre de l'énergie de radiofréquence et, s'il n'est pas installé et utilisé conformément aux instructions, peut causer des interférences nuisibles aux communications radio. Cependant, il n'y a aucune garantie que des interférences ne se produiront pas dans une installation particulière. Si cet équipement cause des interférences nuisibles à la réception radio ou télévision, ce qui peut être déterminé en éteignant et en rallumant l'équipement, l'utilisateur est encouragé à essayer de corriger l'interférence par une ou plusieurs des mesures suivantes :

-Réorientez ou déplacez l'antenne de réception.
-Augmenter la distance entre l'équipement et le récepteur.

-Connectez l'équipement à une prise sur un circuit différent de celui auquel le récepteur est connecté.

-Consultez le revendeur ou un technicien radio/TV expérimenté pour obtenir de l'aide.

Ce symbole signifie que vous devez jeter un article électrique ET/OU contenant une batterie Li-Mn séparément des ordures ménagères lorsqu'ils atteignent la fin de leur durée de vie utile. Apportez votre PC ou la batterie à votre déchetterie ou déchetterie locale. Ceci s'applique à tous les pays de l'Union européenne, ainsi qu'aux autres pays disposant d'un système de collecte des déchets séparé.