



NINJAGO

Masters of Spinjitzu

9449



JAY ZX + ZANE ZX
INCLUDED

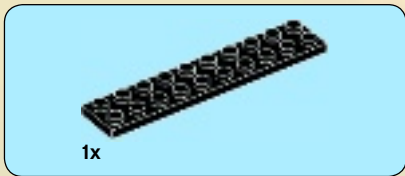
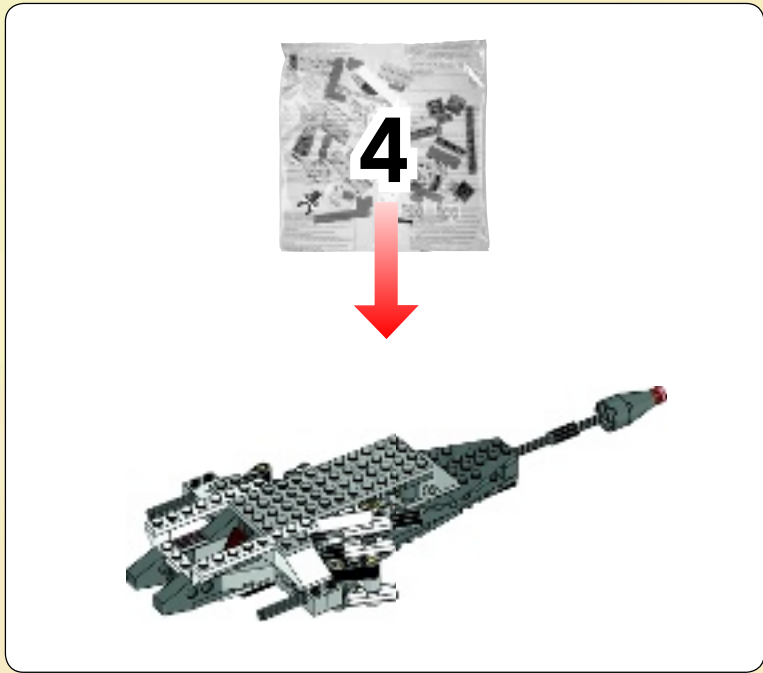

1



2 IN 1
2 EN 1
2 EN 1

JAY ZX + ZANE ZX INCLUDED
JAY ZX + ZANE ZX INCLUS
INCLUYE A JAY ZX Y A ZANE ZX

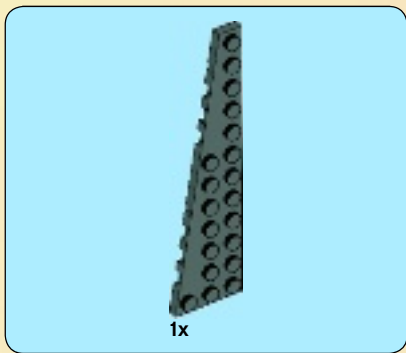

2

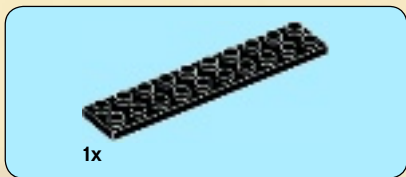
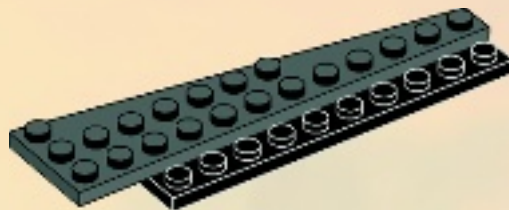

3

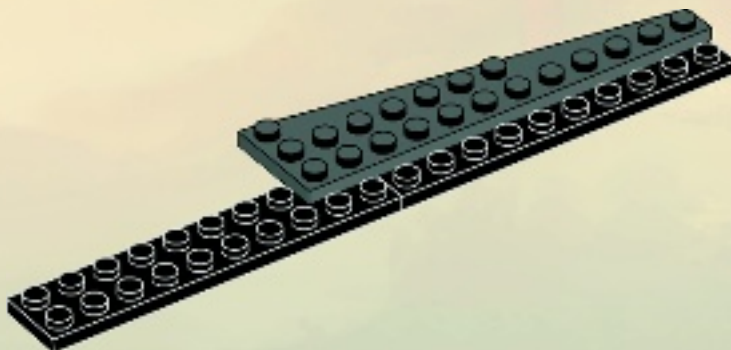

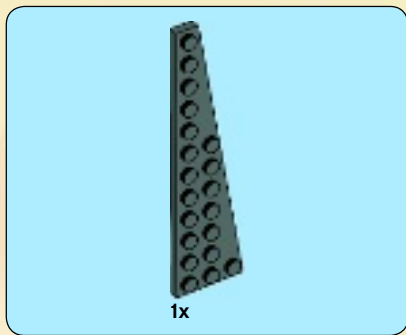

4

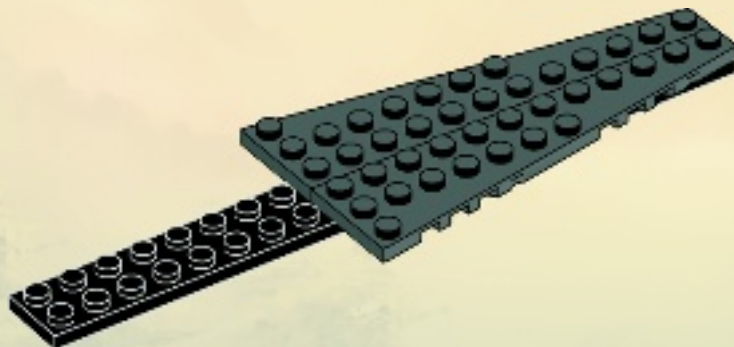

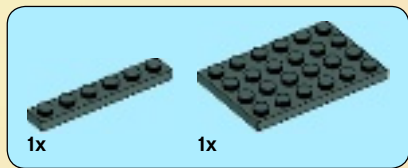

5

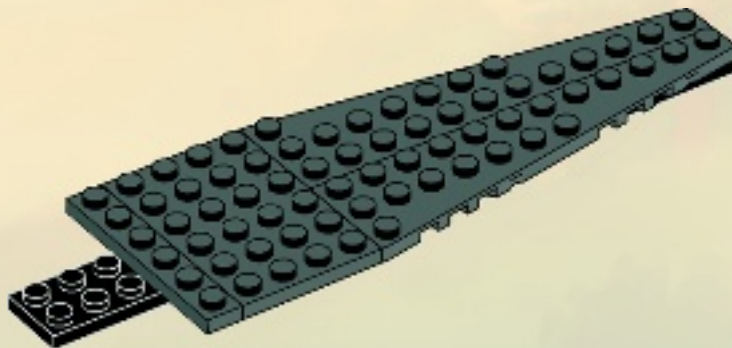



3x

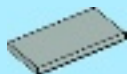

2x

6

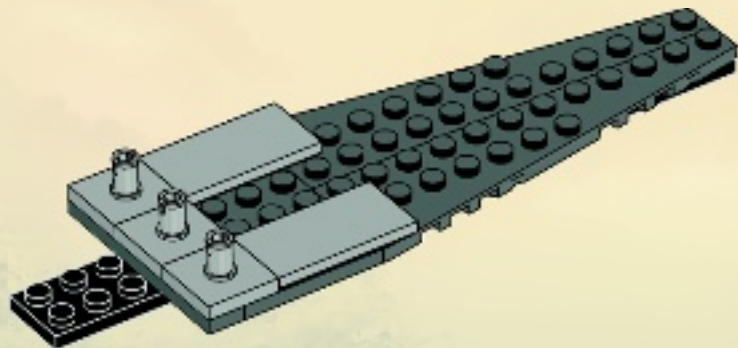

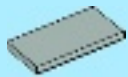

2x

7

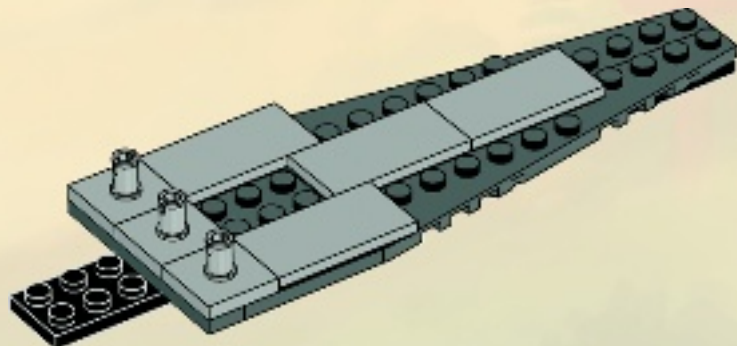



2x

8

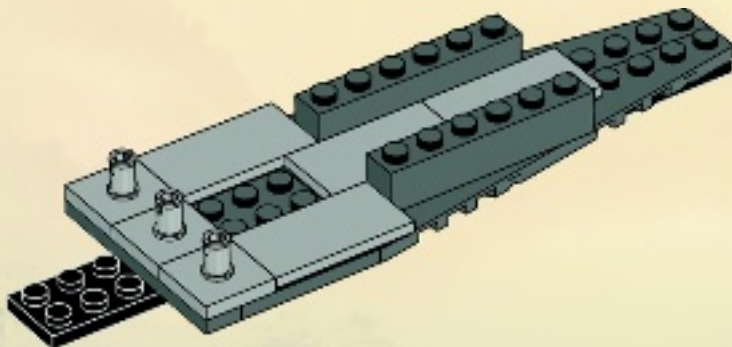

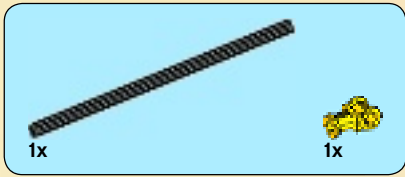
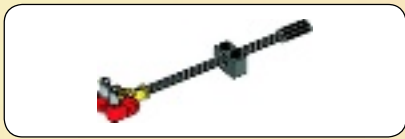

1

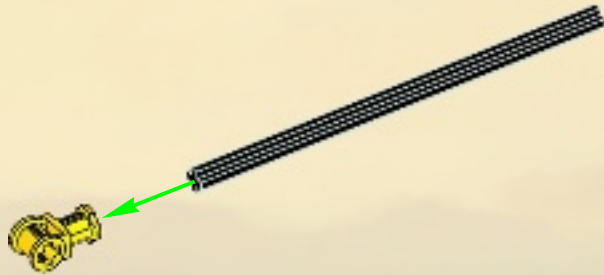

2

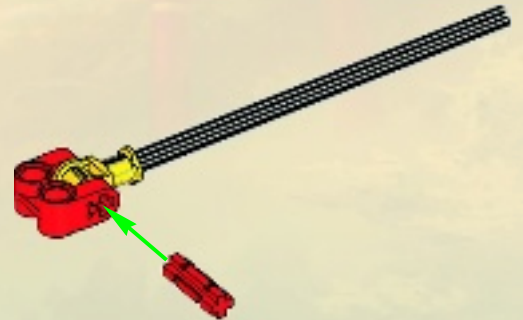



2x

3



1x



1x

4

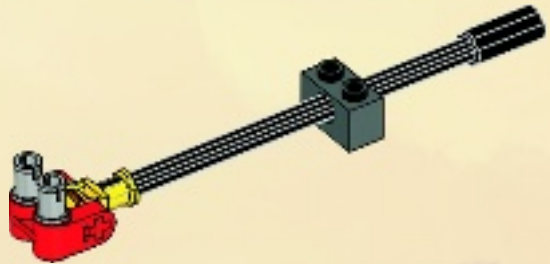

9

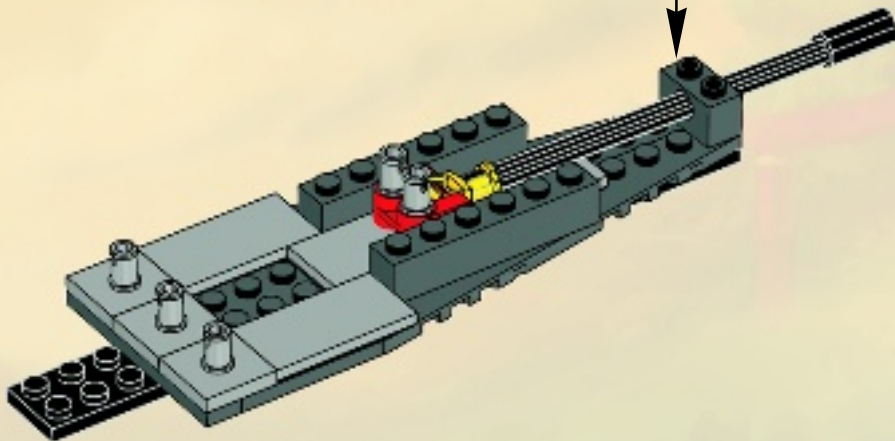

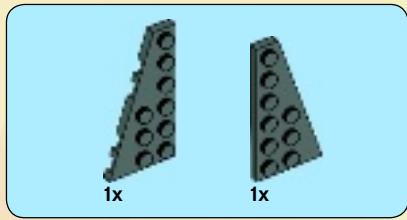

10

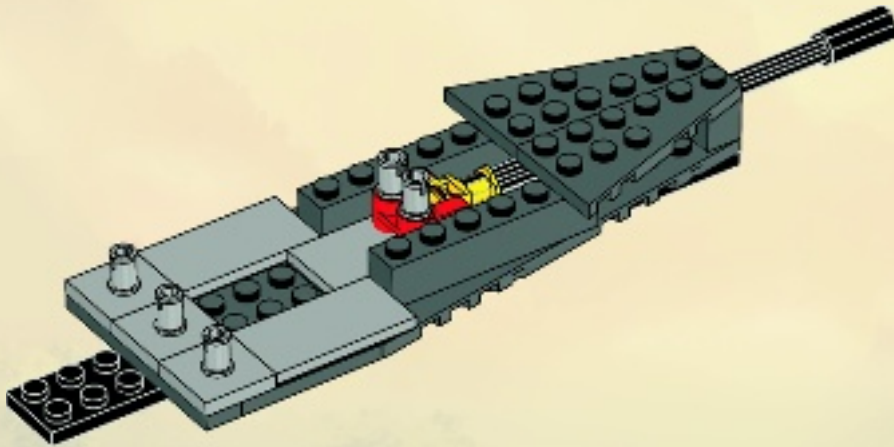



1x



1x

11

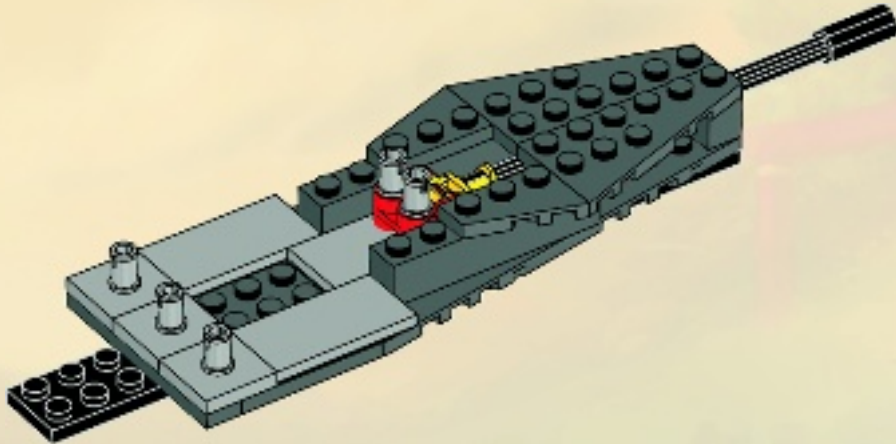

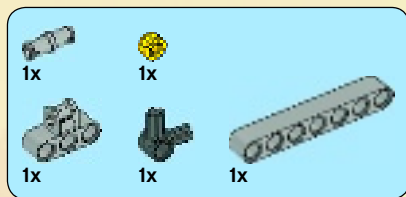

12

1

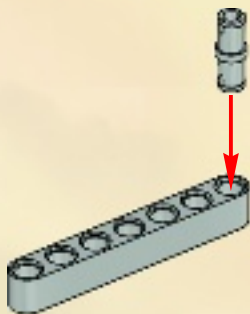

2

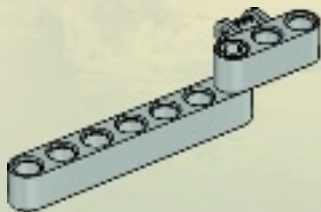

3

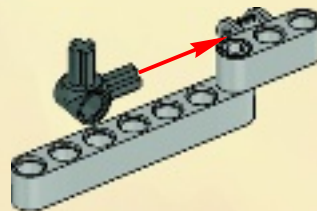

4

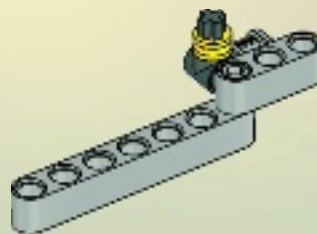

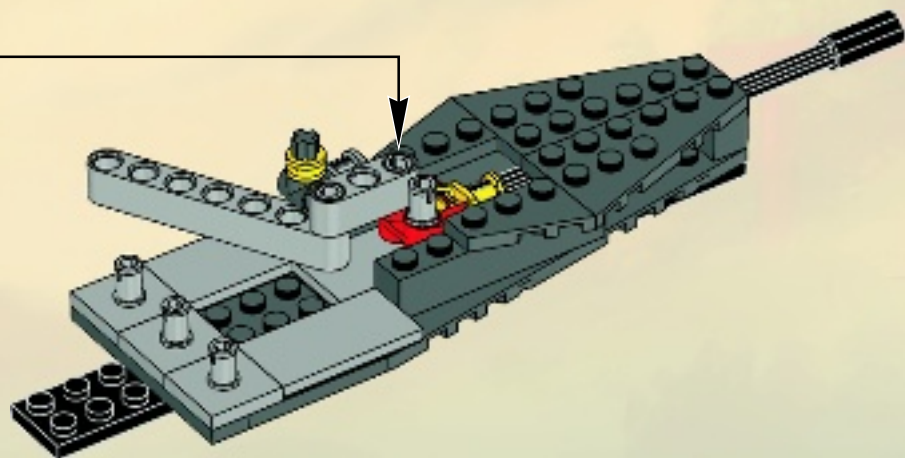

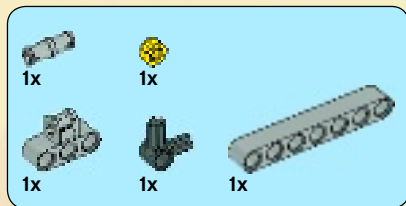

13

1

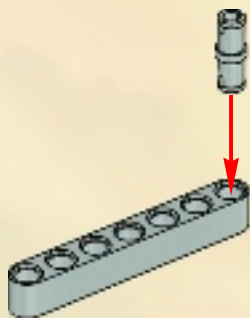

2

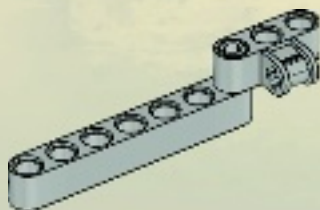

3

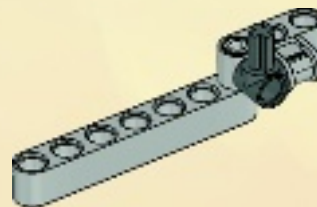

4

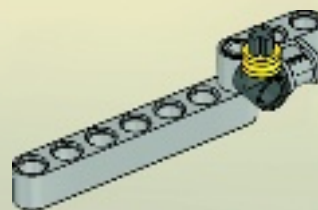

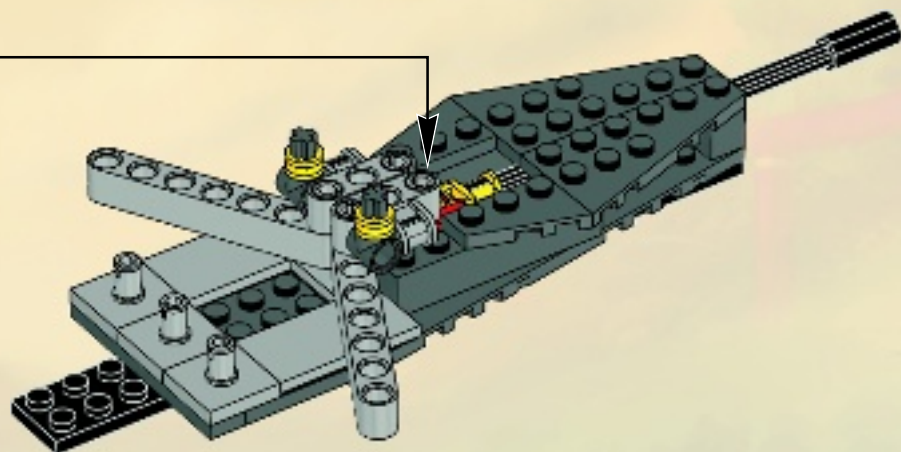



1x

14

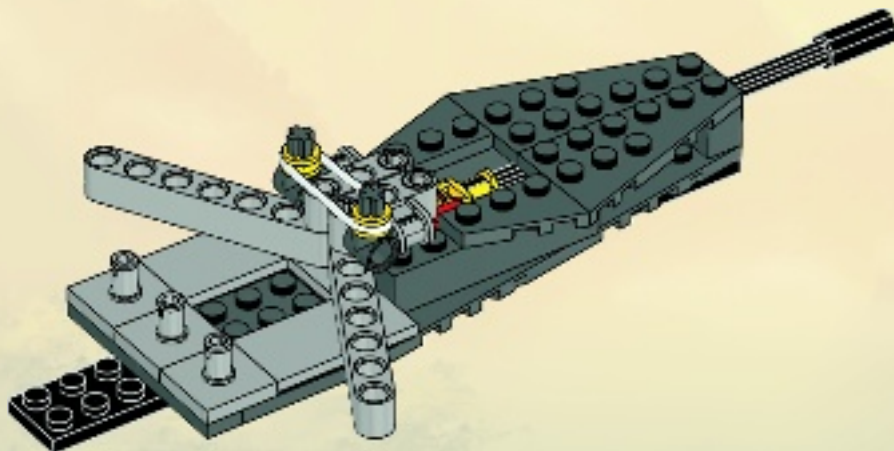

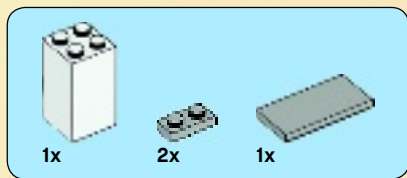

15

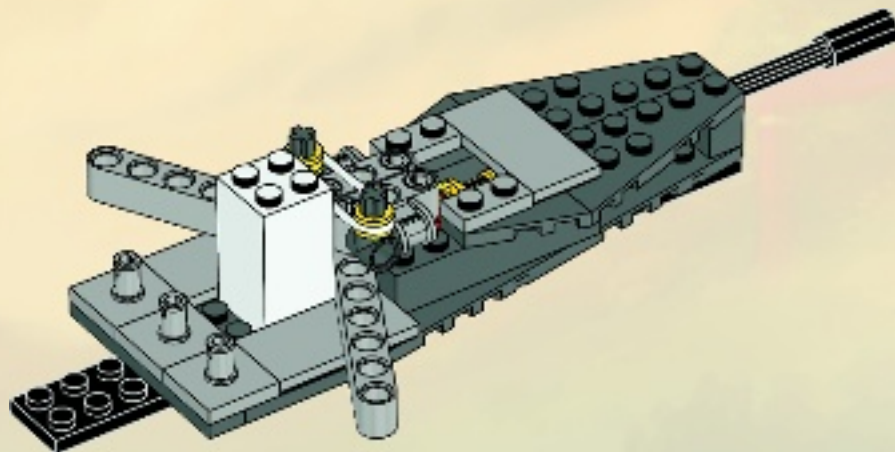



1x

16

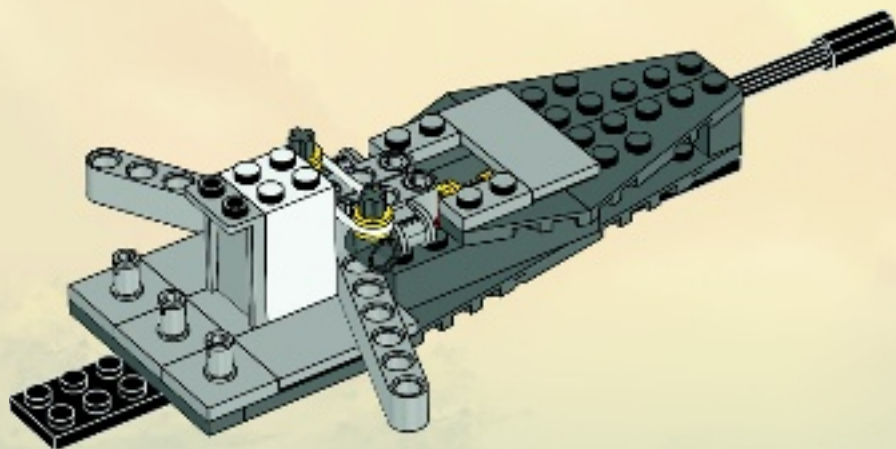

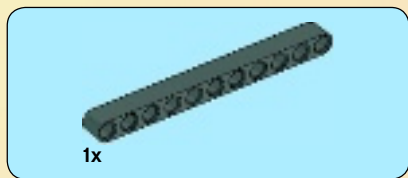

17

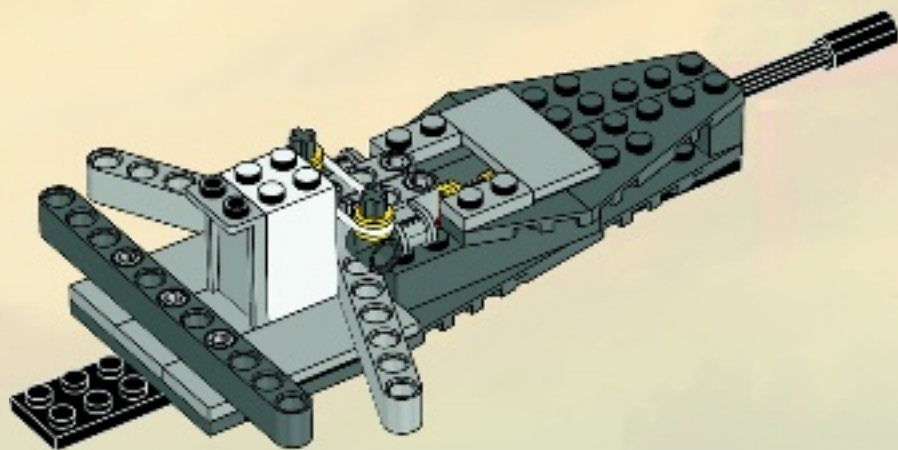



4x

18

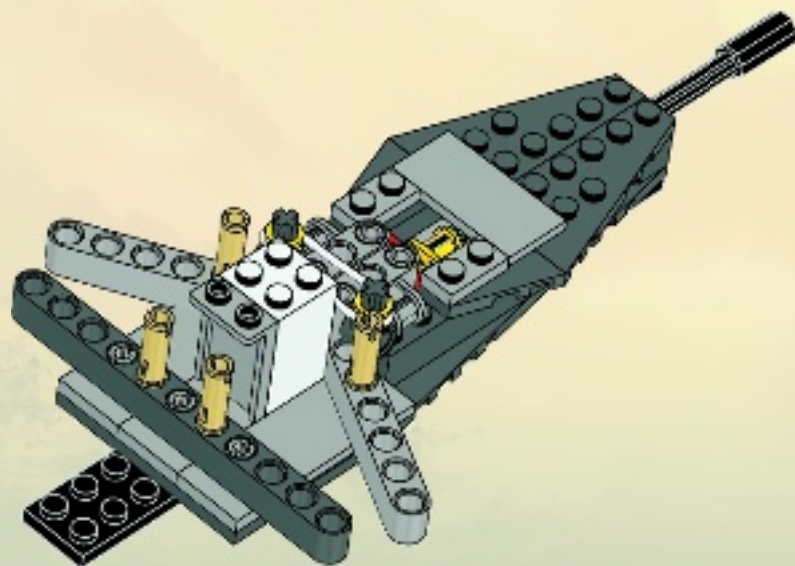

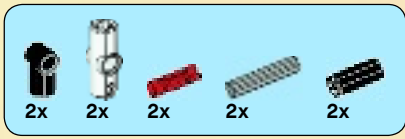

19

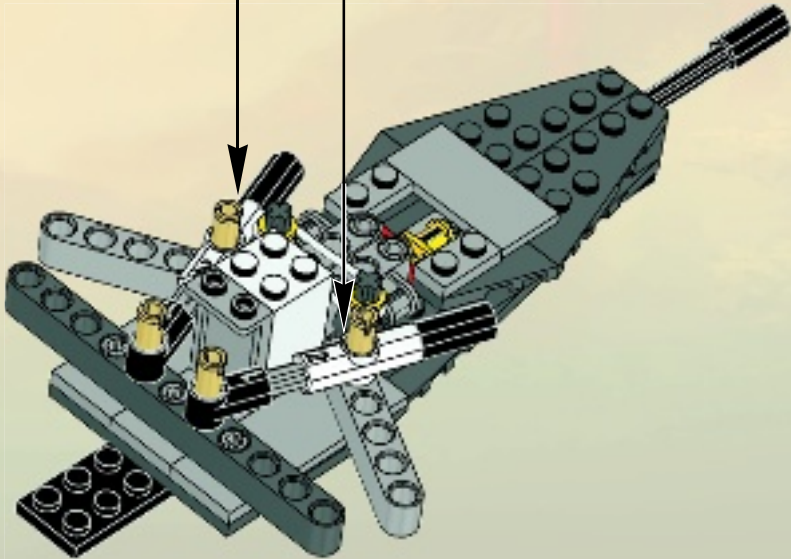
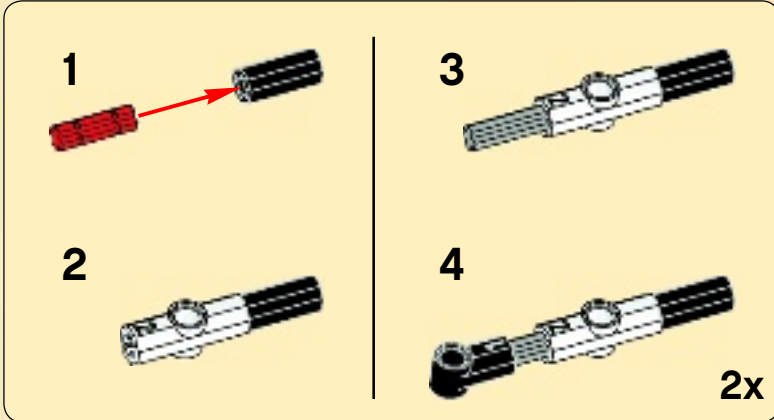



4x

20

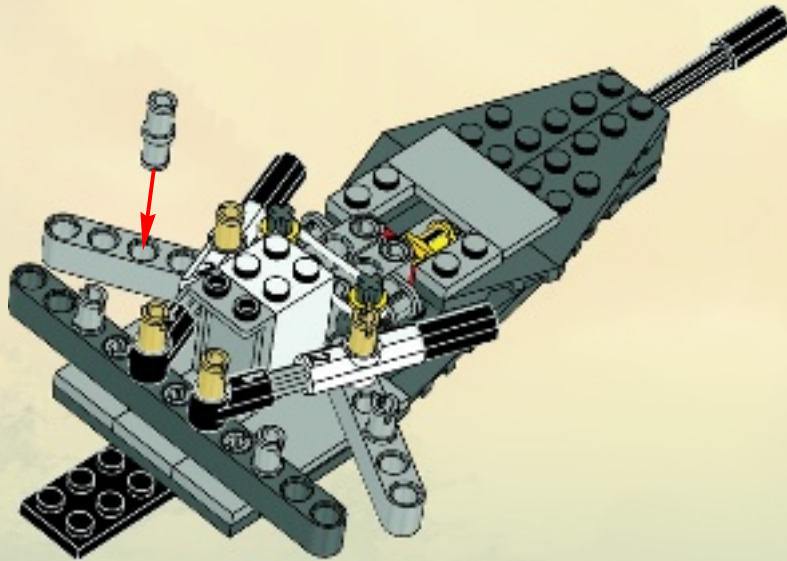

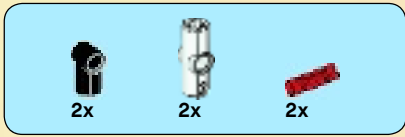

21

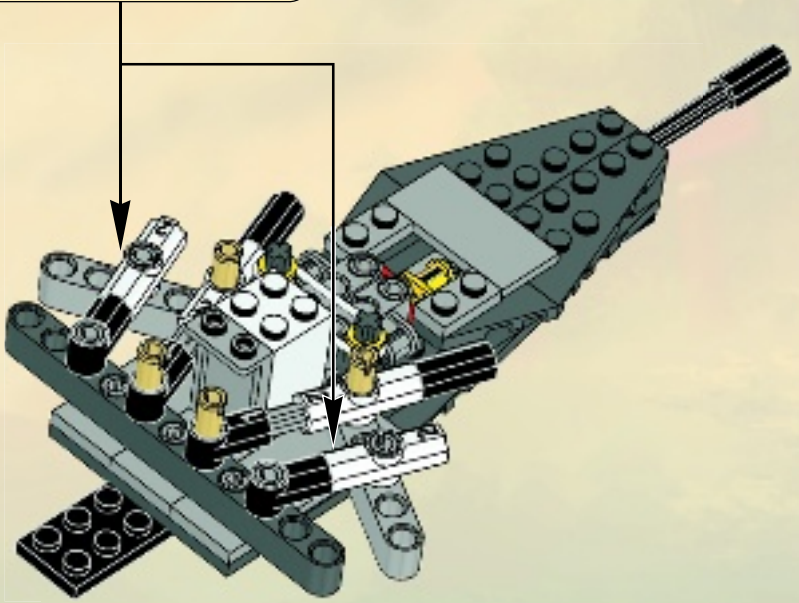
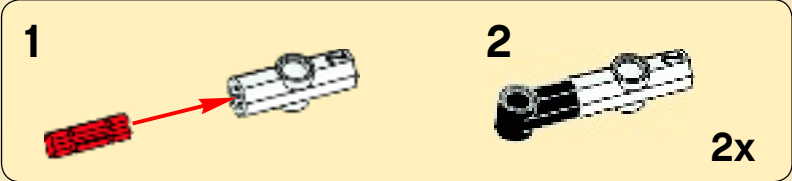



2x

22

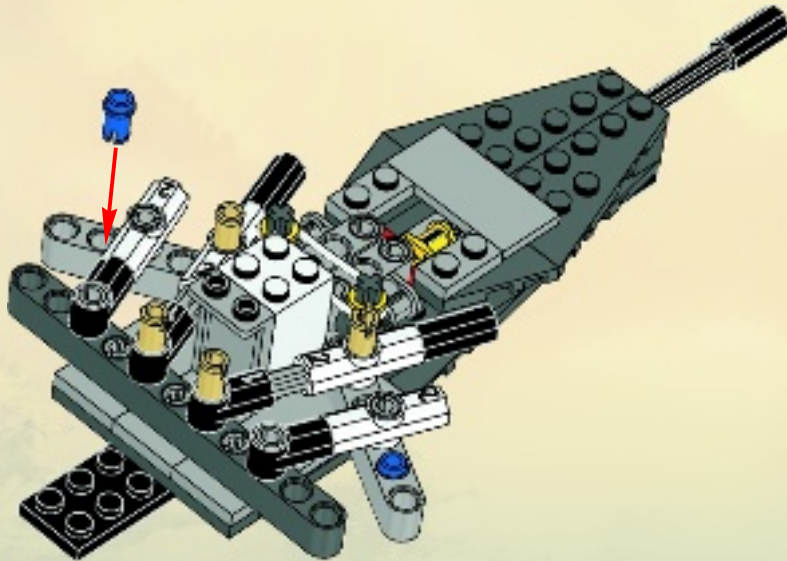



4x

23

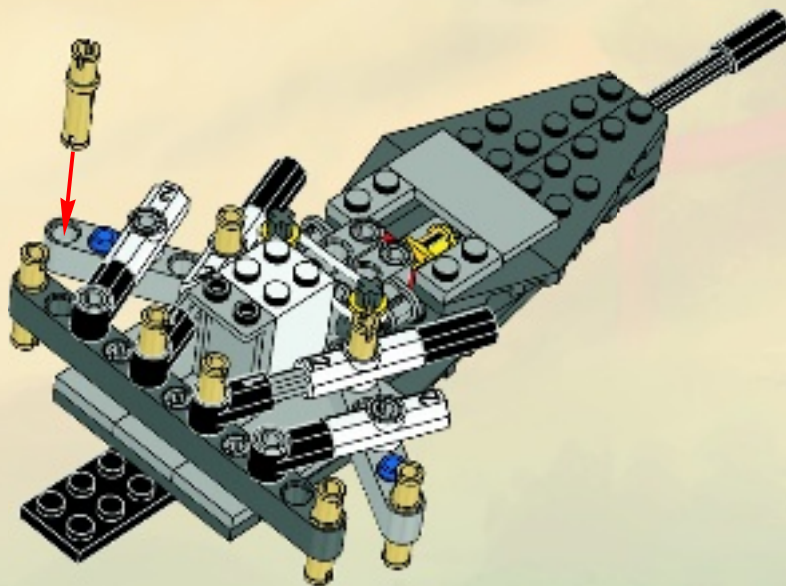



2x

24

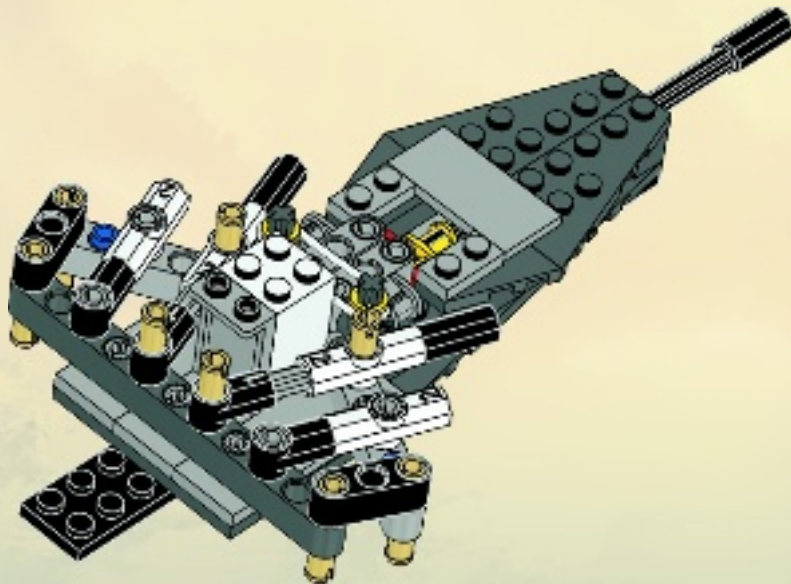



2x

25

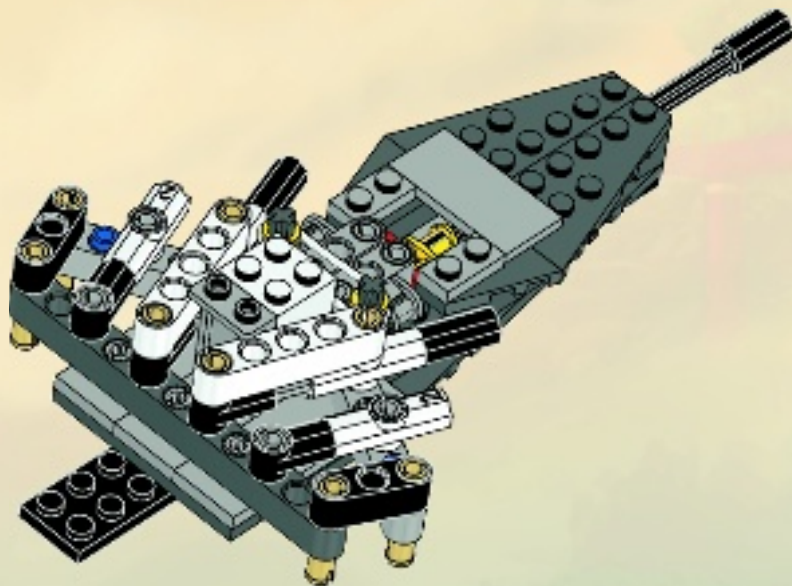



2x



2x

26

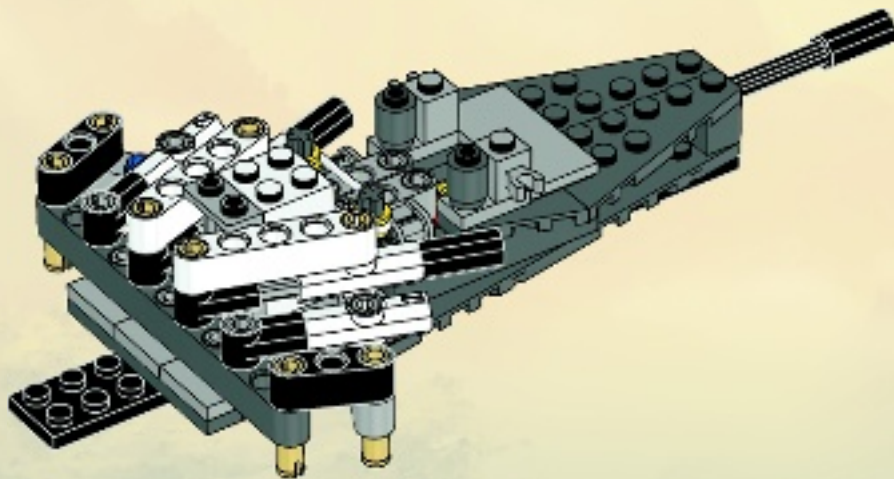



1x

27

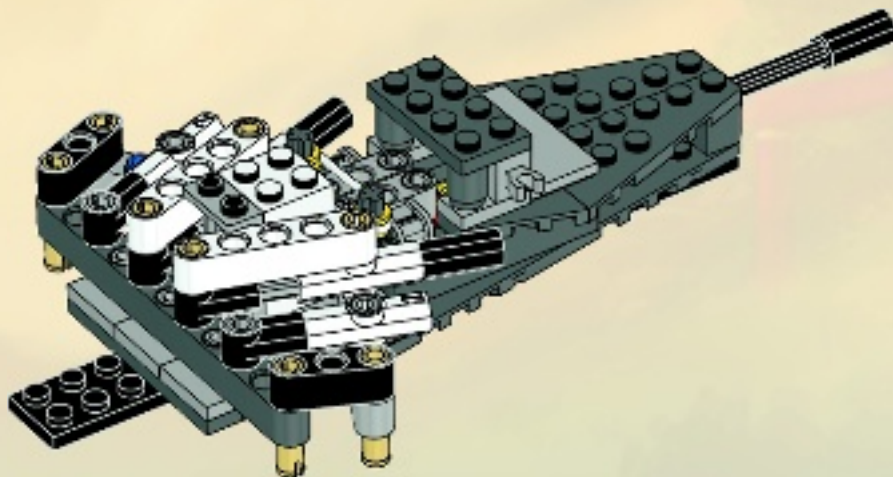

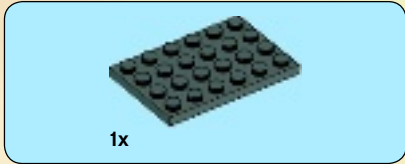

1

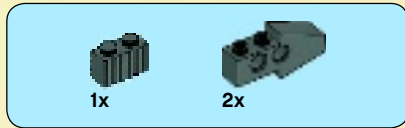

2

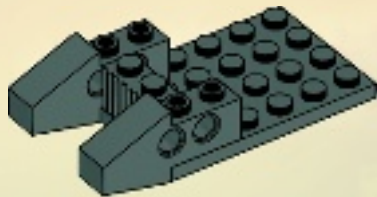

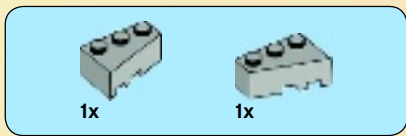

3

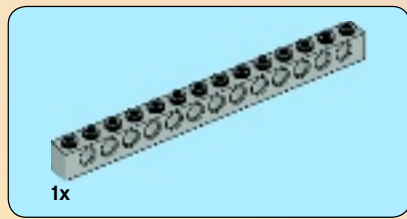
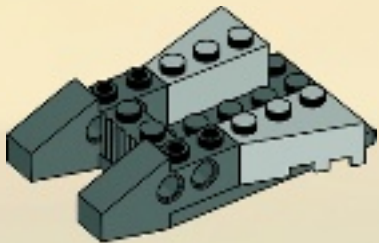

4

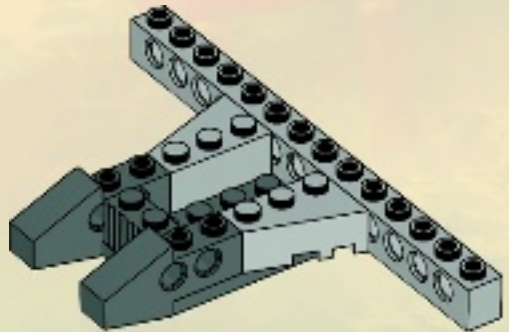

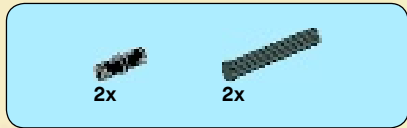

5

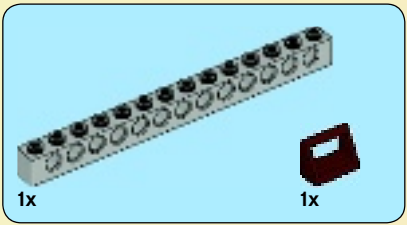
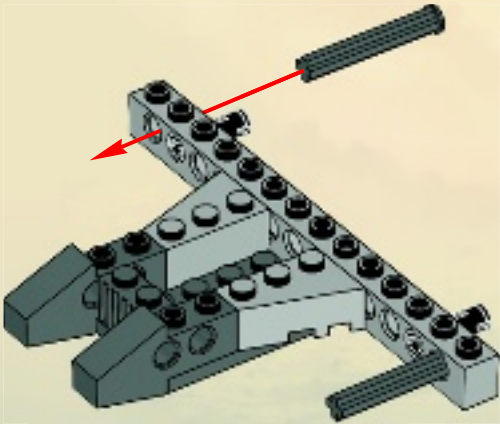

6

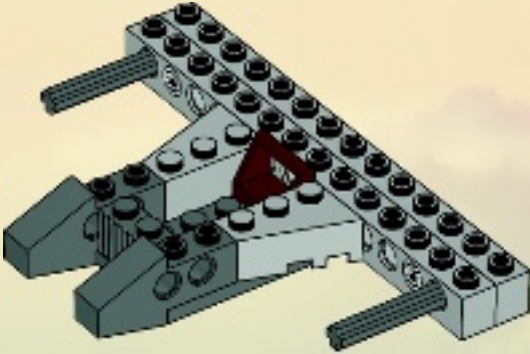

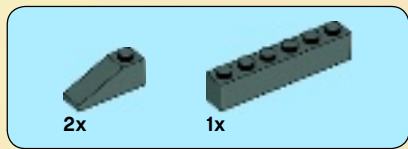

7

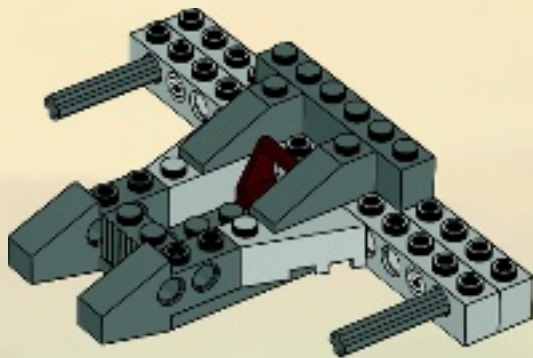

8

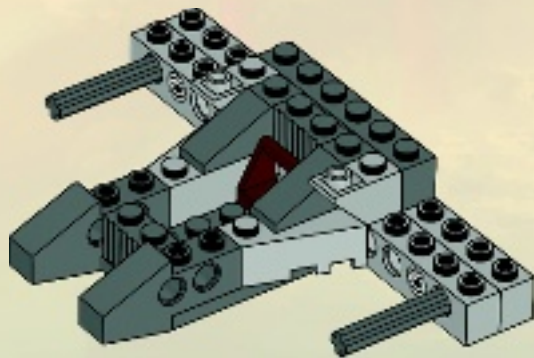

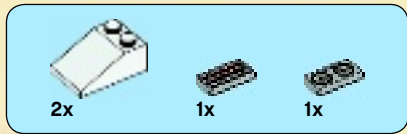

9

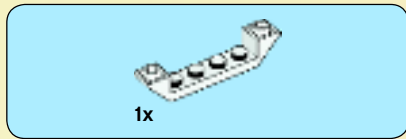
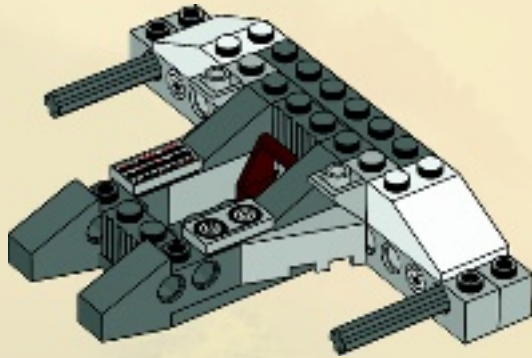

10

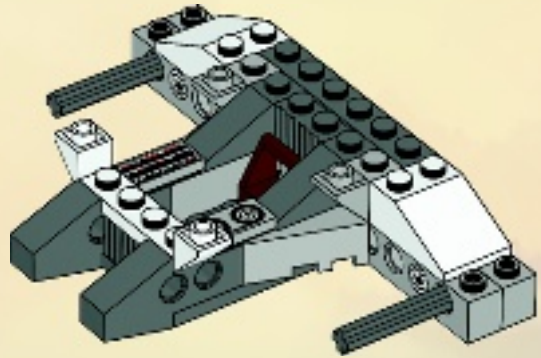

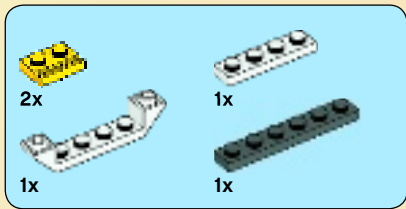

11

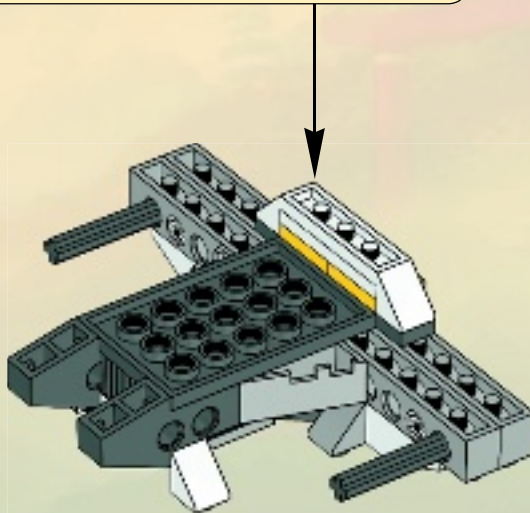
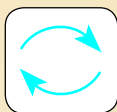
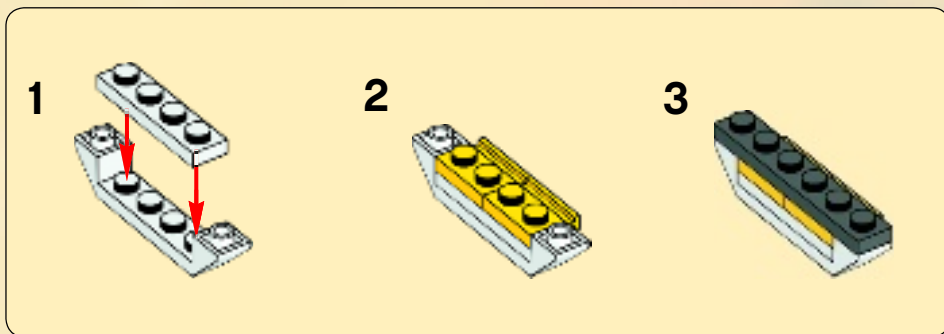



1x

12

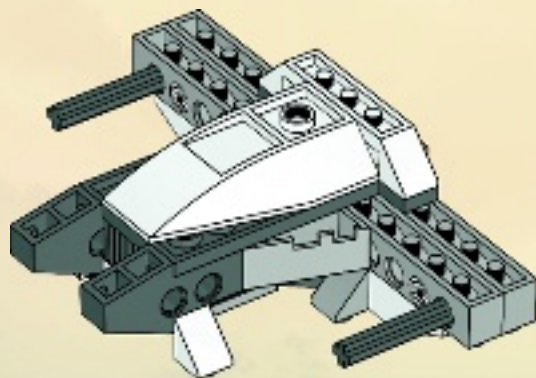

28

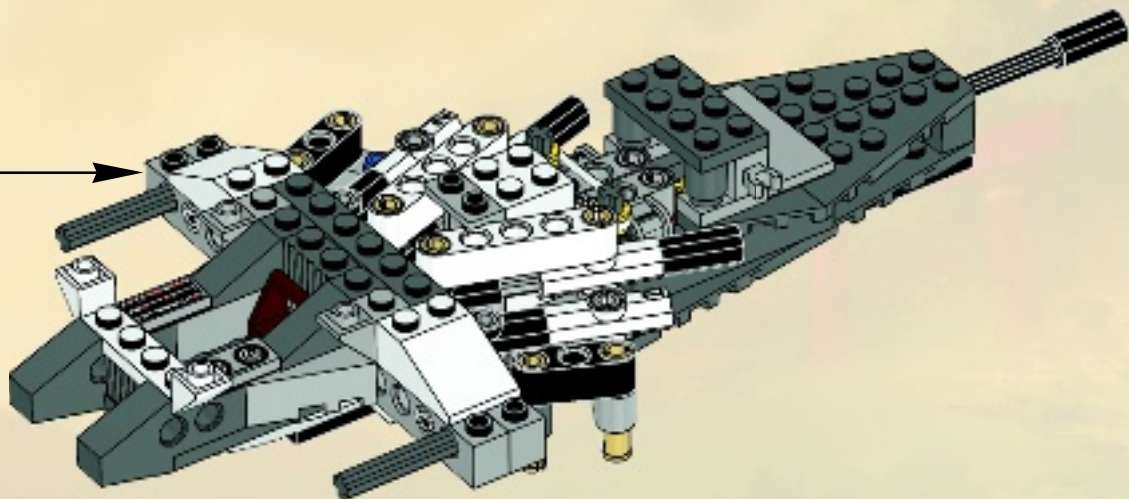

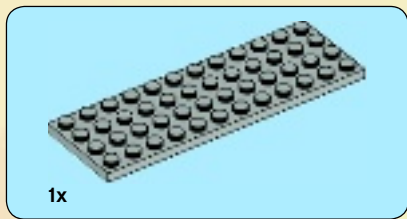

29

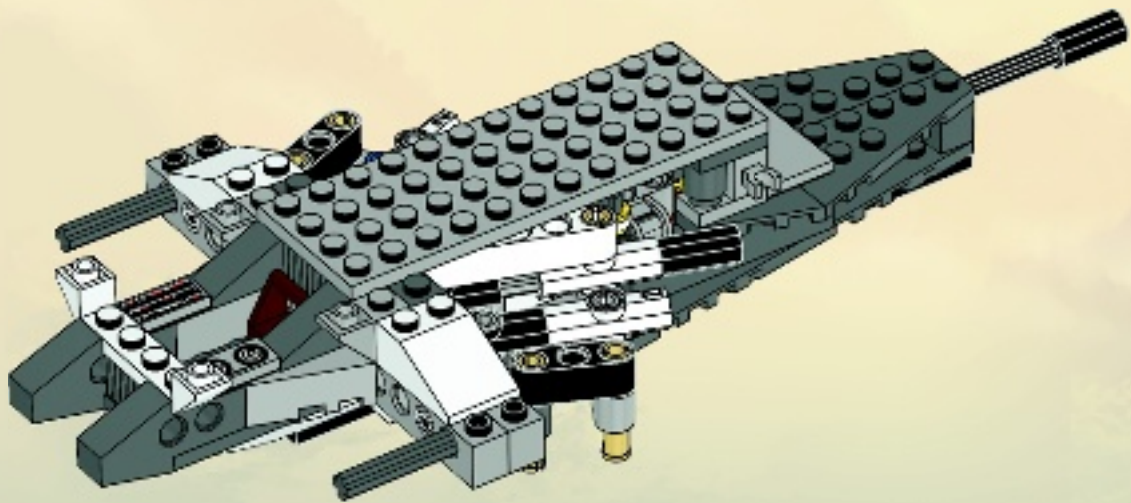

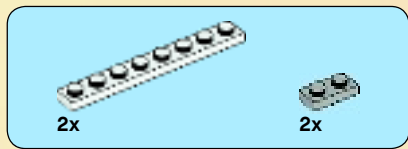

30

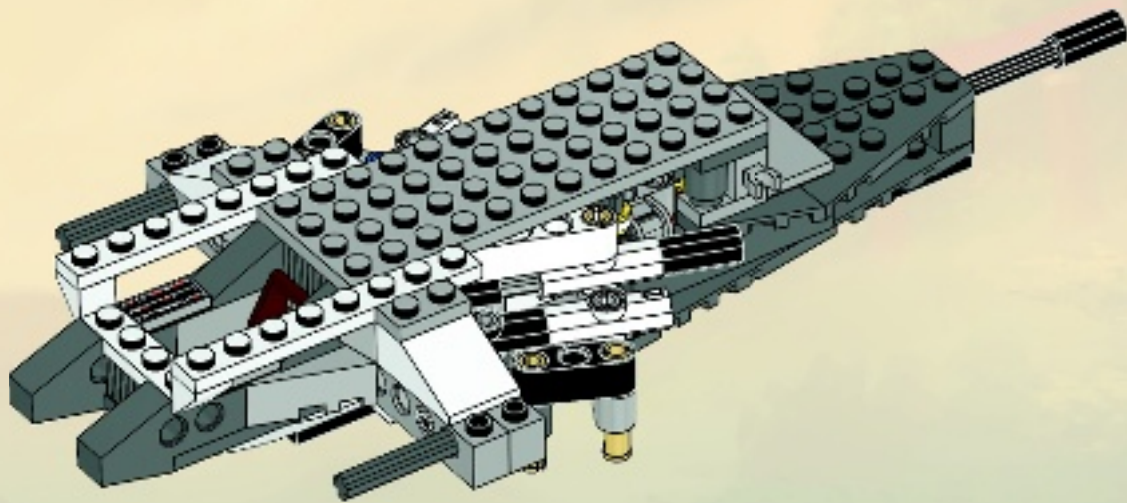

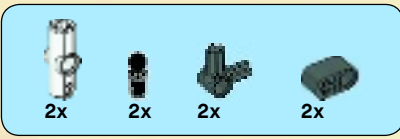

31

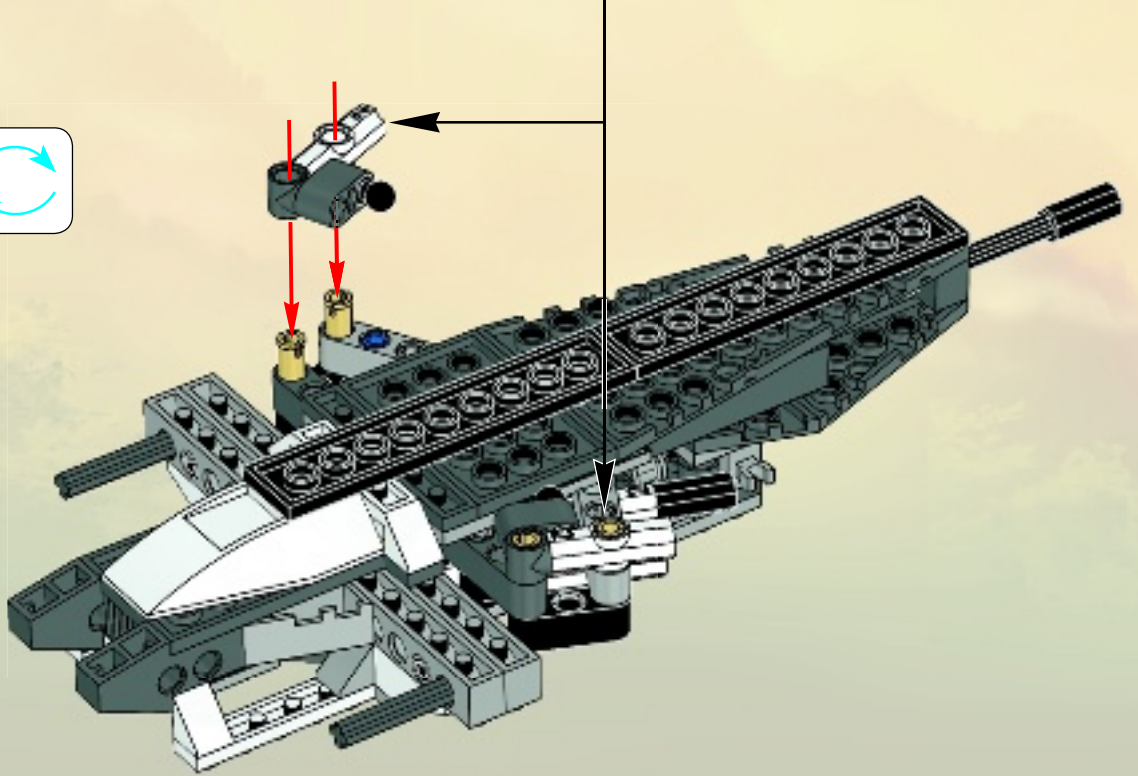
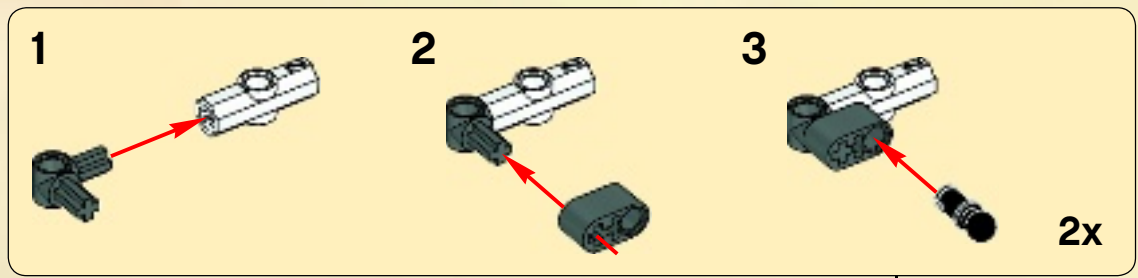



32

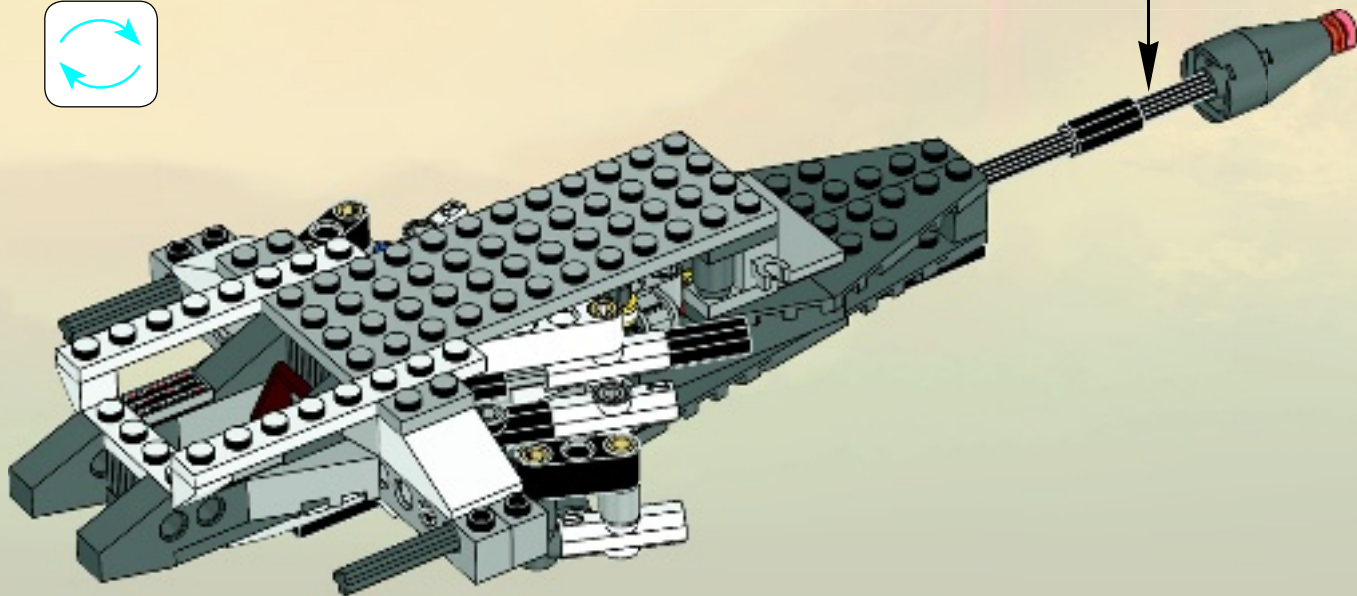
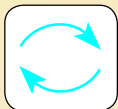

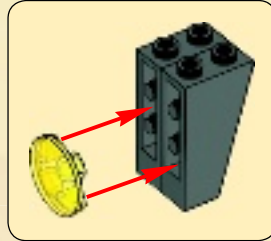
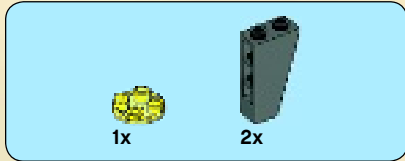

33

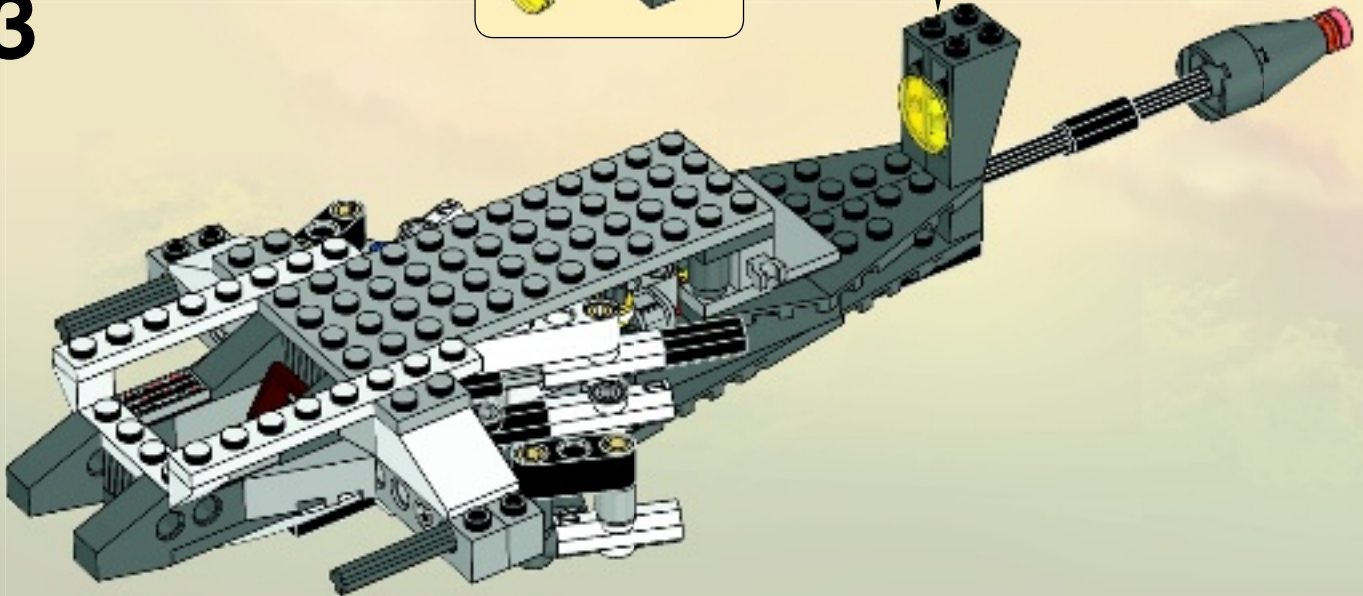

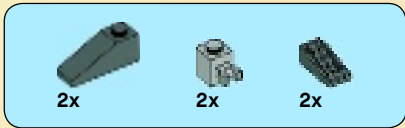

34

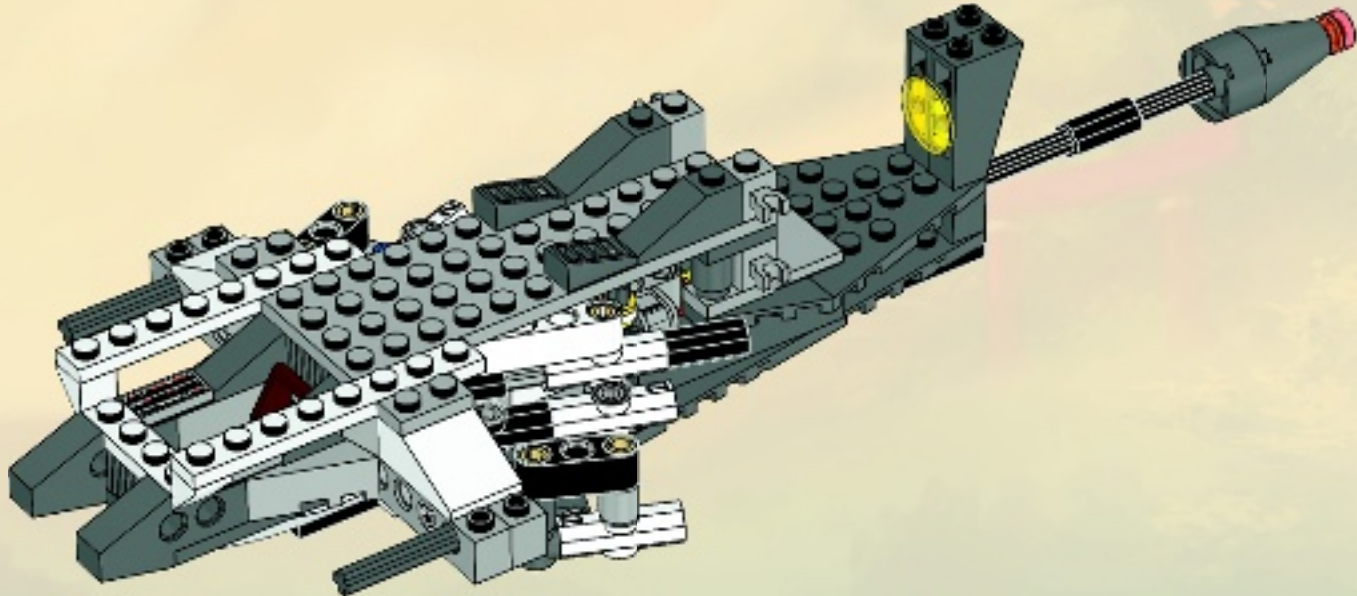

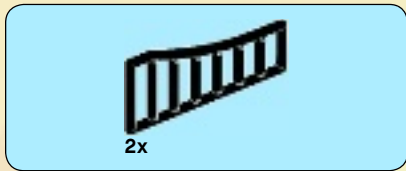

35

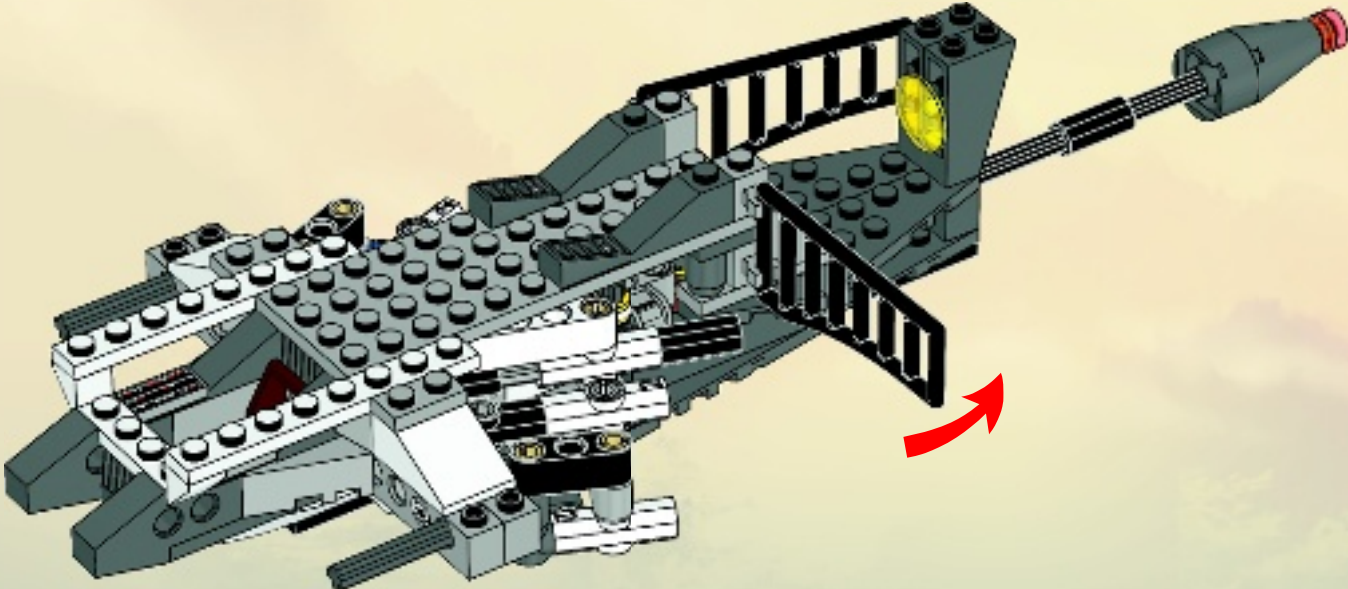

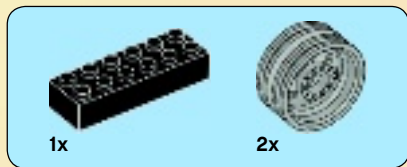

36

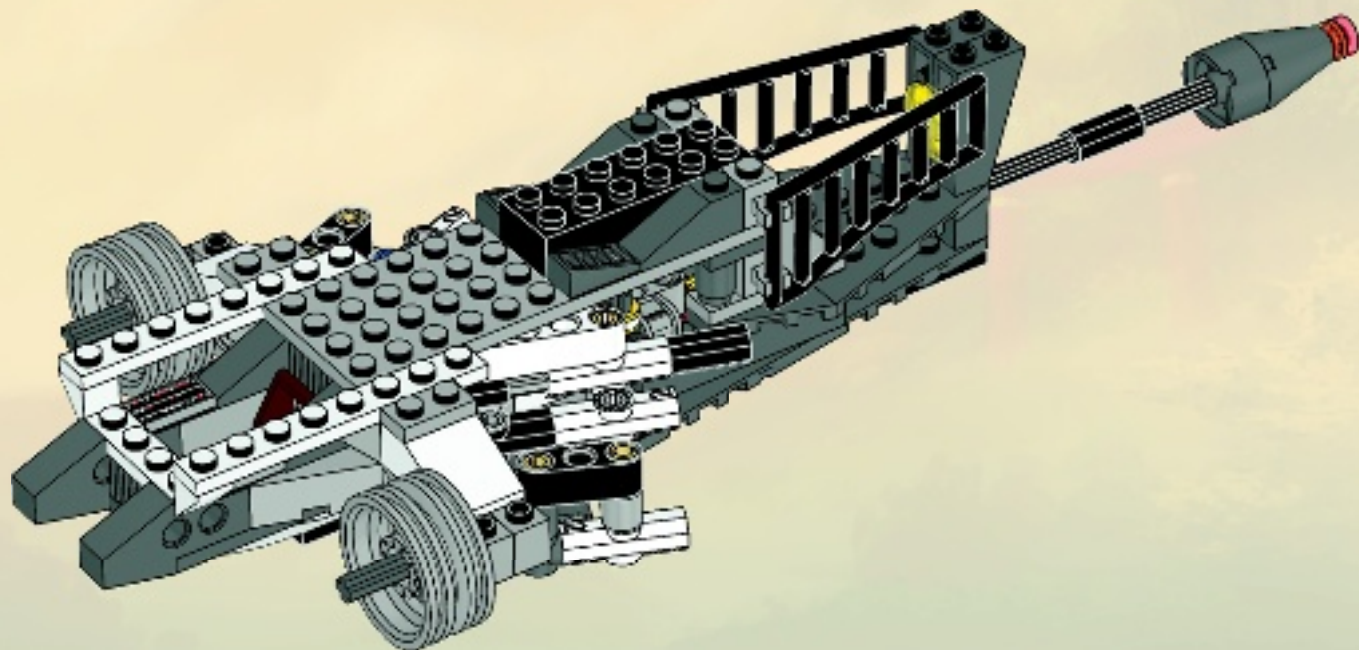



2x



2x



2x

37

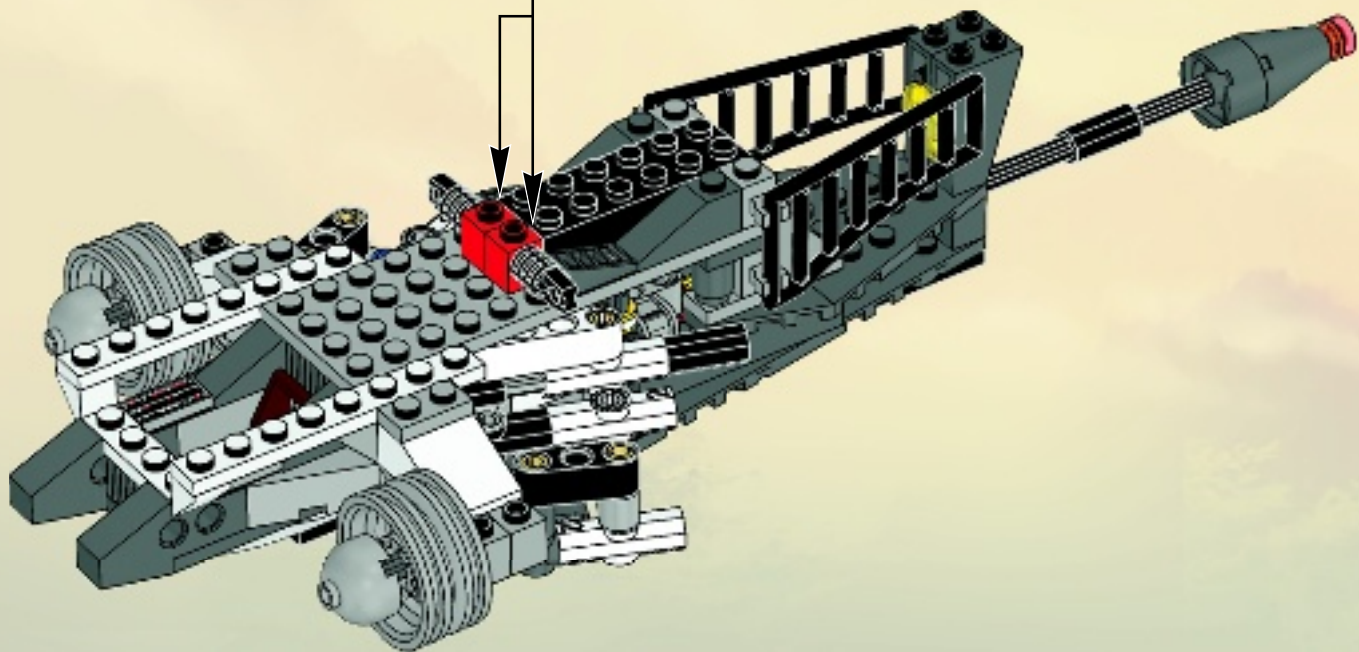
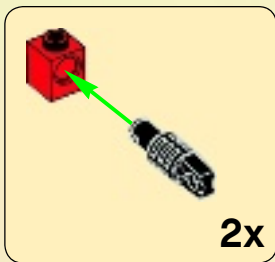

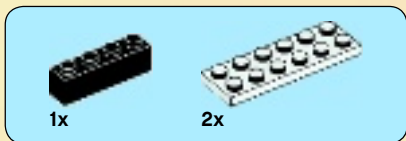

38

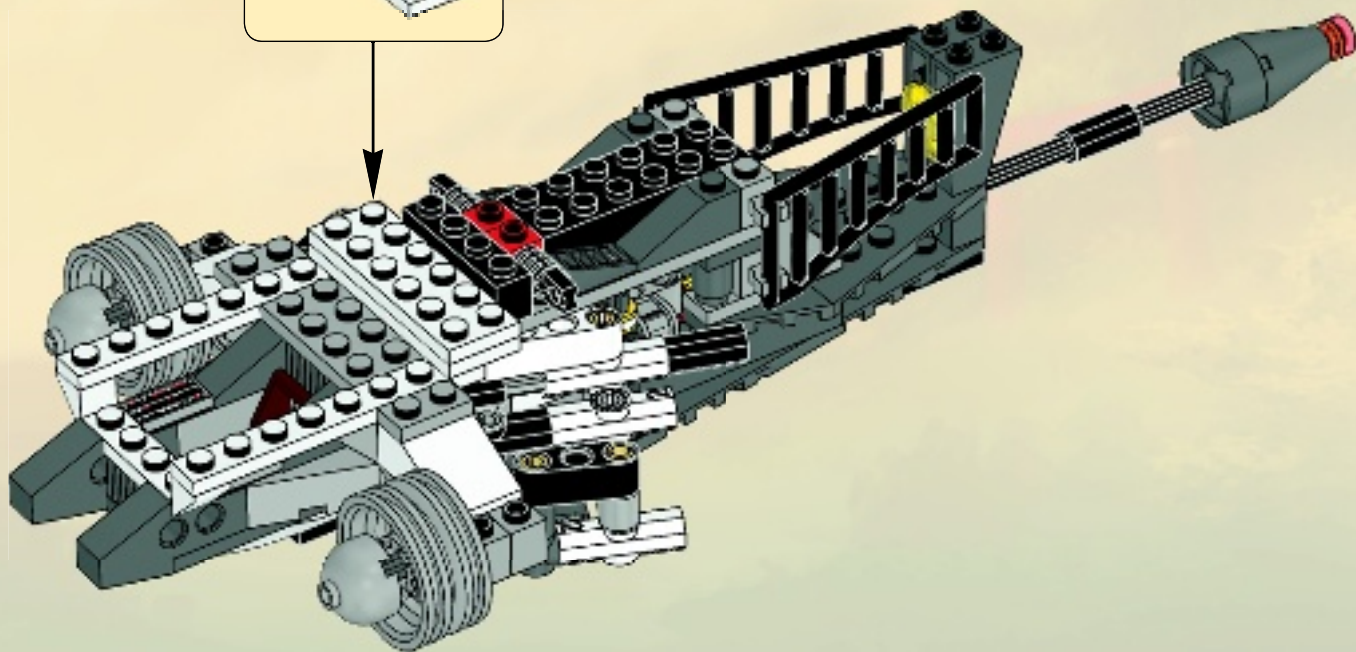
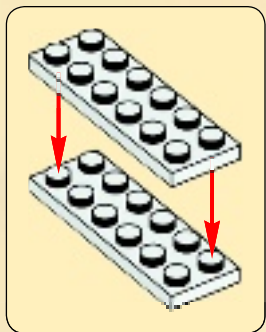



2x



2x



2x

39

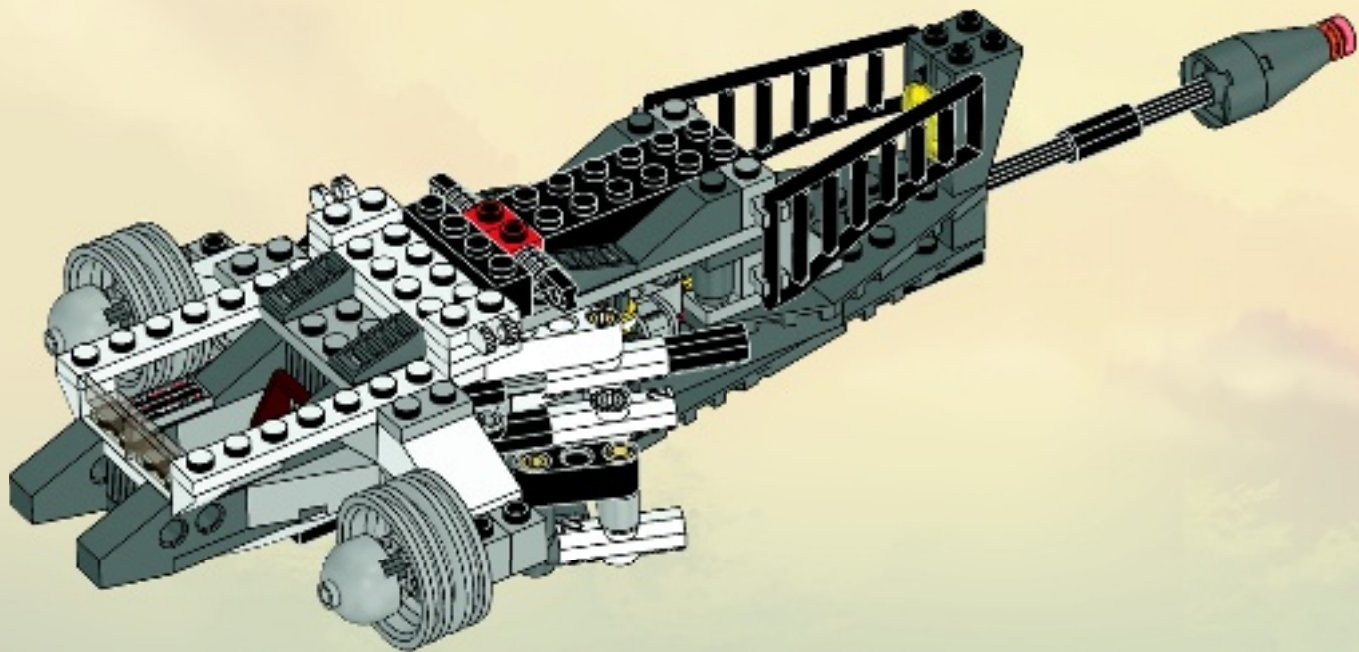

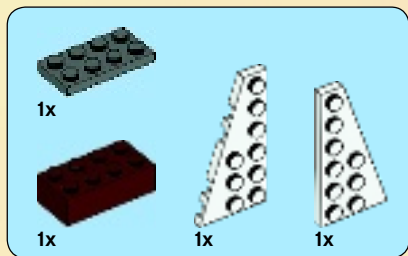

40

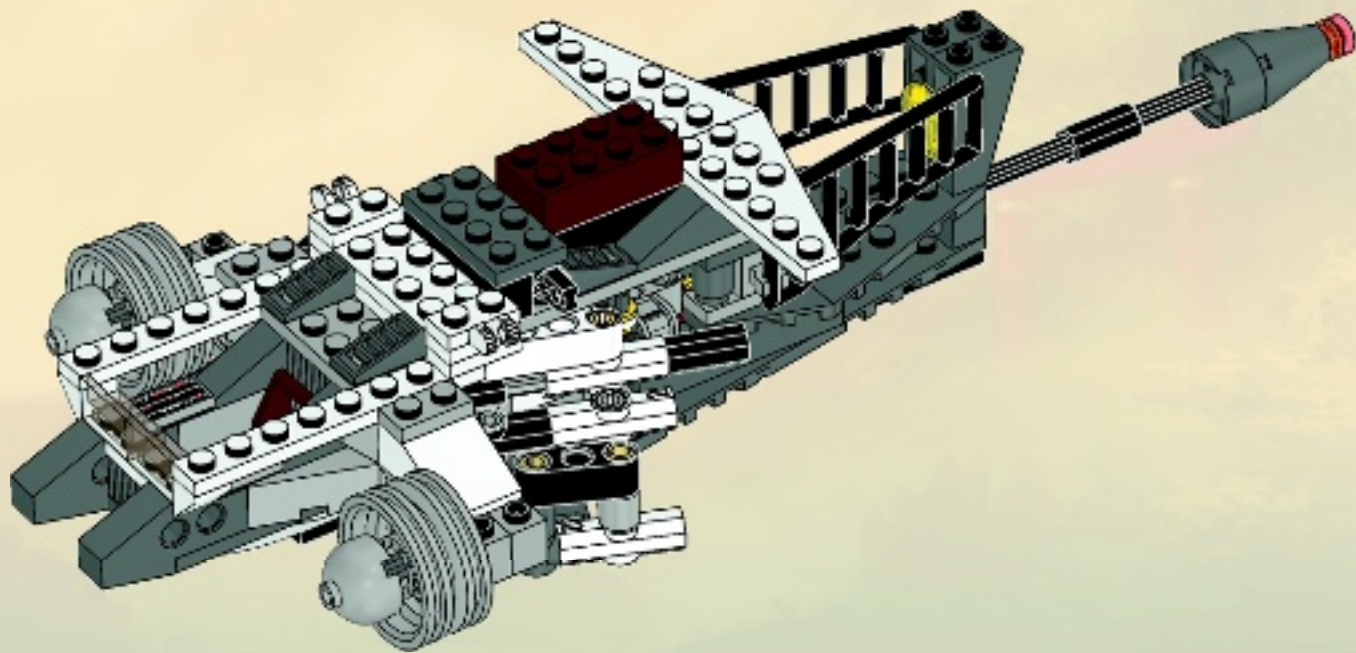



1x



1x



1x

41

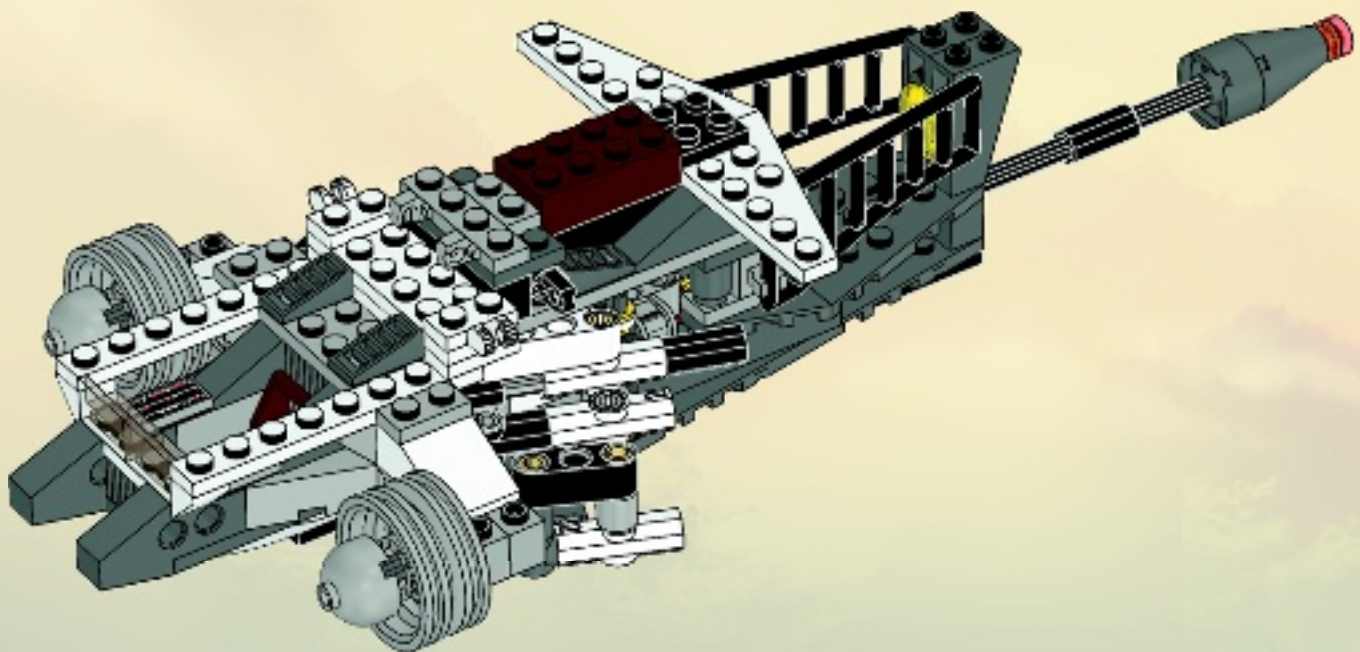

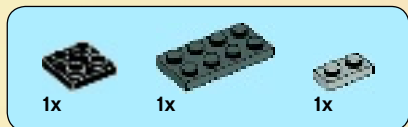

42

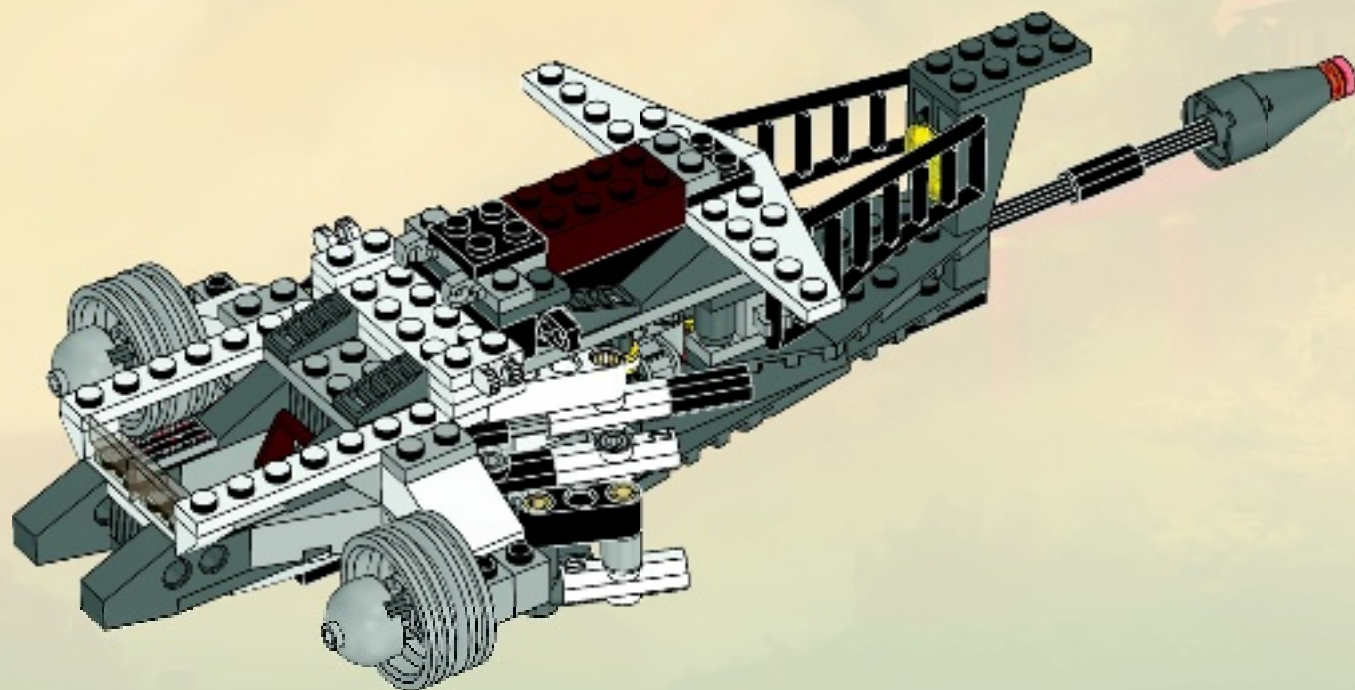

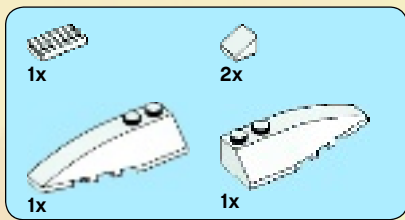

43

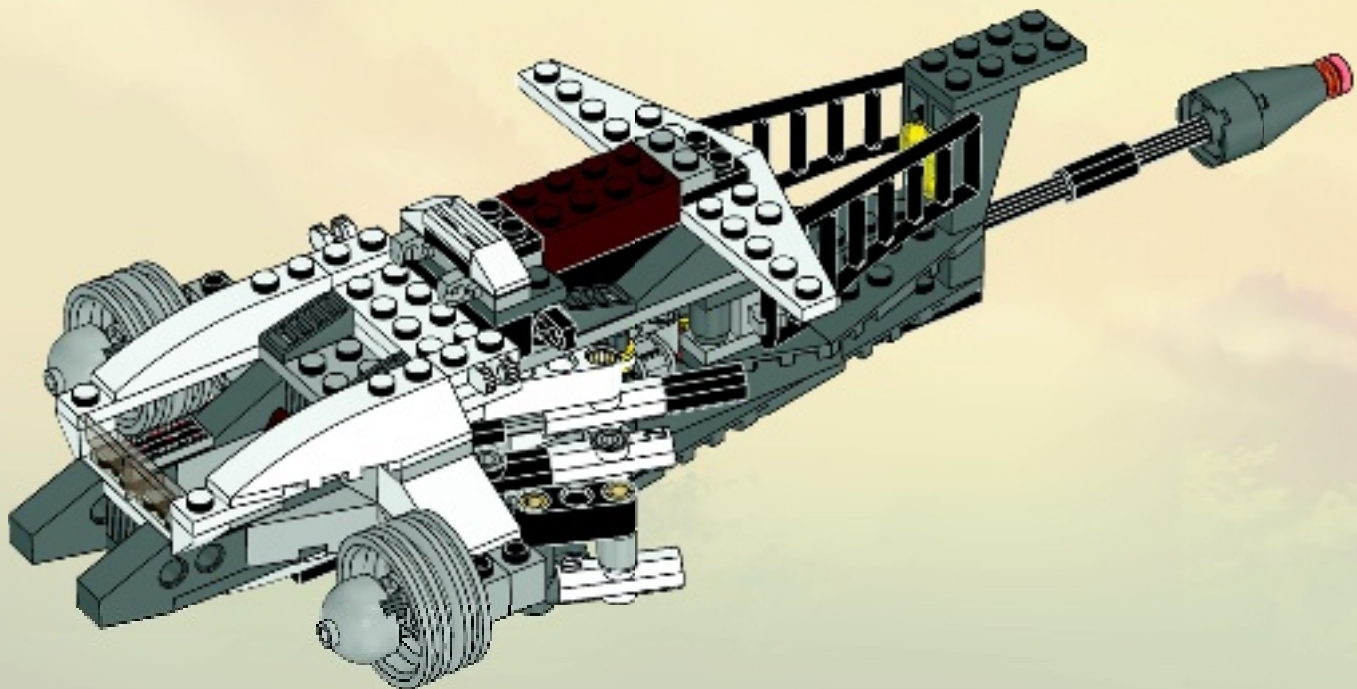

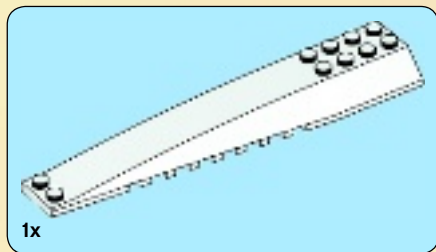

44

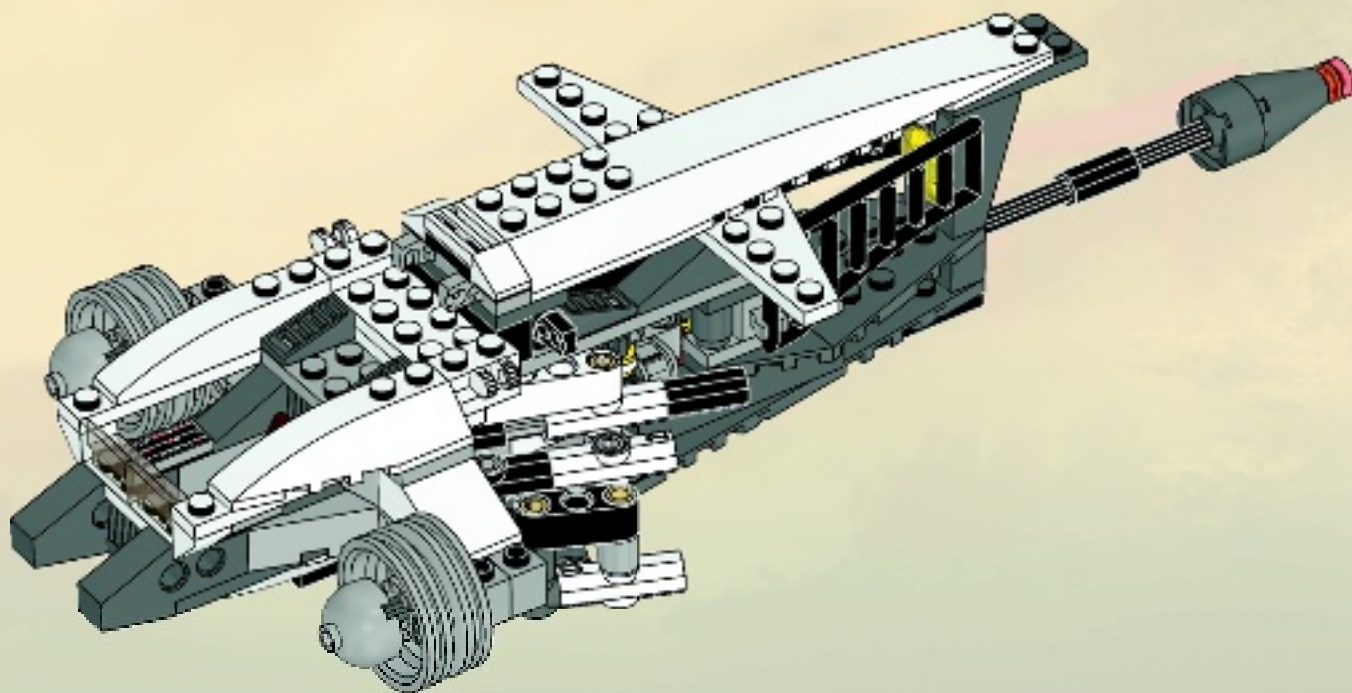



1x

45

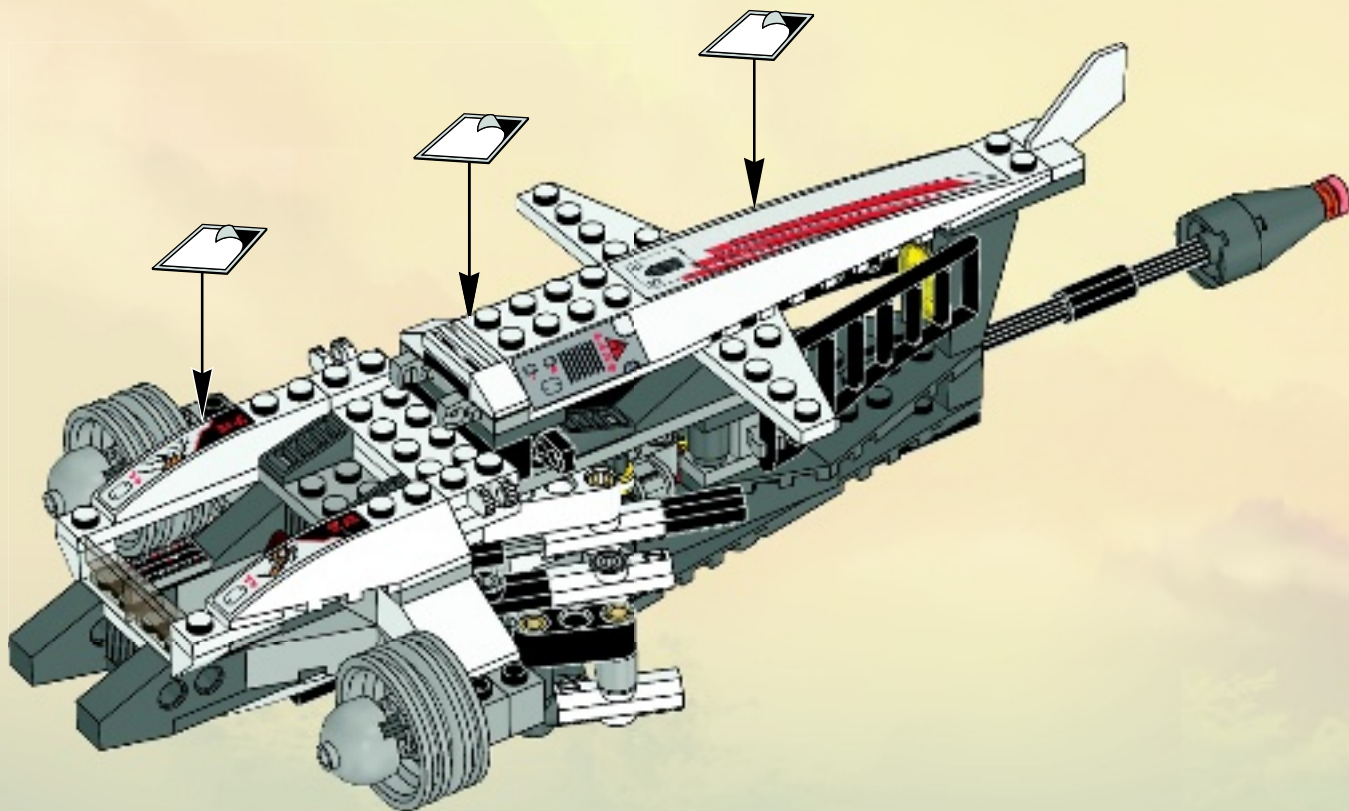

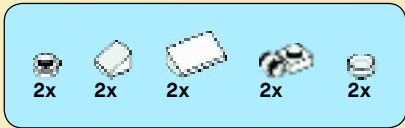

46

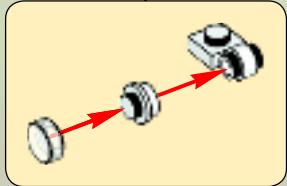
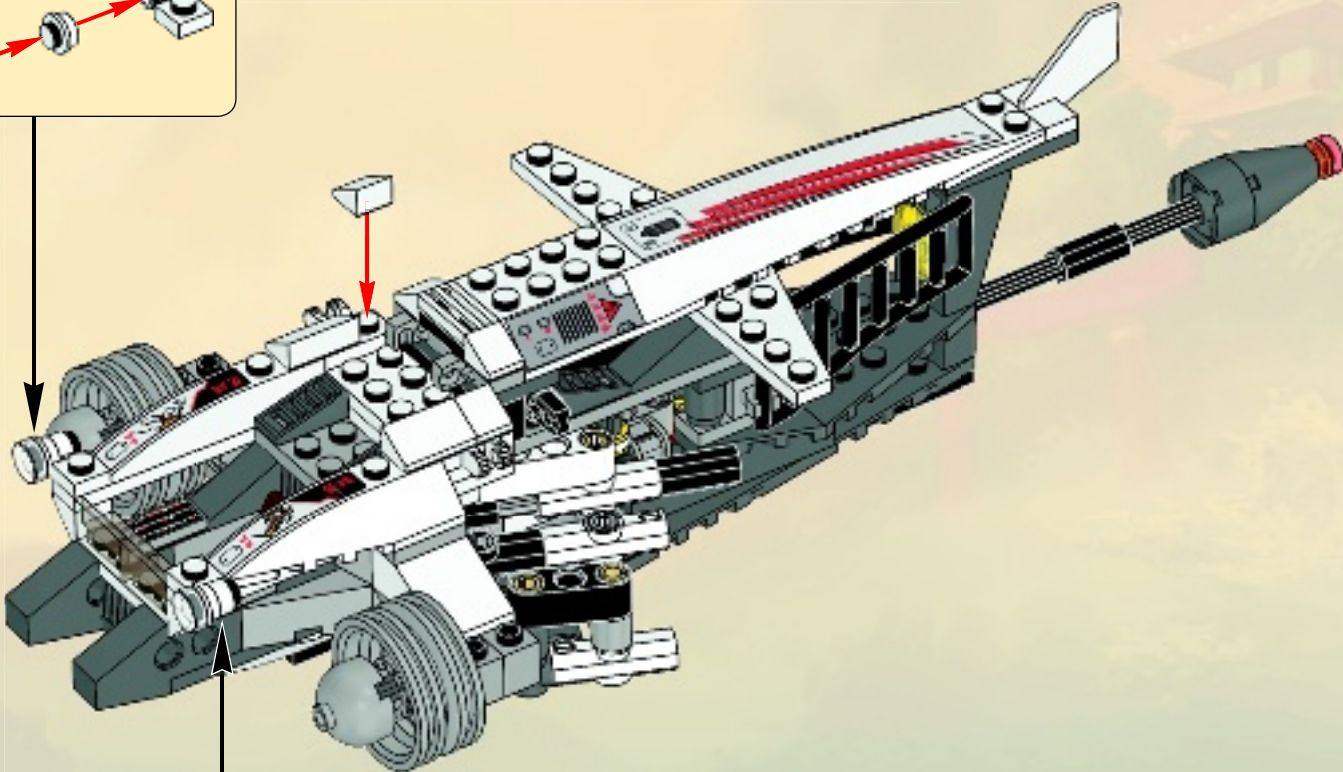
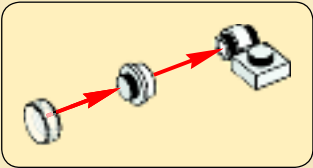

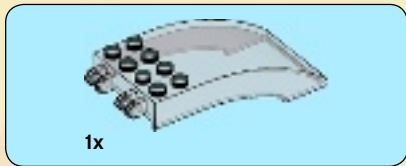

47

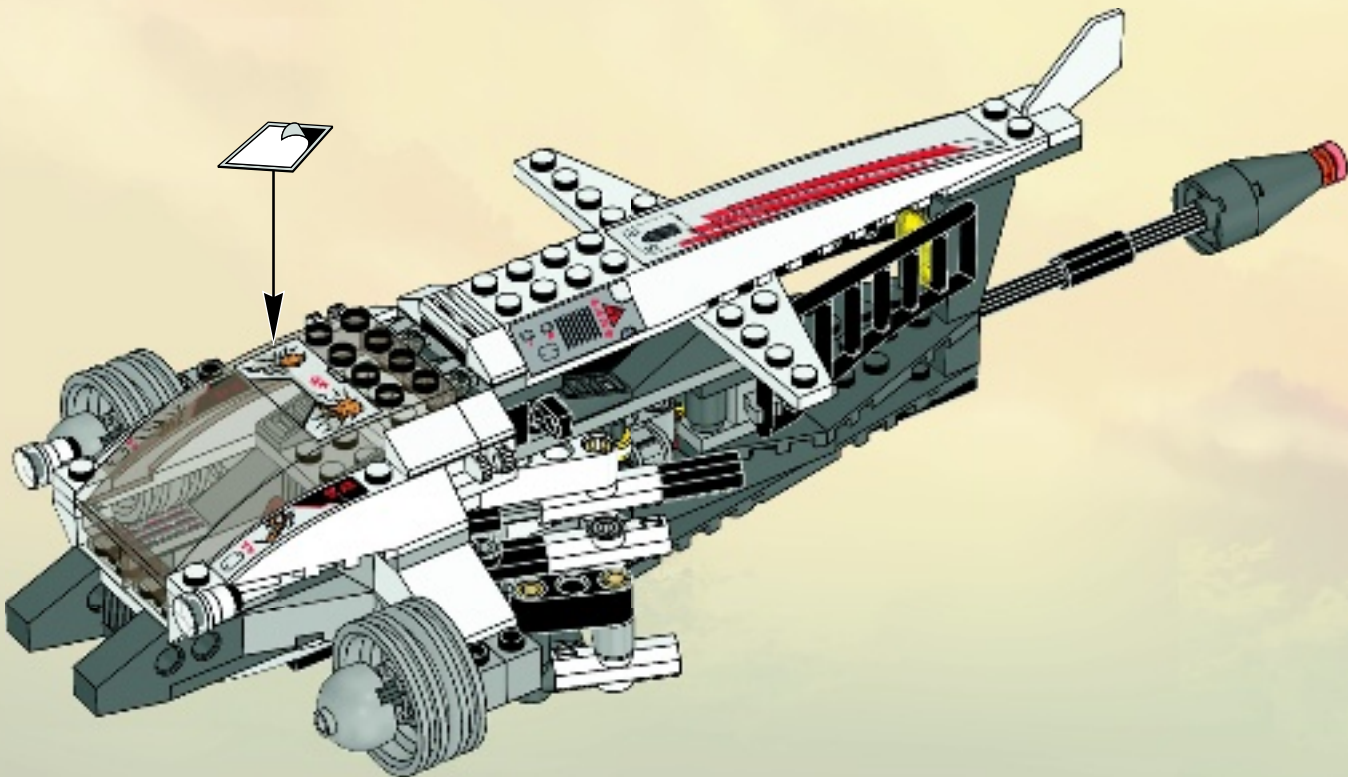



48

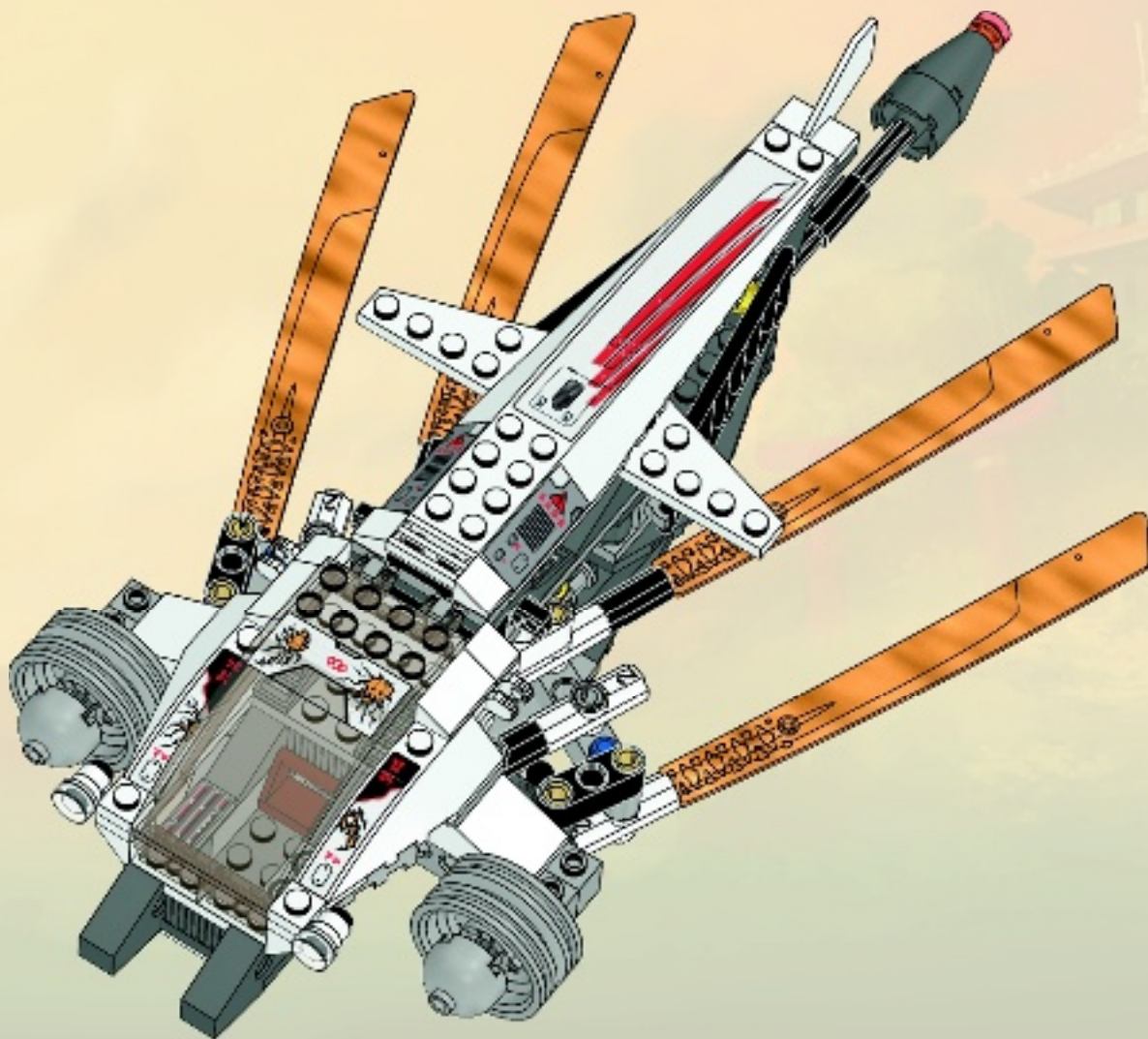



2x

49

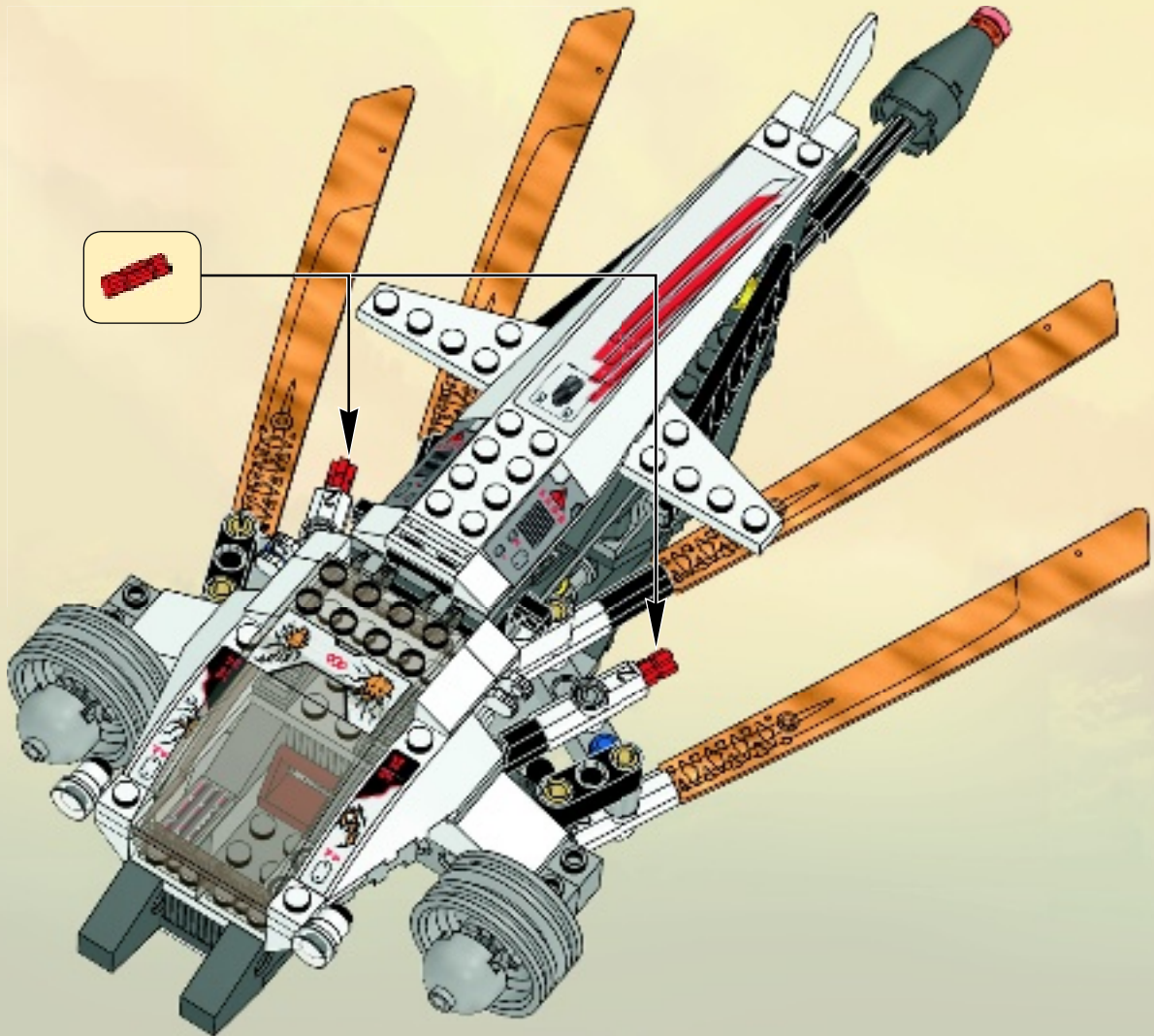



50

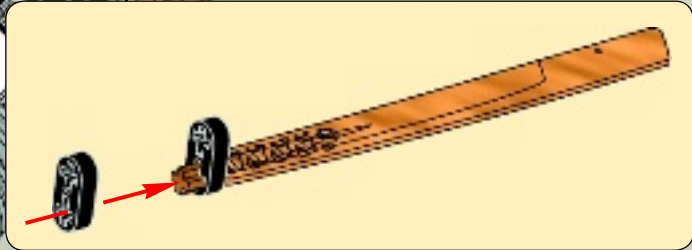
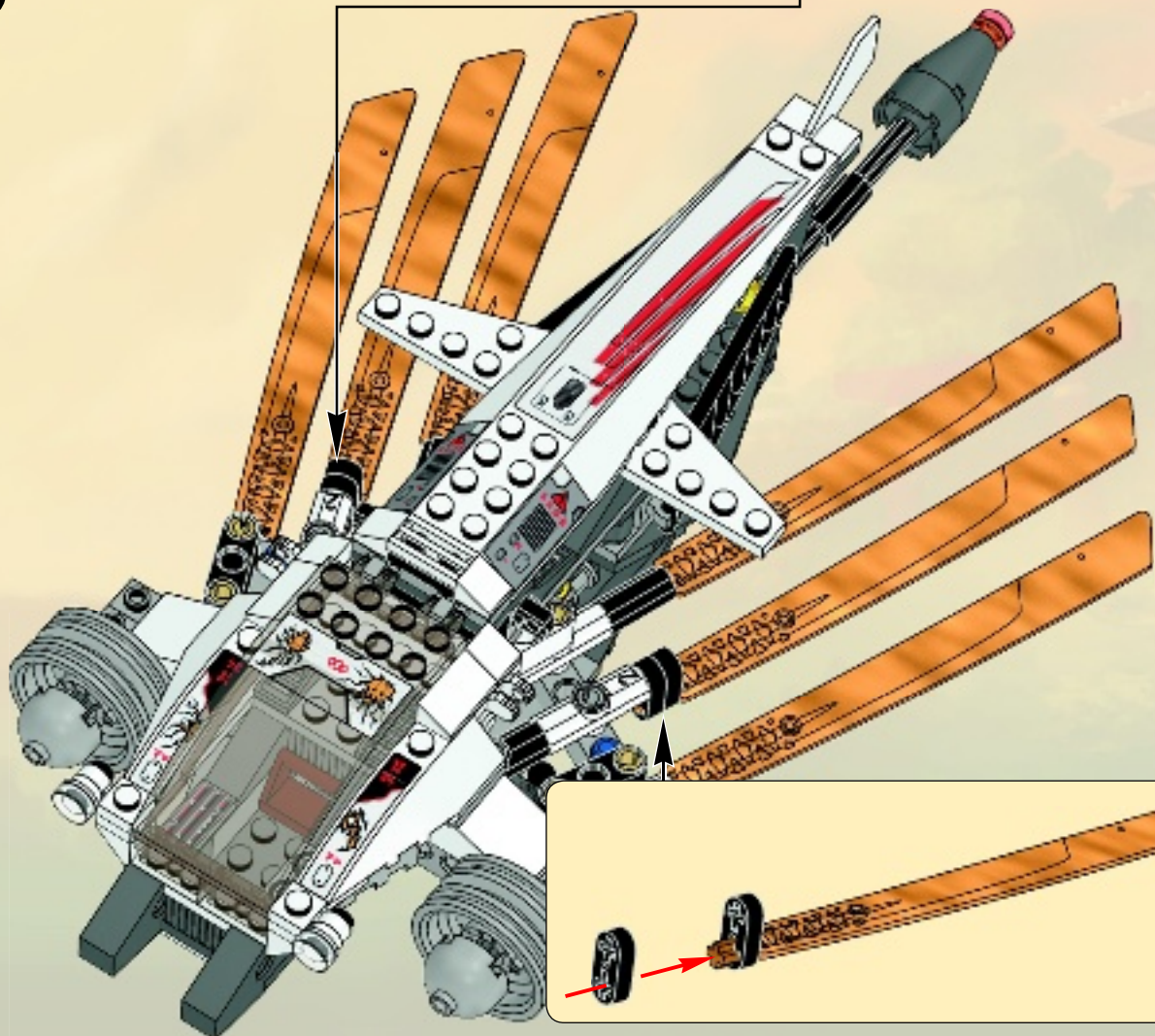
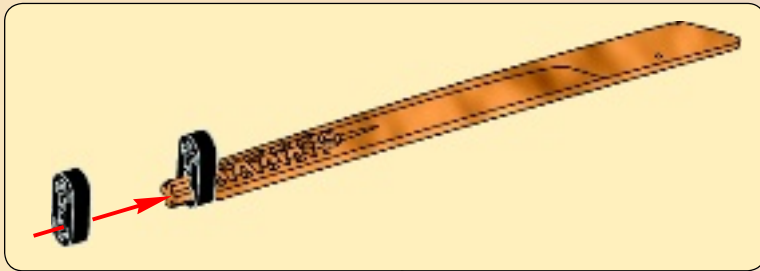

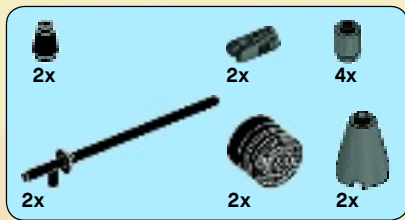

51

1



2



3



4



5



2x

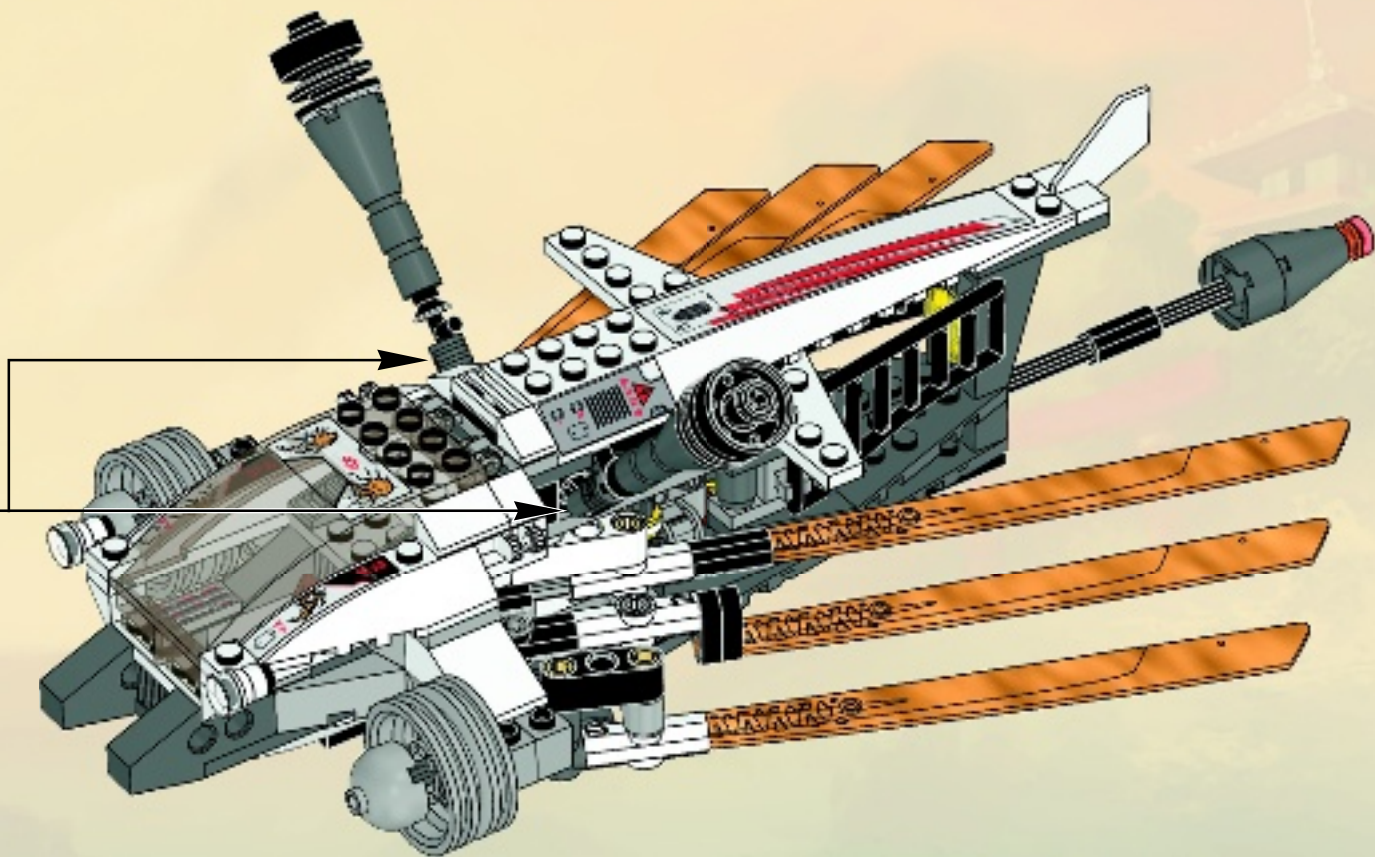



2x



1x

1



1x

2



1x

3



1x

4

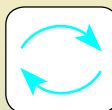



1x

5



4x

6

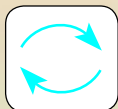

1x

7



2x

52

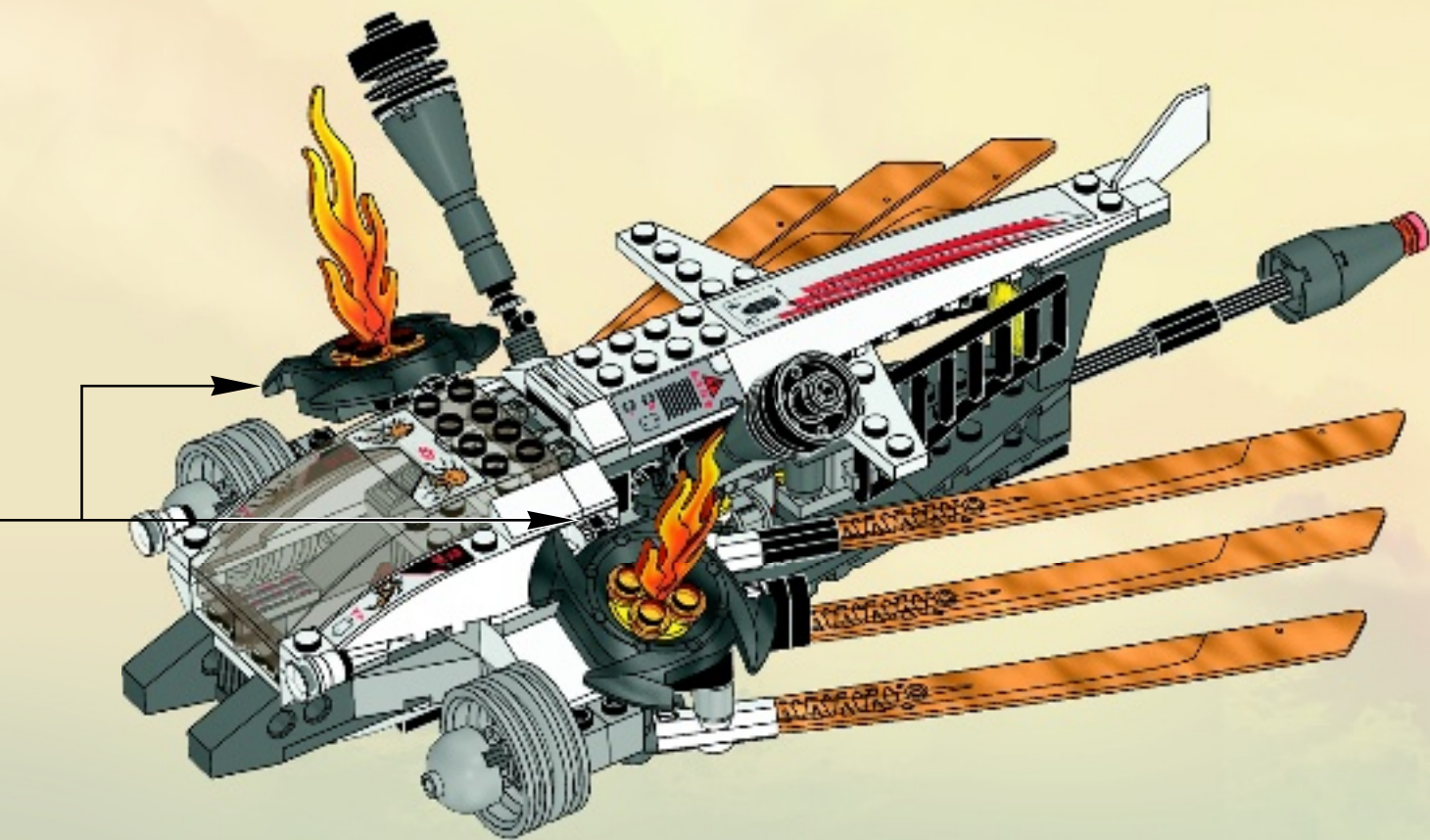

1

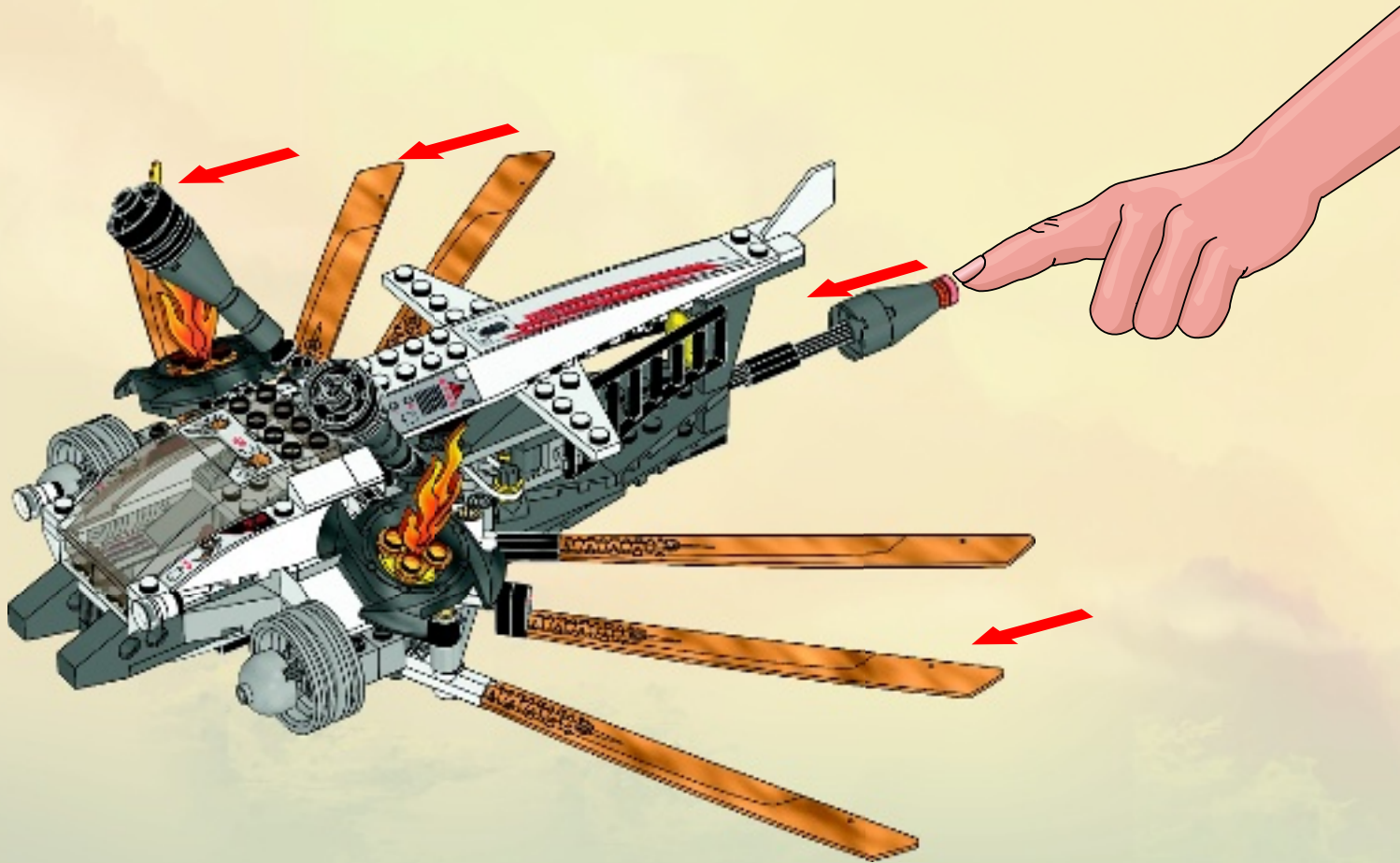

2

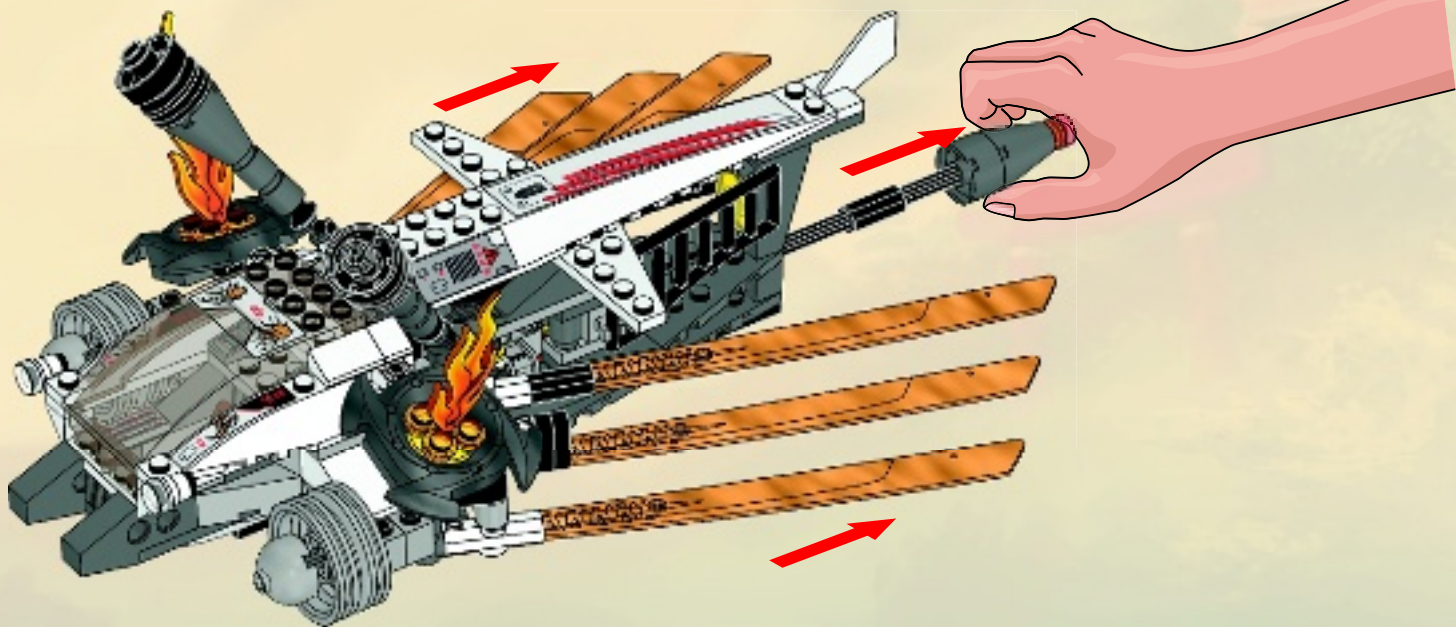

3

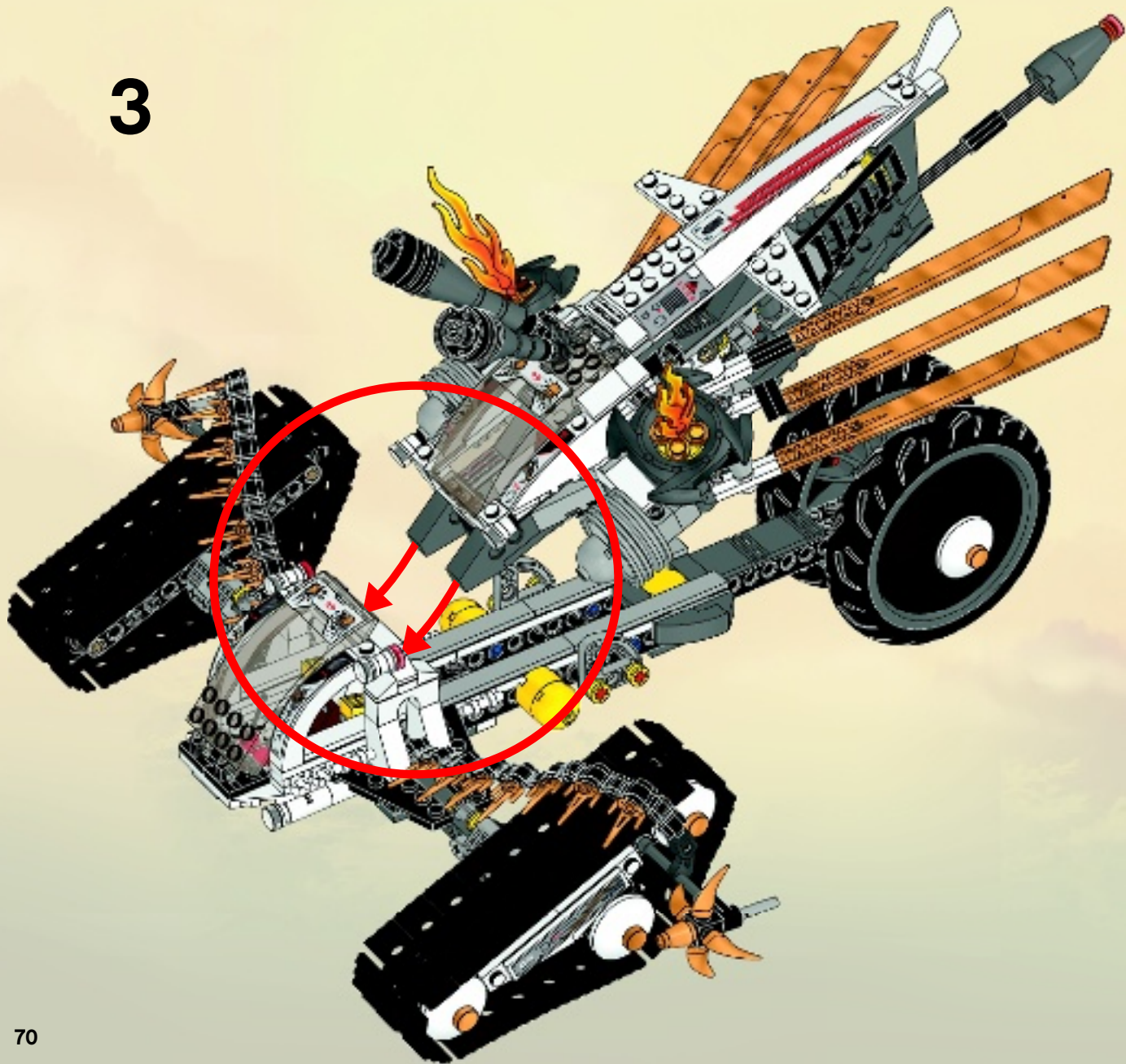

4

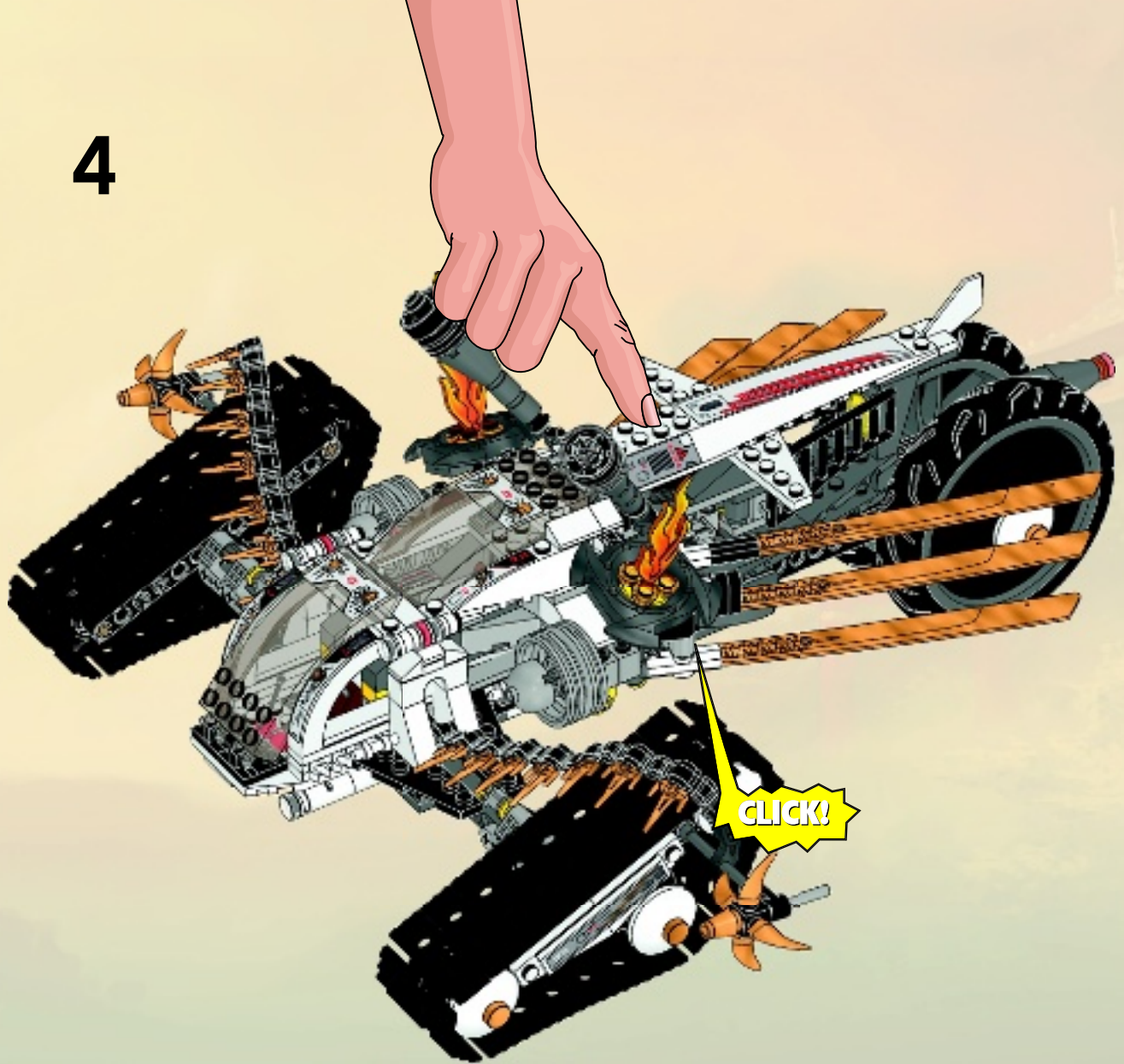

5

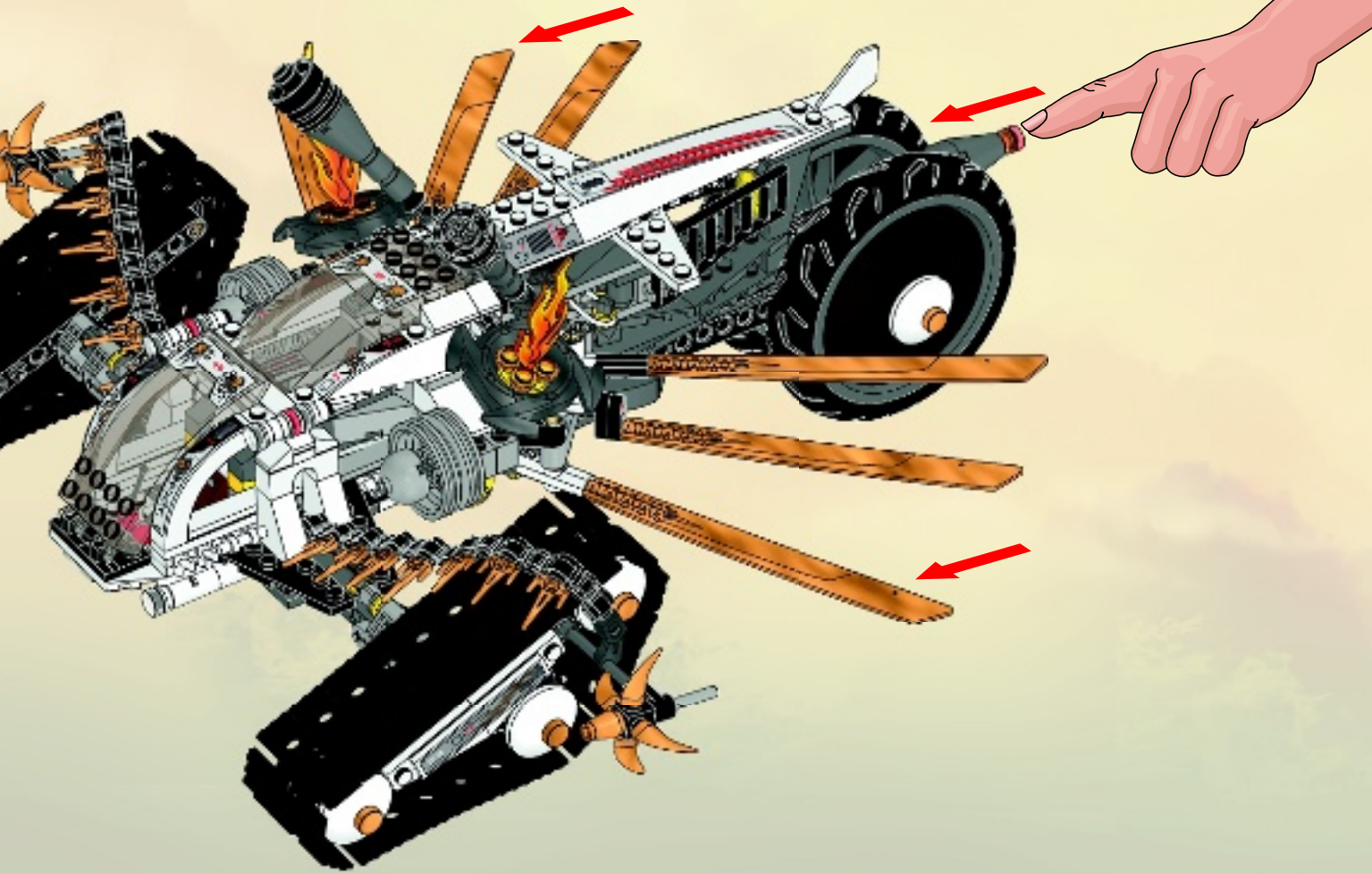

6

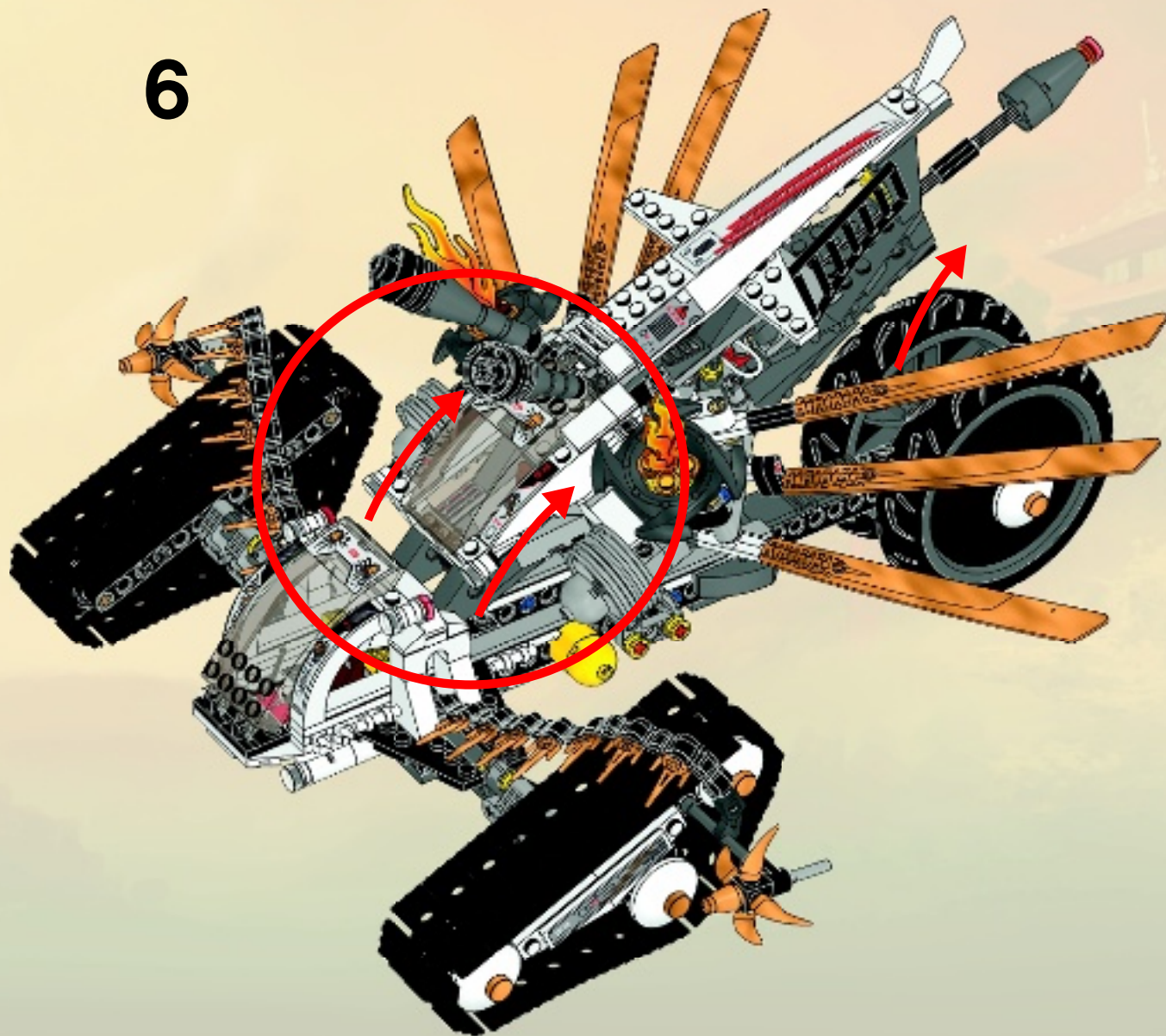



1x
4109791



10x
4504369



2x
4547489



6x
4515370



2x
329801



2x
4259937



2x
4520970



2x
4507168



1x
4160101



1x
4160124



2x
4261693



2x
4160857



1x
4503223



1x
4287708



7x
371001



2x
379501



5x
346001



4x
4613256



4x
4632566



2x
4515337



1x
241201



4x
4140583



5x
663601



8x
614101



2x
4161326



1x
4287707



8x
4179580



1x
4508408



1x
4650494



1x
4650130



1x
4650119



1x
4288960



1x
4544140



2x
4249021



6x
4125554



4x
4526981



10x
4514554



2x
654121



1x
241221



4x
403221



2x
74335



1x
4650487



1x
4650128



1x
4650117



1x
4173975



13x
4142865



1x
4650492



1x
4650129



1x
4650118



14x
4143005



6x
4206482



2x
4514553



1x
300424



2x
4216656



2x
614324



1x
415024



2x
4141630



2x
403224



6x
4169960



1x
4611426



1x
4611427



1x
4611429



1x
4611424



2x
4540384



10x
4239601



1x
4107800



1x
301026



1x
4181144



2x
473326



2x
4529236



2x
370026



2x
4529549



1x
273026



4x
370326



2x
302226



2x
383226



2x
4185620



2x
4613759



2x
4251393



2x
4251394



2x
4620385



1x
4650495



1x
4650131



2x
4114206



2x
384926



1x
4650120



2x
4517737



2x
4159335



2x
4142822



4x
4522933



2x
4497946



4x
4164133



2x
4567999



2x
4184169



10x
4107085



8x
4109810



18x
4121715



3x
4512363



4x
4140801



1x
370626

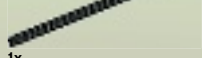

1x
370826



6x
4662228



2x
4652060



6x
4650498



1x
4653402



3x
4646864



2x
4548009



1x
4278415

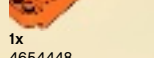

1x
4654448



2x
4200798

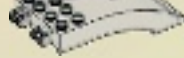

2x
4199601



2x
4183133



1x
6001078



1x
4647769



6x
4566927



1x
6016732



9x
4222960



1x
4211201



2x
4211219



4x
4533772



2x
4211637



1x
4526932



1x
4527767



2x
4211541



2x
4211705



2x
4211614



2x
4211437



2x
4217918



6x
4211398



1x
4211401



1x
4212363



1x
4654046



3x
4211365



2x
6014615



1x
4211840



5x
4560183

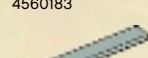

4x
4211481



1x
4585429



1x
4539481



2x
4541318



2x
4520320



2x
4495930



2x
4538007



2x
4531184



4x
4630114



4x
4211622



8x
4211807



4x
4211888



2x
4211815



1x
4535768



1x
4611880



3x
4211100



2x
4210636



6x
4211090



1x
4249139



3x
4211108



1x
4211111



2x
4273814



2x
4621917



2x
4500975



4x
4211045



2x
4246896



6x
4211133



2x
4598769



7x
4211065



2x
4211056



1x
4243831



2x
4211115



1x
4211061



2x
4538721



4x
4540386



2x
4210695



2x
6006141



4x
6005331



2x
4499858



1x
4586562



1x
4290150



1x
4209014



2x
4538721



4x
4540386



2x
4210695



2x
6006141



4x
6005331



2x
4560177



2x
4499858



2x
4568006



3x
4603472



1x
4650894



1x
6001079



1x
6009199



2x
4529247



8x
4649422



1x
4600267



1x
4626501



3x
4640843



2x
4600519



14x
4646866



2x
4646814



9x
4611904



1x
4600501



2x
6005671



46x
6003879



2x
4612900



2x
4646815



1x
4617190



2x
6008484



2x
4647381



6x
4646835



Customer Service

Kundenservice

Service Consommateurs

Servicio Al Consumidor

LEGO.com/service or dial



00800 5346 5555 :



1-800-422-5346 :





NINJAGO

Masters of Spinjitzu



9449



9448



9447



9450



9450



9449



9448



9447



NINJAGO

Masters of Spinjitzu

**CUSTOMISE YOUR SPINNERS
PERSONNALISE TES TOUPIES
PERSONALIZA TUS SPINNERS**



9554

9555



9556

9557

COMING SOON
PROCHAINEMENT
PROXIMAMENTE

COMING SOON
PROCHAINEMENT
PROXIMAMENTE



9591

SPITTA

NRG JAY

FANEDAM

NRG COLE



COMING SOON
PROCHAINEMENT
PROXIMAMENTE

COMING SOON
PROCHAINEMENT
PROXIMAMENTE

COMING SOON
PROCHAINEMENT
PROXIMAMENTE



NRG KAI VS CHOKUN



9569

9570

9571

9572

9573

9574

9590

9591

NINJAGO.COM



NINJAGO

Masters of Spinjitzu



NINJAGO.COM

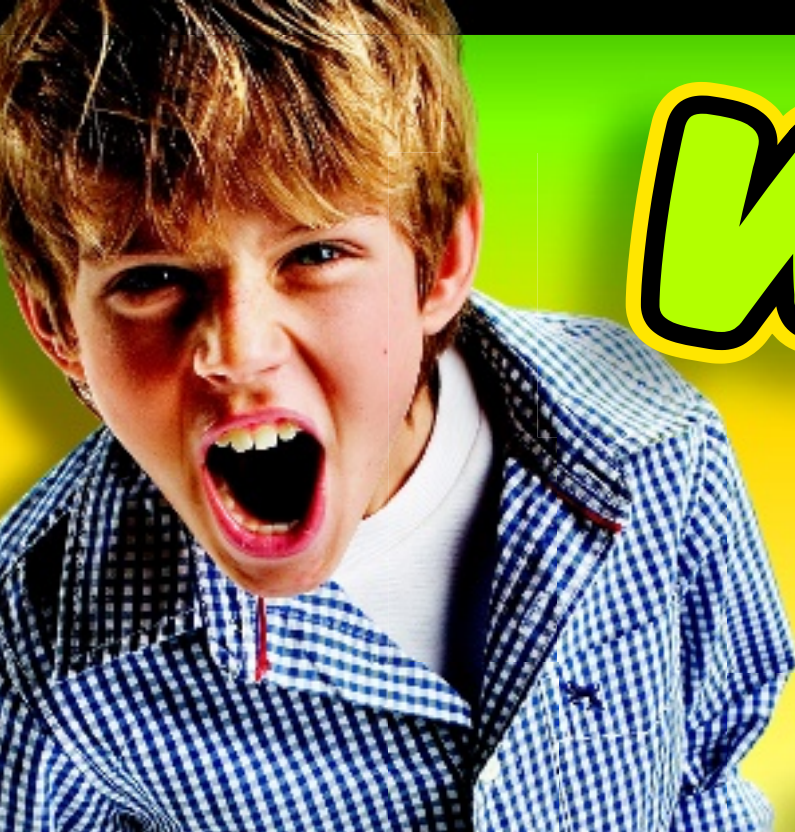

WIN!

Go to www.LEGOsurvey.com/product
to fill out a survey for a chance
to win a cool LEGO® Product.
No purchase necessary.
Open to all residents where not prohibited.



LEGO.com



www.LEGOsurvey.com/product

GEWINNE! WIN!

Nimm an der Umfrage auf
www.LEGOsurvey.com/product
teil und hab die Chance ein cooles
LEGO® Produkt zu gewinnen!

Die Teilnahme am Gewinnspiel führt zu keinerlei
Kaufverpflichtungen. Teilnahme in allen nicht
ausgeschlossenen Ländern möglich.

Ga naar www.LEGOsurvey.com/product,
vul een
enquêteformulier in en maak
kans op een cool LEGO® product.
Geen aankoopverplichting.
Iedereen mag deelnemen, uitgezonderd
ingezetenden van landen waar een
enquêteverbod geldt.

GAGNE! 当てよう!

Visite www.LEGOsurvey.com/product
pour répondre à un
questionnaire et avoir une chance de
gagner un produit LEGO® très cool!
Aucune obligation d'achat.
Ouvert à tous les résidents des pays
autorisés.

www.LEGOsurvey.com/product にアクセスして、
アンケートにご記入ください。当選者にはレゴ®
製品を差し上げます。

お買い上げの必要はありません

禁止されていない限り、すべての皆様にご利用いただけます。