



# NINJAGO

Masters of Spinjitzu

9449



2 IN 1

JAY ZX + ZANE ZX  
INCLUDED



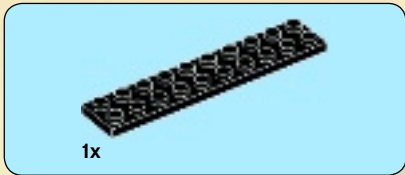
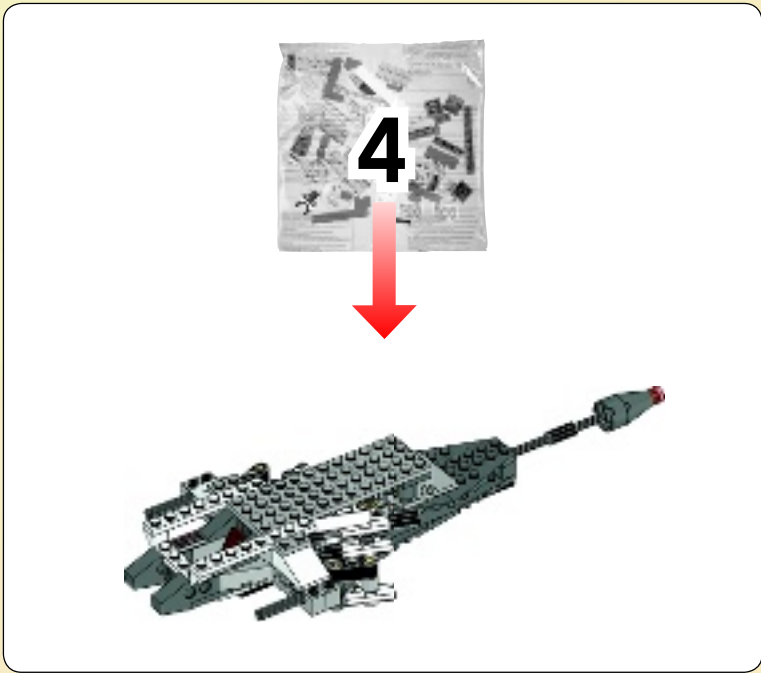

1x

1



**2 IN 1**  
**2 IN EINEM**  
**2 EN 1**  
**2 EN 1**  
**2 EM 1**  
**2 AZ EGYBEN**

**JAY ZX + ZANE ZX INCLUDED**  
**ENTHÄLT JAY ZX + ZANE ZX**  
**JAY ZX + ZANE ZX INCLUS**  
**INCLUYE A JAY ZX Y A ZANE ZX**  
**JAY ZX + ZANE ZX INCLUIDOS**  
**JAY ZX + ZANE ZX A CSOMAGBAN**

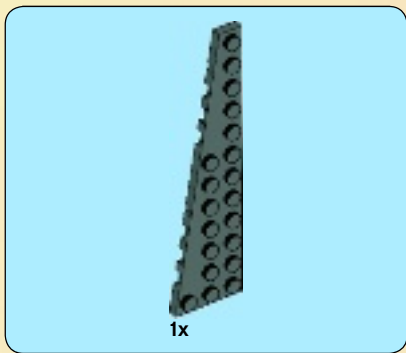

2

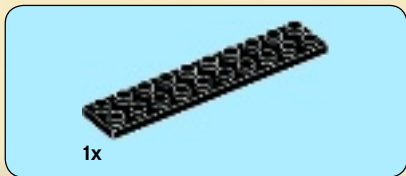
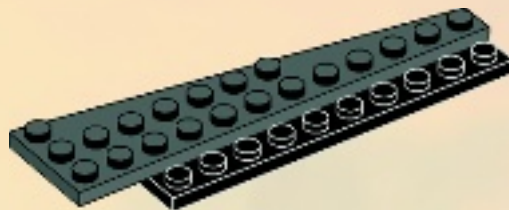

3

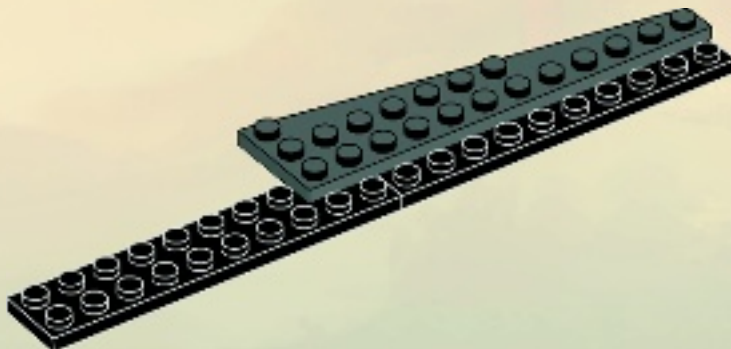

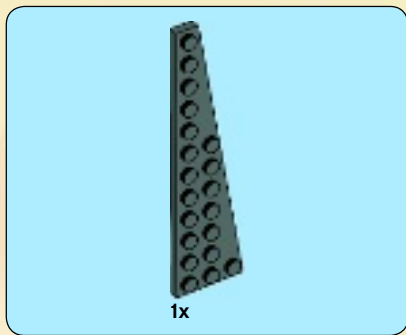

4

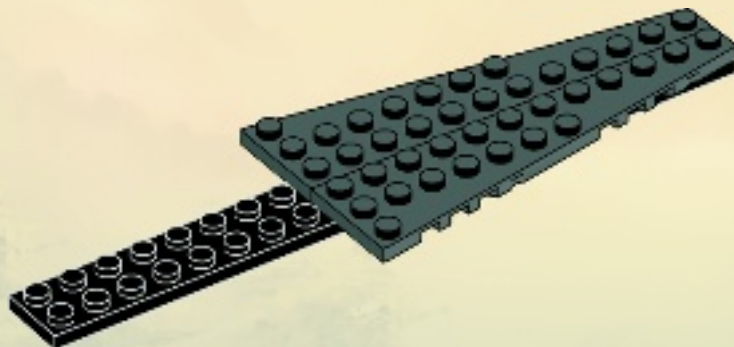

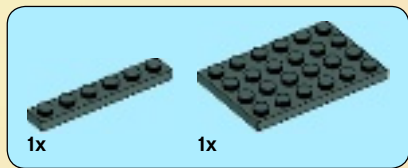

5

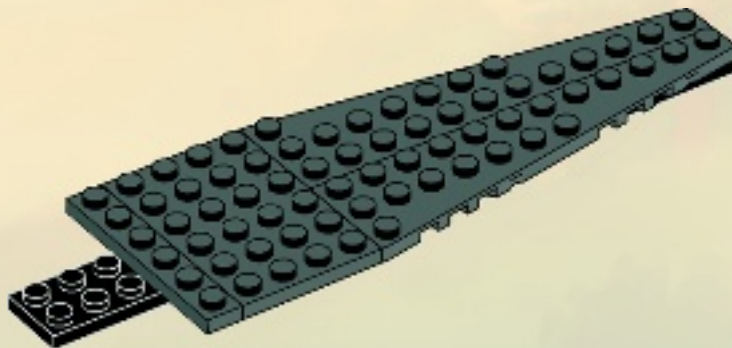

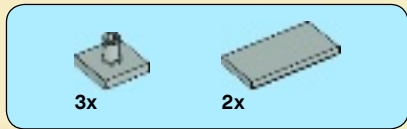

6

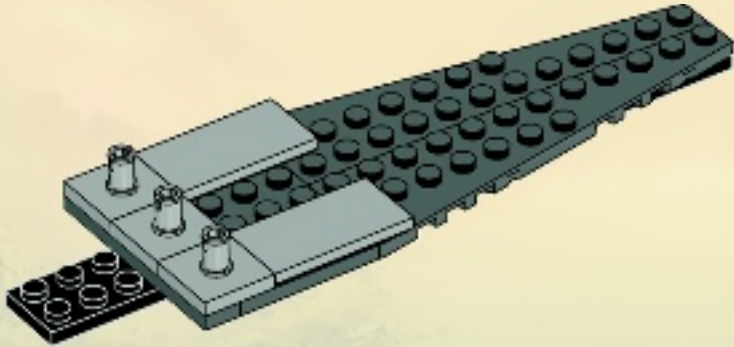

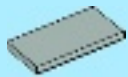

2x

7

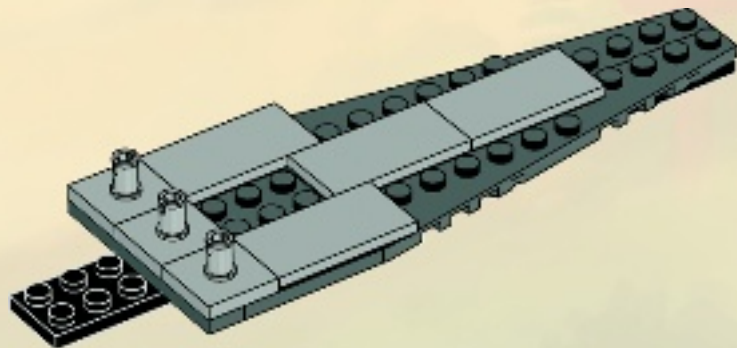



2x

8

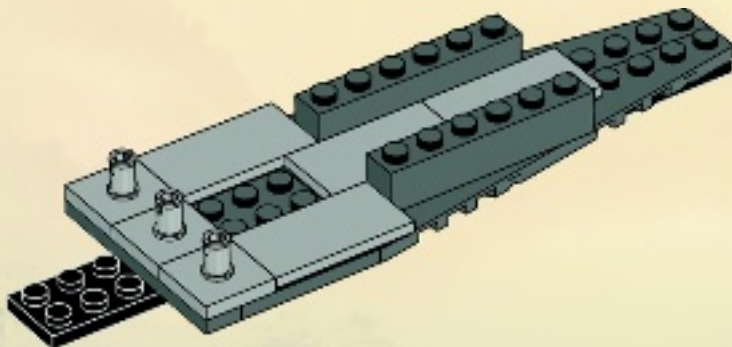



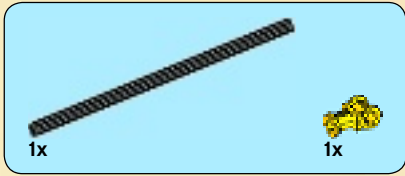
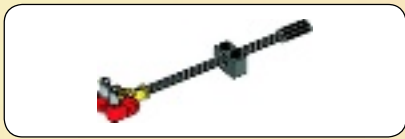

1

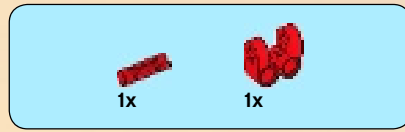
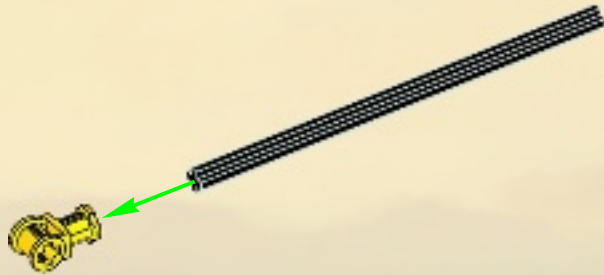

2

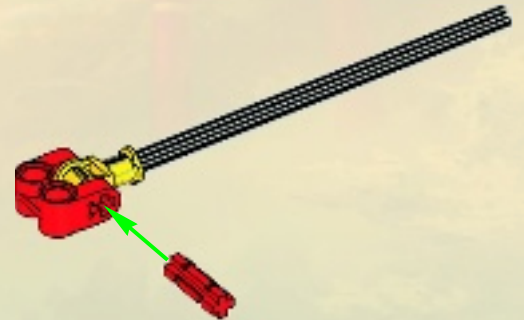



2x

3



1x



1x

4

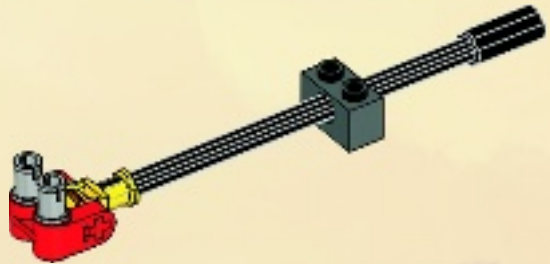

9

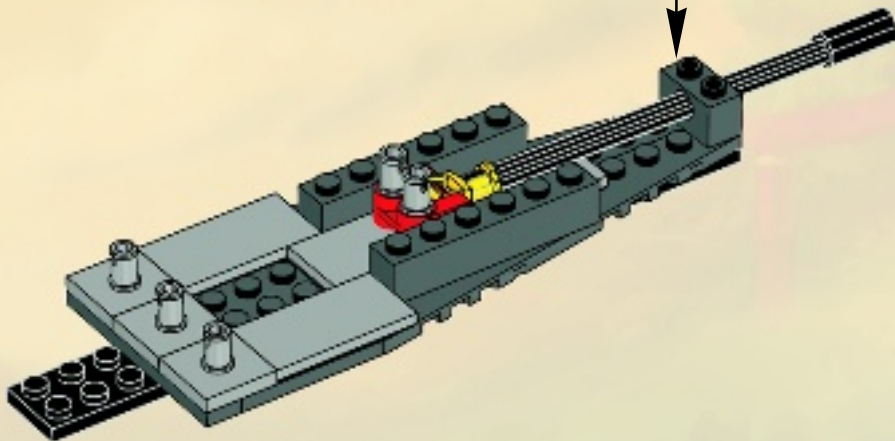

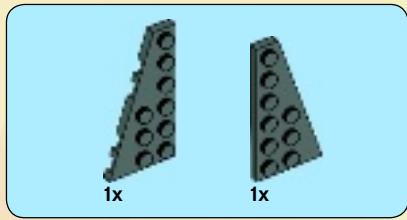

10

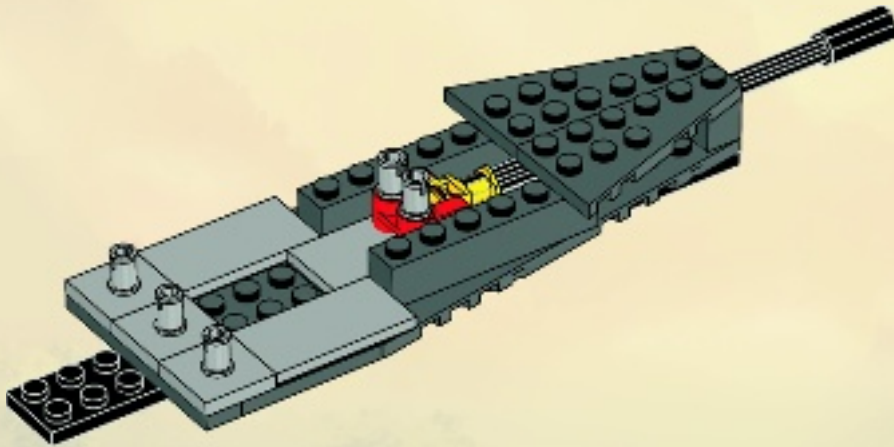



1x



1x

# 11

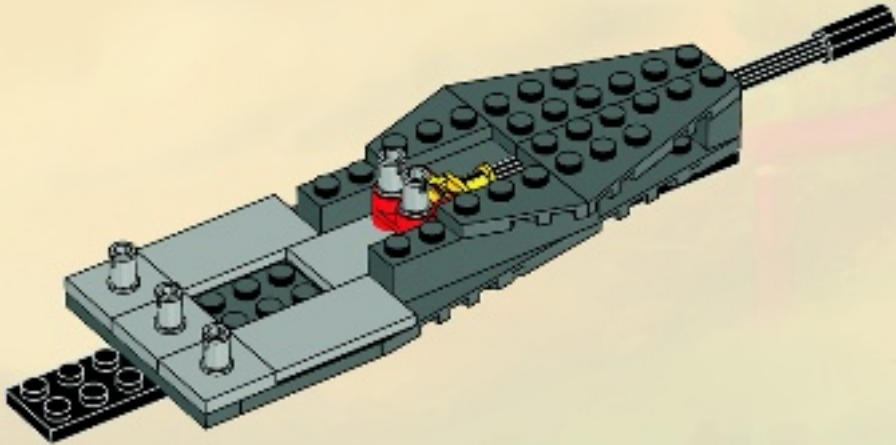

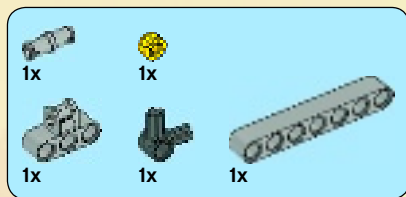

# 12

1

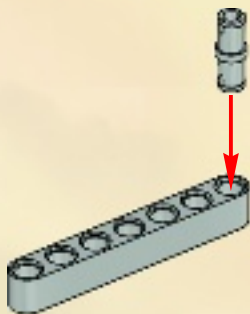

2

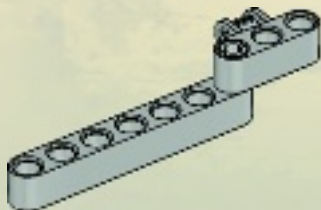

3

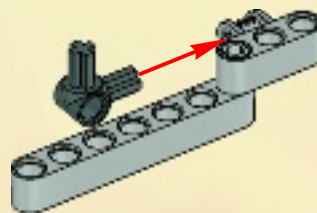

4

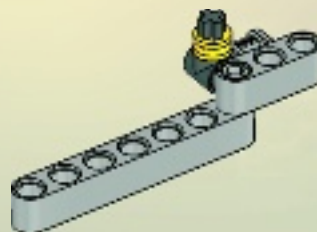

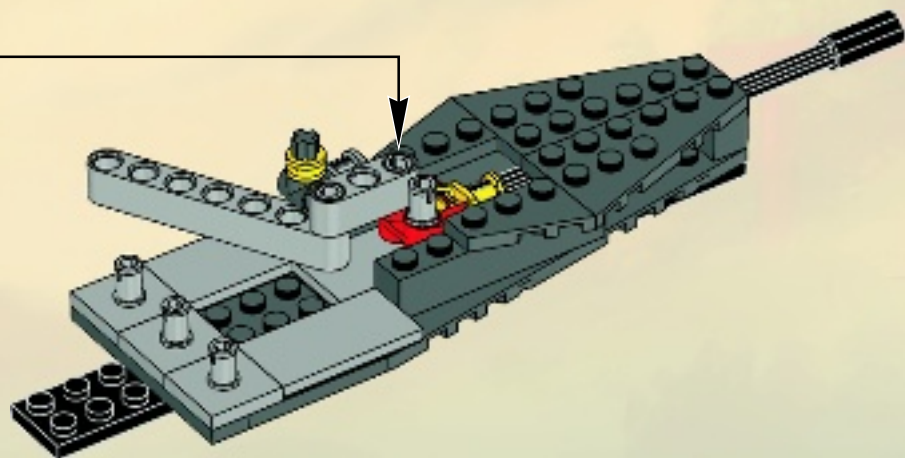



# 13

1

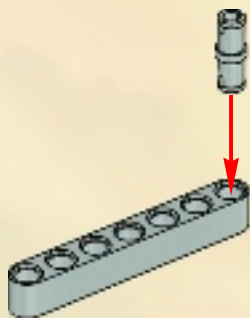

2

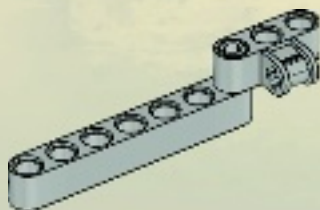

3

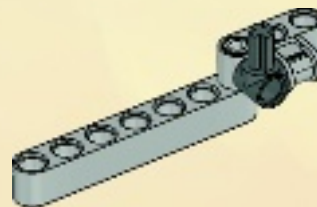

4

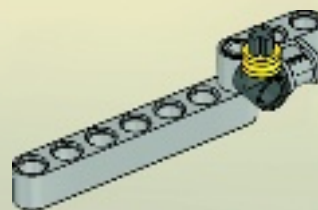



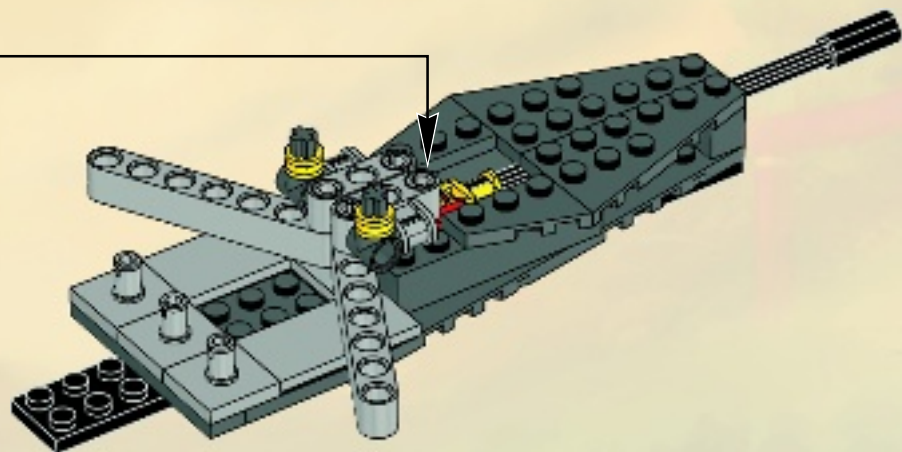



1x

14

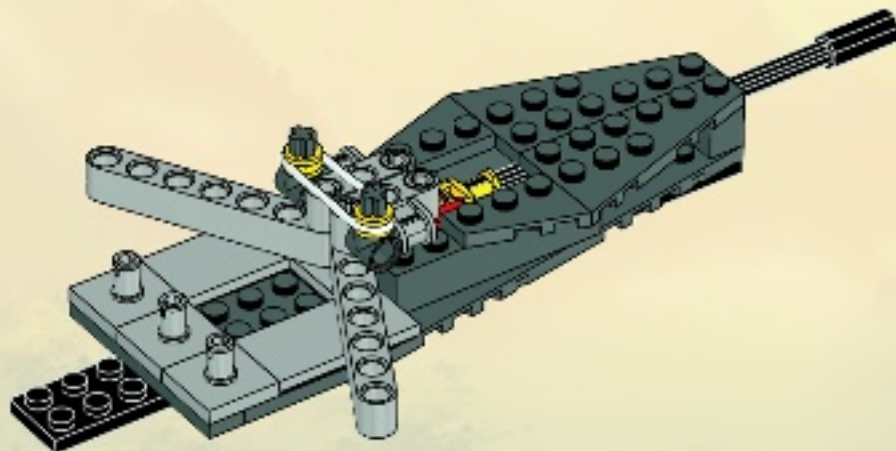

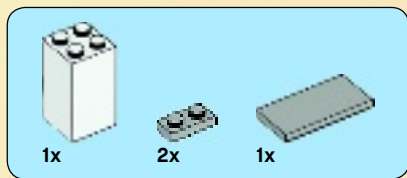

15

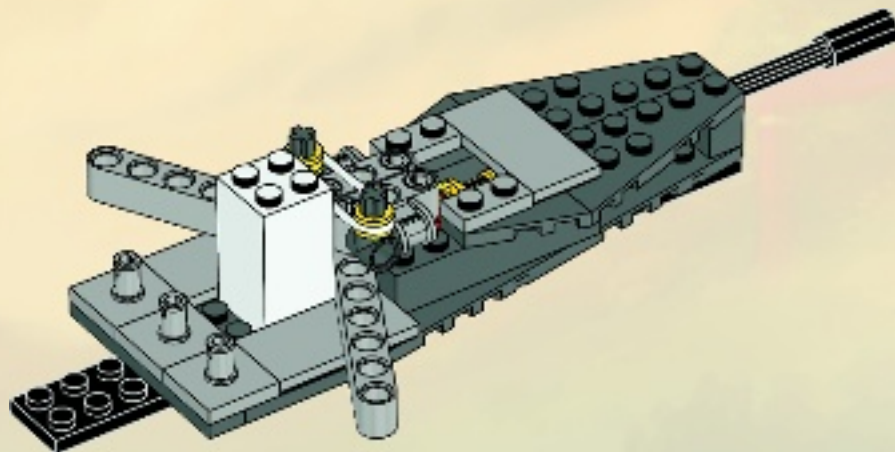



1x

# 16

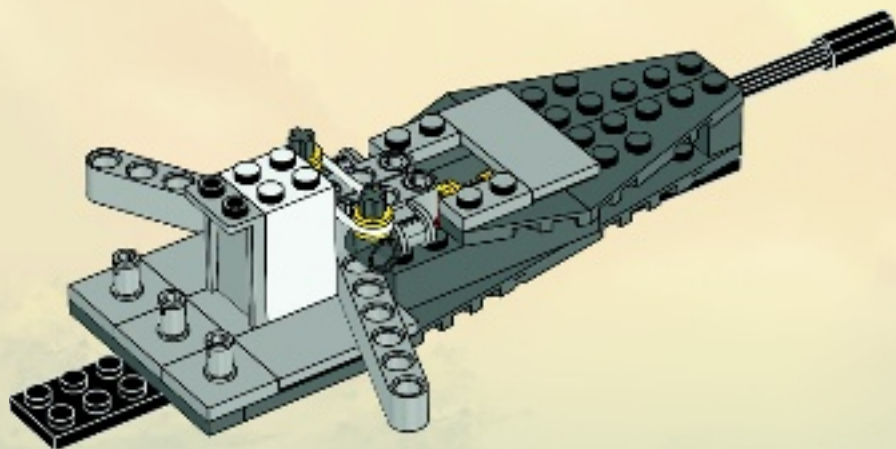

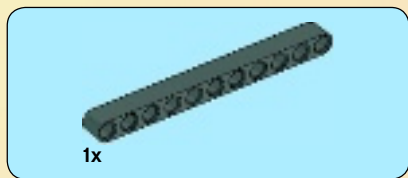

17

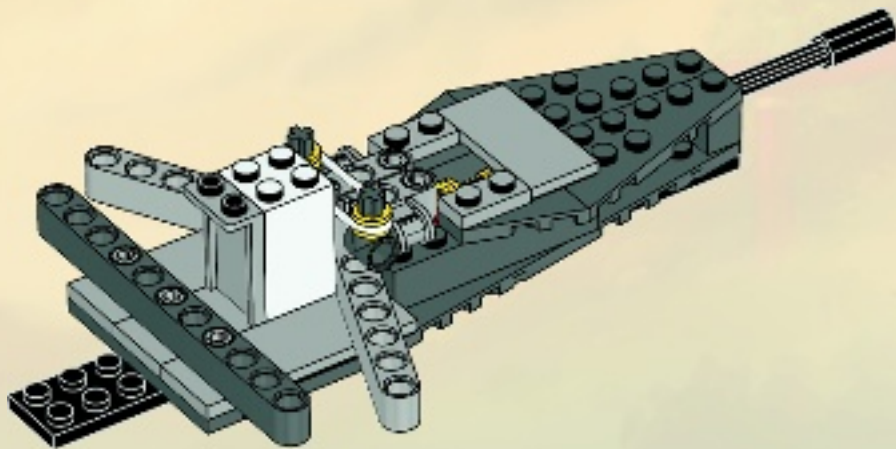



4x

# 18

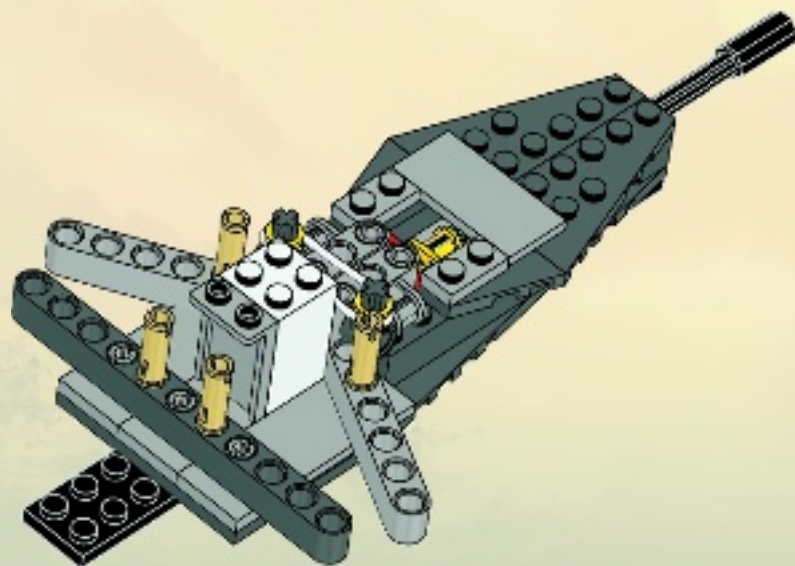

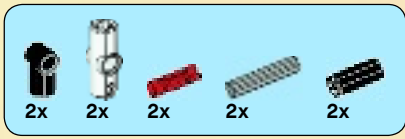

# 19

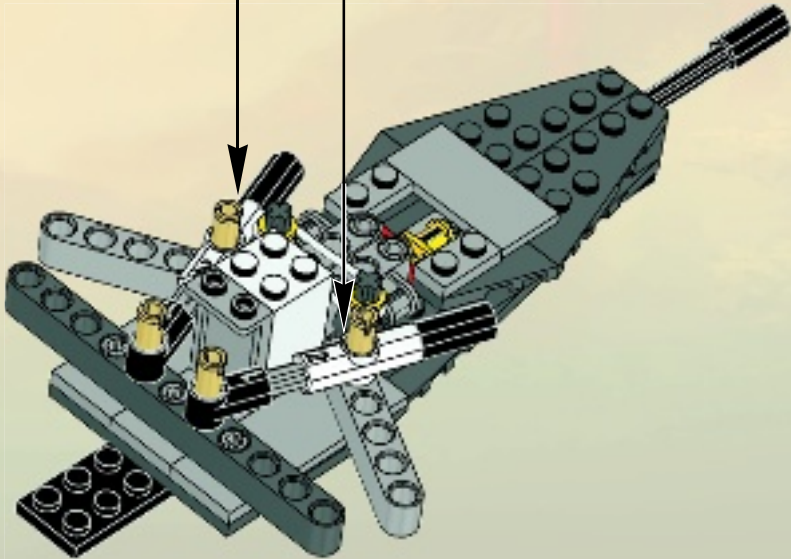
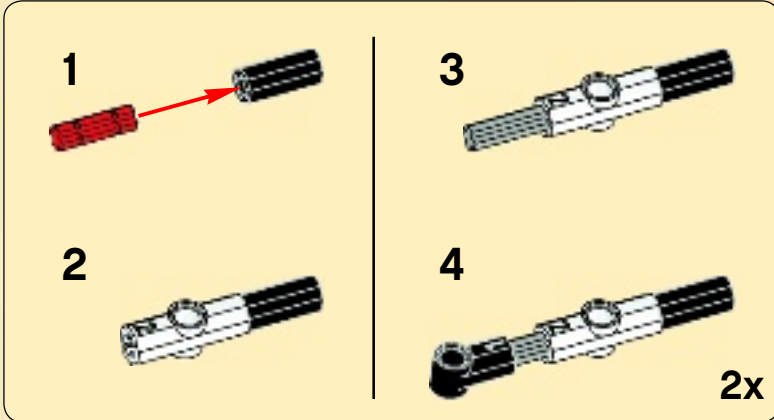



4x

# 20

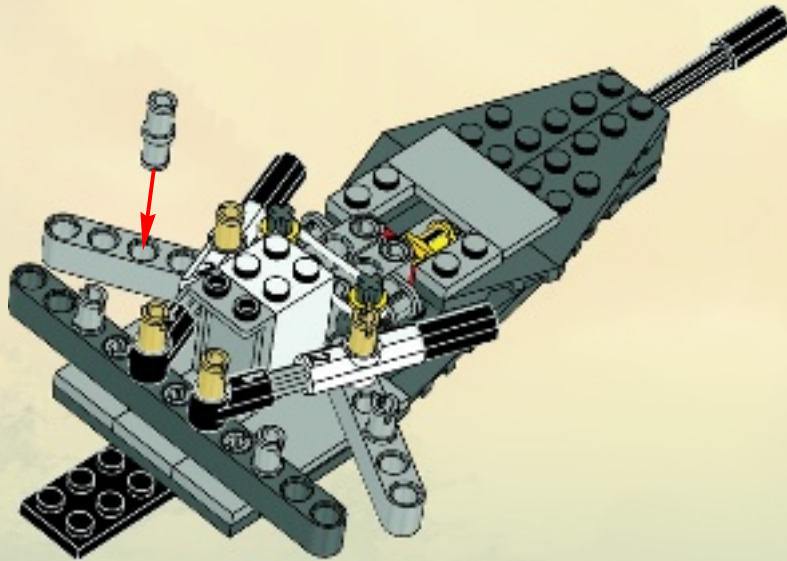



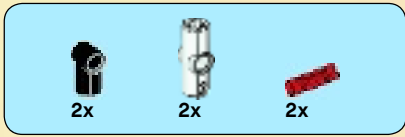

# 21

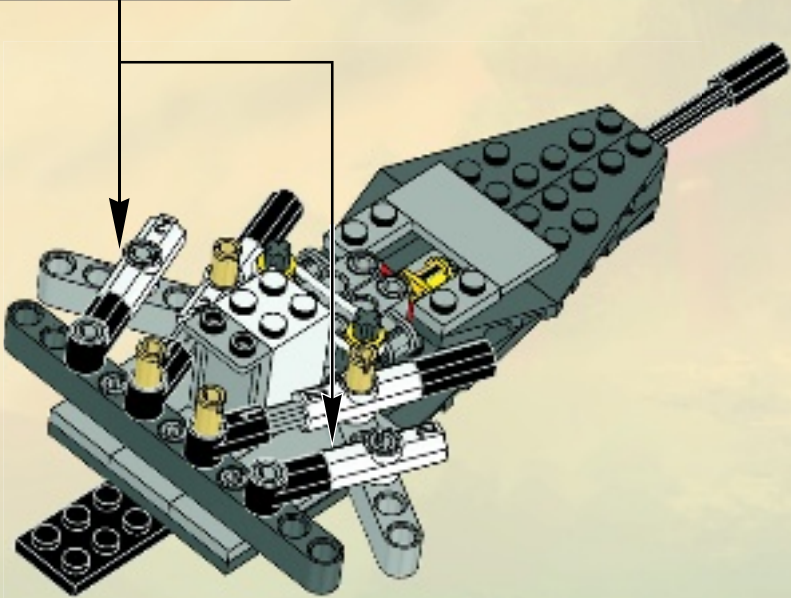
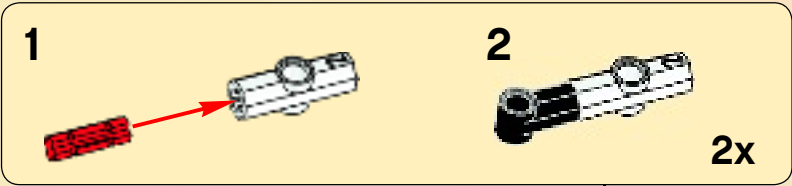



2x

# 22

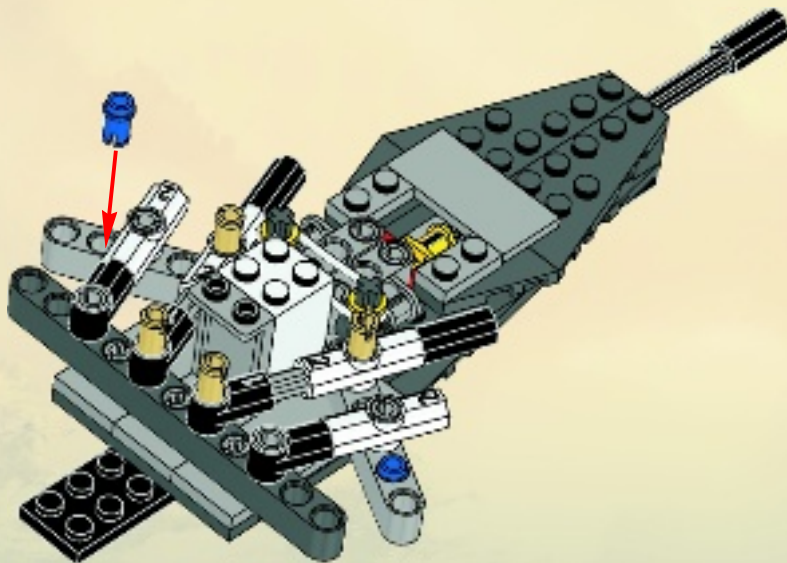



4x

# 23

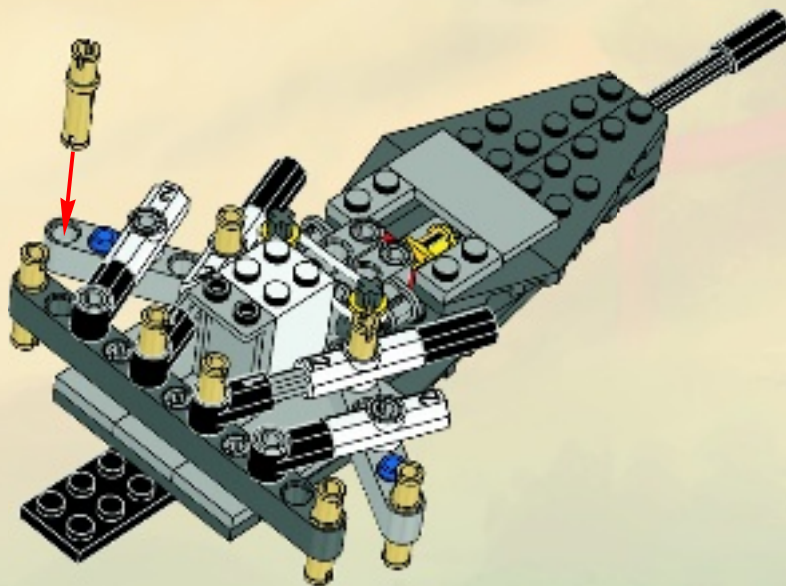



2x

# 24

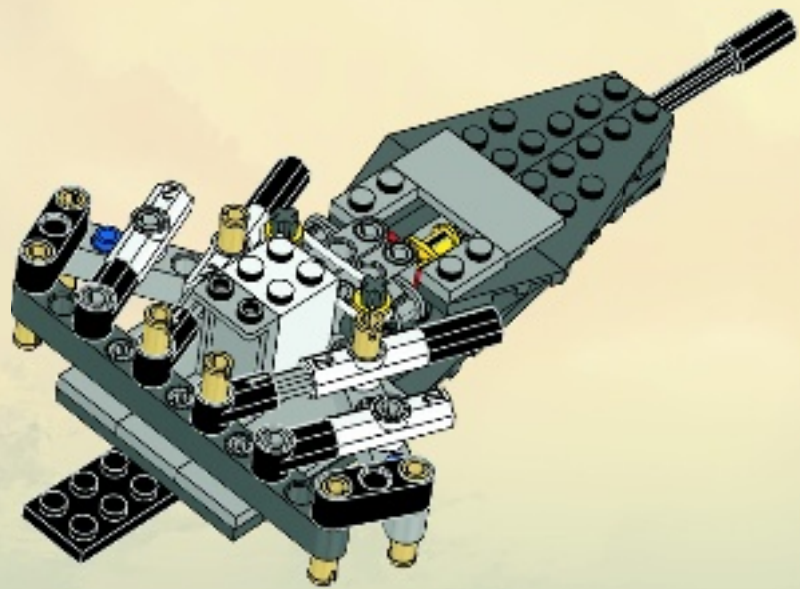



2x

# 25

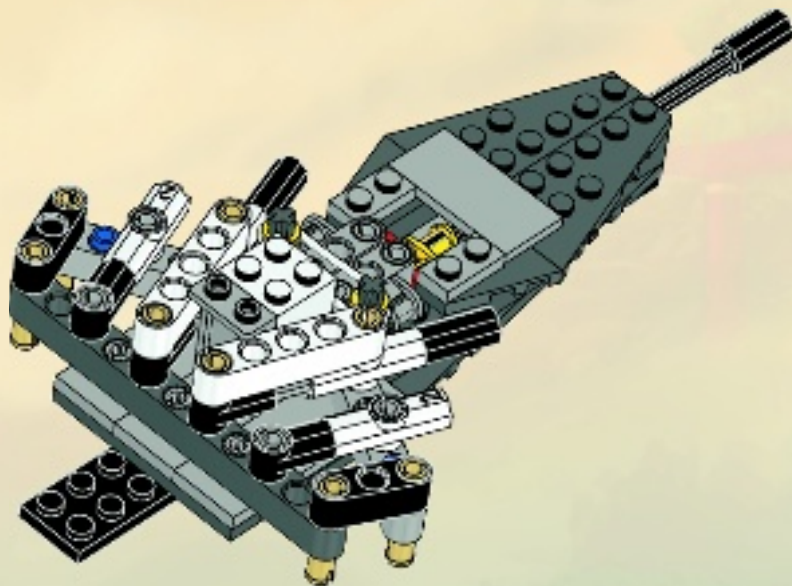



2x



2x

# 26

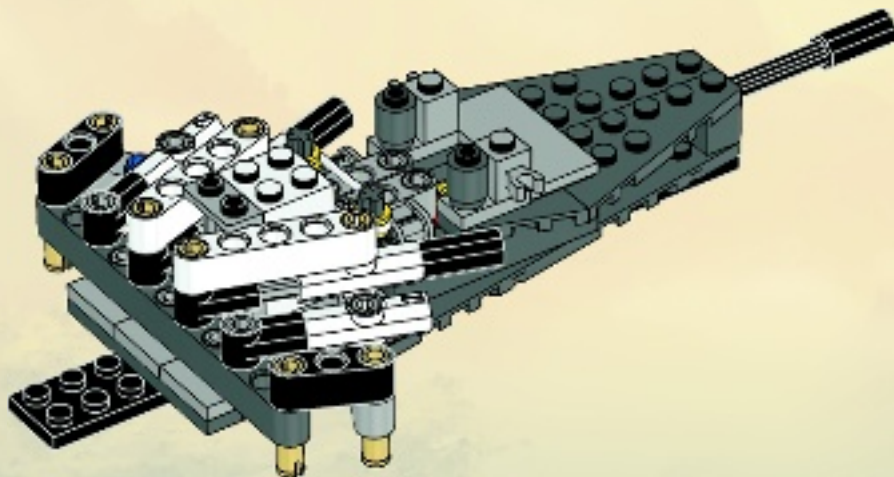



1x

# 27

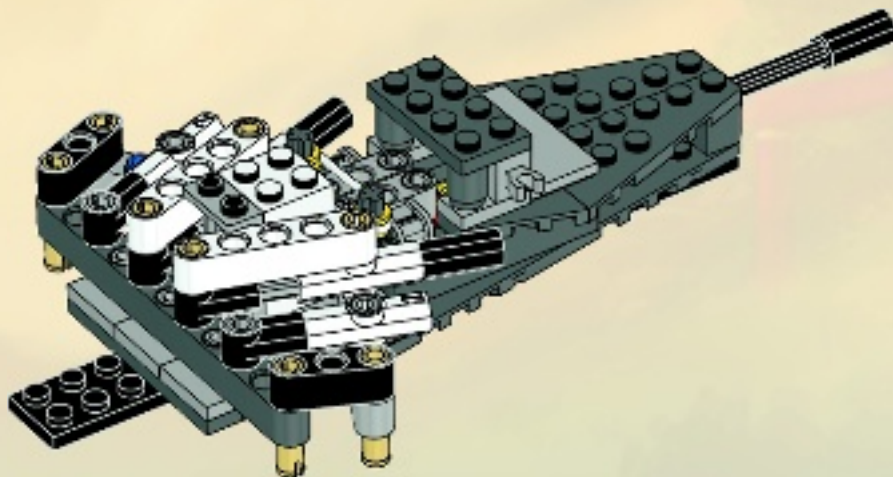

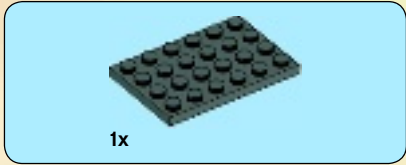

**1**

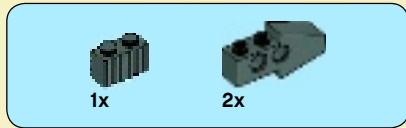
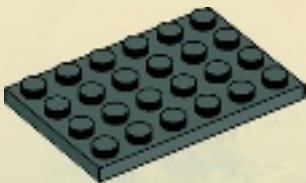

**2**

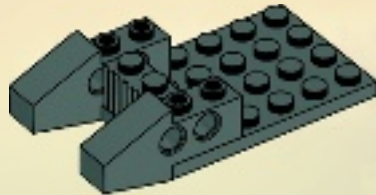



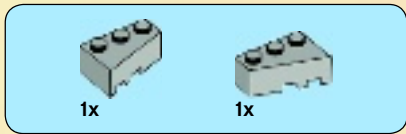

3

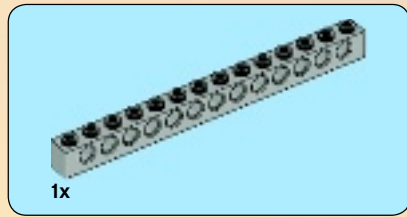
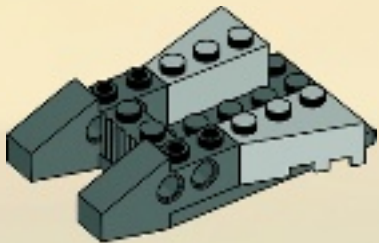

4

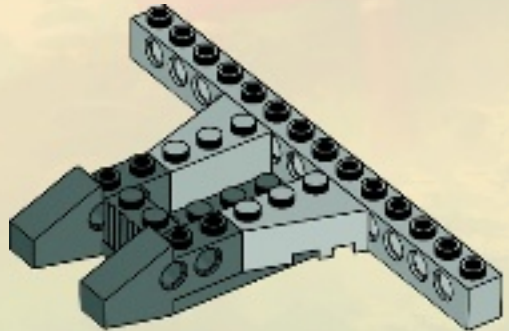

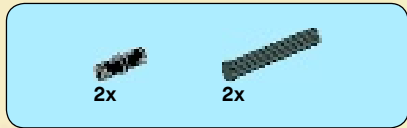

5

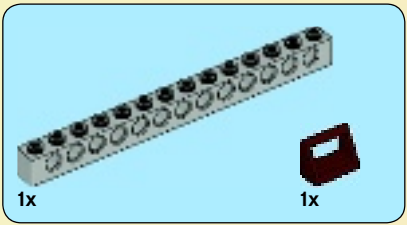
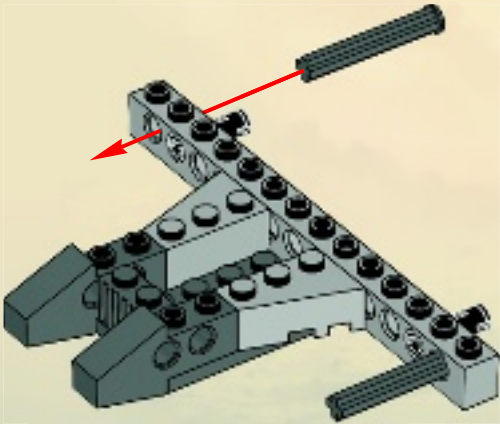

6

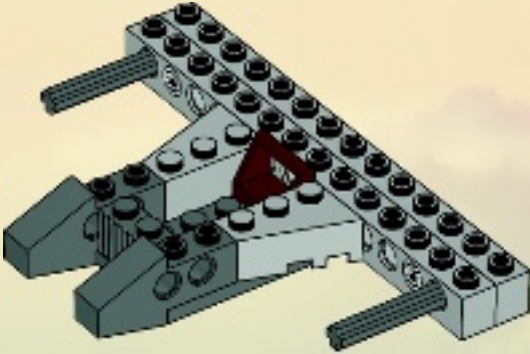

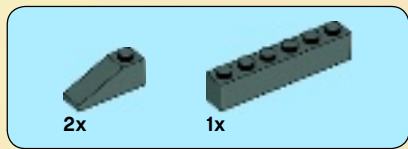

7

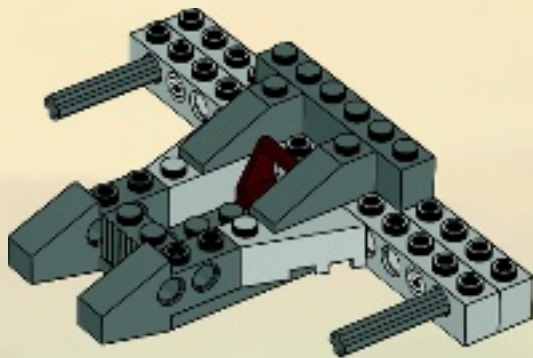

8

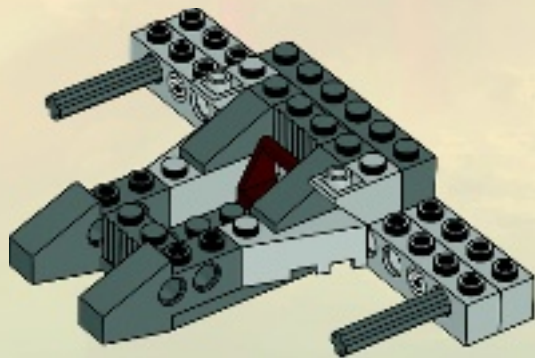

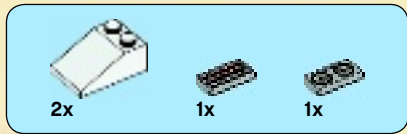

9

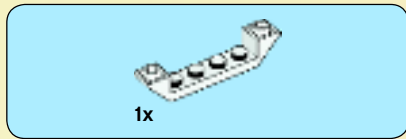
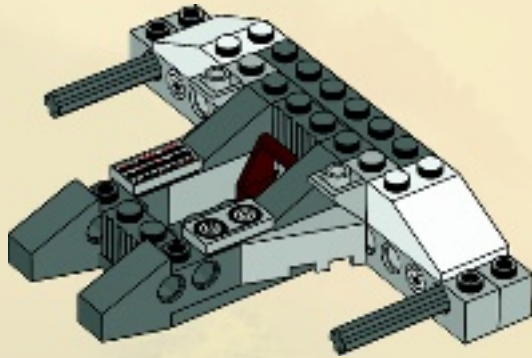

10

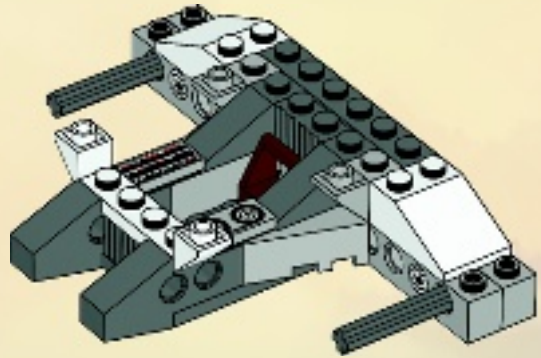

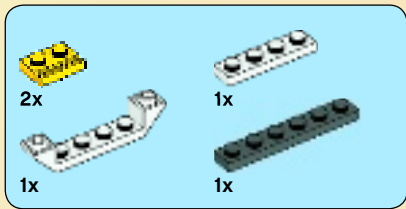

11

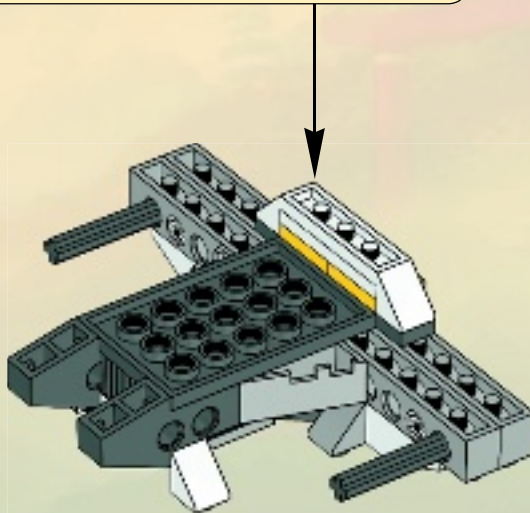
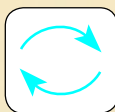
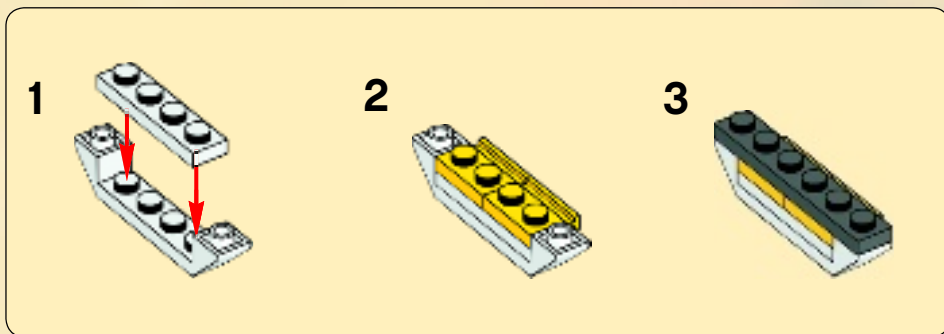



1x

12

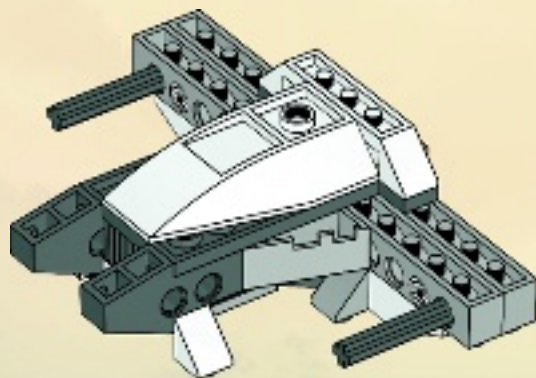

28

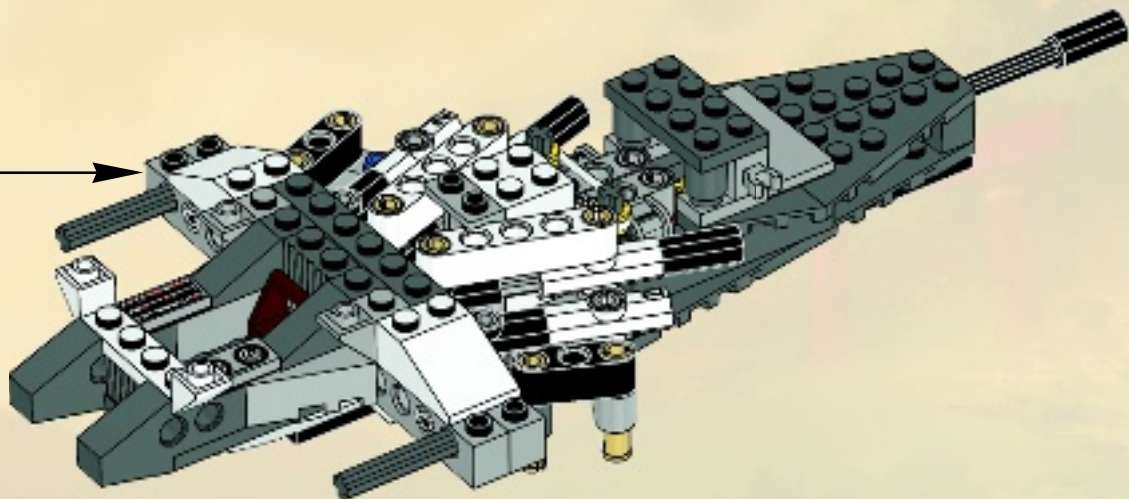

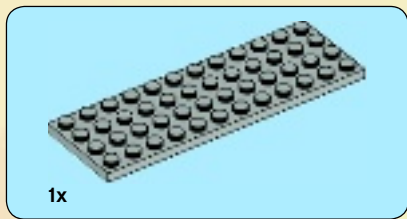

29

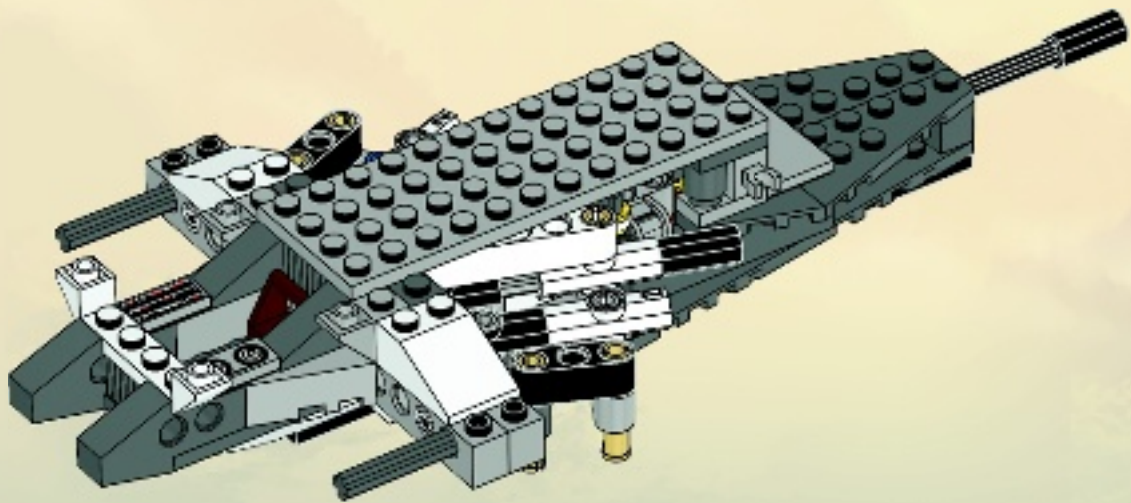



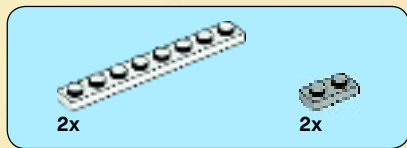

# 30

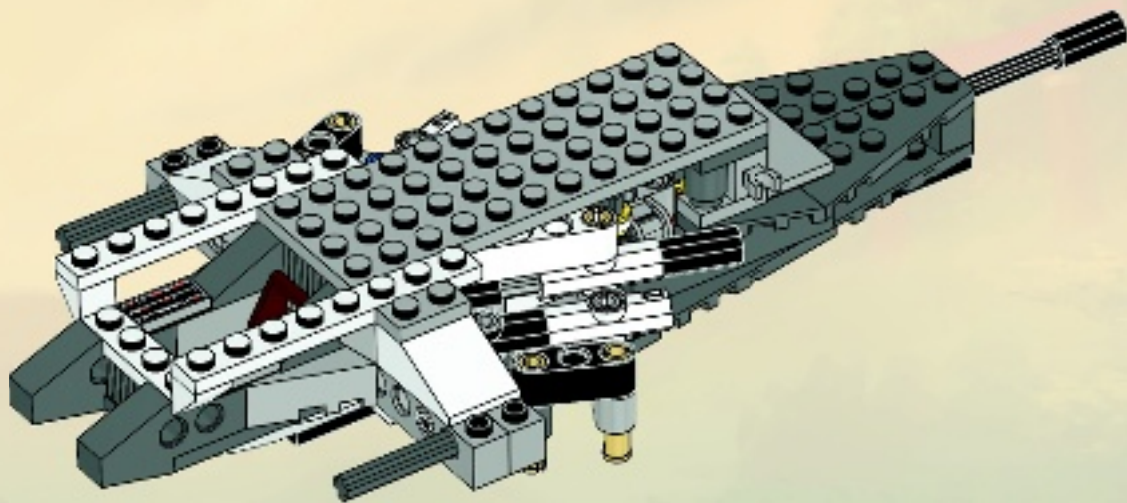

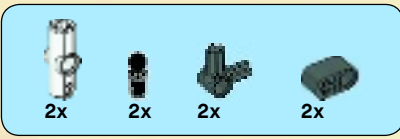

# 31

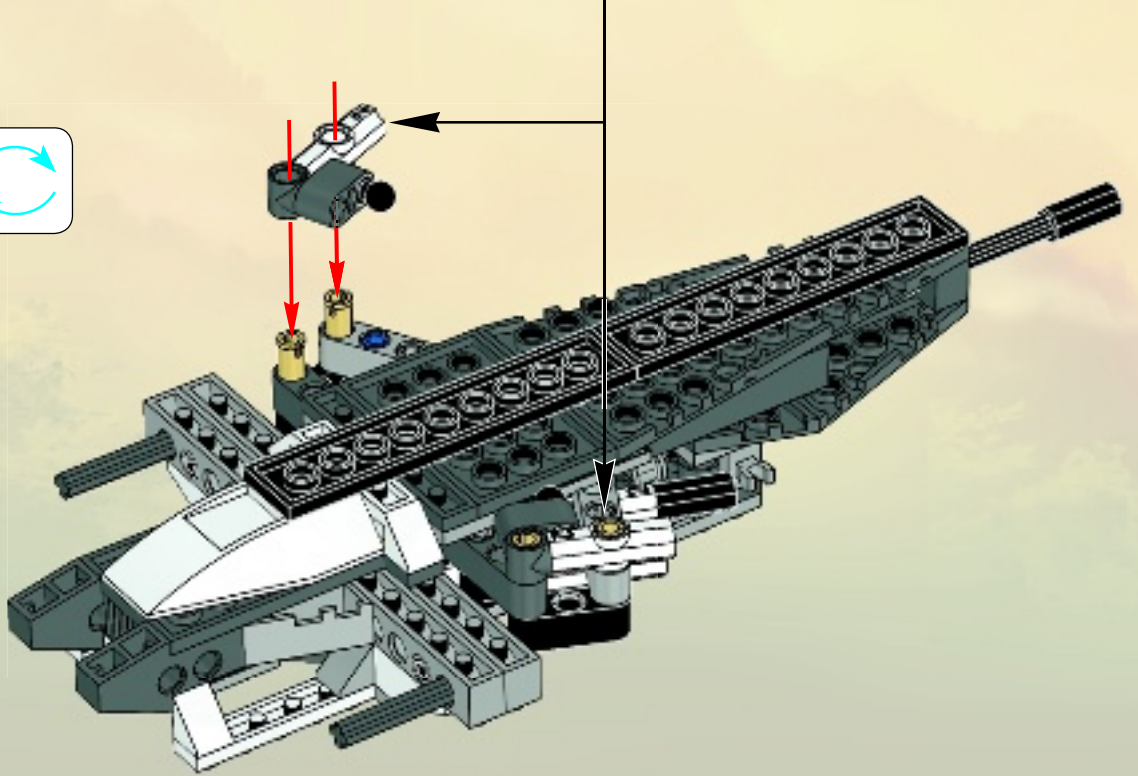
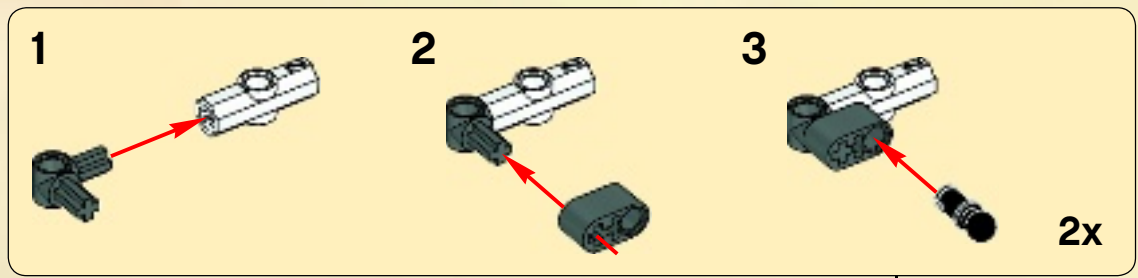



# 32

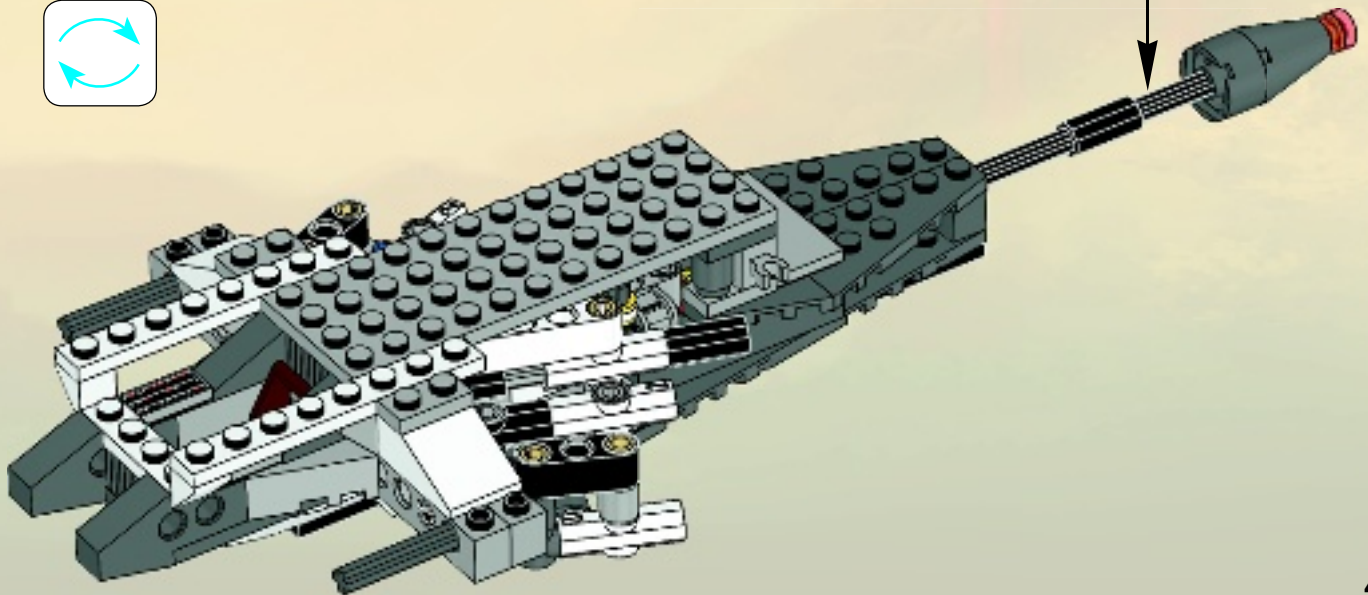
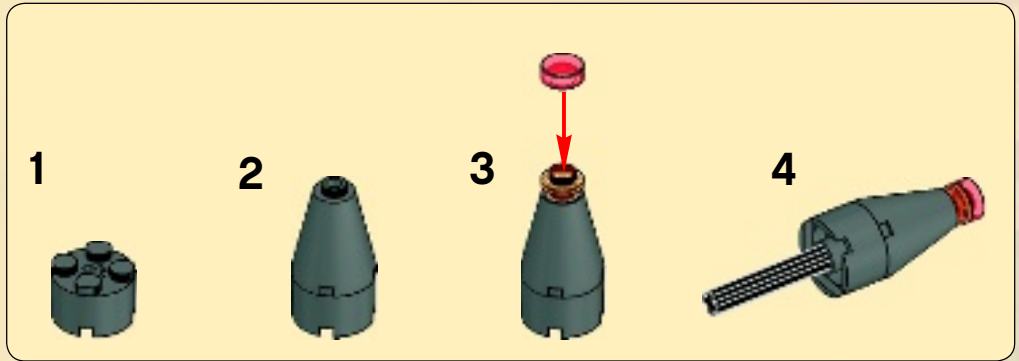

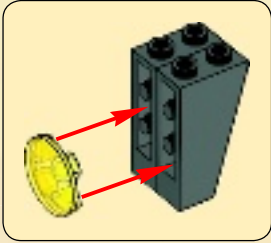
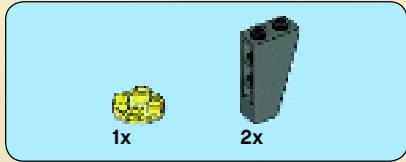
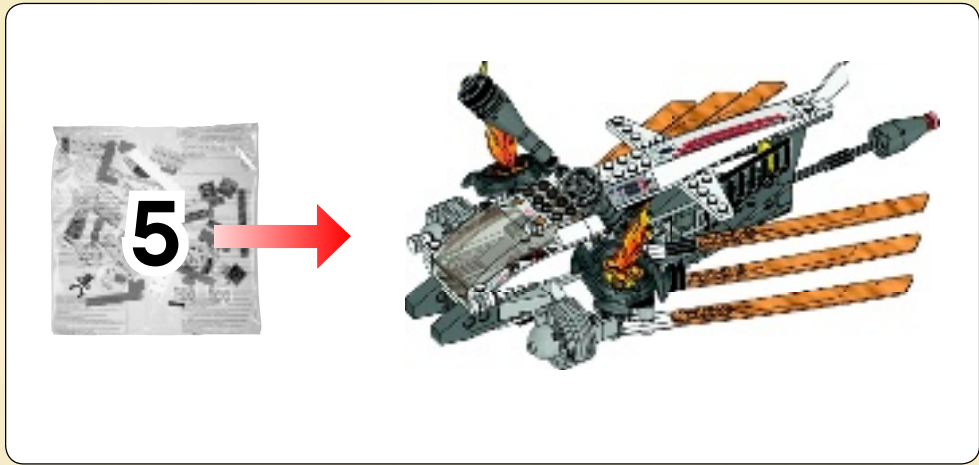

33

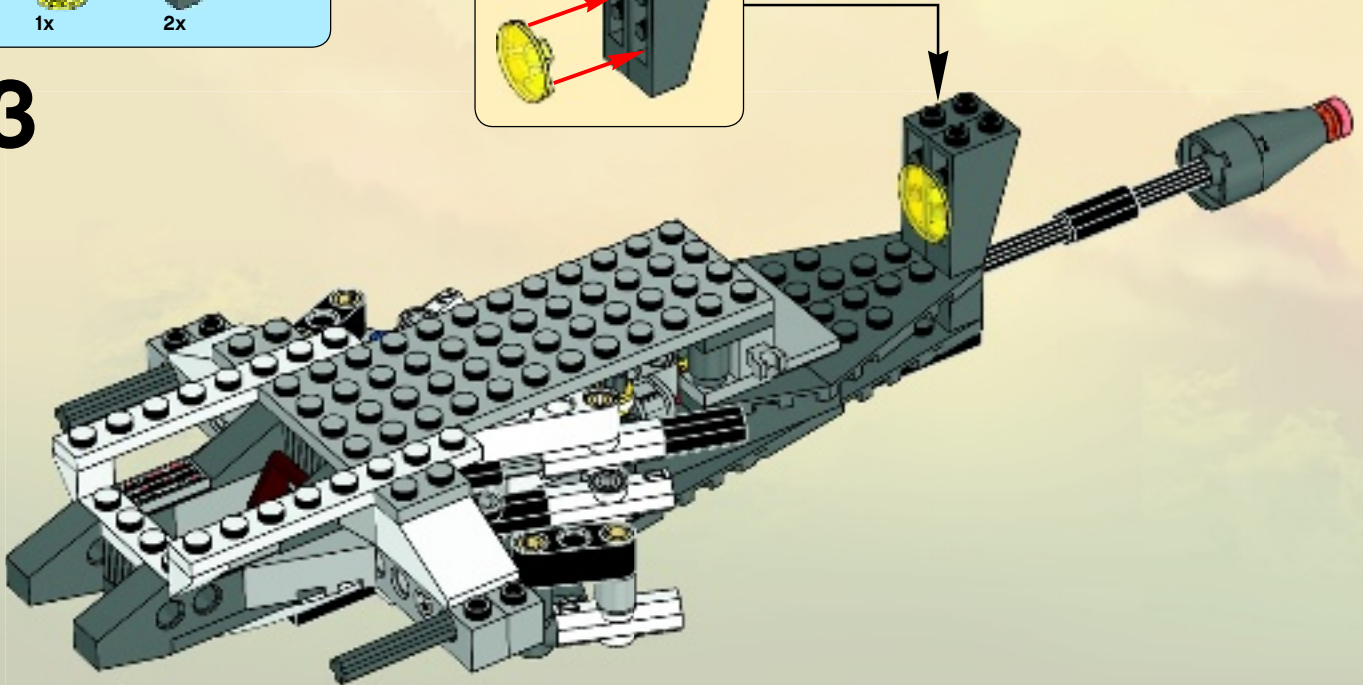

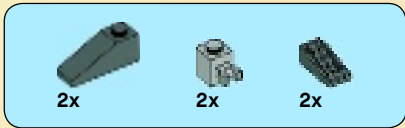

# 34

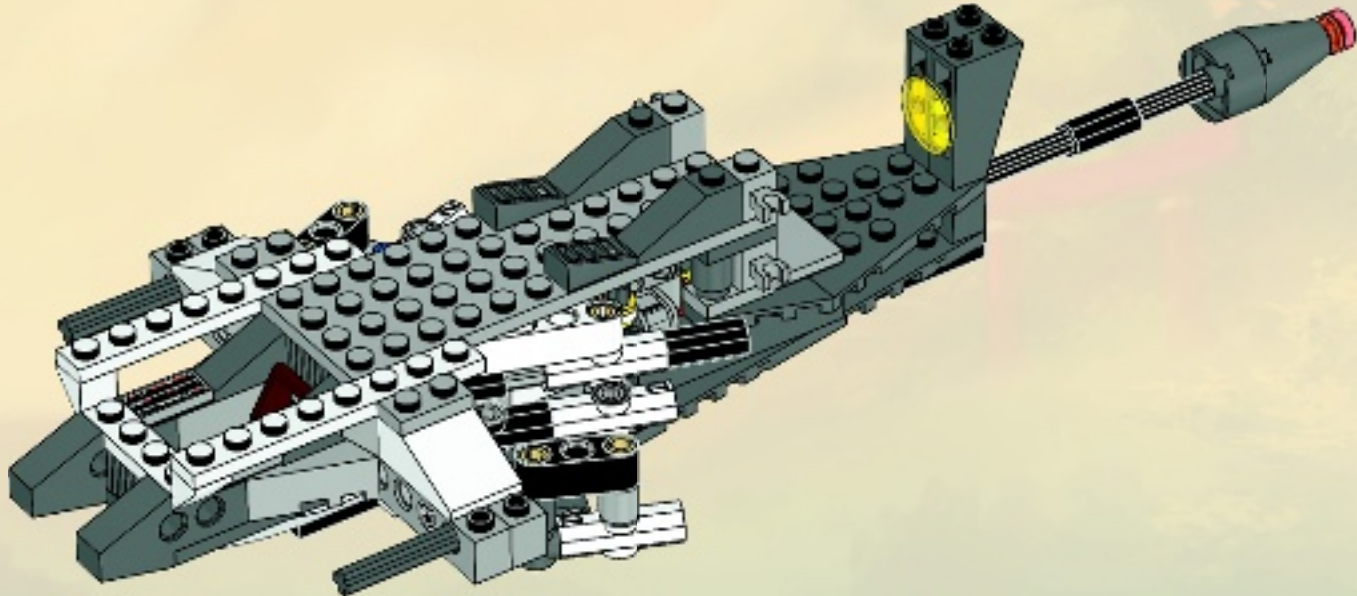

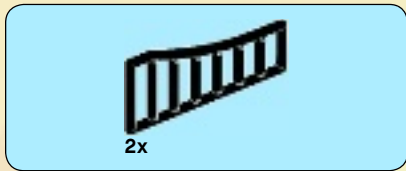

35

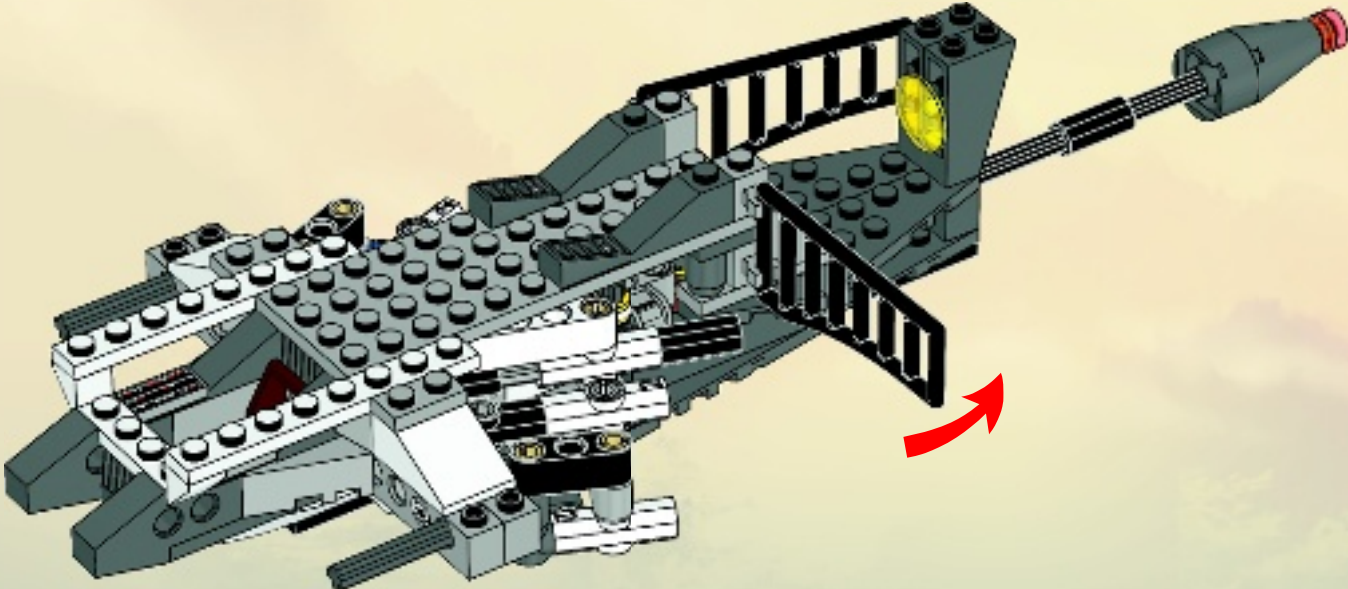

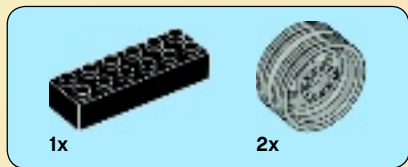

# 36

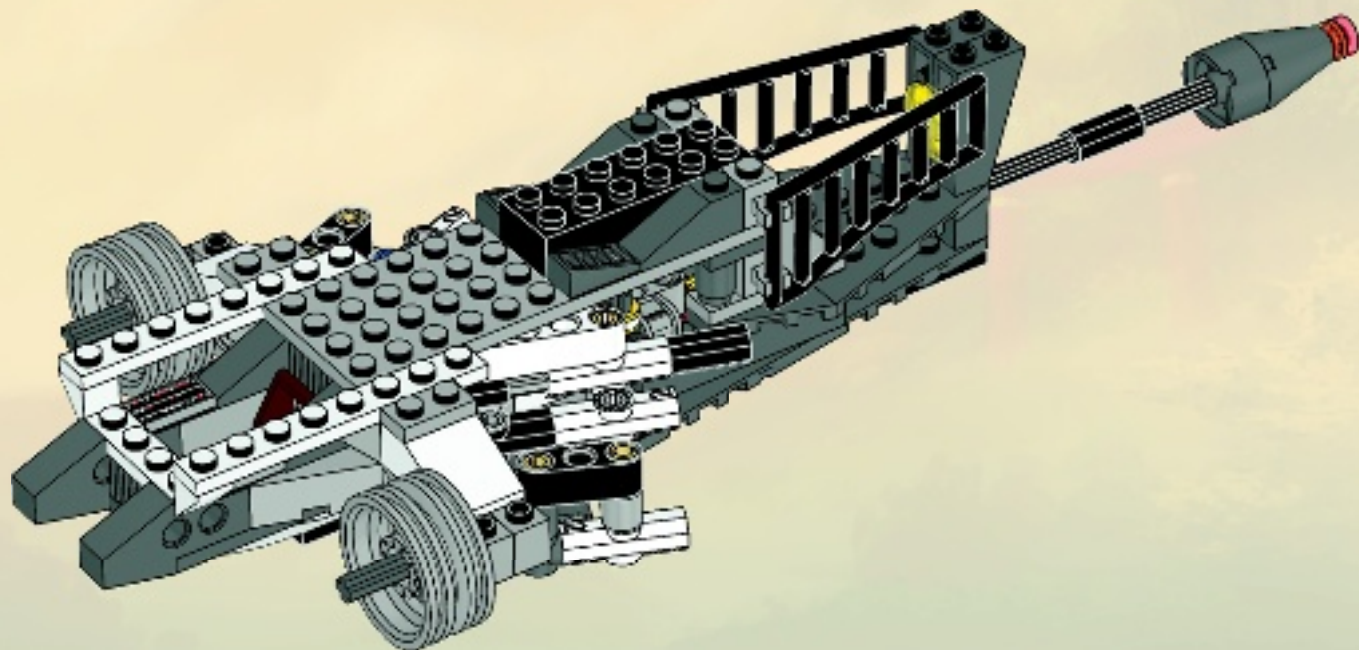



2x



2x



2x

# 37

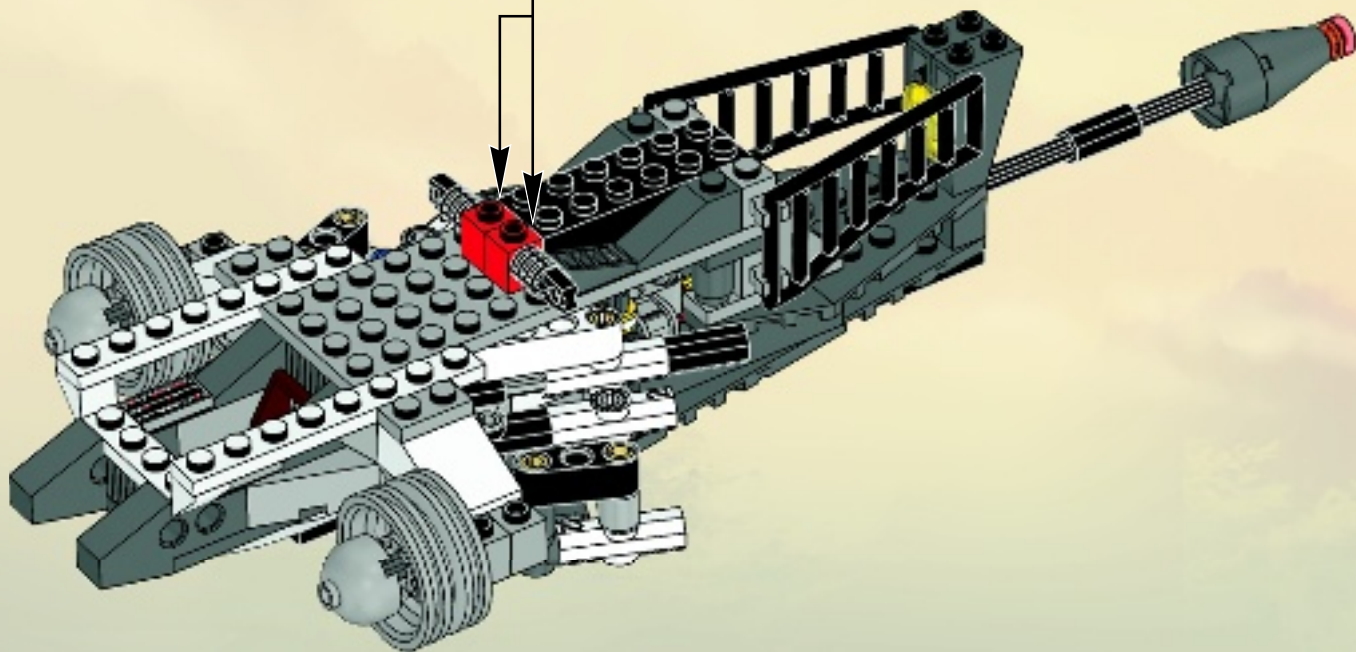
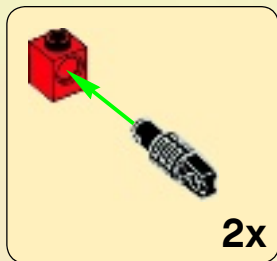



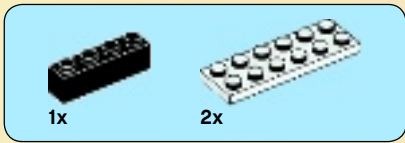

# 38

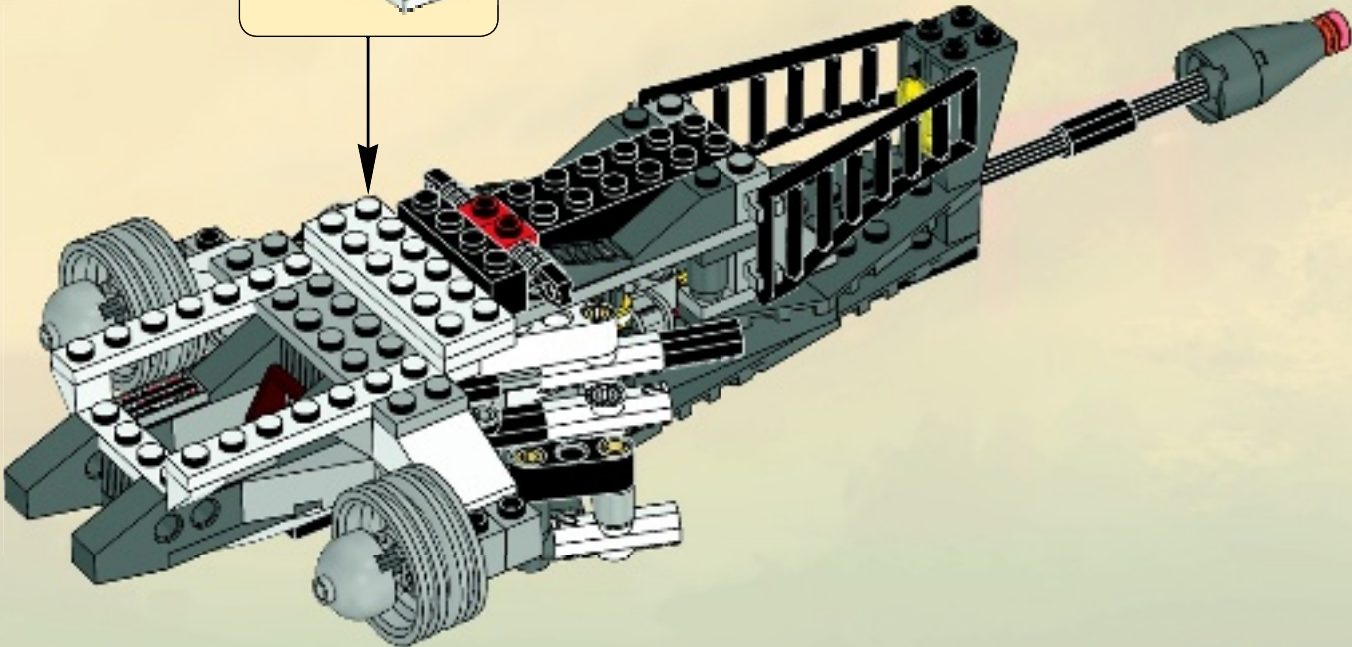
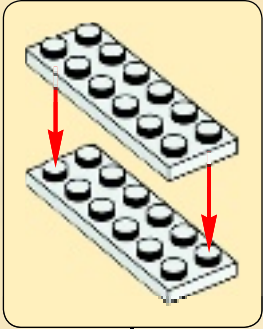



2x



2x



2x

# 39

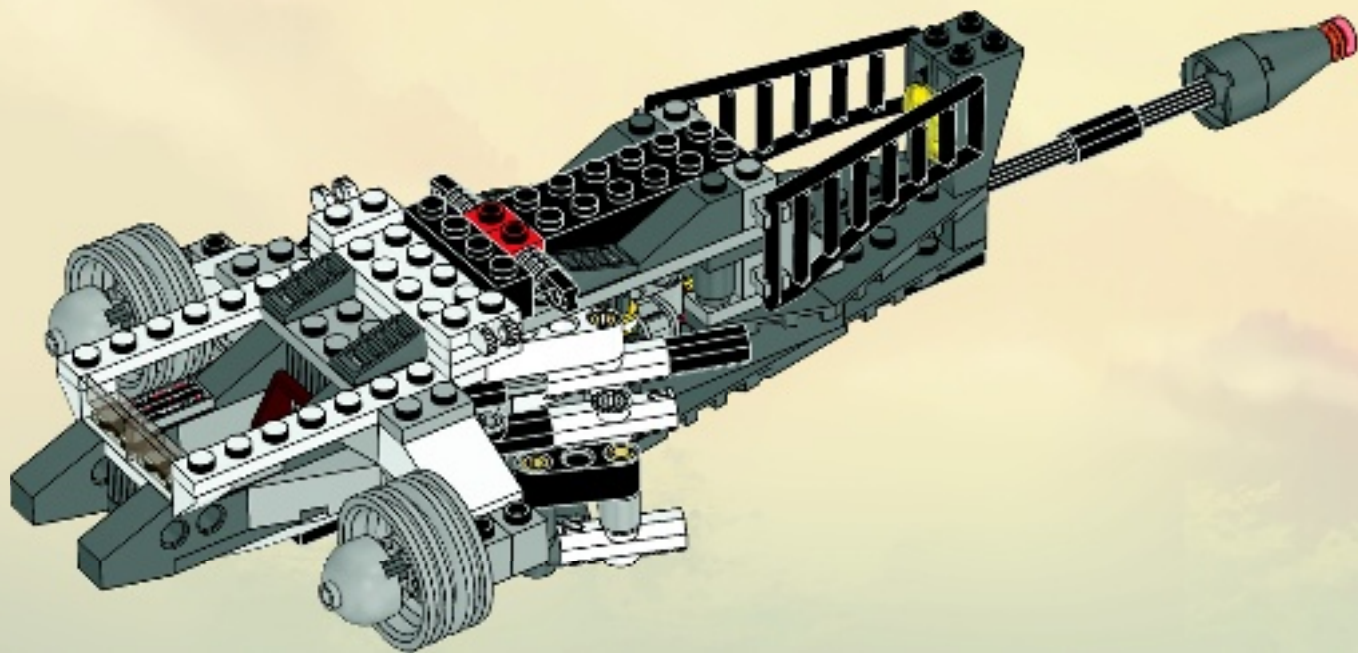

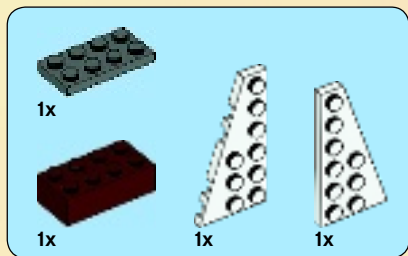

40

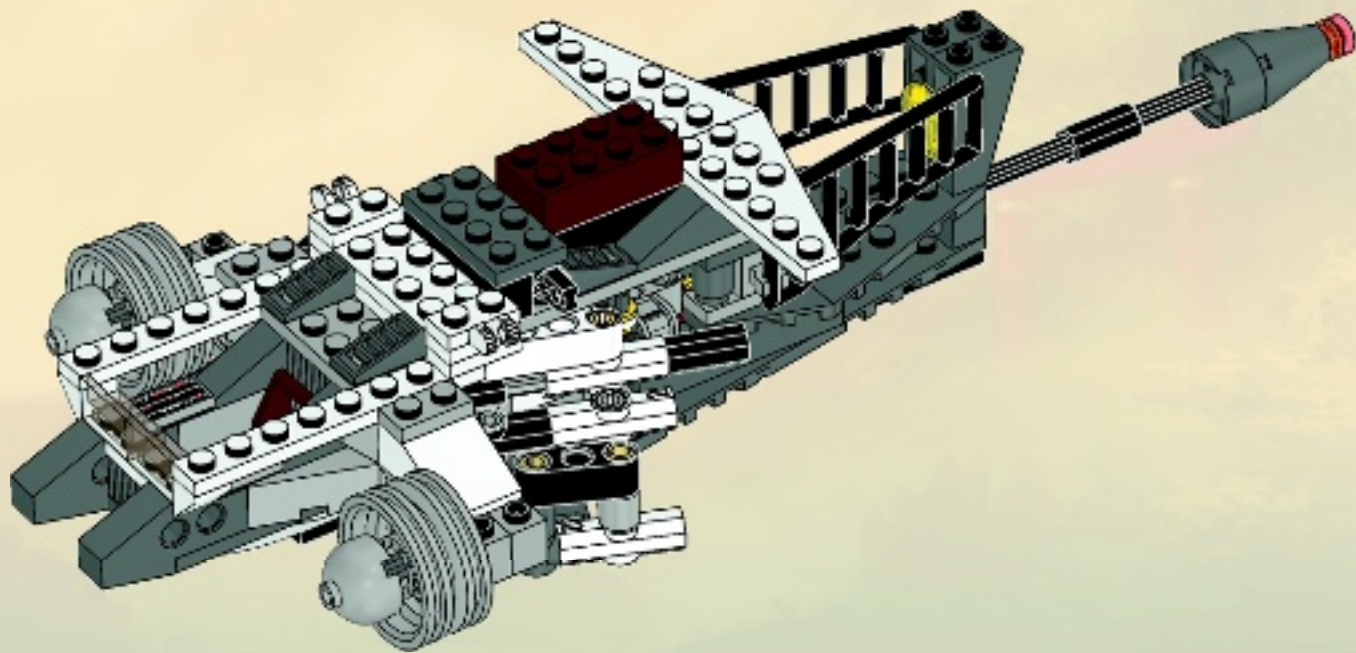



1x



1x



1x

# 41

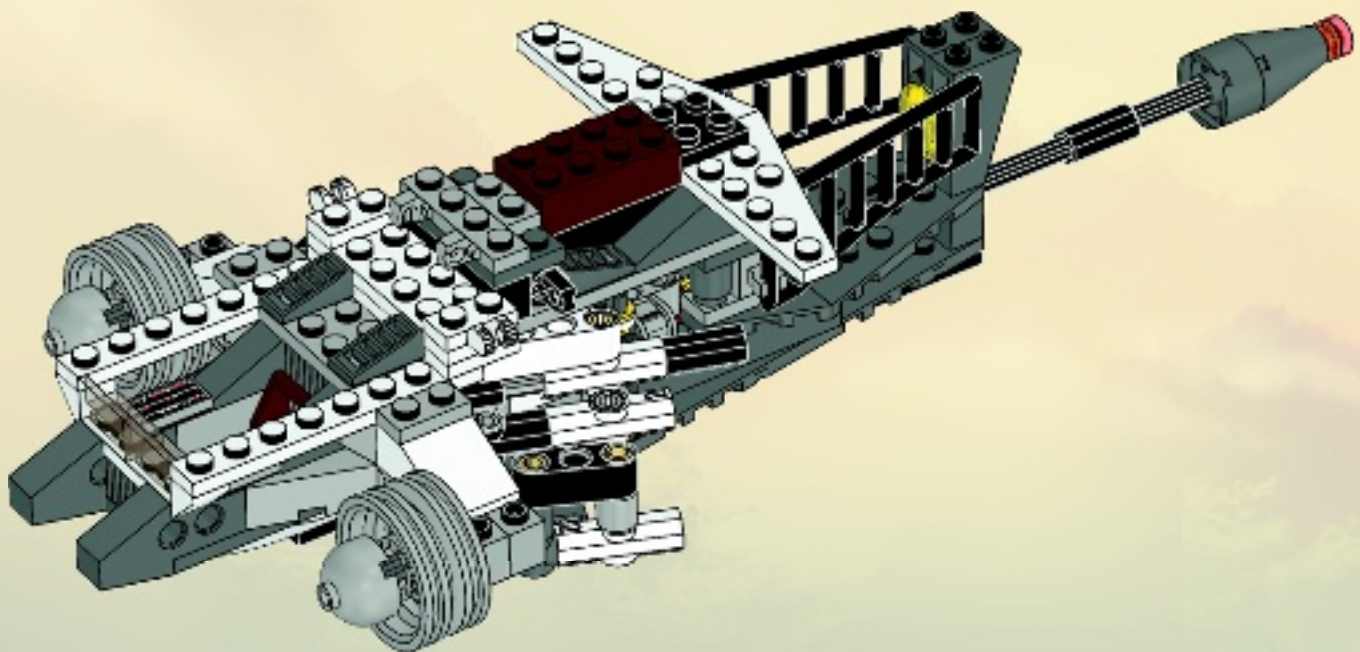

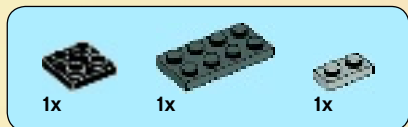

# 42

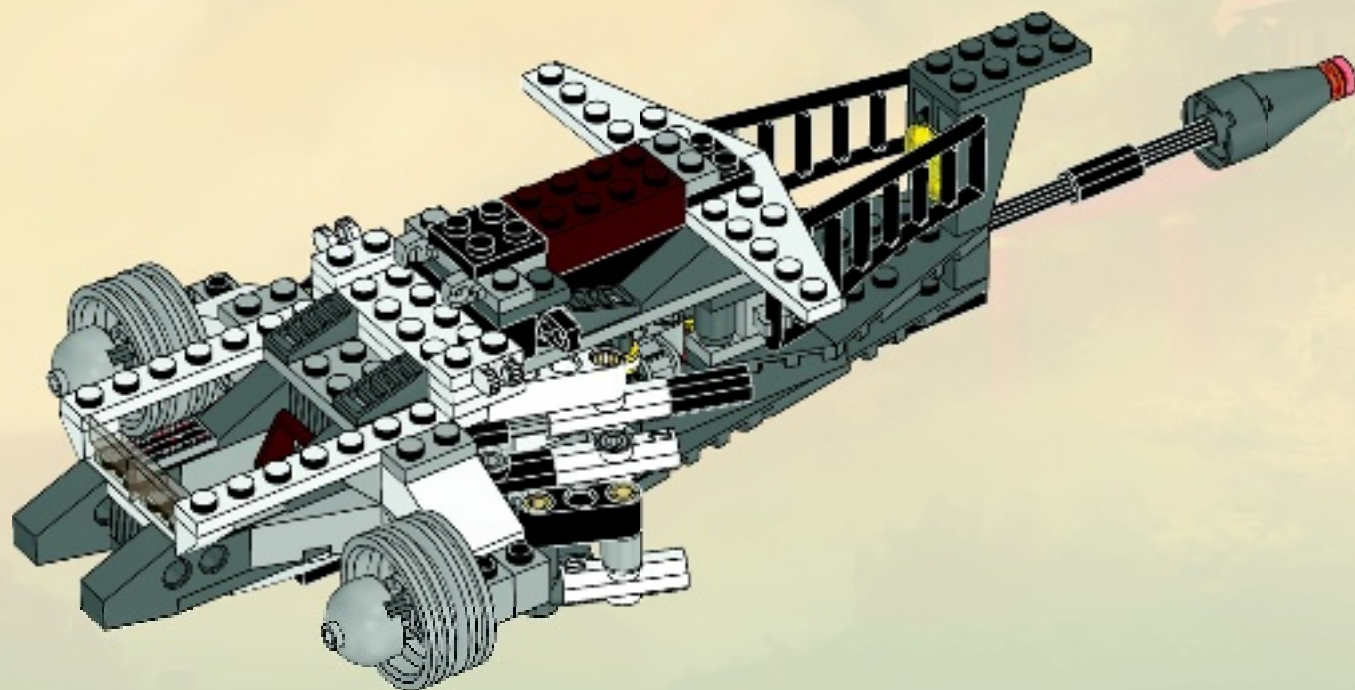

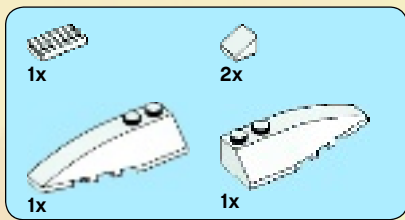

# 43

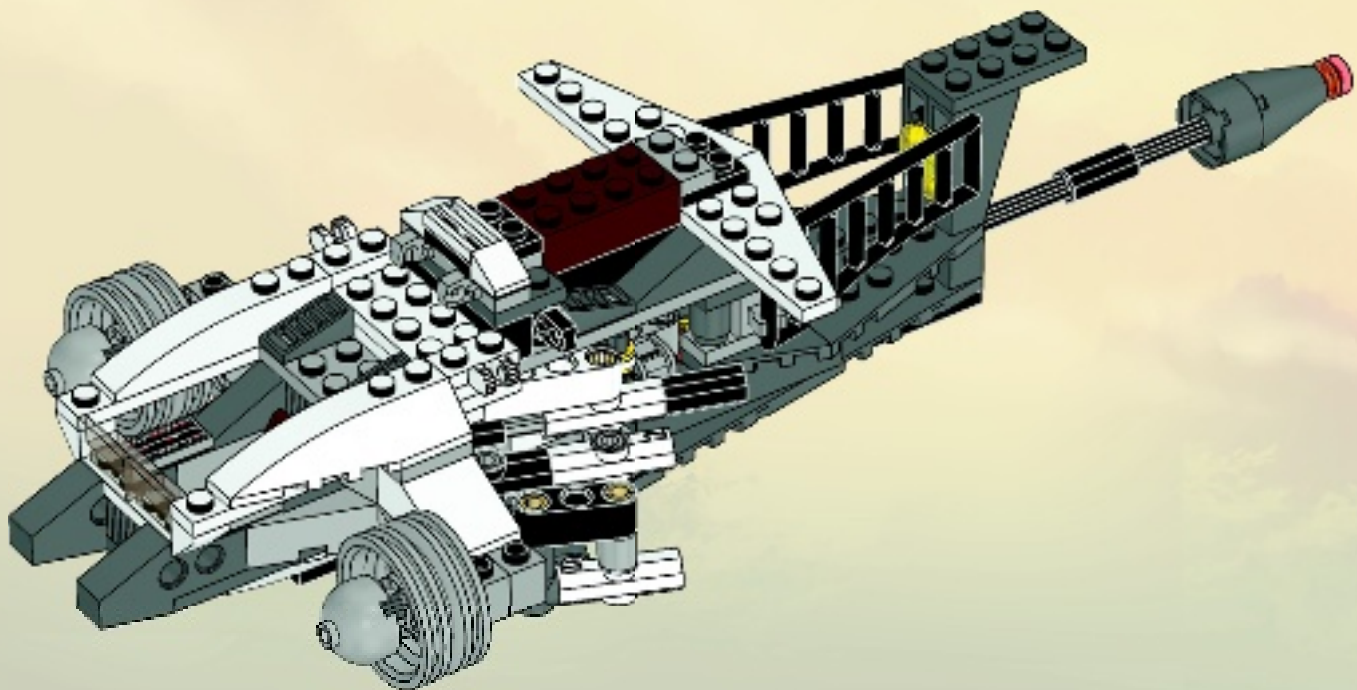

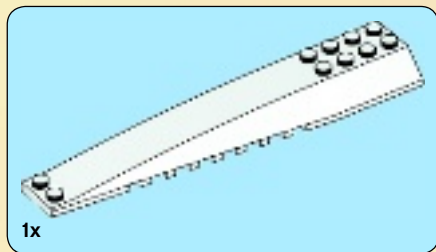

44

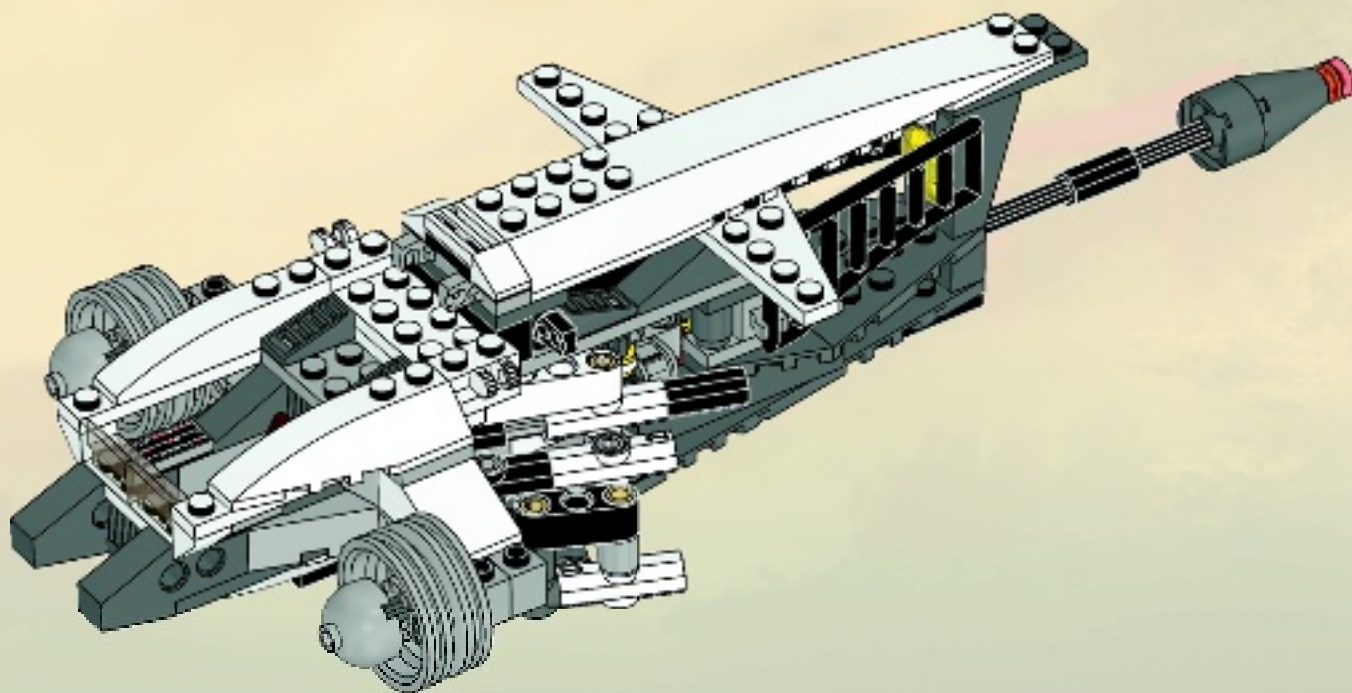



1x

# 45

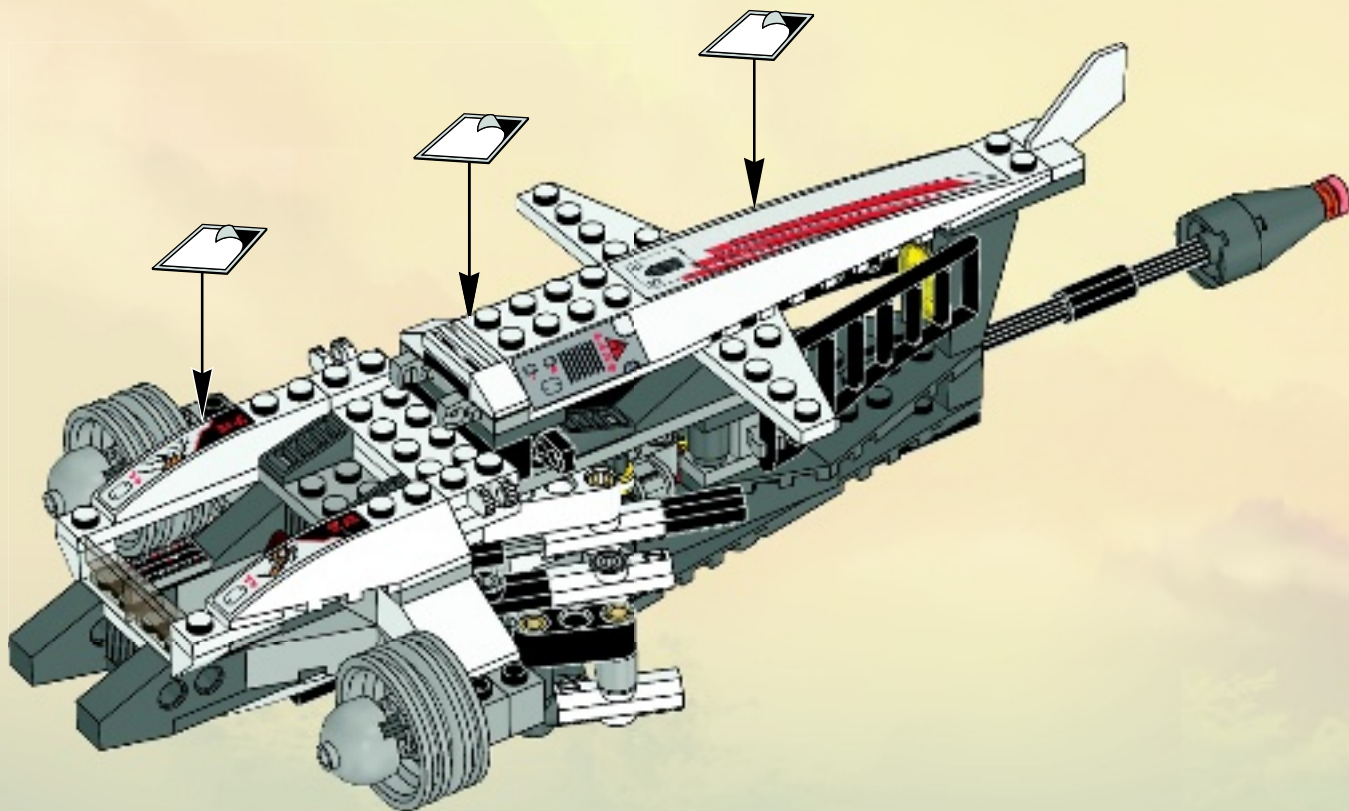



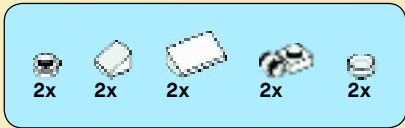

# 46

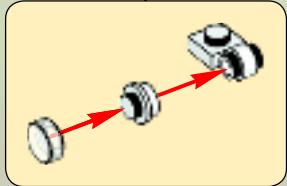
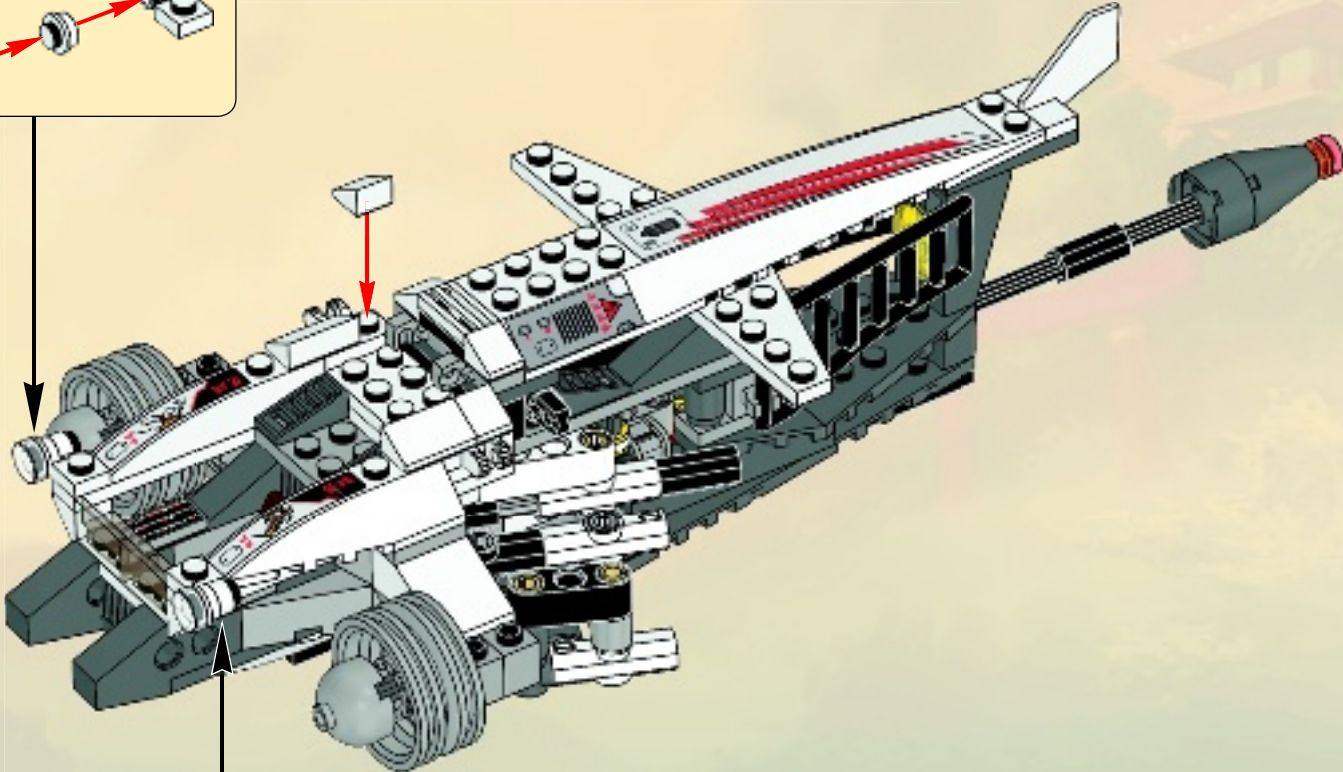
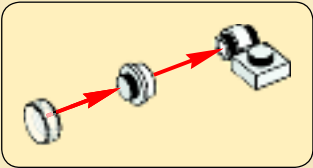

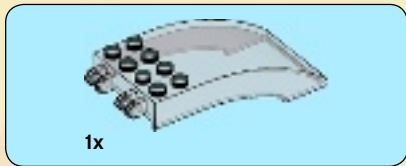

47

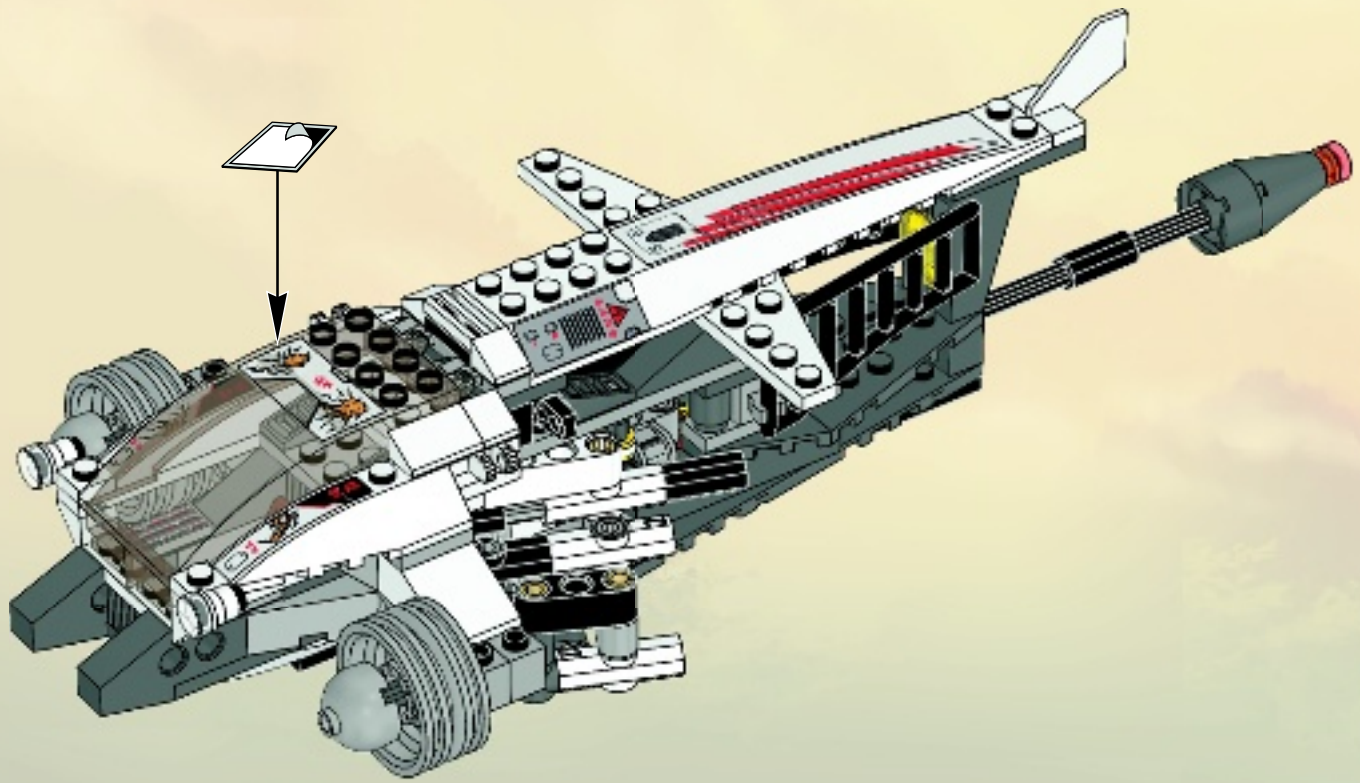



48

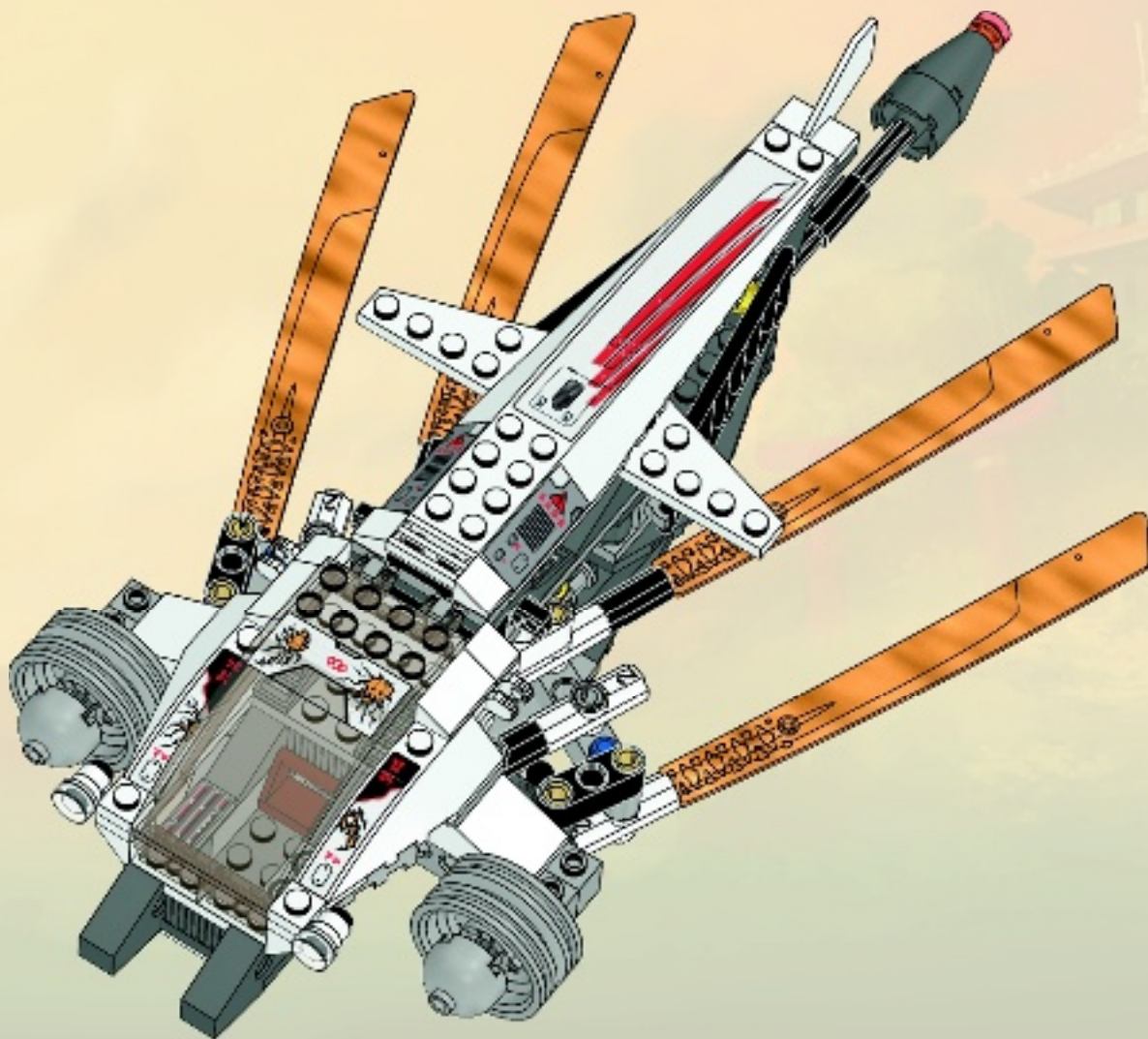



2x

# 49

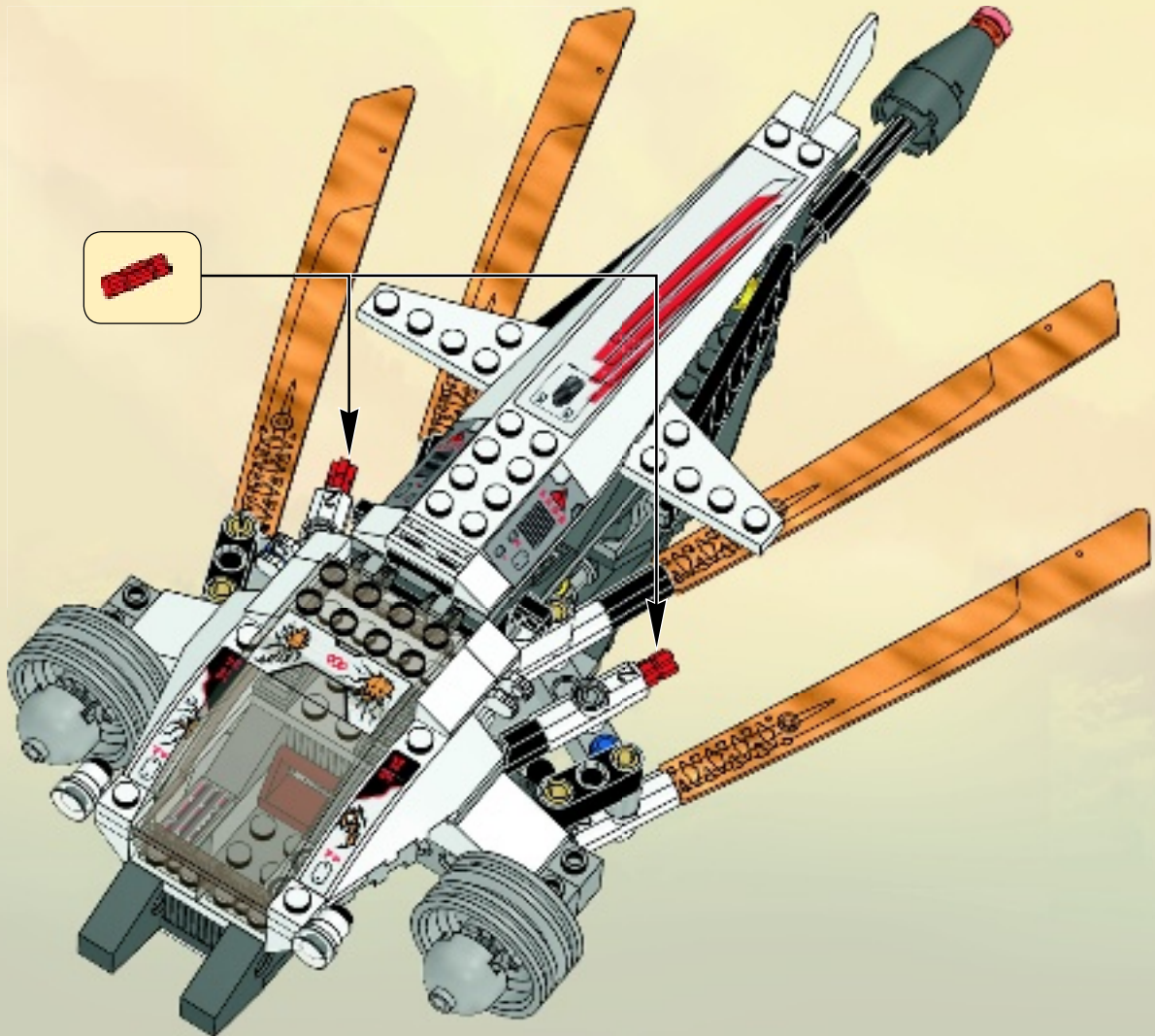



50

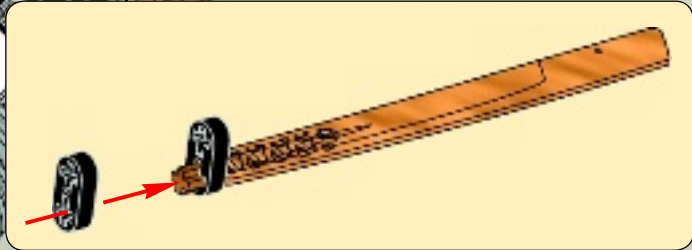
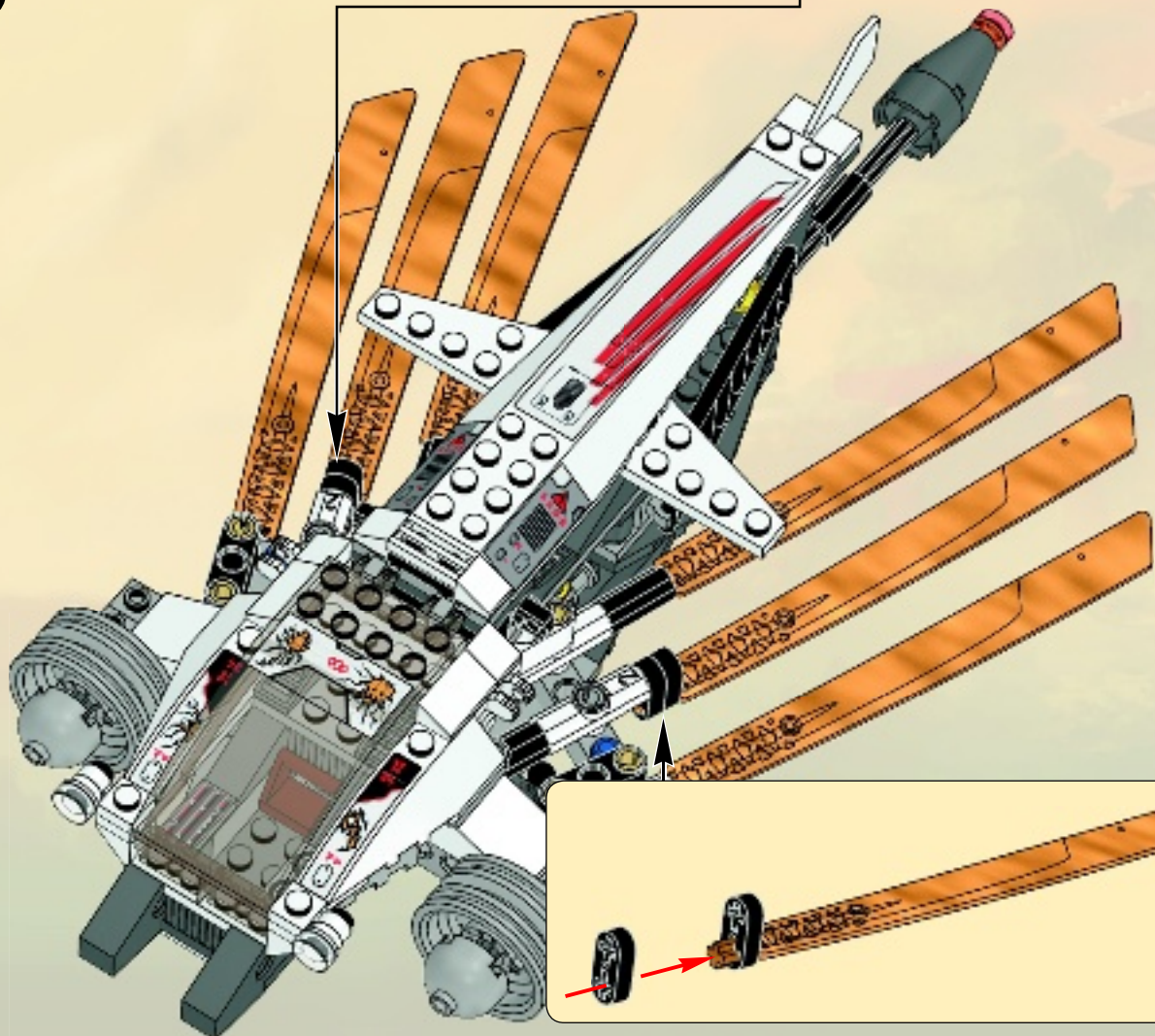
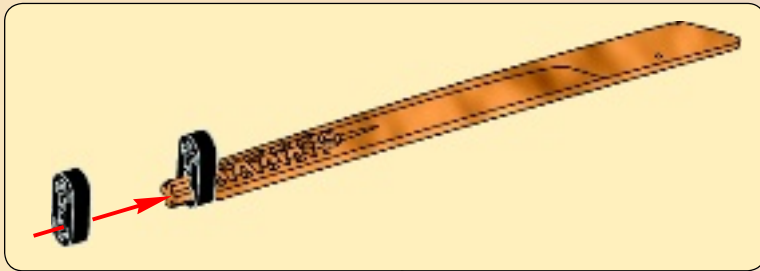

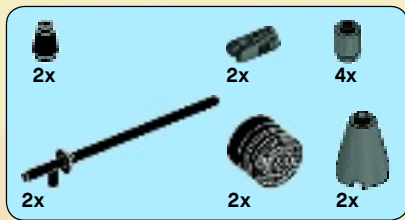

# 51

1



2



3



4



5



2x

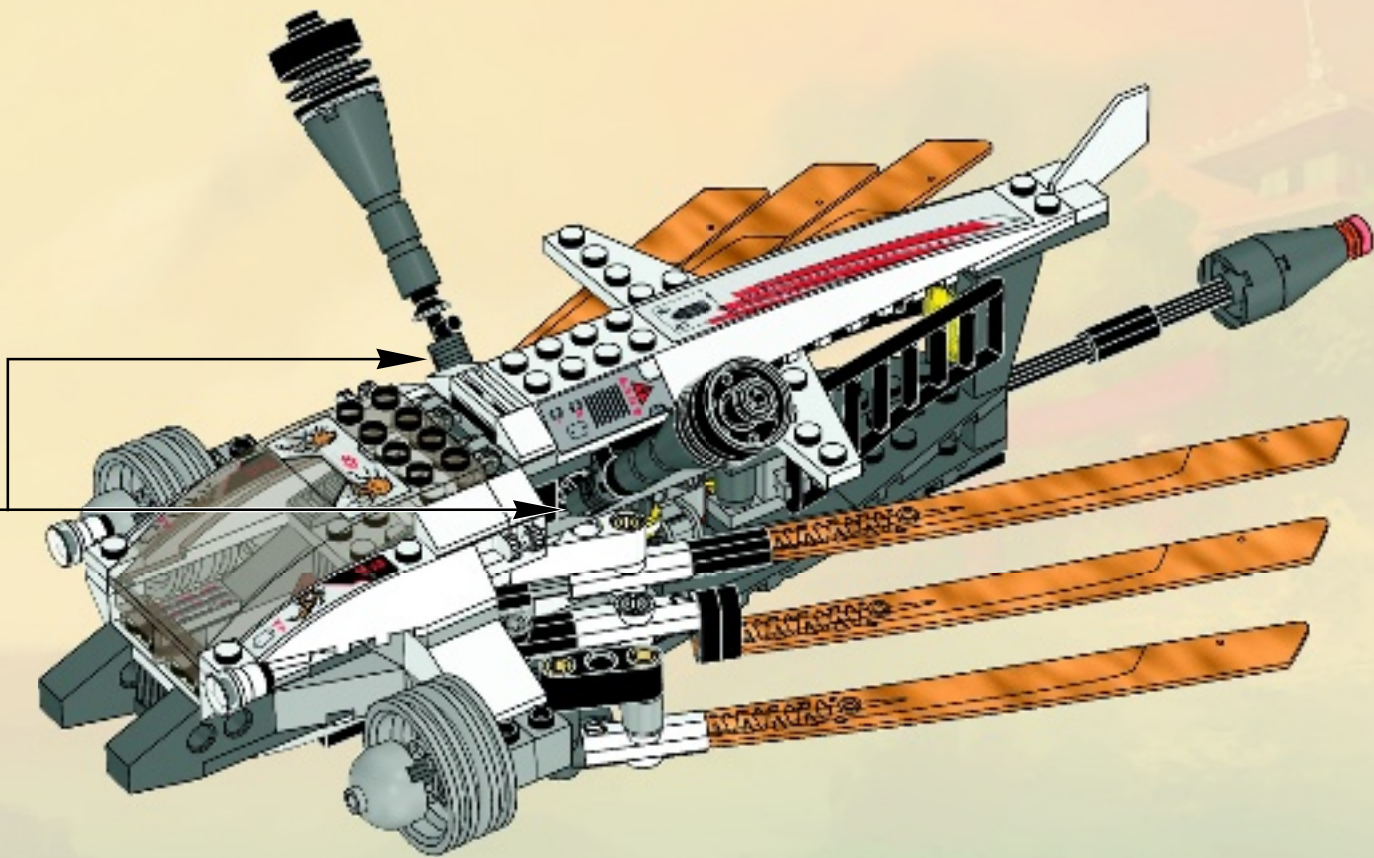



2x



1x

1



1x

2



1x

3



1x

4

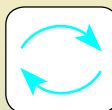





1x

5



4x

6

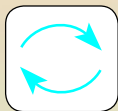

1x

7



2x

52

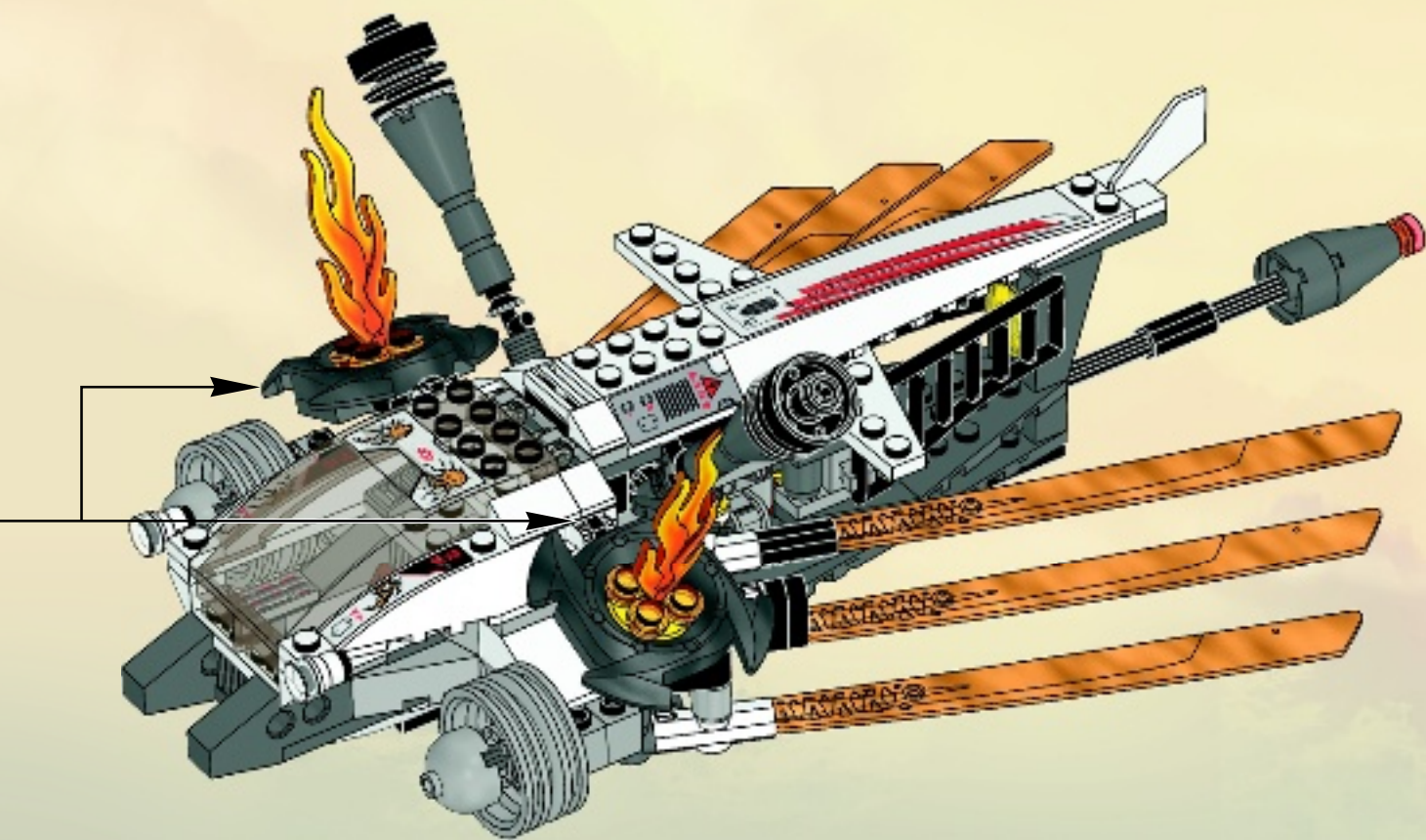

53

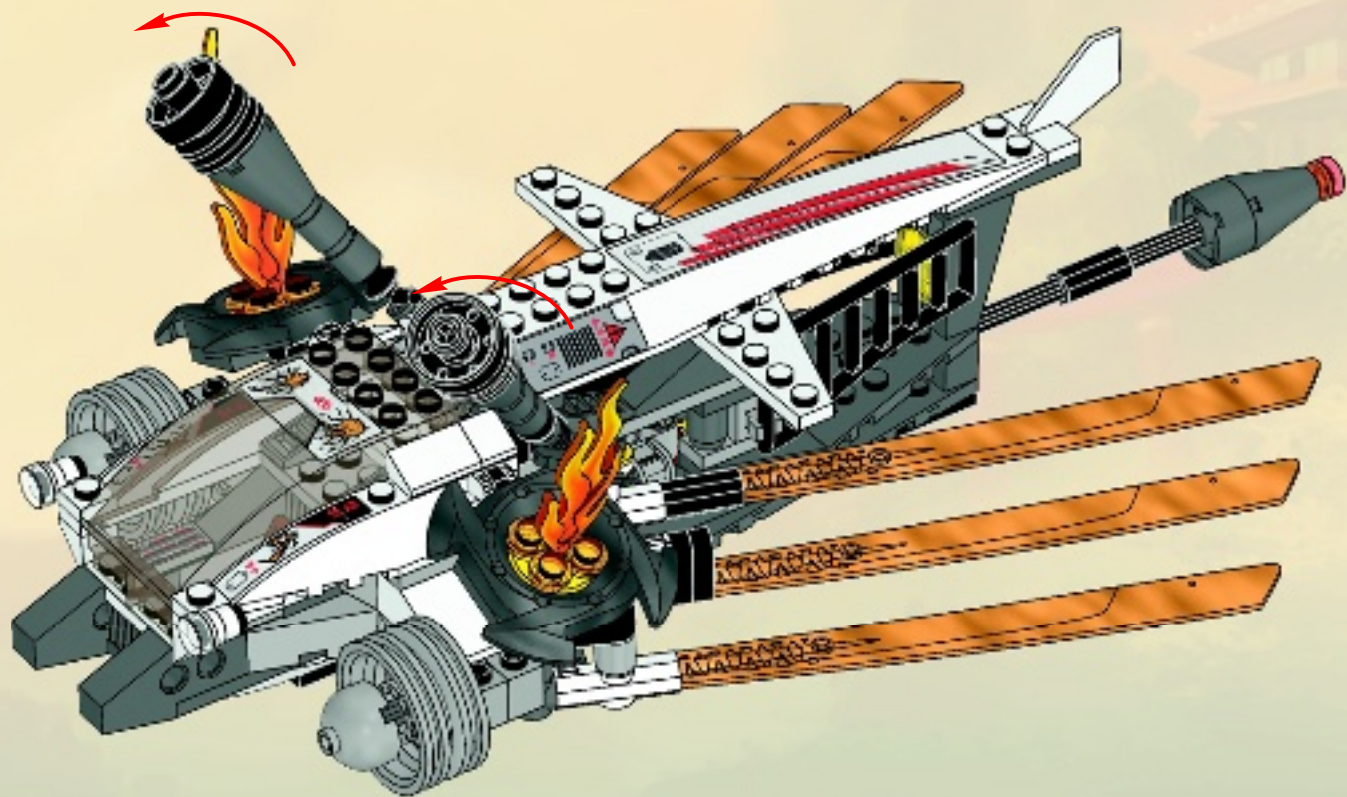

1

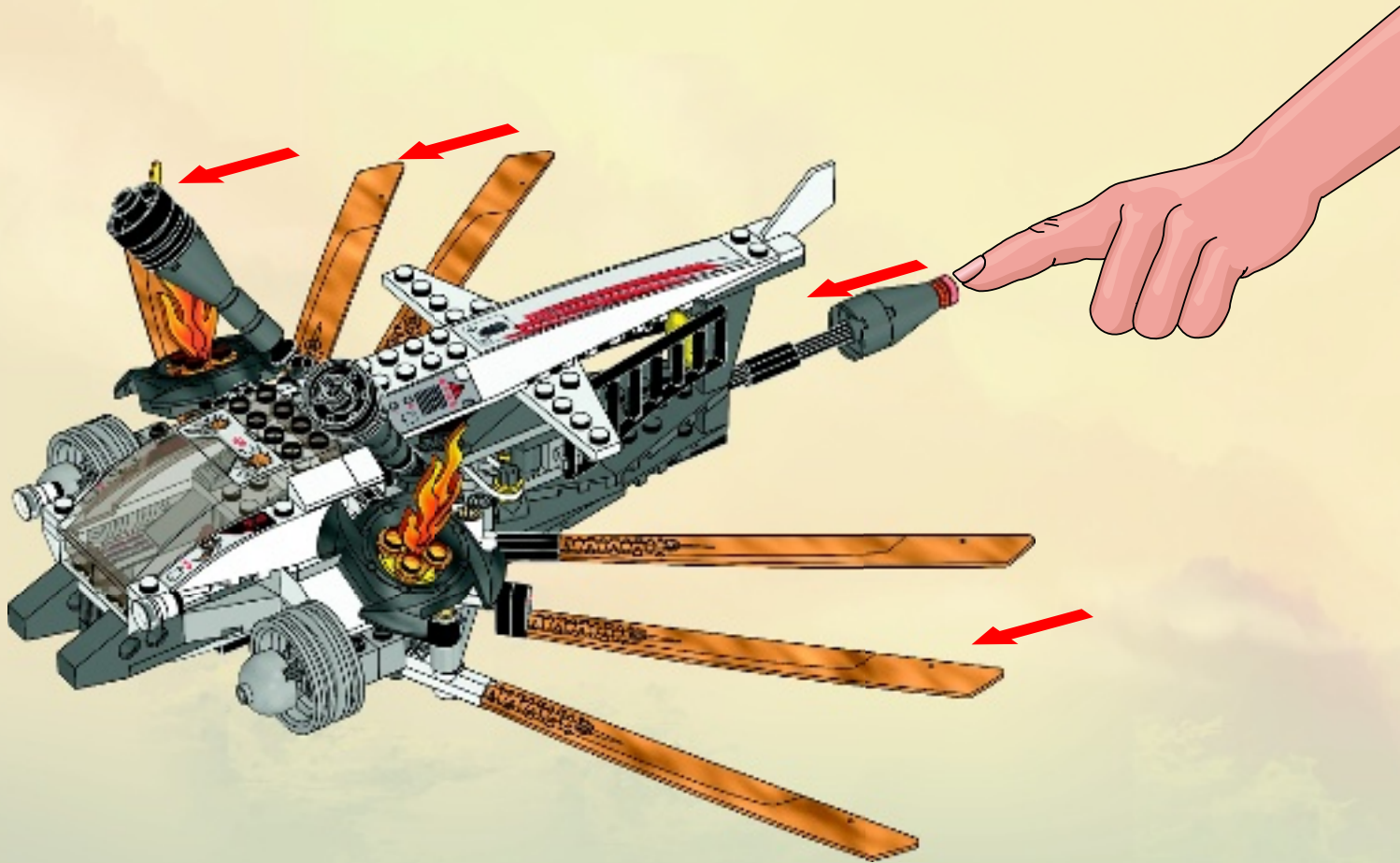



3

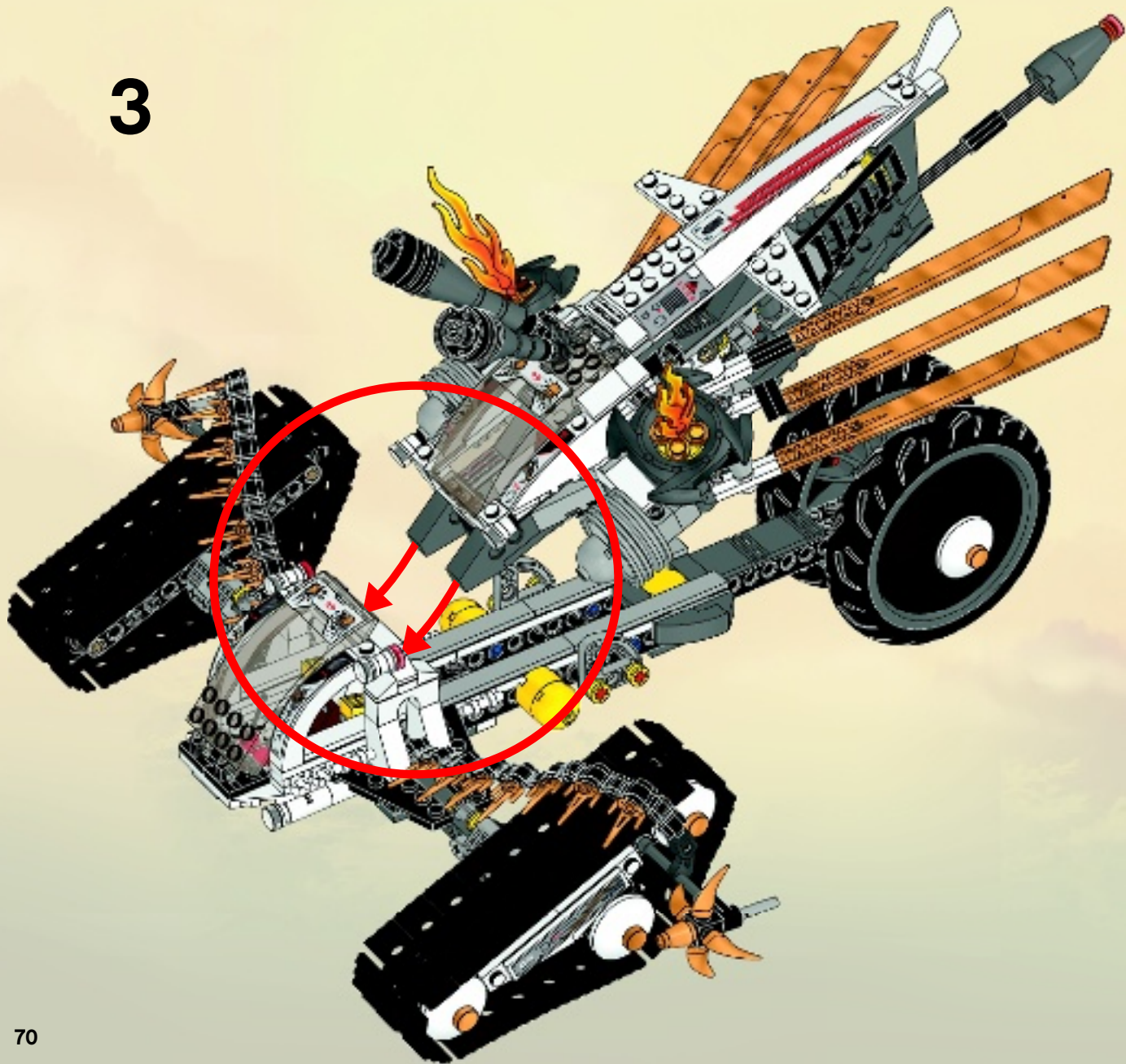

4

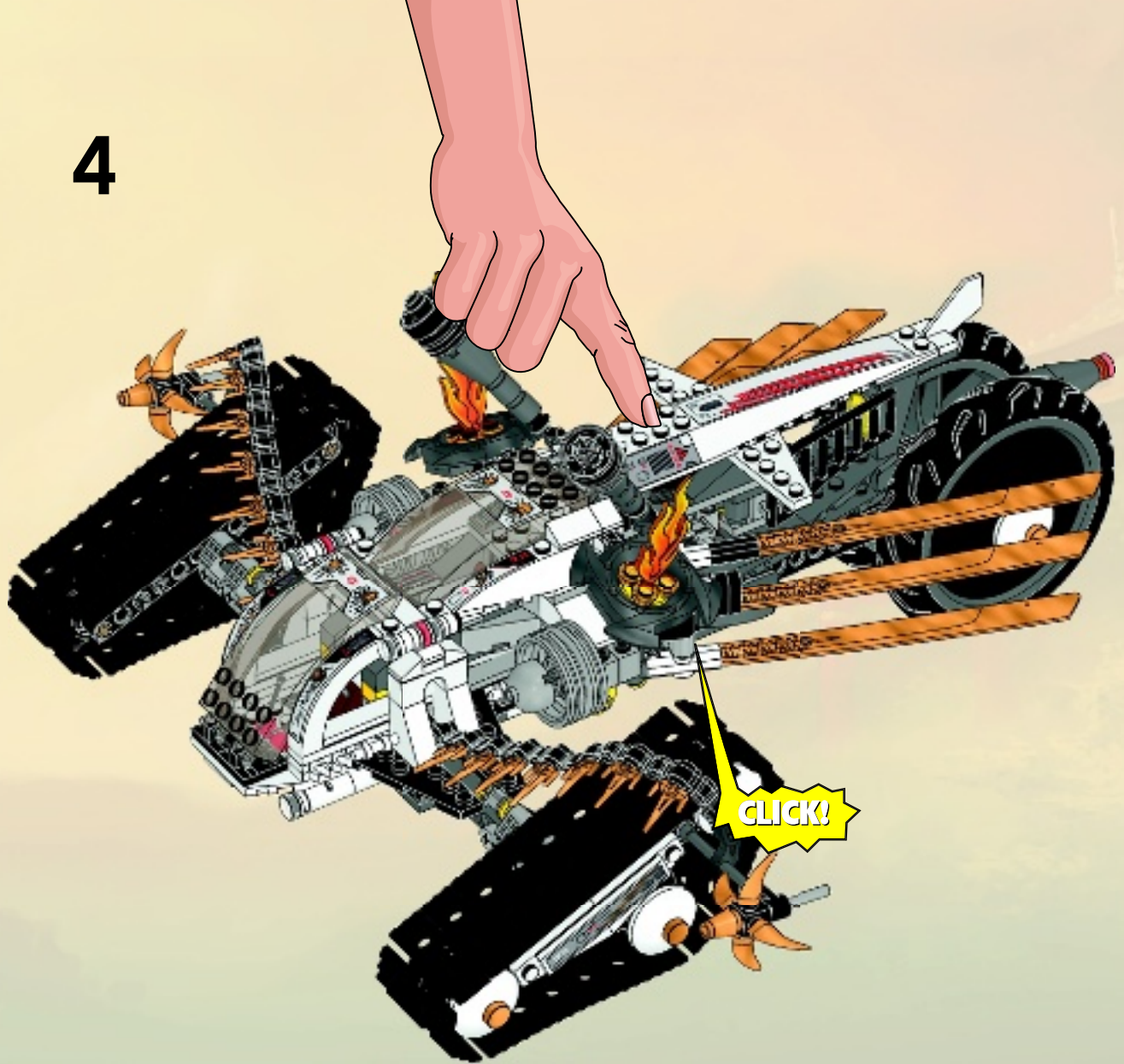

5

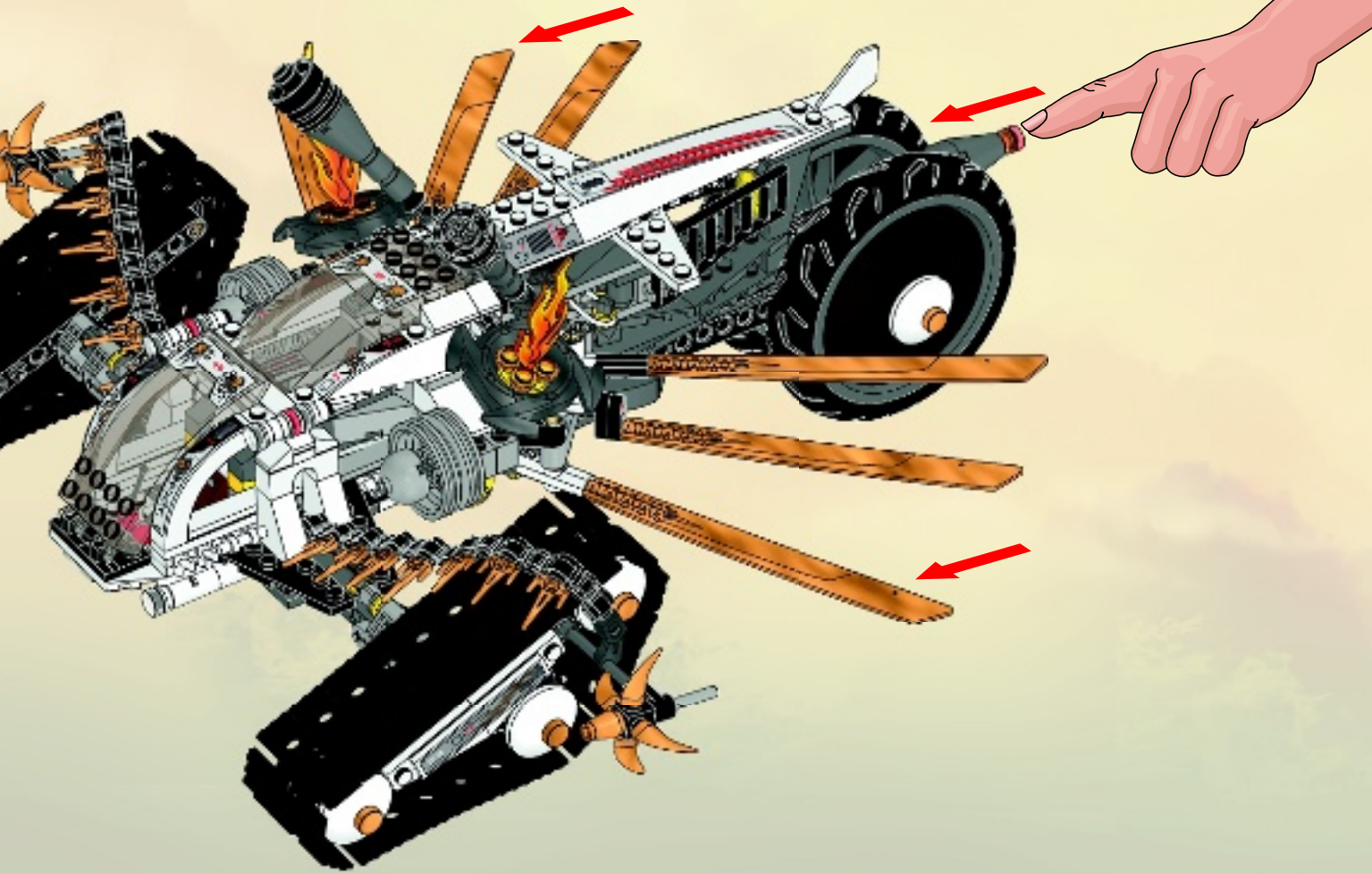



6

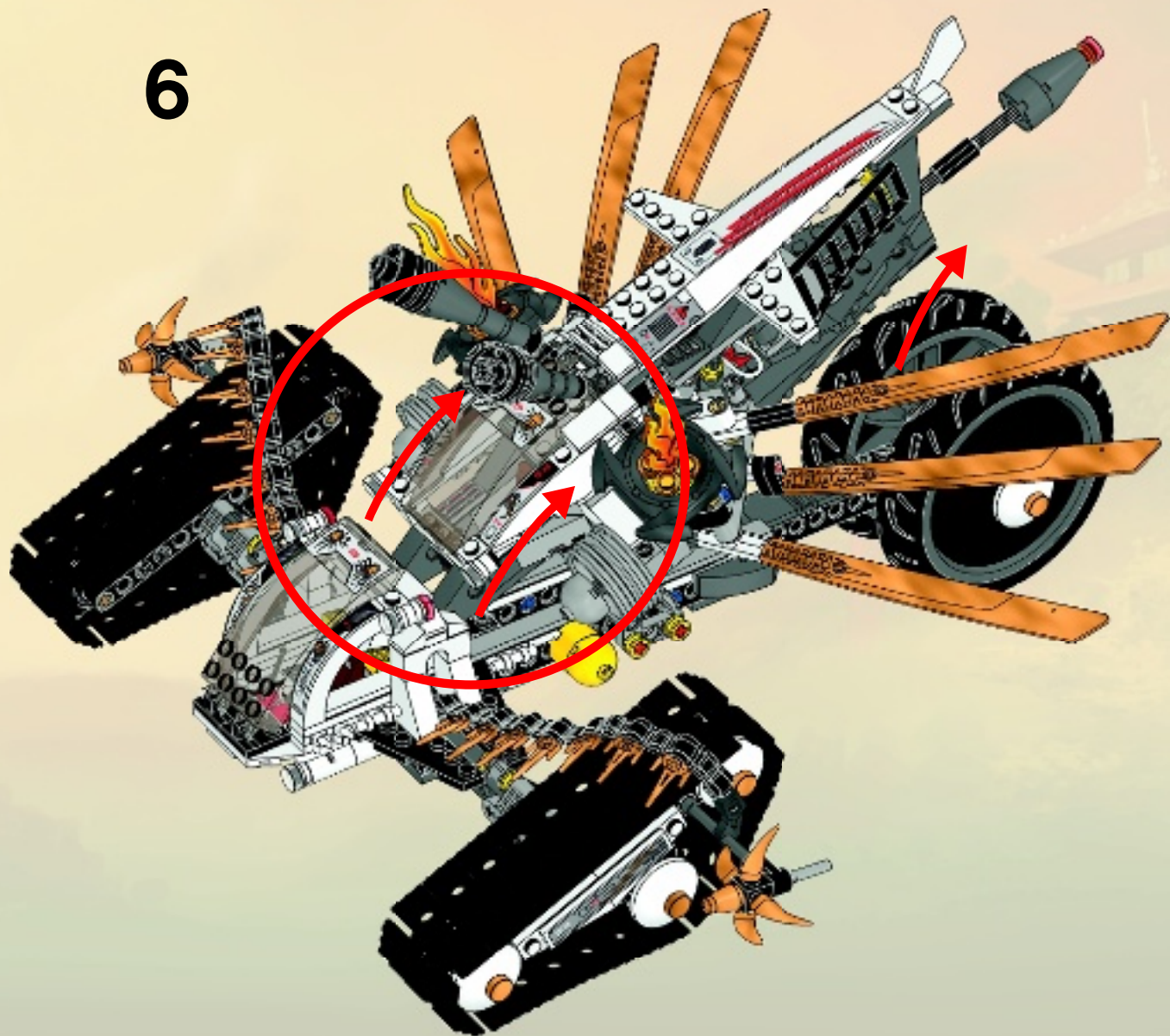



1x  
4109791



10x  
4504369



2x  
4547489



6x  
4515370



2x  
329801



2x  
4259937



2x  
4520970



2x  
4507168



1x  
4160101



1x  
4160124



2x  
4261693



2x  
4160857



1x  
4503223



1x  
4287708



7x  
371001



2x  
379501



5x  
346001



4x  
4613256



4x  
4632566



2x  
4515337



1x  
241201



4x  
4140583



5x  
663601



8x  
614101



2x  
4161326



1x  
4287707



8x  
4179580



1x  
4508408



1x  
4650494



1x  
4650130



1x  
4650119



1x  
4288960



1x  
4544140



2x  
4249021



6x  
4125554



4x  
4526981



10x  
4514554



2x  
654121



1x  
241221



4x  
403221



2x  
74335



1x  
4650487



1x  
4650128



1x  
4650117



1x  
4173975



13x  
4142865



1x  
4650492



1x  
4650129



1x  
4650118



14x  
4143005



6x  
4206482



2x  
4514553



1x  
300424



2x  
4216656



2x  
614324



1x  
415024



2x  
4141630



2x  
403224



6x  
4169960



1x  
4611426



1x  
4611427



1x  
4611429



1x  
4611424



2x  
4540384



10x  
4239601



1x  
4107800



1x  
301026



1x  
4181144



2x  
473326



2x  
4529236



2x  
370026



2x  
4529549



1x  
273026



4x  
370326



2x  
302226



2x  
383226



2x  
4185620



2x  
4613759



2x  
4251393



2x  
4251394



2x  
4620385



1x  
4650495



1x  
4650131



2x  
4114206



2x  
384926



1x  
4650120



2x  
4517737



2x  
4159335



2x  
4142822



4x  
4522933



2x  
4497946



4x  
4164133



2x  
4567999



2x  
4184169



10x  
4107085



8x  
4109810



18x  
4121715



3x  
4512363



4x  
4140801



1x  
370626



1x  
370826



6x  
4662228



2x  
4652060



6x  
4650498



1x  
4653402



3x  
4646864



2x  
4548009



1x  
4278415



1x  
4654448



2x  
4200798



2x  
4199601



2x  
4183133



1x  
6001078



1x  
4647769



6x  
4566927



1x  
6016732



9x  
4222960



1x  
4211201



2x  
4211219



4x  
4533772



2x  
4211637



1x  
4526932



1x  
4527767



2x  
4211541



2x  
4211705



2x  
4211614



2x  
4211437



2x  
4217918



6x  
4211398



1x  
4211401



1x  
4212363



1x  
4654046



3x  
4211365



2x  
6014615



1x  
4211840



5x  
4560183



4x  
4211481



1x  
4585429



1x  
4539481



2x  
4541318



2x  
4520320



2x  
4495930



2x  
4538007



2x  
4531184



4x  
4630114



4x  
4211622



8x  
4211807



4x  
4211888



2x  
4211815



1x  
4535768



1x  
4611880



3x  
4211100



2x  
4210636



6x  
4211090



1x  
4249139



3x  
4211108



1x  
4211111



2x  
4273814



2x  
4621917



2x  
4500975



4x  
4211045



2x  
4246896



6x  
4211133



2x  
4598769



7x  
4211065

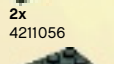

2x  
4211056



1x  
4243831



2x  
4211115



1x  
4211061



2x  
4538721



2x  
4210631



2x  
4211055



1x  
4210872



1x  
4210869



2x  
4278274



1x  
4290149



1x  
4586562



1x  
4290150



1x  
4209014



2x  
4538721



4x  
4540386



2x  
4210695



2x  
6006141



4x  
6005331



2x  
4560177



2x  
4499858



2x  
4568006



3x  
4603472



1x  
4650894



1x  
6001079



1x  
6009199



2x  
4529247



8x  
4649422



1x  
4600267



1x  
4626501



3x  
4640843



2x  
4600519



14x  
4646866



2x  
4646814



9x  
4611904



1x  
4600501



2x  
6005671



46x  
6003879



2x  
4612900



2x  
4646815



1x  
4617190



2x  
6008484



2x  
4647381



6x  
4646835



Customer Service

Kundenservice

Service Consommateurs

Servicio Al Consumidor

LEGO.com/service or dial



00800 5346 5555 :



1-800-422-5346 :



LEGO

# NINJAGO

Masters of Spinjitzu



9449



9448



9447



9450



9450



9449



9448



9447



# NINJAGO

Masters of Spinjitzu

## CUSTOMISE YOUR SPINNERS

BAUE DEINE EIGENEN, VERÄNDERBAREN SPINNERS • PERSONALISE TES TOUPAJES • PERSONALIZA TUS SPINNERS  
PERSONALIZA AS TUAS RODAS • TEDO EGYEZIVÉ A PÜRGETTYÜDET!



9554



9555



9556

COMING SOON  
BALD ERHÄLTlich  
PROCHAINEMENT  
PROXIMAMENTE  
A CHEGAR  
BREVEmente  
HAMAROSAN  
ÉRKEZIK

9557

COMING SOON  
BALD ERHÄLTlich  
PROCHAINEMENT  
PROXIMAMENTE  
A CHEGAR  
BREVEmente  
HAMAROSAN  
ÉRKEZIK

9591

SPIRIT



9569

NRG JAY



9570

FANGDAM



9571

NRG COLE



9572



9573



9574

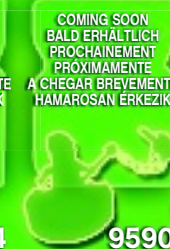

9590

NRG KAI VS CHOKUN



9591

NINJAGO.COM



# NINJAGO

Masters of Spinjitzu



[NINJAGO.COM](http://NINJAGO.COM)

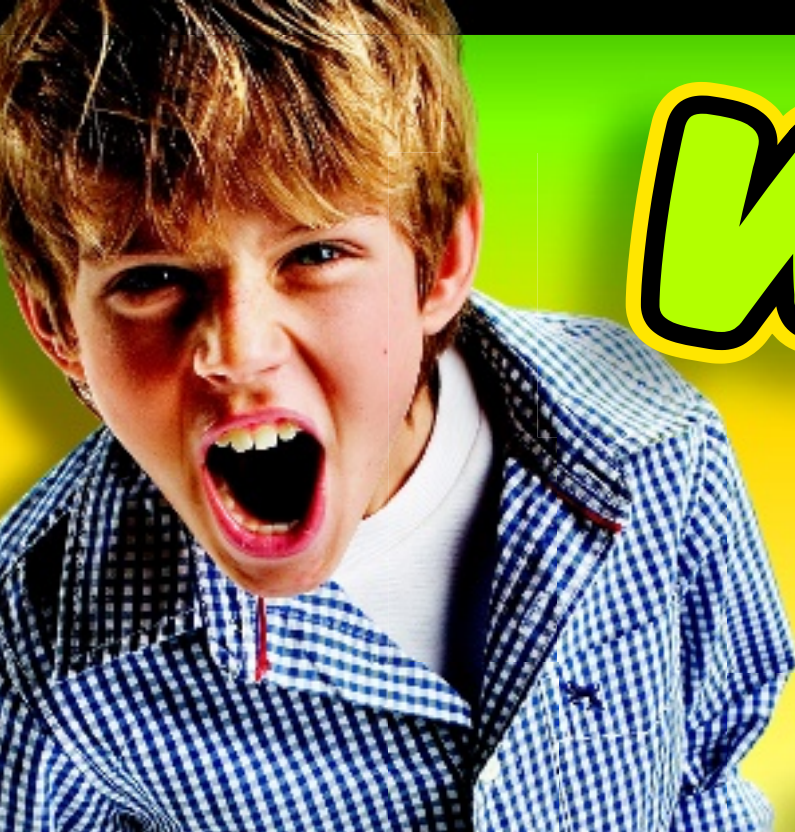

# WIN!

Go to [www.LEGOsurvey.com/product](http://www.LEGOsurvey.com/product)  
to fill out a survey for a chance  
to win a cool LEGO® Product.  
No purchase necessary.  
Open to all residents where not prohibited.



LEGO.com



## [www.LEGOsurvey.com/product](http://www.LEGOsurvey.com/product)

### GEWINNE! WIN!

Nimm an der Umfrage auf  
[www.LEGOsurvey.com/product](http://www.LEGOsurvey.com/product)  
teil und hab die Chance ein cooles  
LEGO® Produkt zu gewinnen!

Die Teilnahme am Gewinnspiel führt zu keinerlei  
Kaufverpflichtungen. Teilnahme in allen nicht  
ausgeschlossenen Ländern möglich.

Ga naar [www.LEGOsurvey.com/product](http://www.LEGOsurvey.com/product),  
vul een  
enquêteformulier in en maak  
kans op een cool LEGO® product.

Geen aankoopverplichting.  
Iedereen mag deelnemen, uitgezonderd  
ingezetenden van landen waar een  
enquêteverbod geldt.

### GAGNE! 当てよう!

Visite [www.LEGOsurvey.com/product](http://www.LEGOsurvey.com/product)  
pour répondre à un  
questionnaire et avoir une chance de  
gagner un produit LEGO® très cool!

Aucune obligation d'achat.  
Ouvert à tous les résidents des pays  
autorisés.

[www.LEGOsurvey.com/product](http://www.LEGOsurvey.com/product) にアクセスして、  
アンケートにご記入ください。当選者にはレゴ  
製品を差し上げます。

お買い上げの必要はありません

禁止されていない限り、すべての皆様にご利用いただけます。