



80108



一起来拼搭

3

 Build Together  
6x





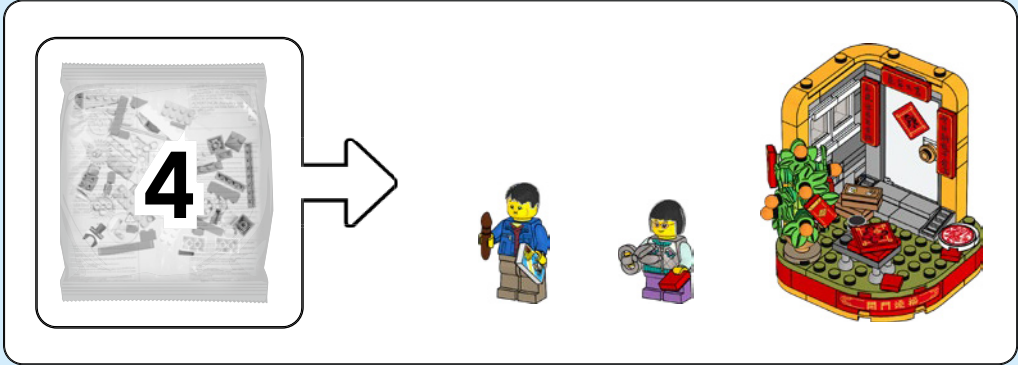

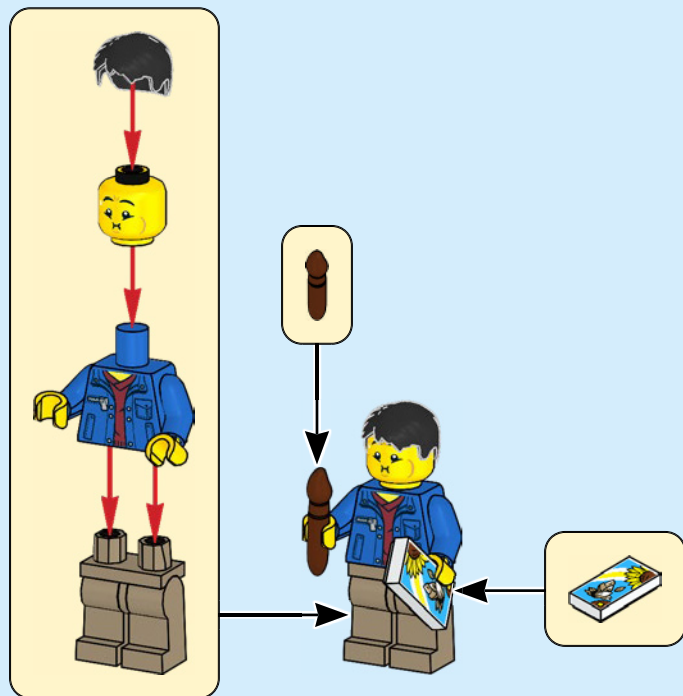
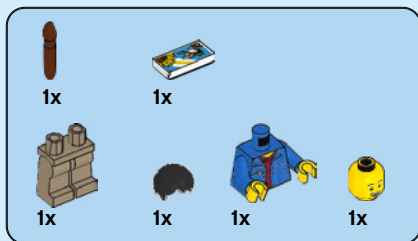

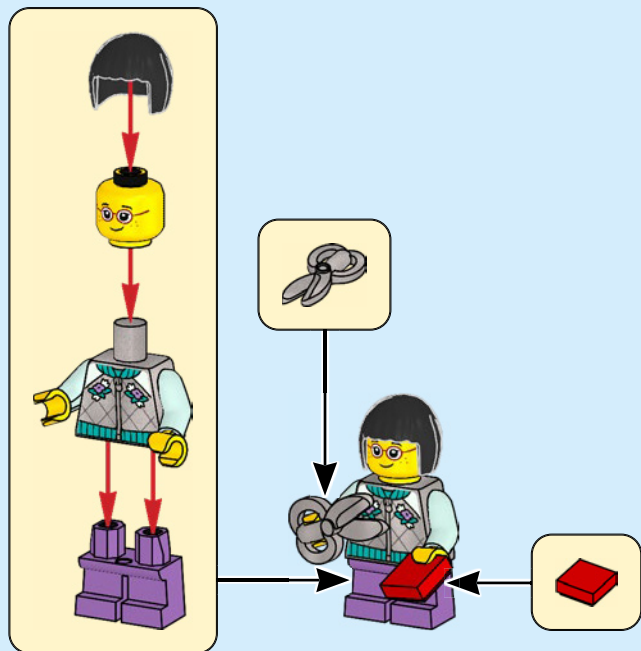
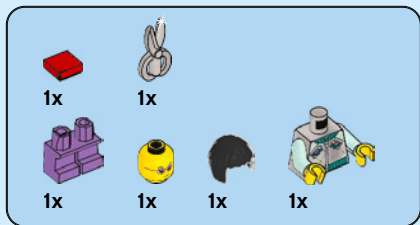

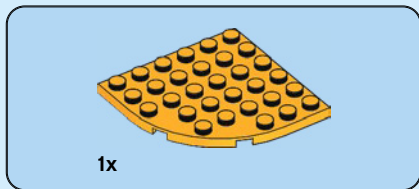

1x

1

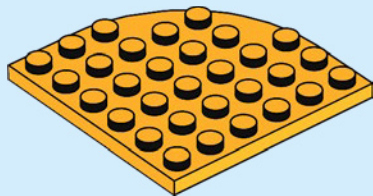



1x

2

1



2

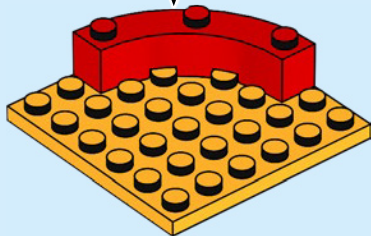



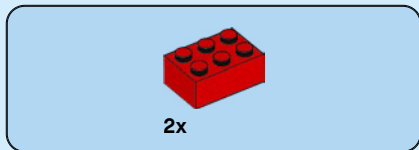

3

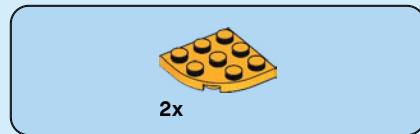
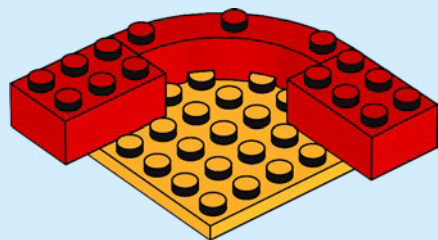

4

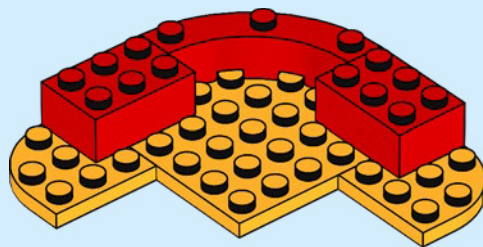



2x

5

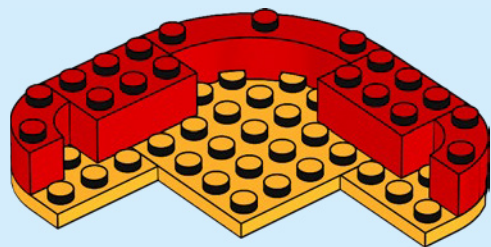

10



2x

6

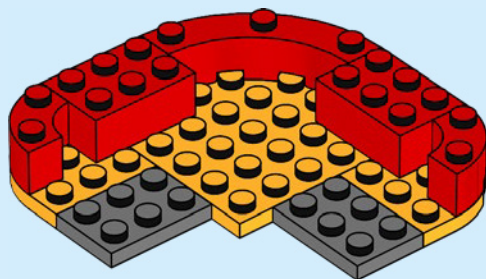



2x

7

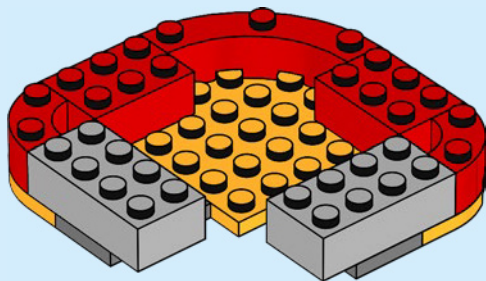

2x

8

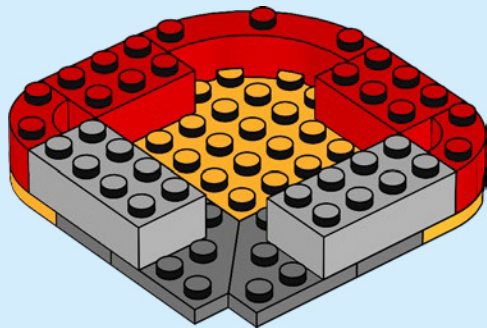

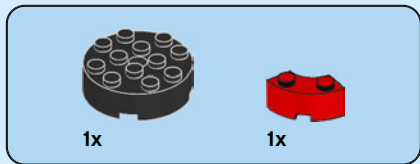

9

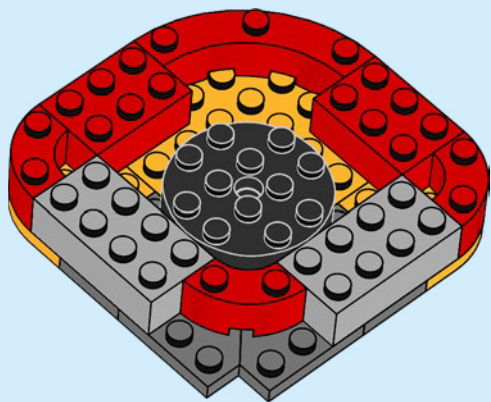

12

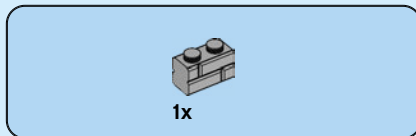

10

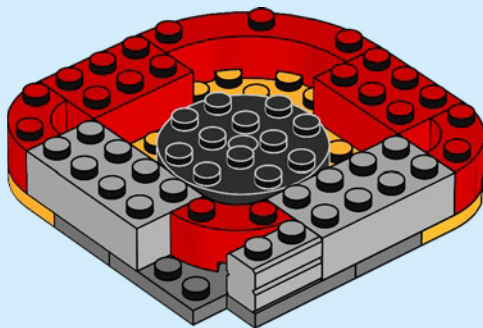

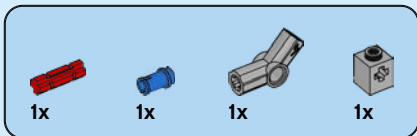

11

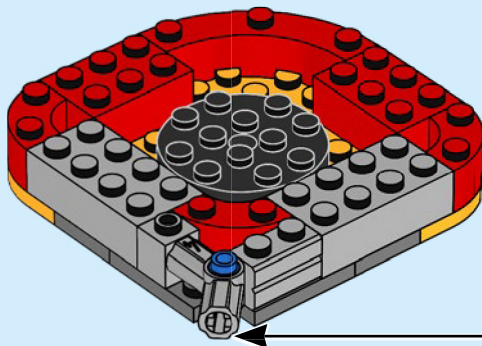
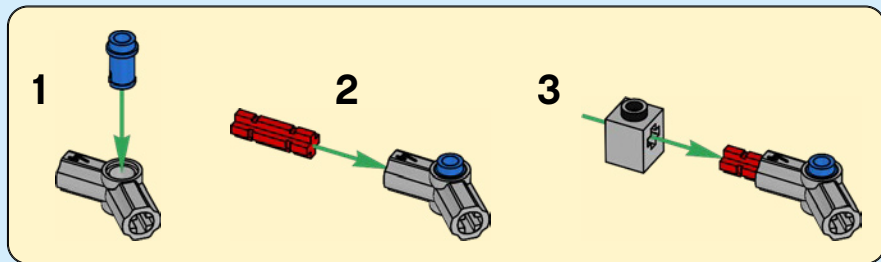

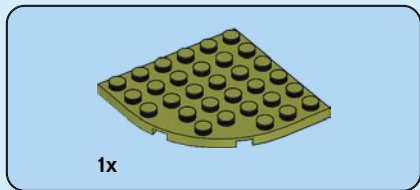

12

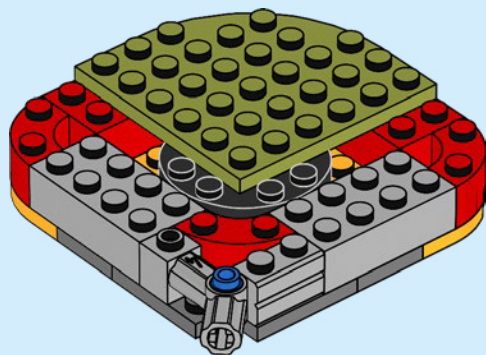



2x

13

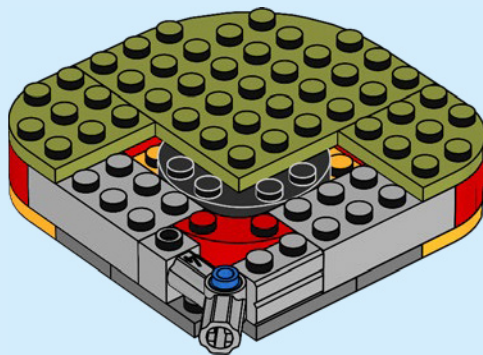



4x

14

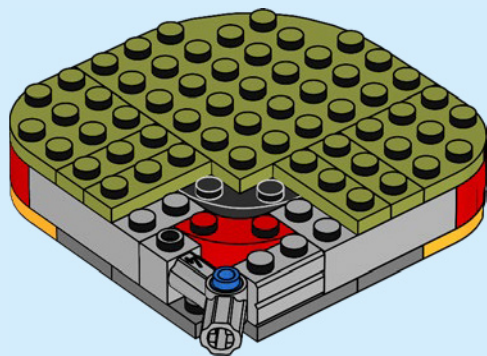

16





2x

15

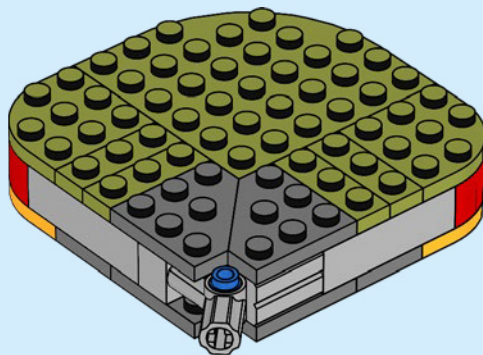

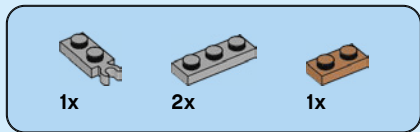

16

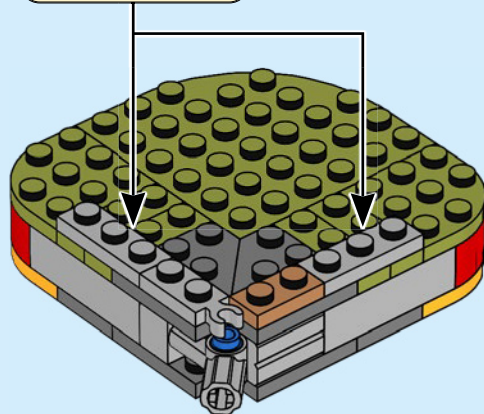
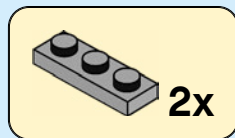



2x



2x

# 17

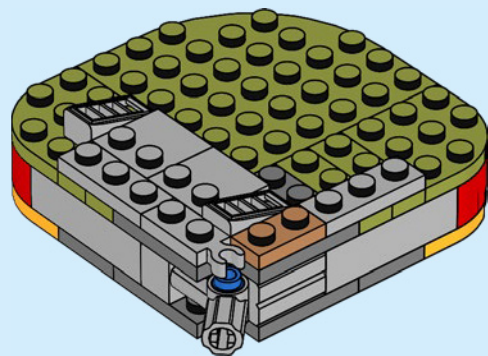

1x

# 18

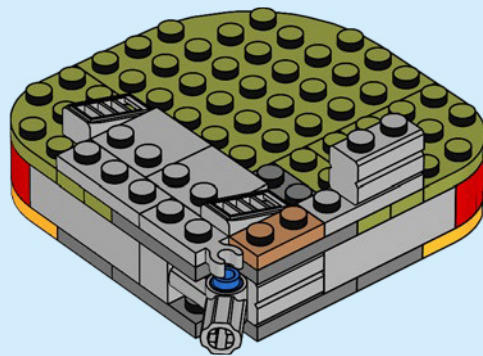

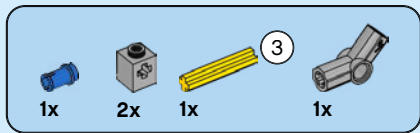

19

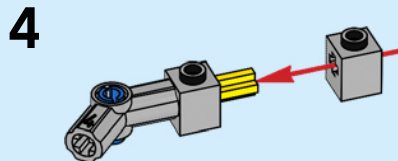
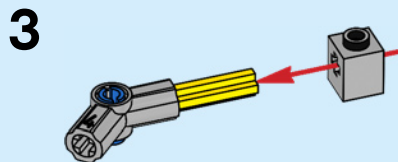
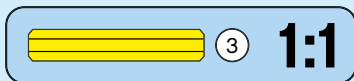
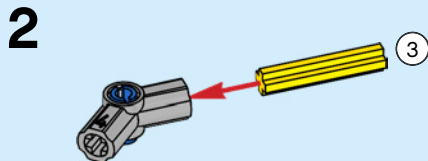
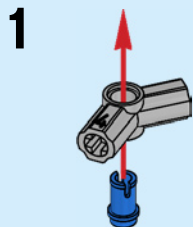

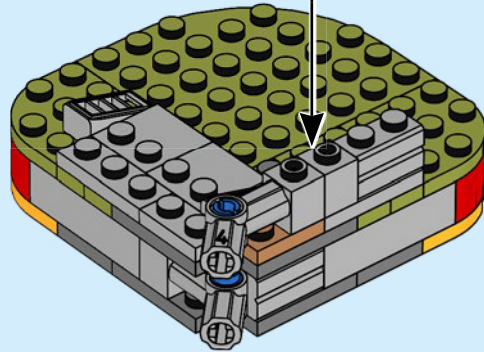

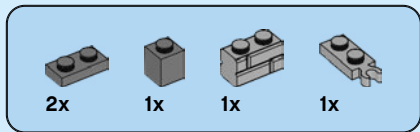

20

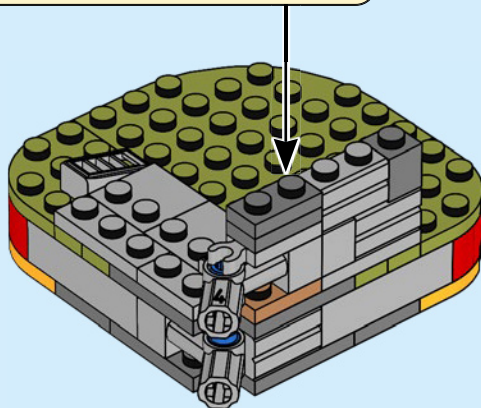
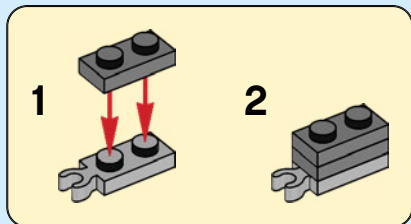



21

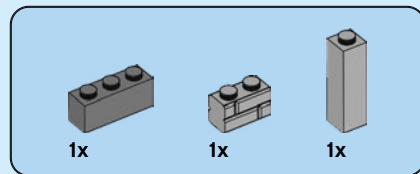
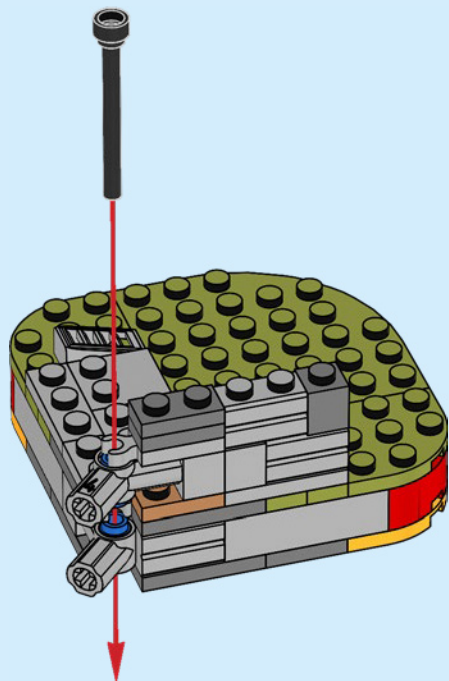

22

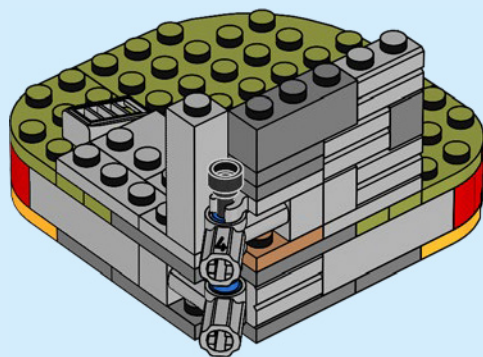



1x

23

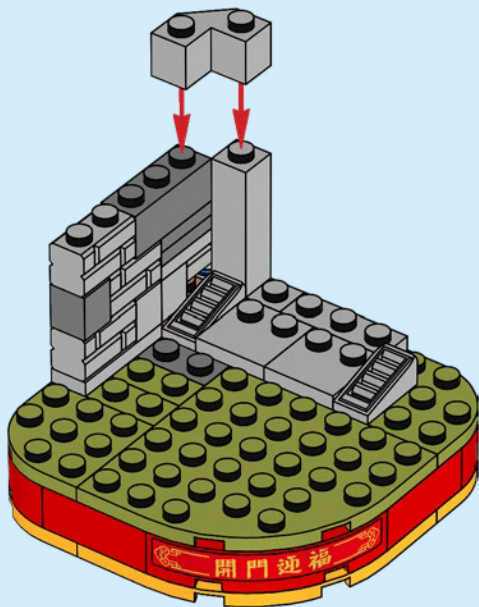
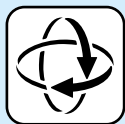

24





1x



2x



1x

# 24

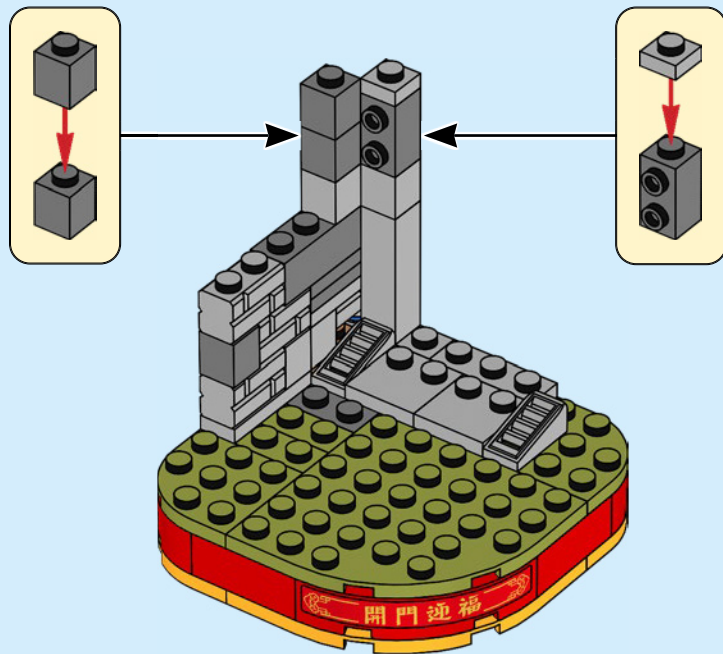

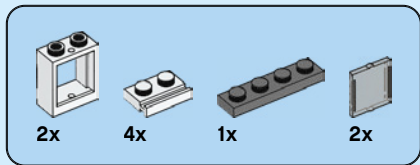

25

1

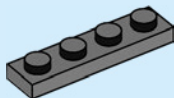

2

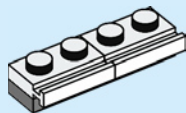

3

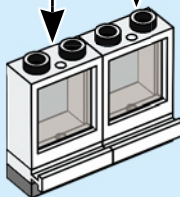

4

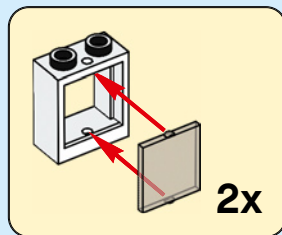
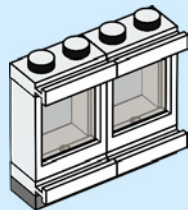

26

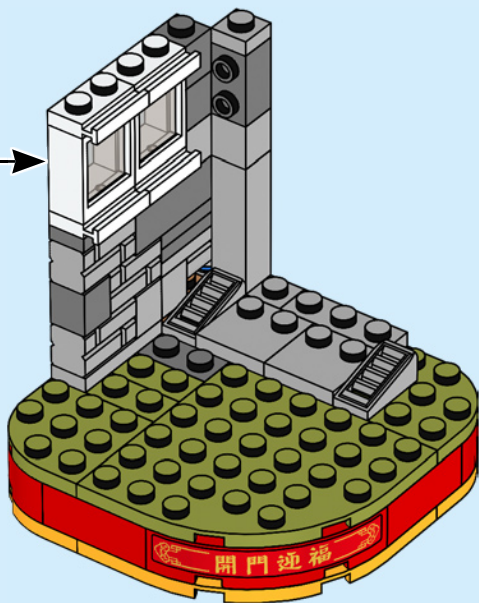

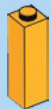

2x

27

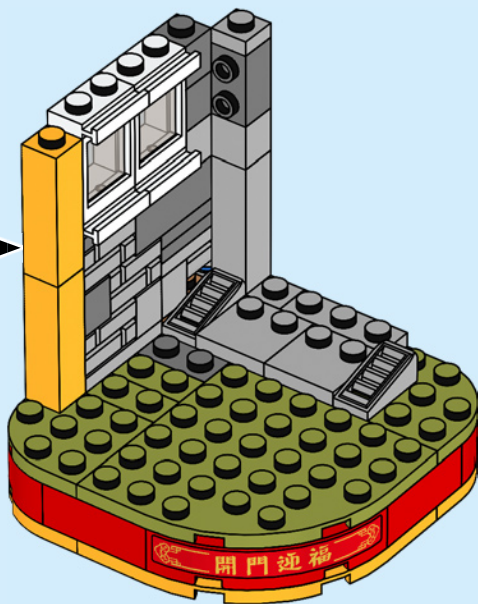
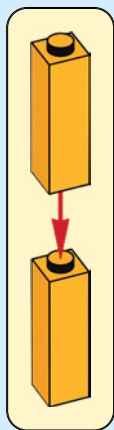

28

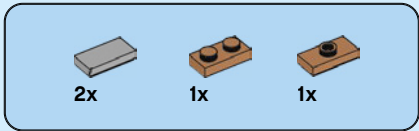

28

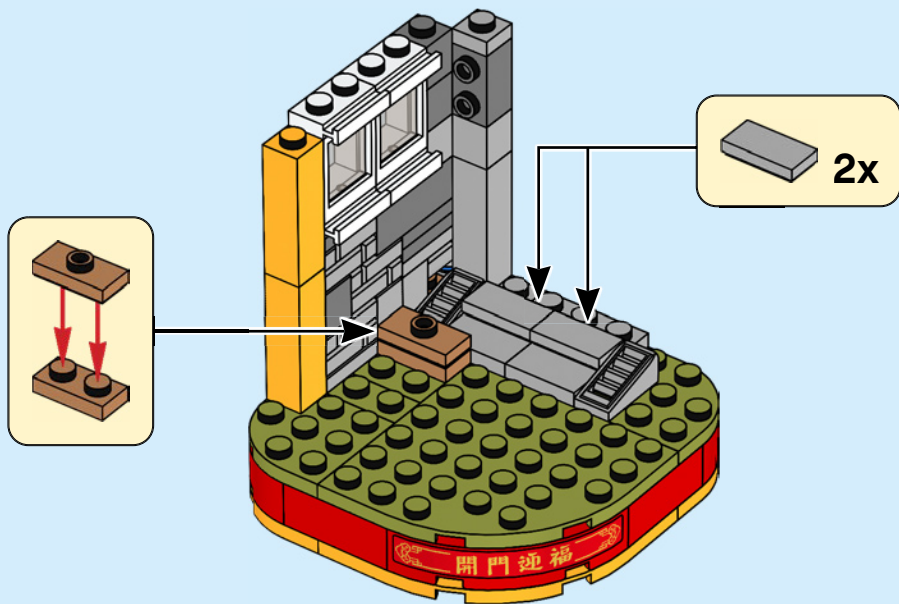

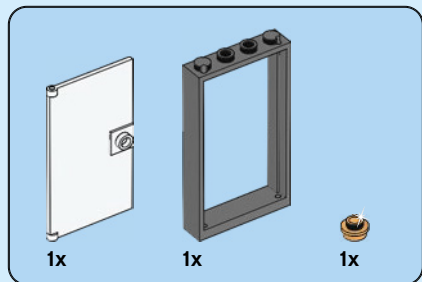

29

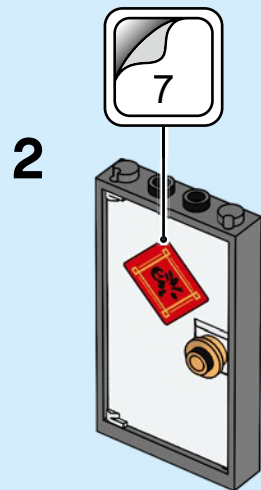
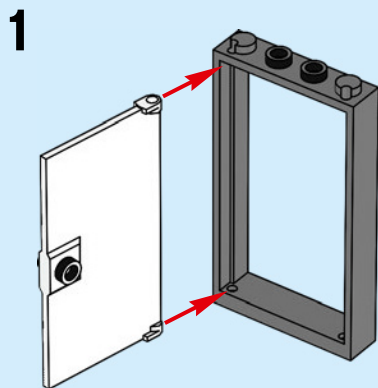

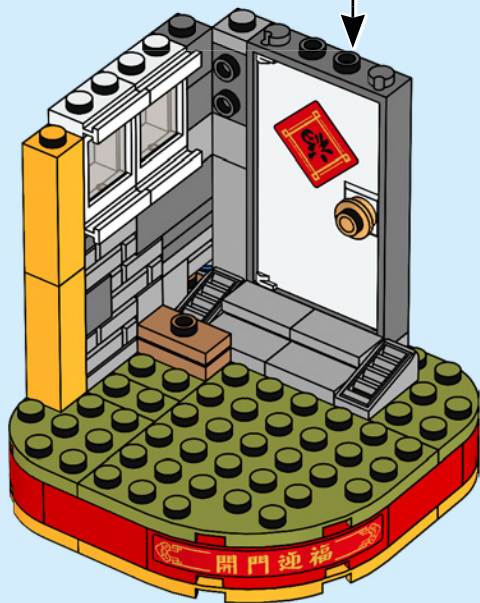

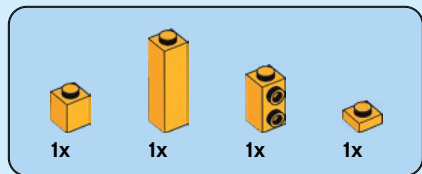

30

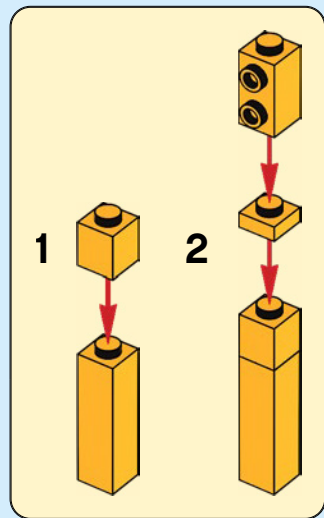
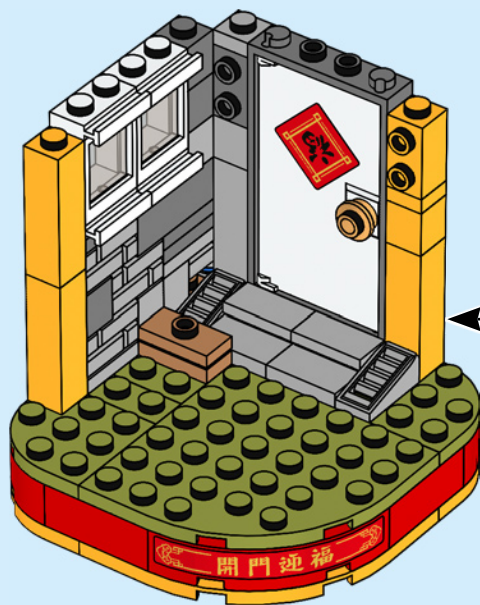



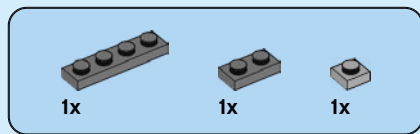

31

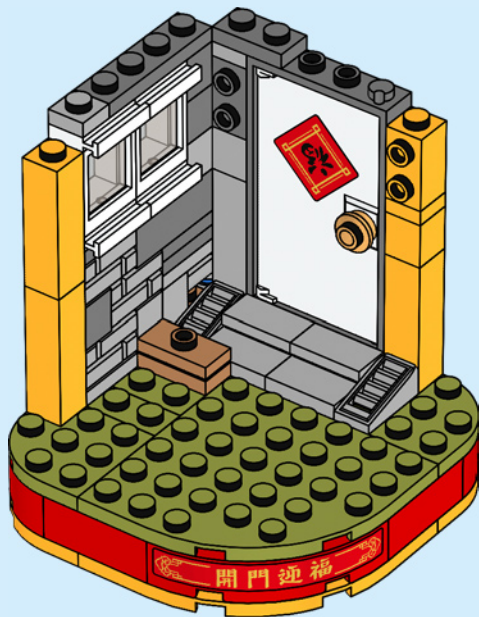



1x



1x

32

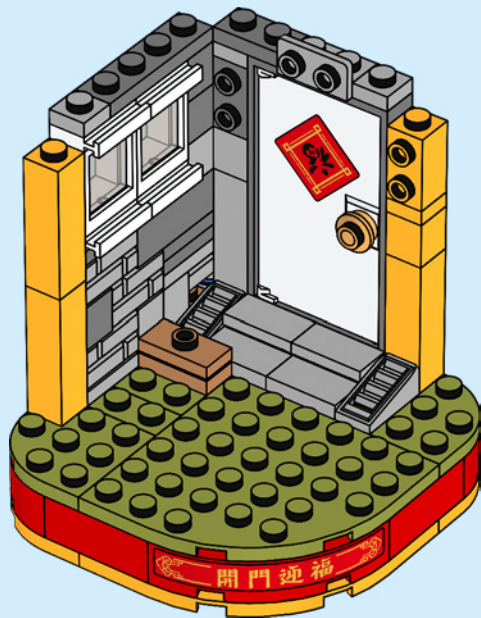

34



2x



2x

# 33

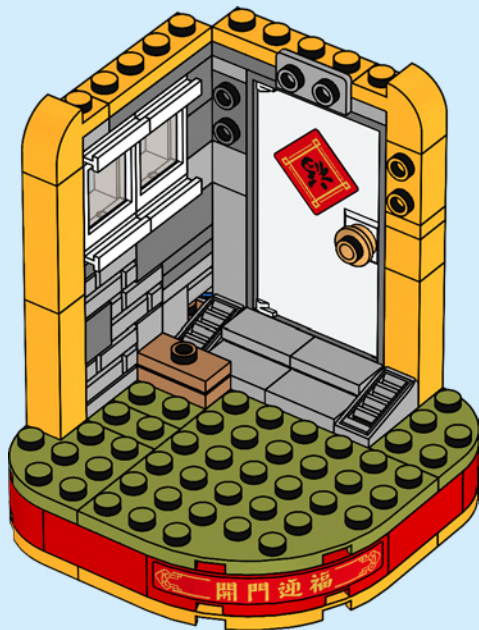



2x



1x

# 34

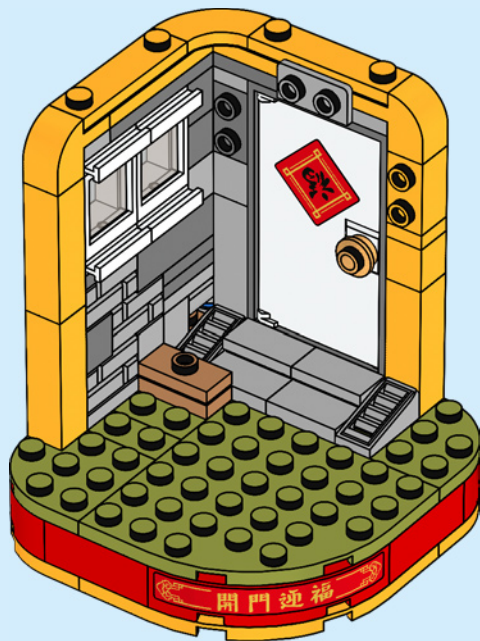

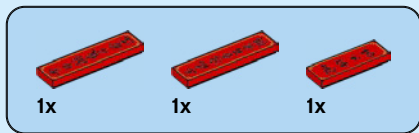

35

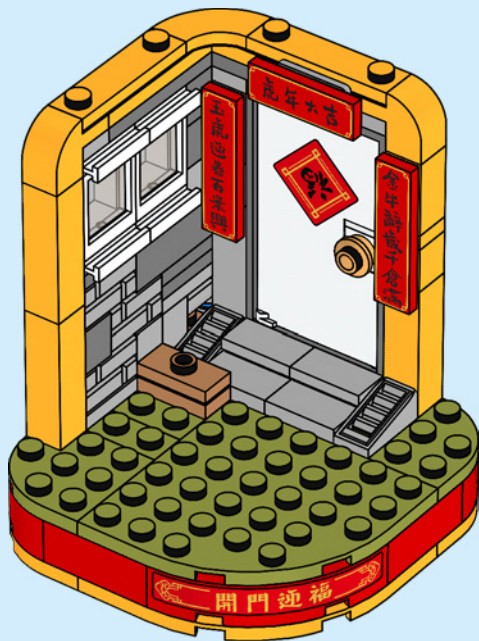



1x



1x

36

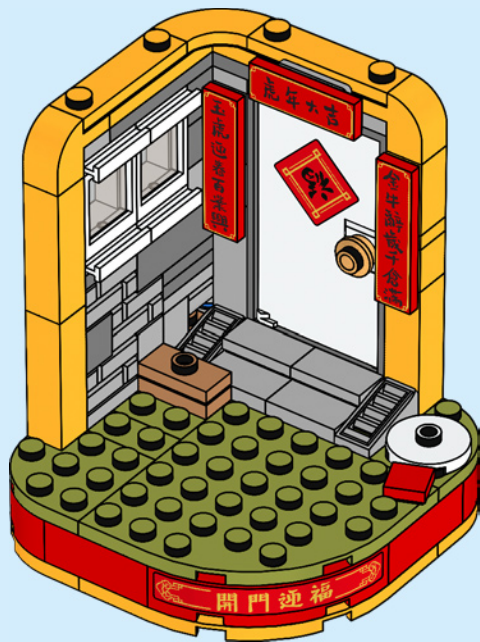

38

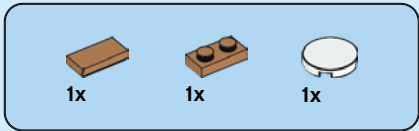

37

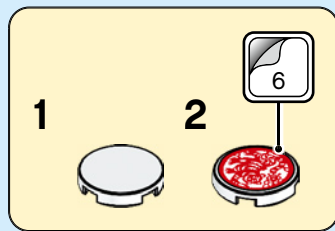
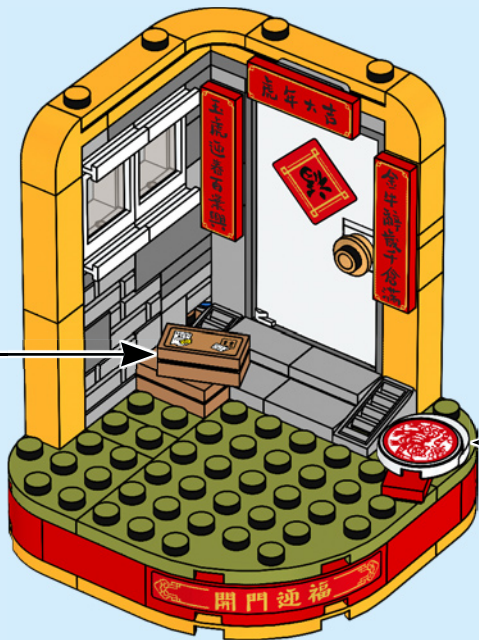
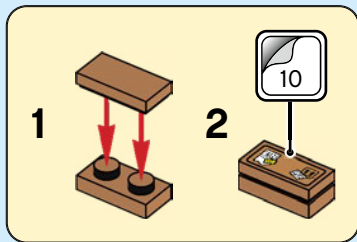



4x



1x



4x

38

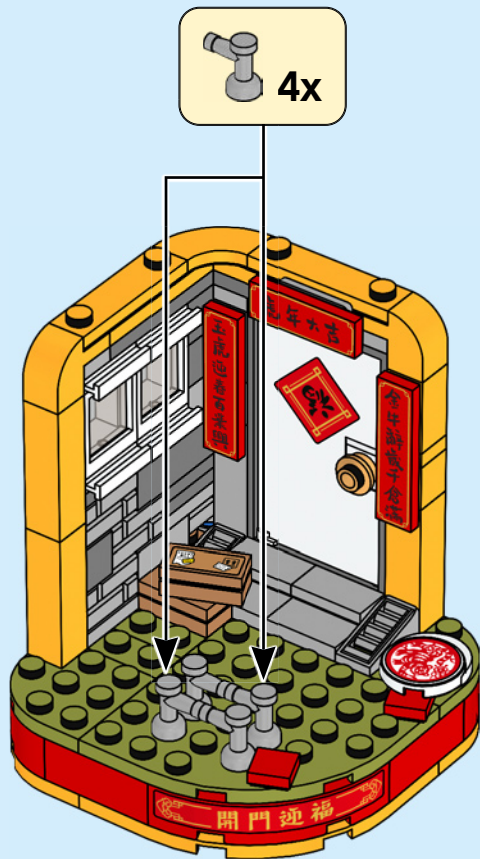

40





1x

39





1x



1x



1x

# 40

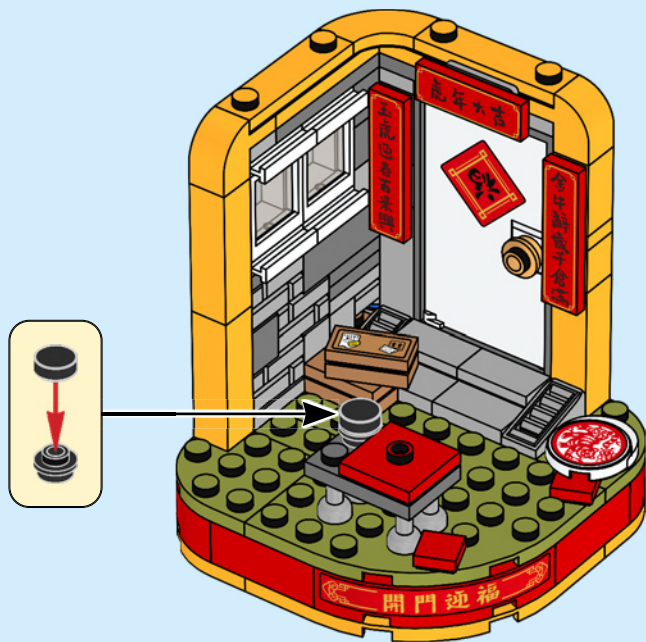

42



1x

# 41

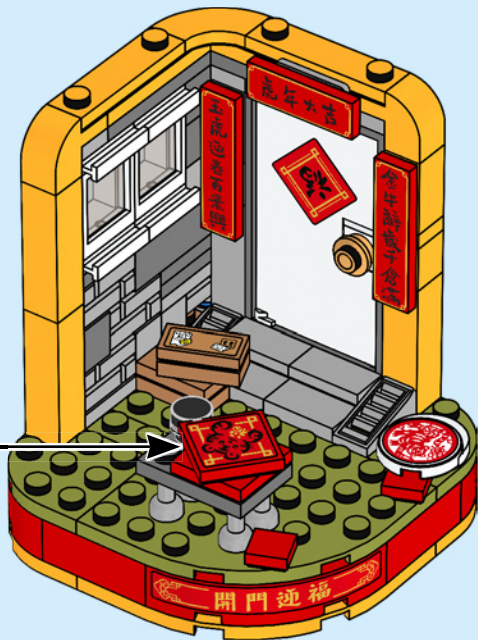

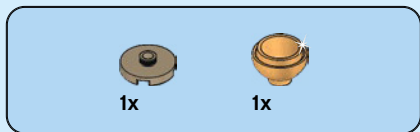

42

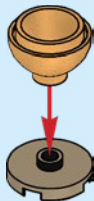

44



43





3x

# 44



2x



2x



2x

# 45

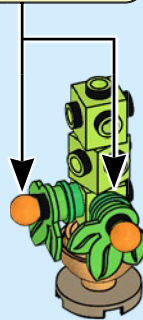
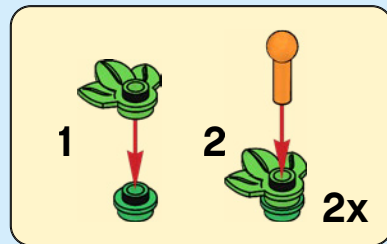

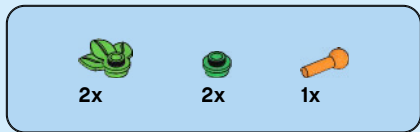

46

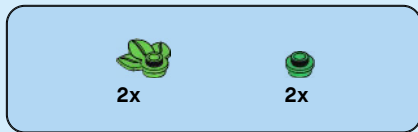
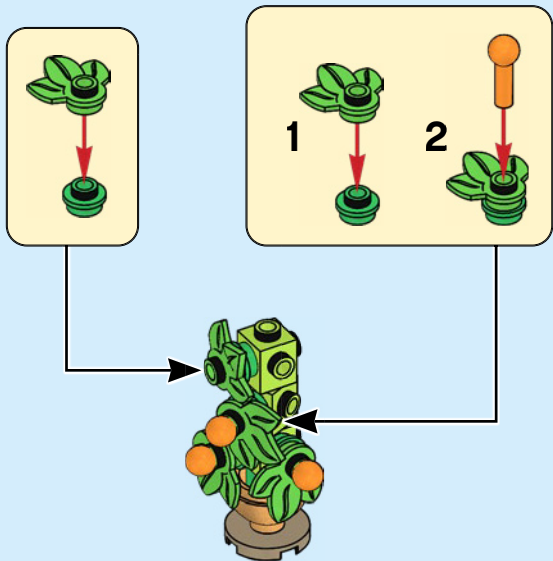

47

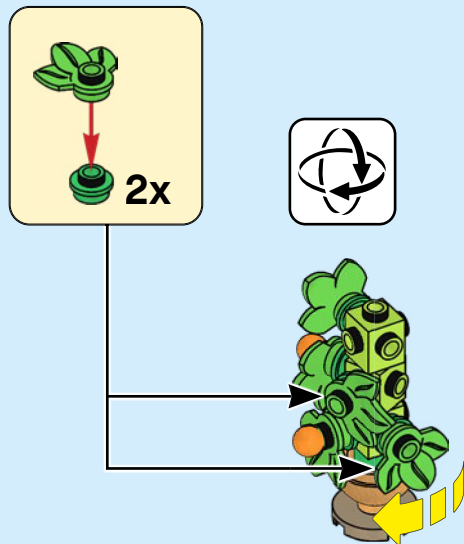

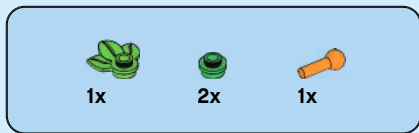

48

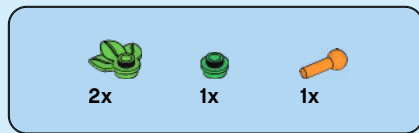
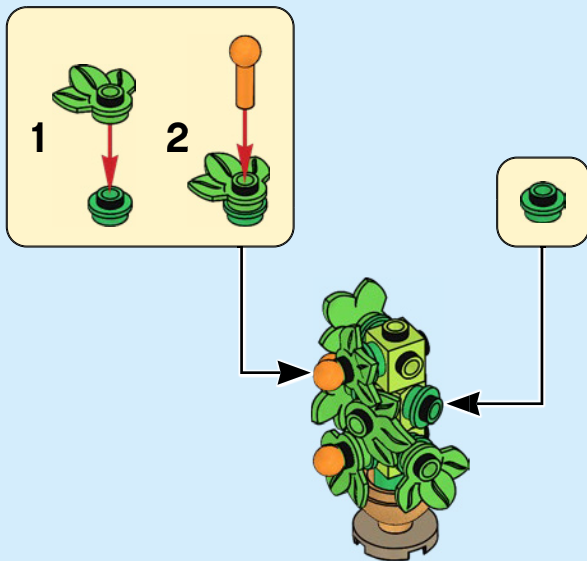

49

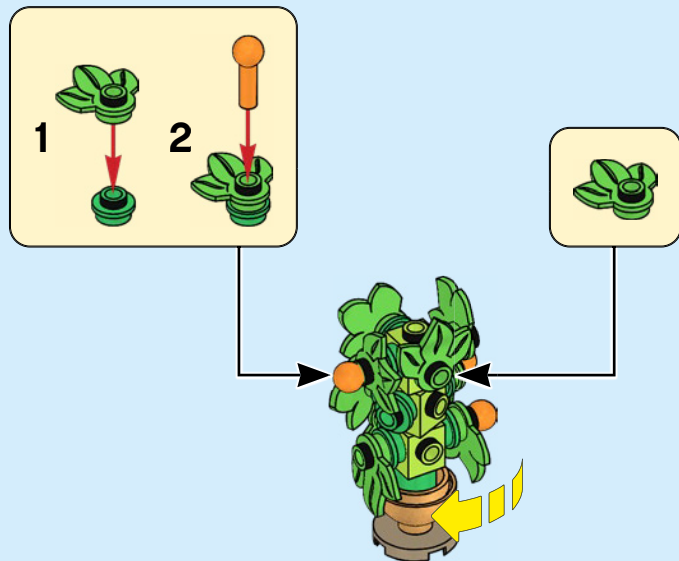



1x



1x

# 50

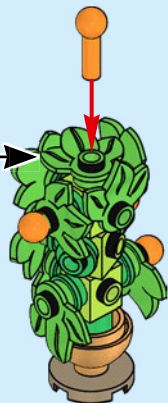

1x

# 51







2x

52



53





55

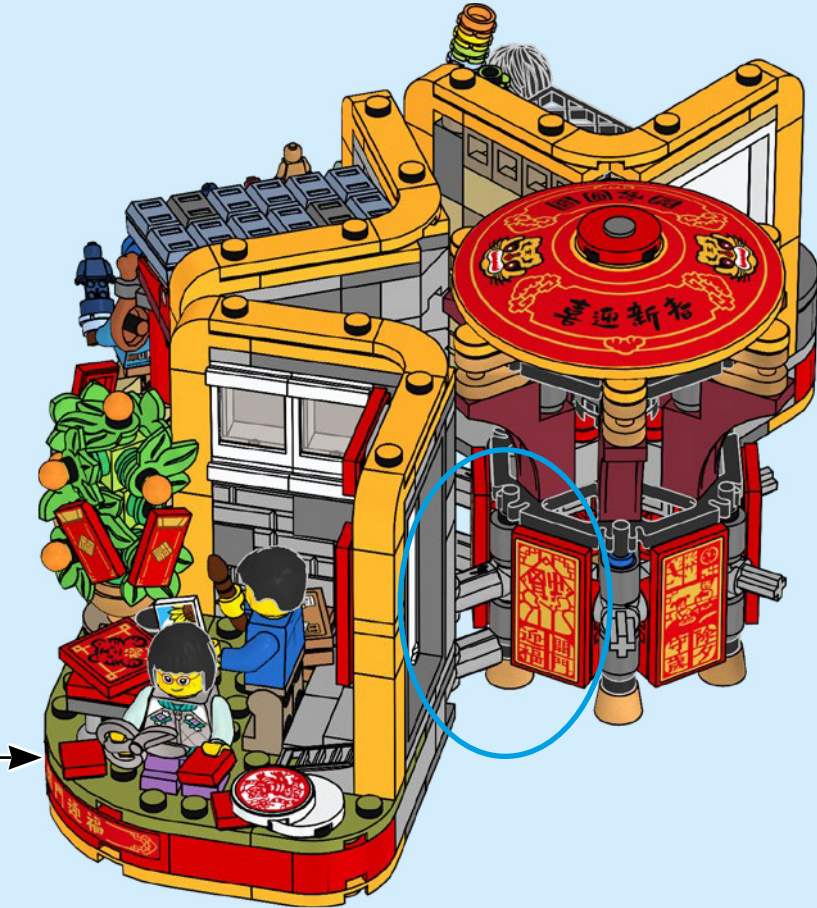

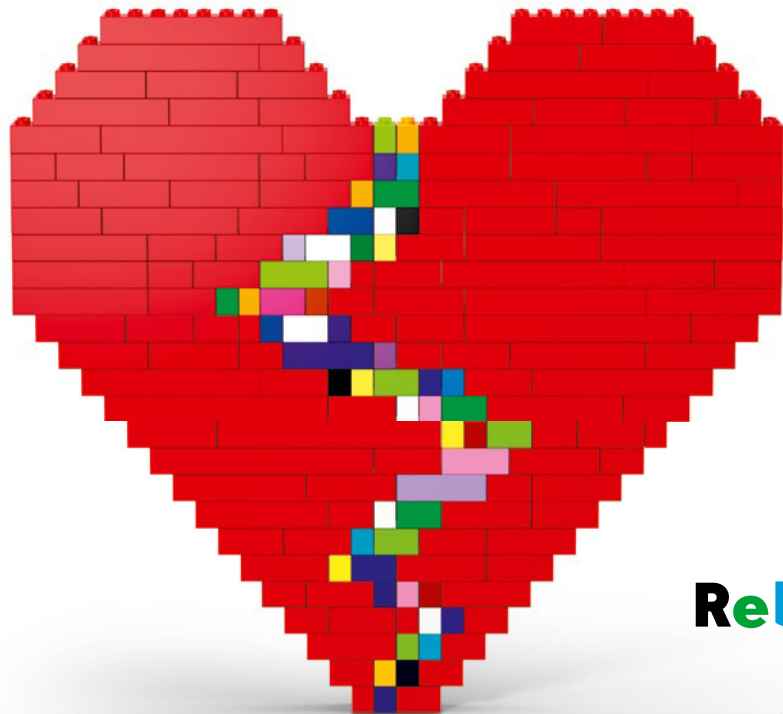

Rebuild  
the  
world™

