



ATLANTIS

7985



1

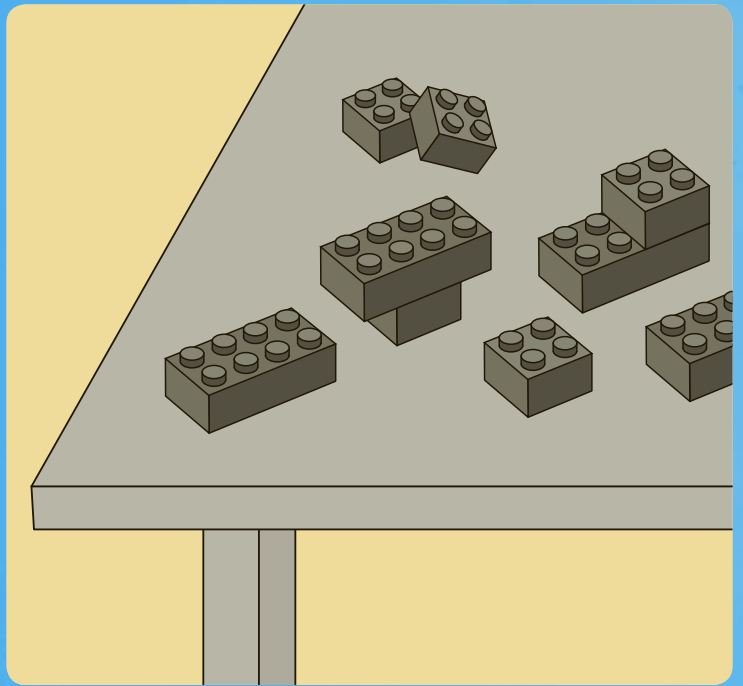
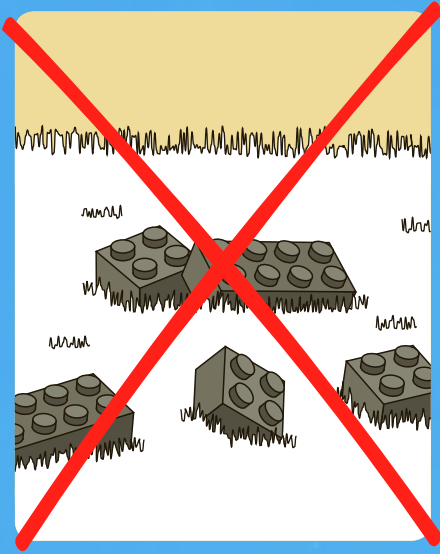

2





1

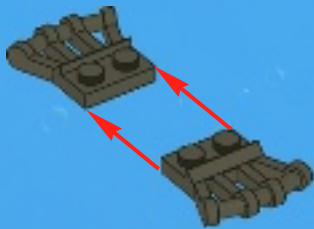

2



3





1x



2x

4



1x

5



1x

6



1x

7



2x

8



2x



2x

9





1x

10



11



1x

12

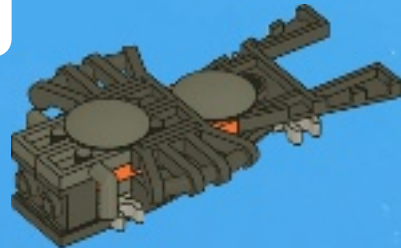



2x

13

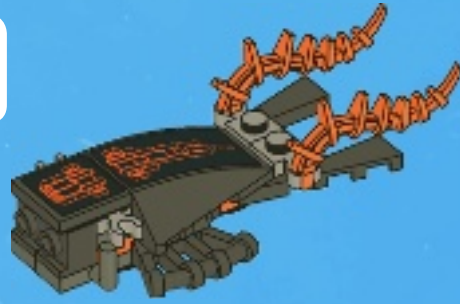

6x



6x

14

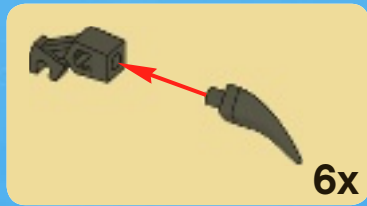

6x



2x



2x

15



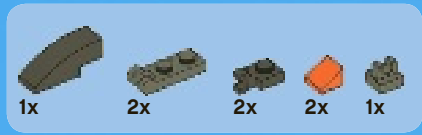

16

1 2 3 4 2x

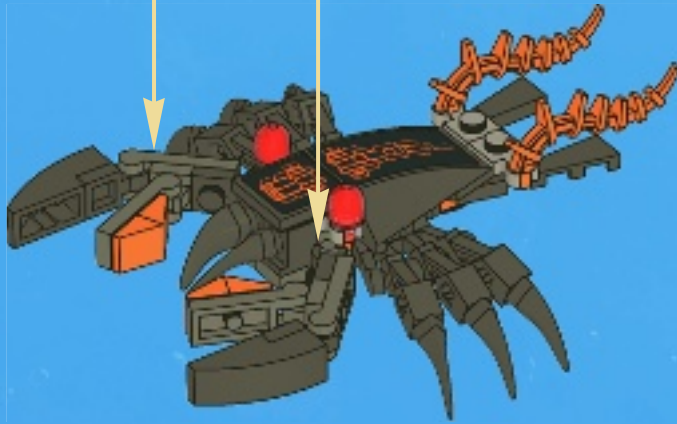



1x

1



2x



2x

2

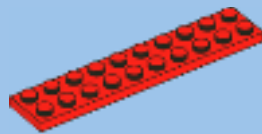

1x

3

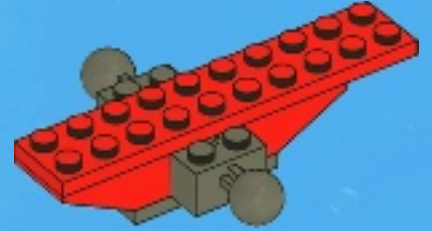

4x

4



1x



1x

5



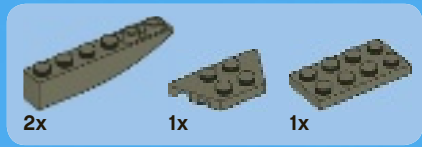

6

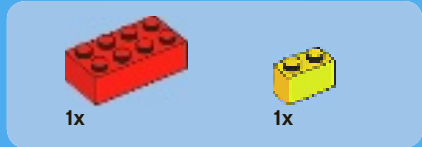
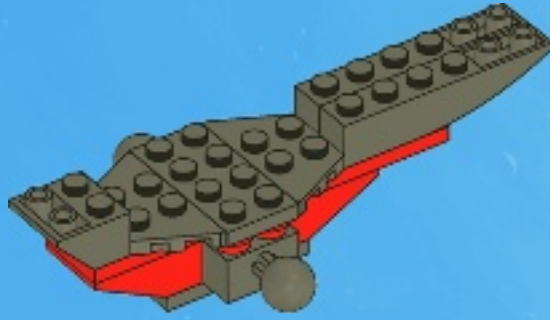

7

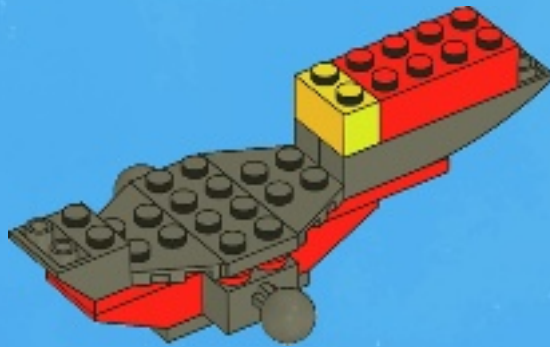

8

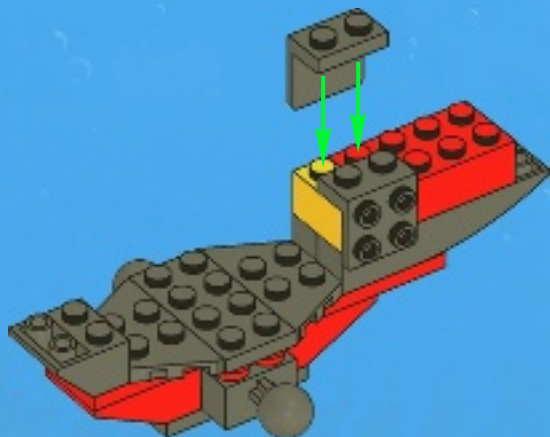



1x



2x

9

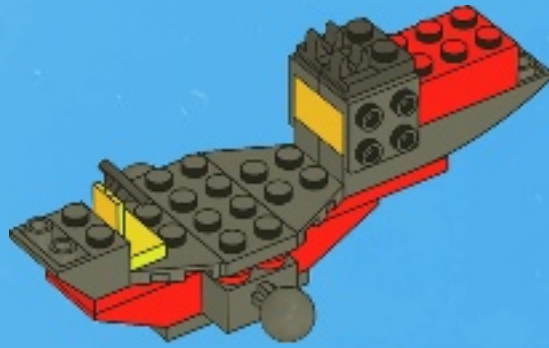

2x



2x

10

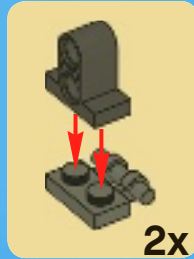

2x

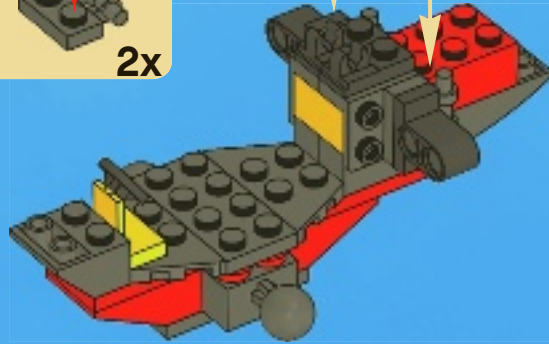

1x



2x



2x

11

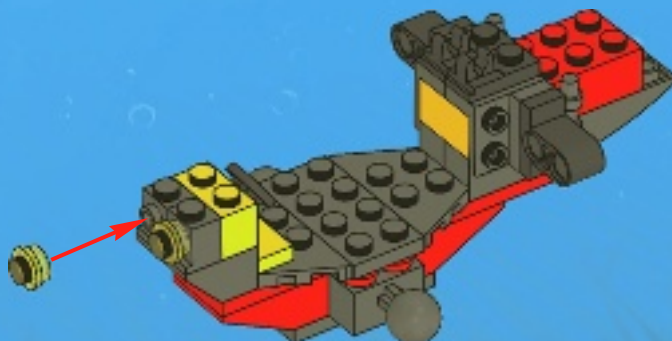



2x

12

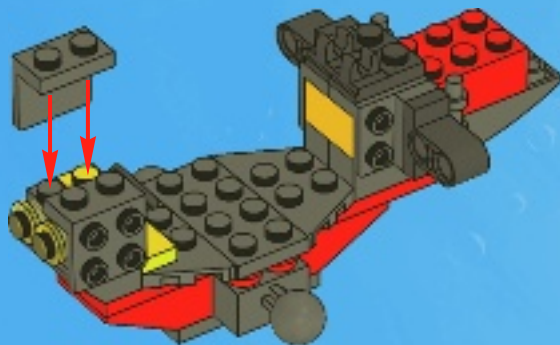

2x



4x



8x

13

1



2

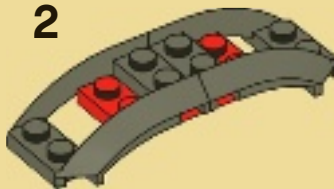

3

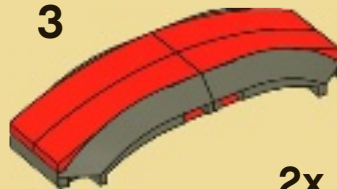

2x

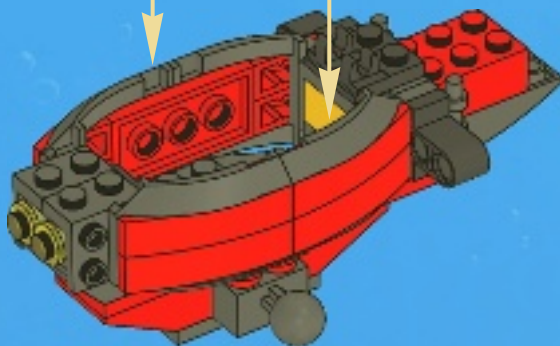



4x



14

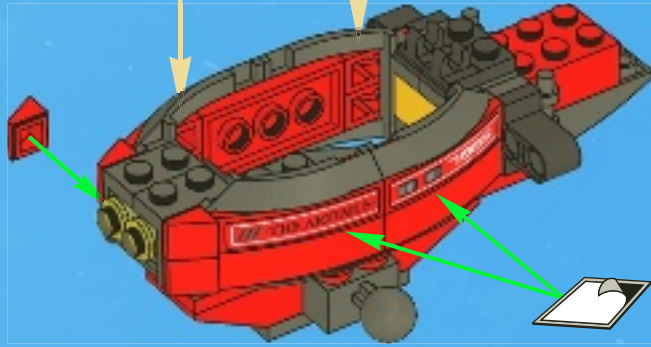

1x



1x

15



1x



1x

16

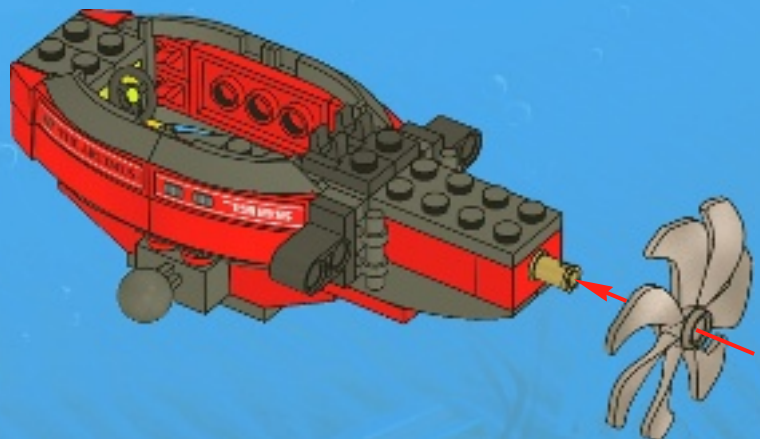



17

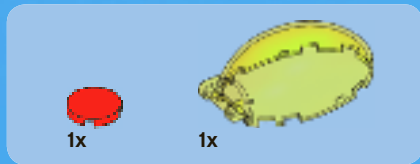
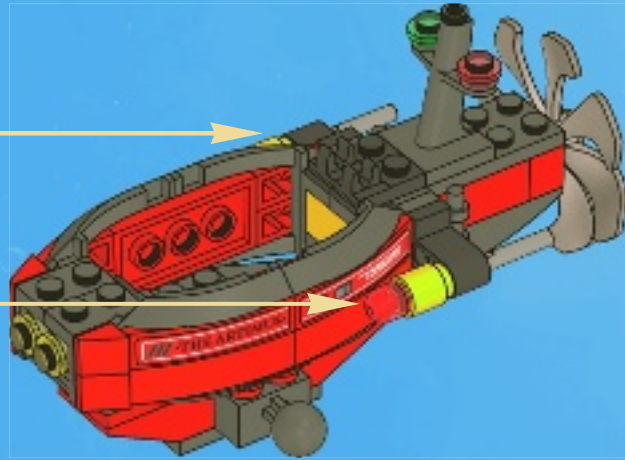
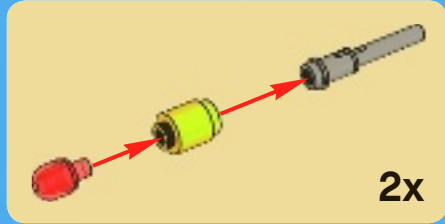
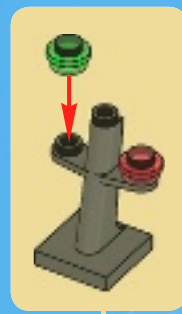

18

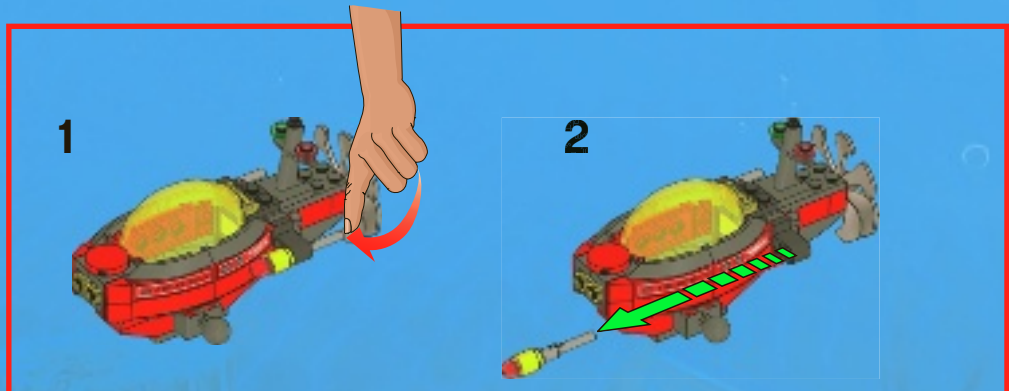
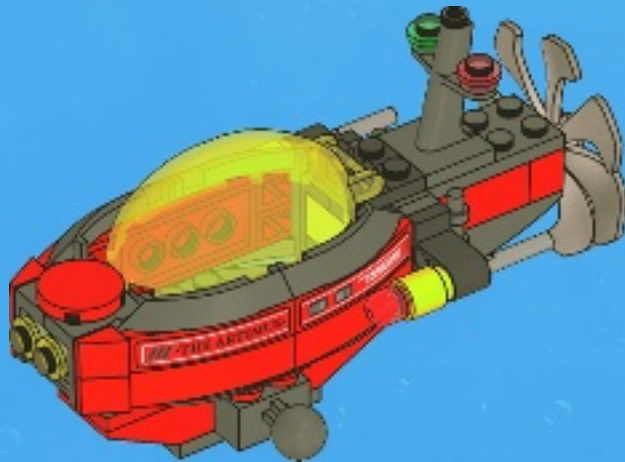



19

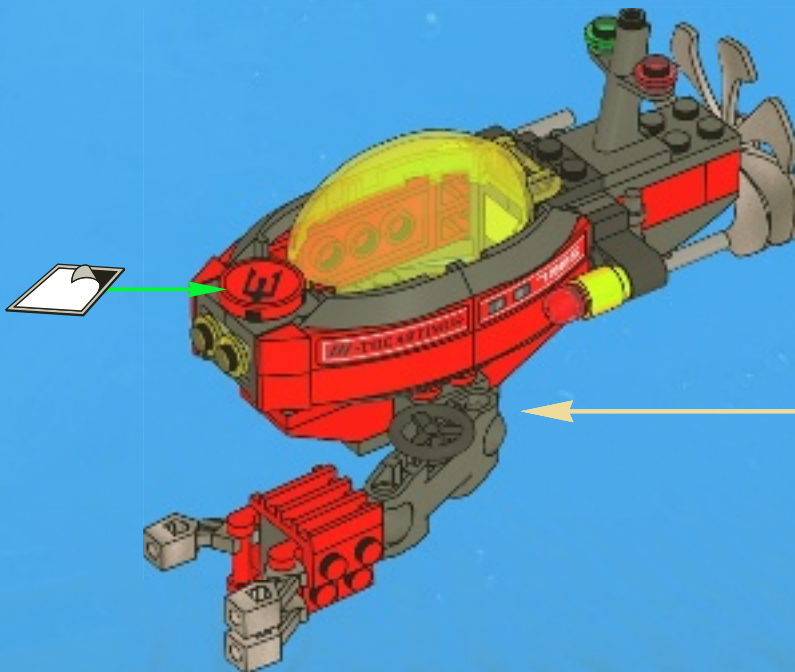
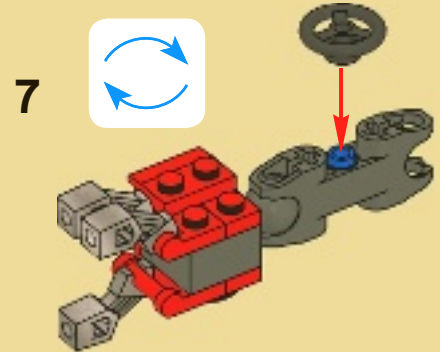
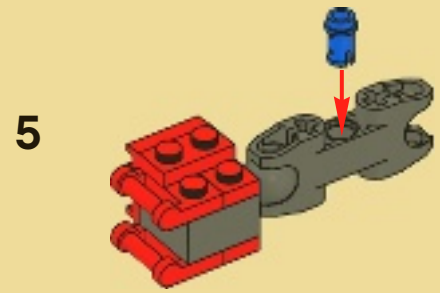
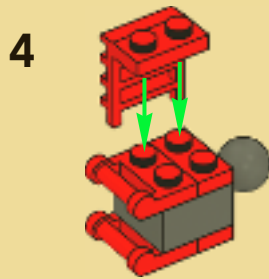
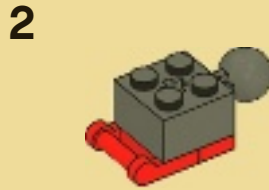
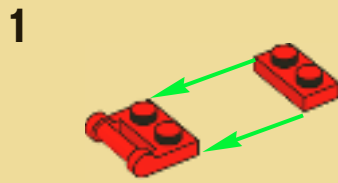

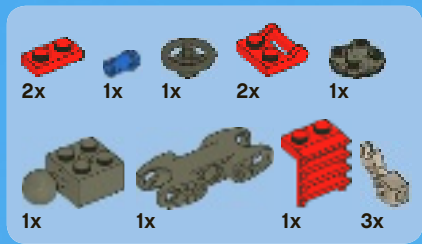

20

1

2

3

4

5

6

7

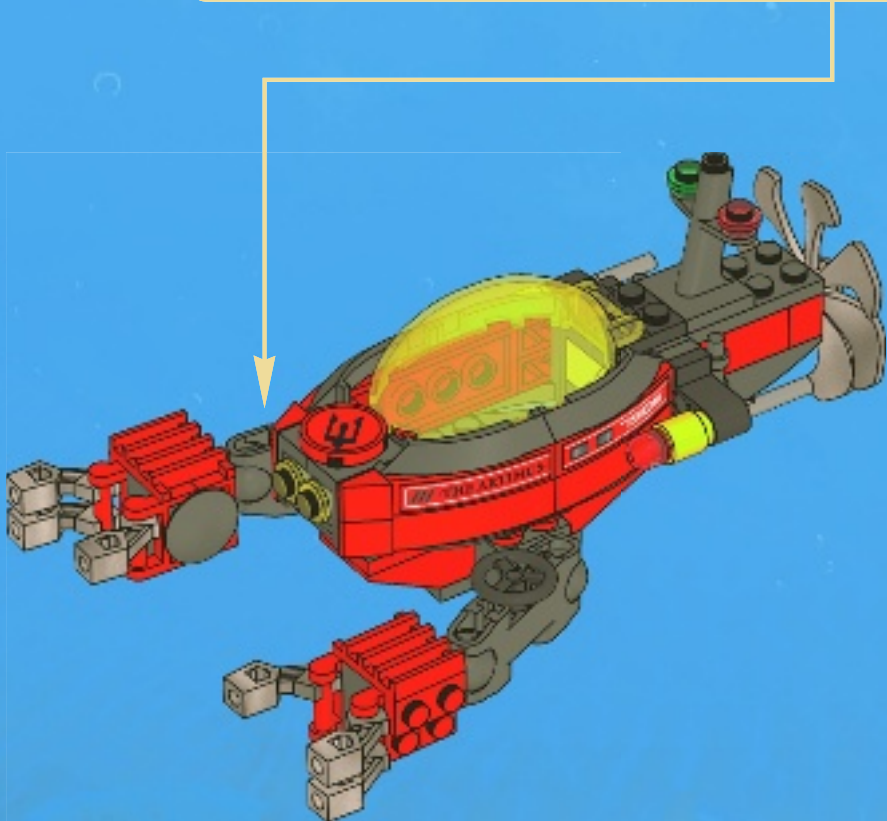

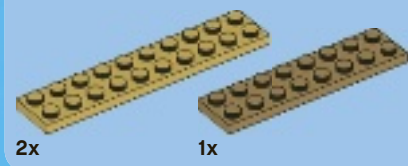

2x

1x

1

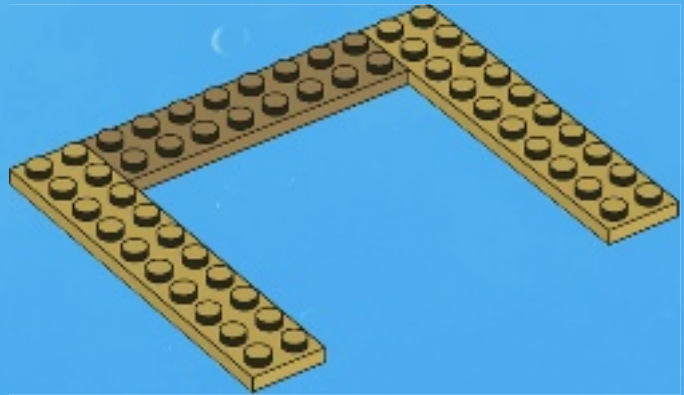

2x



1x



1x

2

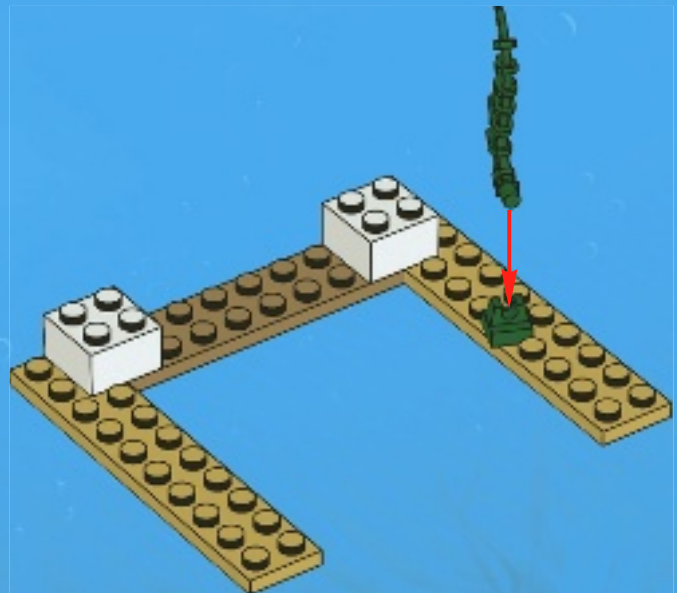



3

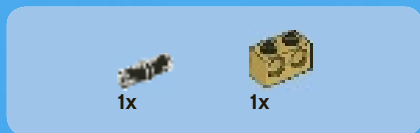

4





12x



3x

5

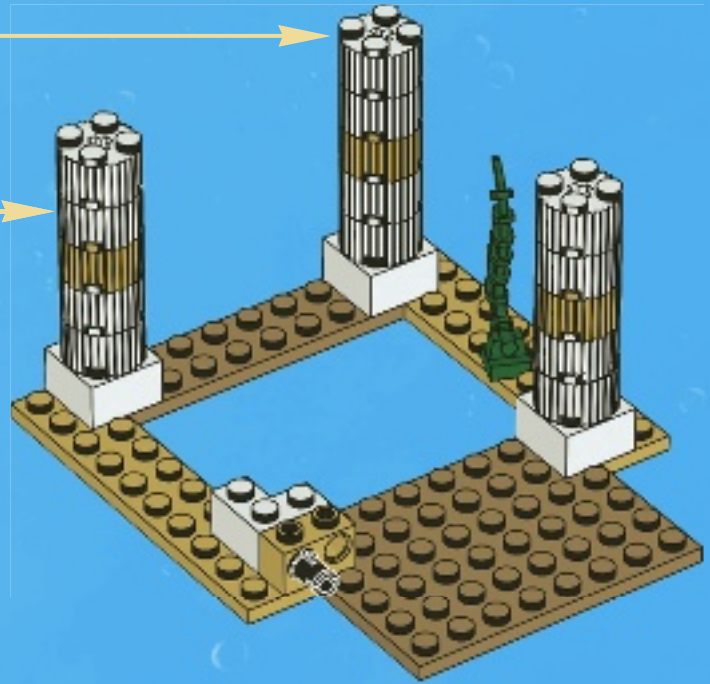
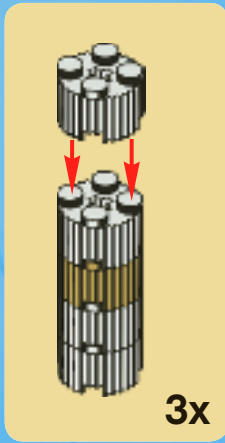

1x



1x



2x

6

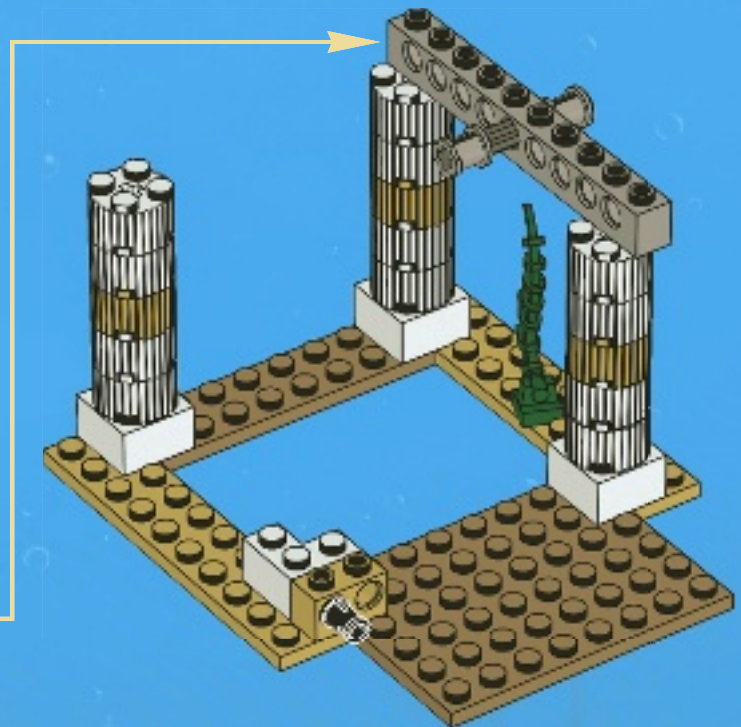
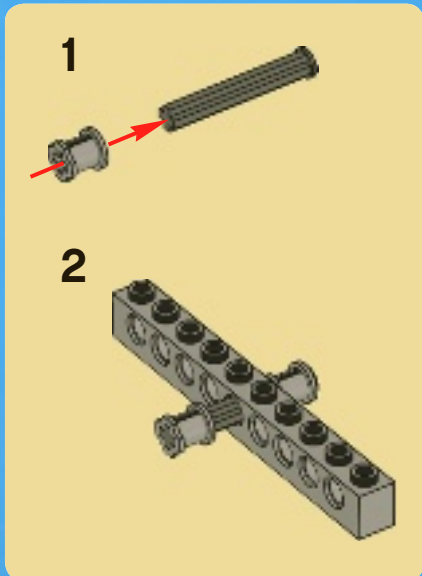

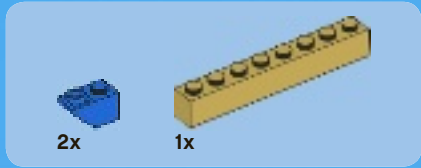

7

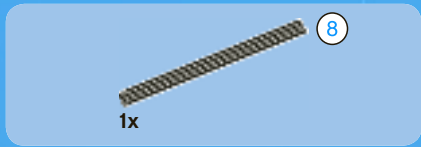
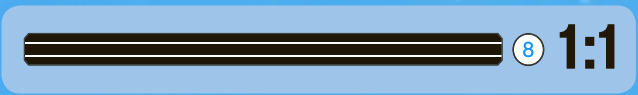
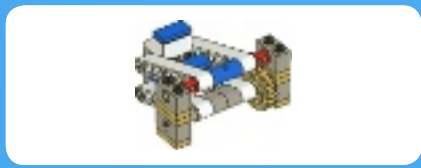

1





2x

2

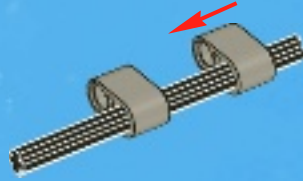

2x

3

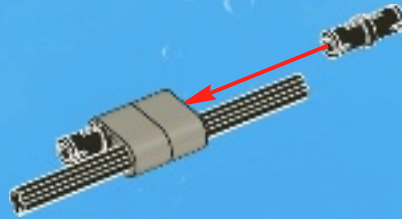

1x

4

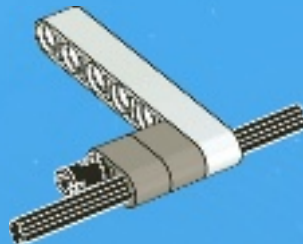

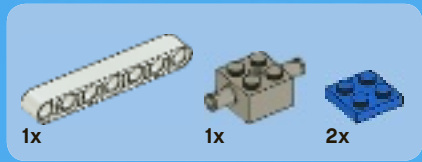

5

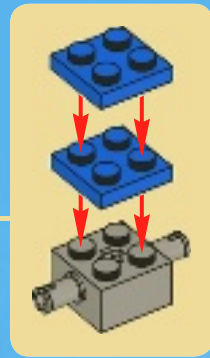
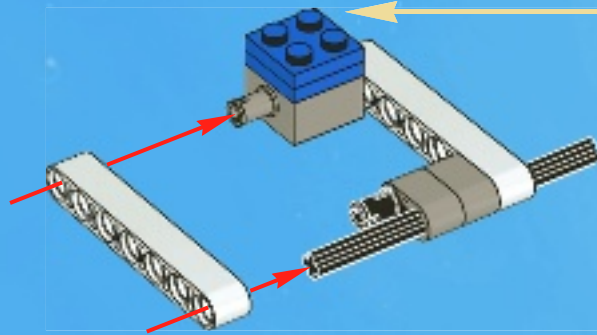

6

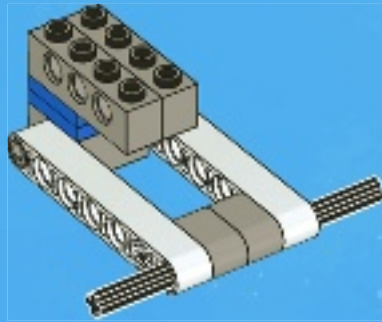

7

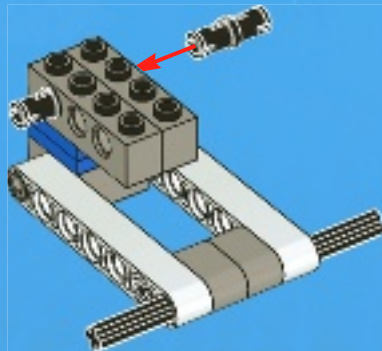



1x



2x

8

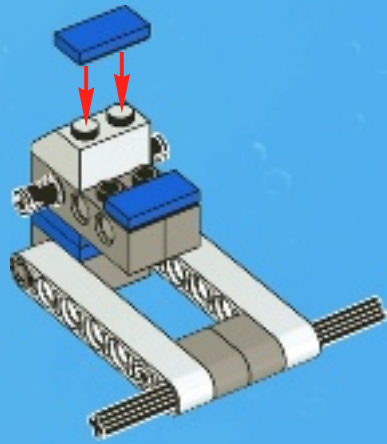

1x



1x

9

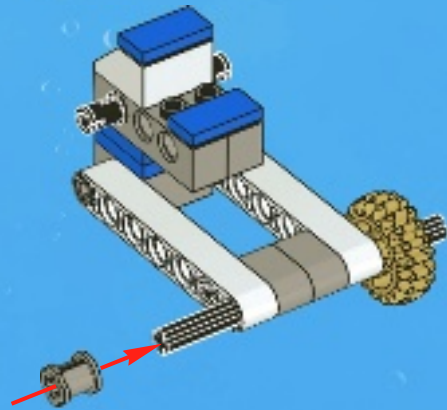

1x



1x



1x



1x

10

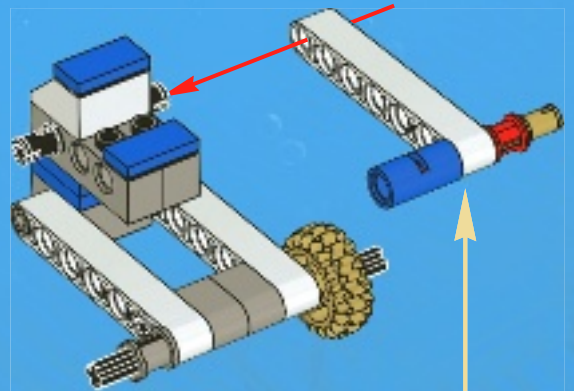
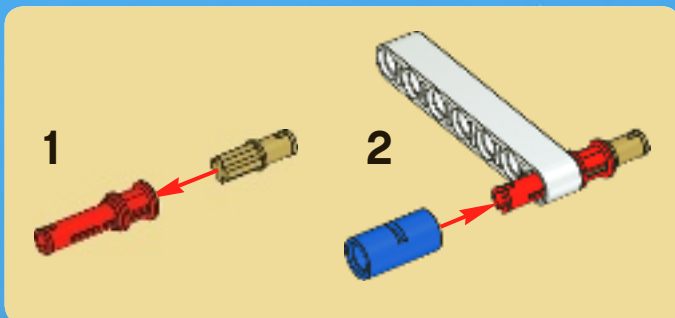

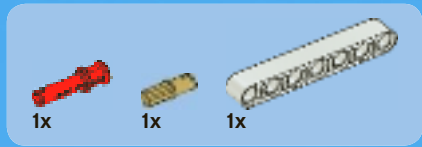

11

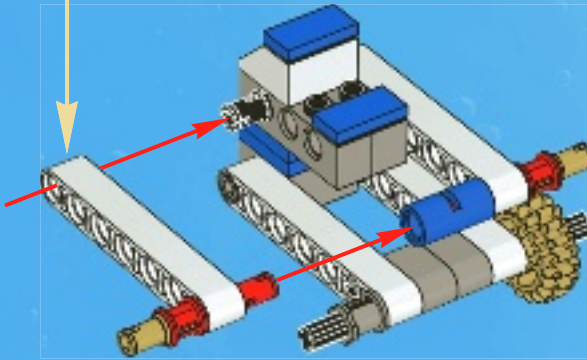
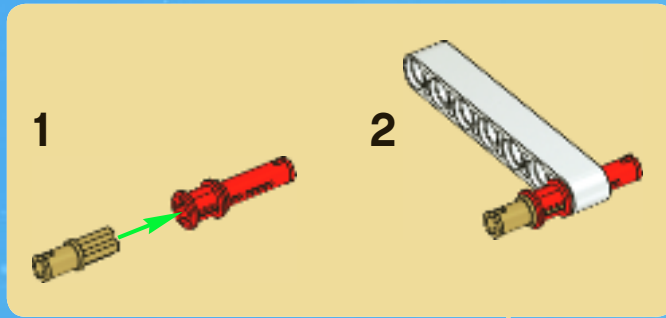

12

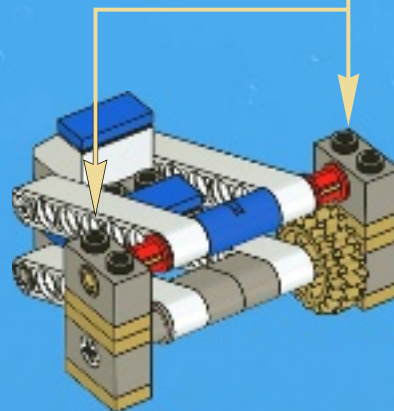
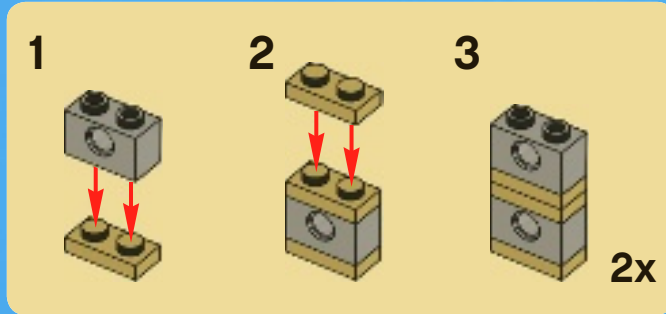

8

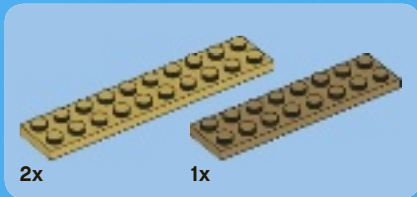
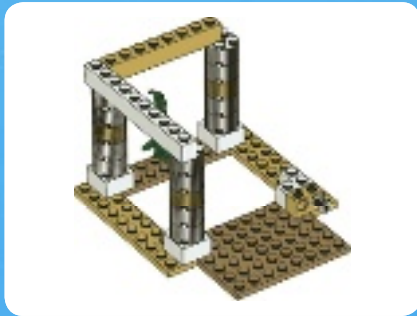

1

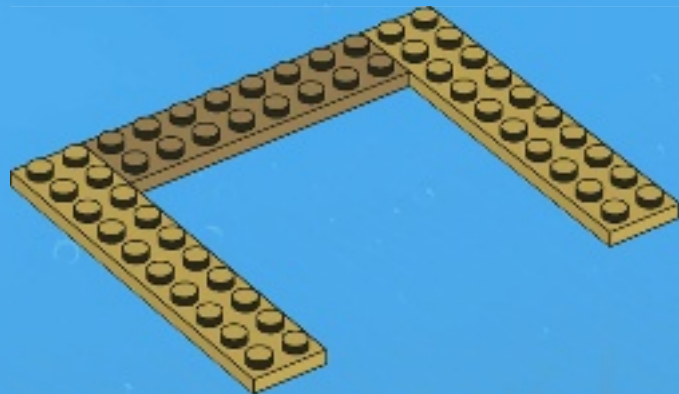

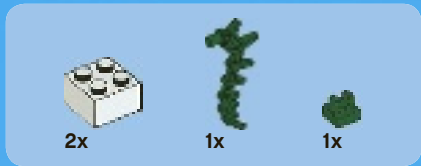

2

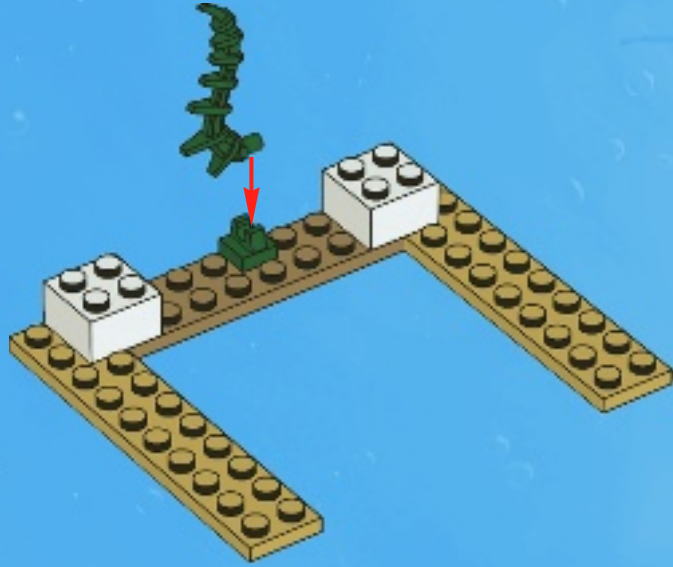

3





1x



1x

4

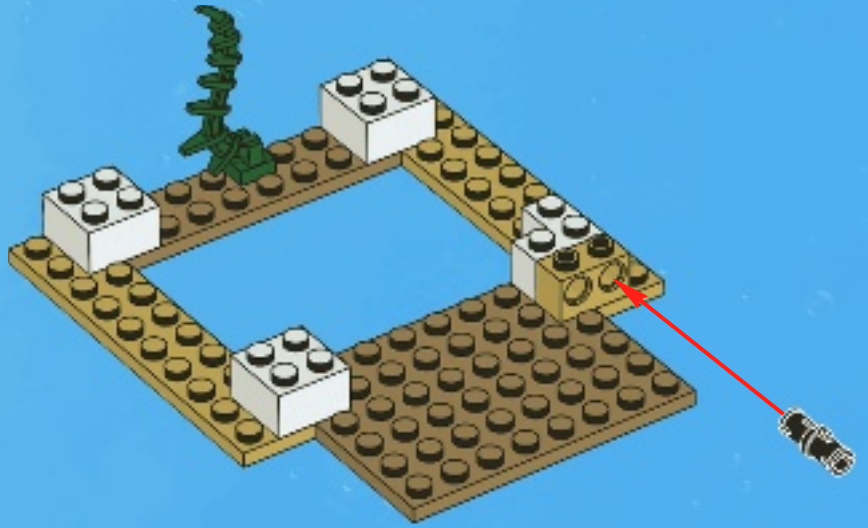

12x



3x

5

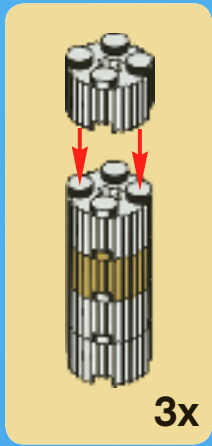

3x

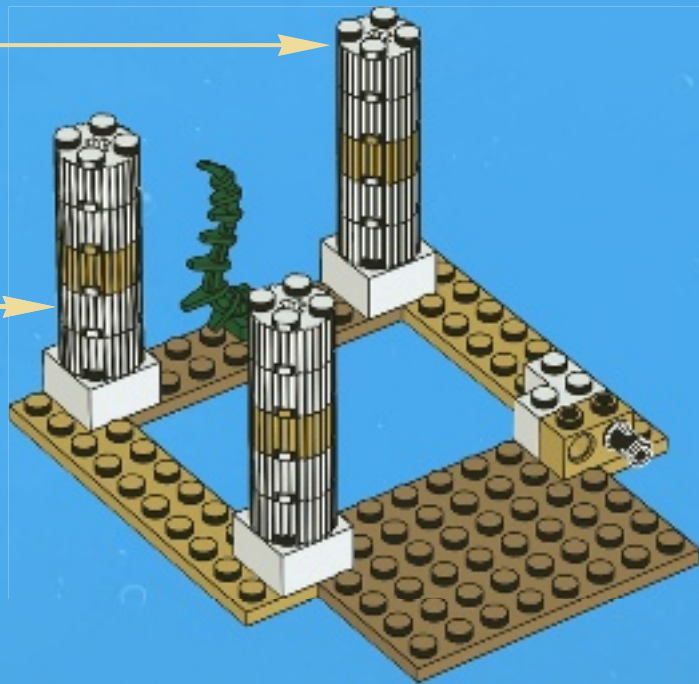

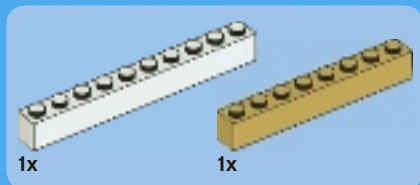

6

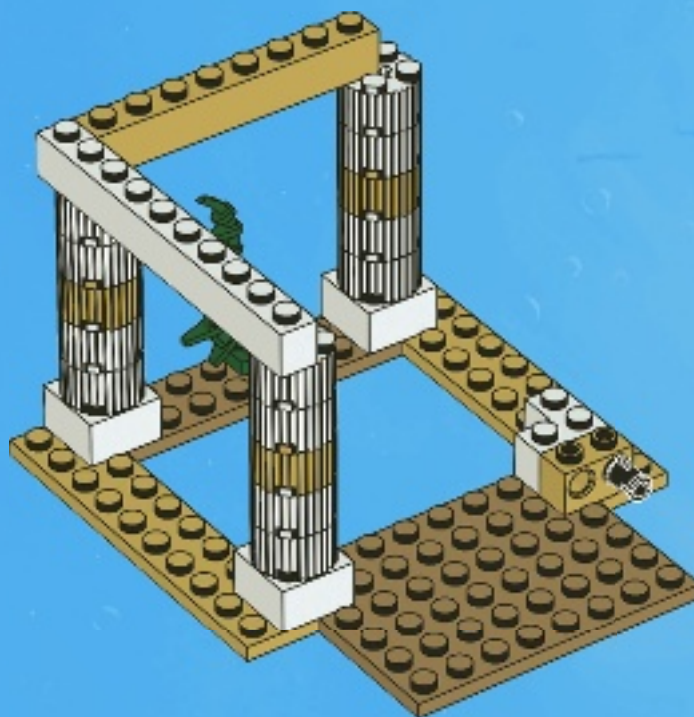

9

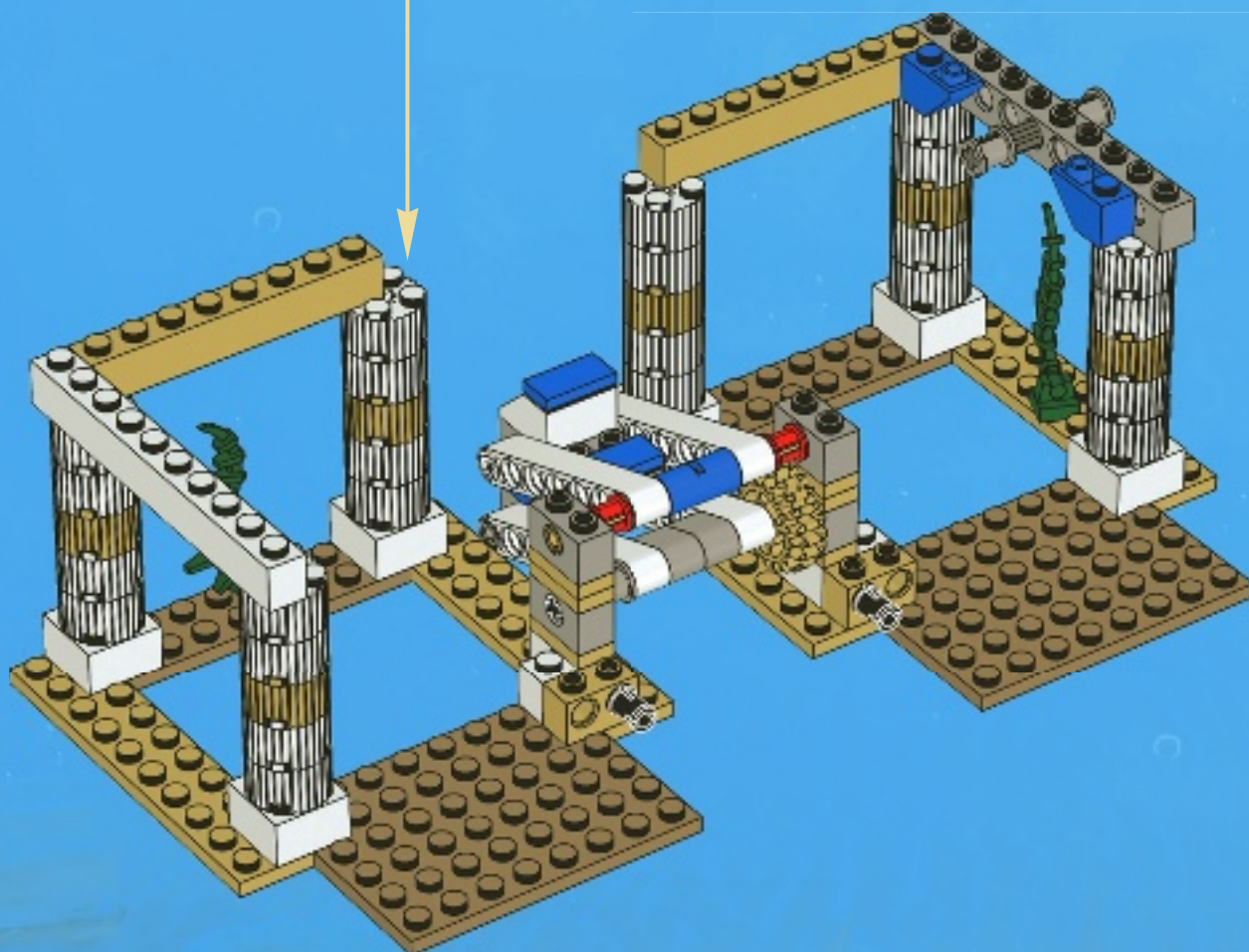



10

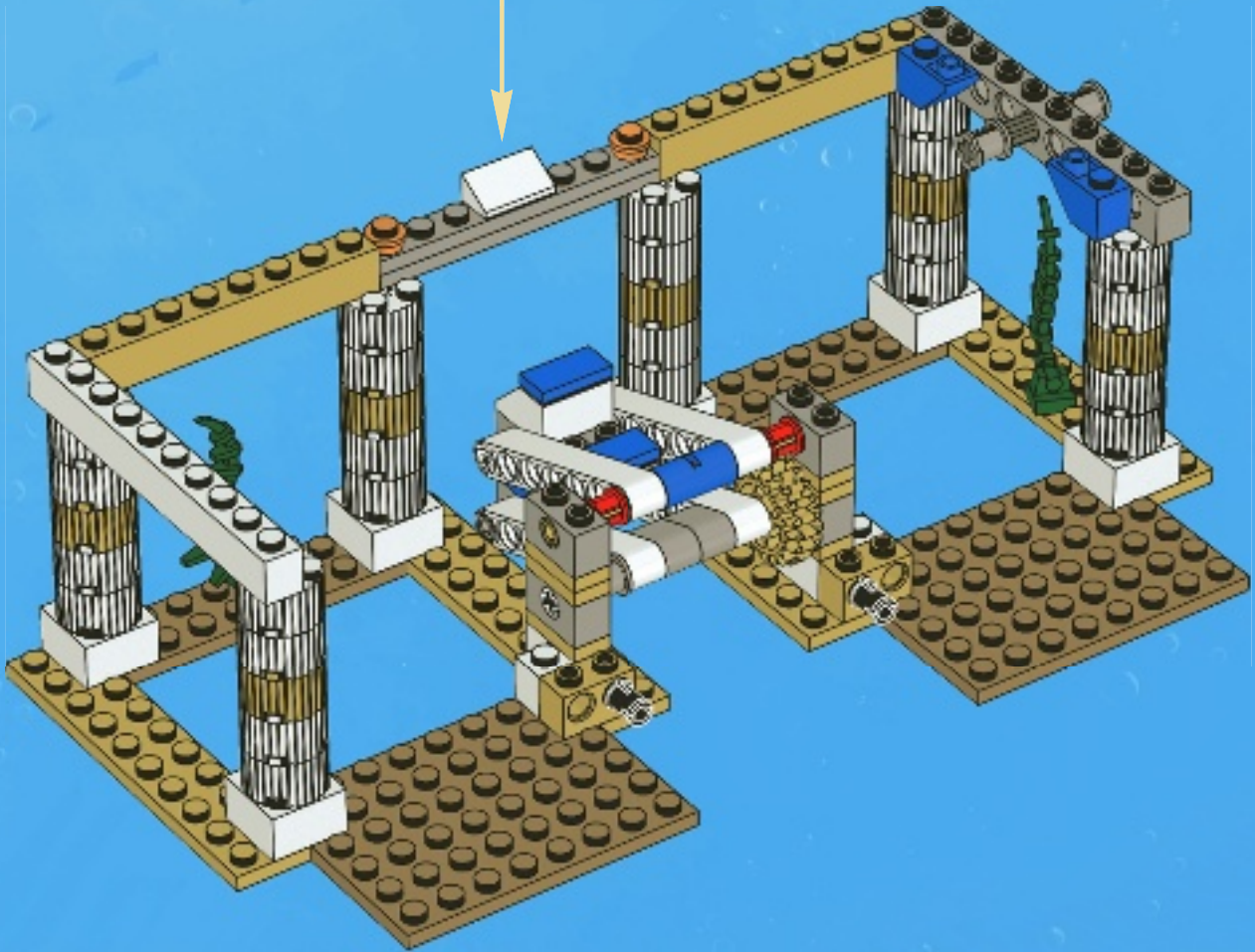
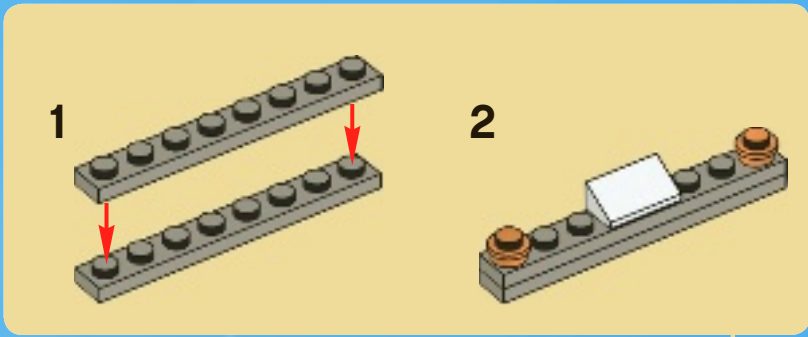

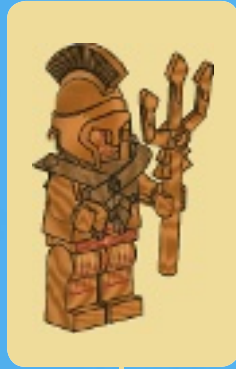

11

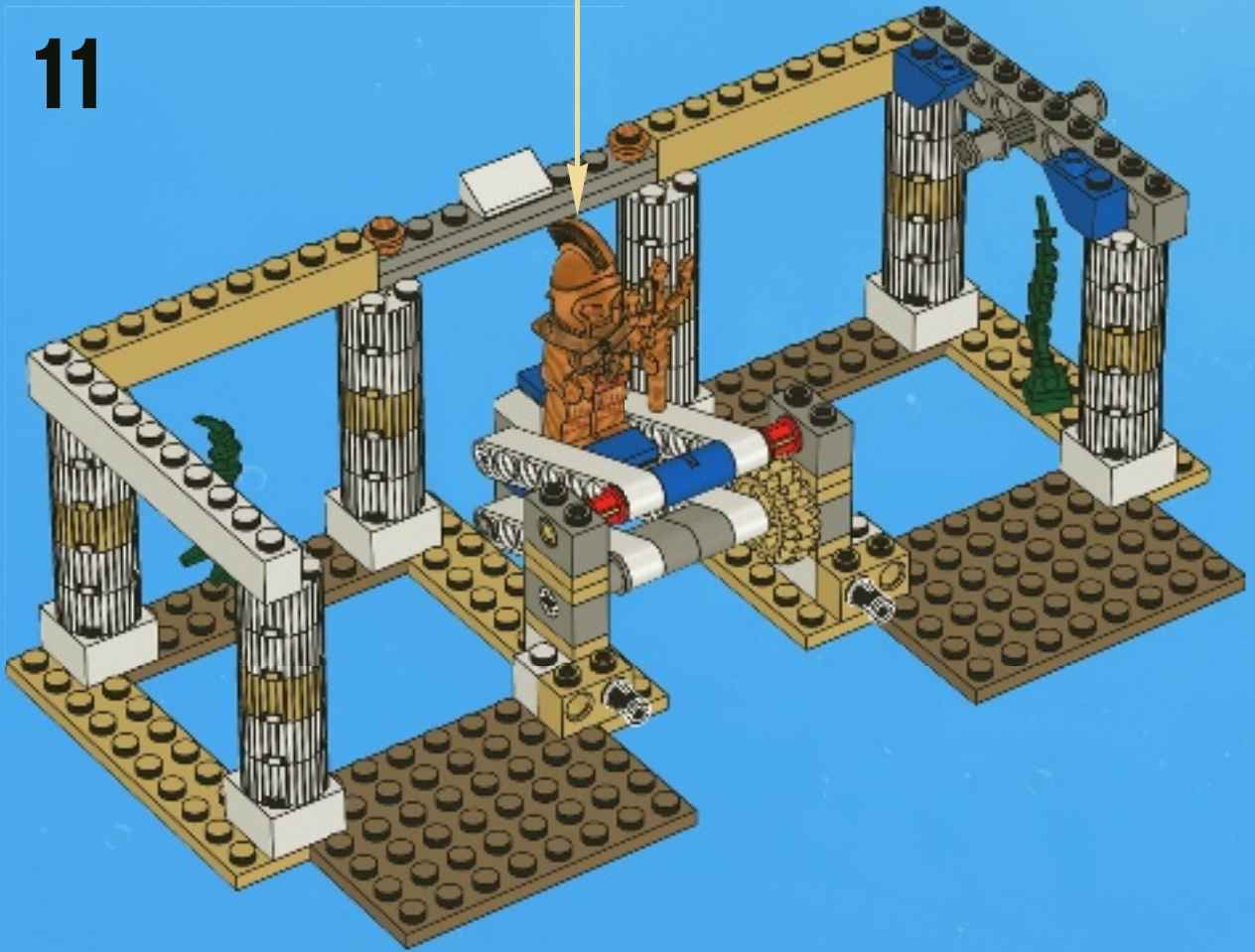



6x



4x

12

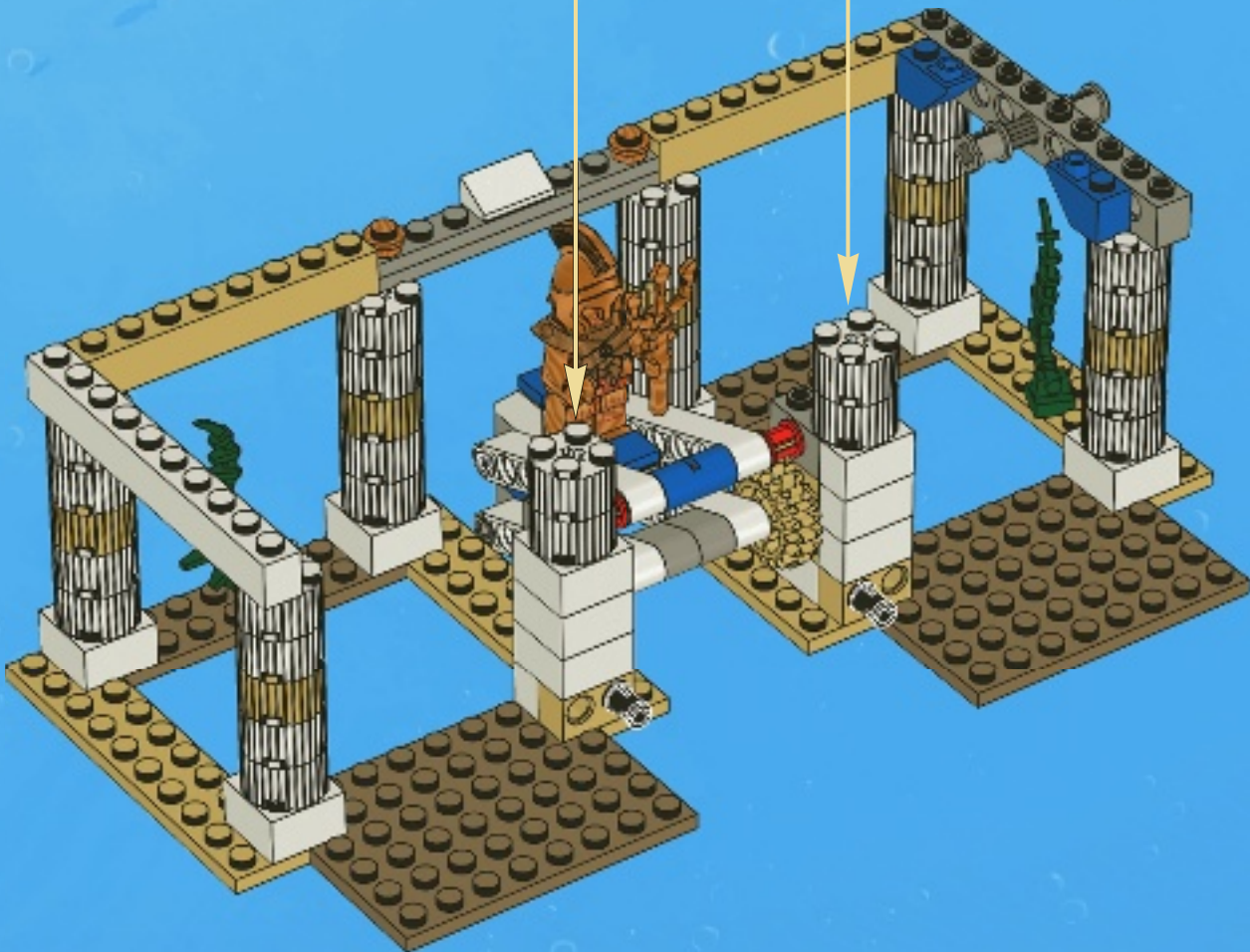
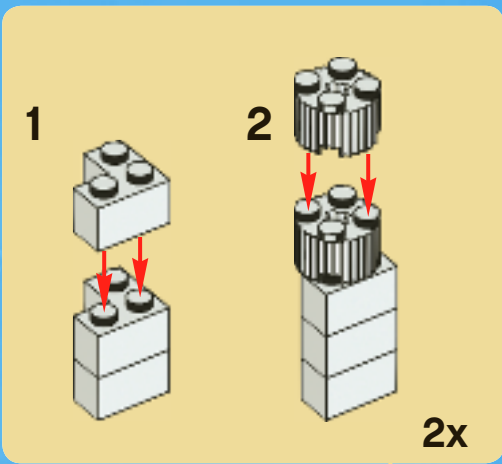

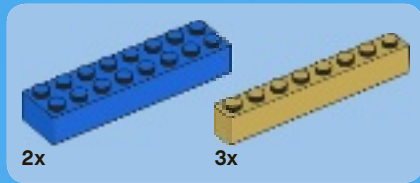

13

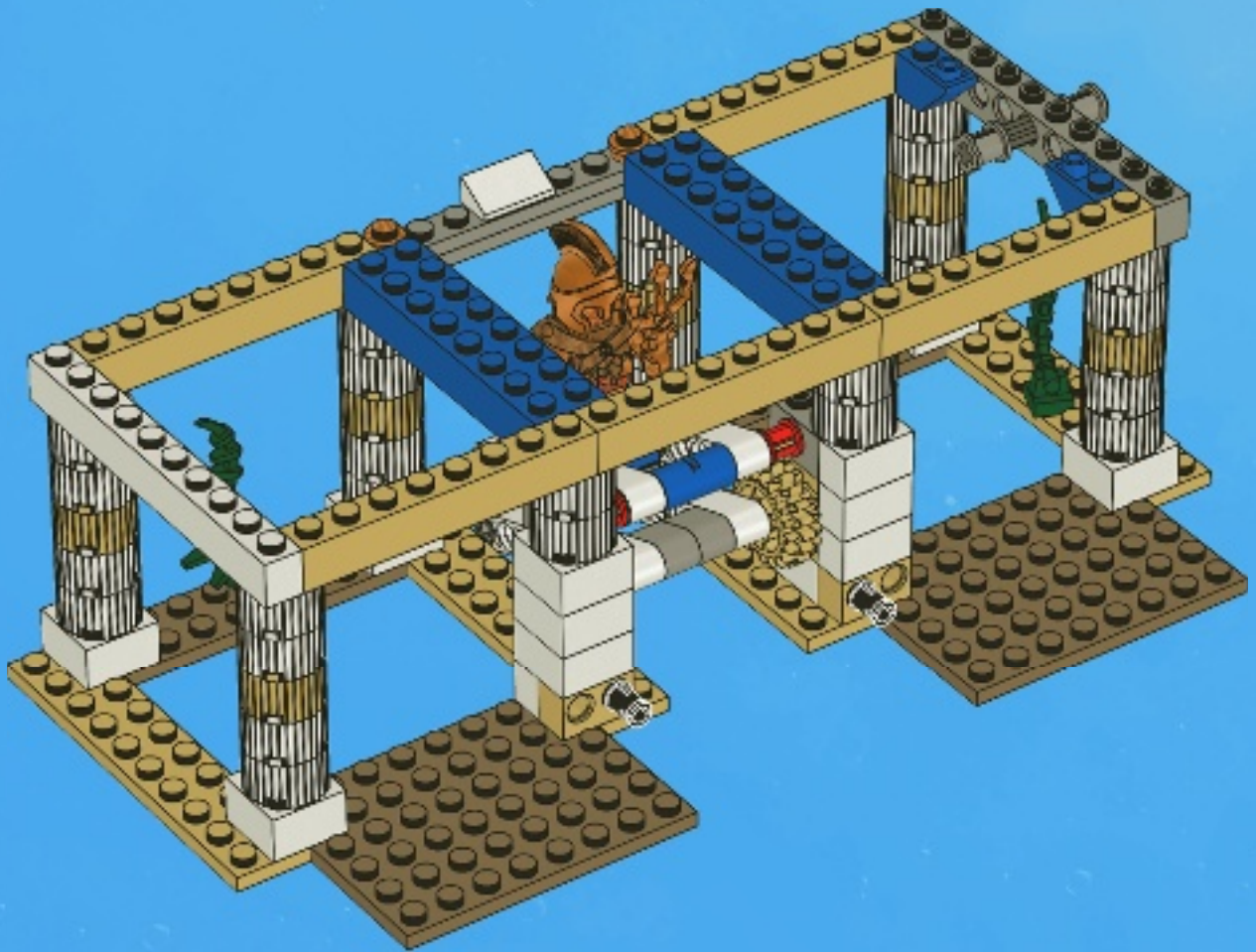

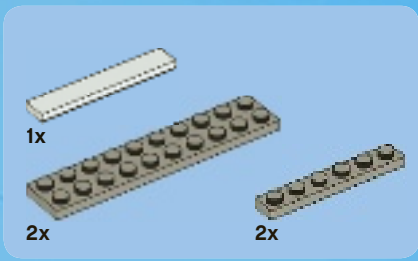

14

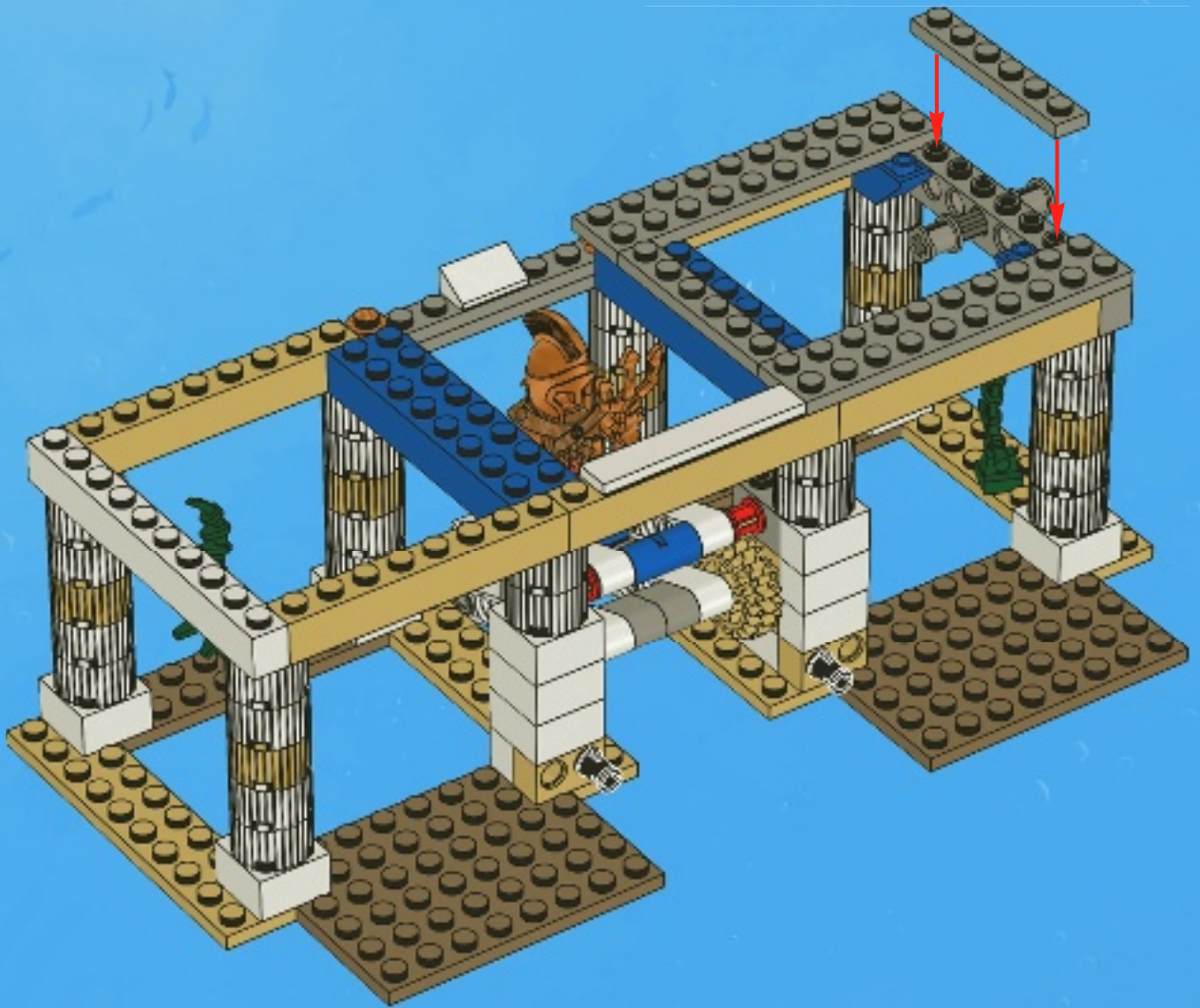

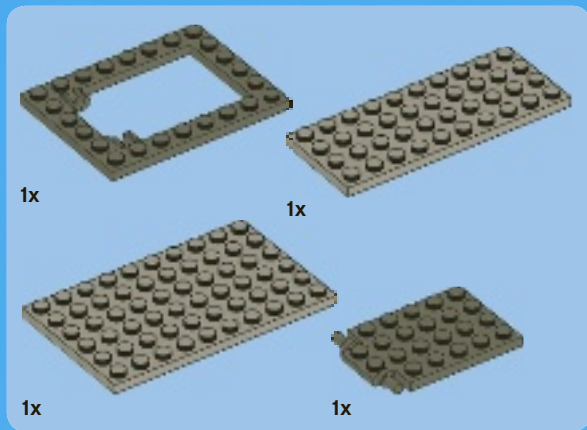

15

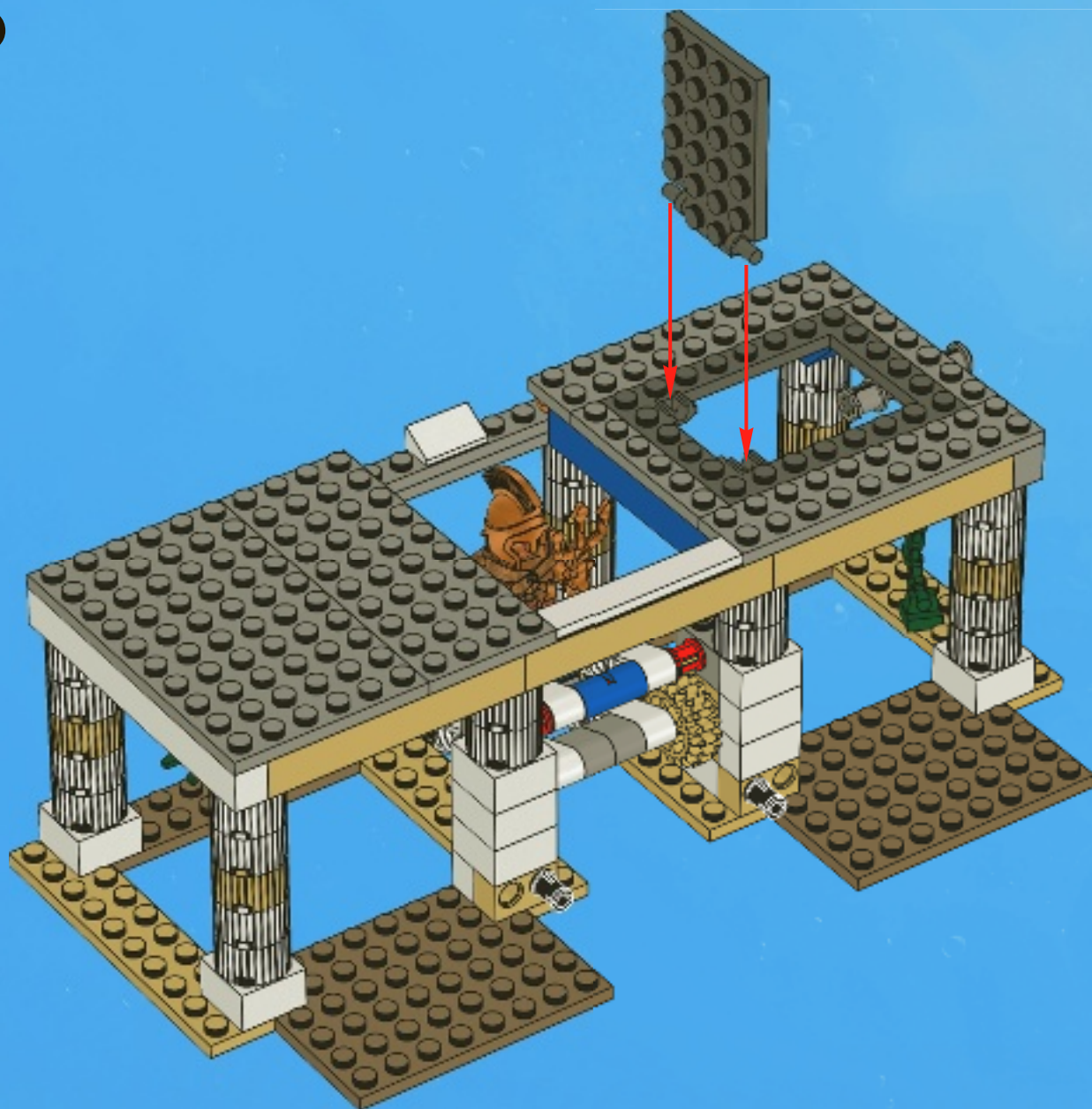



4x



2x

16

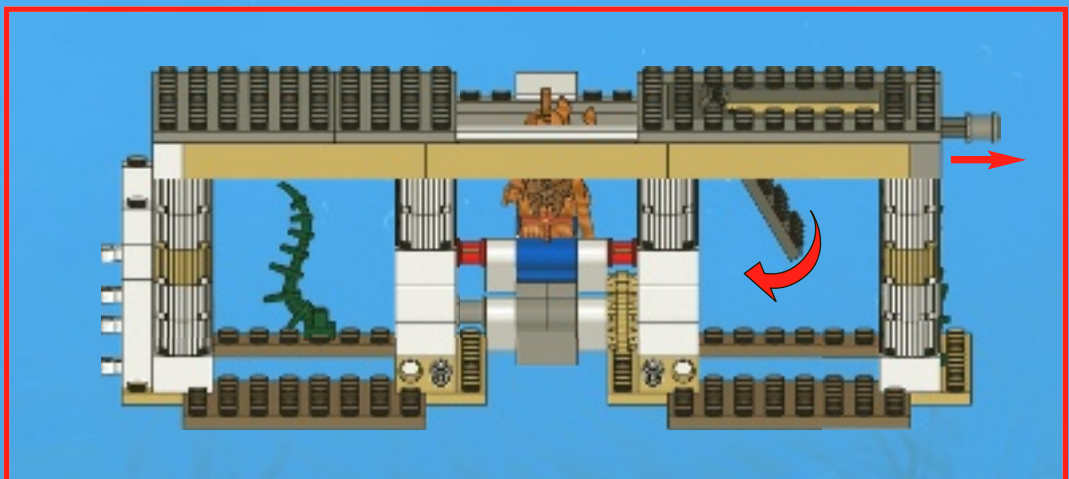
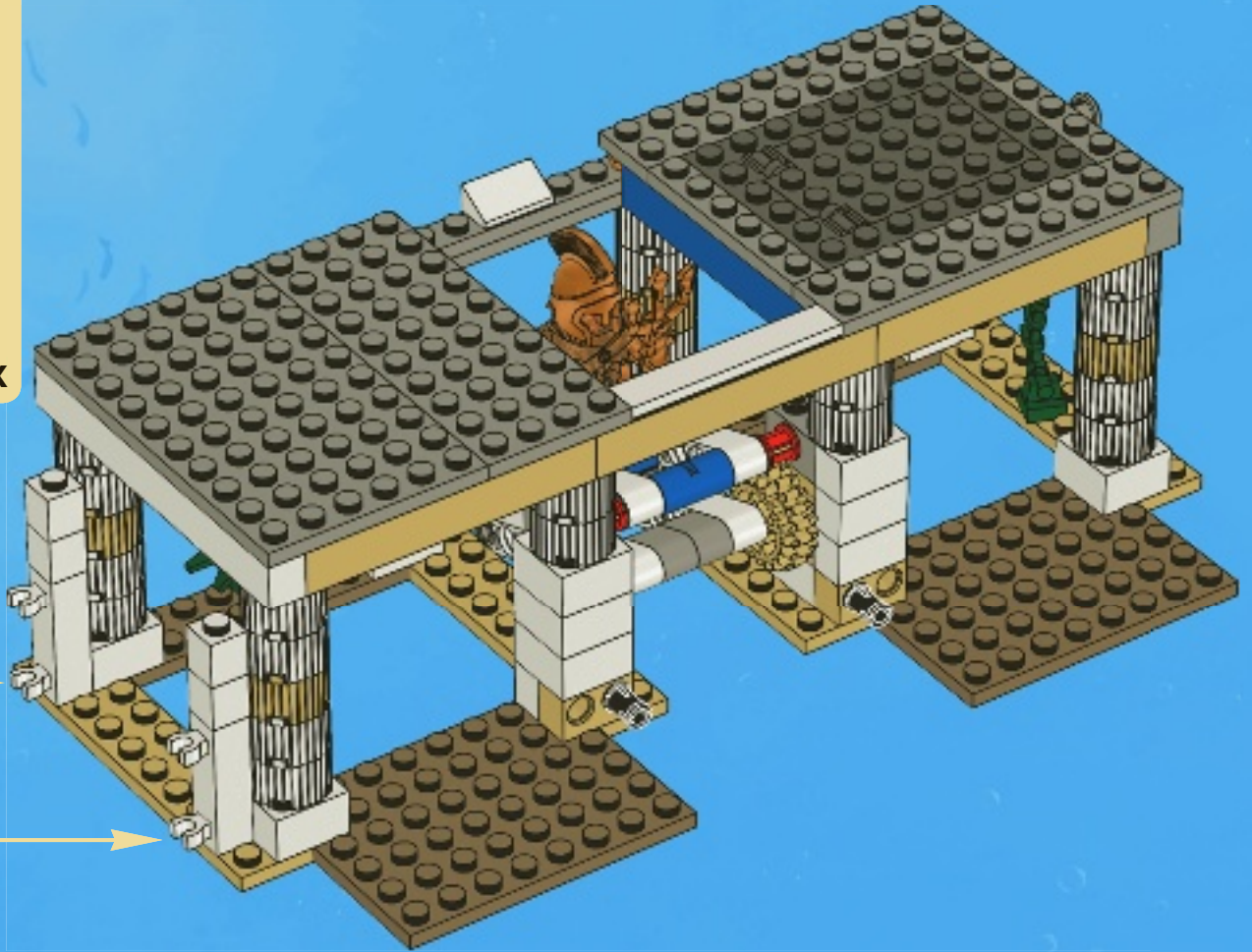
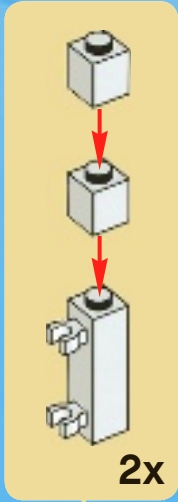

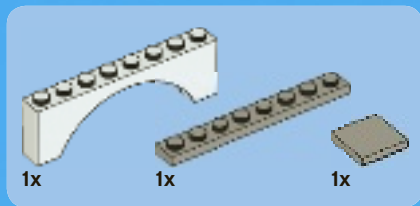

17

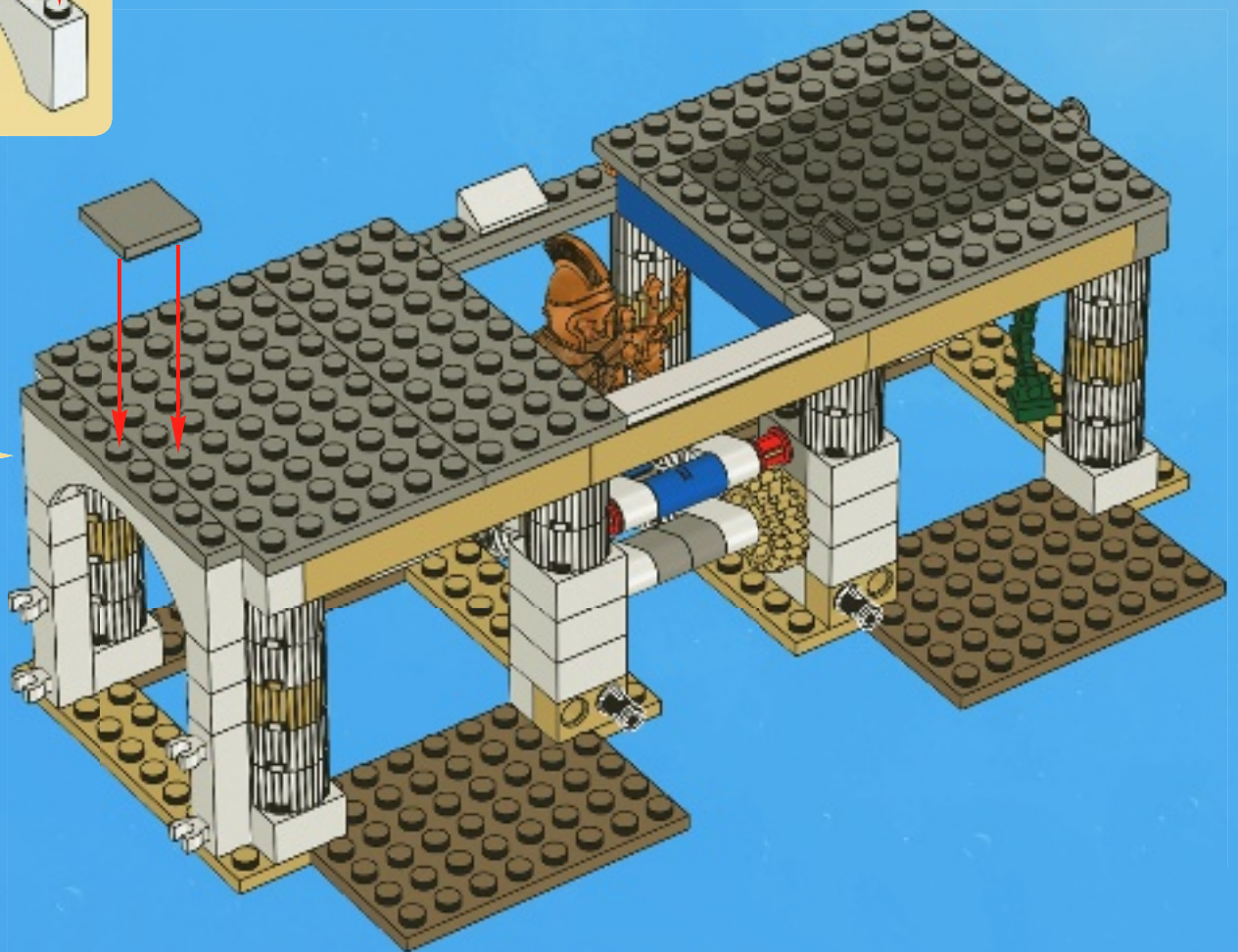
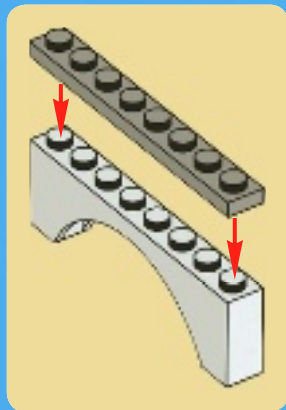



2x

18

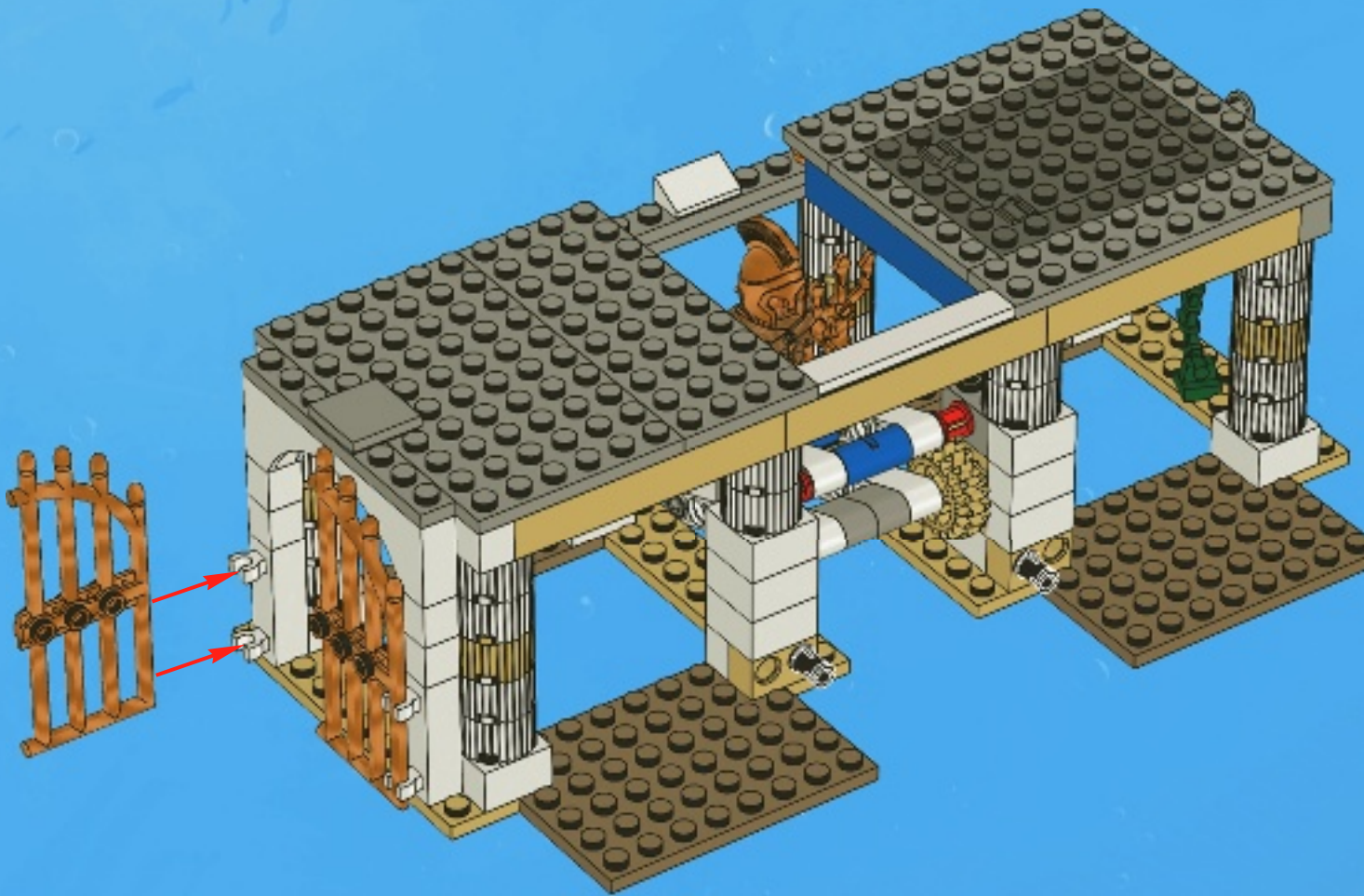



1x

19

1



2

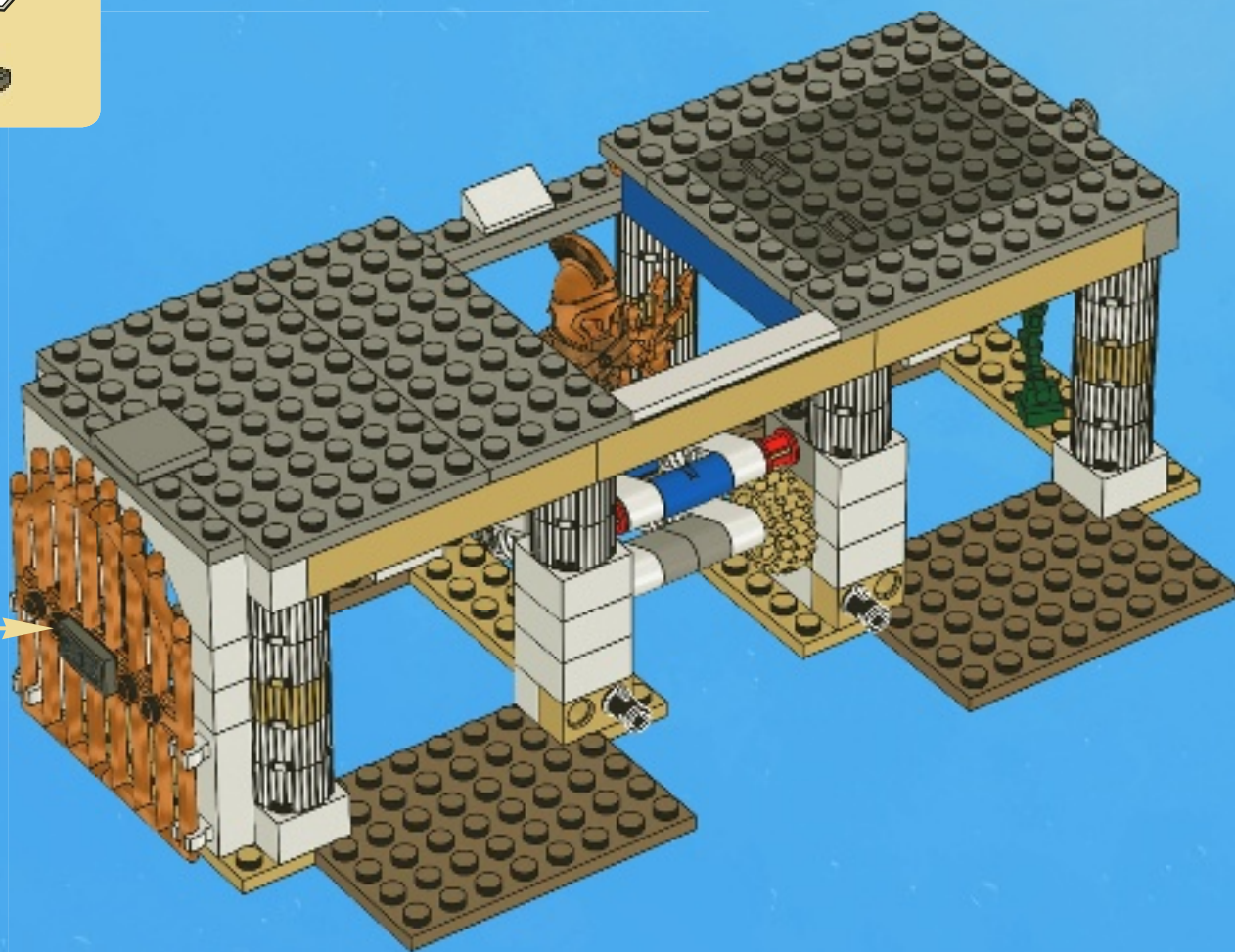
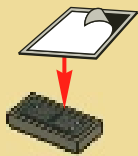



1x

1

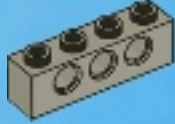

2x

2

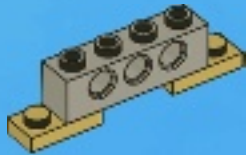

2x

3

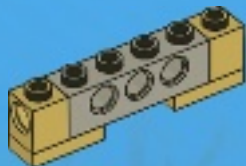

2x

4

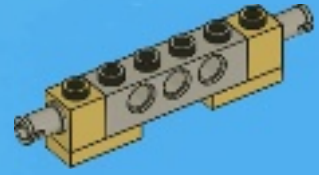

1x



2x

5

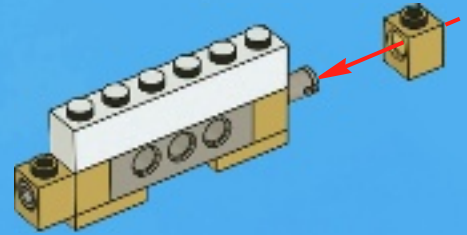

1x

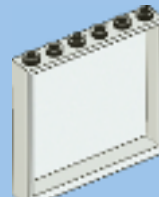

1x

6

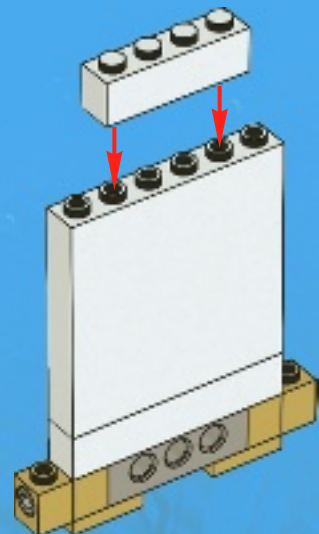



1x



2x

7

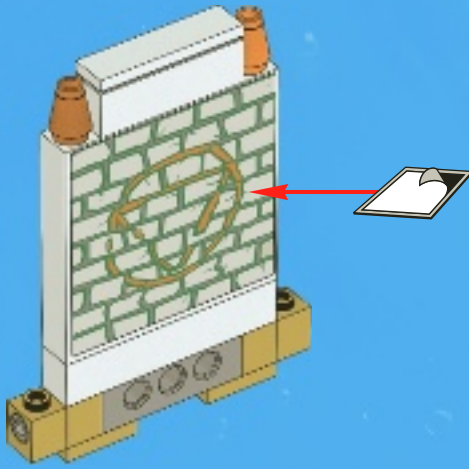

8

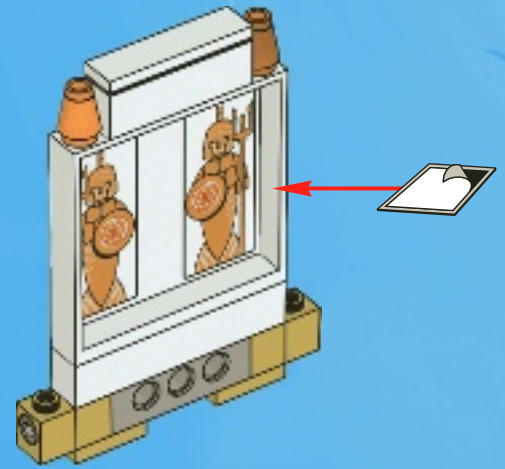

20

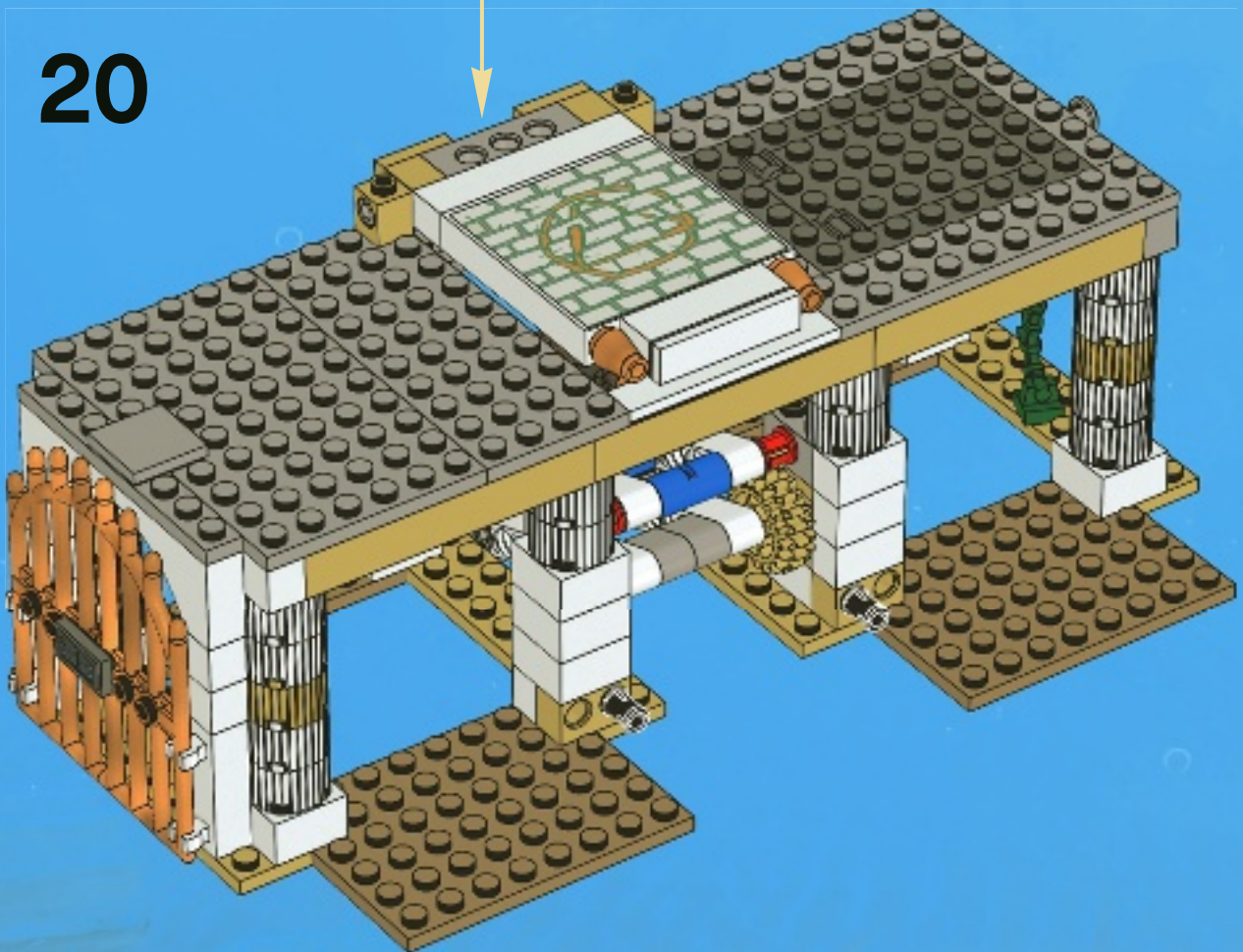



6x



2x

21

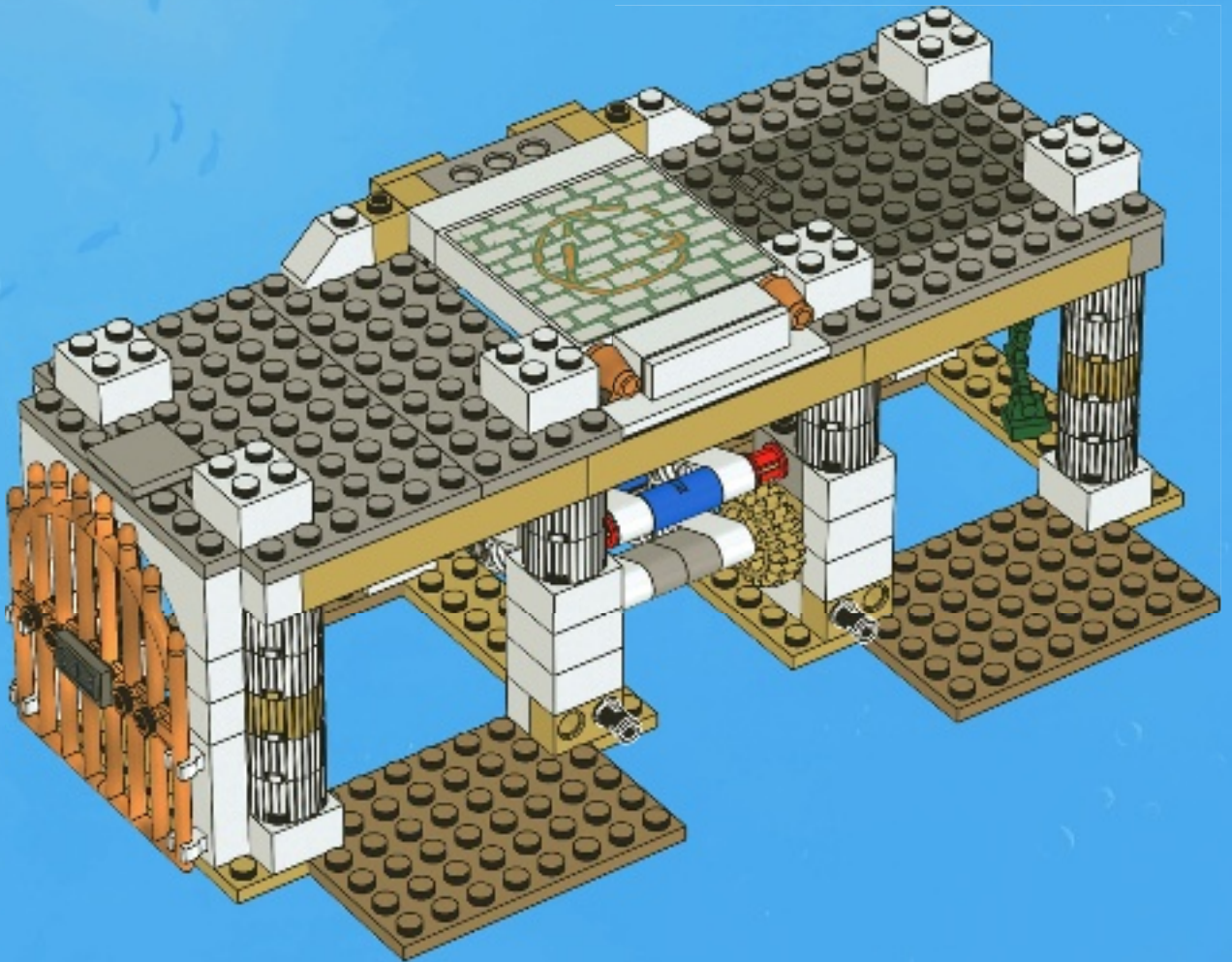

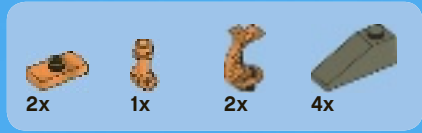

22

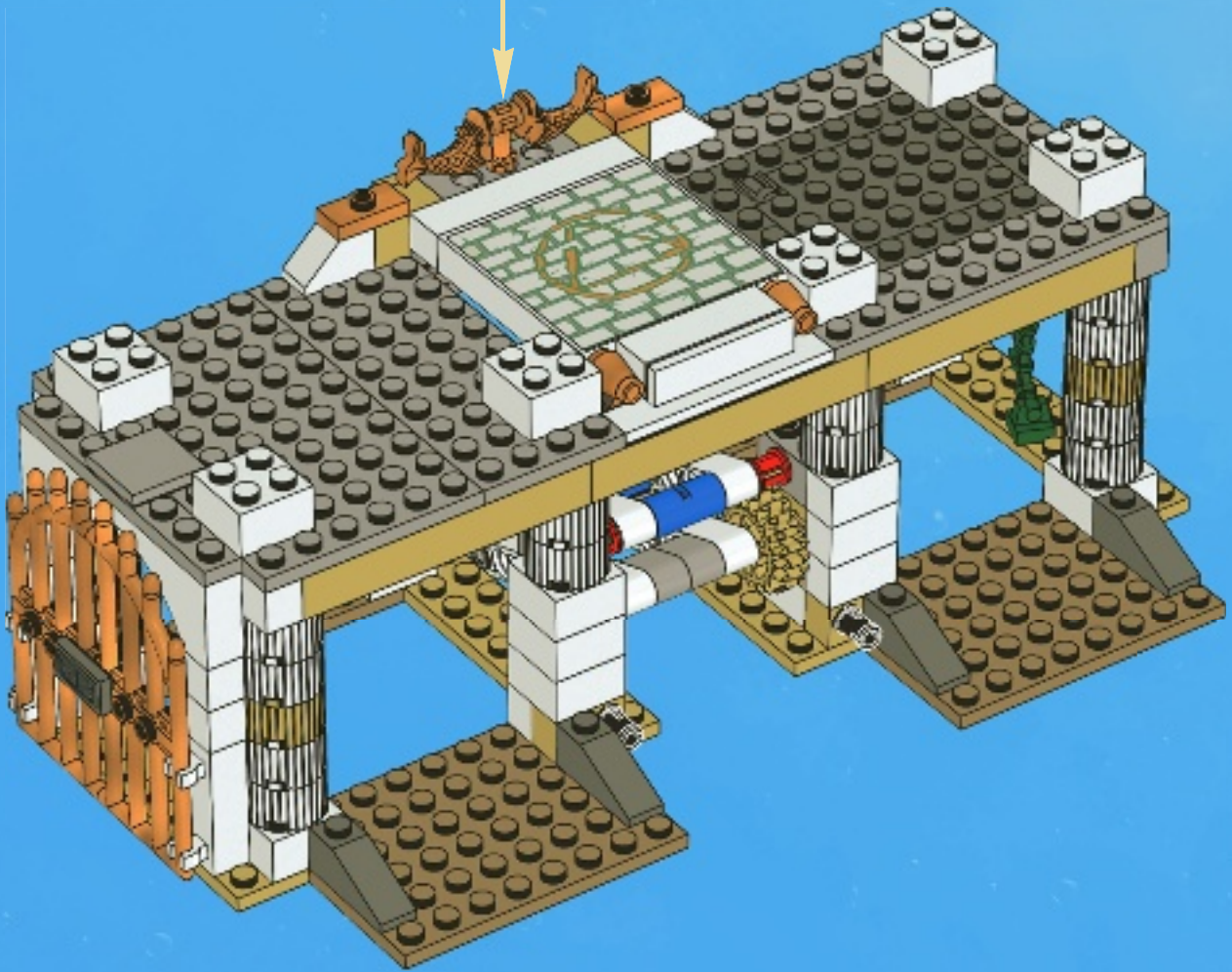
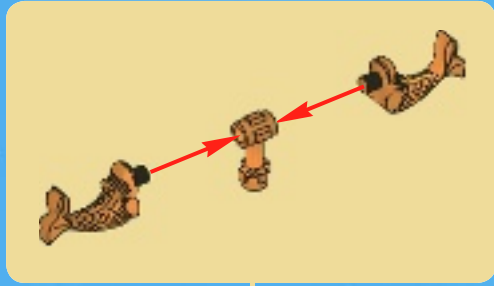



2x



2x



4x

23

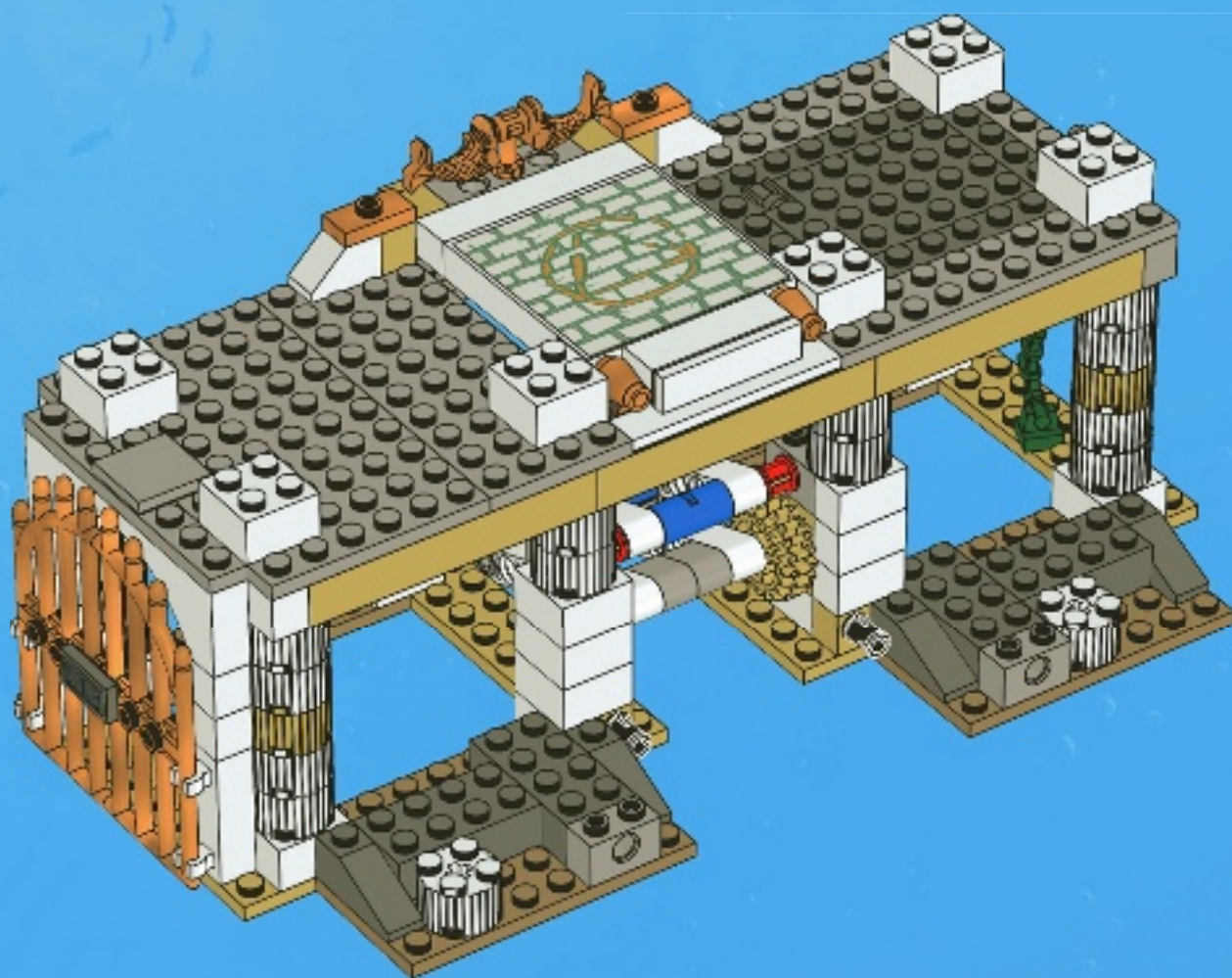



24

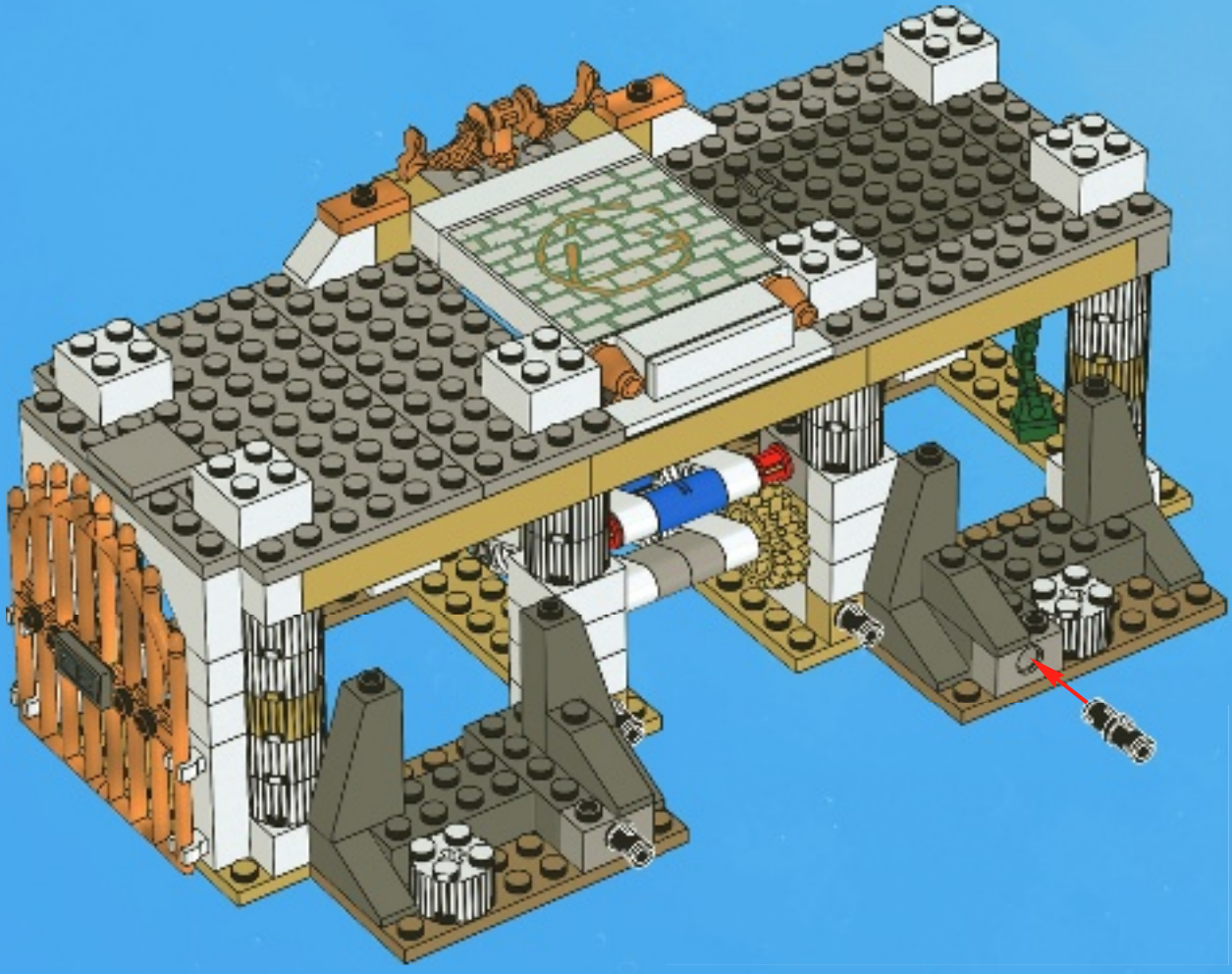

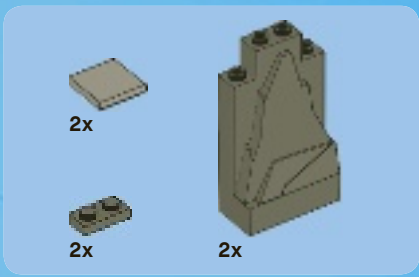

25

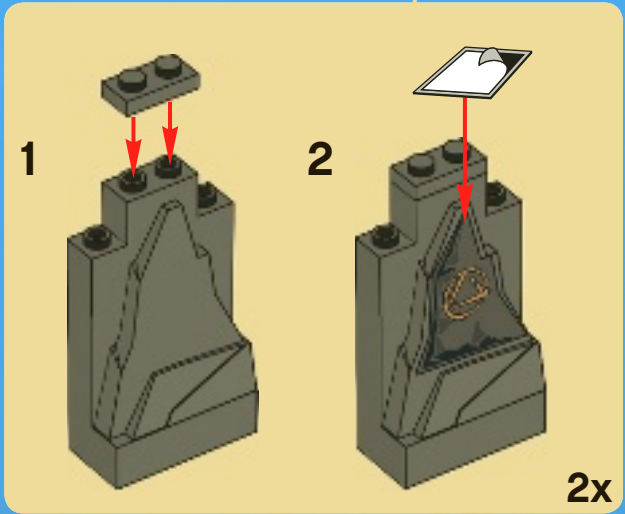
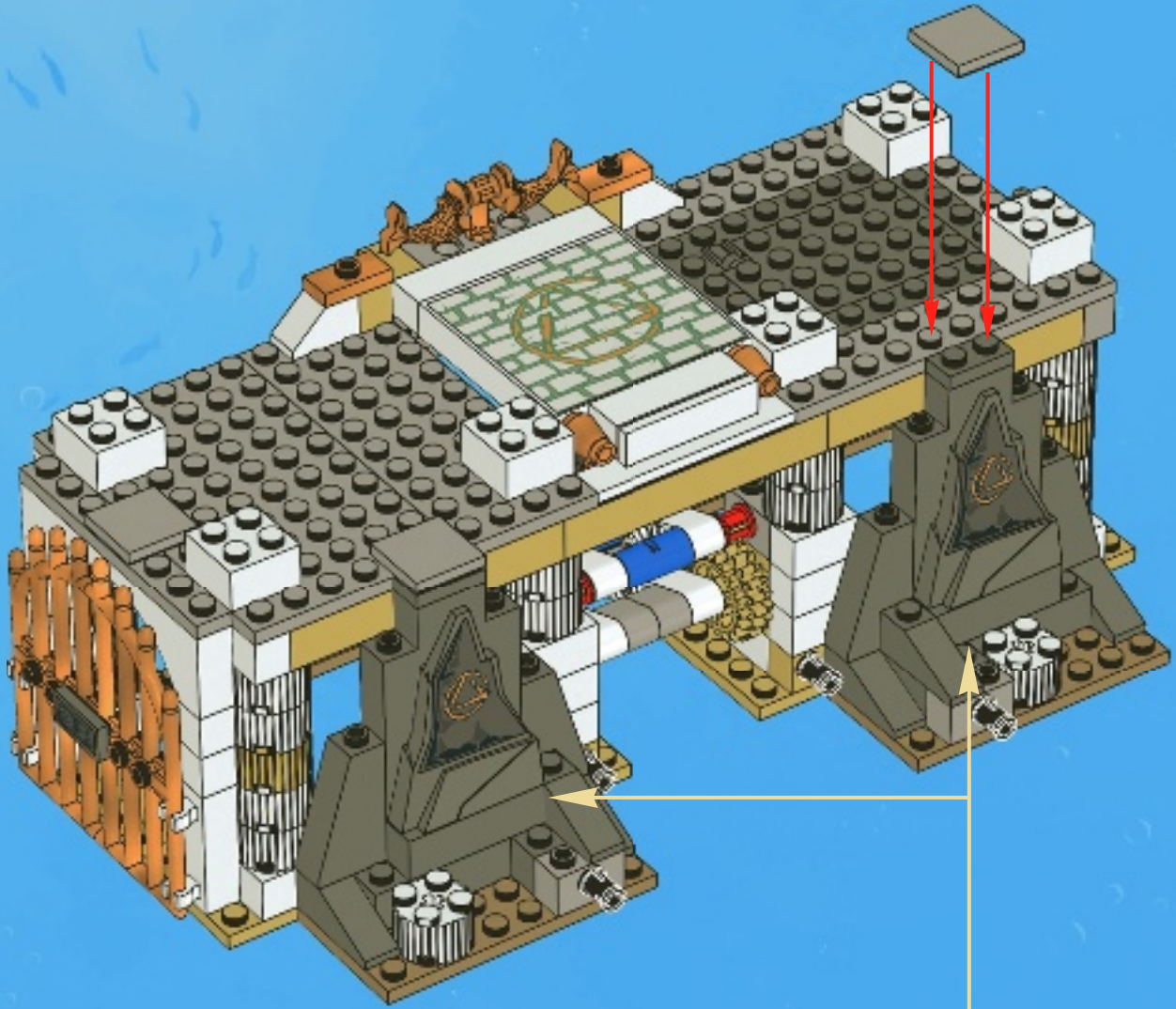

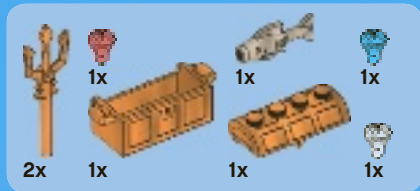

26

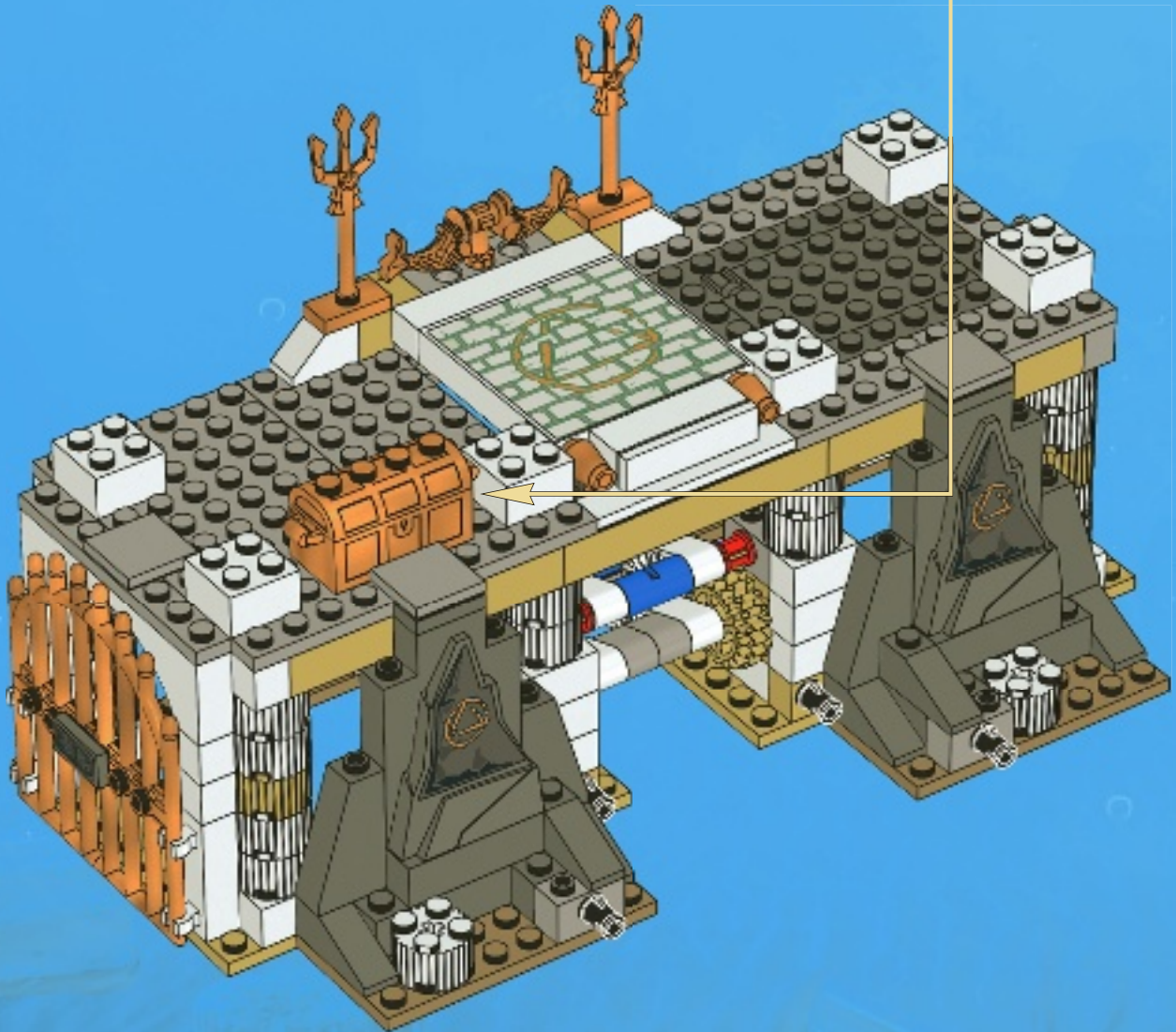
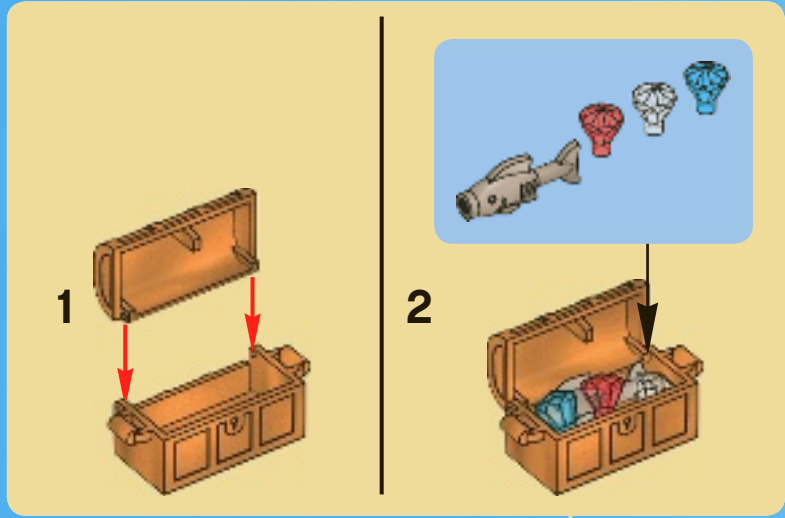



4

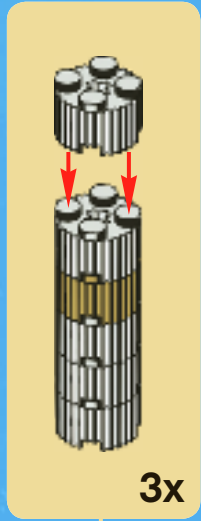

3x



27x



9x

27

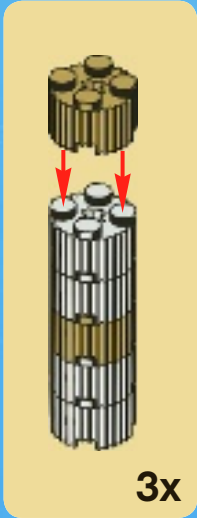

3x

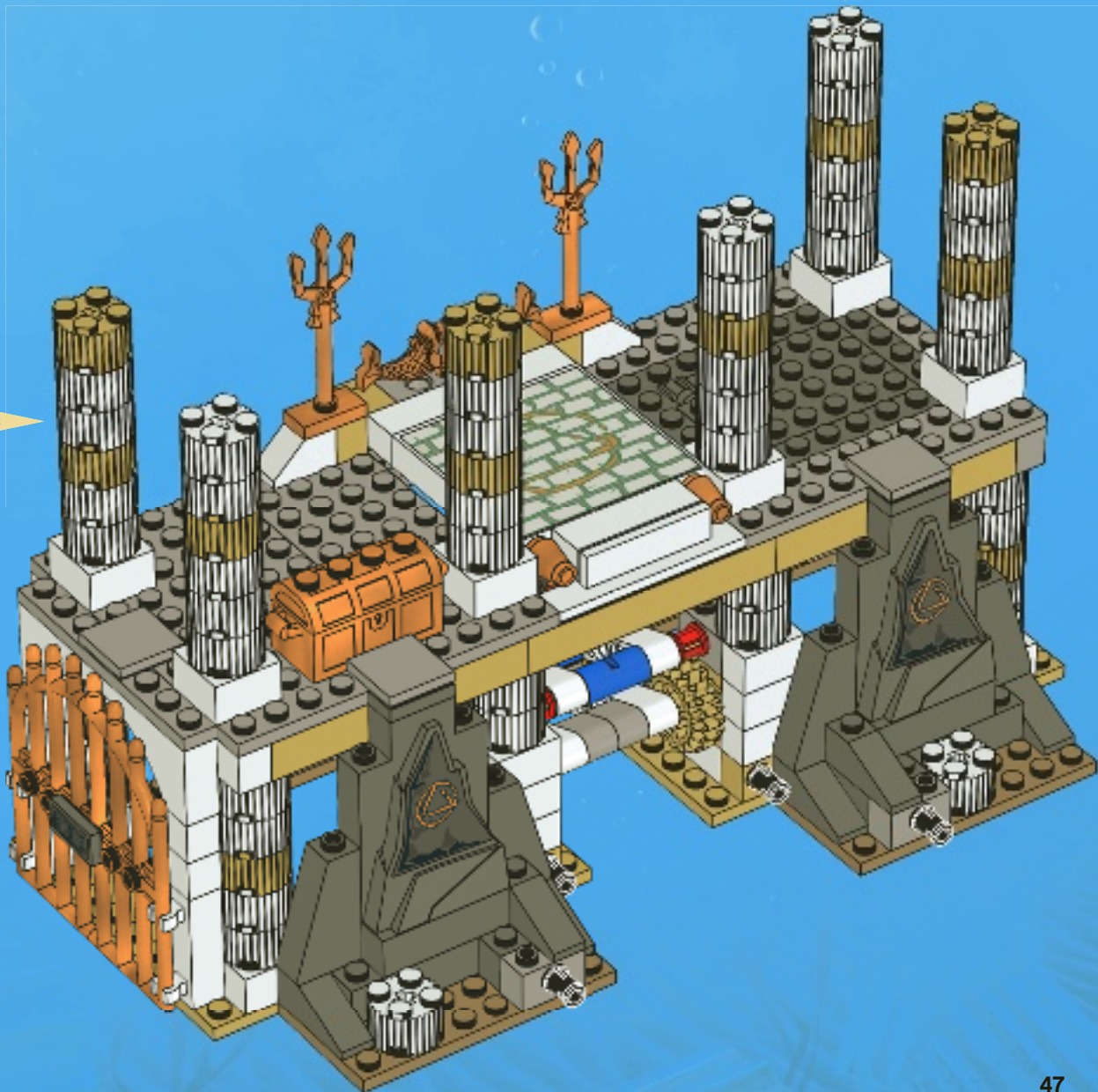



1x



1x

1



1x



1x

2



3x



3x

3

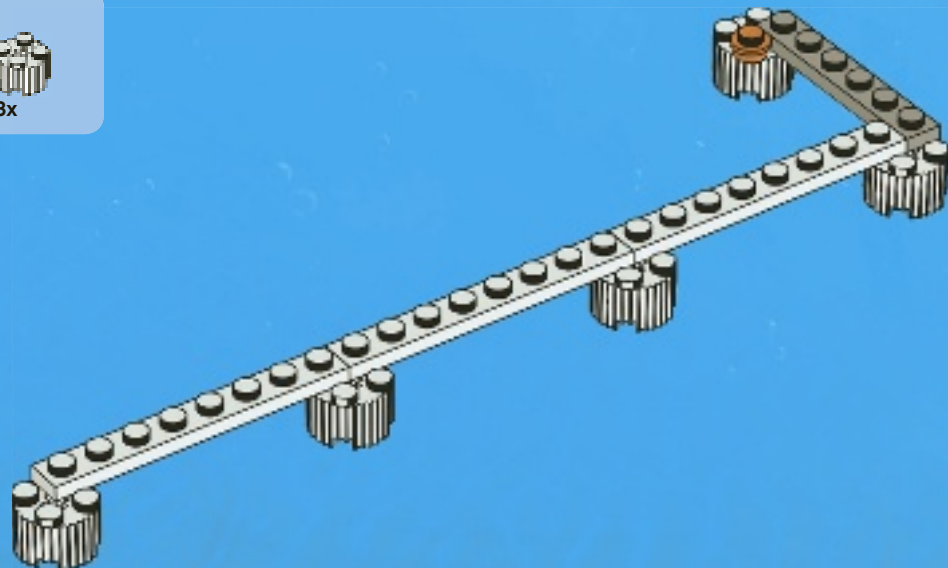



4

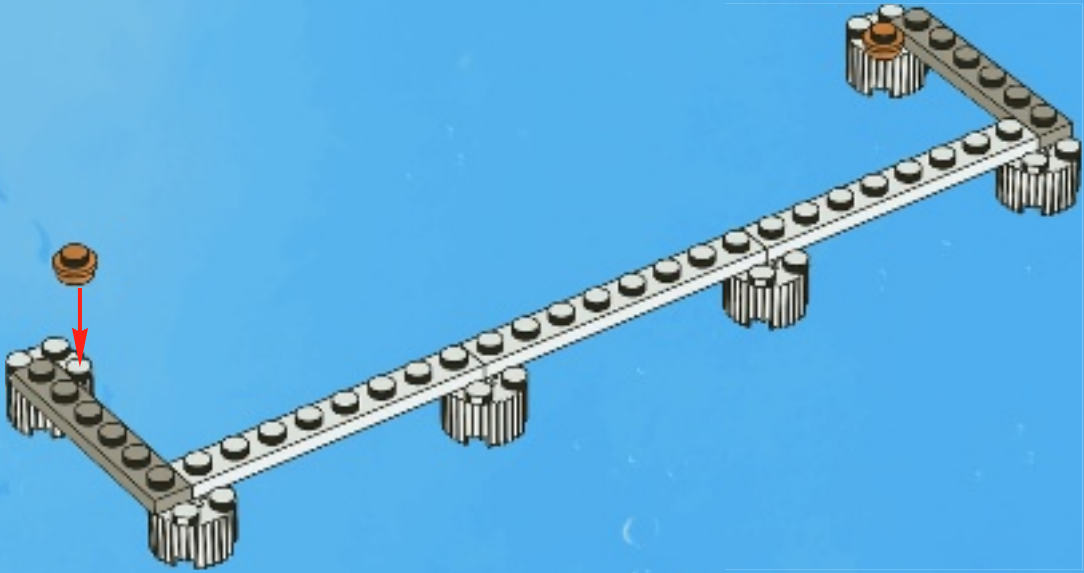

5

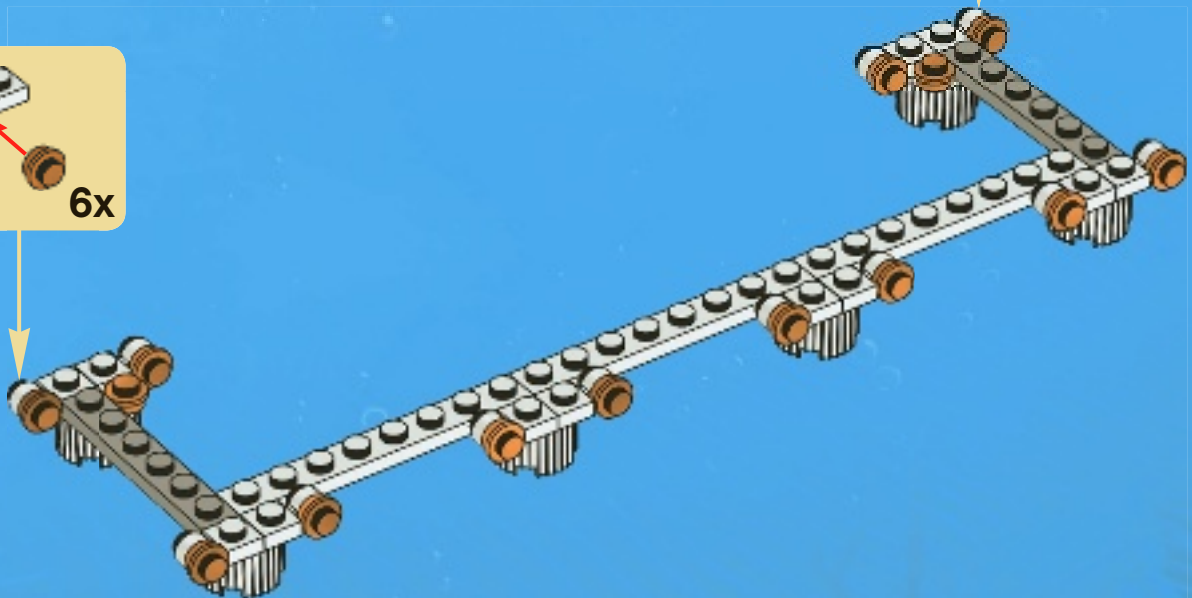
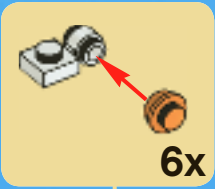



6x

6

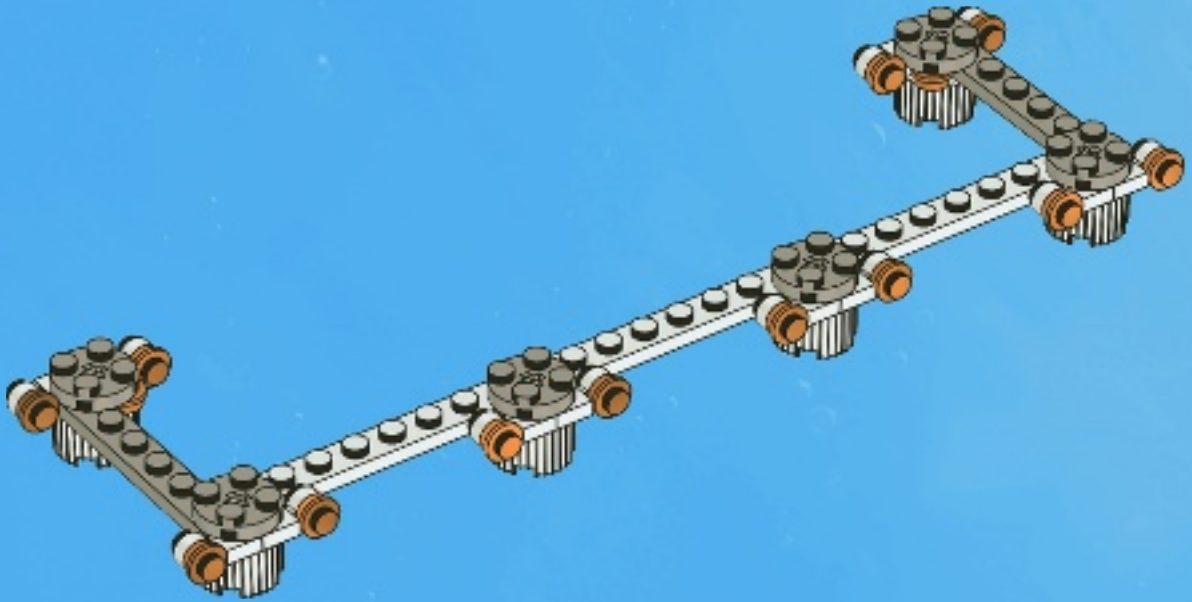

2x



3x

7

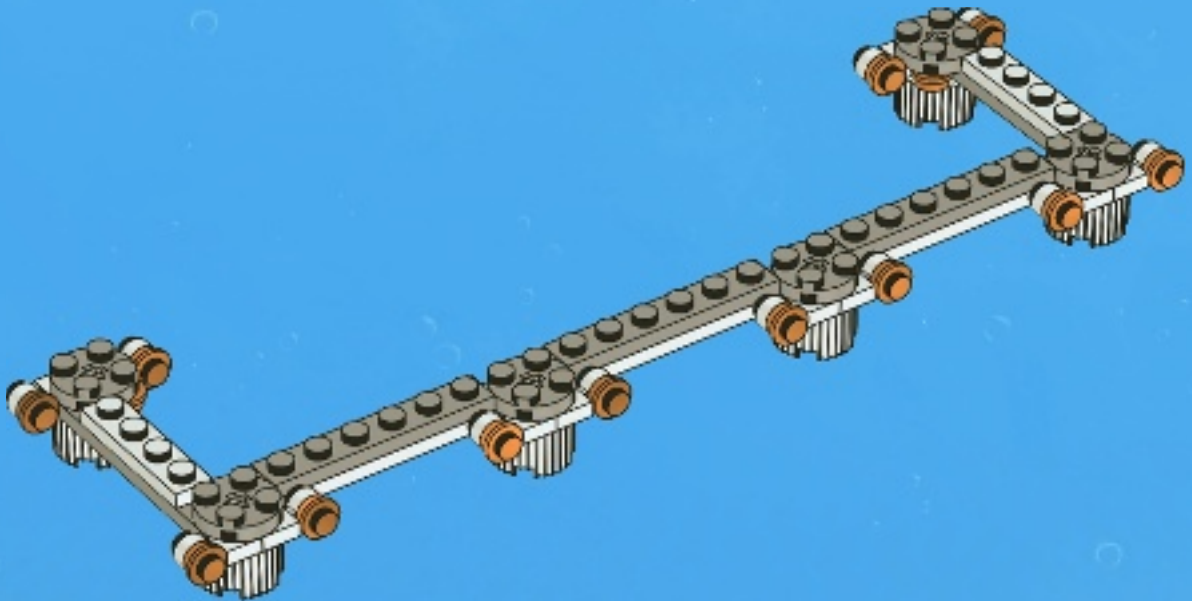

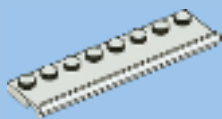

5x

8

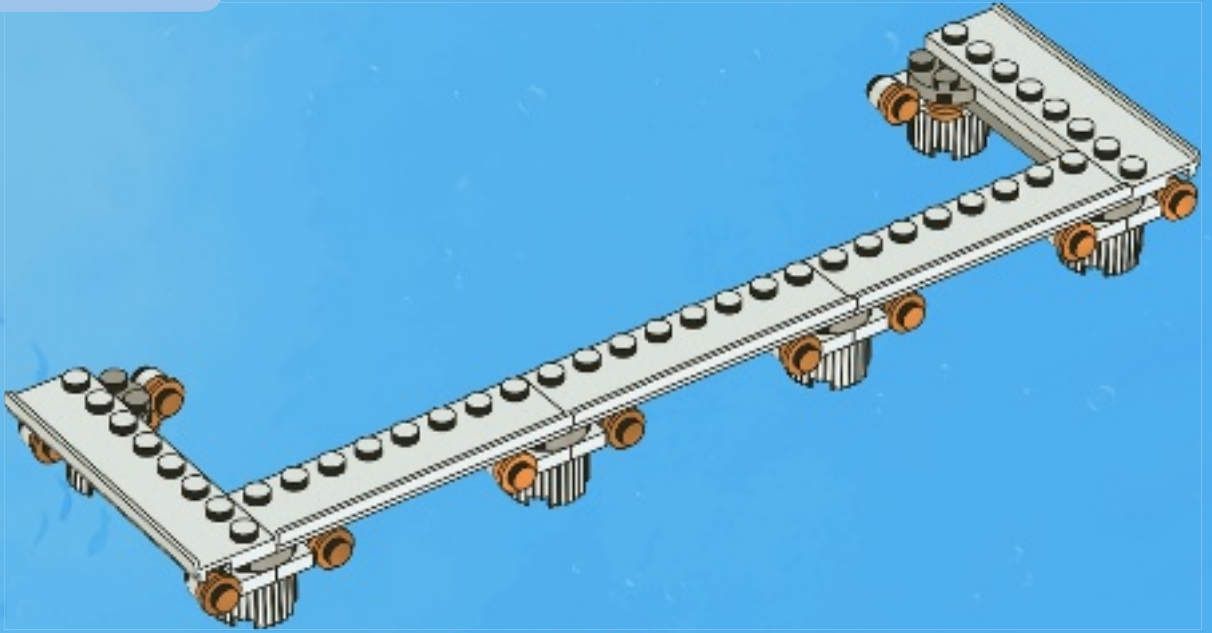

2x



2x



2x



4x

9

1

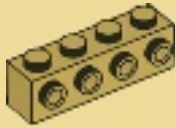

2

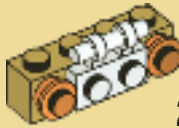

2x

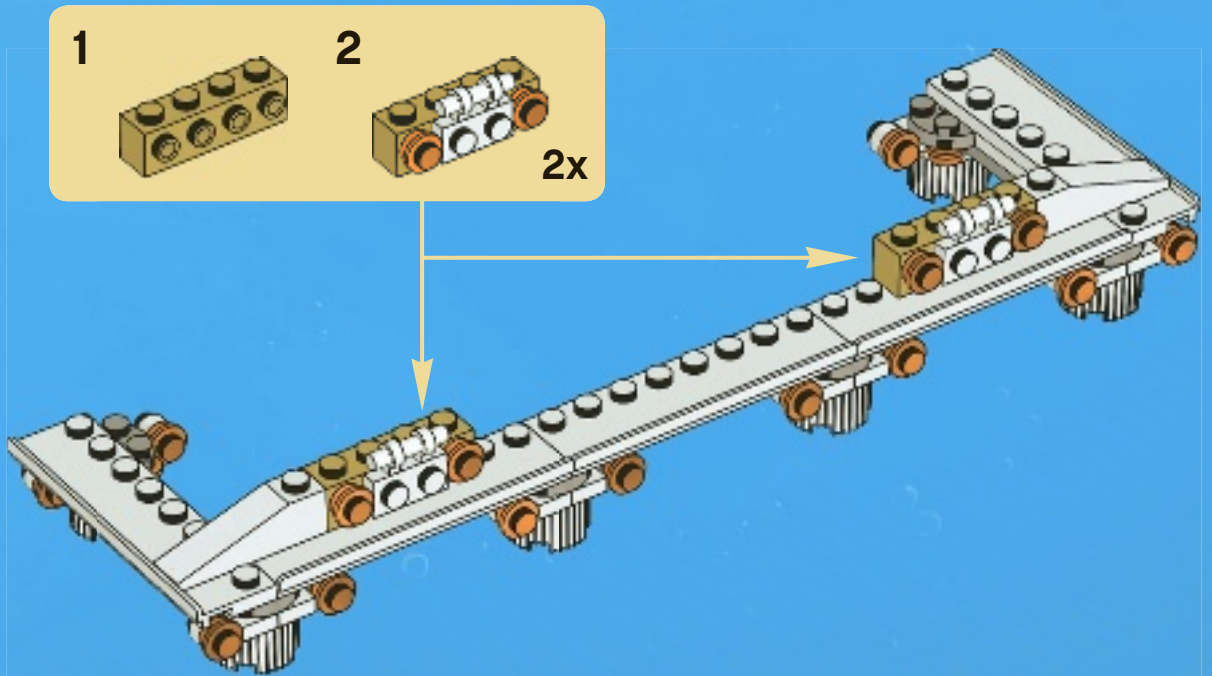



2x



2x

10

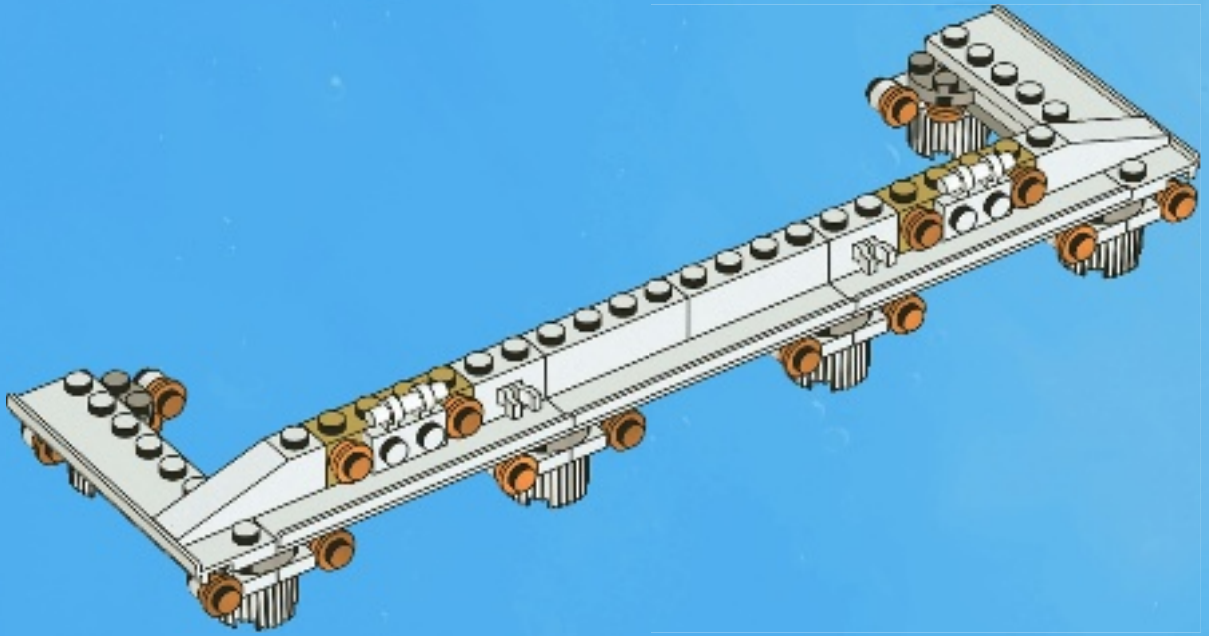

2x



1x



2x

11

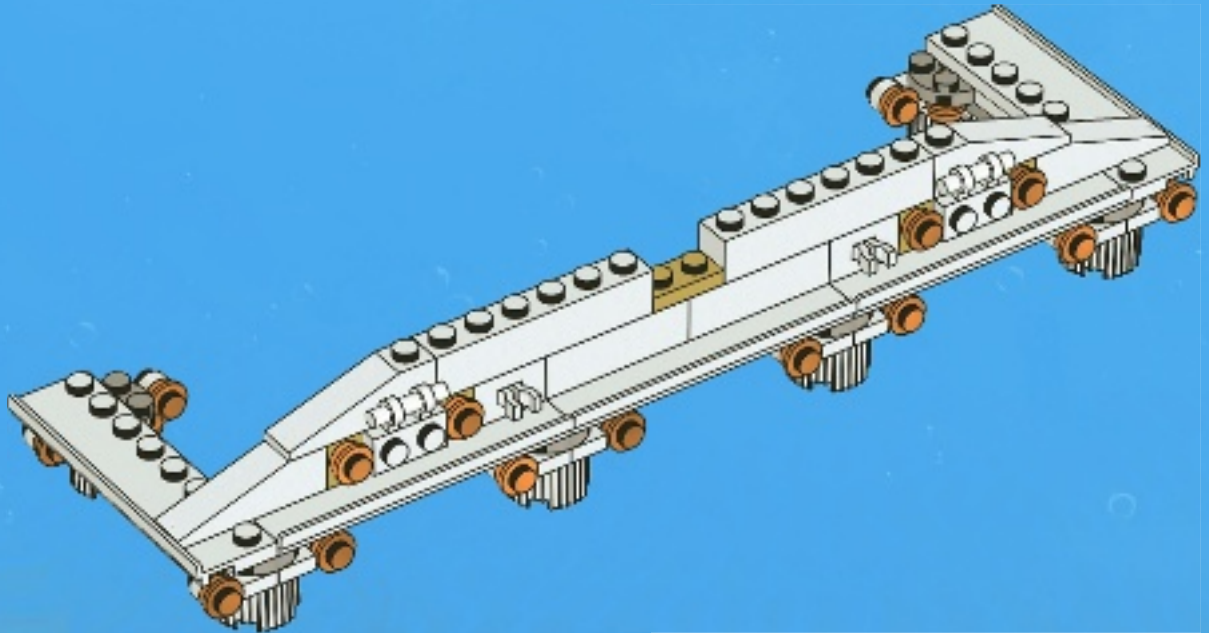



1x



2x

12

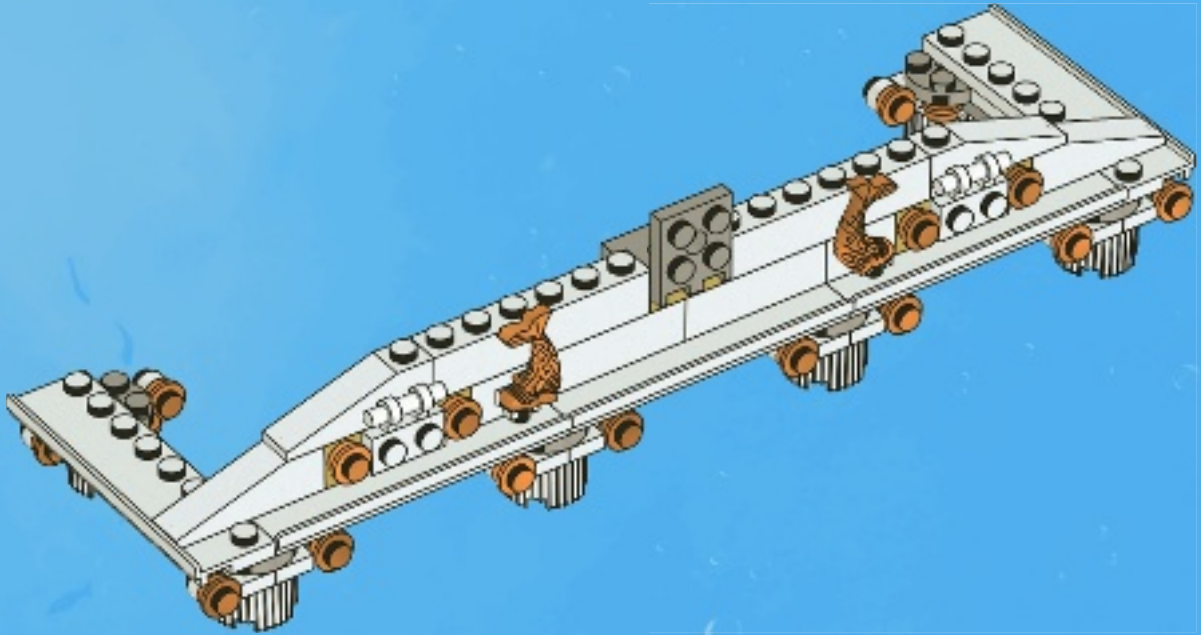

1x



2x



2x



2x

13

1



2

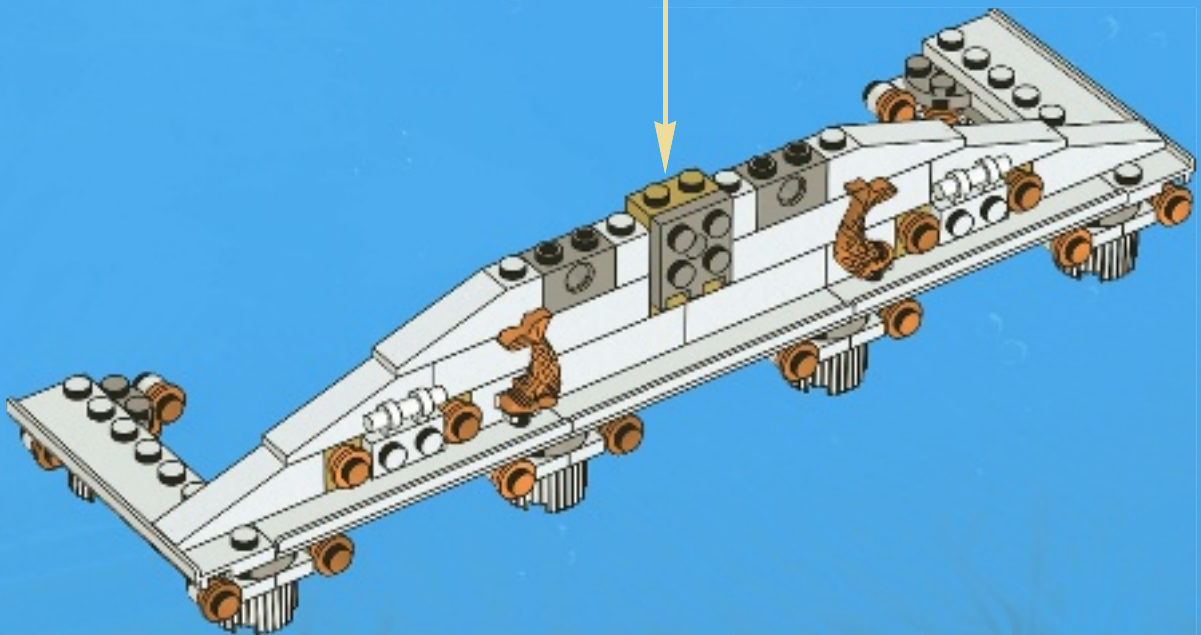
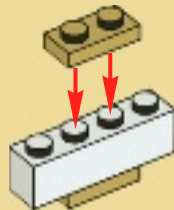



2x

14

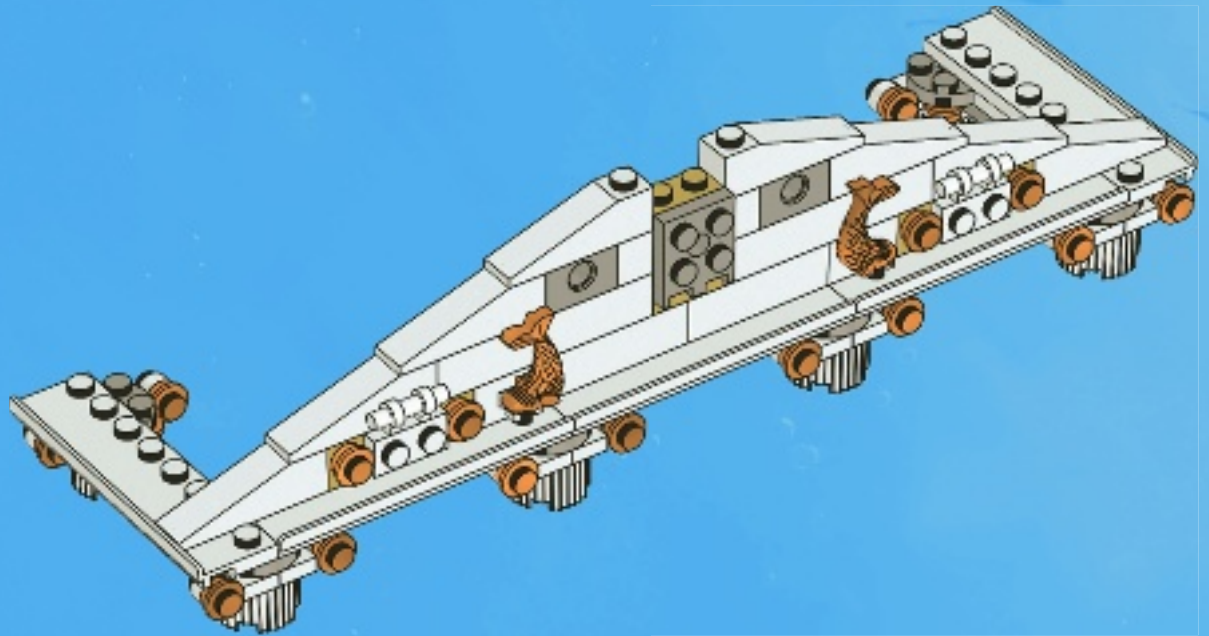

1x



1x



1x

15

1

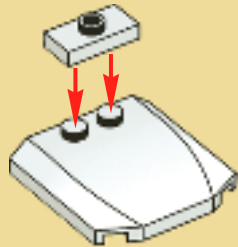

2

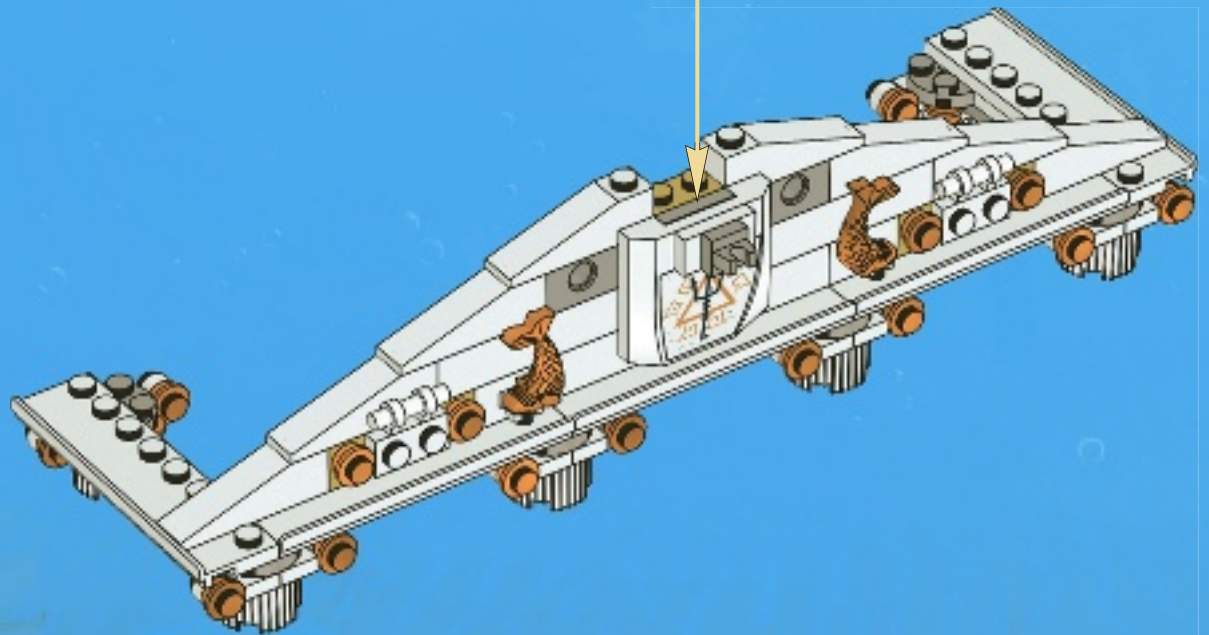
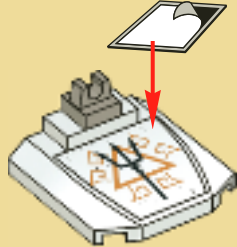



16

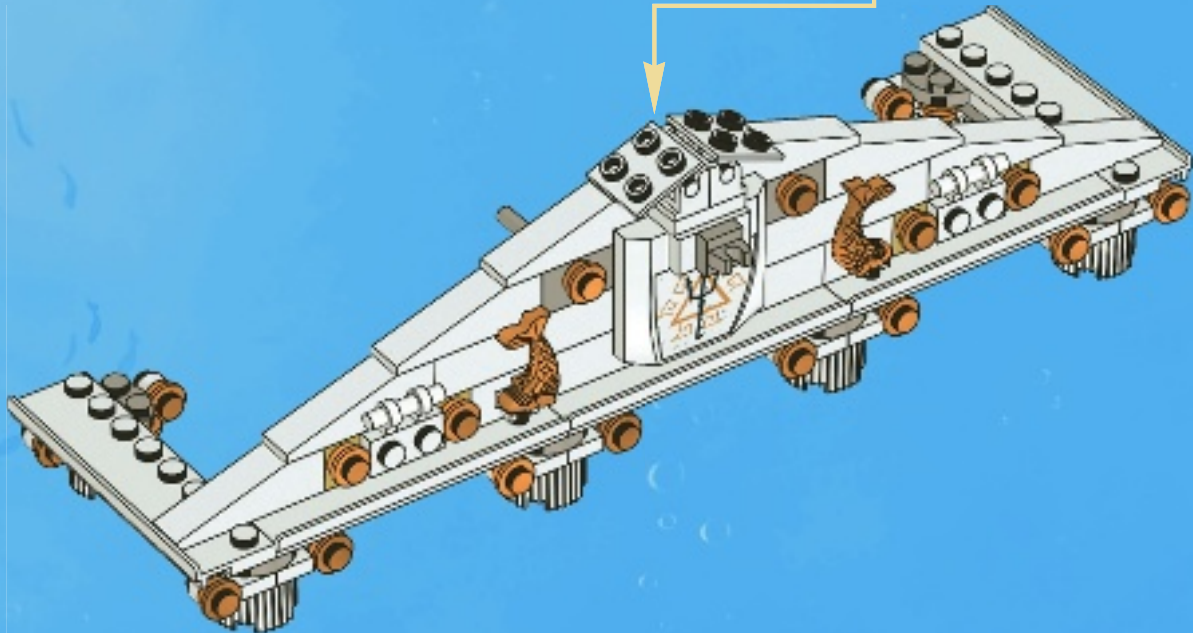
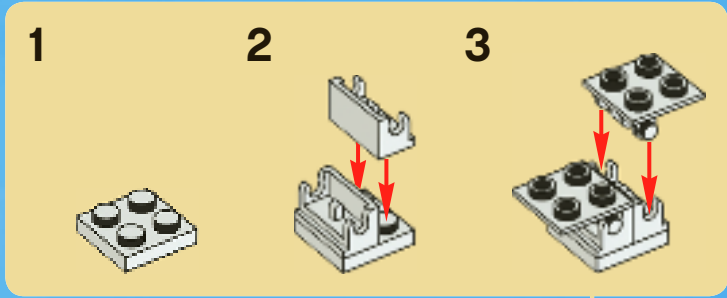

28

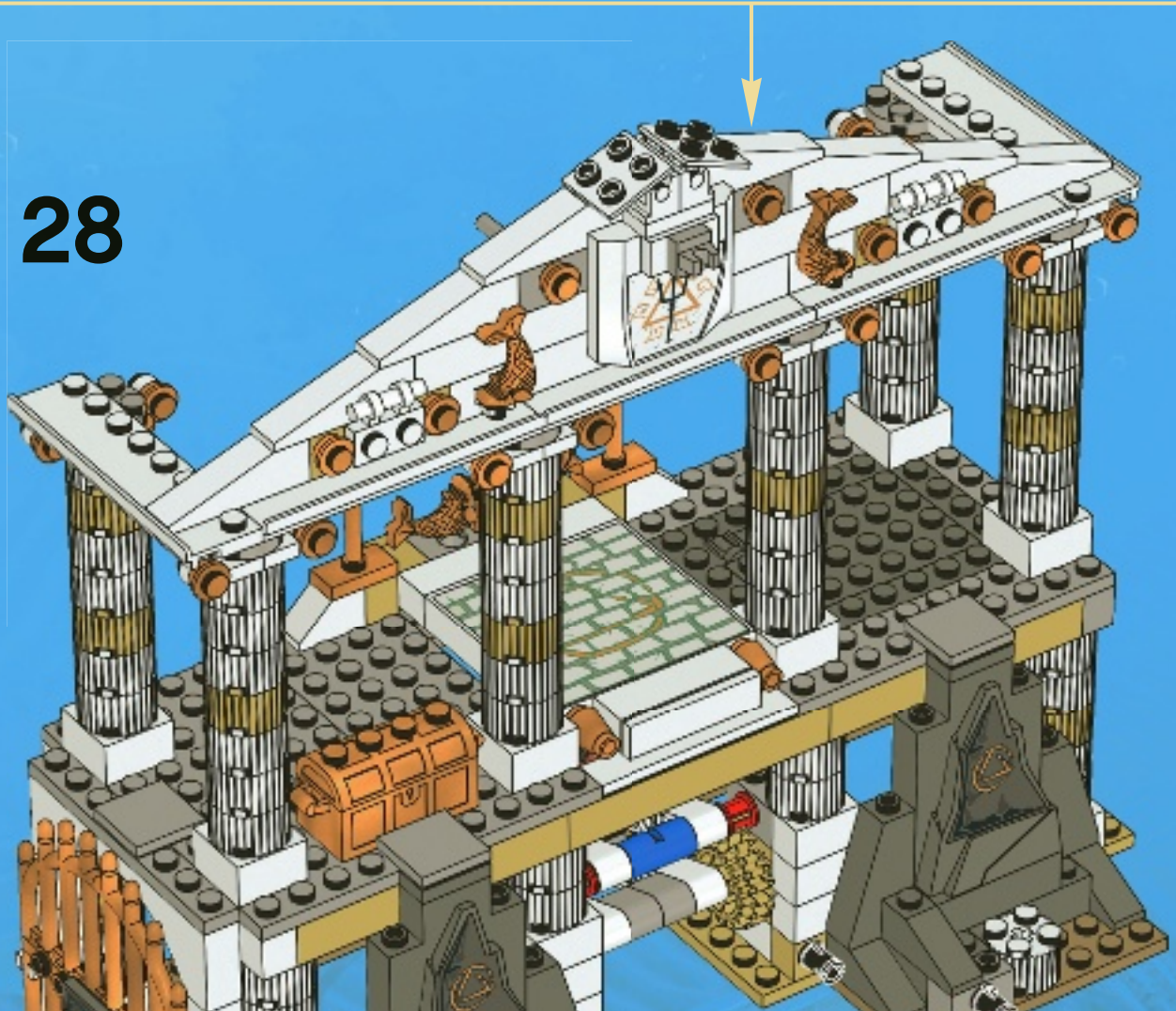

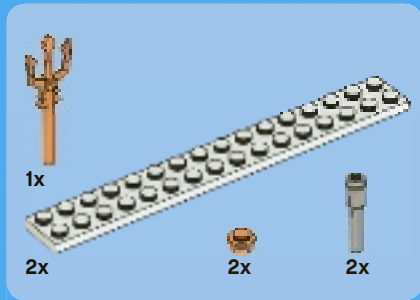

29

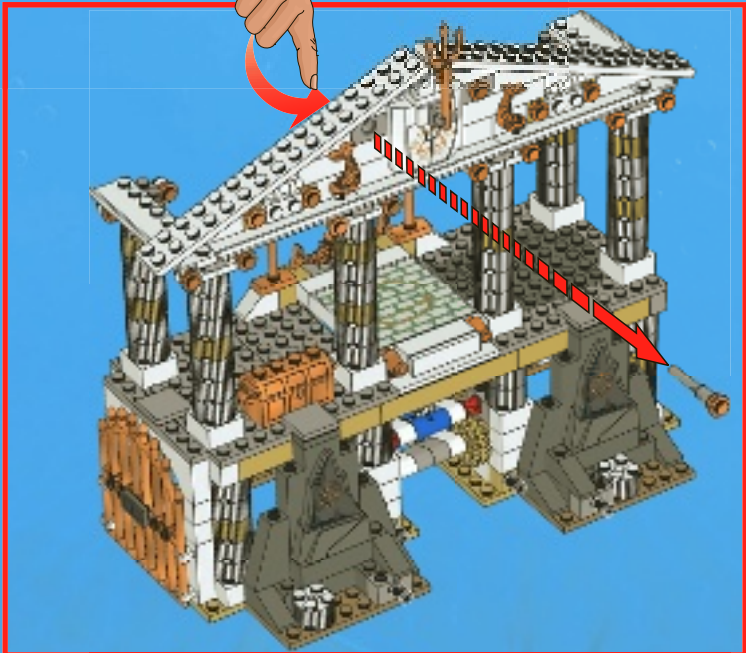
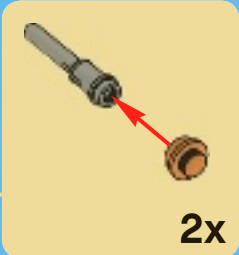
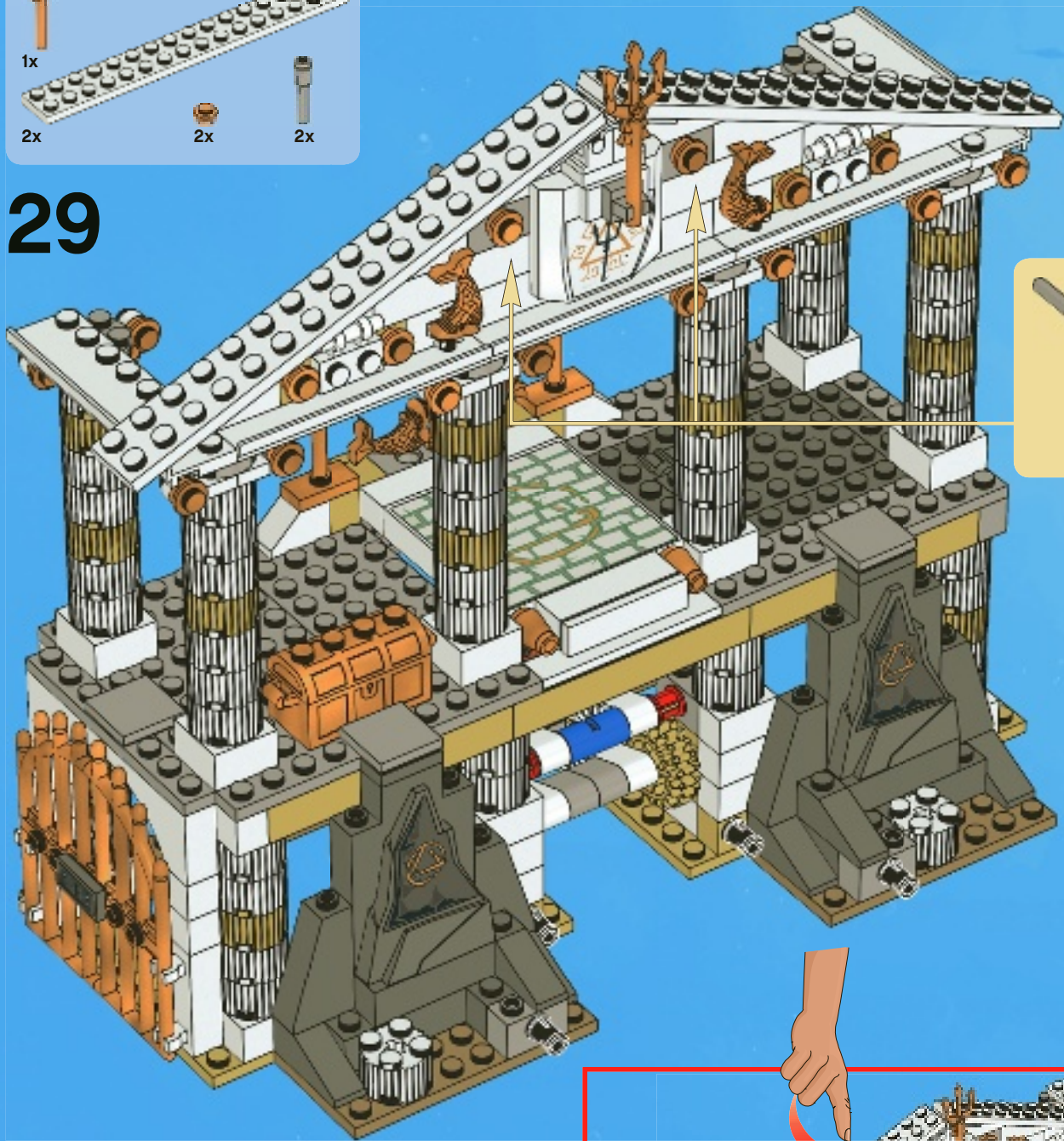

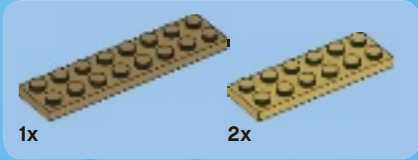

1

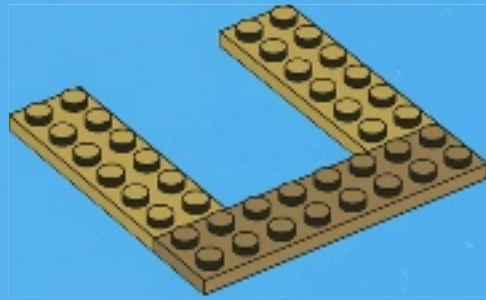

2



3

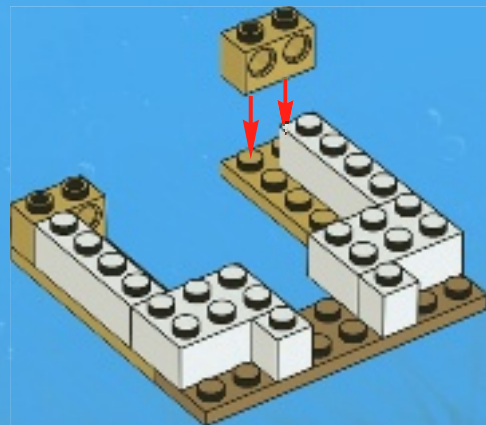



4

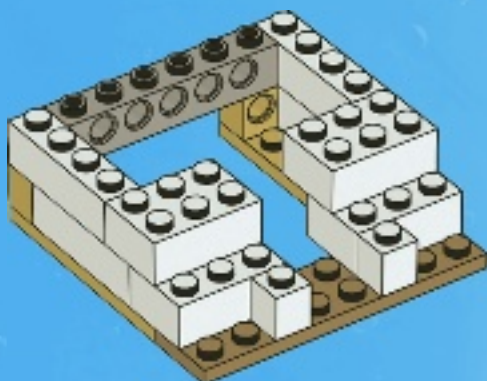

5

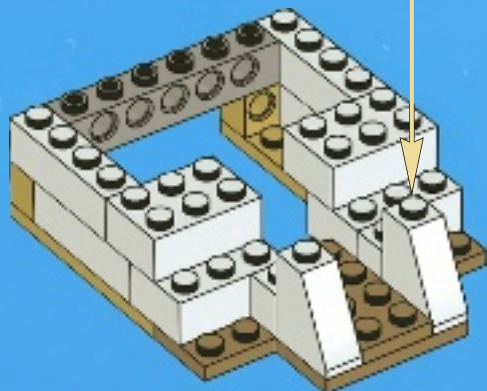
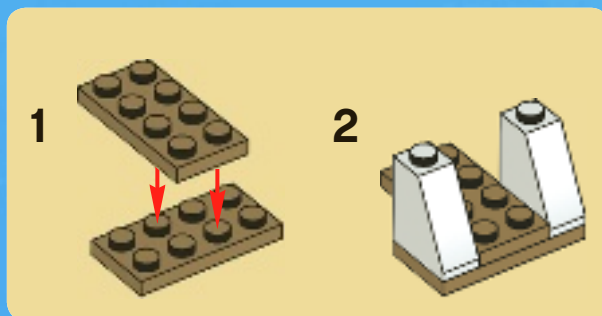



1:1



1



1x



2

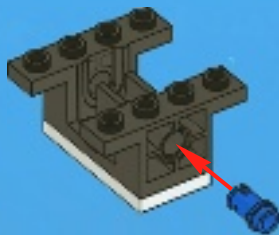

1x



1x

3

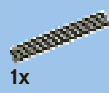
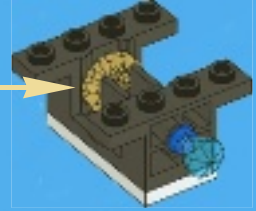
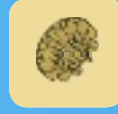

1x

4



1x

4



1x

5





1x

6



7

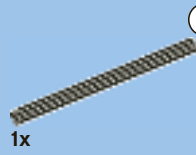
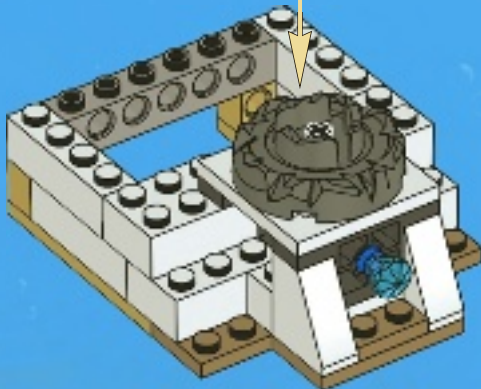

1x



1x

8

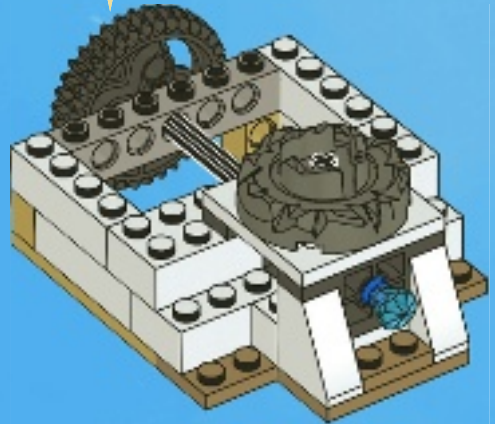
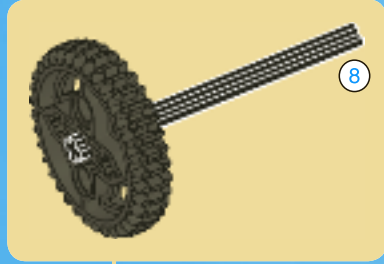

2x



4x

9

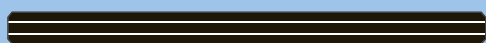
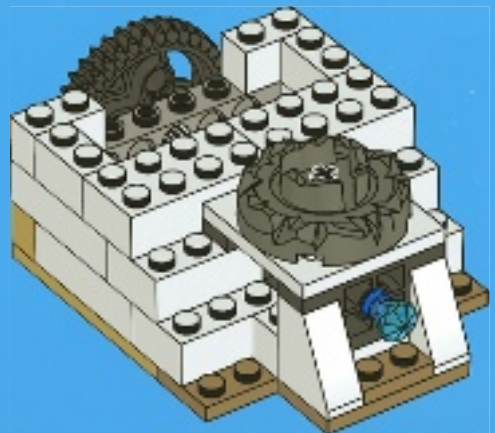

8

1:1



2x



2x

10

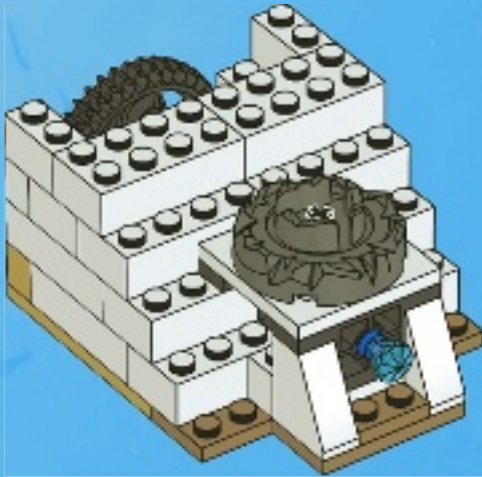

2x

12

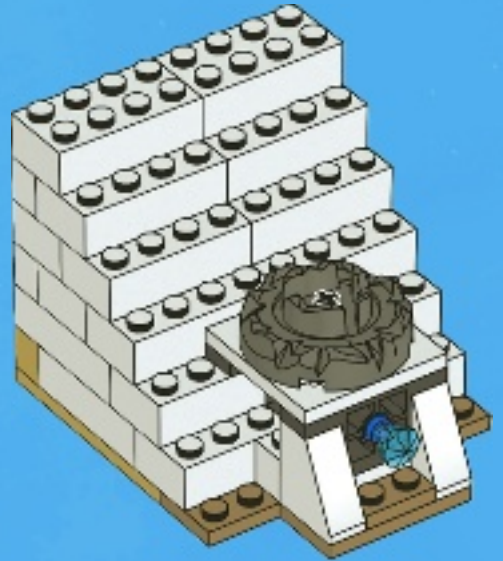

2x



2x

11

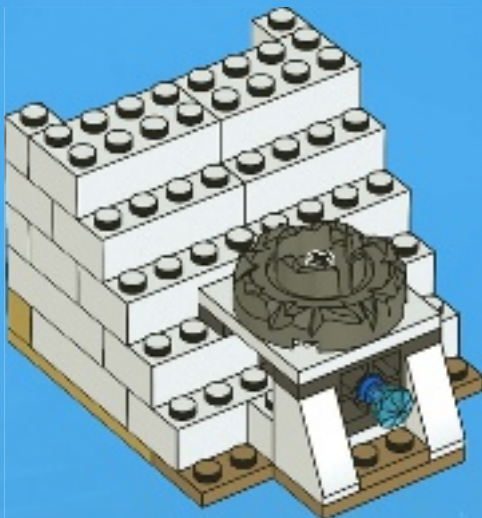

1x



1x

13

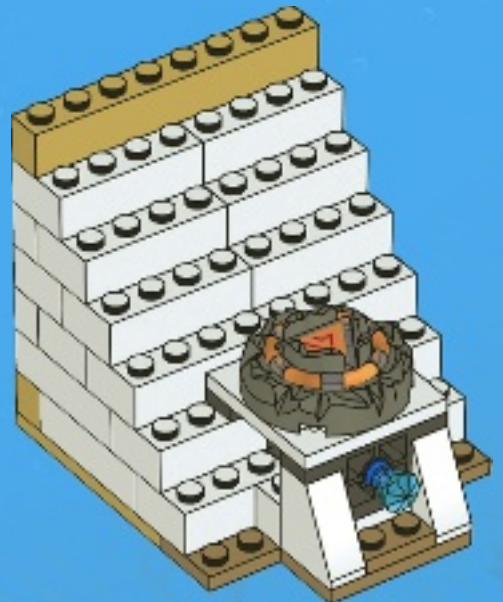

30

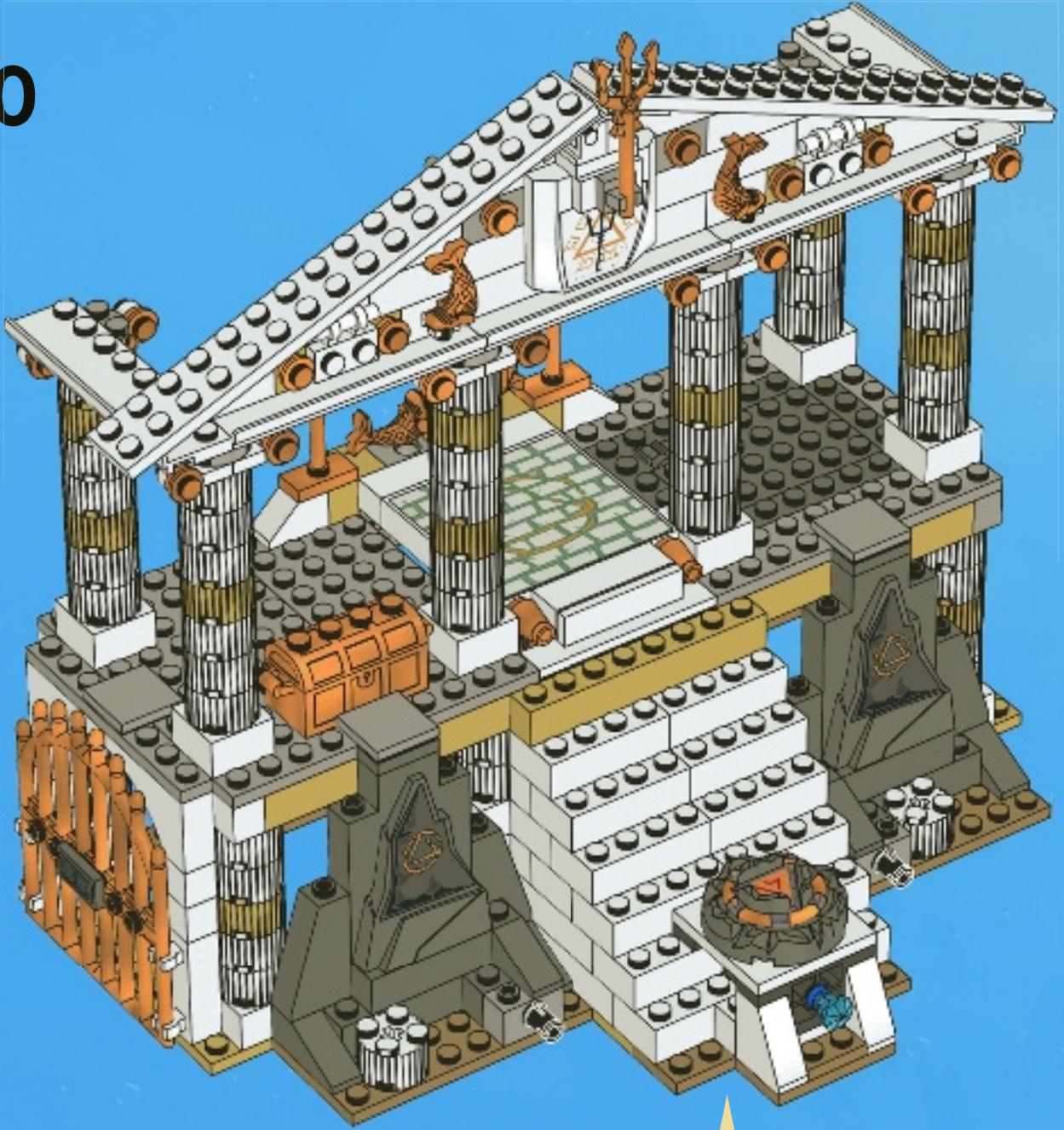



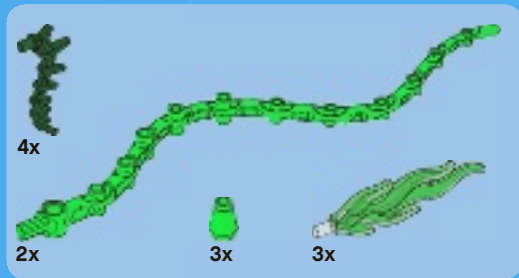
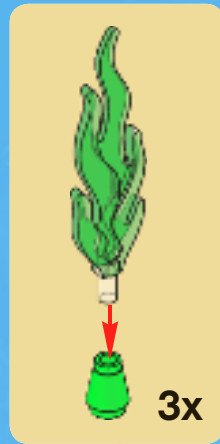
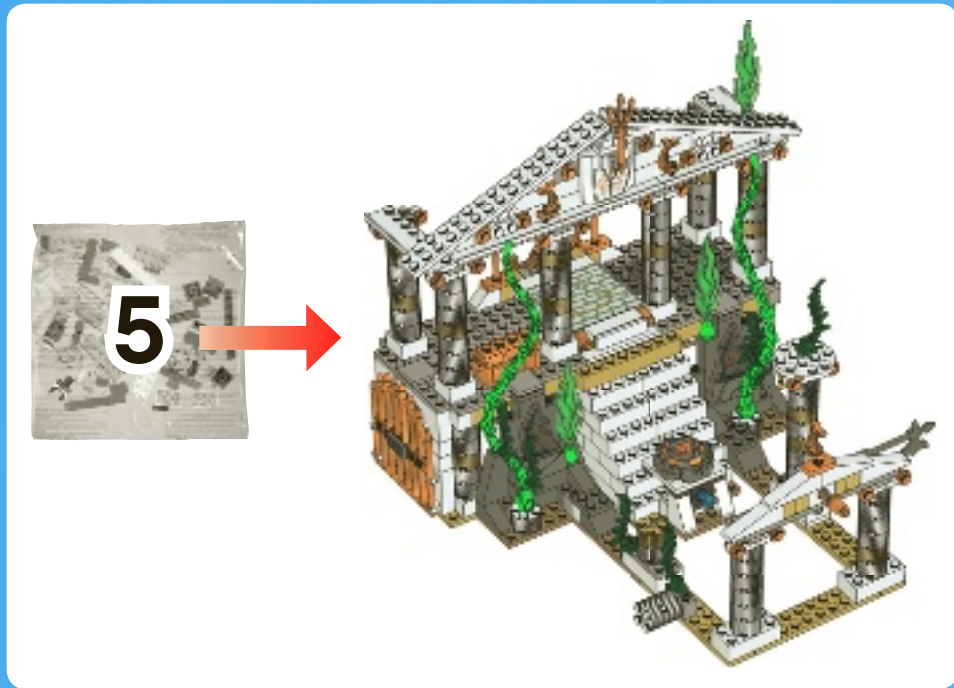

31



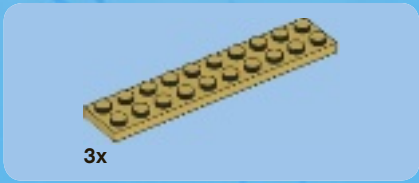

3x

1

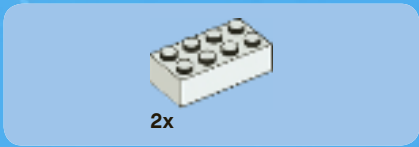
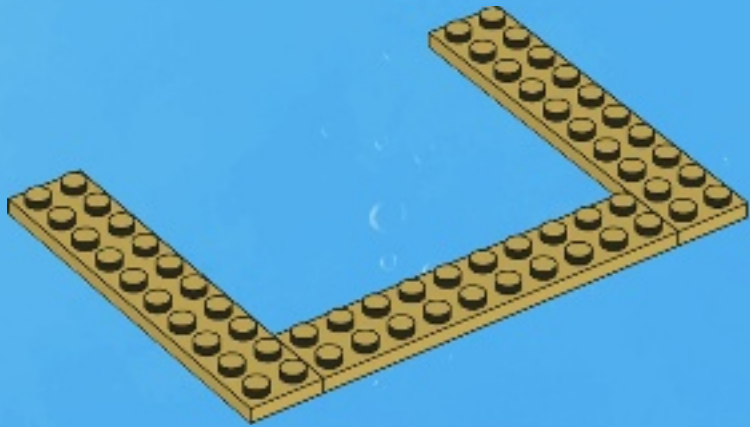

2x

2

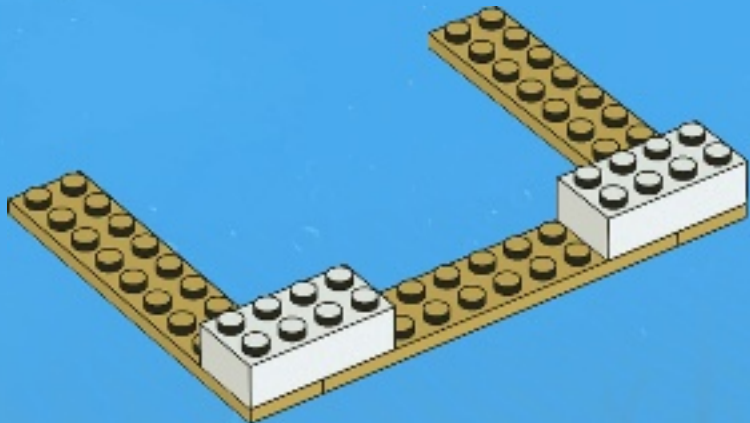

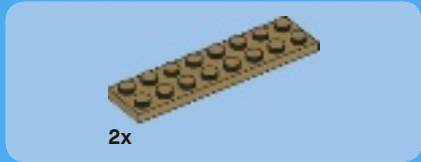

3

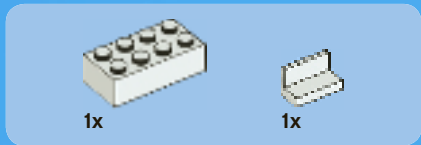
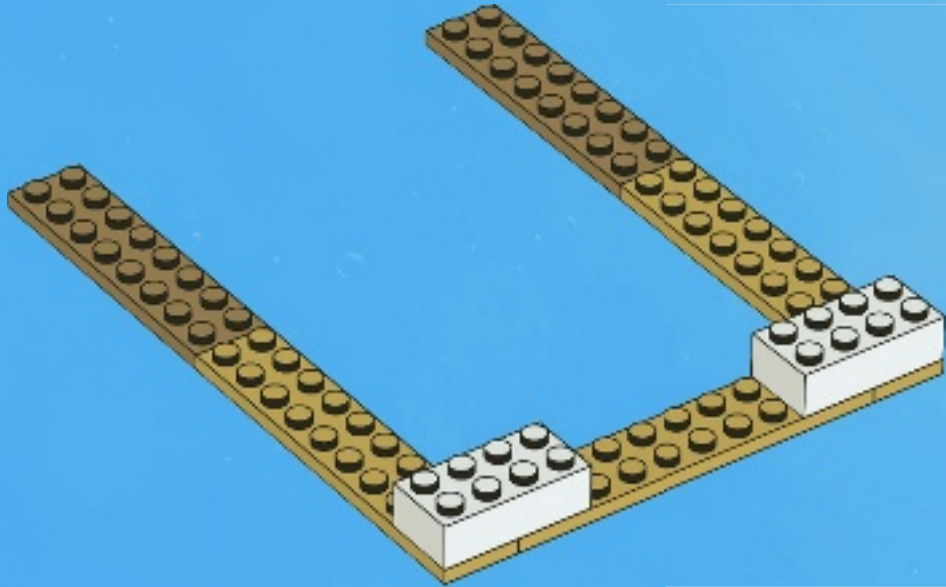

4

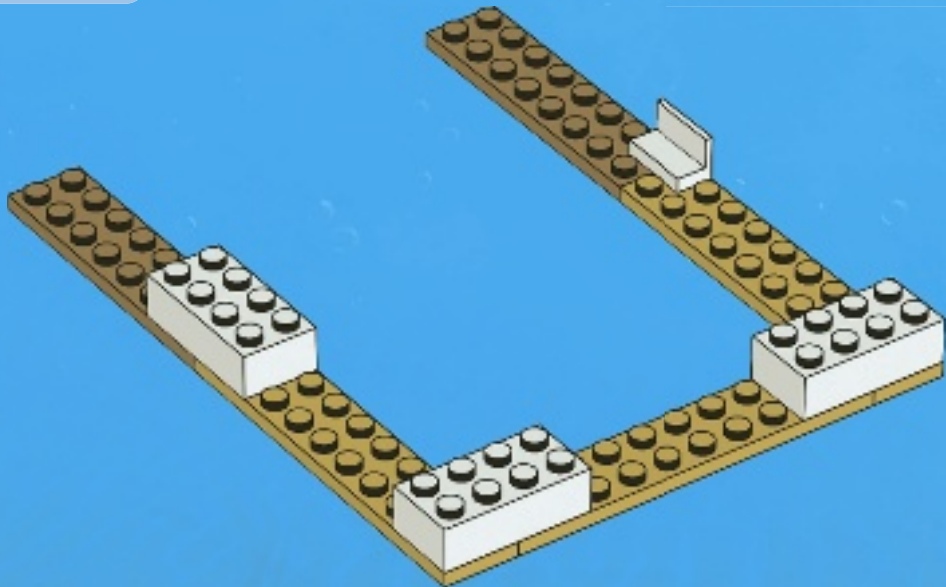



2x



2x

5

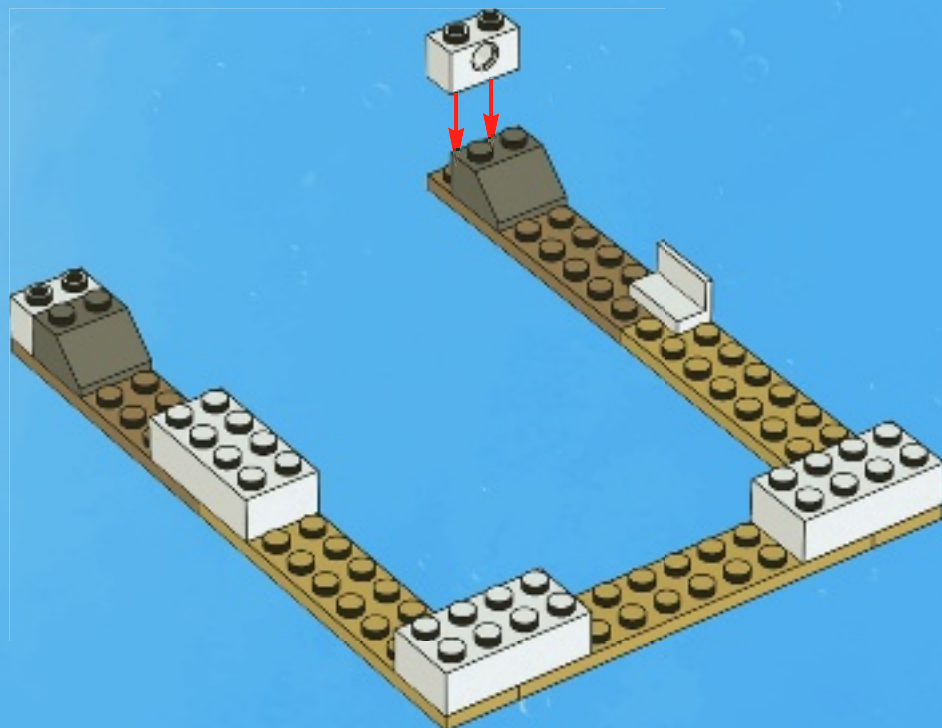

2x



2x



1x

6

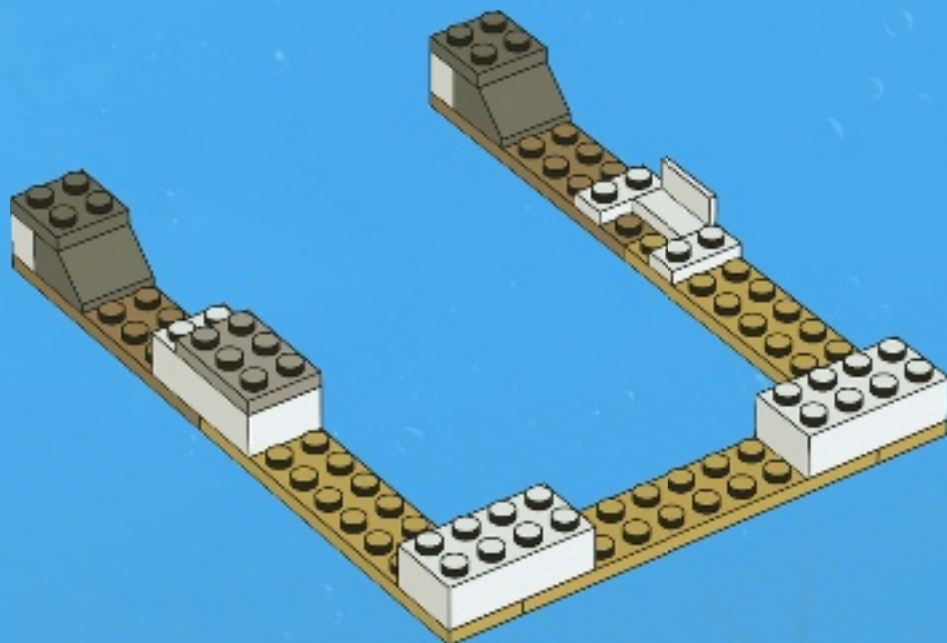



7

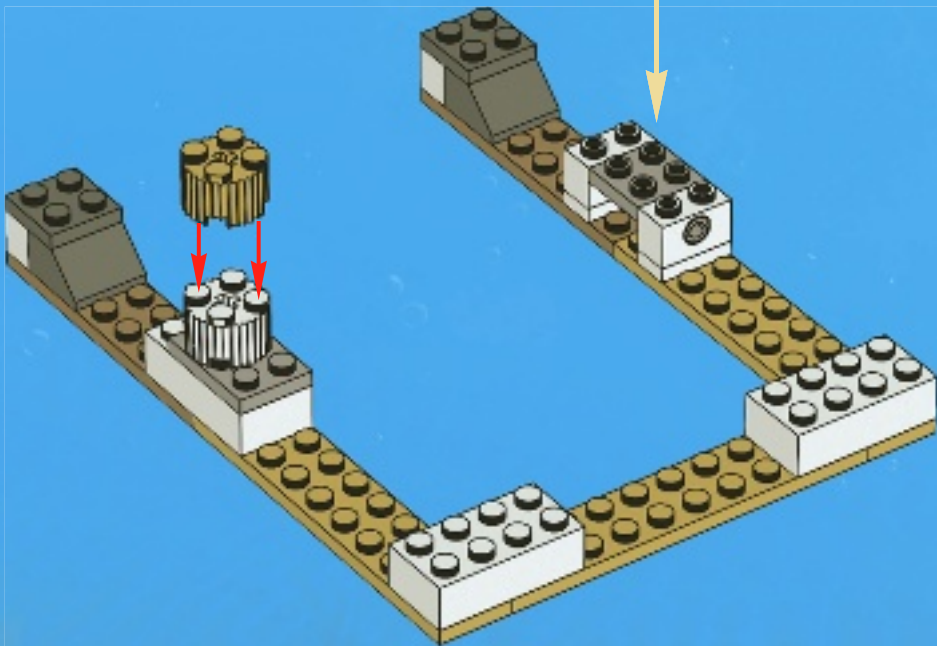
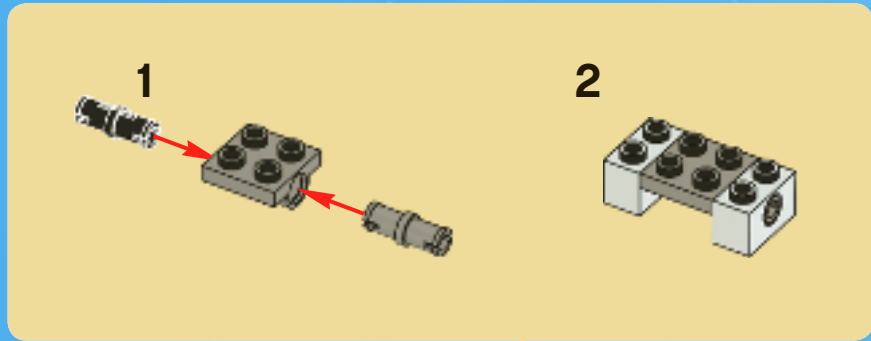

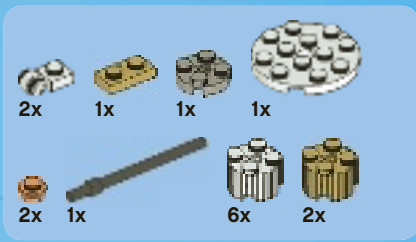

8

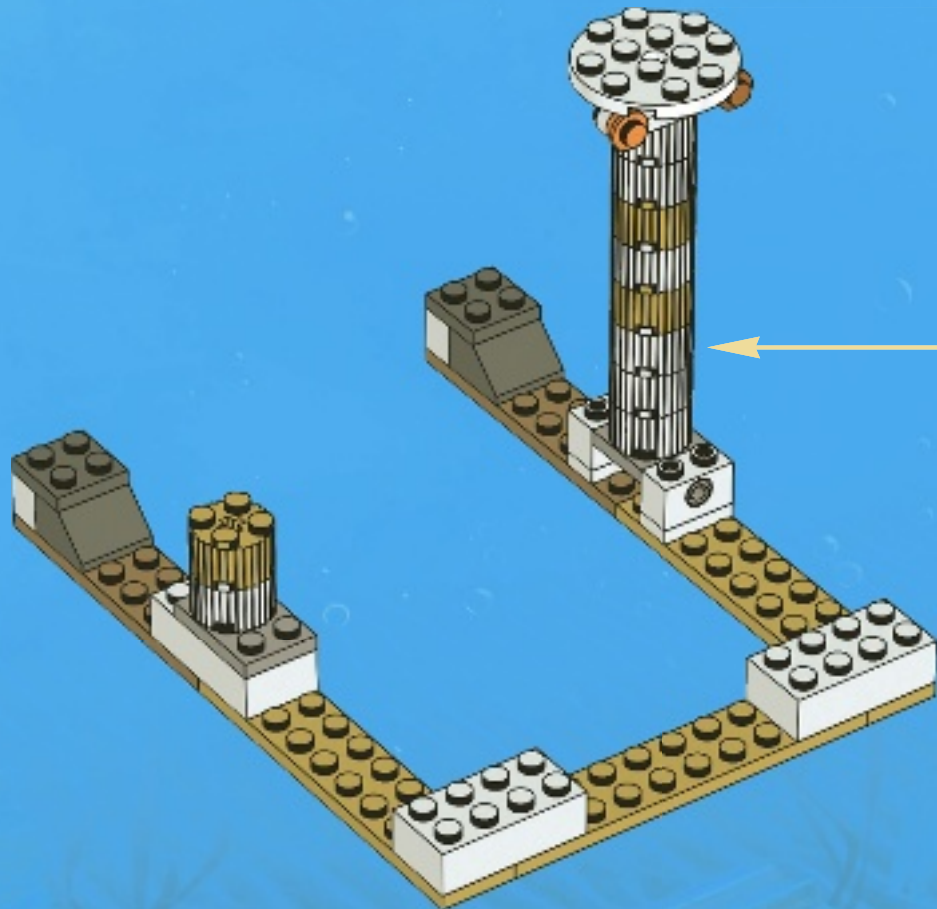
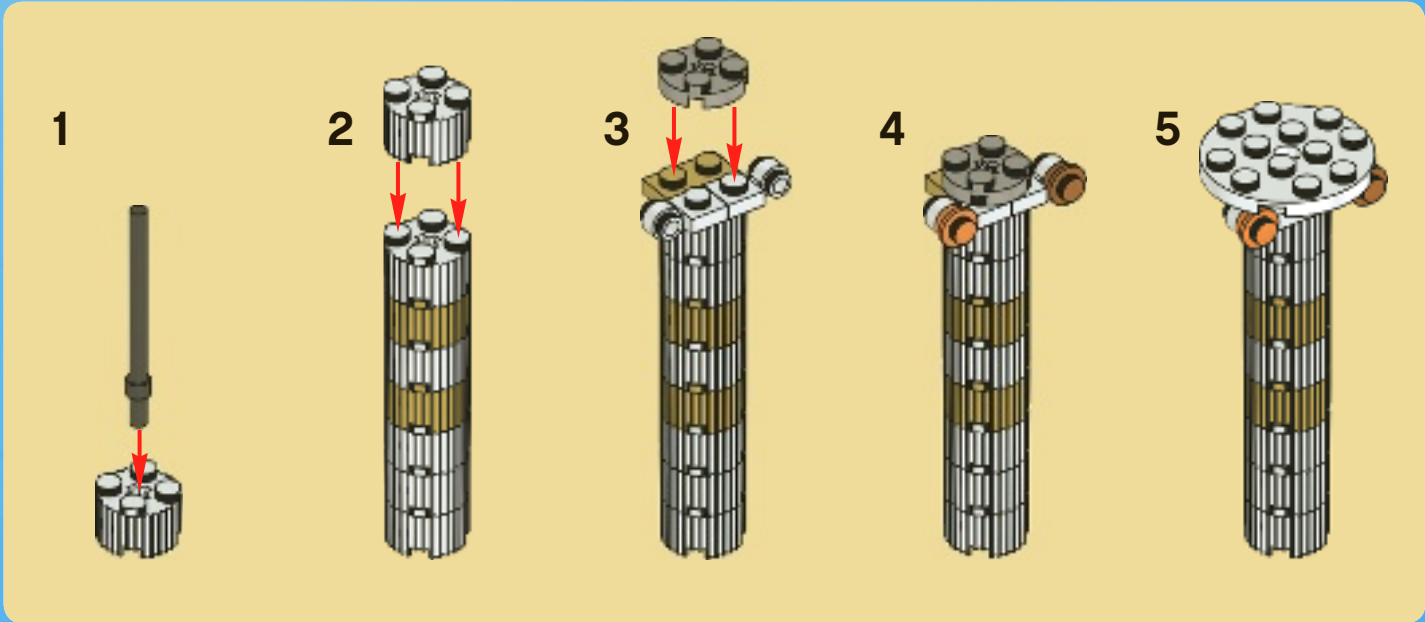

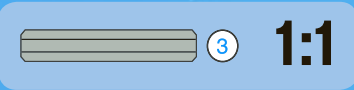
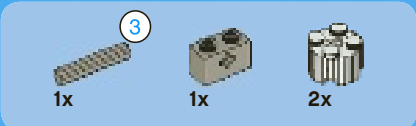

9

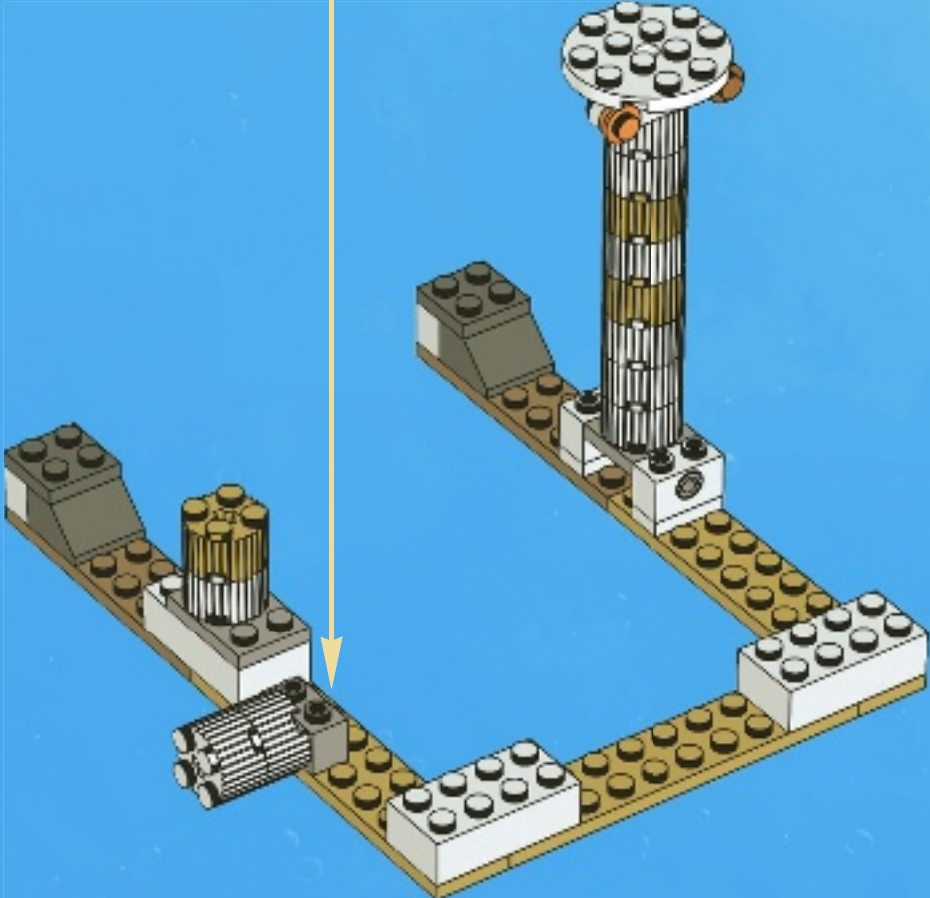
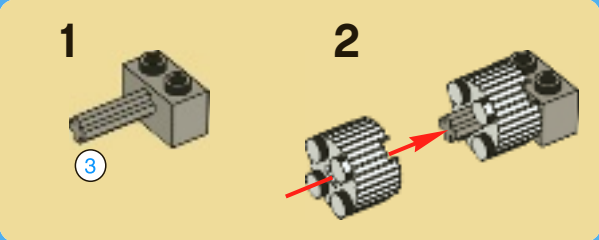



3x



3x

10



3x

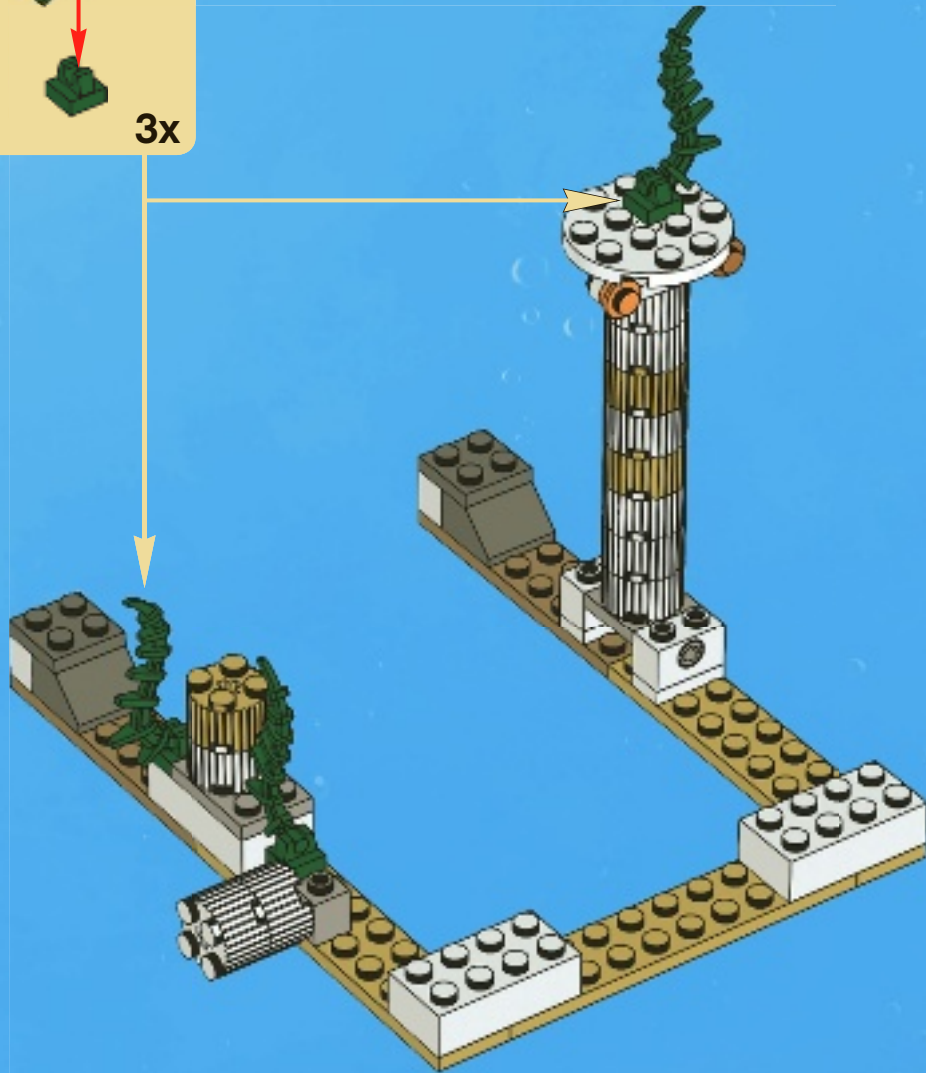



11

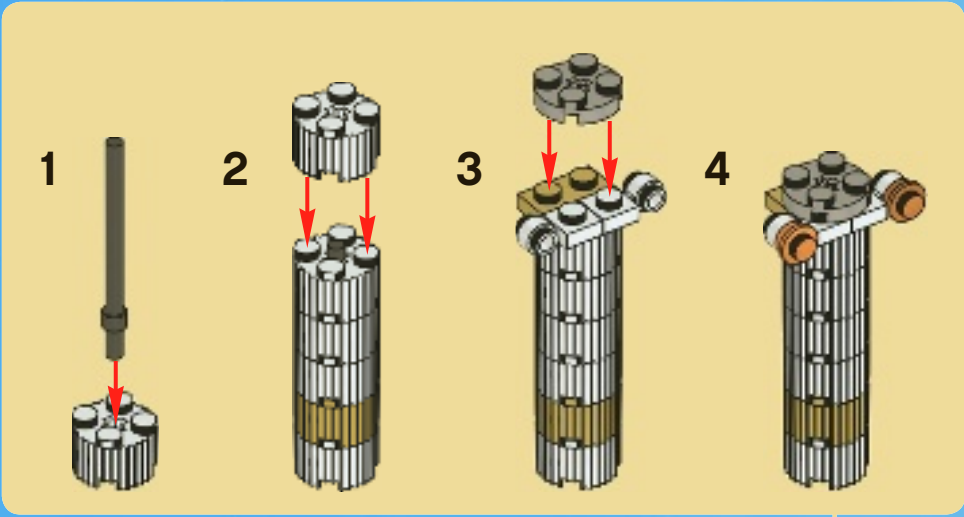

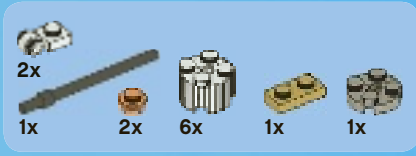

12

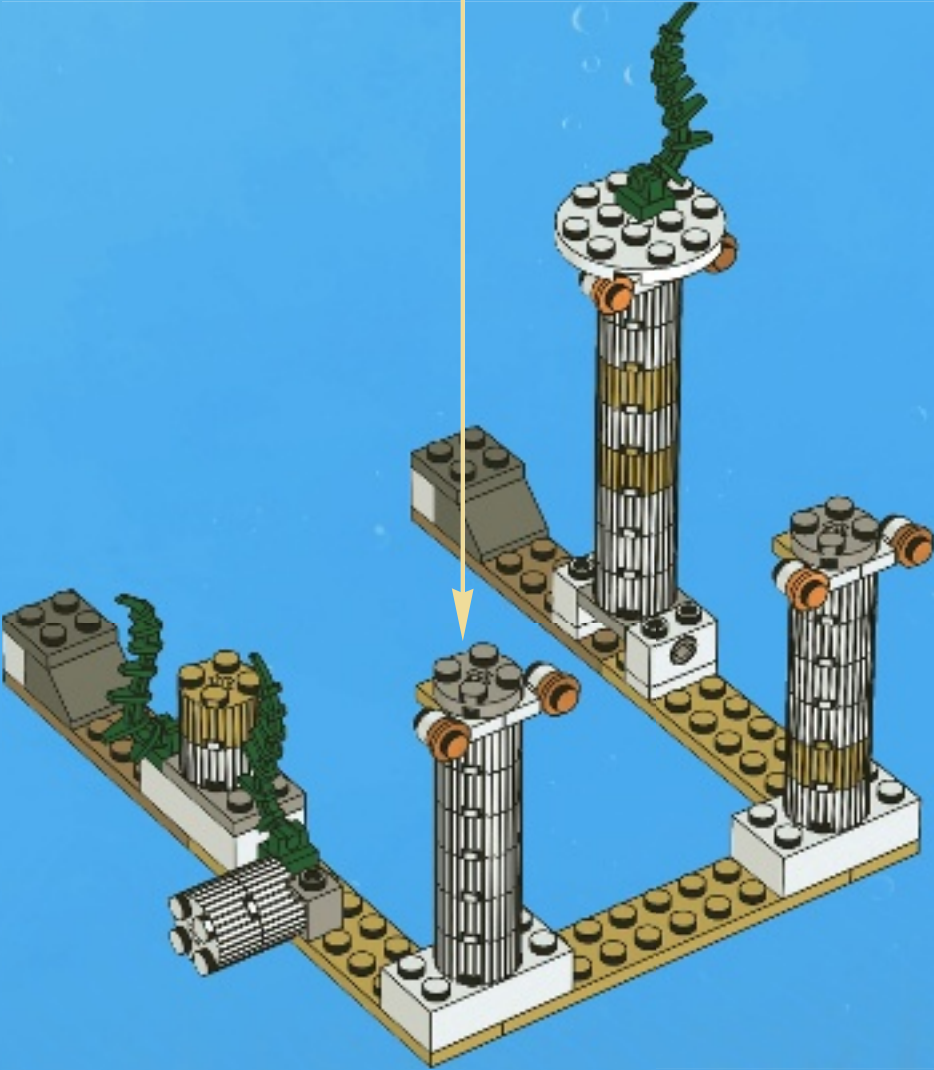
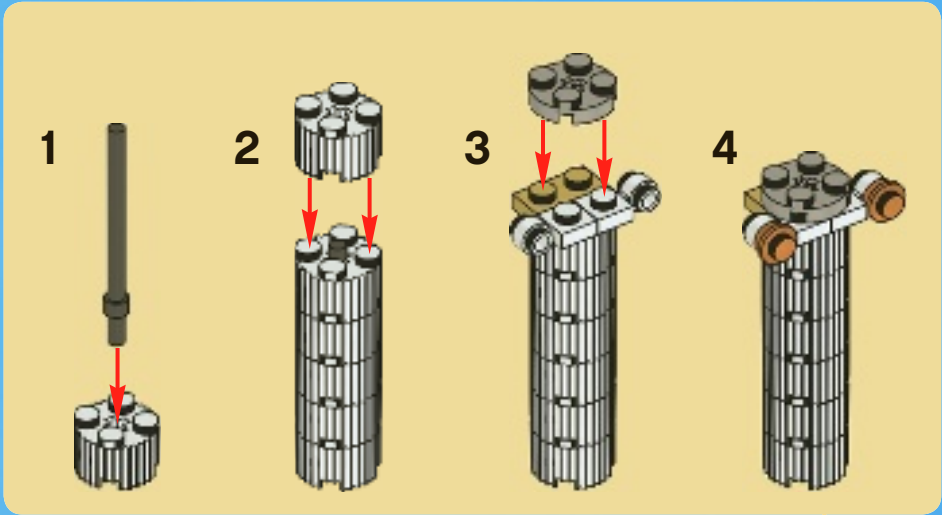

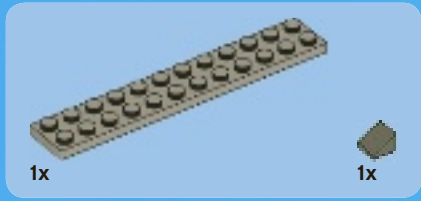
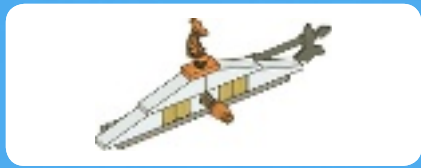

1

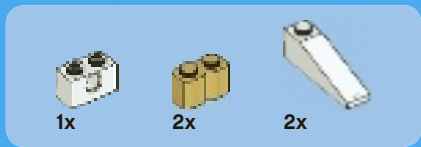
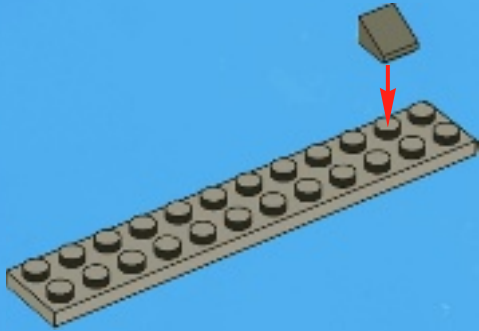

2

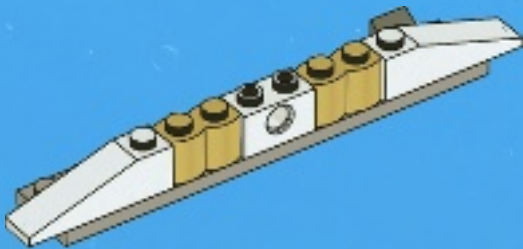

3

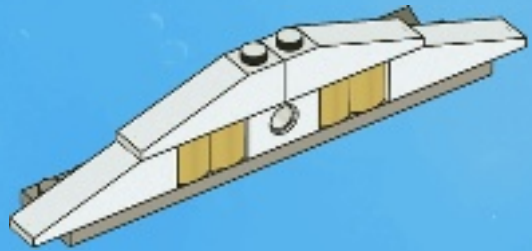

4

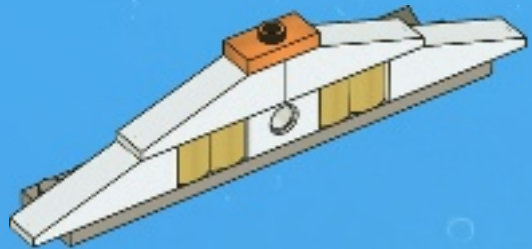

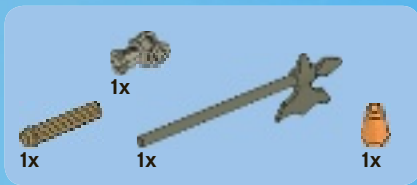

5

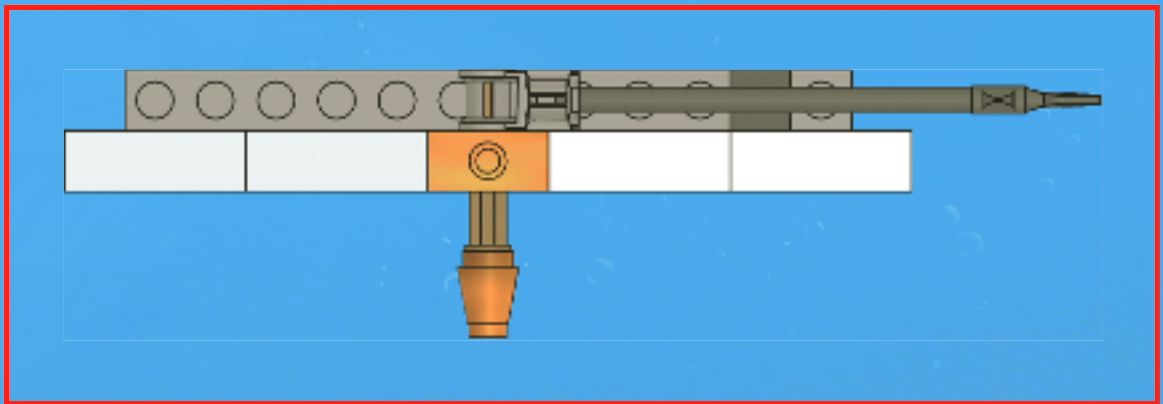
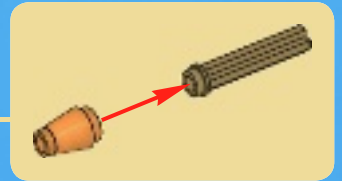
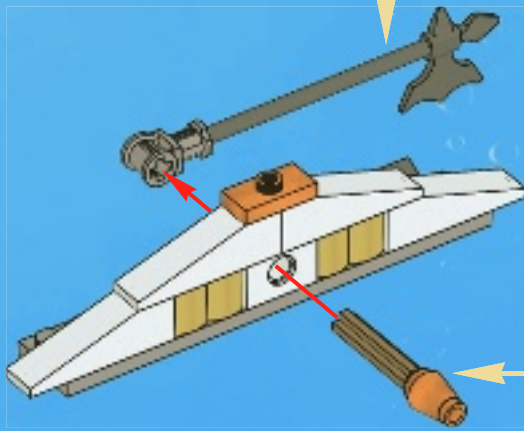
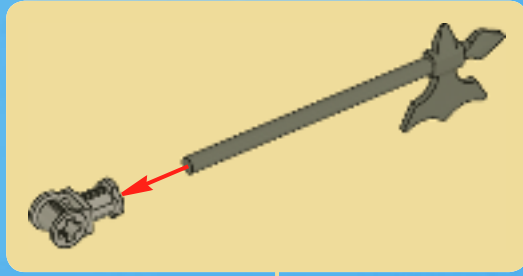



1x

6

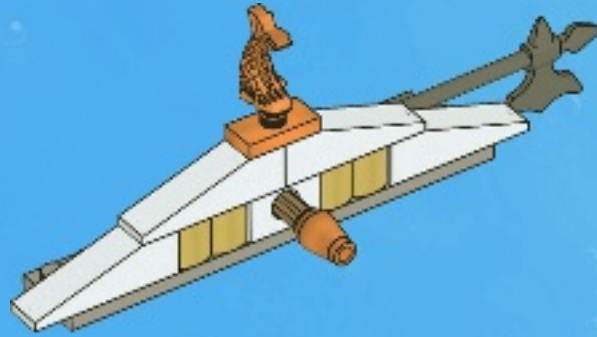

13



32

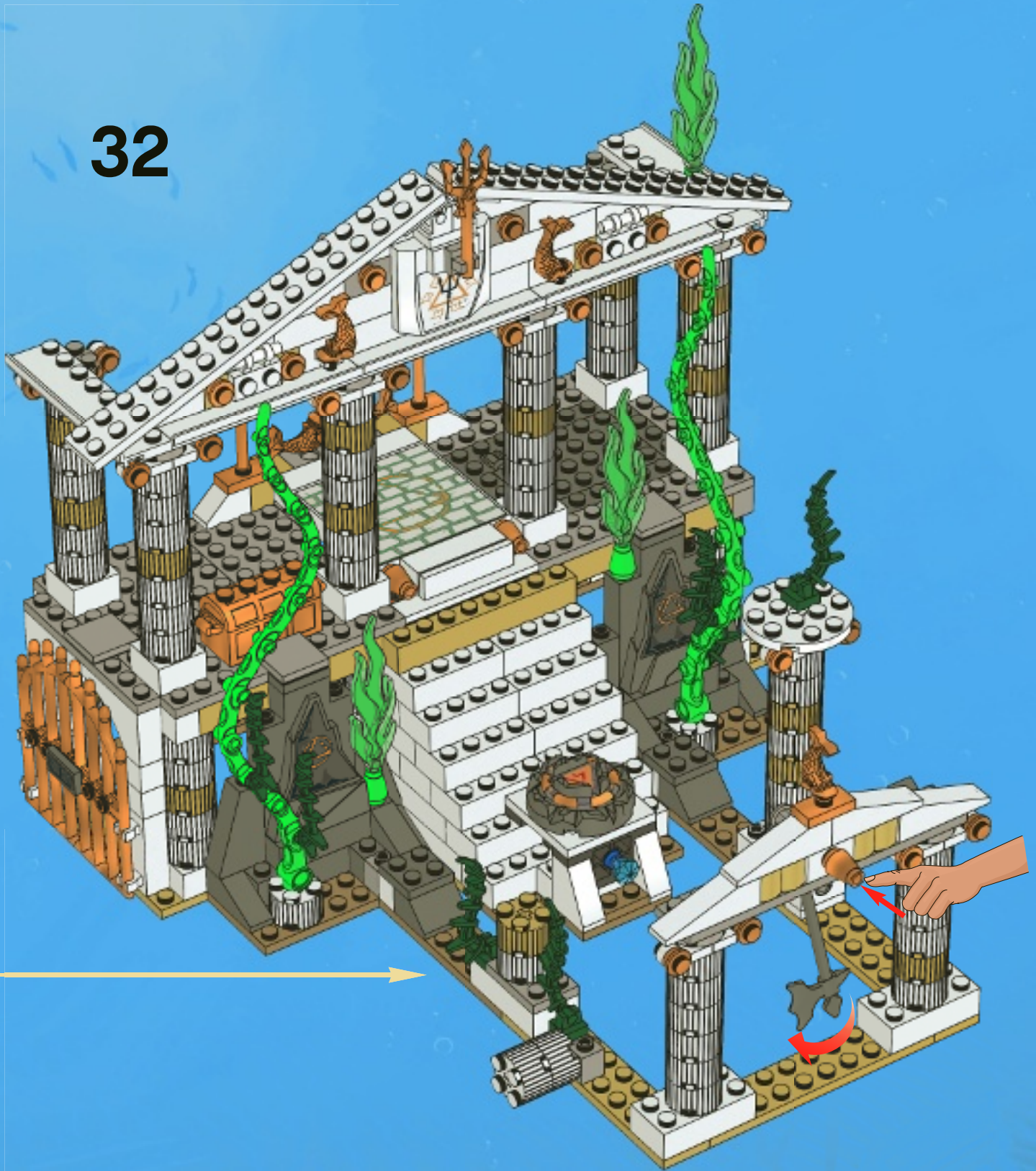



7976

7984

7978

7985

7977





7977



7976



7978



7985



7984



2x 419227
1x 4547489
2x 4121932
1x 303901
1x 4504228
1x 4160736
5x 4500878
3x 346001
1x 611101
3x 300901
6x 300401
12x 300301
8x 235701
4x 300201
8x 301001
11x 300101
2x 4563684
1x 486501
83x 4603123
5x 370001

1x 4547489
2x 4121932
1x 303901
1x 4504228
12x 4515359
8x 300501
2x 302301
1x 302201
1x 243101
2x 371001
1x 663601
18x 408101
1x 379401
2x 4140583
1x 370901
1x 4515347
2x 4515370
2x 4117061
2x 4568387
1x 4193068

2x 393701
2x 4612342
1x 4611927
4x 4495927
7x 4249019
6x 4159774
2x 4218749
2x 4201062
19x 4612717
4x 4179771
4x 4523145
14x 4113917
2x 4113993
3x 4186017
2x 4565452
1x 4514555
1x 300121
1x 4513987
4x 4504379

2x 4500462
8x 4520782
5x 302321
2x 302021
1x 383221
2x 4603505
4x 4226876
1x 281721
4x 614121
1x 415021
2x 4140806
2x 300723
2x 366523
2x 306923
2x 302223
3x 4143005
1x 4595160
2x 300424
2x 306224
1x 4570002
1x 4549621
2x 4613918

1x 9553
2x 407026
2x 4251161
1x 4219107
1x 306826
4x 4517925
2x 4598528
2x 4144024
2x 4604304
1x 4561035
3x 4538722
6x 4623154
1x 4587501
8x 4563477
2x 4153044
1x 4500902
13x 4121715
1x 370526
2x 370726
1x 4255563

3x 4529239
1x 4248937
3x 4615113
1x 3005741
4x 4497943
1x 4113954
2x 4119483
6x 3005744
2x 4611109
1x 4611686
1x 3005748
4x 4504371
1x 4158355
4x 4614380
2x 4570396
2x 4267874
5x 4246957
2x 4251796
1x 4566927
5x 4612418
9x 4294148

4

8



Customer Service
Kundenservice
Service Consommateurs
Servicio Al Consumidor
www.lego.com/service or dial

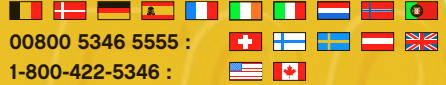

00800 5346 5555 :
 1-800-422-5346 :



2x
4612827

LEGO club™

FREE! GRATIS! GRATUIT!



www.LEGOclub.com



LEGO® Club Magazine



LEGO® Club Email

SIGN UP ONLINE!

www.LEGOclub.com

VISIT THE WORLD'S
BIGGEST LEGO® SHOP!

www.LEGOshop.com

GO TO
www.LEGOclub.com

00800 5346 5555*

1-866-534-6258 • 1-877-518-5346

US & Canada only

Canada seulement



* Freephone. Mobile charges may apply. * Numéro sans frais. Des frais peuvent s'appliquer avec les téléphones cellulaires. * Gebührenfrei, Kosten für Anrufe aus Mobilfunknetzen können abweichen. * Gratis telefoonnummer vanaf vaste lijn. * Det er et gratis nummer, når du ringer fra fasttelefon. * Det är gratis, när du ringer från en fast telefon. * Numéro sans frais. Des frais peuvent s'appliquer avec les téléphones portables.



WIN!

Go to www.LEGOsurvey.com/product to fill out a survey for a chance to win a cool LEGO® Product. No purchase necessary. Open to all residents where not prohibited.

 www.LEGO.com



www.LEGOsurvey.com/product

GEWINNE!

Nimm an der Umfrage auf www.LEGOsurvey.com/product teil und hab die Chance ein cooles LEGO® Produkt zu gewinnen!

Die Teilnahme am Gewinnspiel führt zu keinerlei Kaufverpflichtungen. Teilnahme in allen nicht ausgeschlossenen Ländern möglich.

4624975/ 4624976

WIN!

Ga naar www.LEGOsurvey.com/product, vul een enquêteformulier in en maak kans op een cool LEGO® product.

Geen aankoopverplichting. Iedereen mag deelnemen, uitgezonderd ingezetenden van landen waar een enquêteverbod geldt.

GAGNE !

Visite www.LEGOsurvey.com/product pour répondre à un questionnaire et avoir une chance de gagner un produit LEGO® très cool !

Aucune obligation d'achat. Ouvert à tous les résidents des pays autorisés.

当てよう!

www.LEGOsurvey.com/product にアクセスして、アンケートにご記入ください。当選者にはレゴ®製品を差し上げます。

お買い上げの必要はありません。禁止されていない限り、すべての皆様にご利用いただけます。