



THE HOBBIT™

AN UNEXPECTED JOURNEY

79010



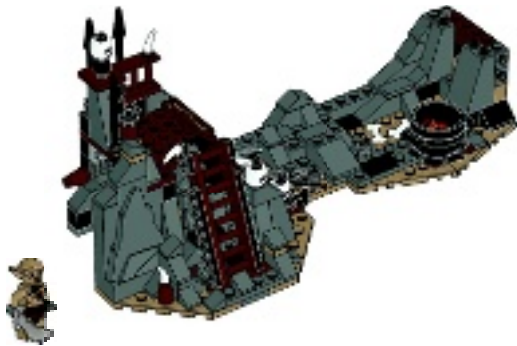
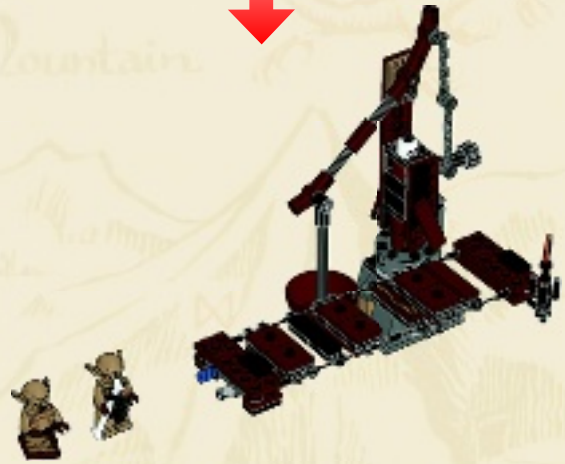

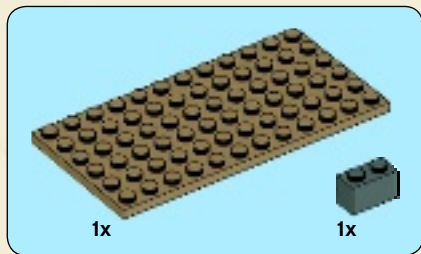

1

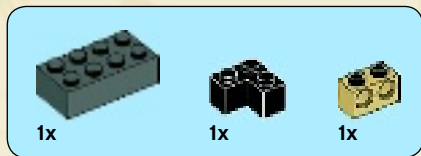
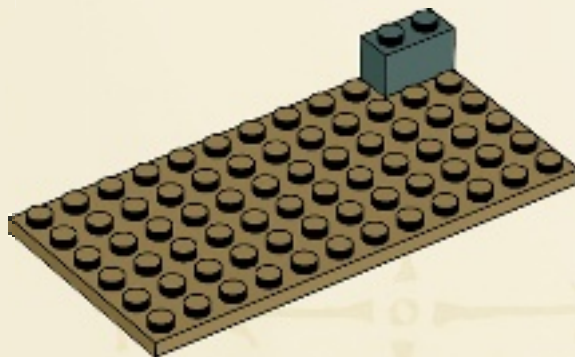

2

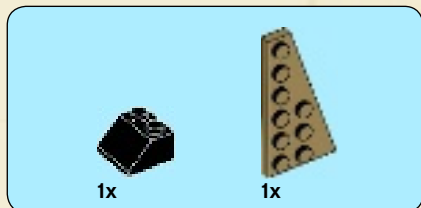
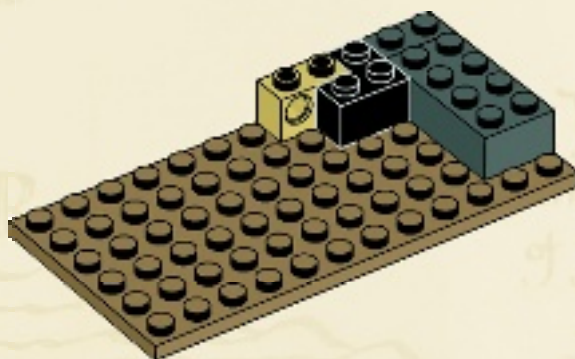

3

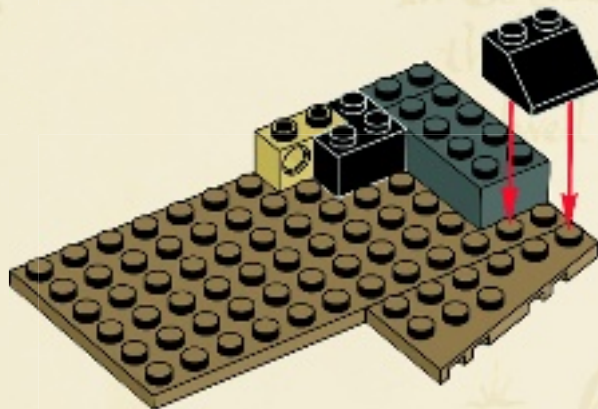



4

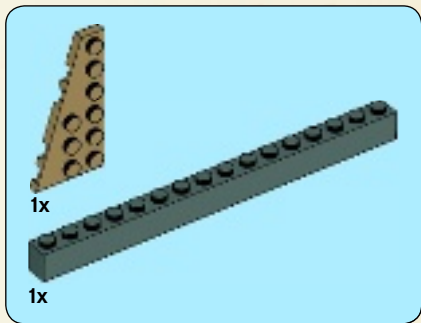
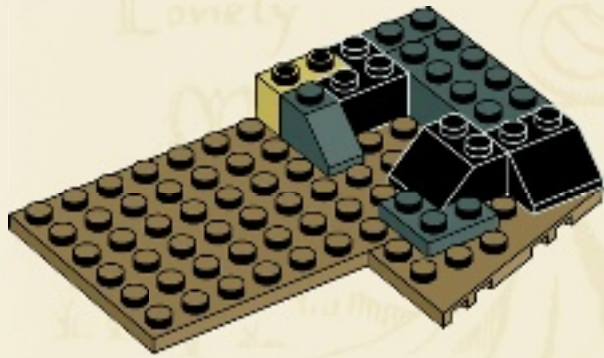

5

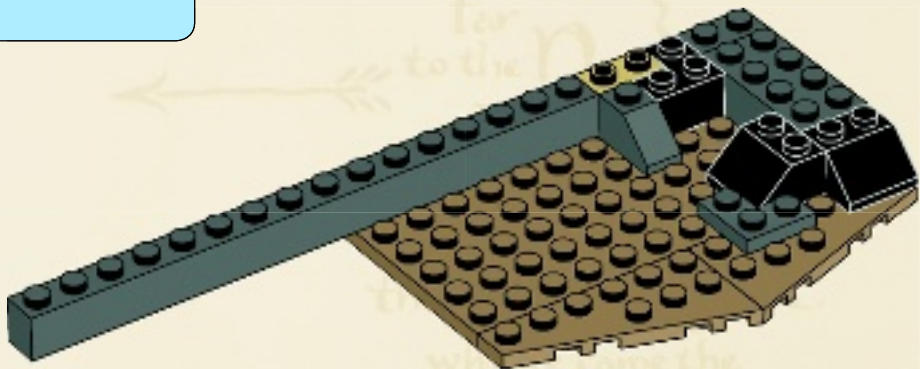

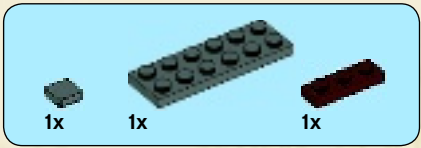

6

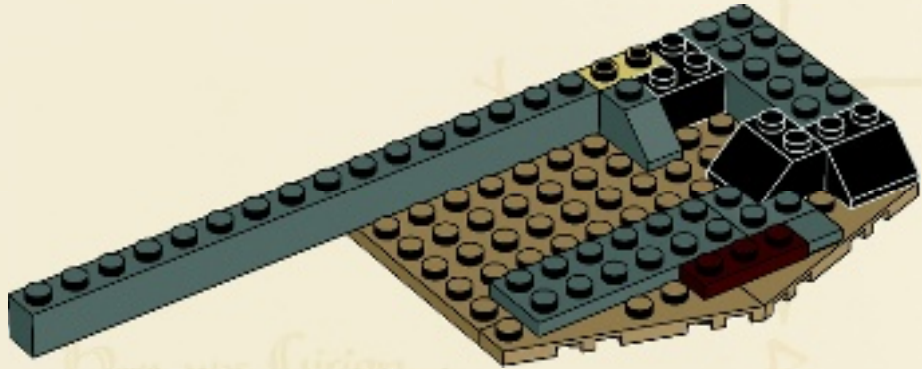

7

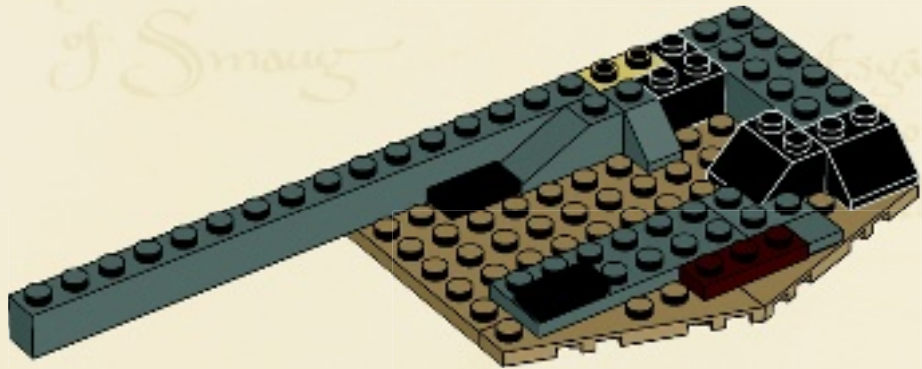



8

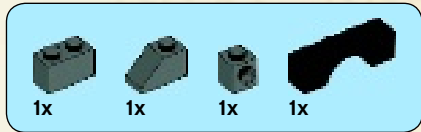
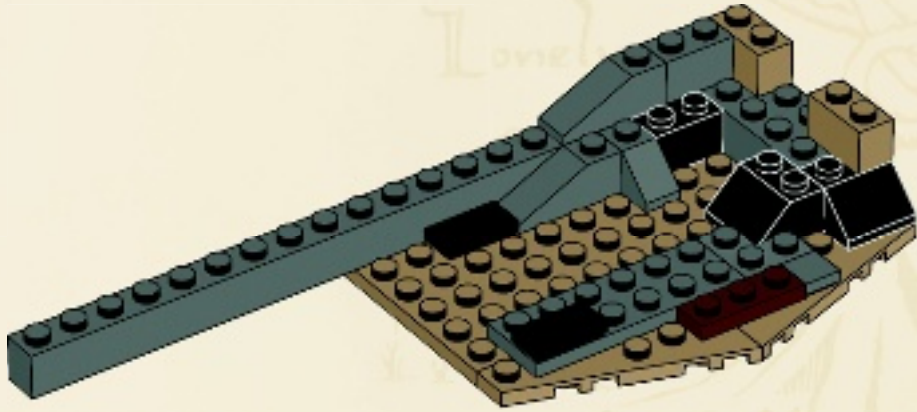

9

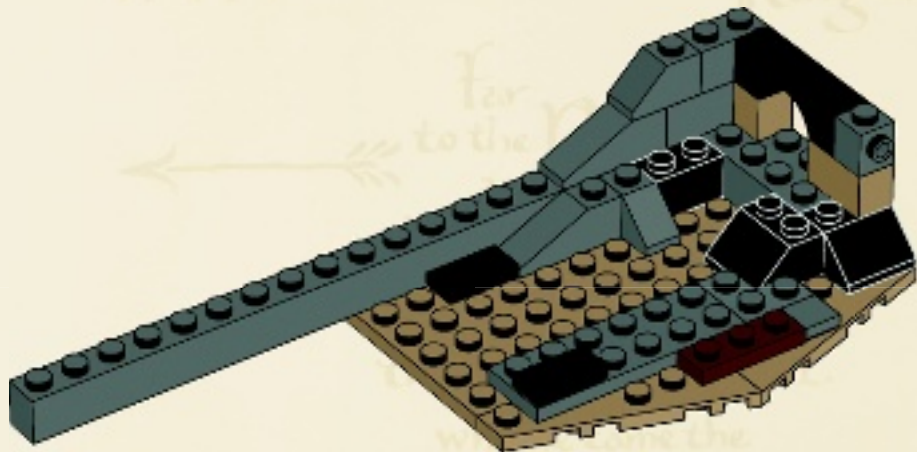

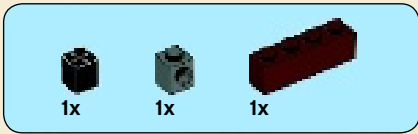

10

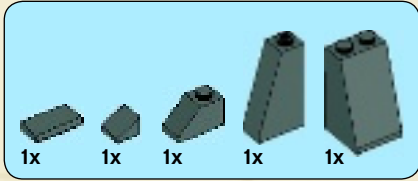
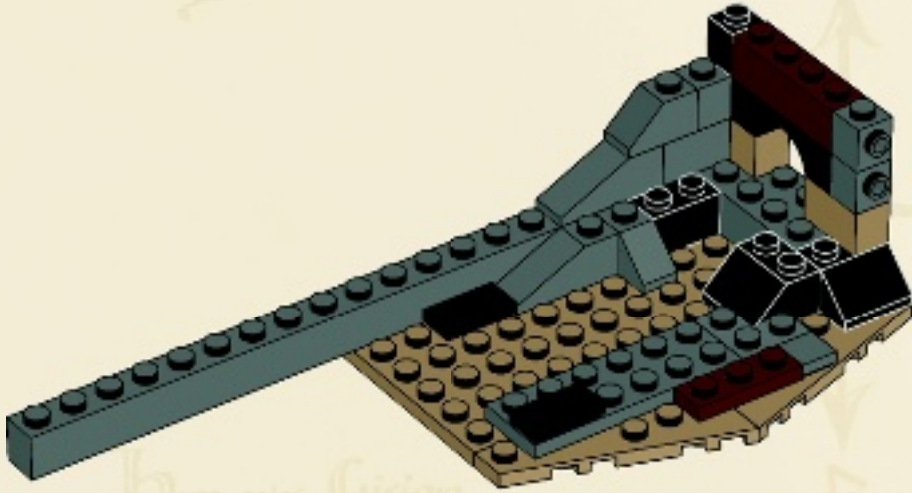

11

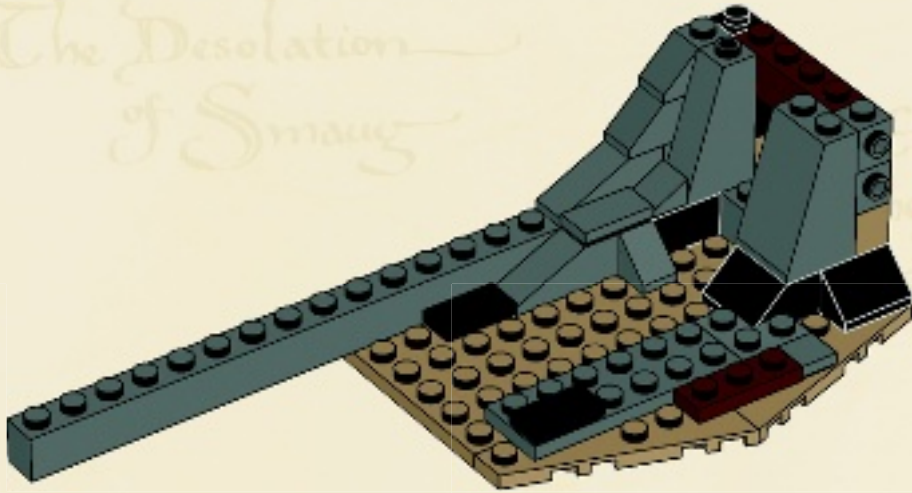

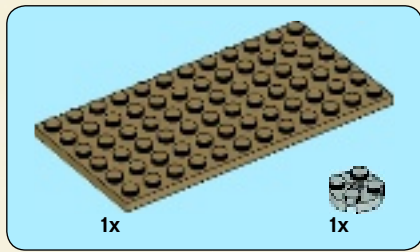

12

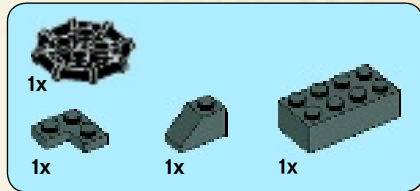
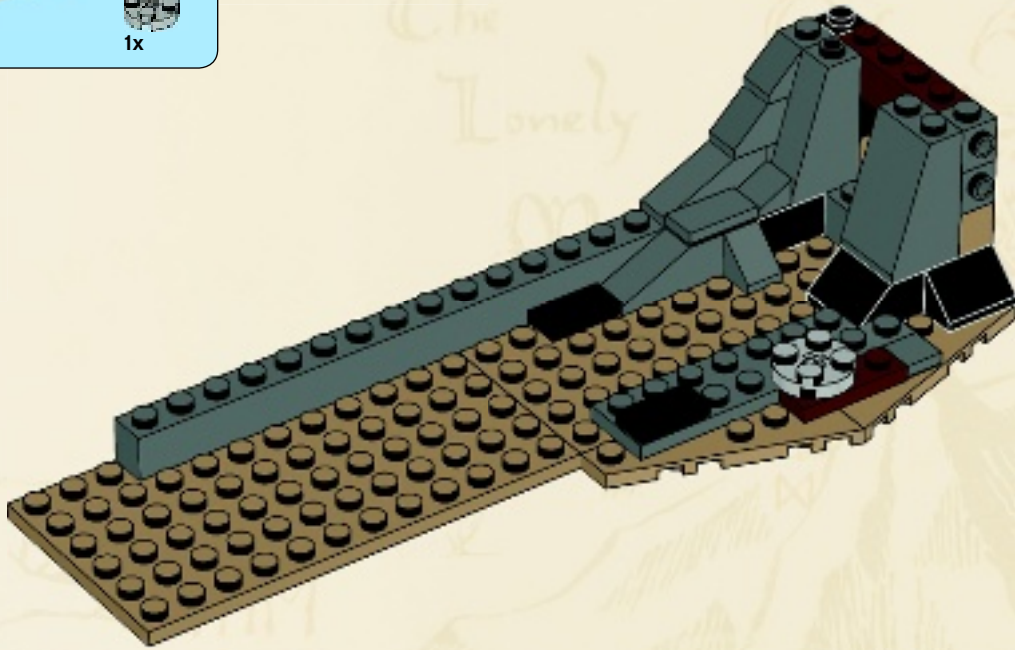

13

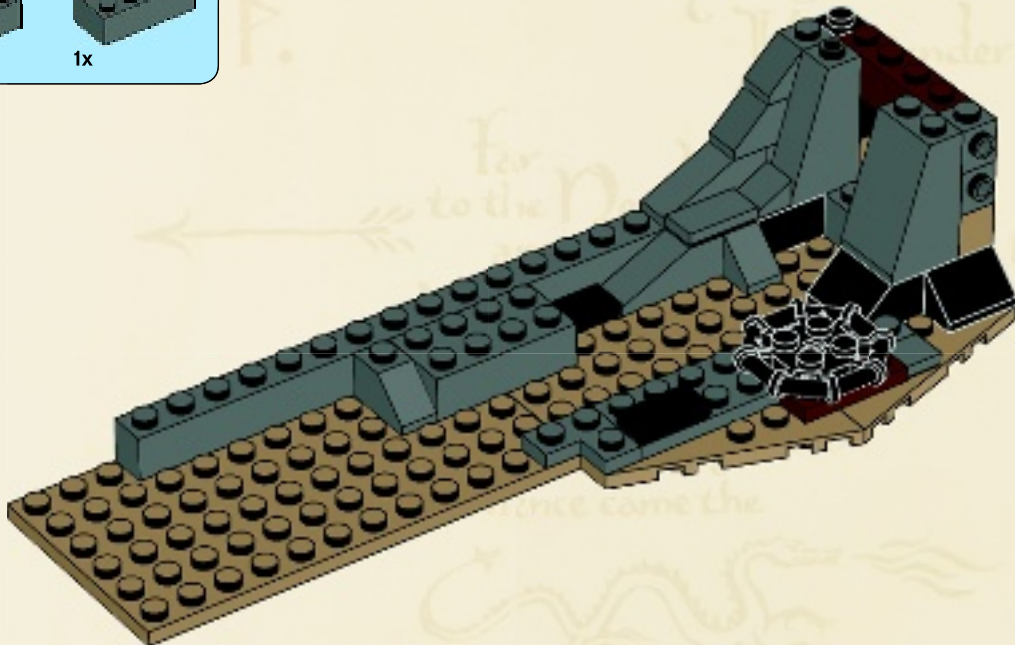

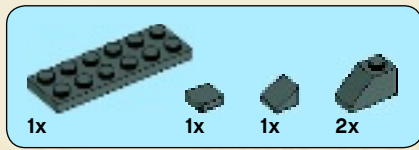

14

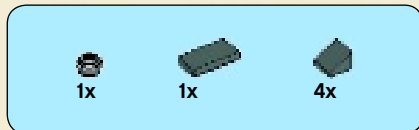
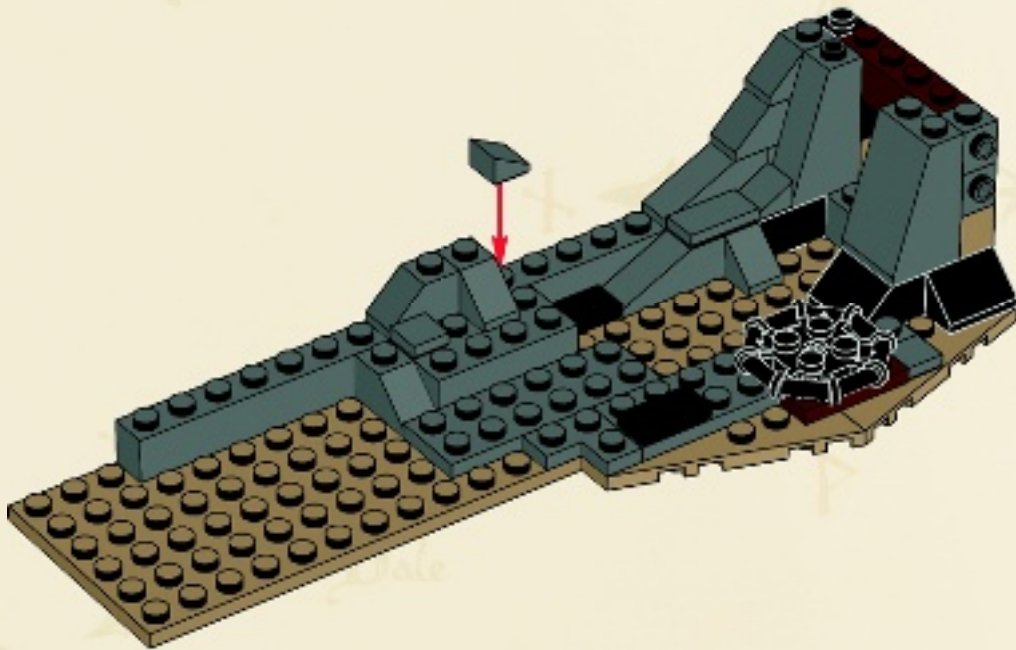

15

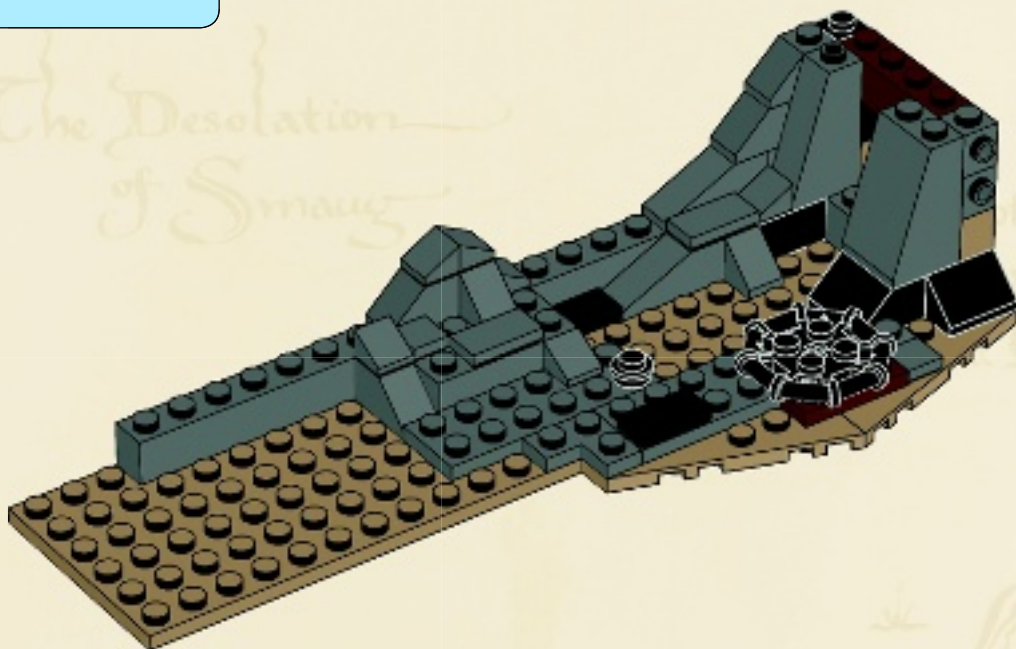

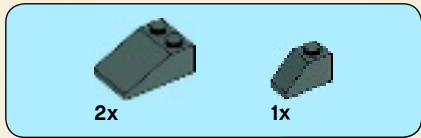

16

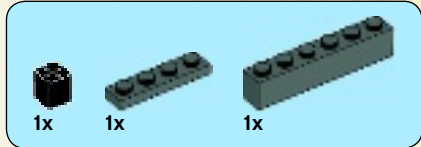
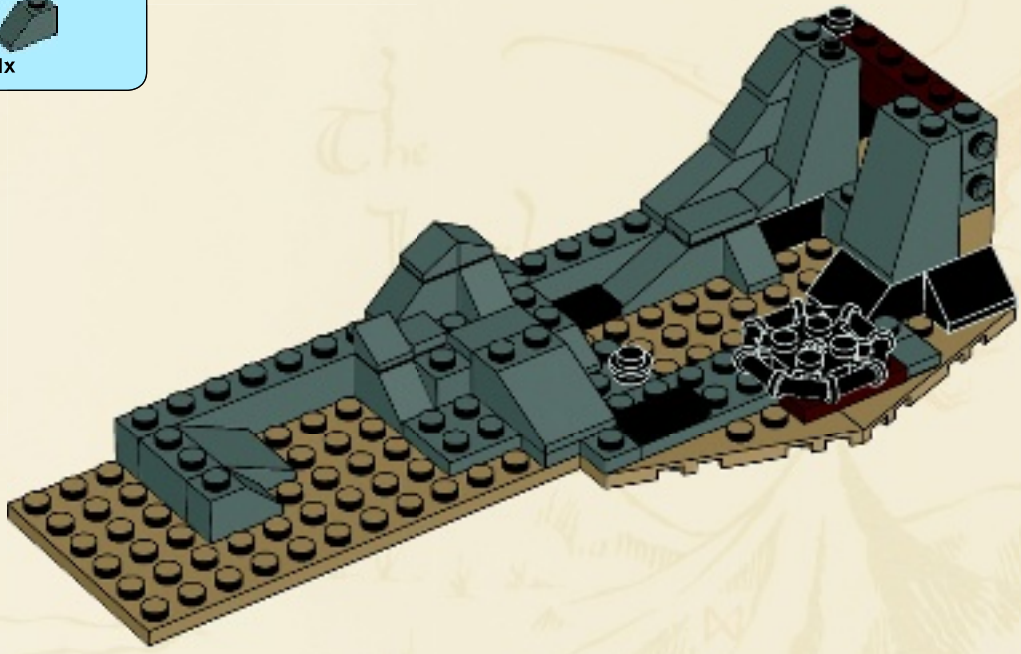

17

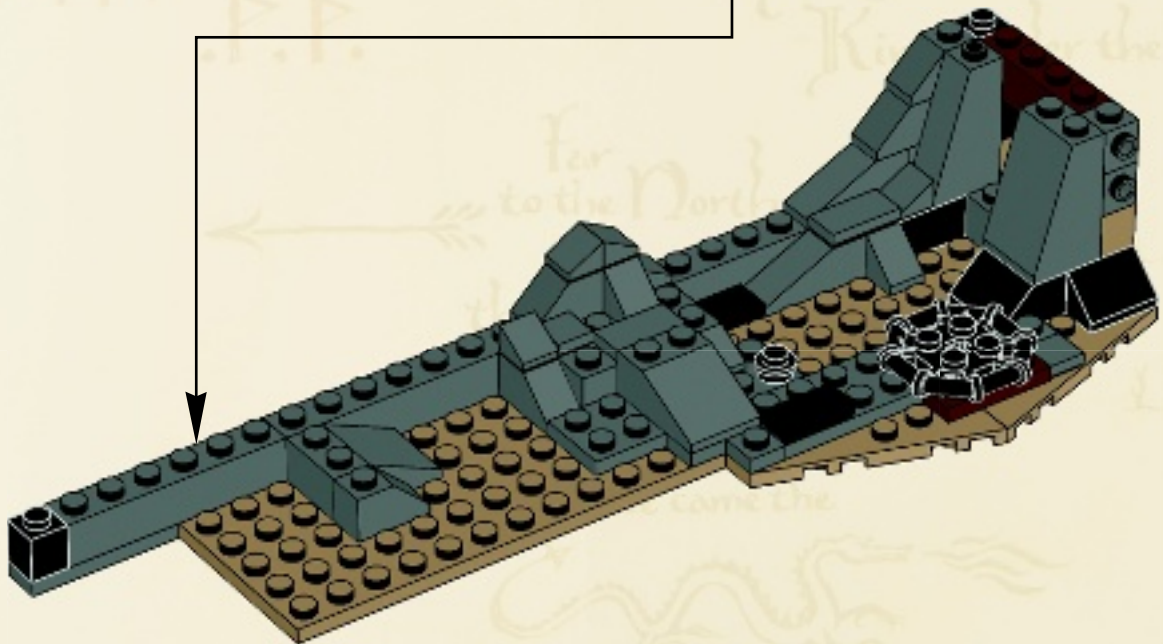
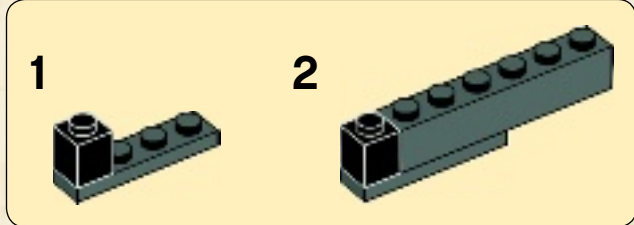

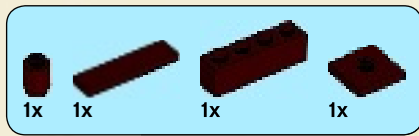

18

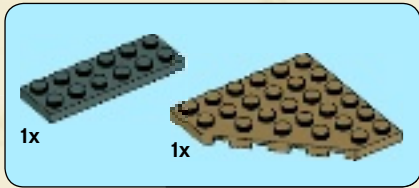
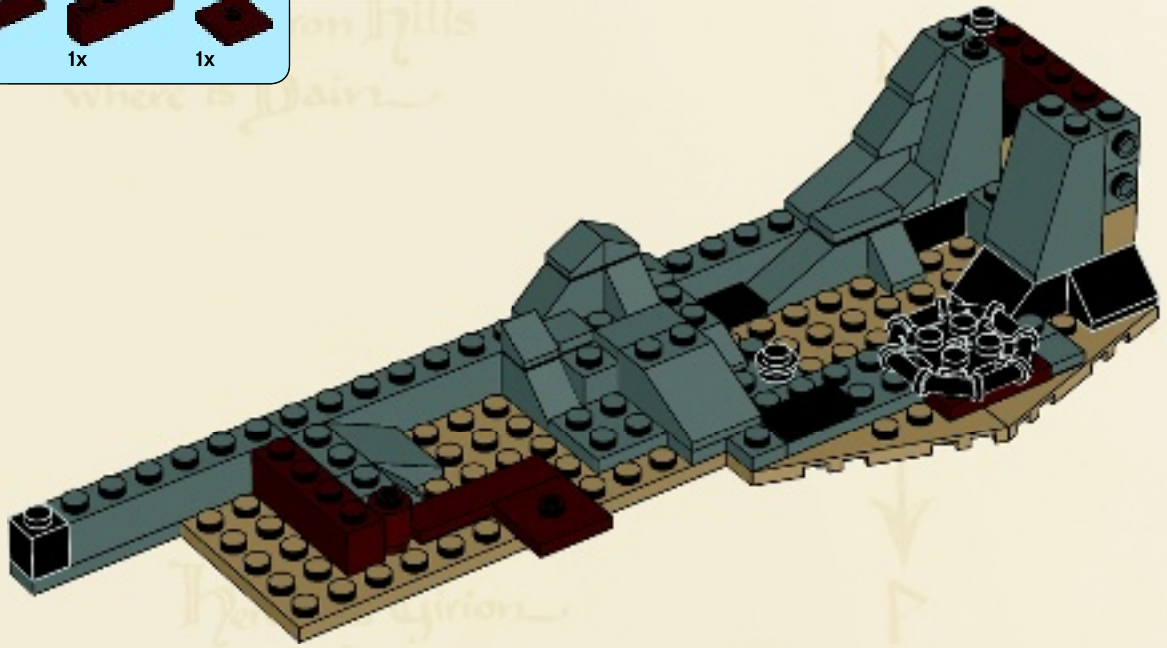

19

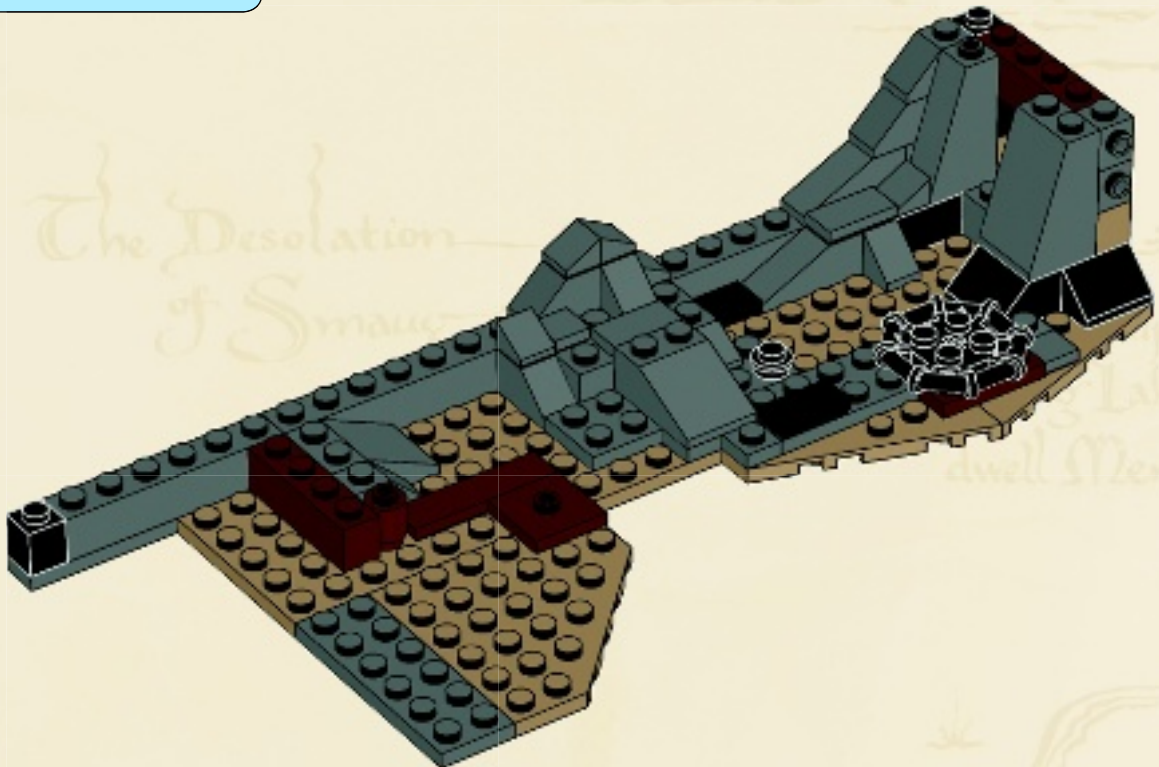

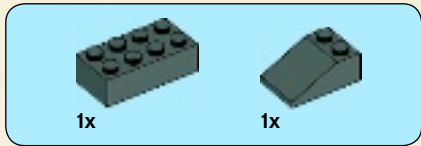

20

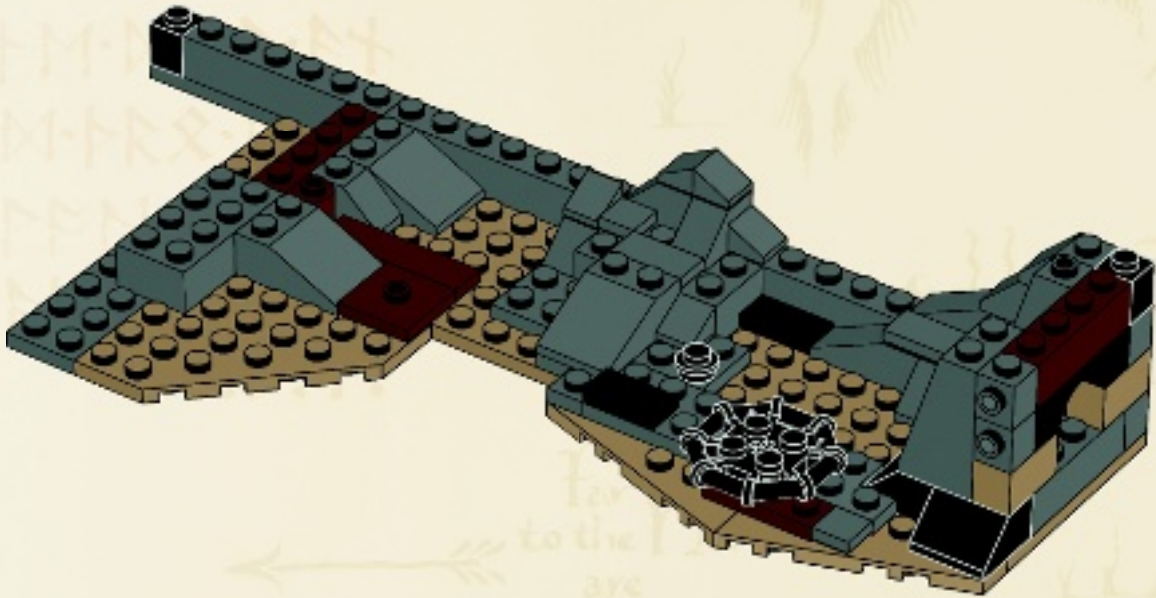
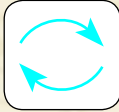

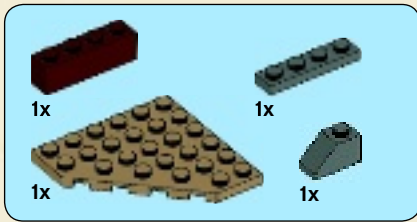

21

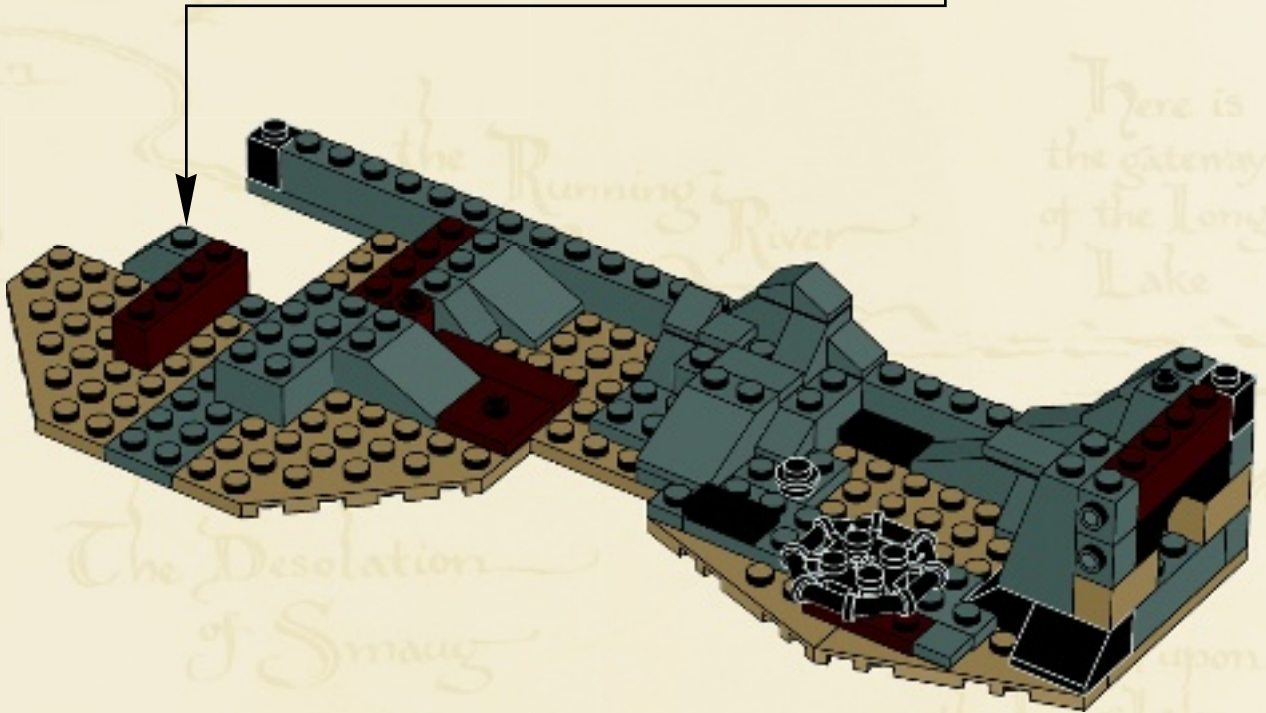
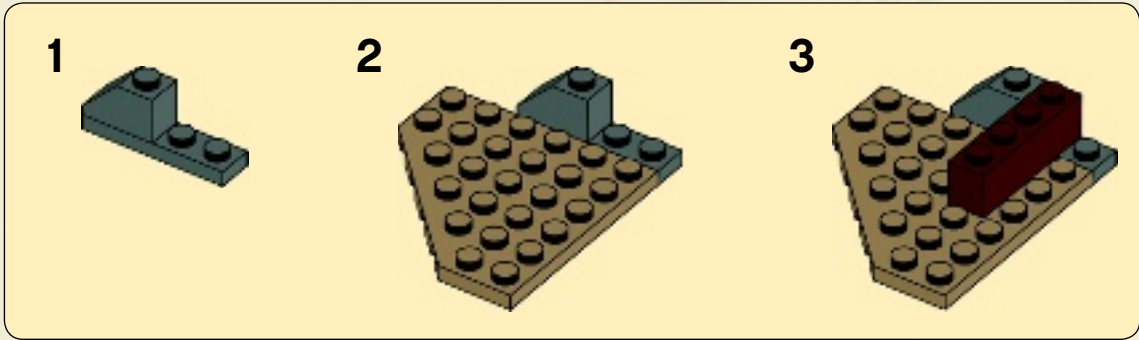

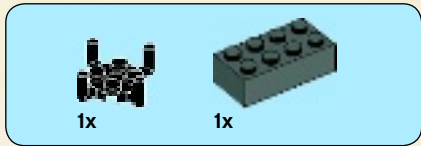

22

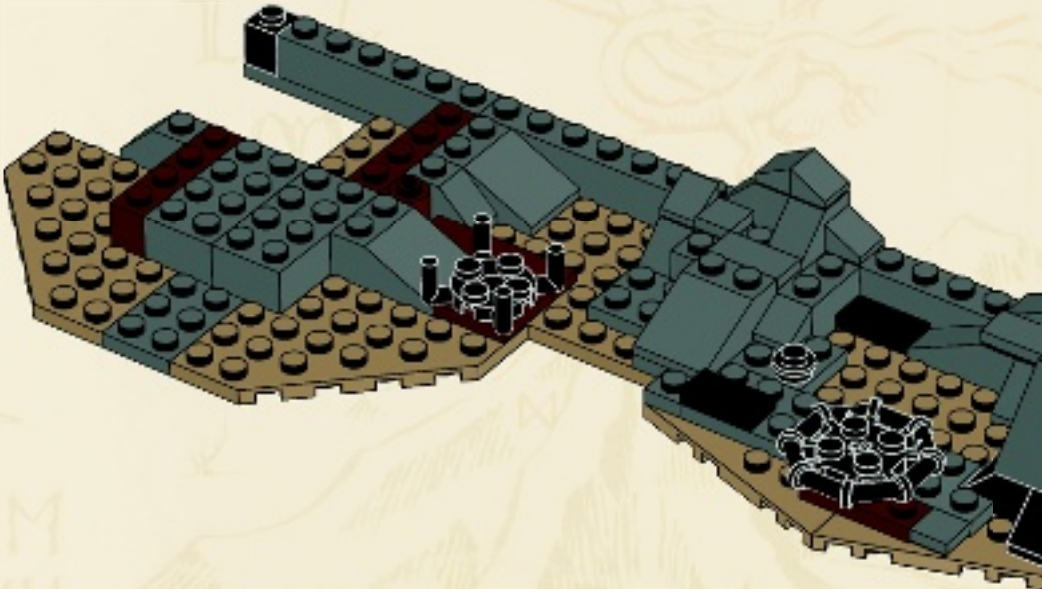

23

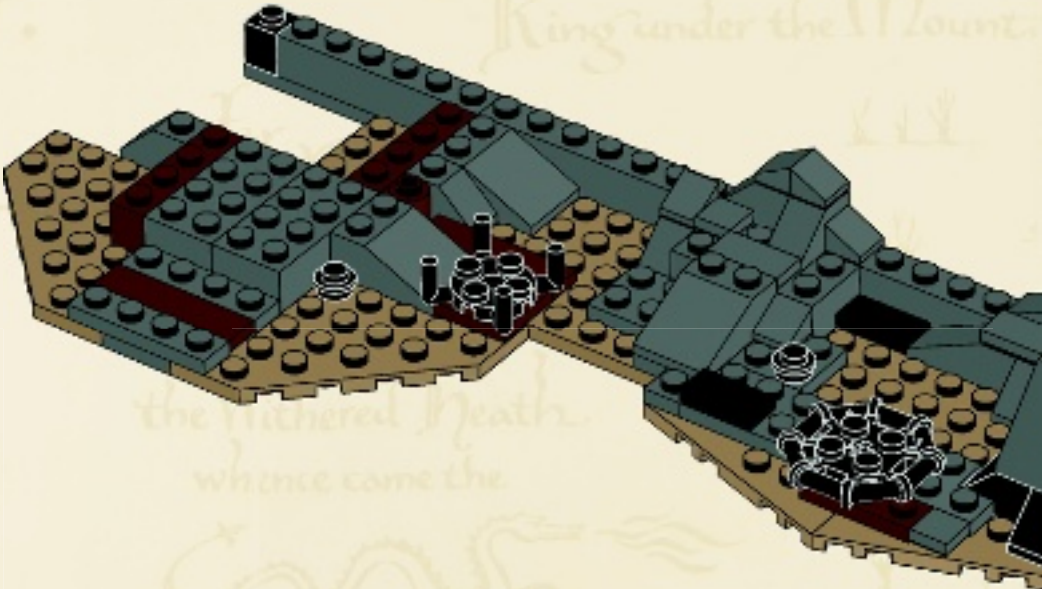

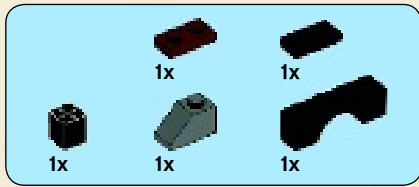

24

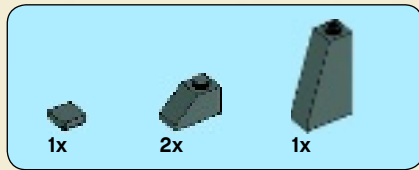
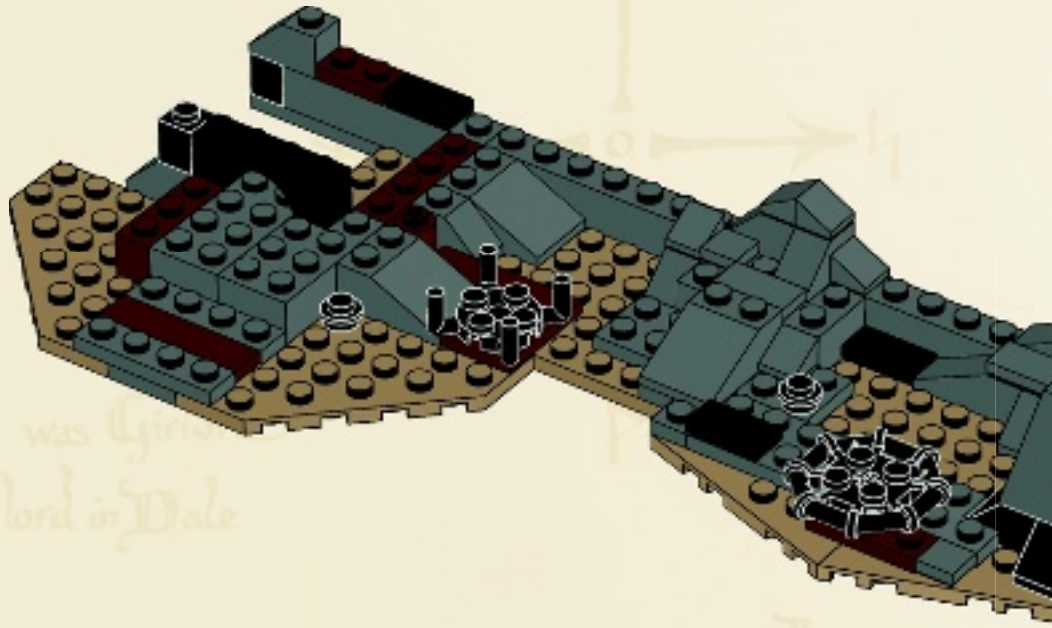

25

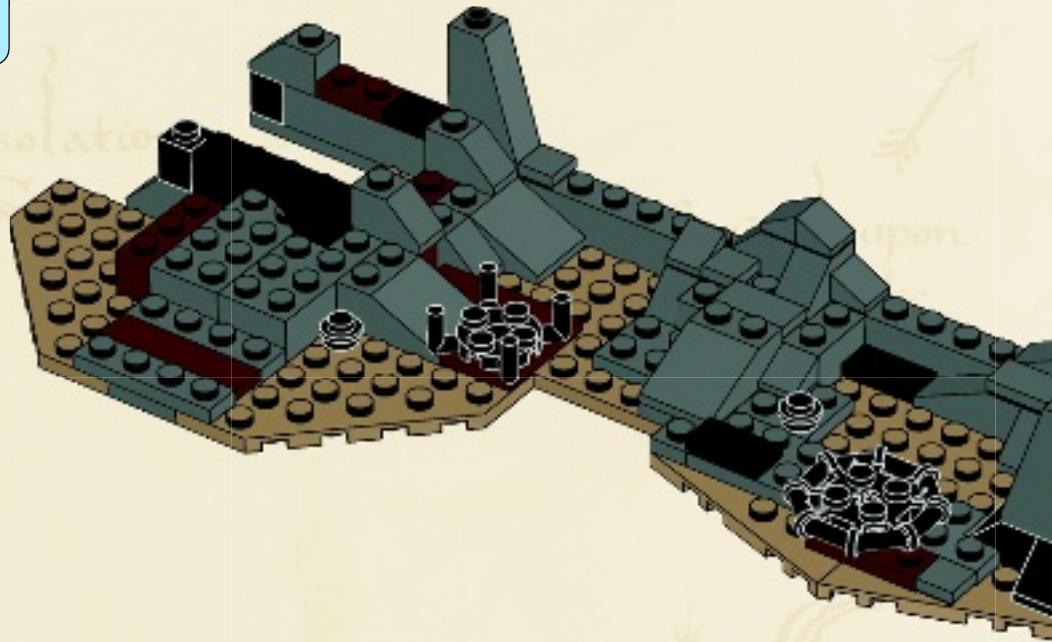

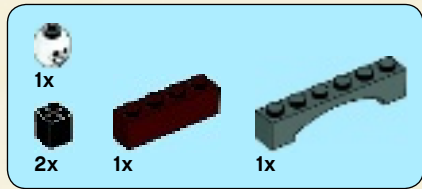

26

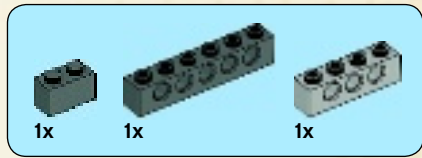
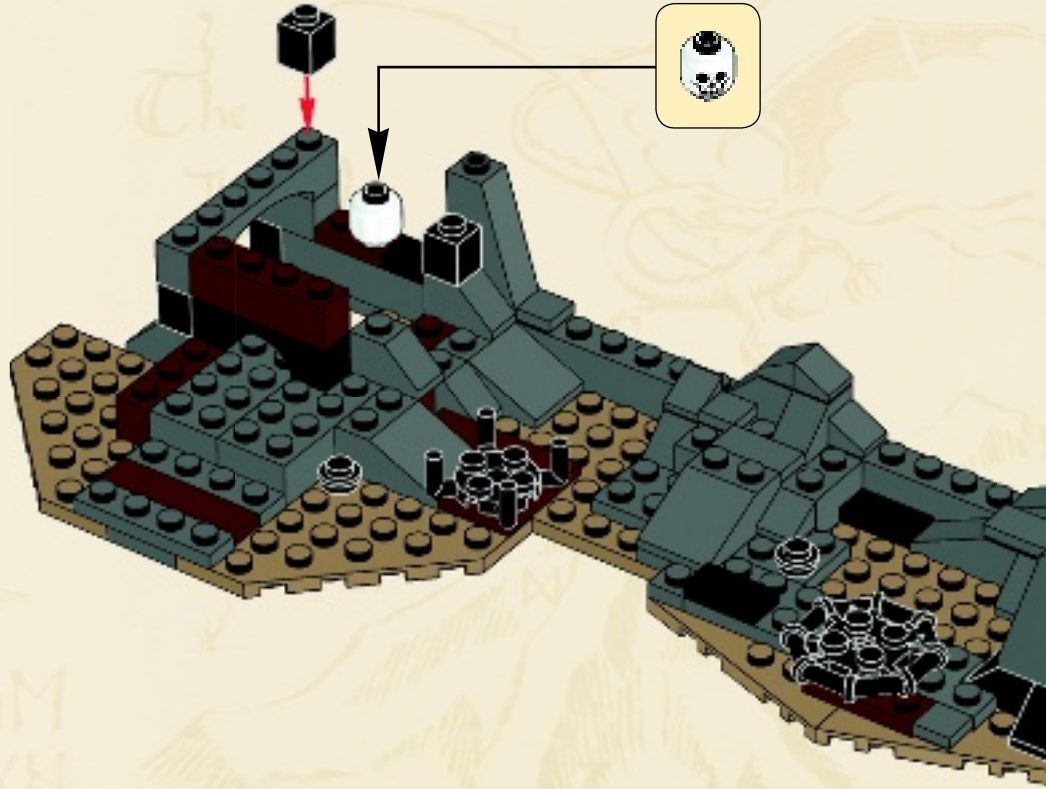

27

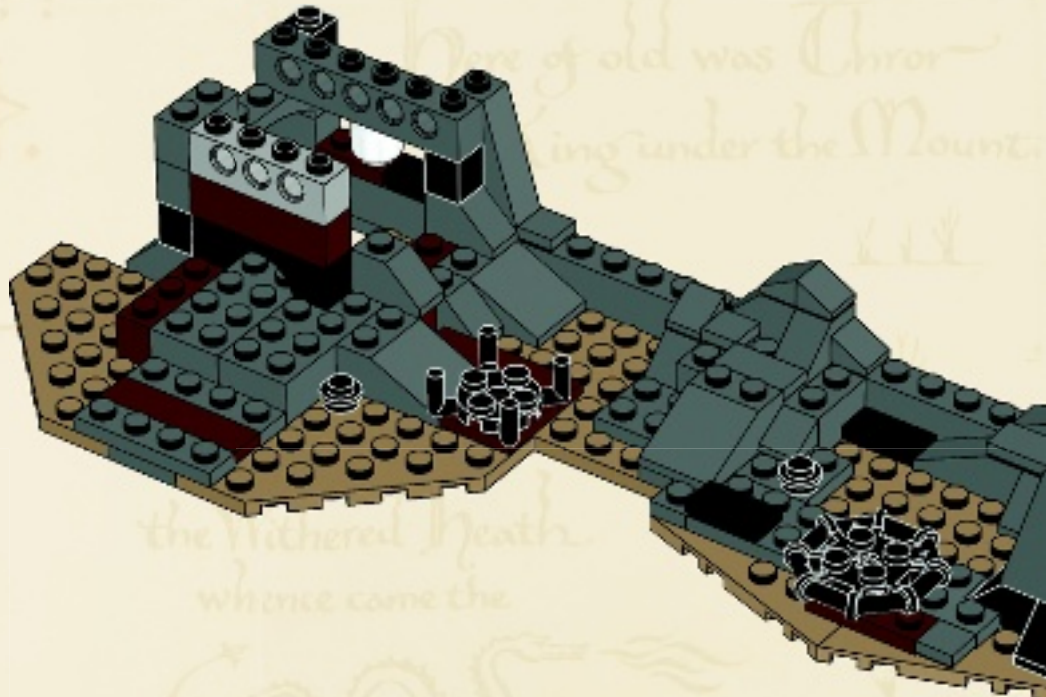

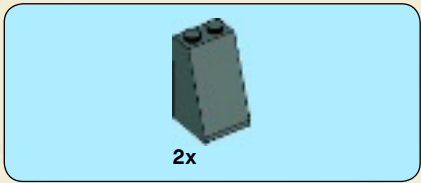

28

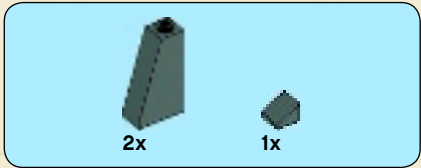
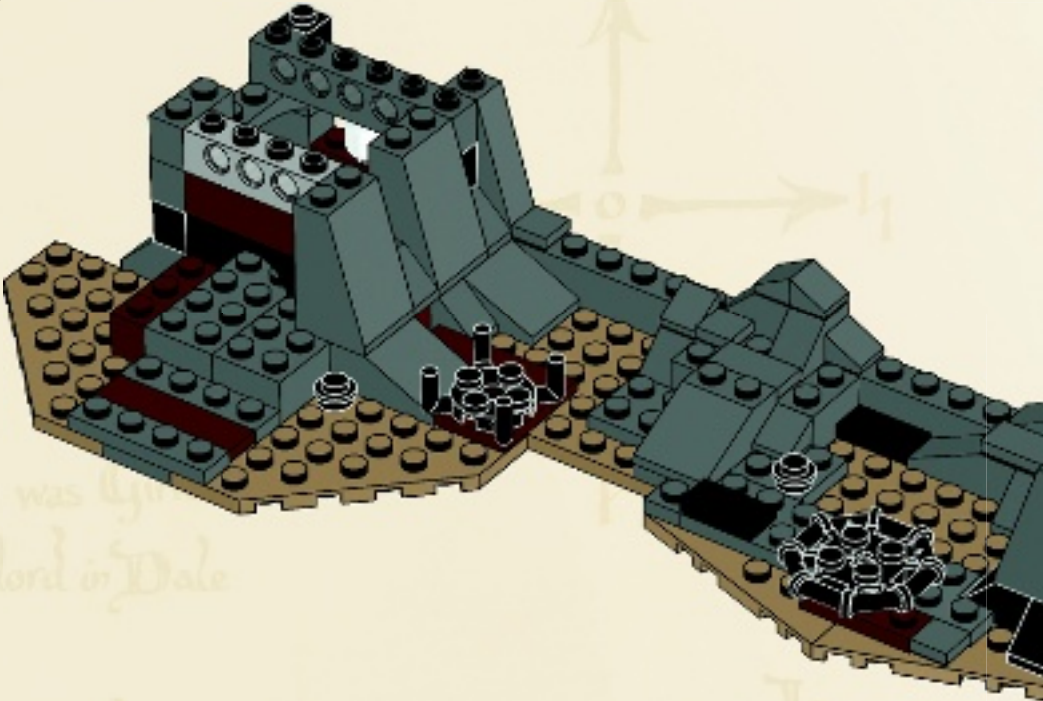

29

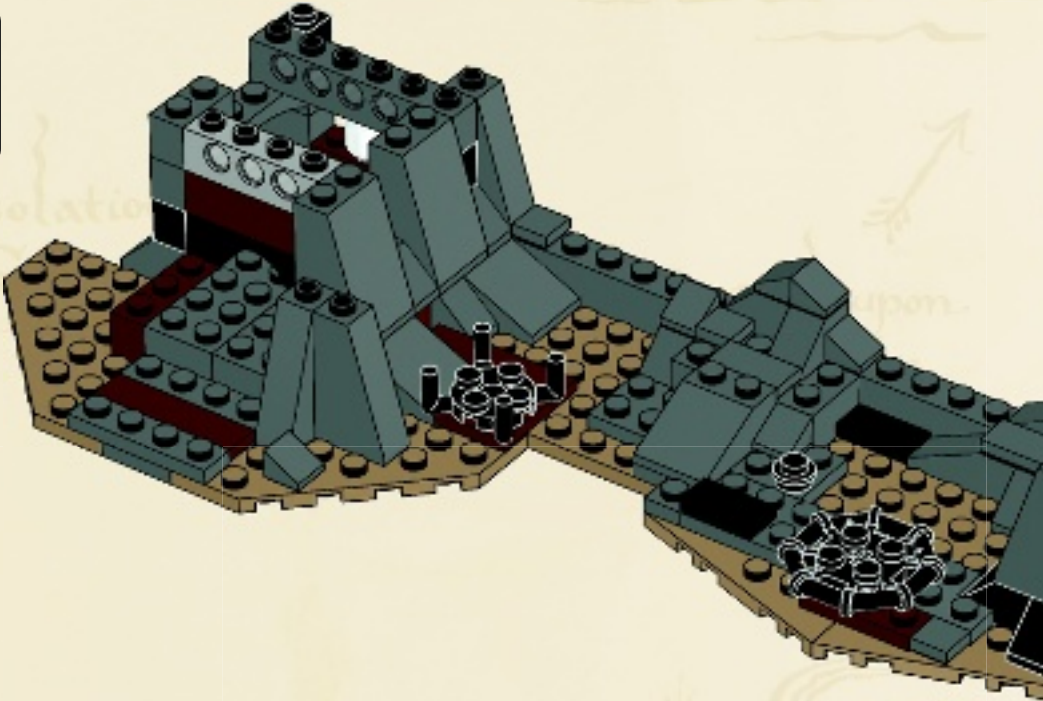



30

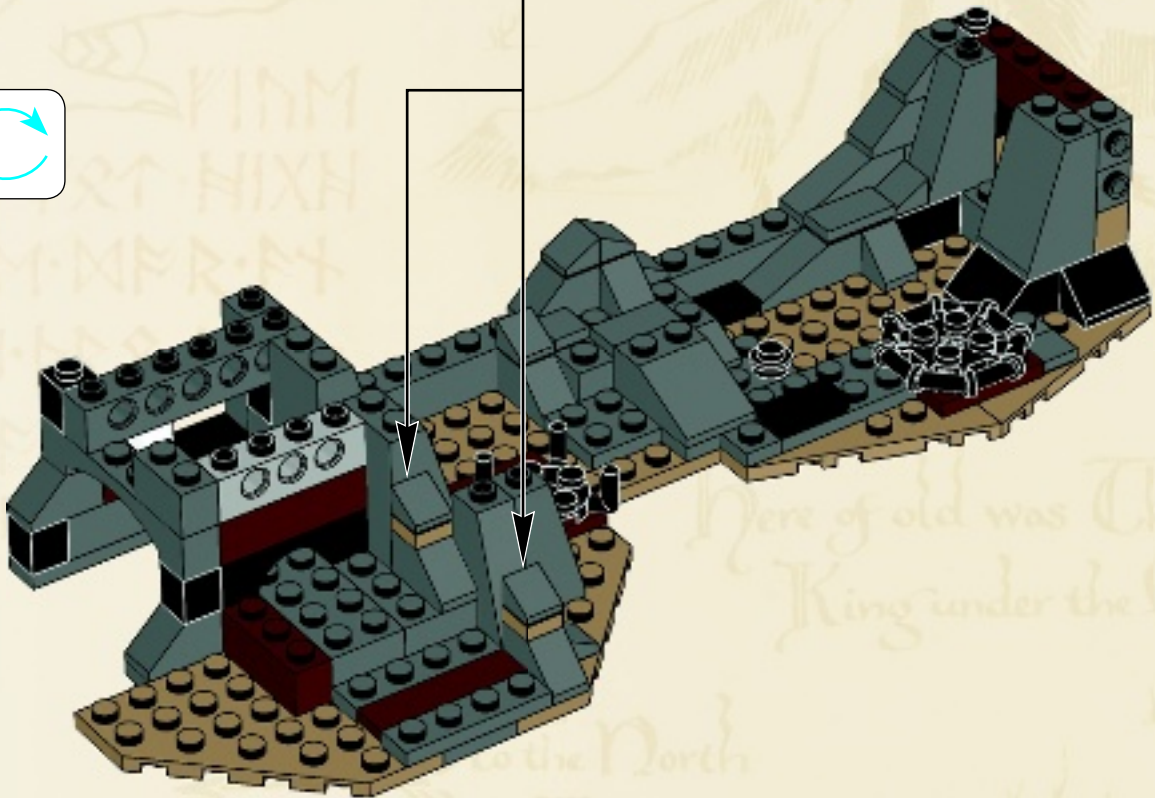
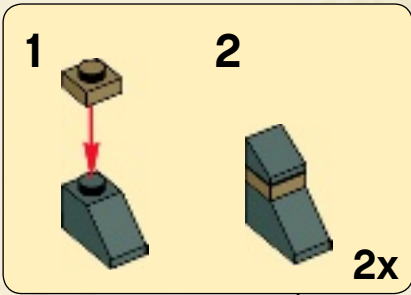

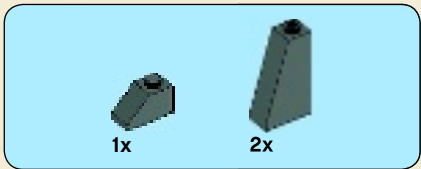

31

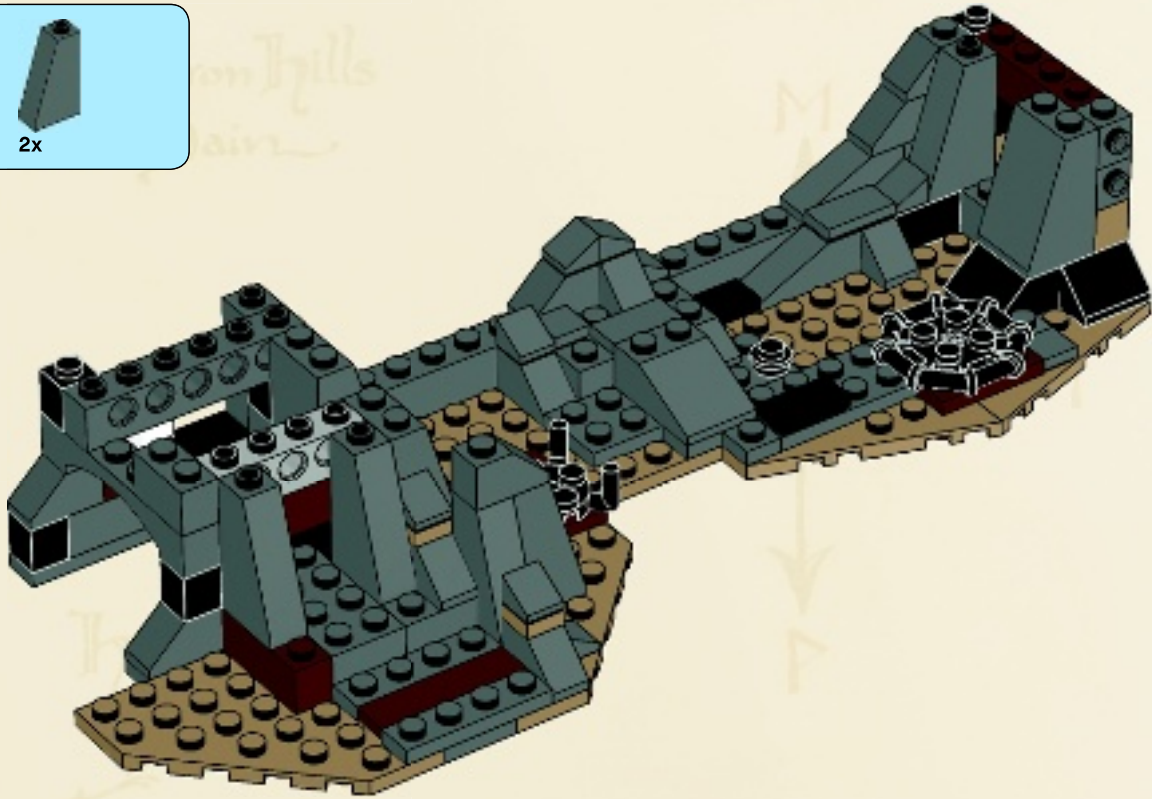

32

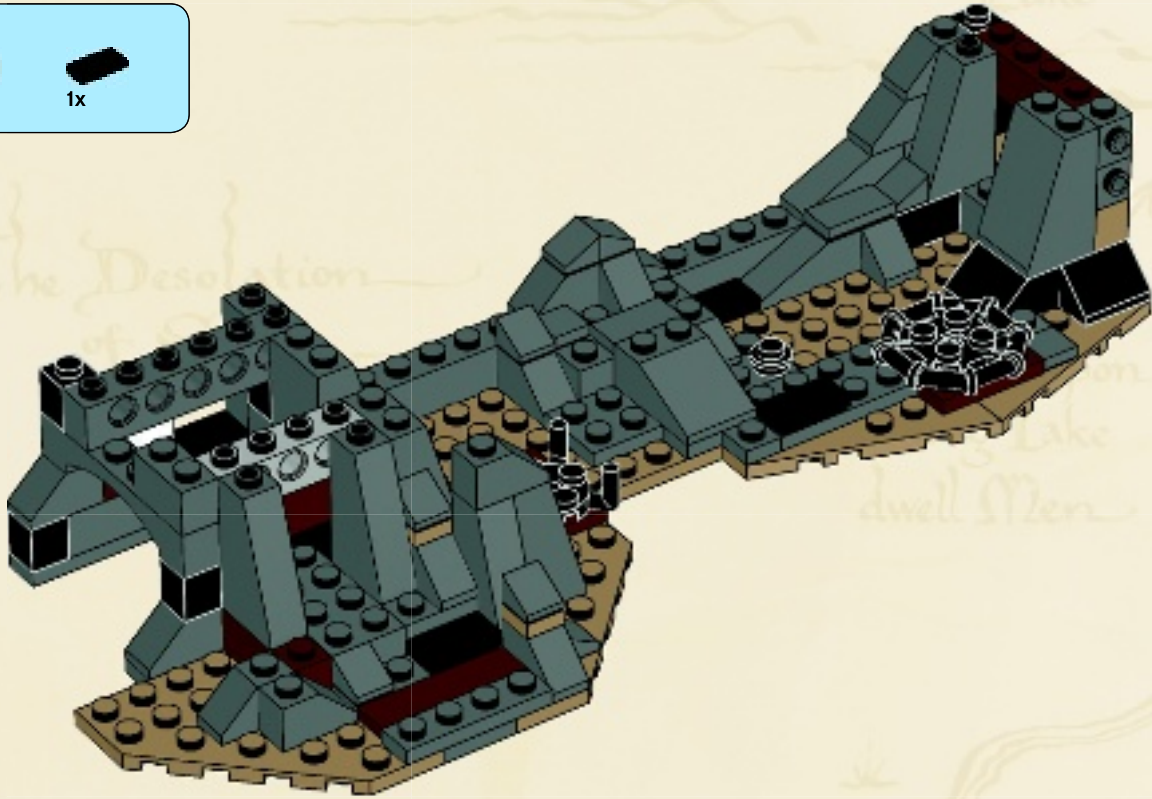



1x



2x

33

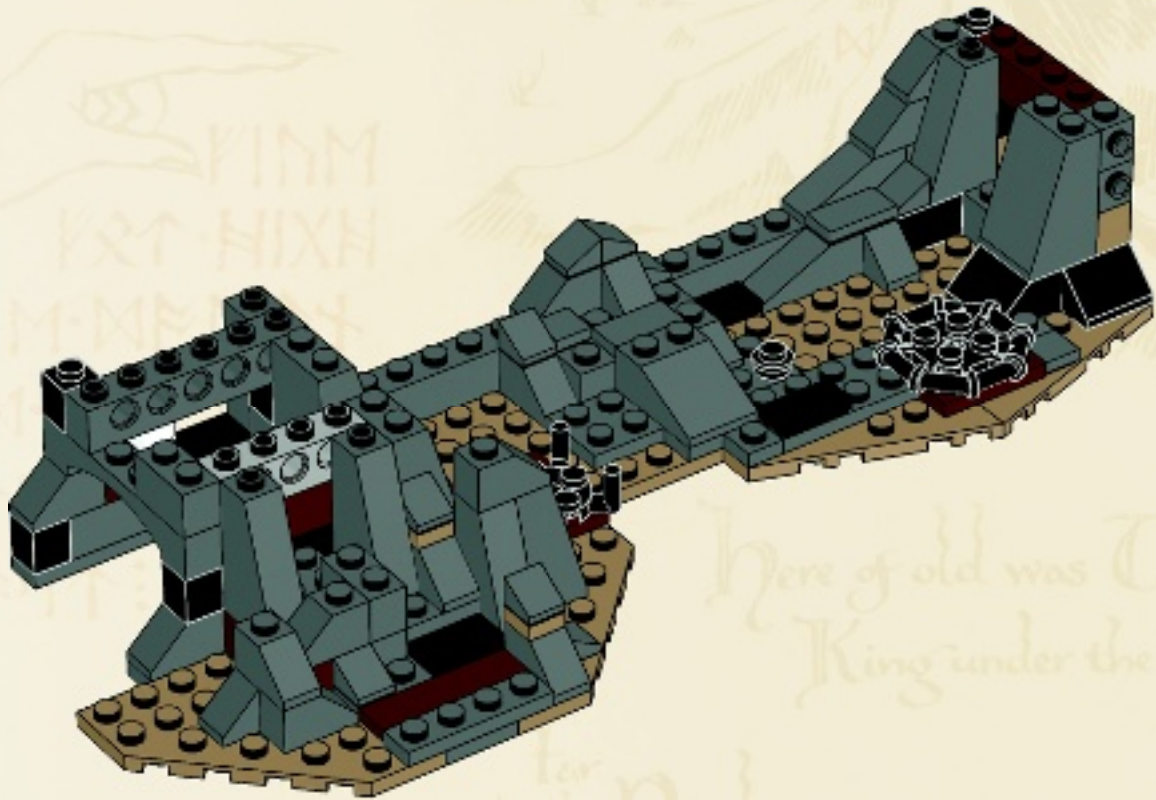

The
Lonely
Mountains

Here of old was Thoror
King under the Mountain

to the North
are
the Grey Mountains
&
the Withered Heath
whence come the

2x

1x

34

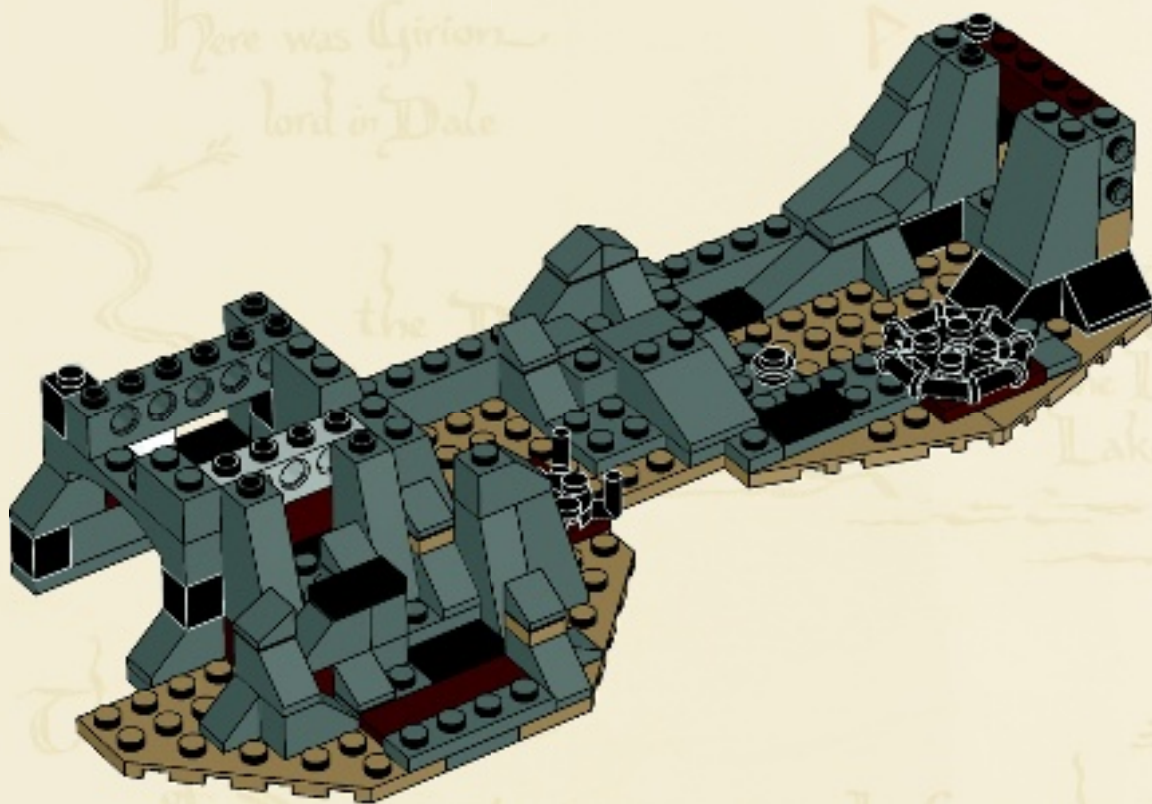

3x 1x 1x

35

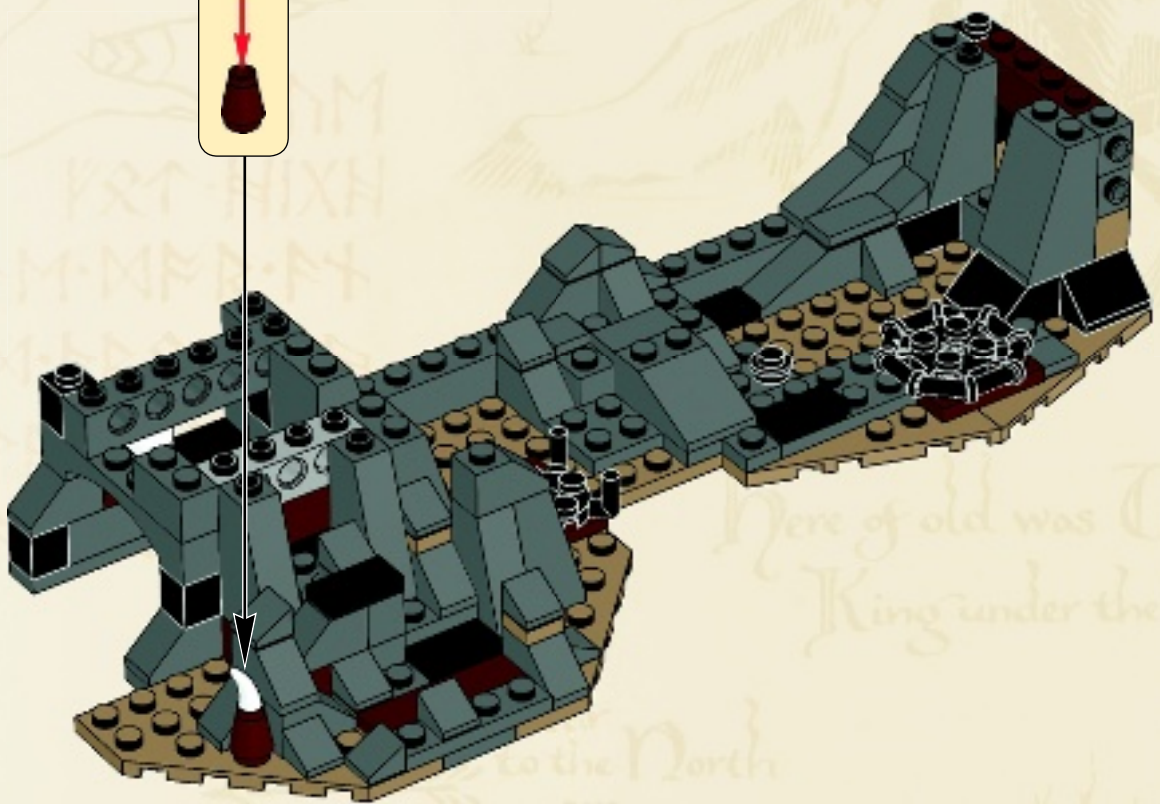
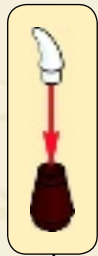

The Lonely Mountains

Here of old was Thoror King under the Mountain

to the North are the Grey Mountains & the Withered Heath whence come the

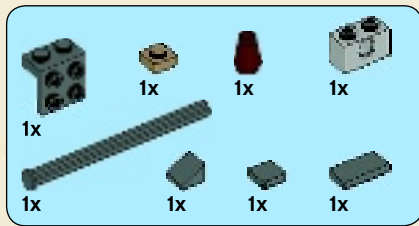

36

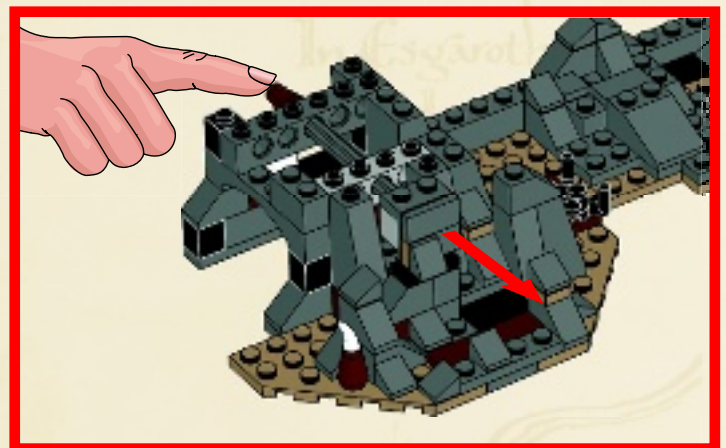
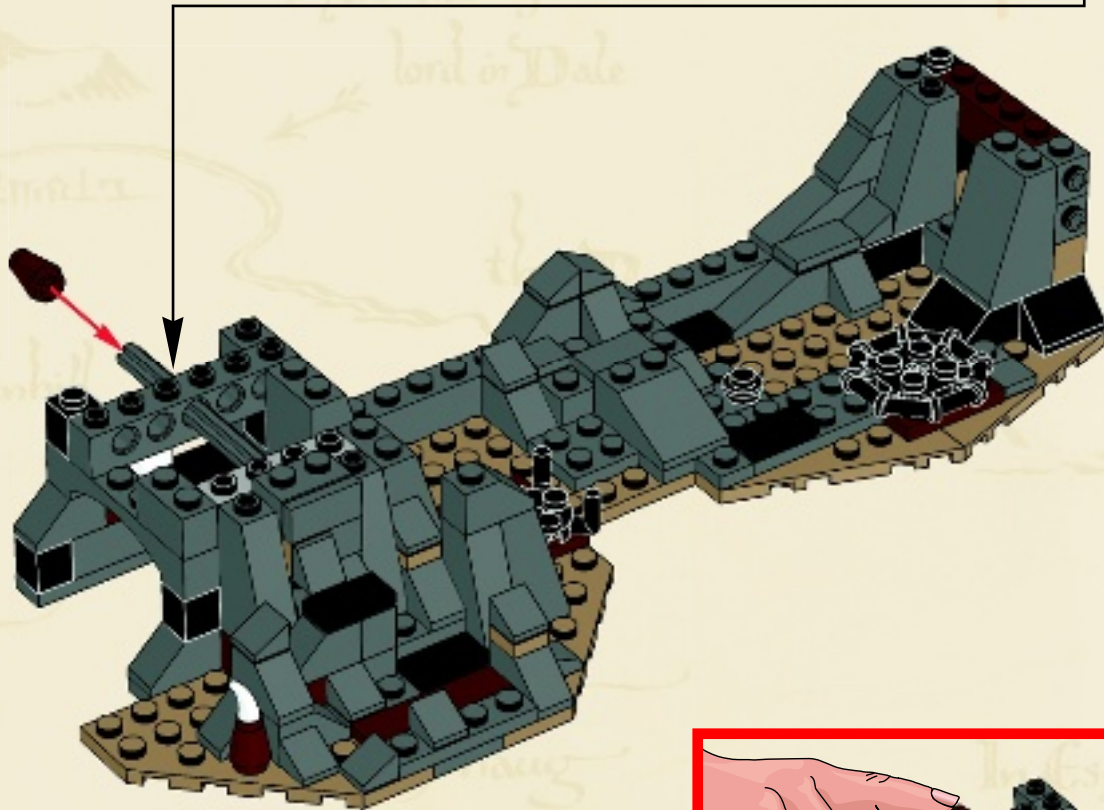
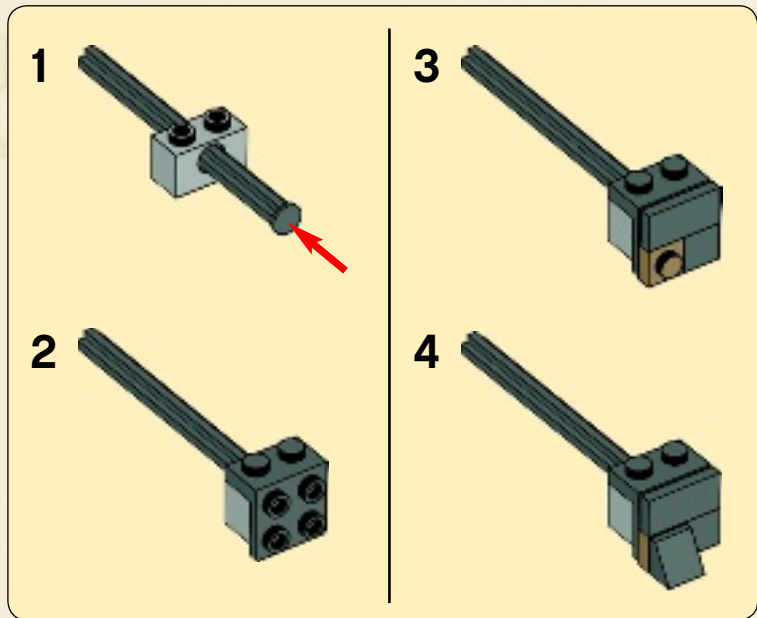

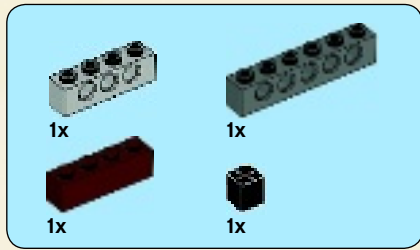

37



The
Lonely
Mountains

Here of old was Thoror
King under the Moun

Far
to the North
are
the Grey Mountains
the Withered Heath
whence come the

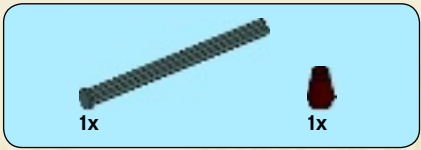

38

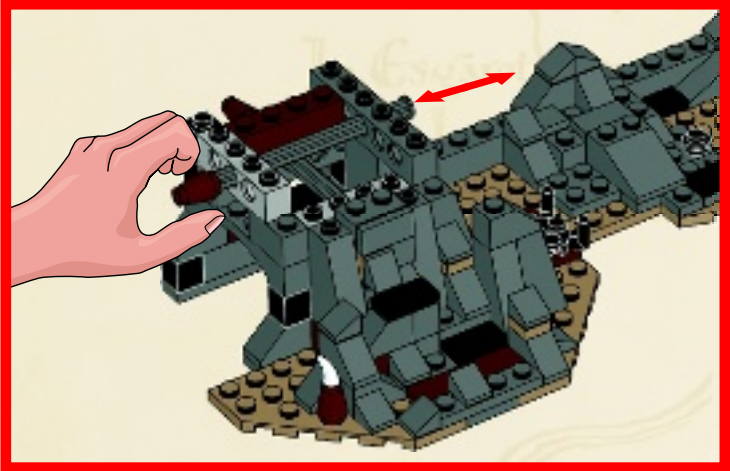
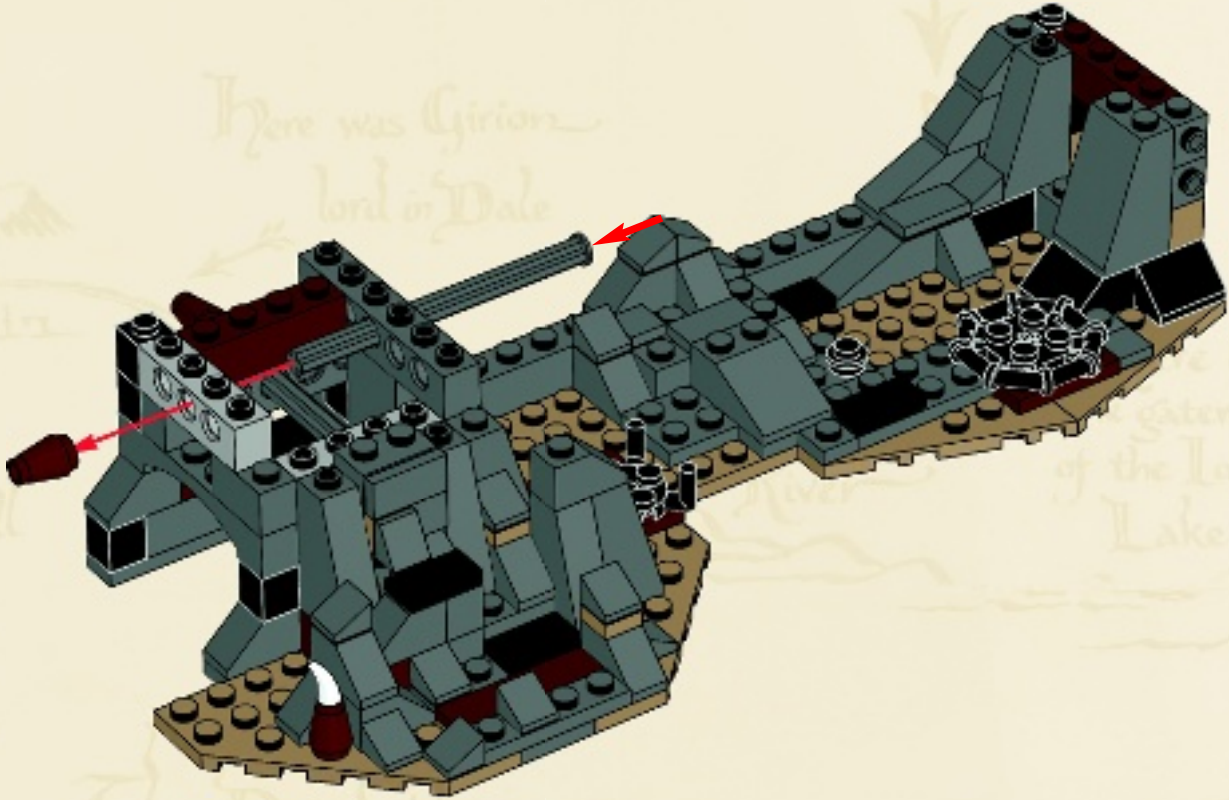

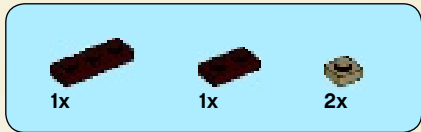

39

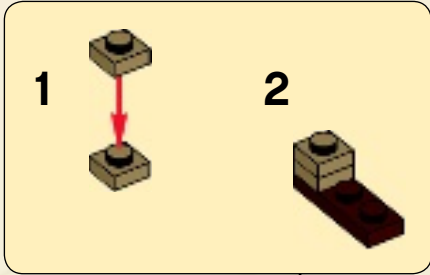

The
Lonely
Mountains

Here of old was Thoror
King under the Mount

to the North
are
the Grey Mountains
&
the Withered Heath
whence come the



1x



1x

40

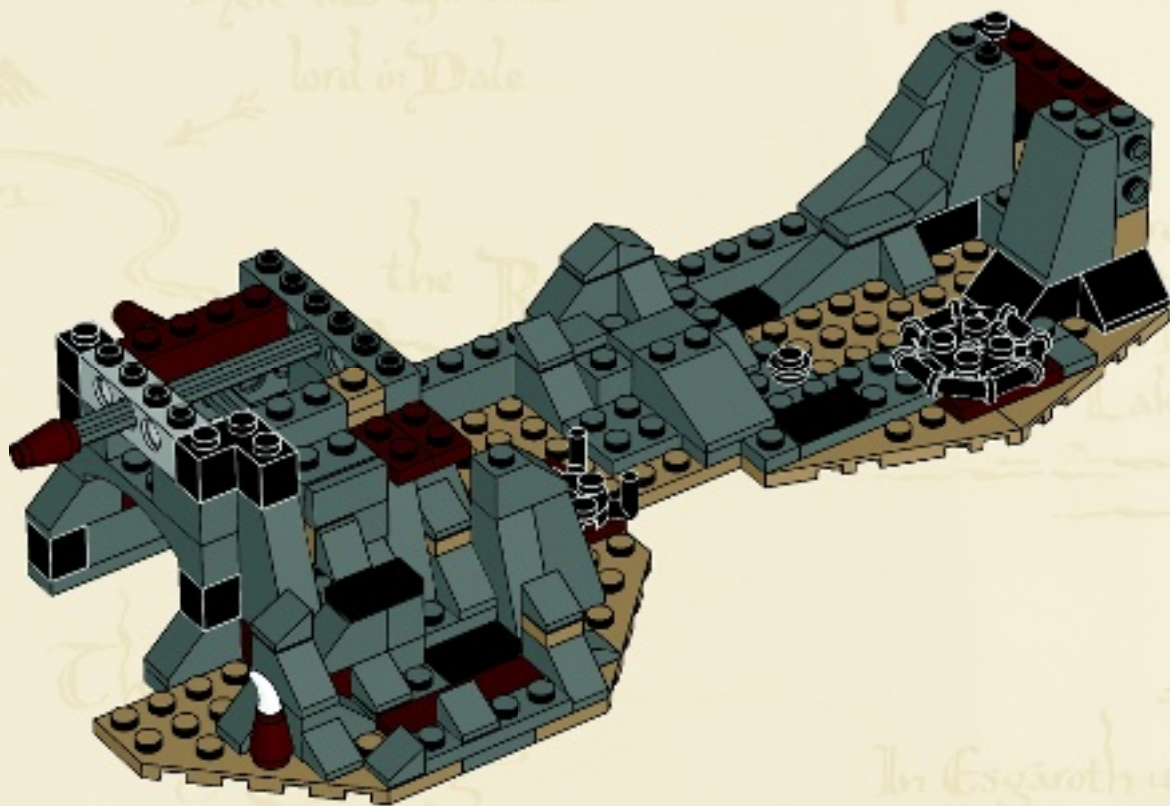

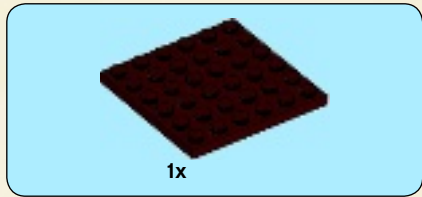

41

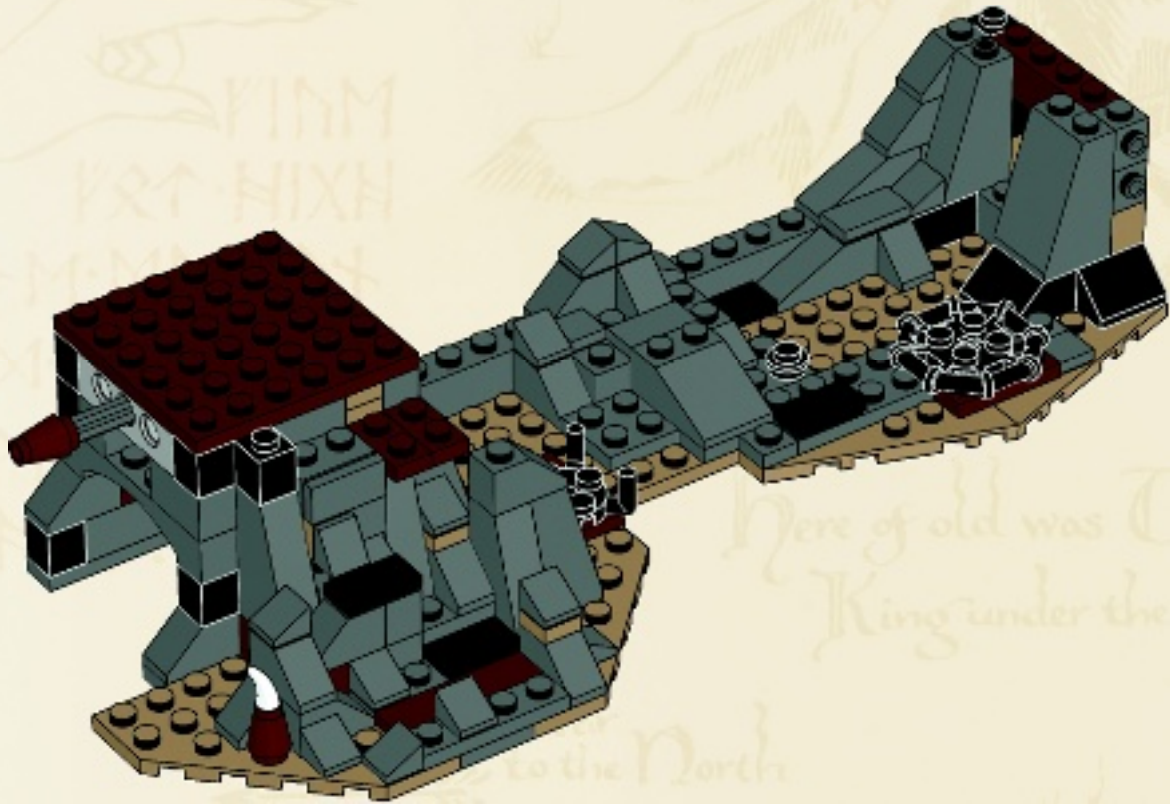

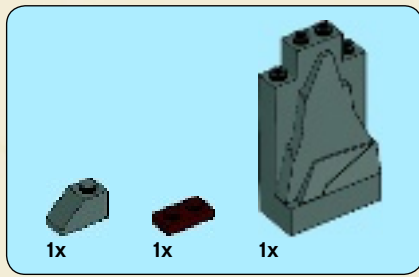

42

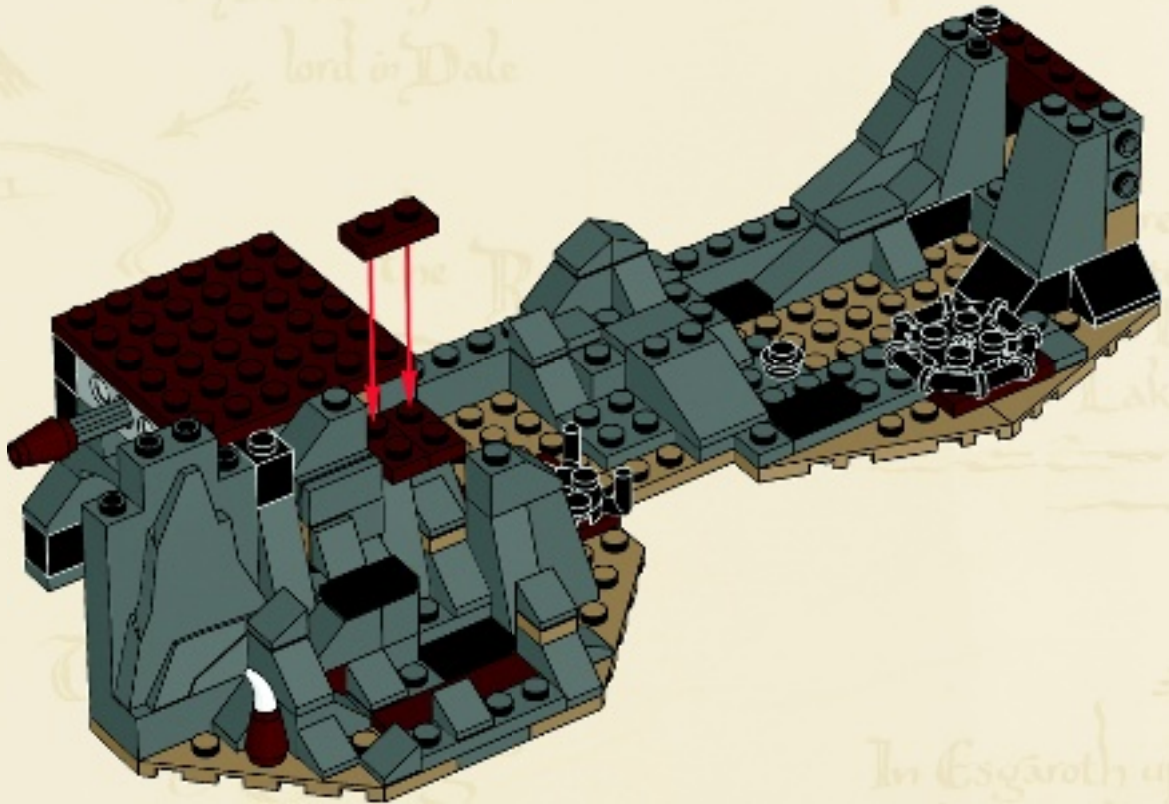

		
1x	1x	2x

43



The Lonely Mountains

Here of old was Thoror King under the Mountain

to the North are the Grey Mountains & the Withered Heath whence come the

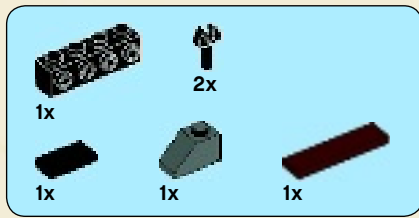

44

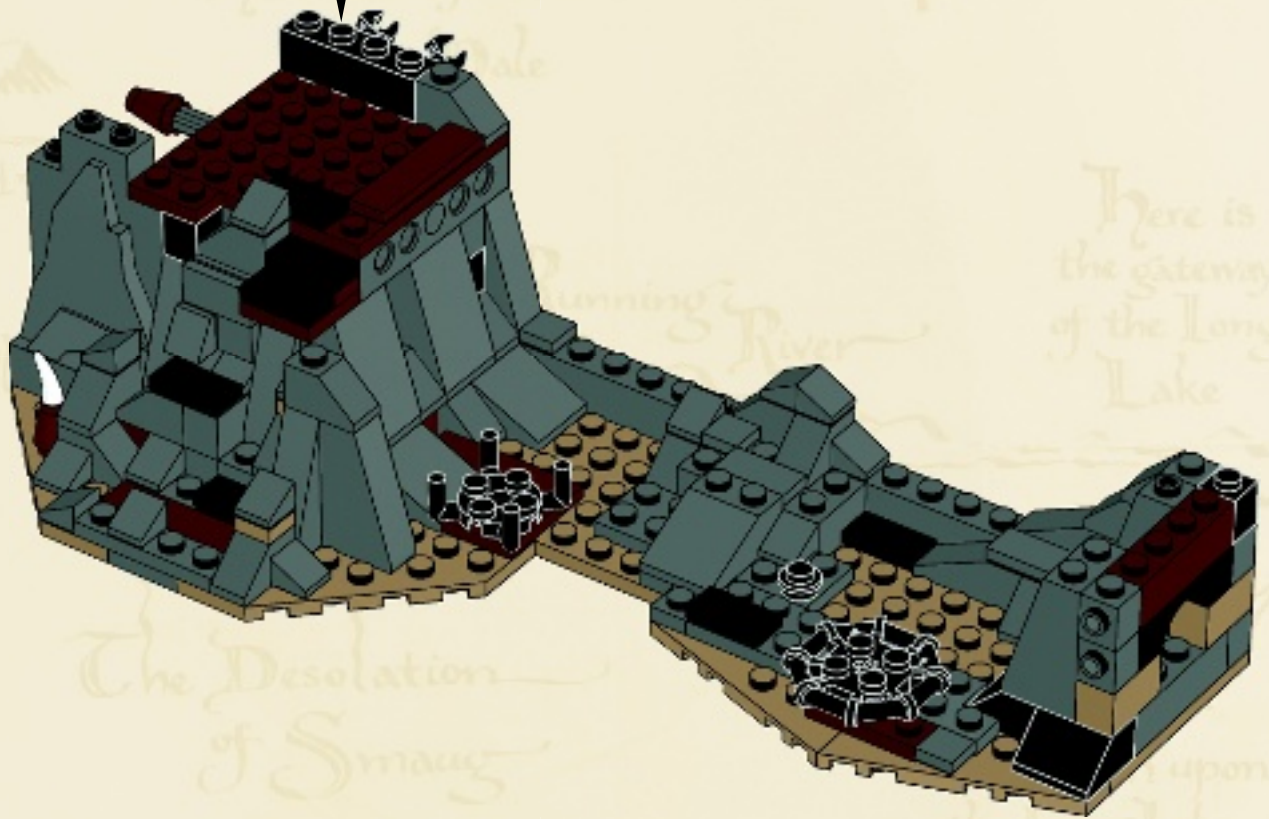
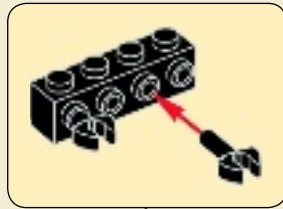

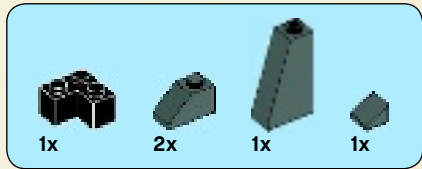

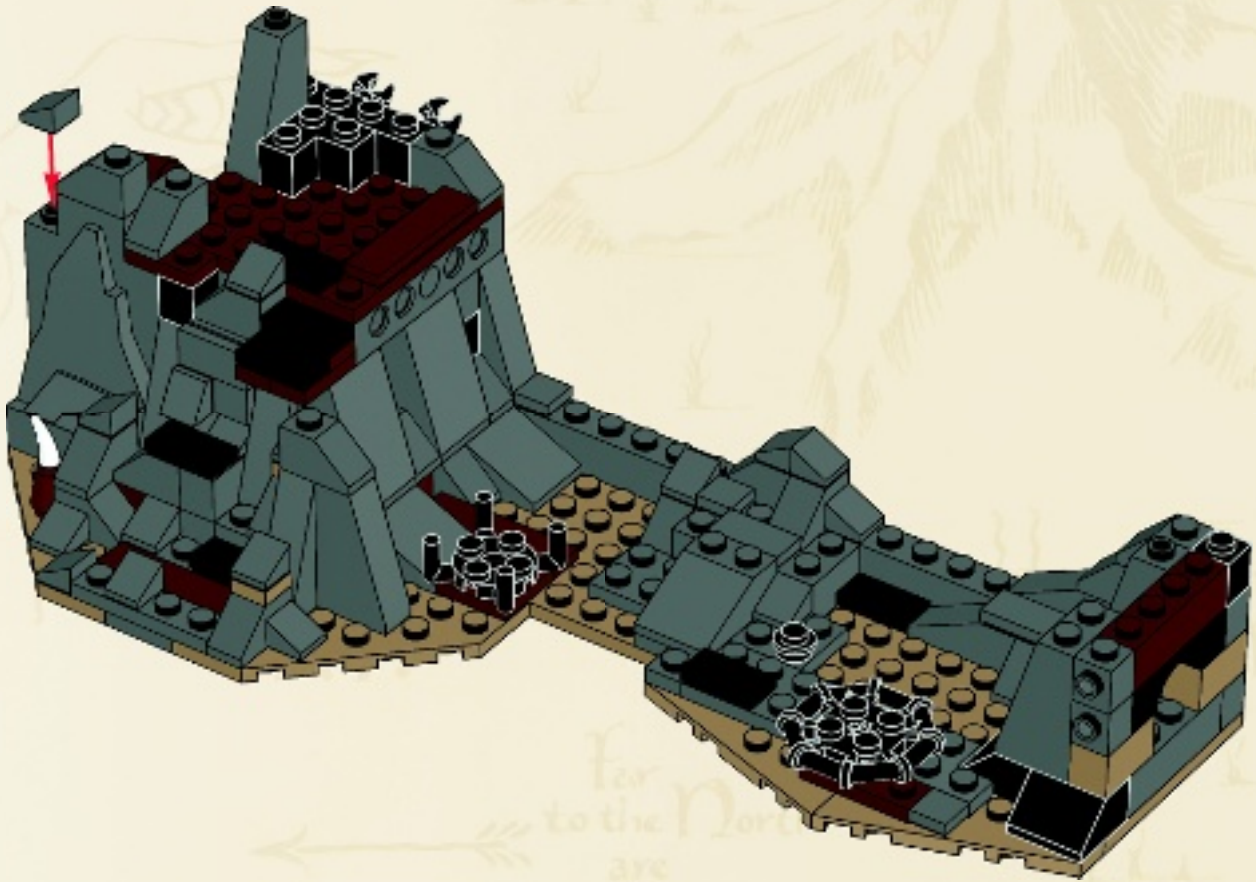

45

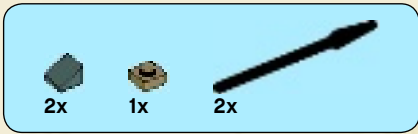

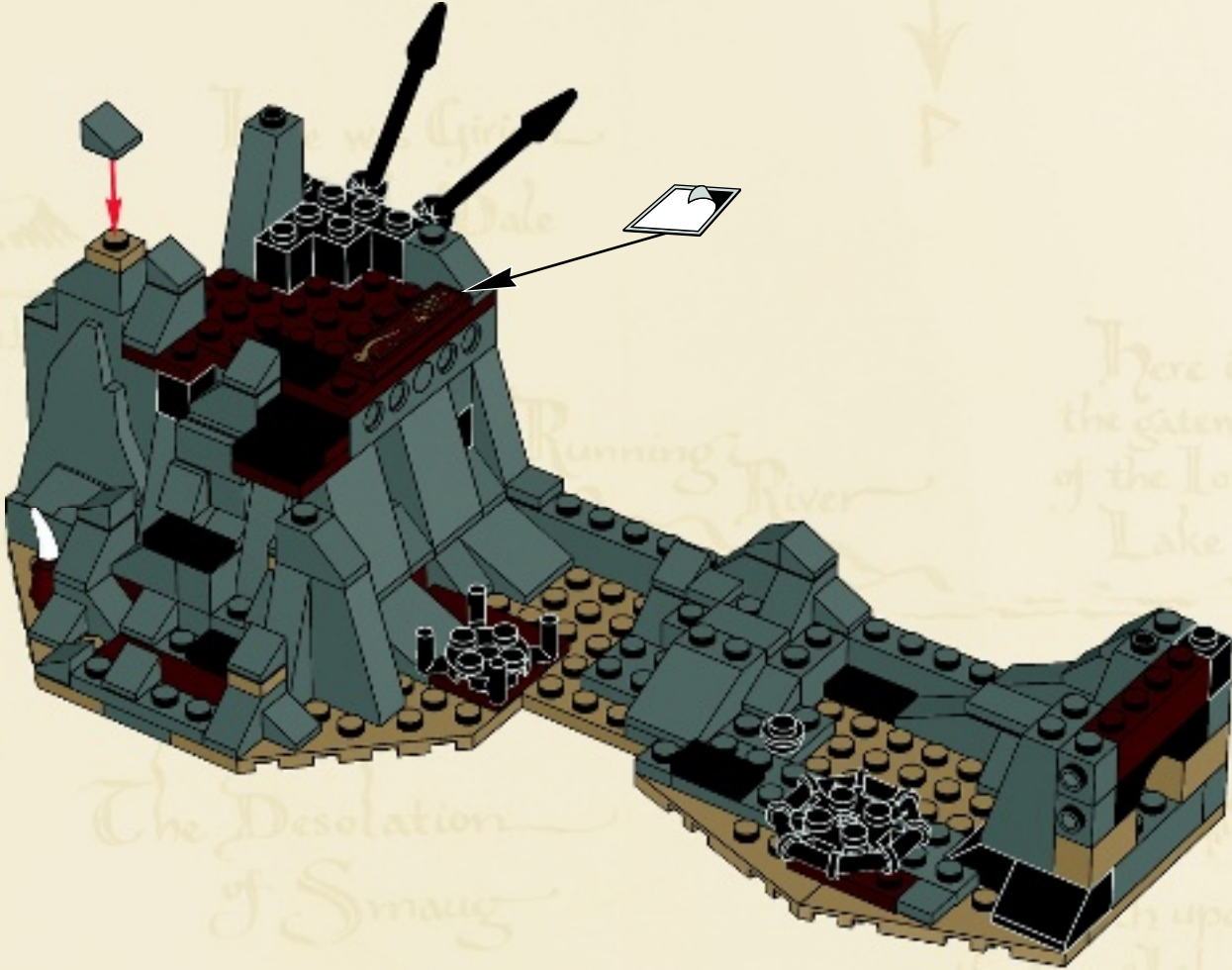

46



2x  1x 

47

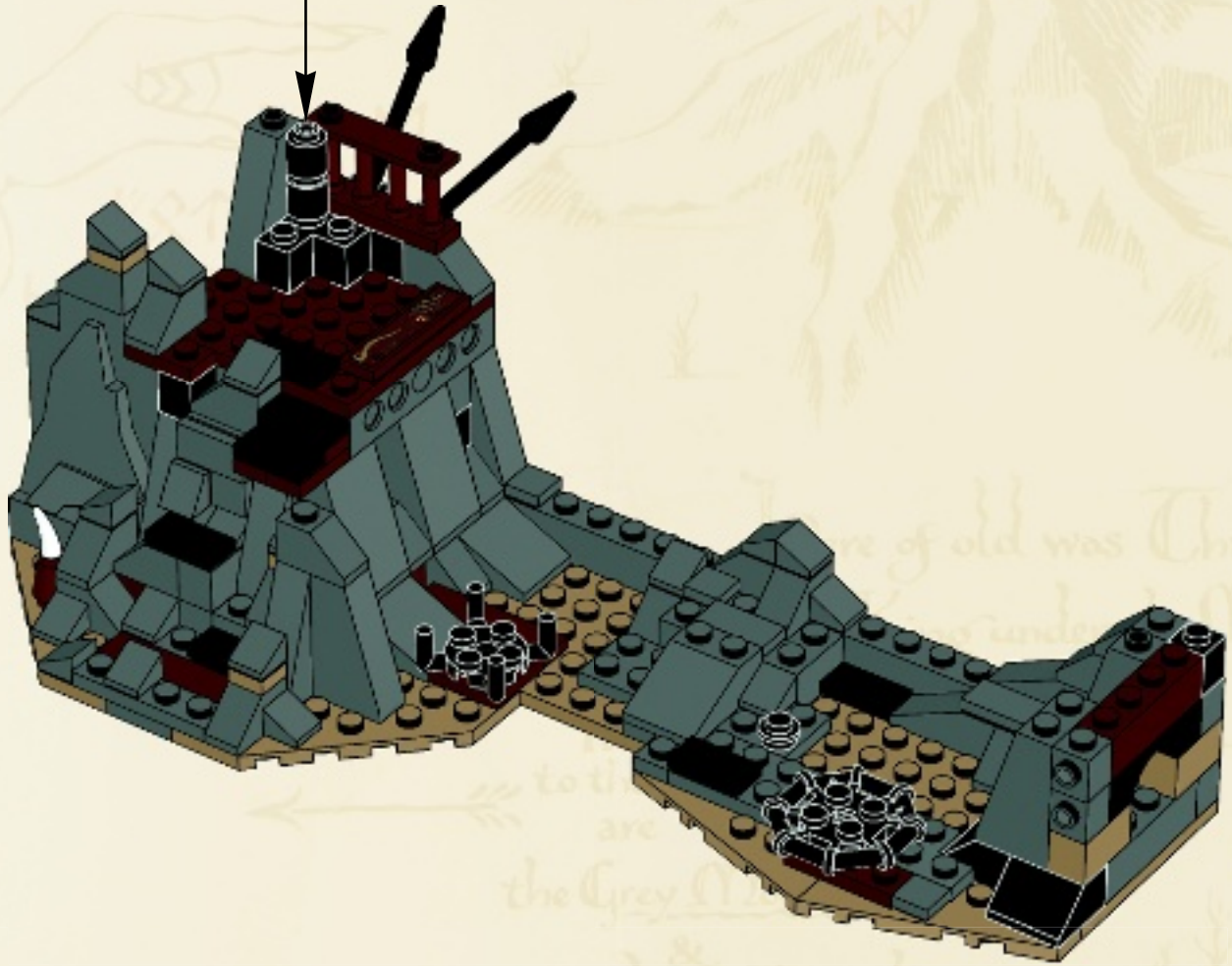
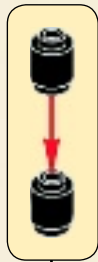

- 1x 
- 1x 
- 1x 
- 1x 

48

1 

2 

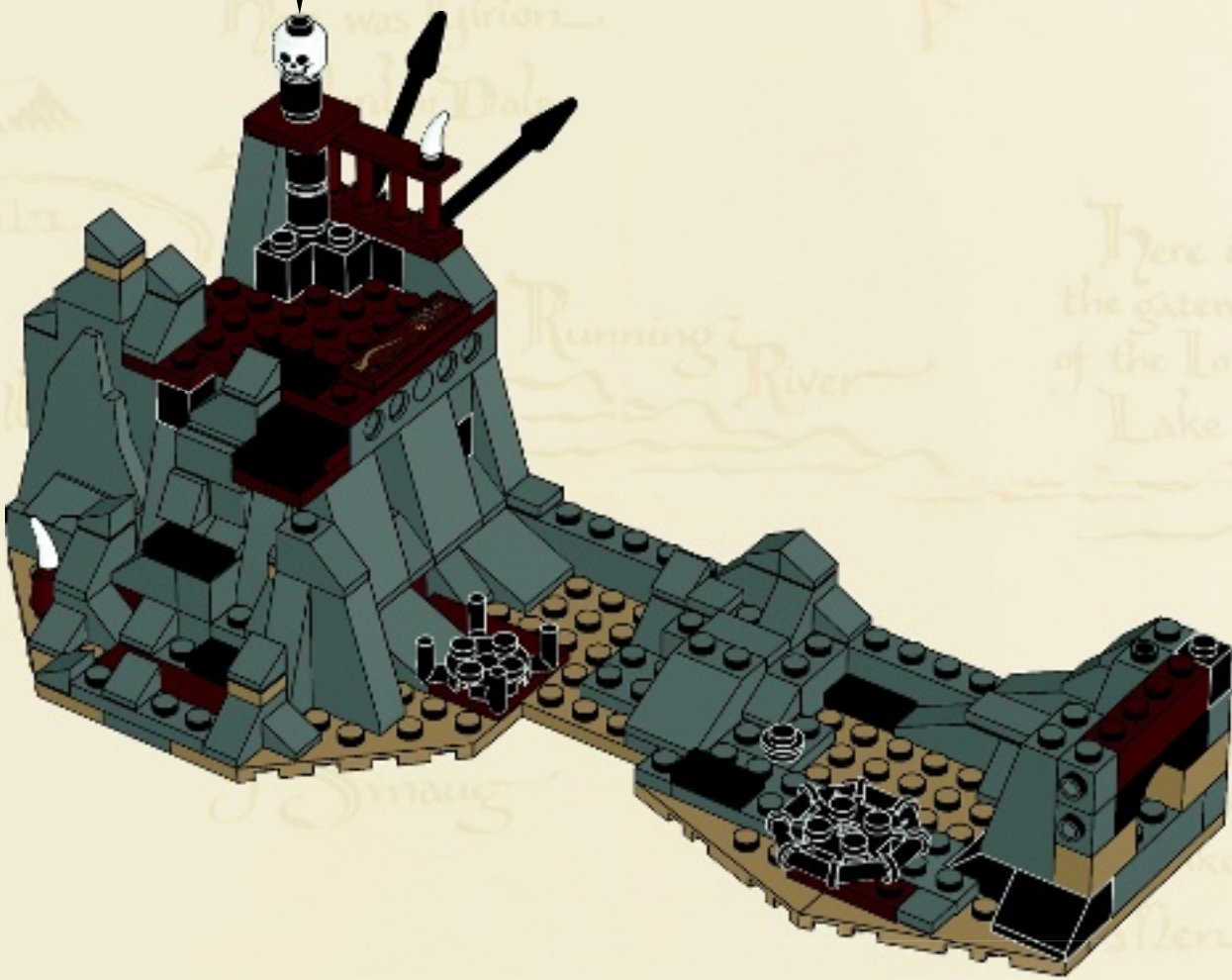

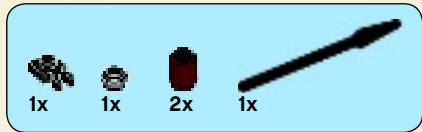

49

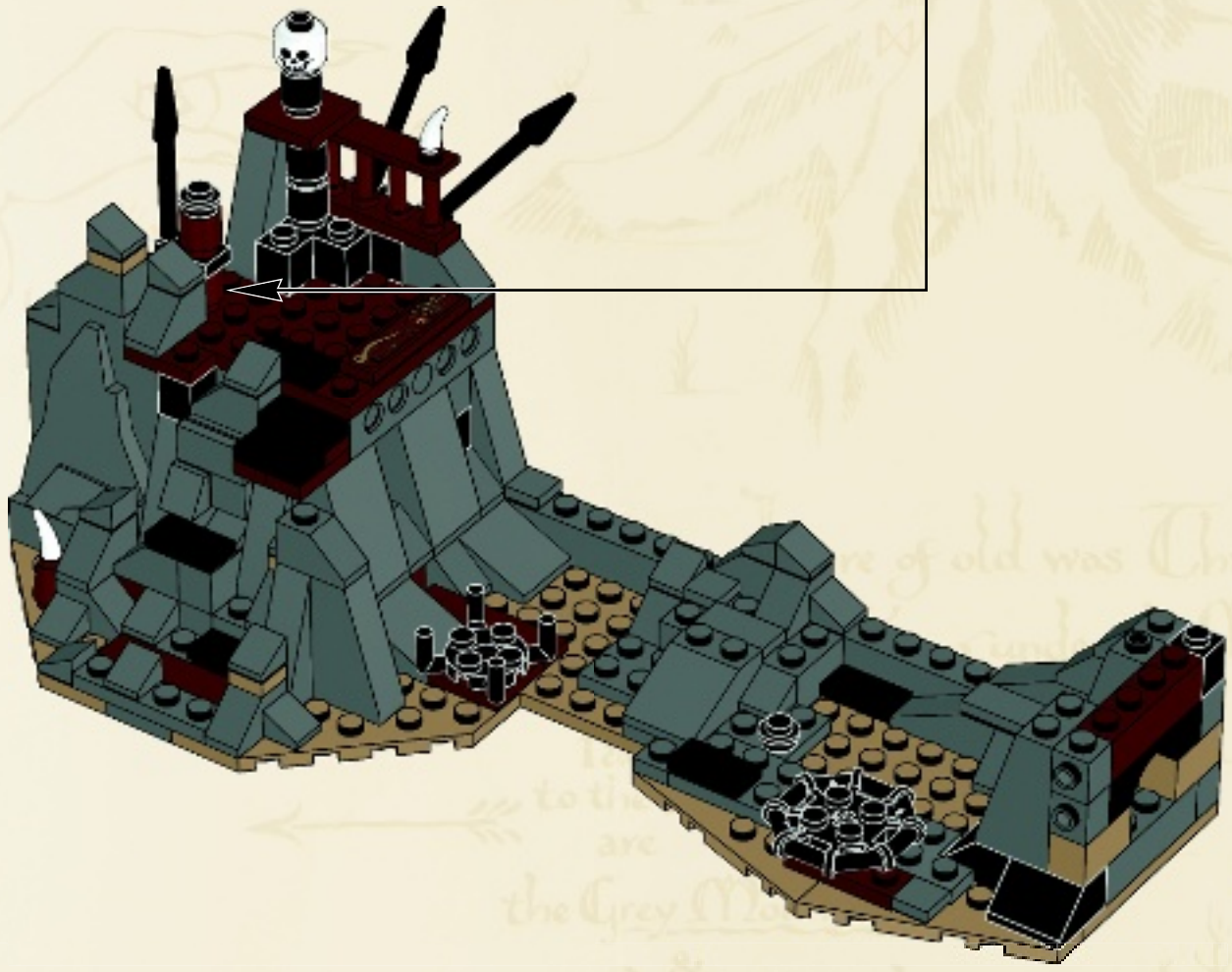
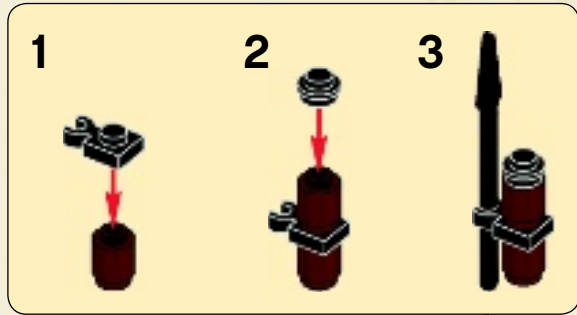

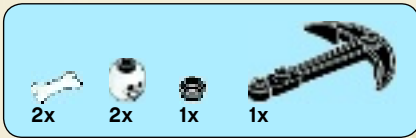

50

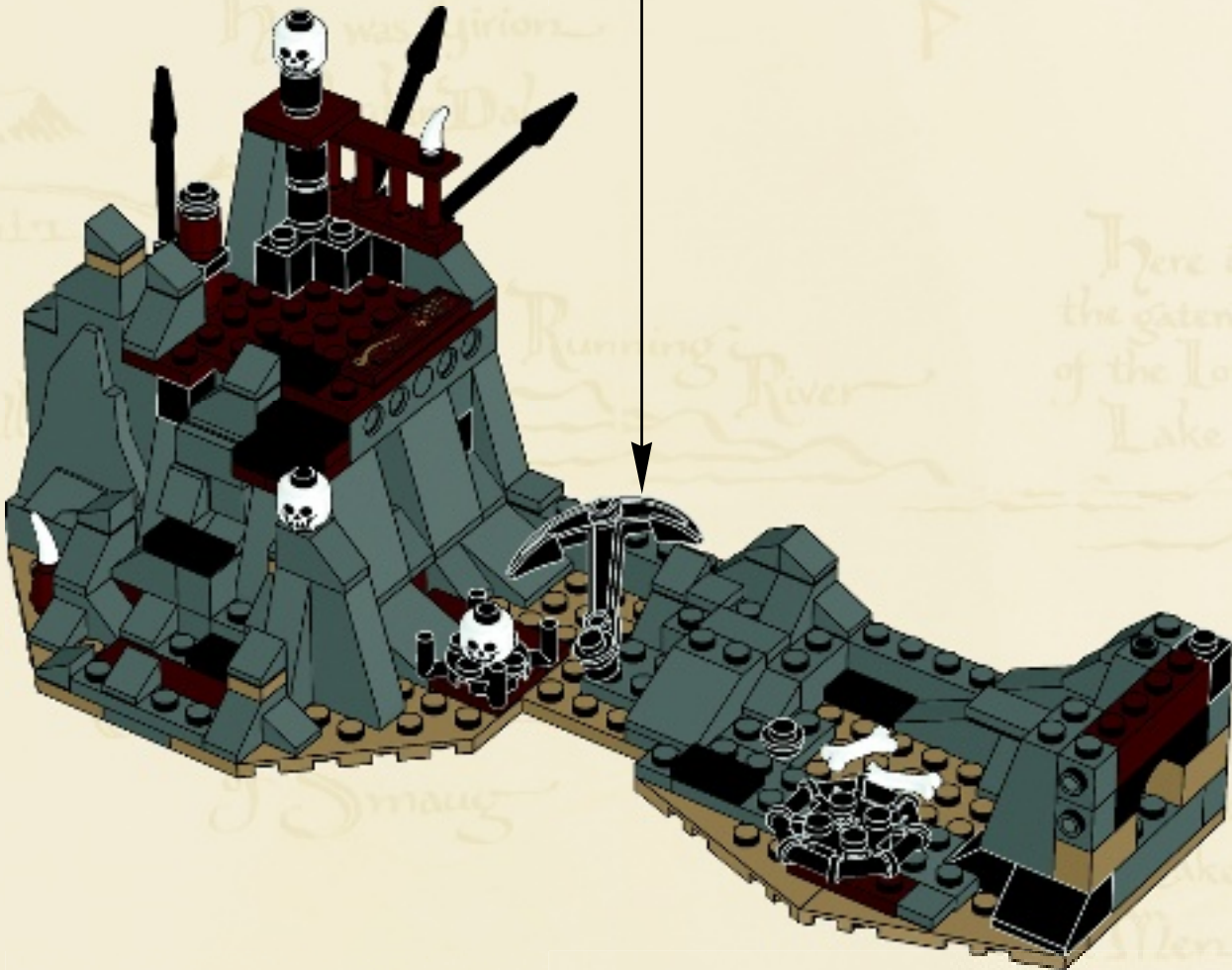
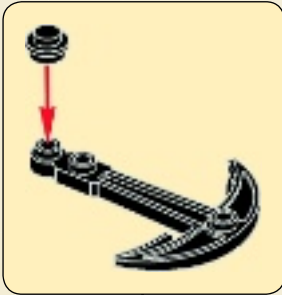

4x  1x 

51

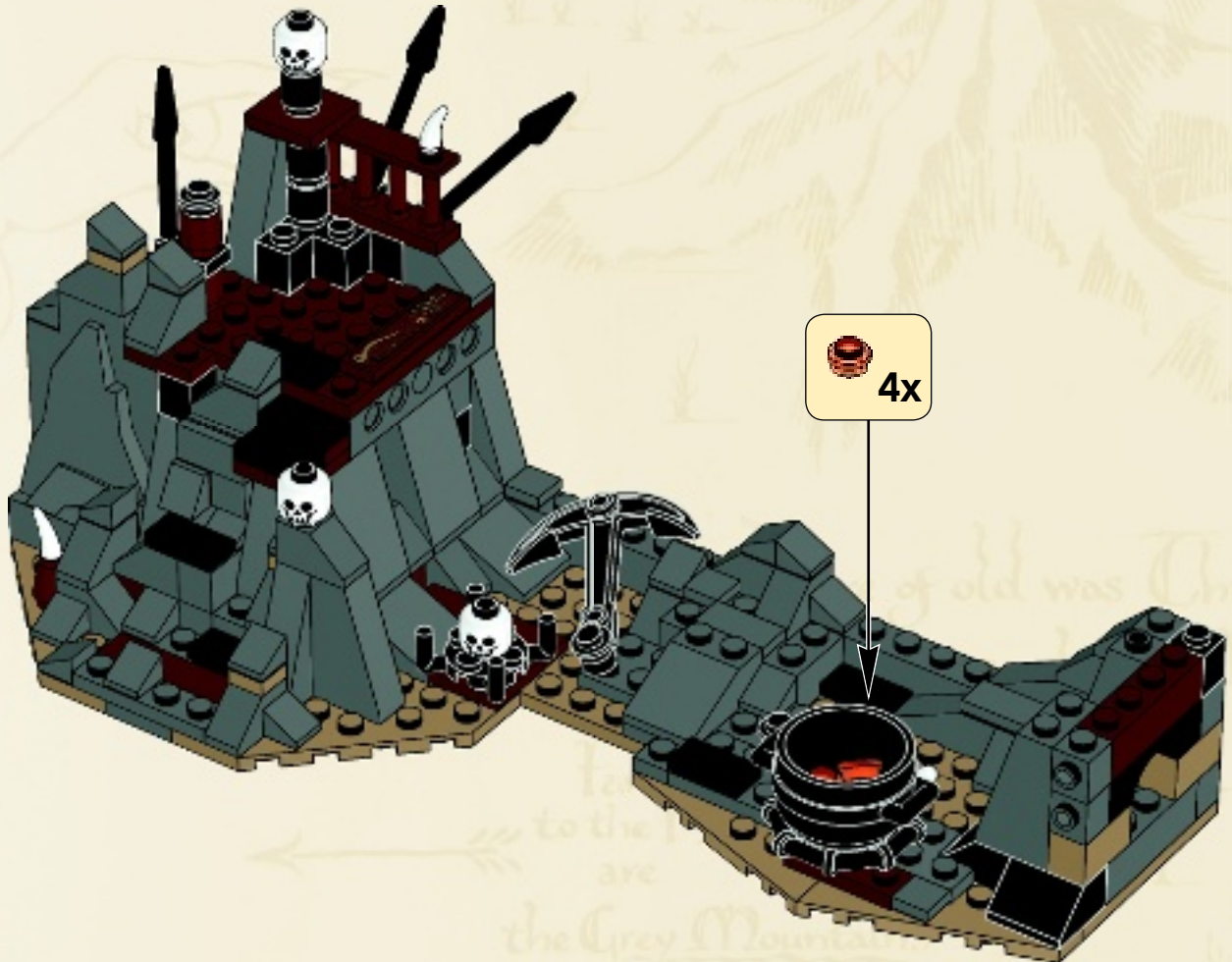

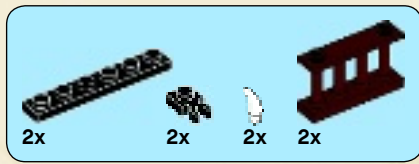

52

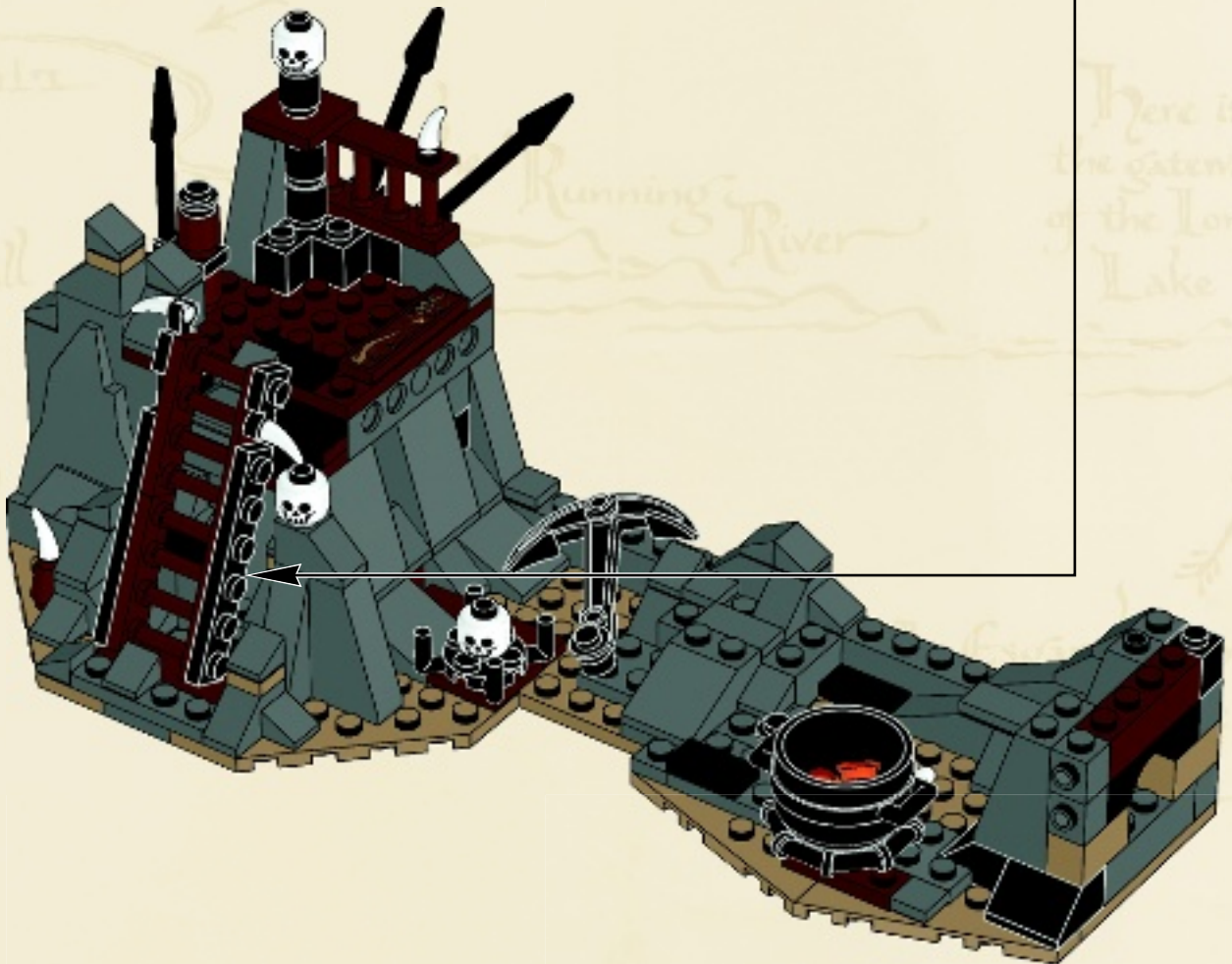
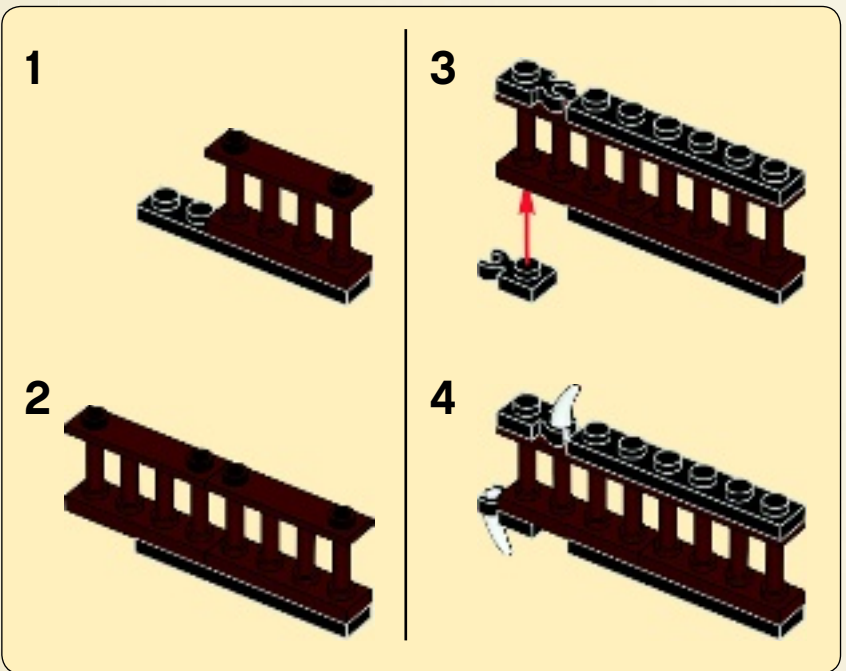

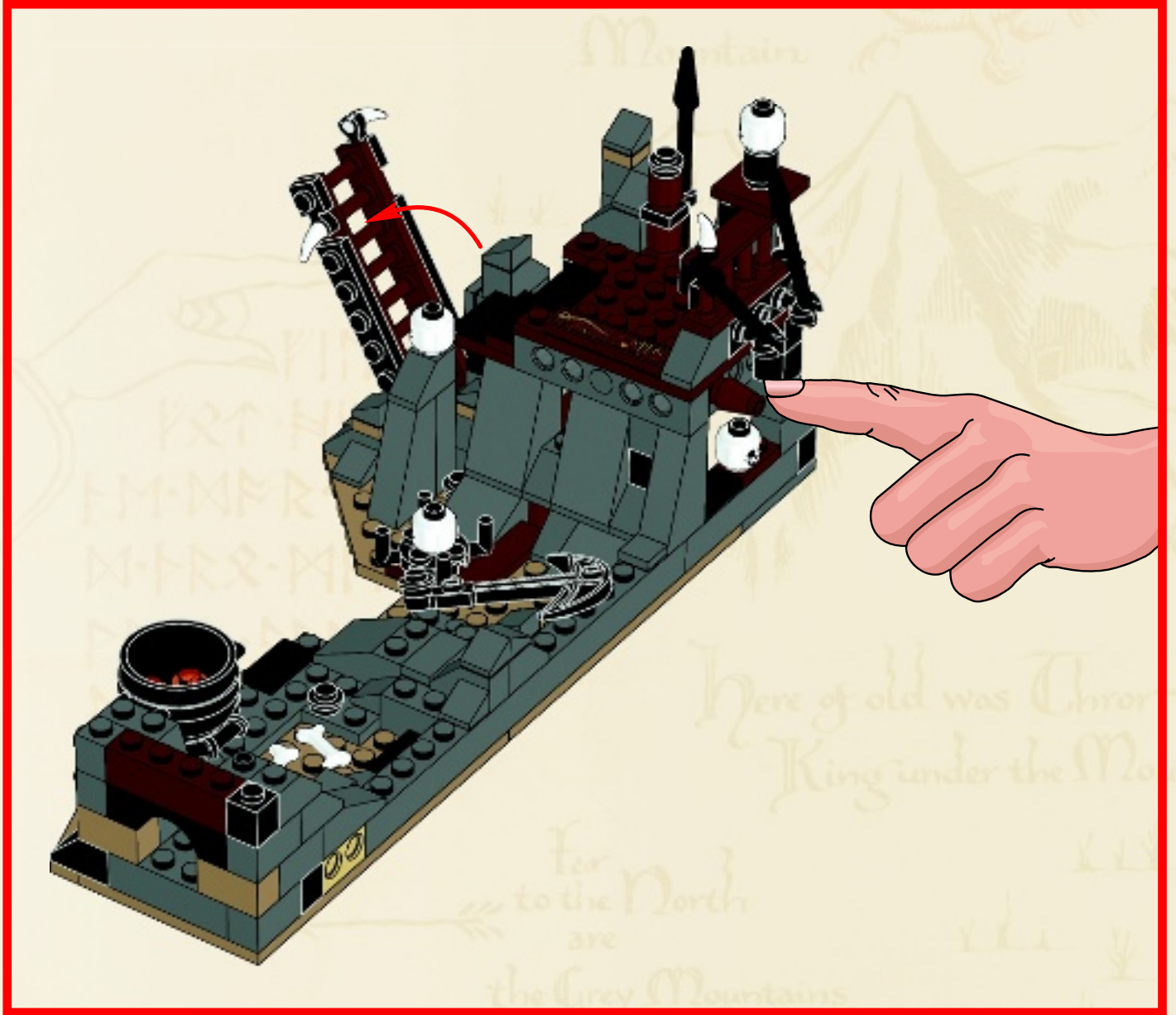

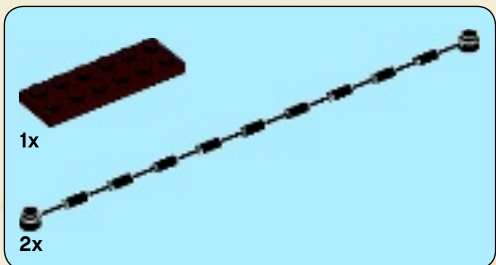
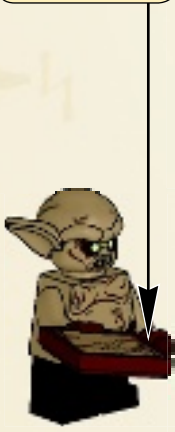
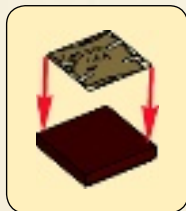
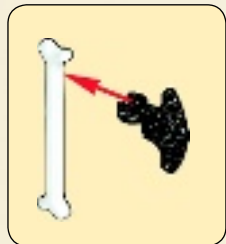
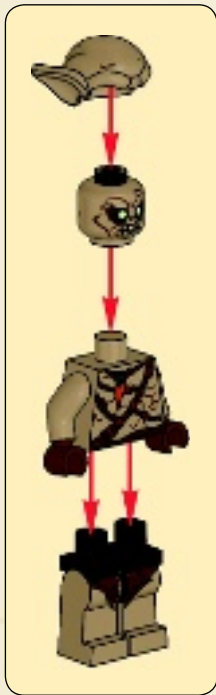
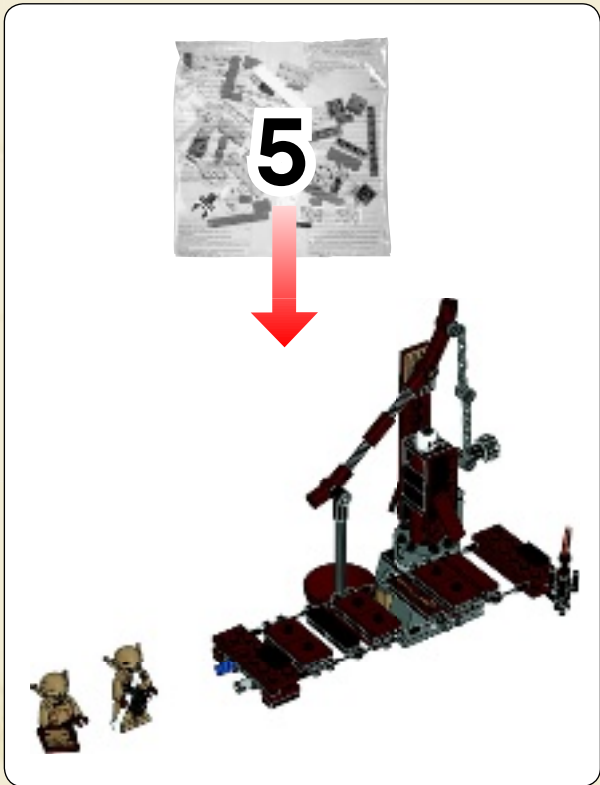

1

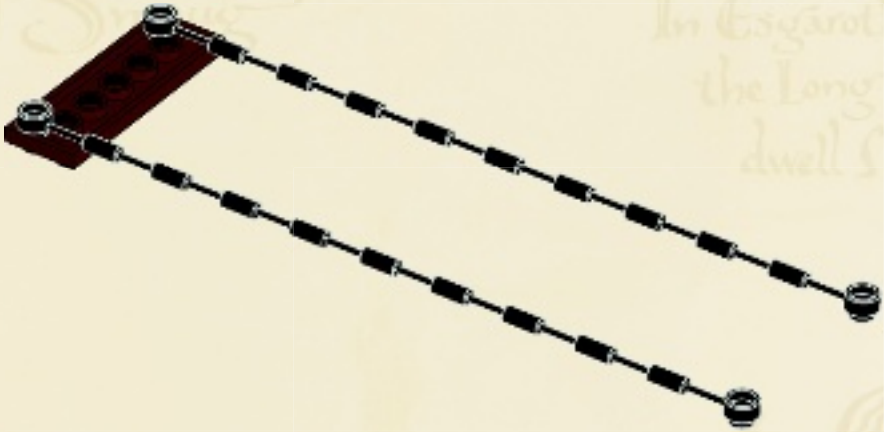



2x

2



1x



2x

3

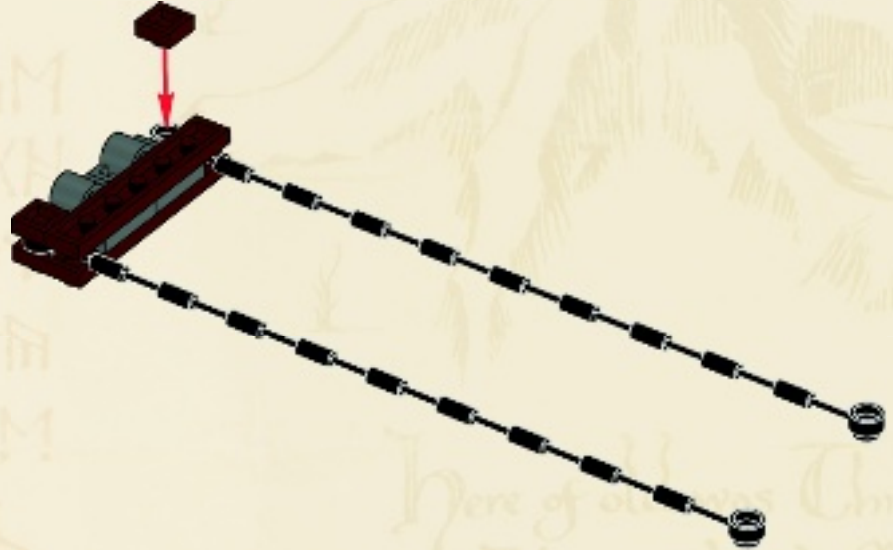

2x



1x



1x

4



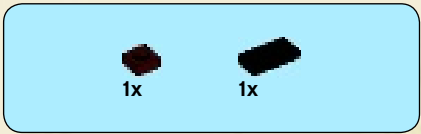

5

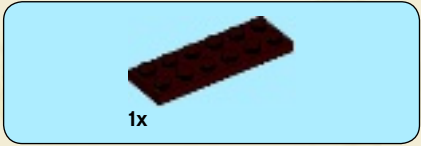

6

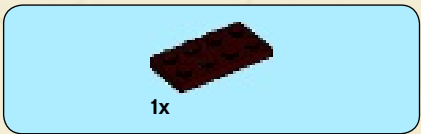

7



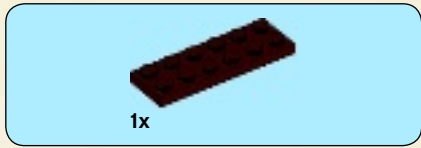

8

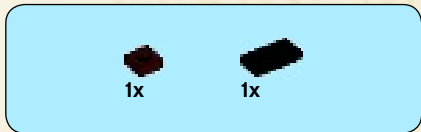

9



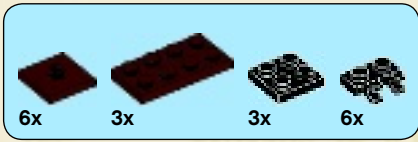

10

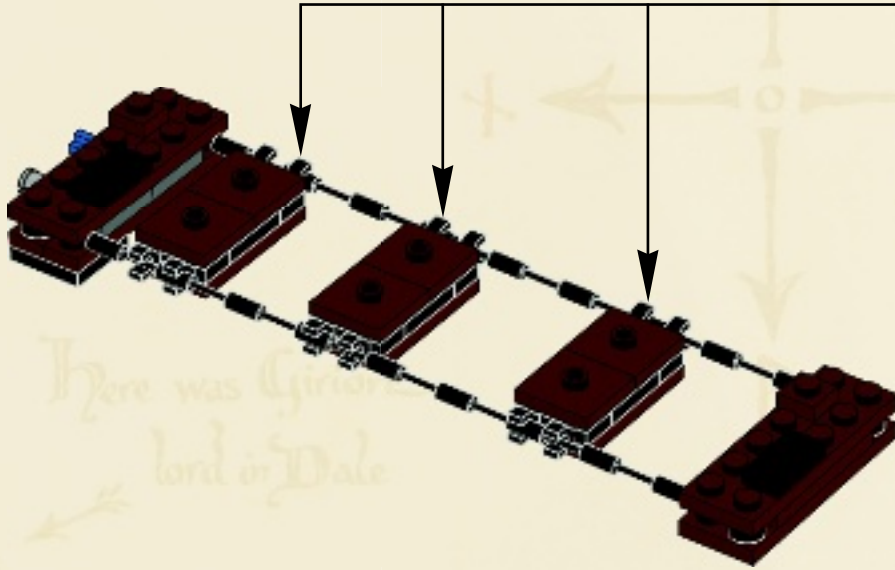
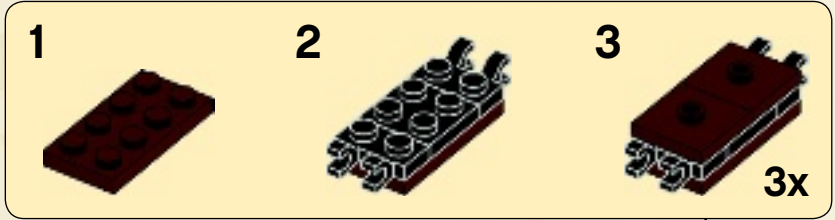

11

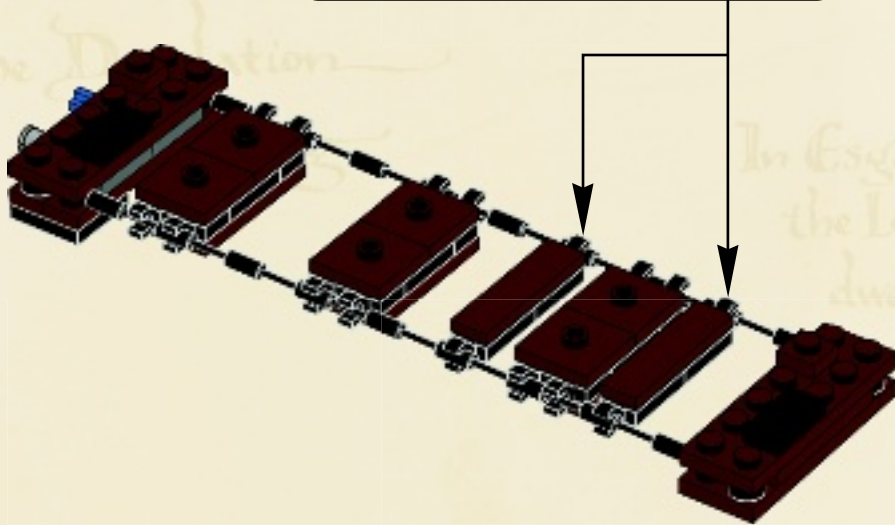
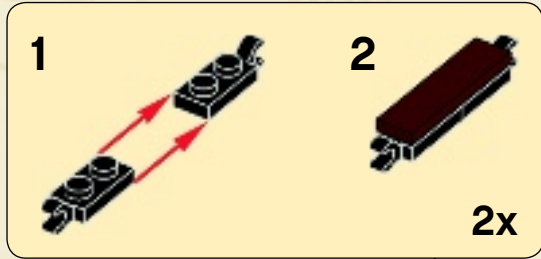

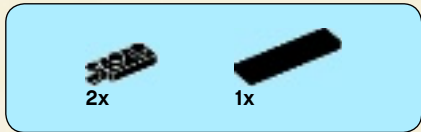

12

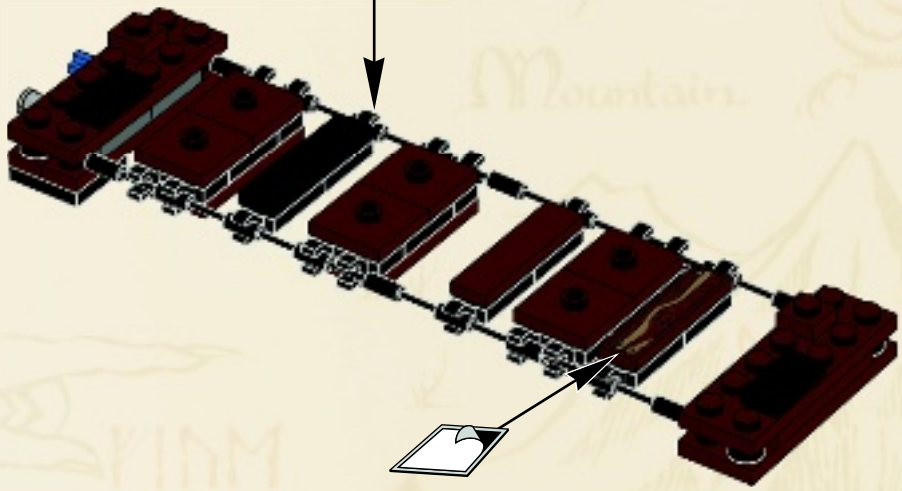
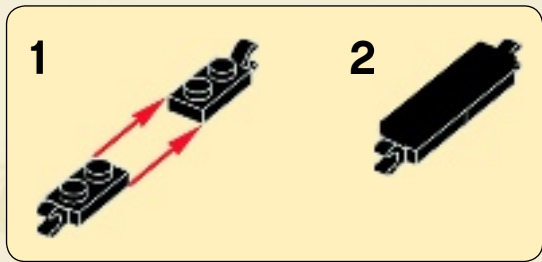

13

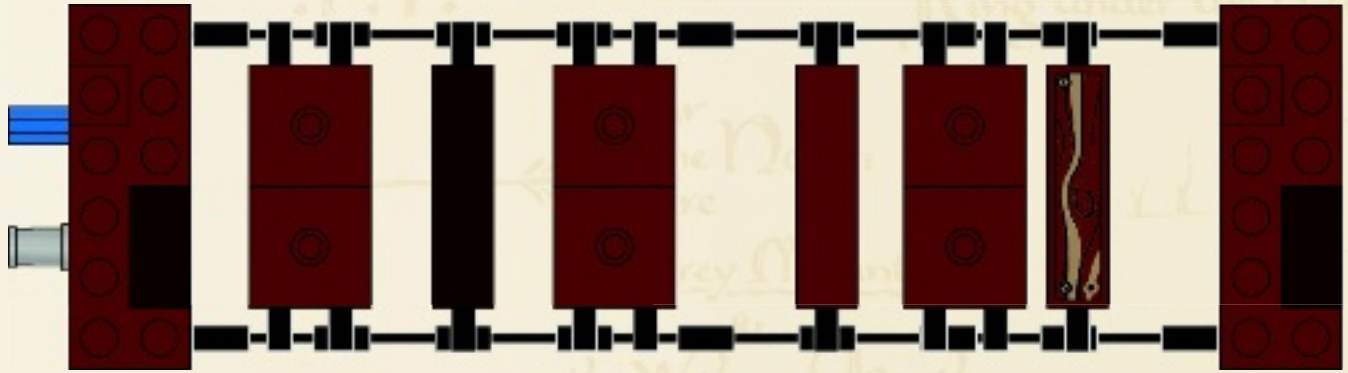

1:1

53

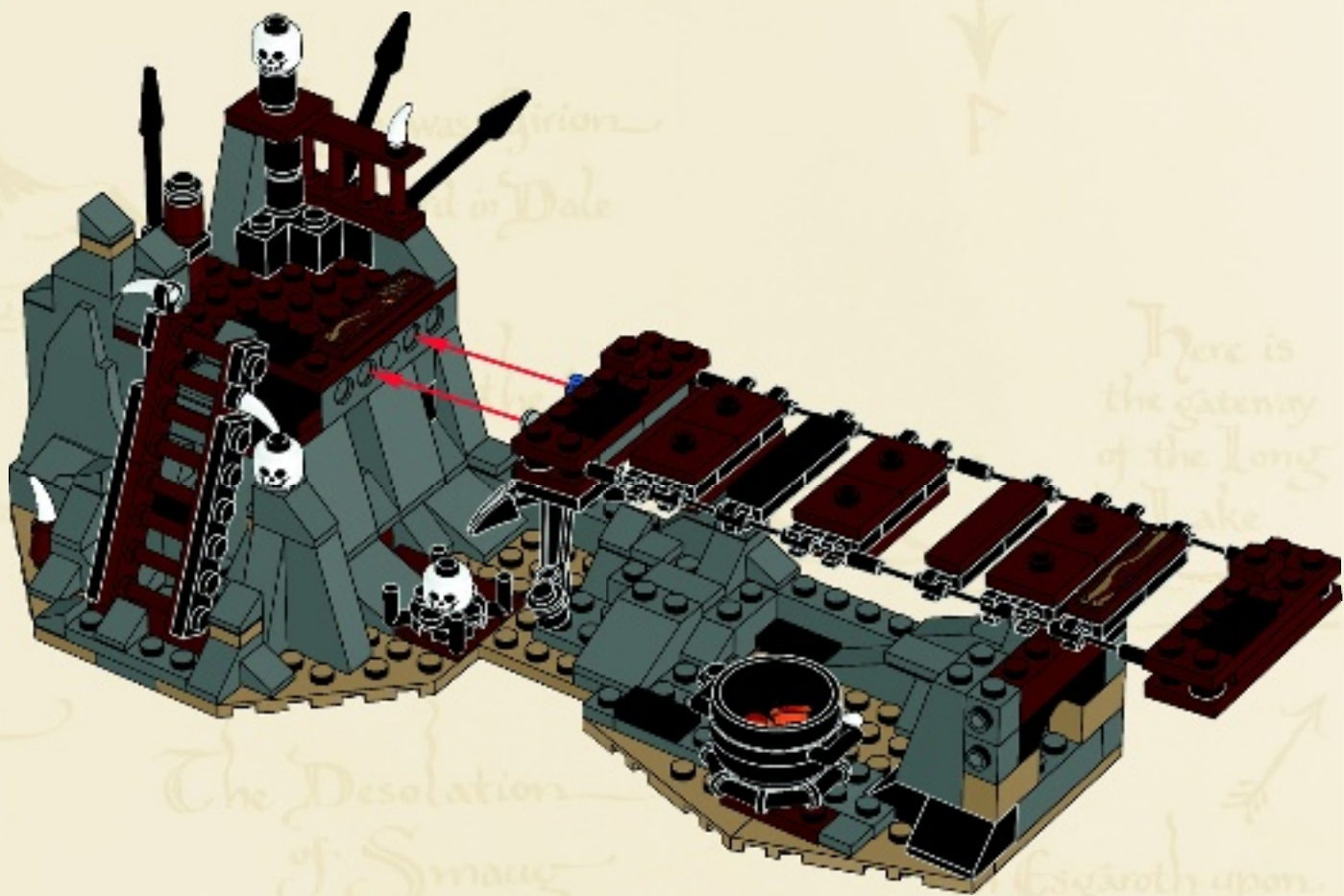

54

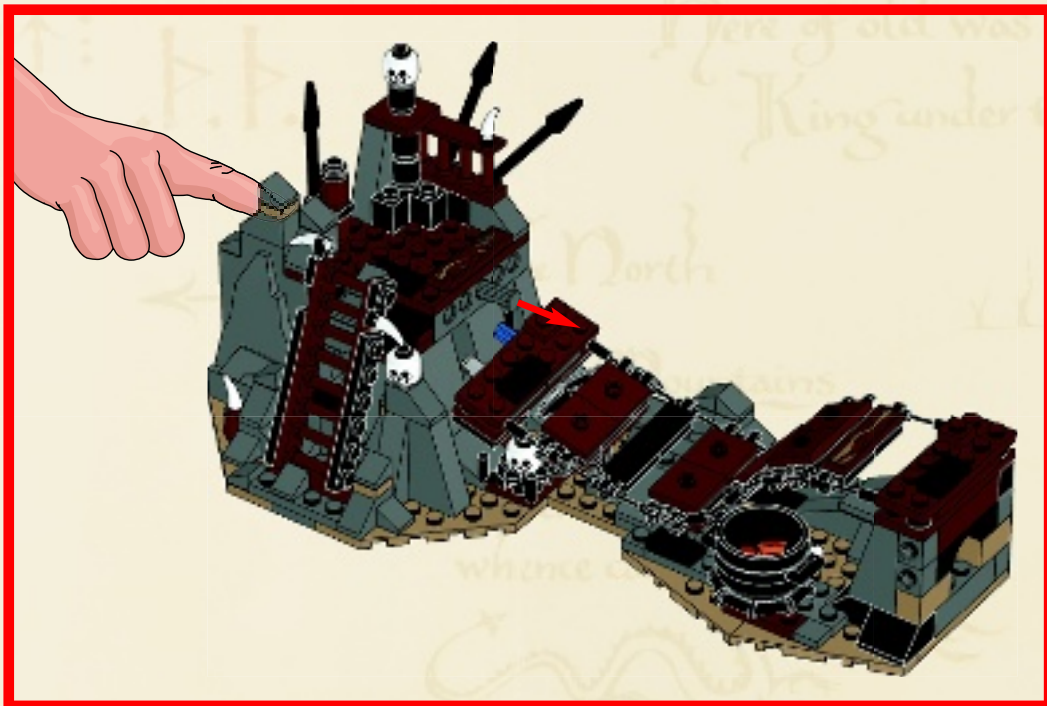
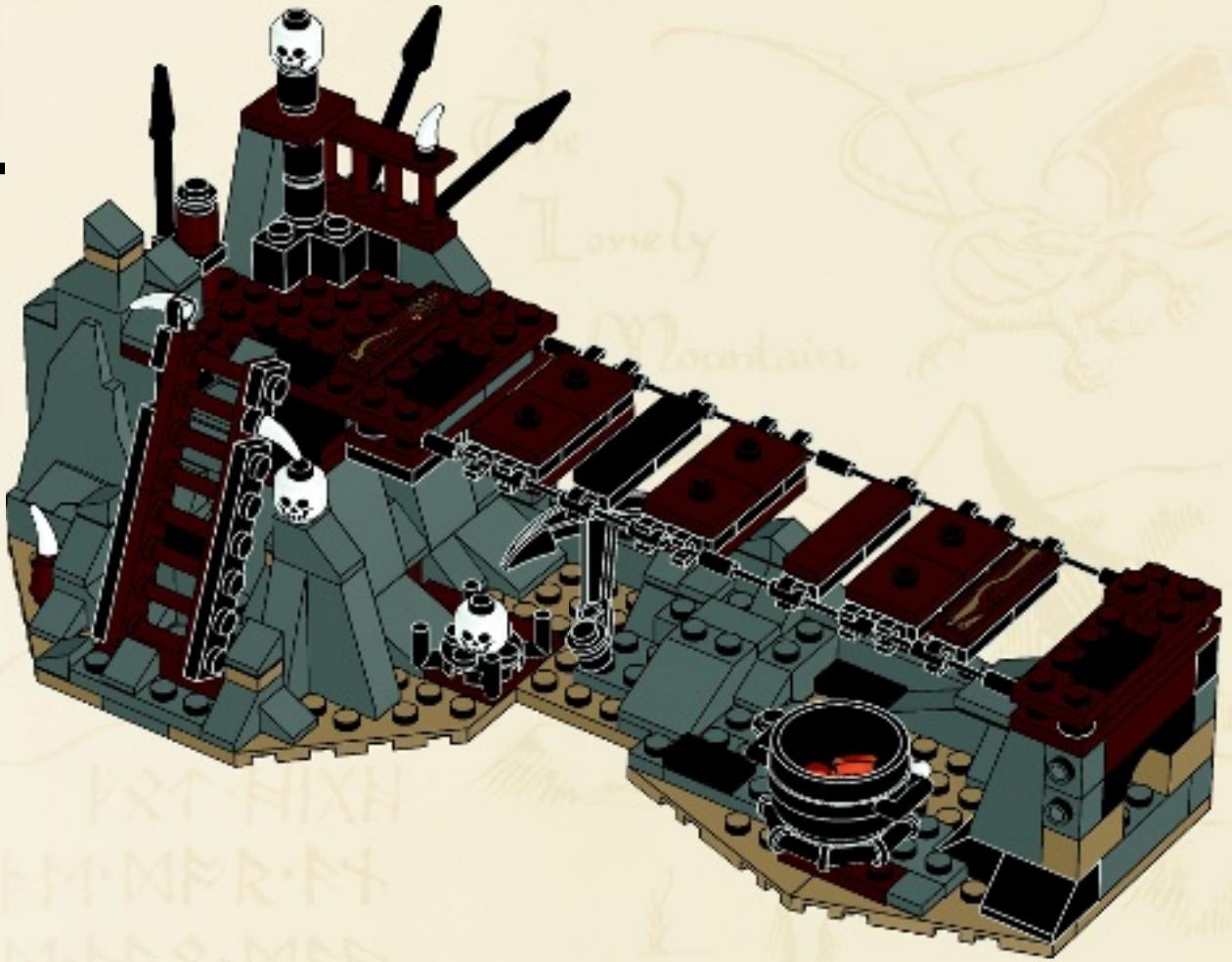

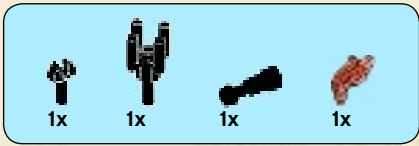

55

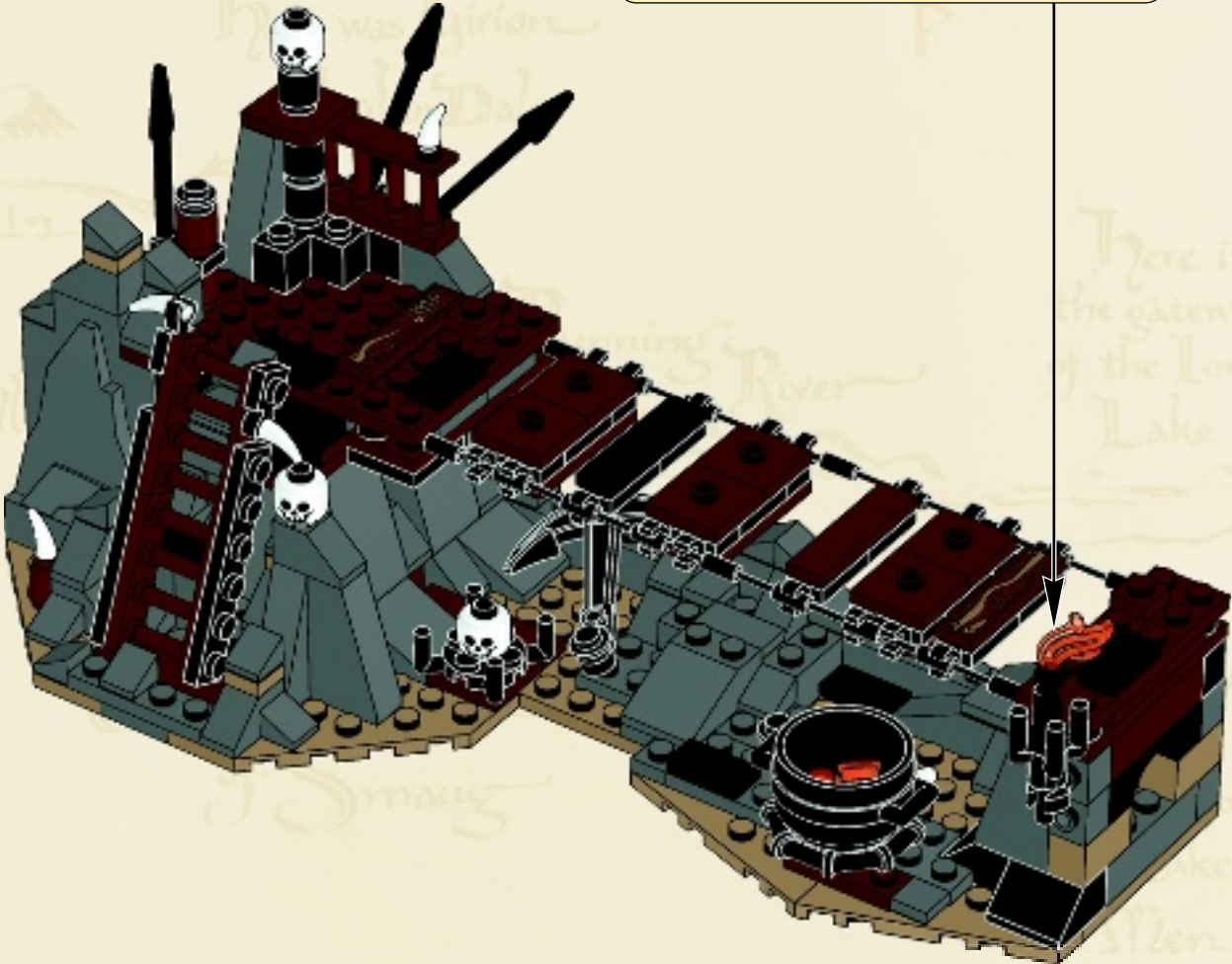
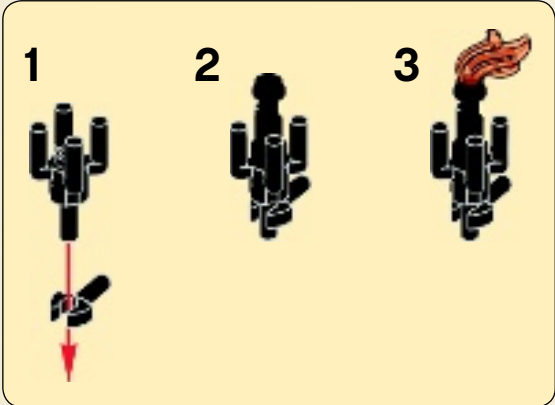

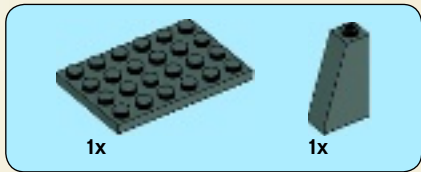
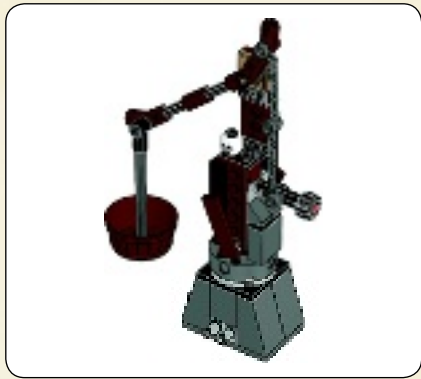

1

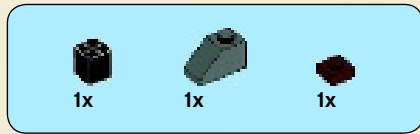

2

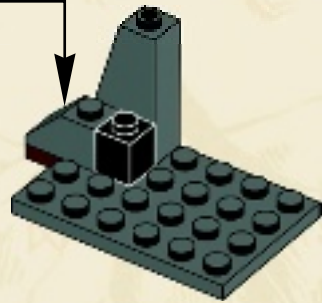
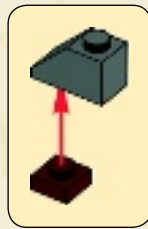

3



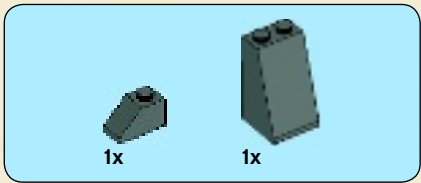

4

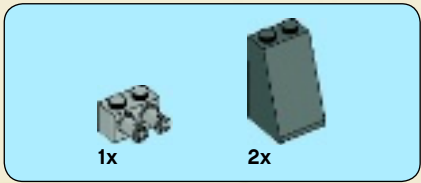
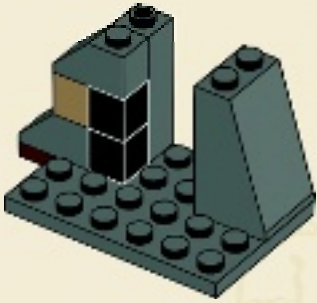

5

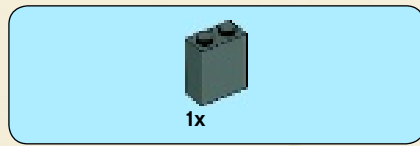
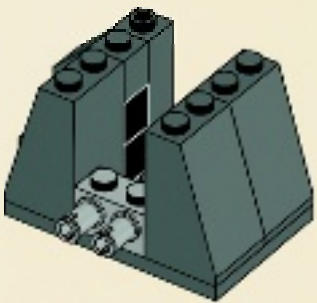

6

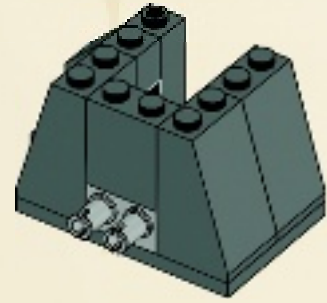

7



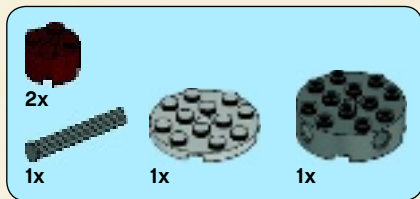

8

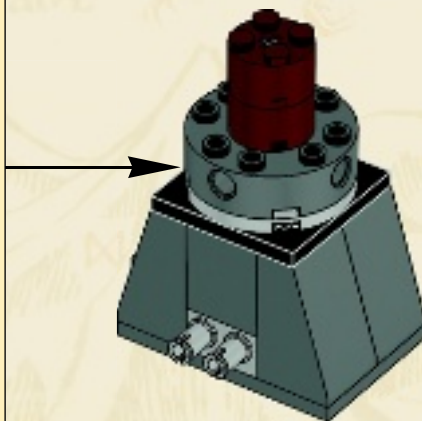
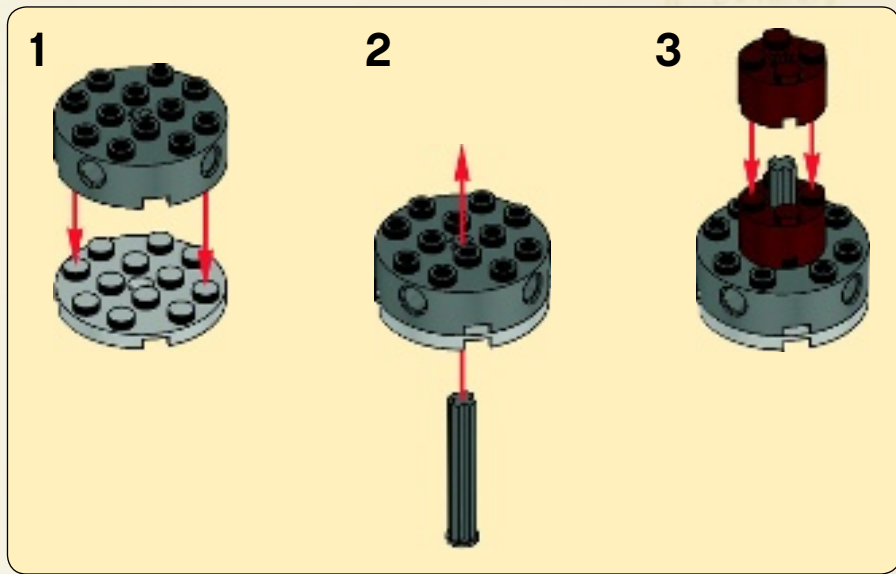

9



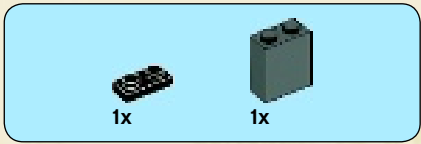

10

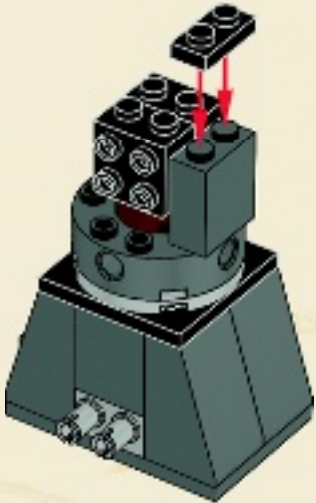

12

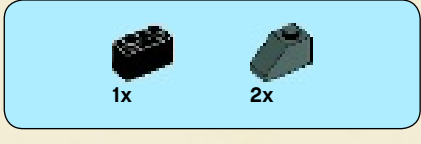

11



13

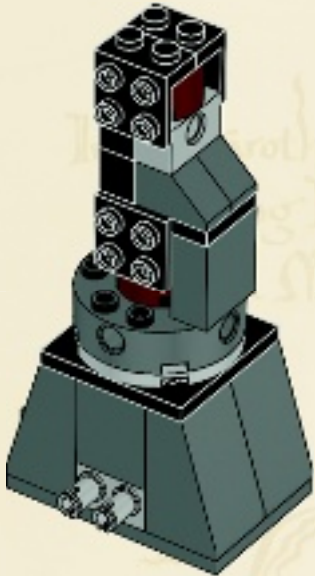

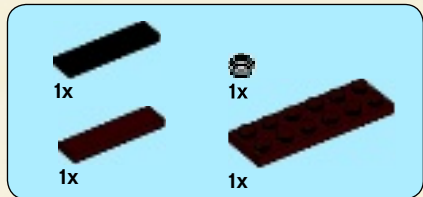

14

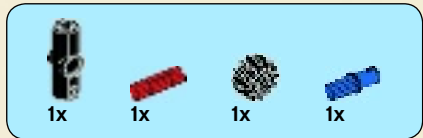
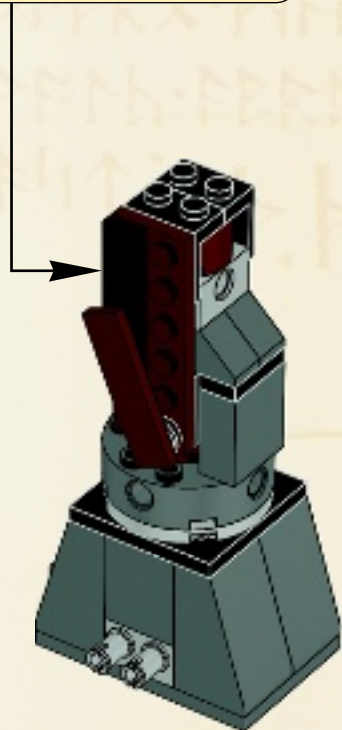
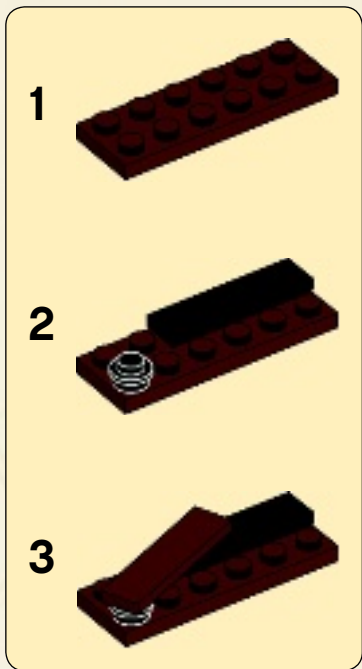

15

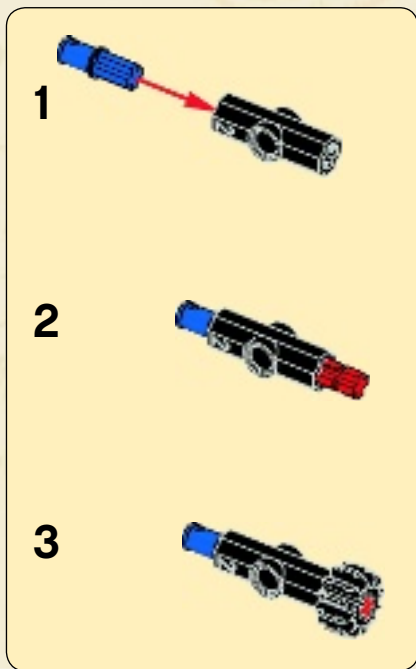

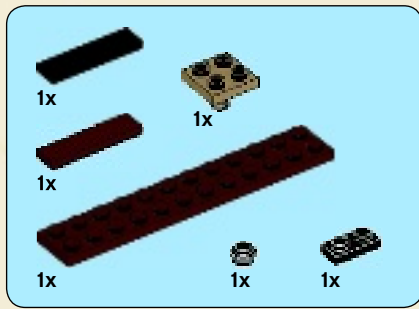

16

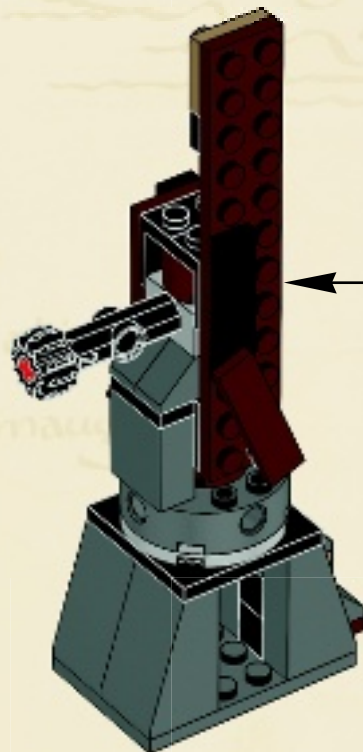
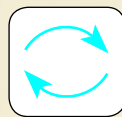
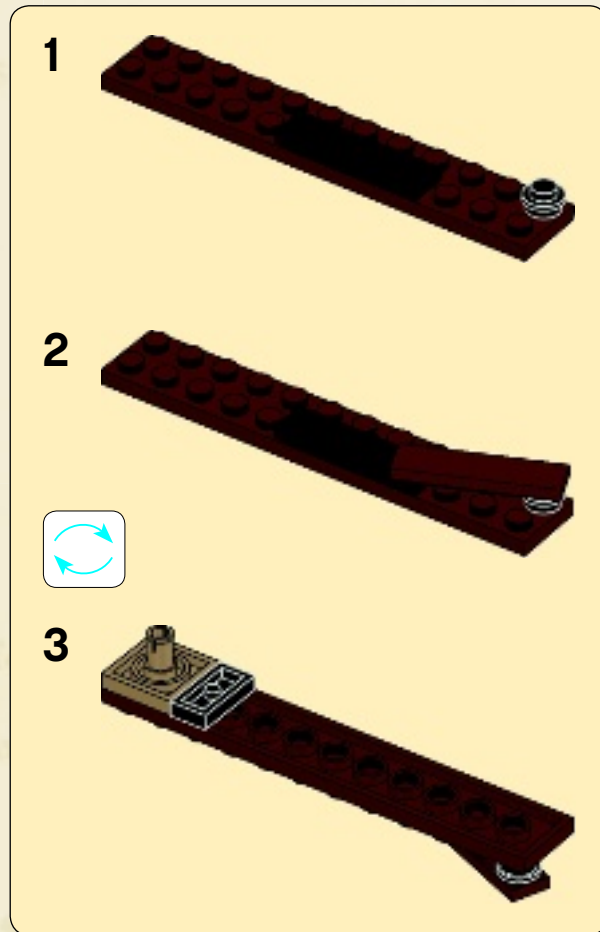

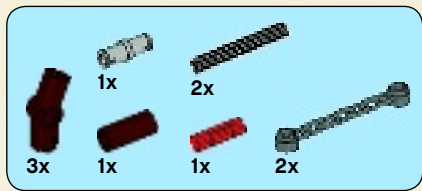

17

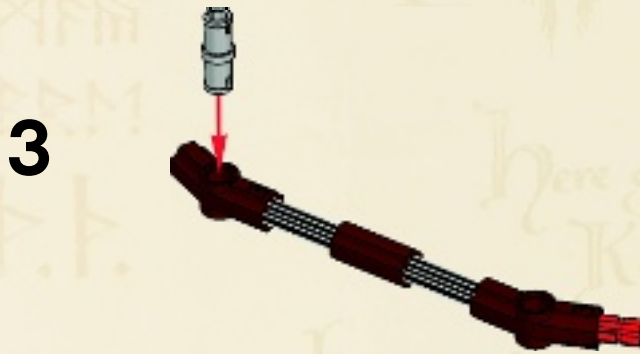

5

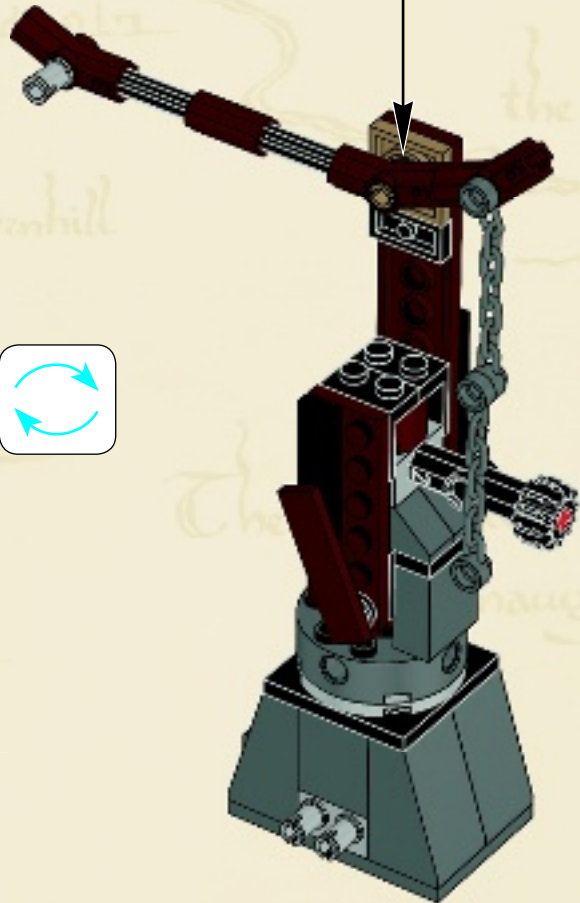
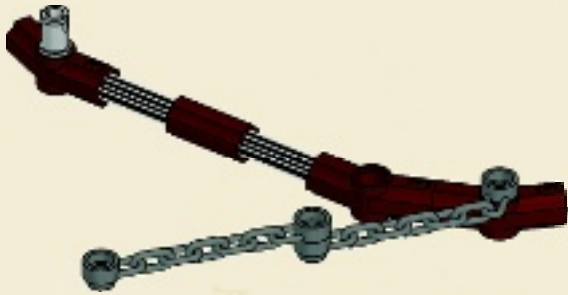

18

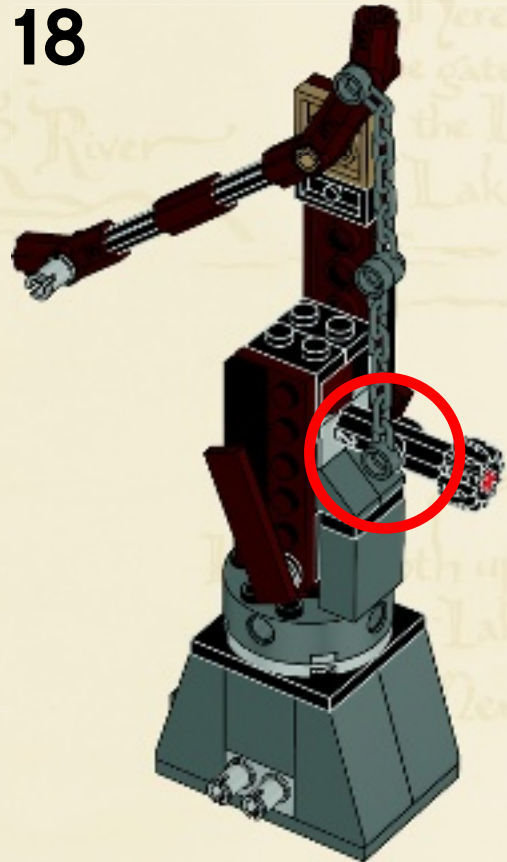

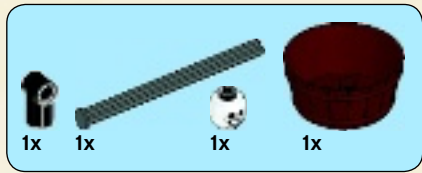

19

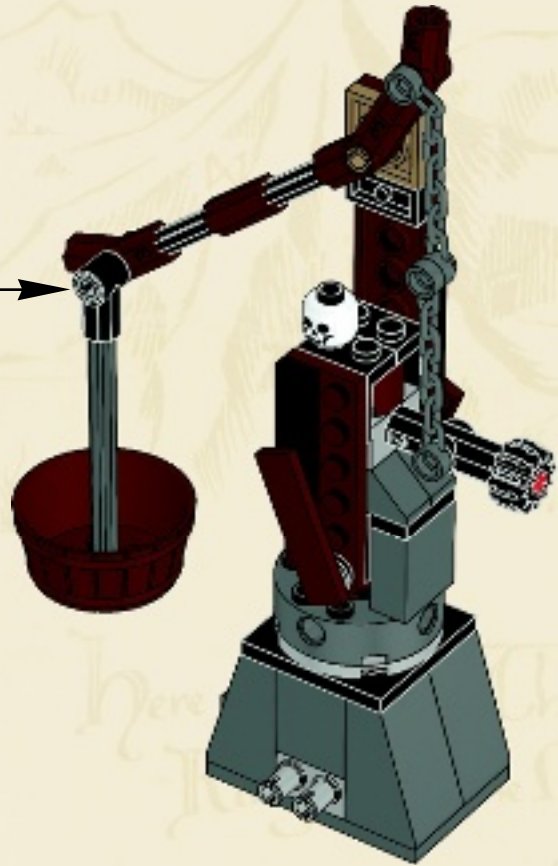
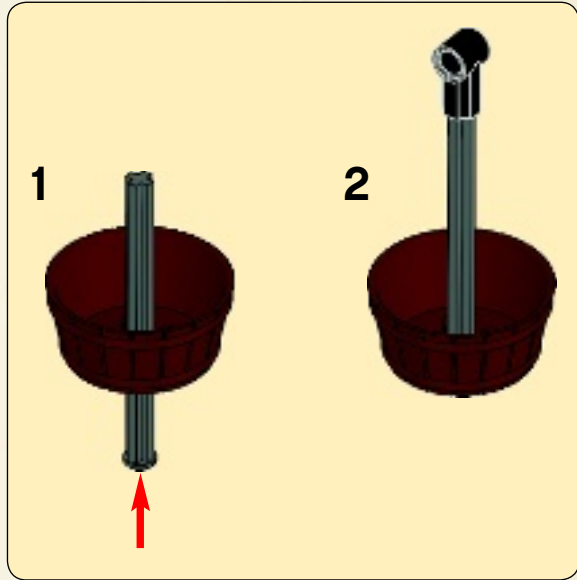

56

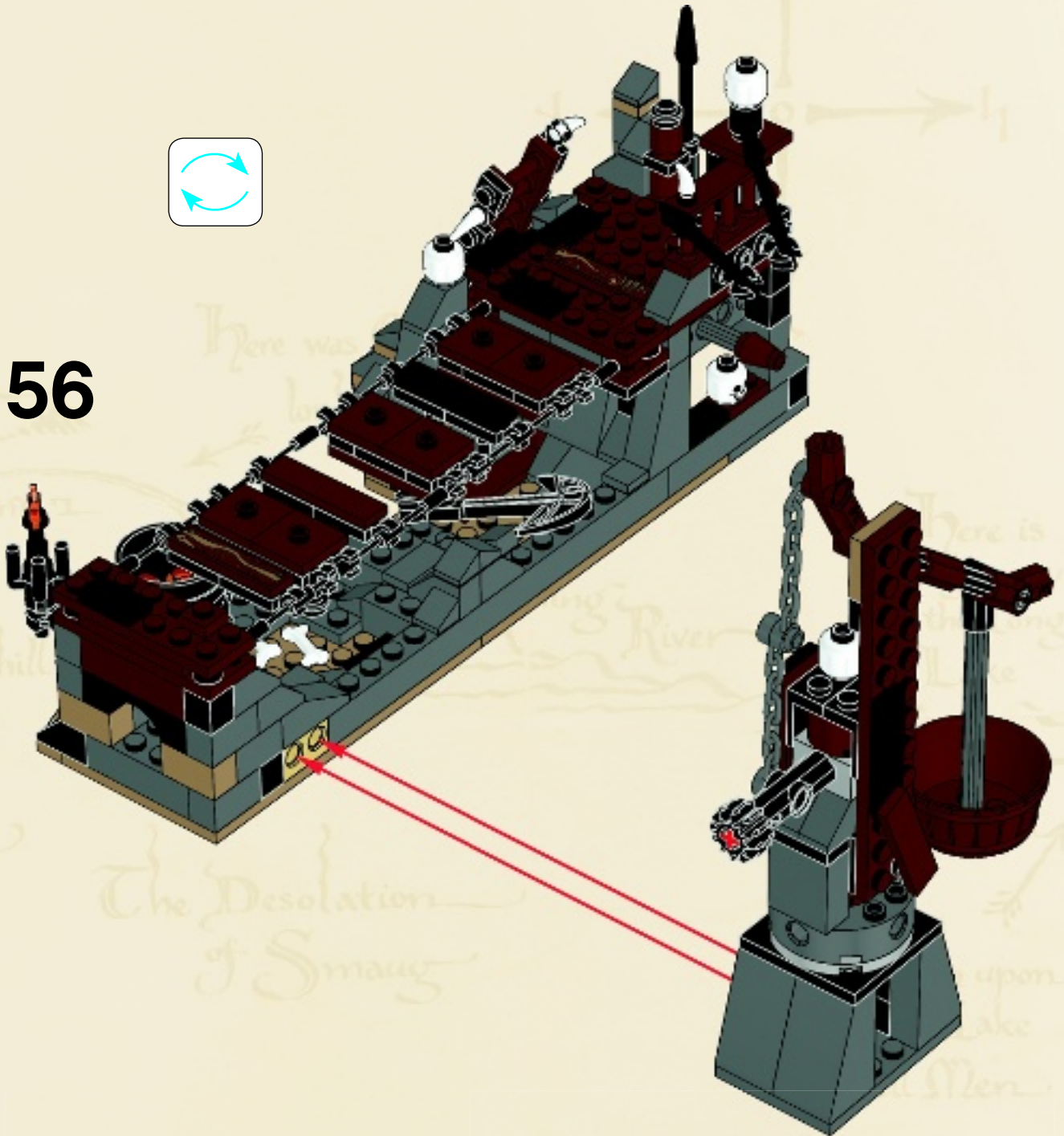
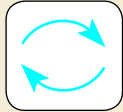

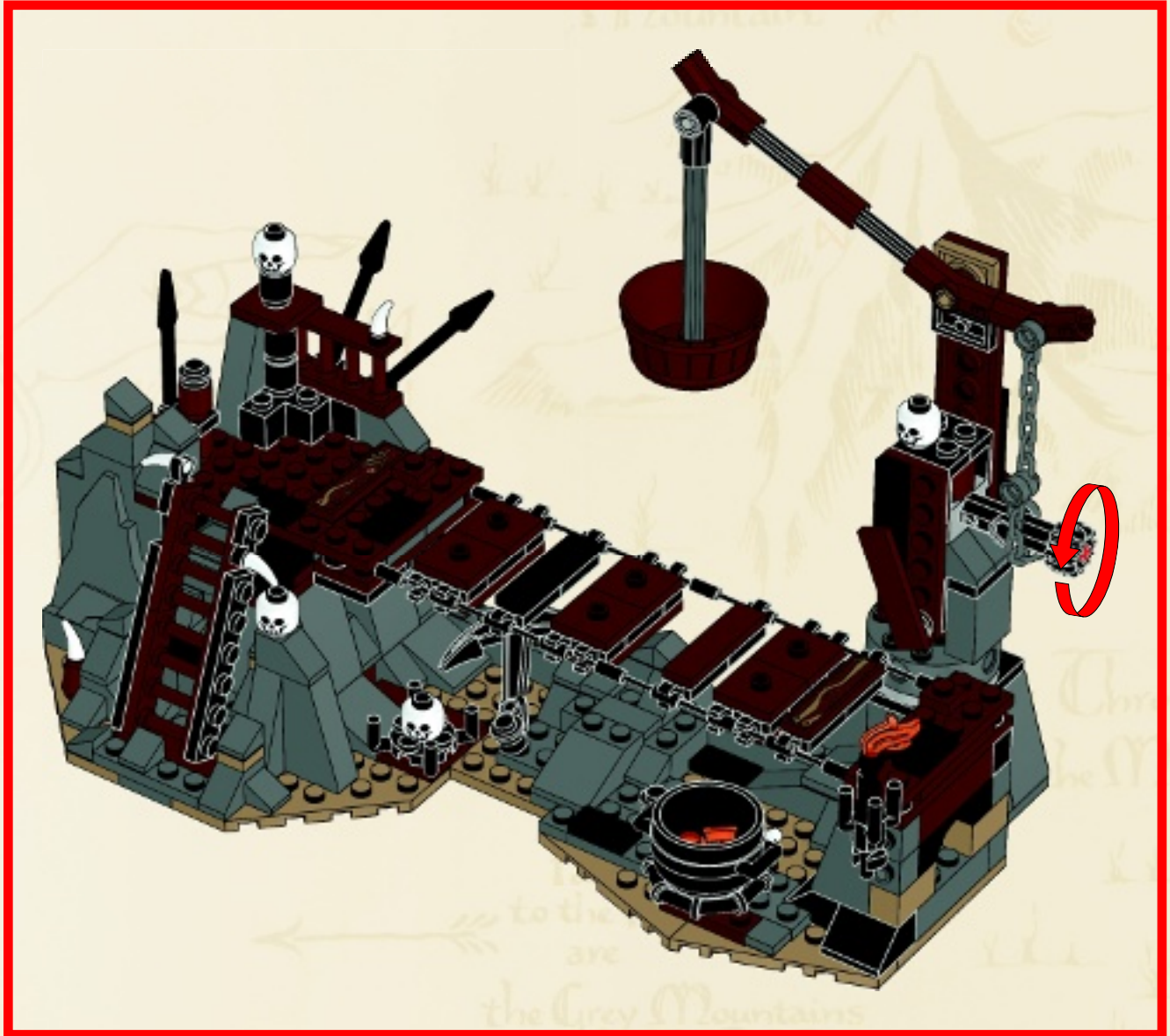

East lie the Iron Hills
where is Dain

M

Here was Ciri

Here is
a way

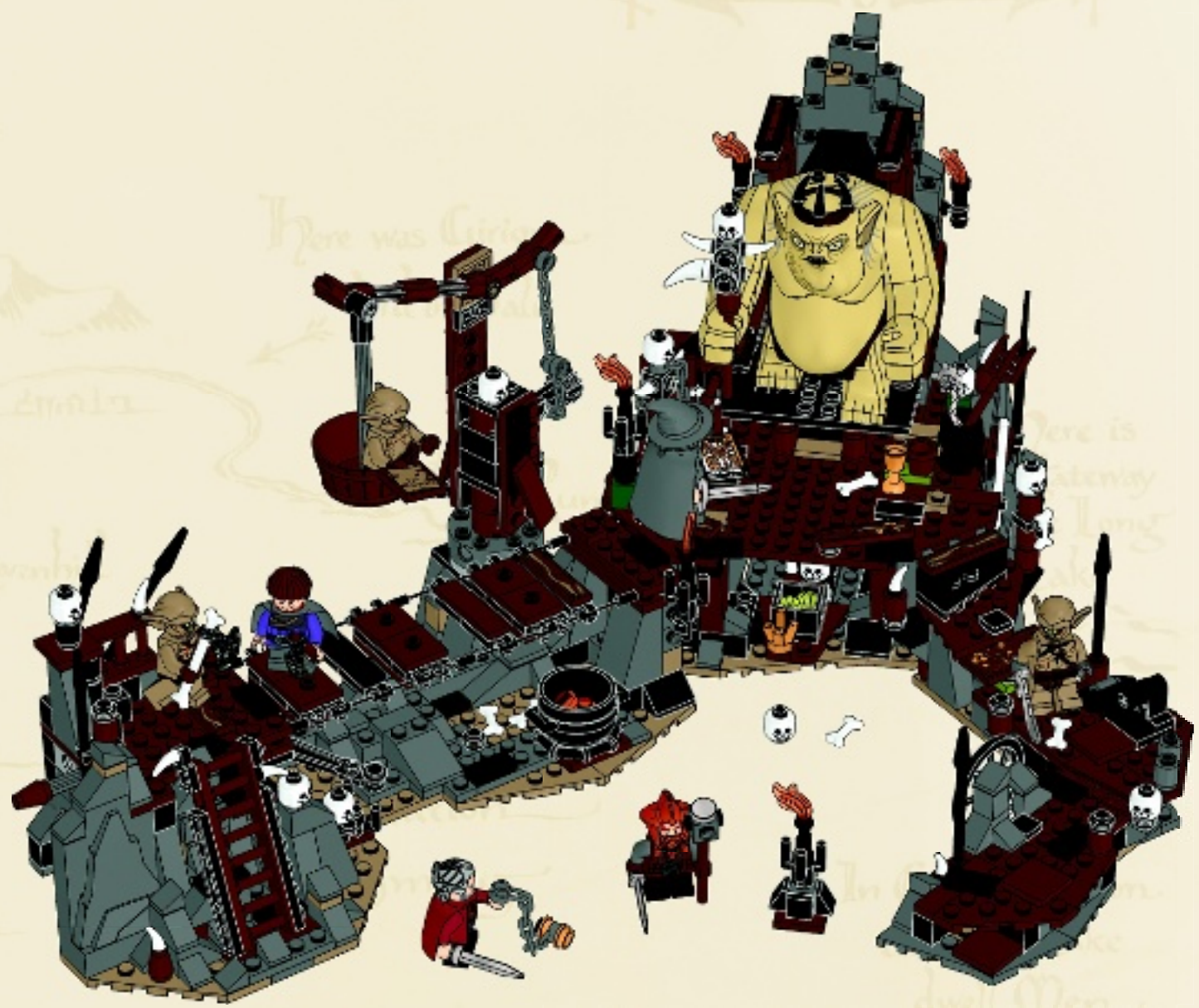



13x 4651445
 1x 6038450
 4x 6037870
 6x 4600294
 2x 4600307
 14x 4568387
 1x 4566256
 1x 4523145
 1x 4129501
 1x 6025316
 1x 6025314
 1x 6025323
 1x 6025321
 1x 6025325
 2x 4523159
 1x 4505990
 1x 4516816
62

3x 473326
 11x 300526
 15x 300426
 3x 300326
 6x 235726
 4x 300226
 1x 300126
 1x 4181144
 1x 4617860
 1x 611226
 1x 4162443
 2x 242026
 1x 302126
 2x 371026
 2x 366626
 1x 4517986
 1x 303626
 2x 4533412

4x 4550017
 4x 4277932
 6x 4556158
 1x 4140588
 6x 4535739
 1x 4650145
 1x 6018805
 4x 307026
 3x 306926
 2x 663626
 26x 614126
 4x 4106347
 2x 486526
 3x 306226
 2x 4504382
 6x 4121966
 3x 303926
 3x 329826
 1x 4160869

1x 4626884
 6x 302426
 1x 379426
 6x 302326
 3x 302226
 3x 4568385
 1x 4121667
 1x 4107783
 1x 4107085
 1x 4107081
 1x 4526982
 2x 370526
 1x 4177431
 1x 4144024
 8x 4289538
 3x 4532220
 1x 368026
 1x 4525078
 1x 4636280
 1x 4620400

1x 6024401
 1x 6024413
 1x 6024423
 2x 6024433
 7x 6001824
 2x 4521914
 11x 4549436
 2x 4528604
 4x 4496699
 1x 4541618
 1x 6002851
 2x 6002849
 4x 6030845
 1x 6006524
 3x 6001001
 2x 4266897

3x 6022985
 3x 6024072
 5x 6016483
 1x 6021615
 4x 3005747
 5x 4540865
 2x 4114505
 2x 4142865
 4x 4206482
 3x 4521915
 1x 6024394
 1x 6020754
 1x 6003235
 1x 6024236
 1x 6024010

1x 4655241
 2x 6000291
 1x 4611880
 1x 4611882
 1x 4653172
 2x 4273965
 1x 6027735
 1x 6022268
 14x 4221744
 4x 4211150
 5x 4211225
 22x 4211183
 8x 4529242
 3x 4211166
 2x 4264755
 2x 4211197
 2x 6012805



Customer Service
Kundenservice
Service Consommateurs
Servicio Al Consumidor

LEGO.com/service or dial



: 00800 5346 5555
: 1-800-422-5346



□ 79010
Goblin Soldier

□ 79010
Nori the Dwarf



□ 79010
Goblin Soldier



□ 79010
Dori the Dwarf



□ 79004
Bilbo Baggins™



□ 79003
Dwalin the Dwarf



□ 79002
Hunter Orc



□ 79004
Oin the Dwarf

□ 79004
Mirkwood™ Elf Chief



□ 79003
Balin the Dwarf



□ 79010
The Goblin King



□ 79001
Kili the Dwarf



□ 79010
Gandalf™ the Grey



□ 79003
Bilbo Baggins™



□ 79000
Bilbo Baggins™

□ 79000
Gollum™



□ 79003
Bofur the Dwarf



□ 79004
Mirkwood™ Elf Guard



□ 79004
Gloin the Dwarf



□ 79001
Fili the Dwarf



□ 79001
Legolas Greenleaf™



□ 79002
Thorin Oakenshield™



□ 79002
Yazncp™



□ 79002
Warg



□ 79002
Warg



□ 79002
Bifur the Dwarf



□ 79010
Goblin Scribe

□ 79010
Ori the Dwarf



□ 79003
Bombur the Dwarf



□ 79003
Gandalf™ the Grey



□ 79001
Tauriel™



□ 79002
Hunter Orc

79002



79003



THE HOBBIT™

AN UNEXPECTED JOURNEY



3920
The Hobbit: An
Unexpected Journey

7+  2-4  15-25



GAMES





THE HOBBIT

AN UNEXPECTED JOURNEY

LEGO.com/thehobbit

