



THE HOBBIT™

AN UNEXPECTED JOURNEY

79010



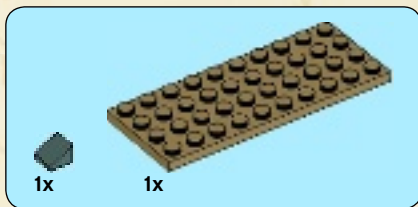
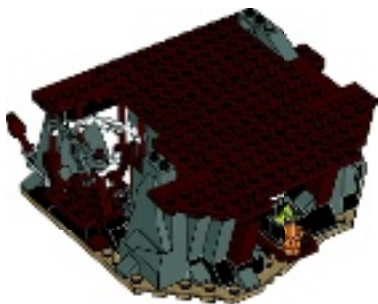
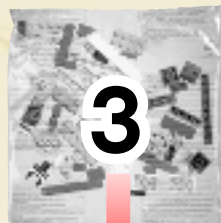
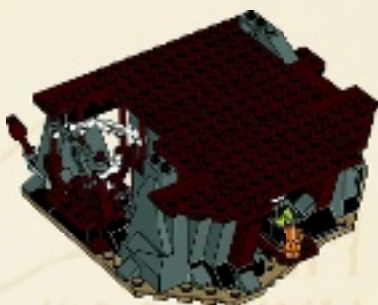
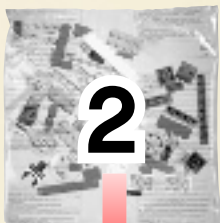

1

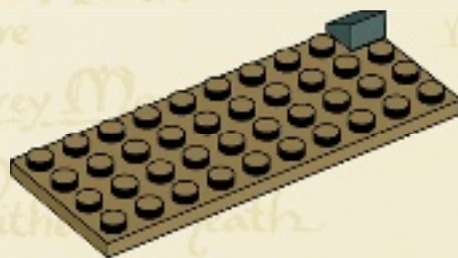



2

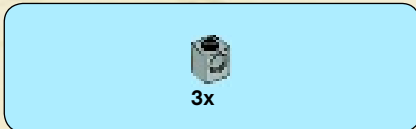
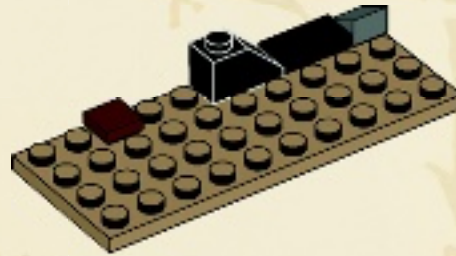

3

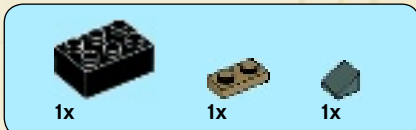
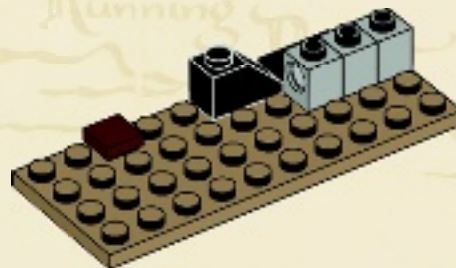

4

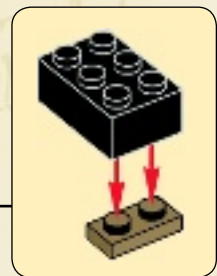
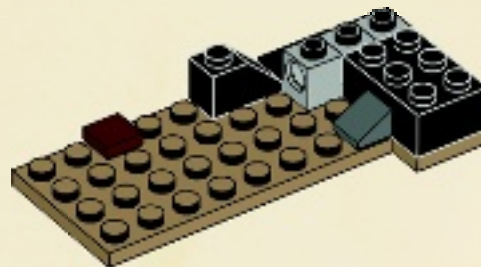

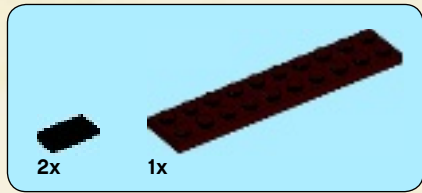

5

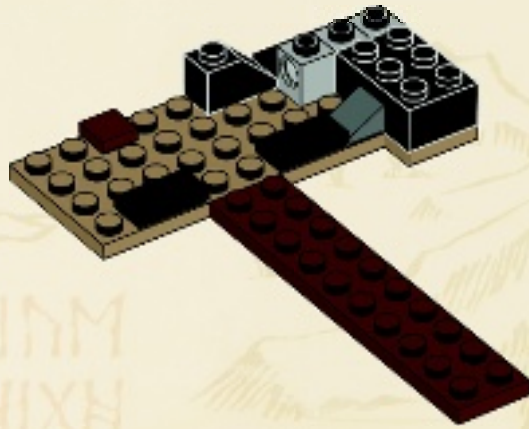

6

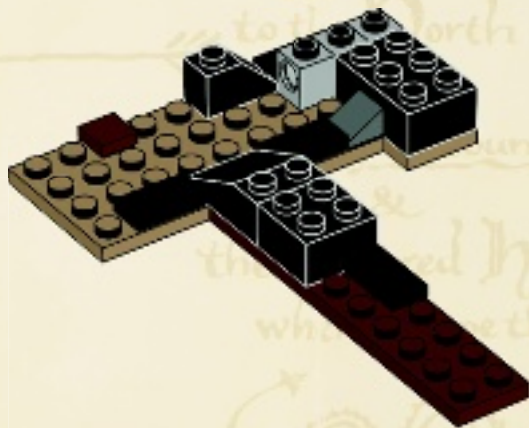

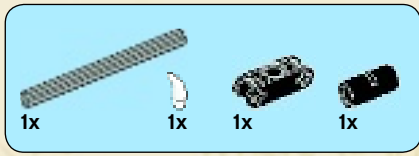

7

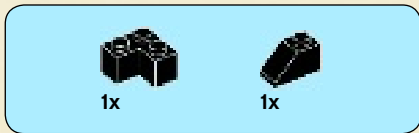
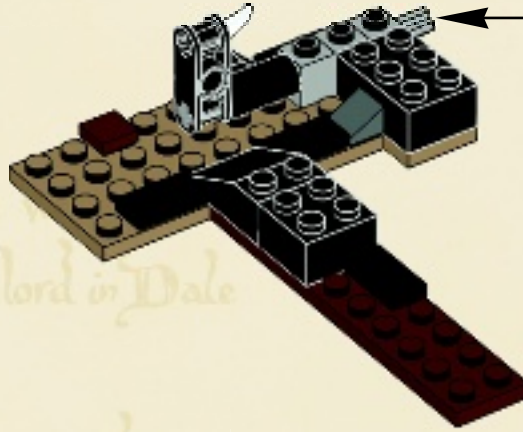
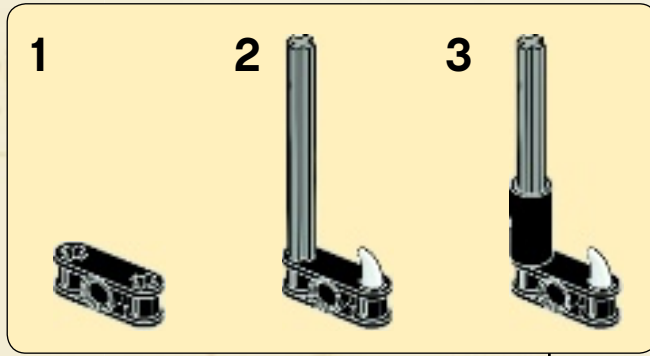

8

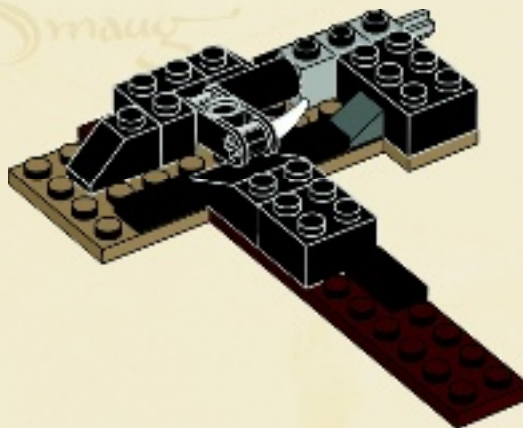

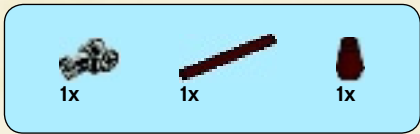

9

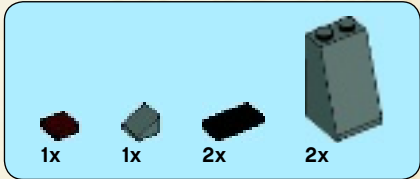
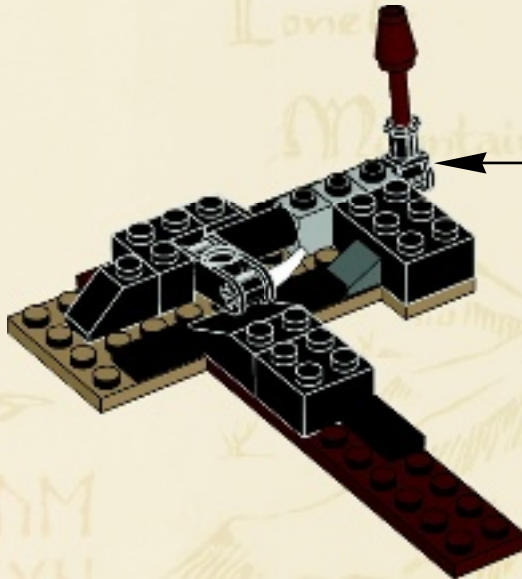

10

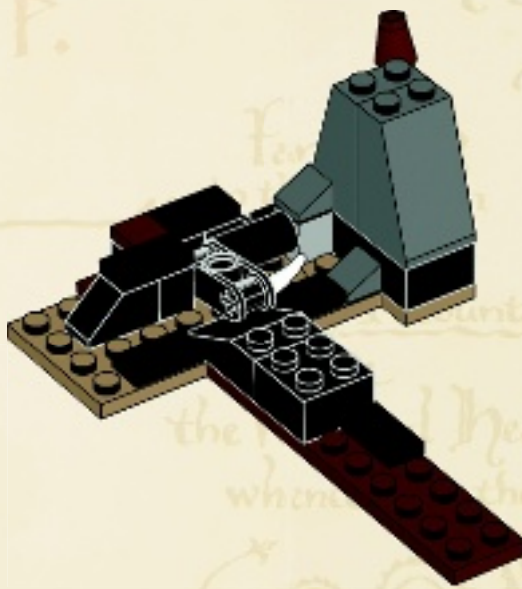

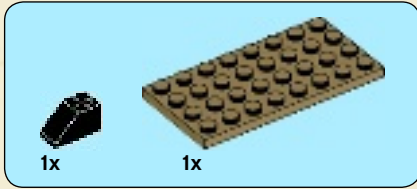
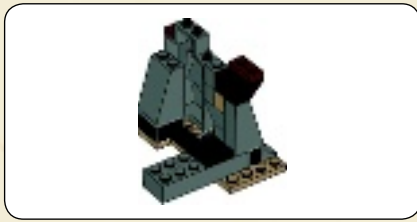

1

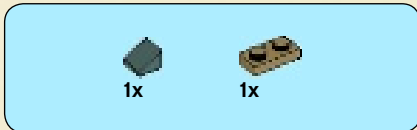

2

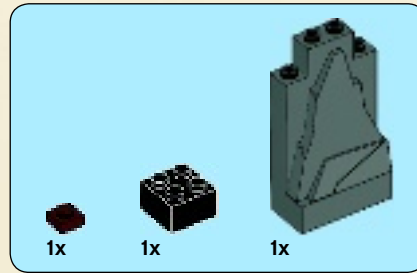

3

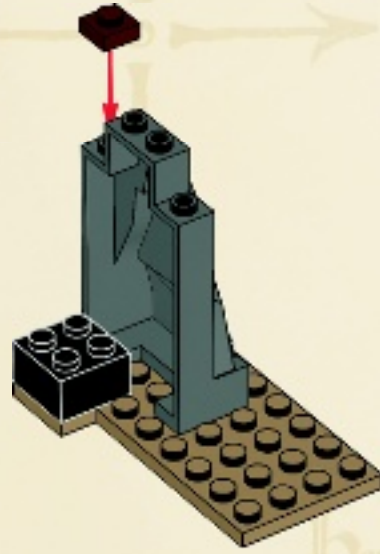

4

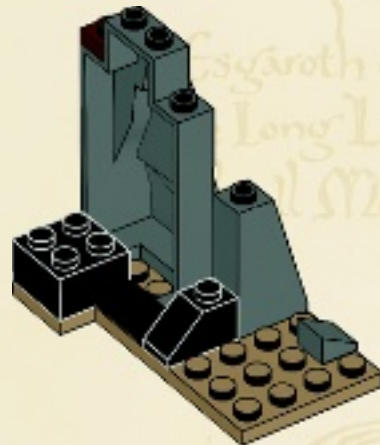

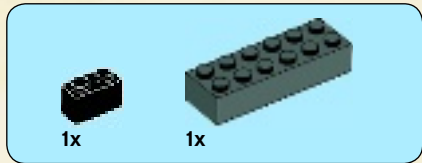

5

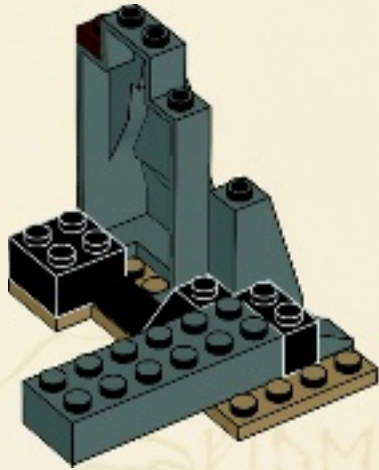

7

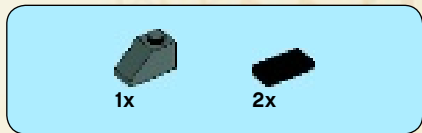
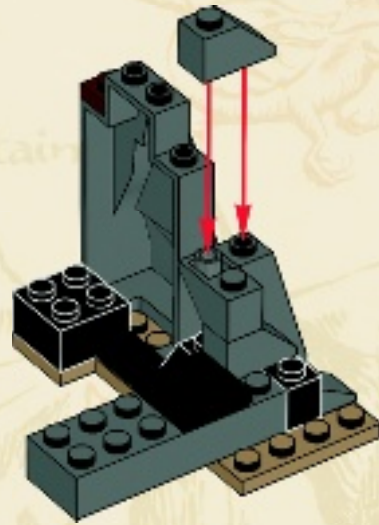

6

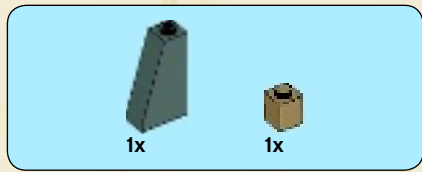
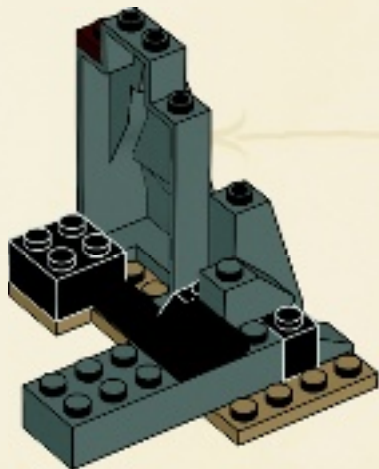

8

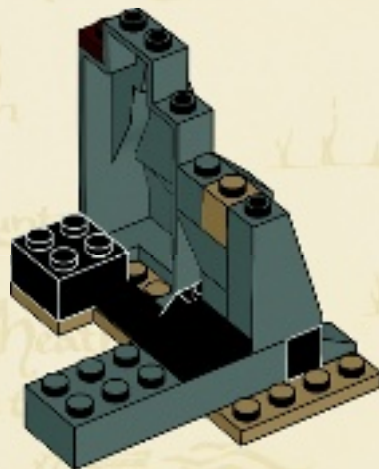

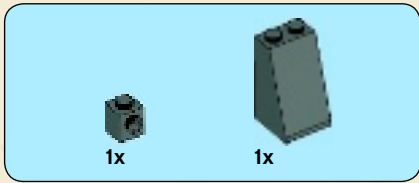

9

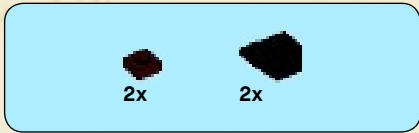
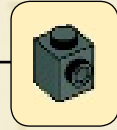
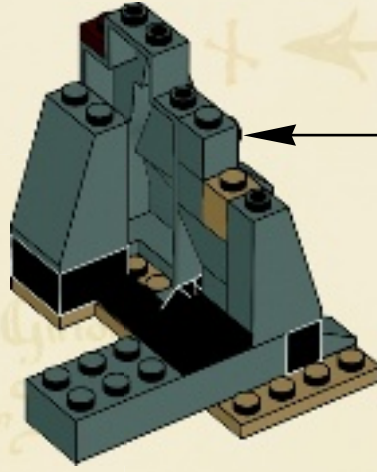

10

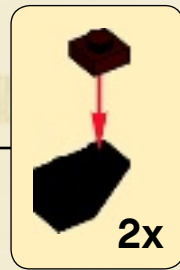
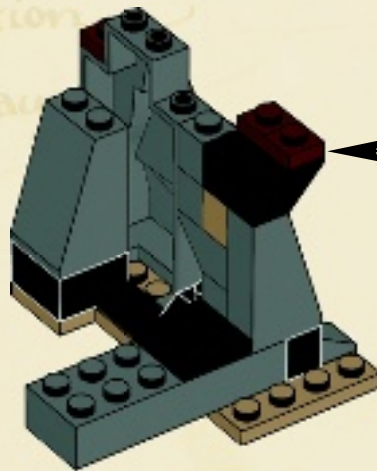

11

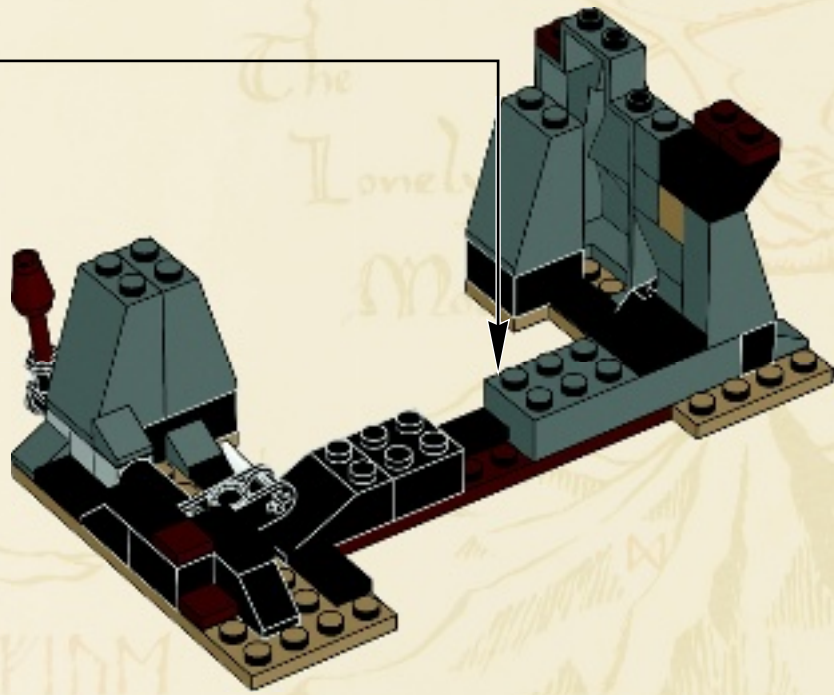

12

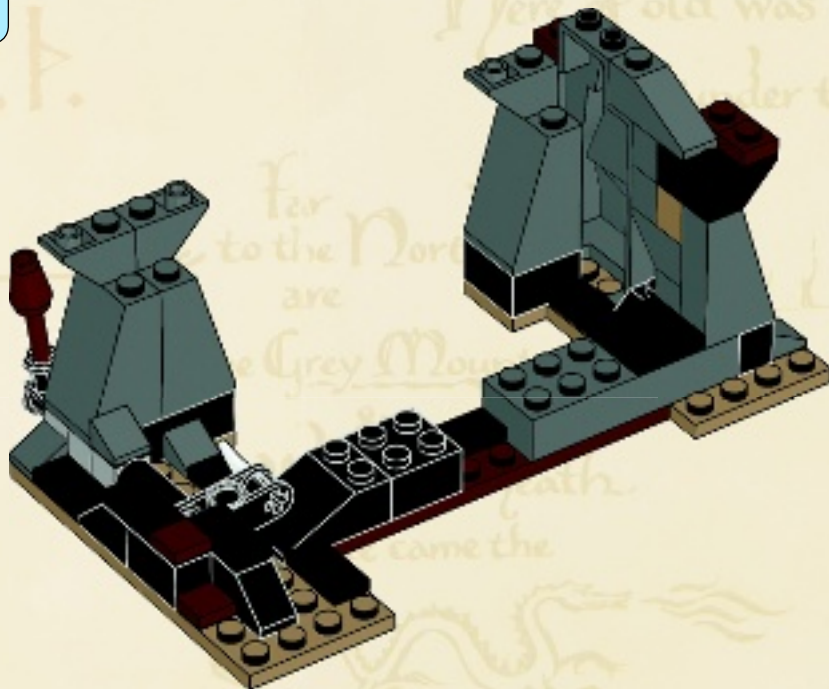

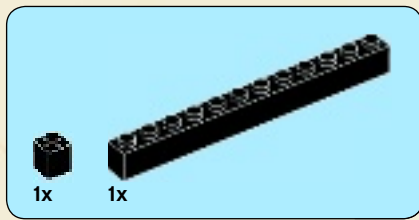

13

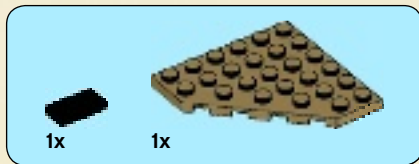
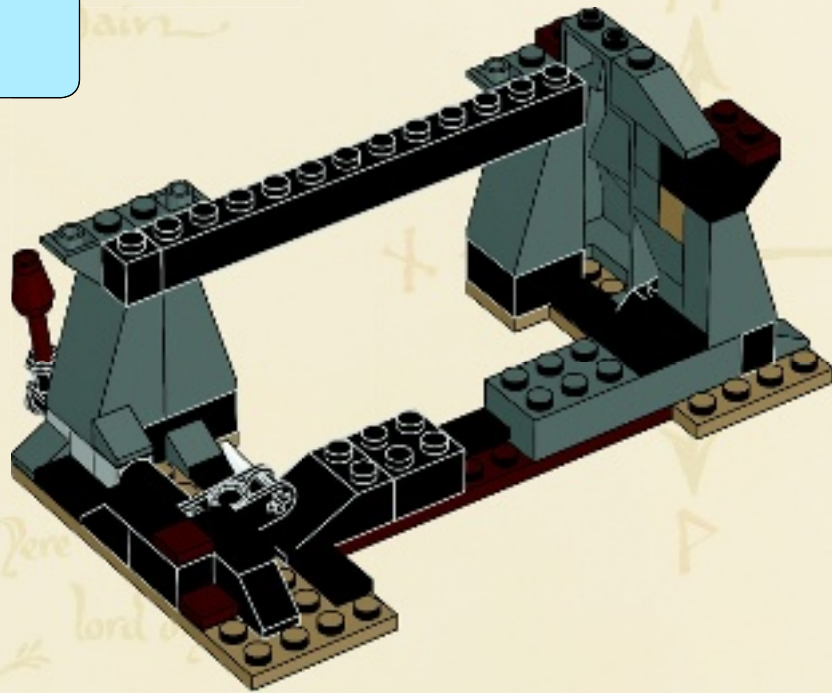

14

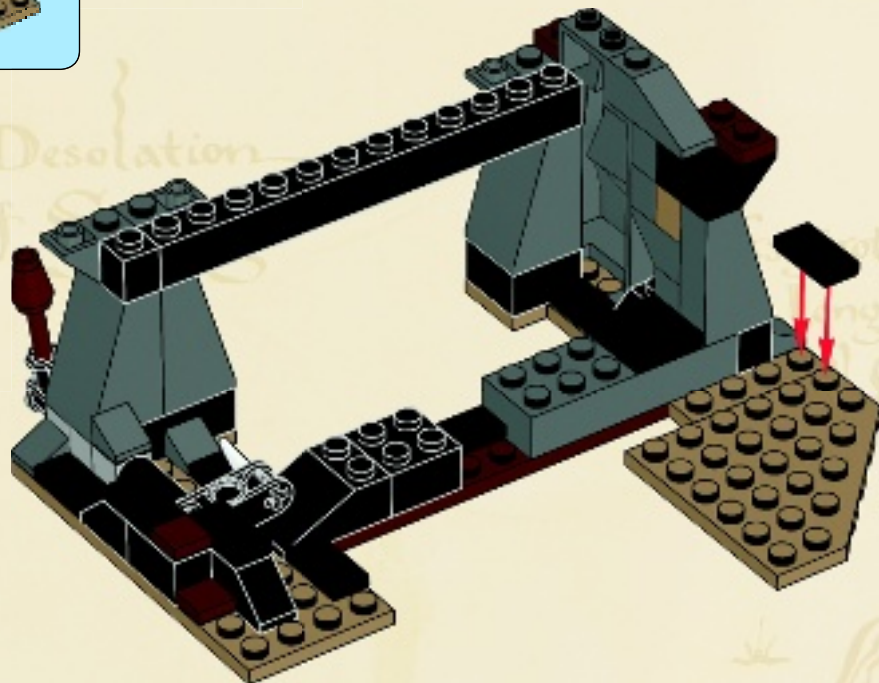

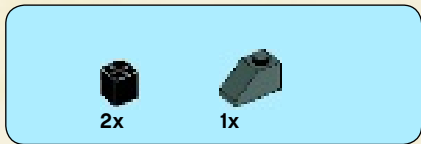

15

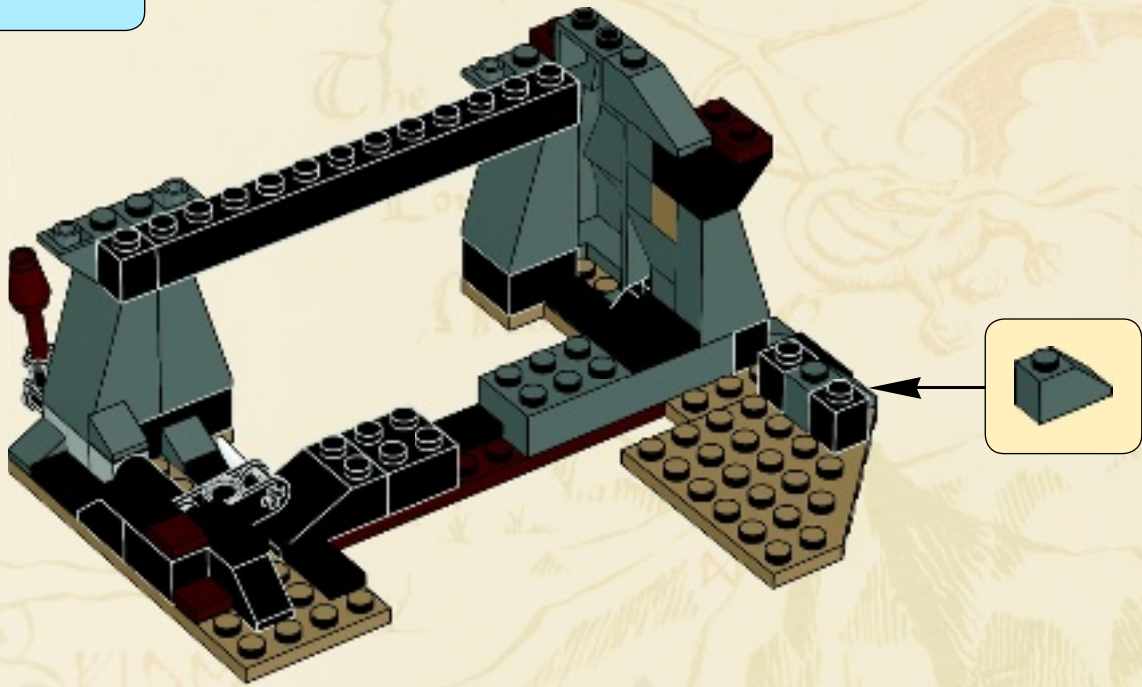

16

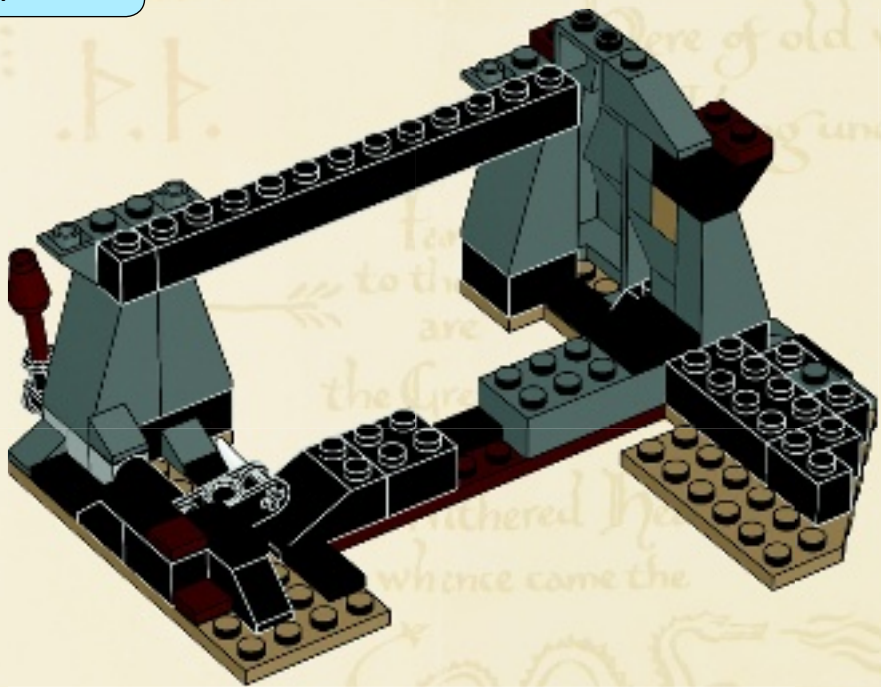

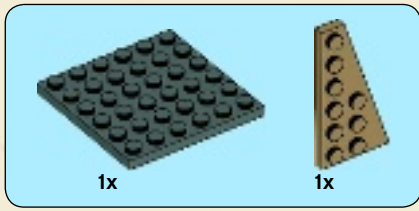

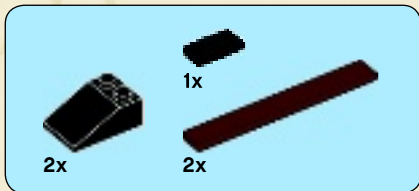
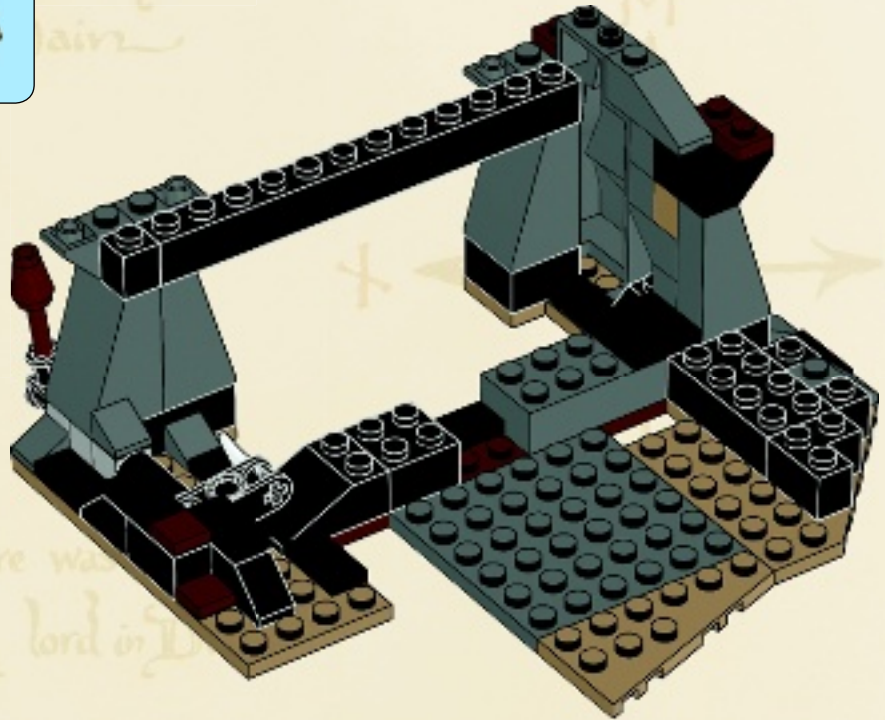

17

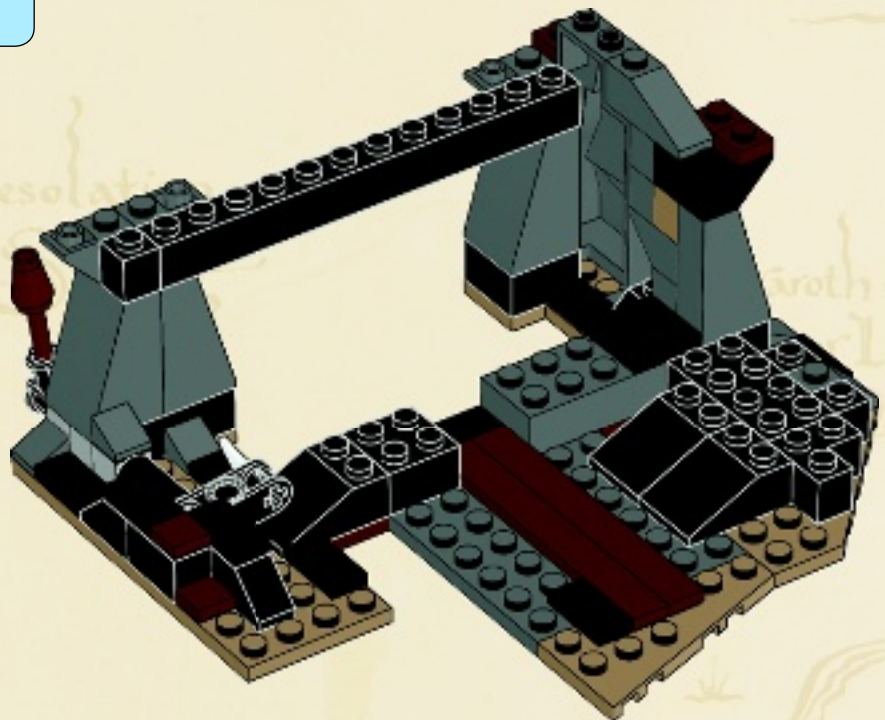

18



1x  1x 

19

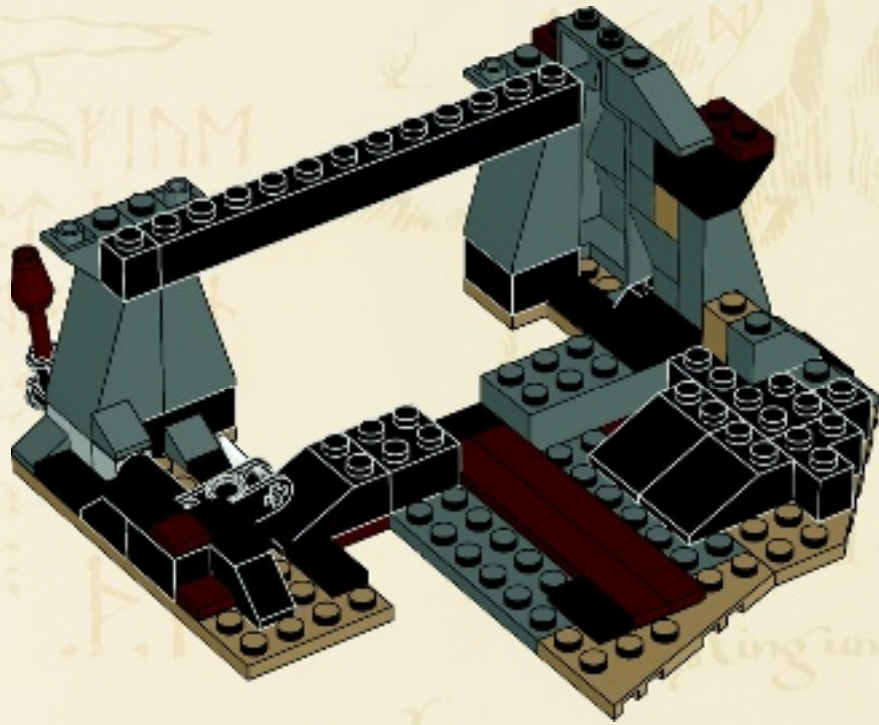

The
Lonely
Mountain

was Thror
living under the Mountain

Far
to the North
are
the Grey Mountains
&
the Withered Heath
whence came the

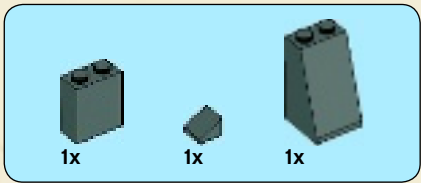

20

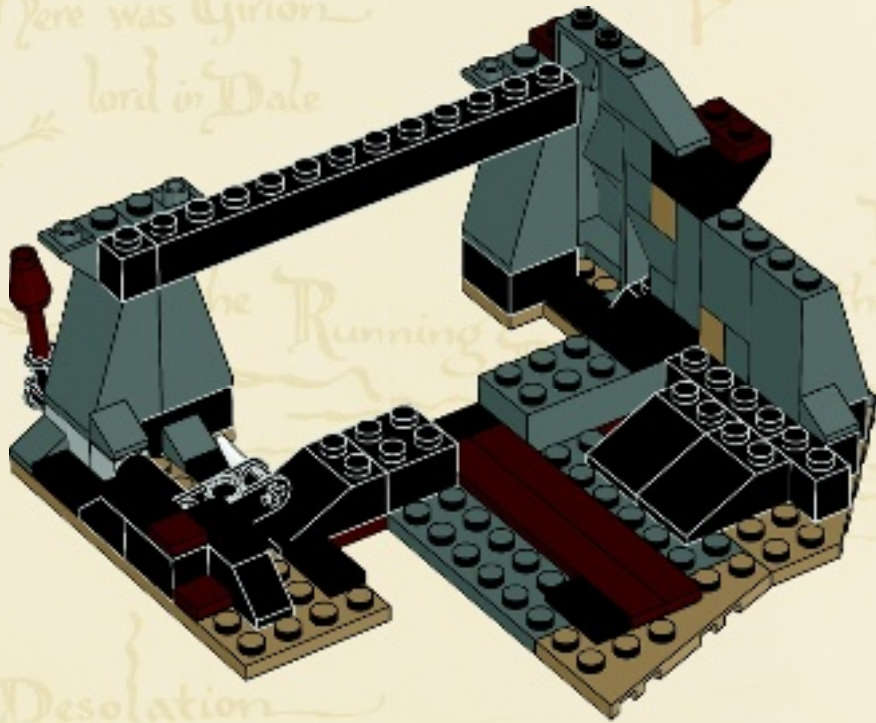

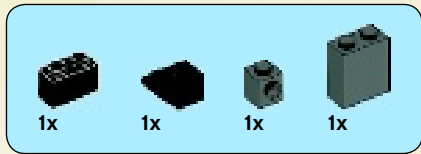

21

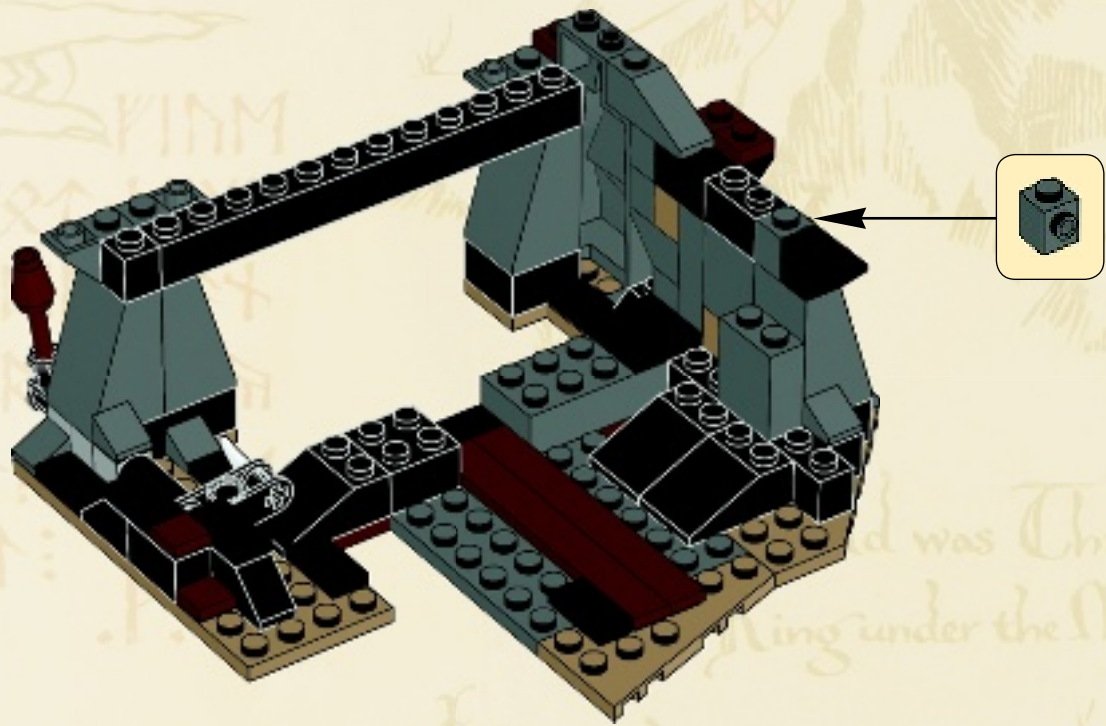

The
Lonely
Mountain

... was Thror
King under the Mountain

Far
to the North
are
the Grey Mountains
&
the Withered Heath
whence came the

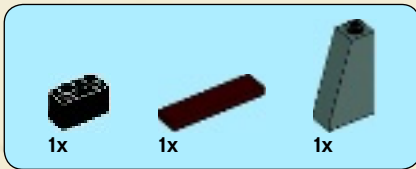

22

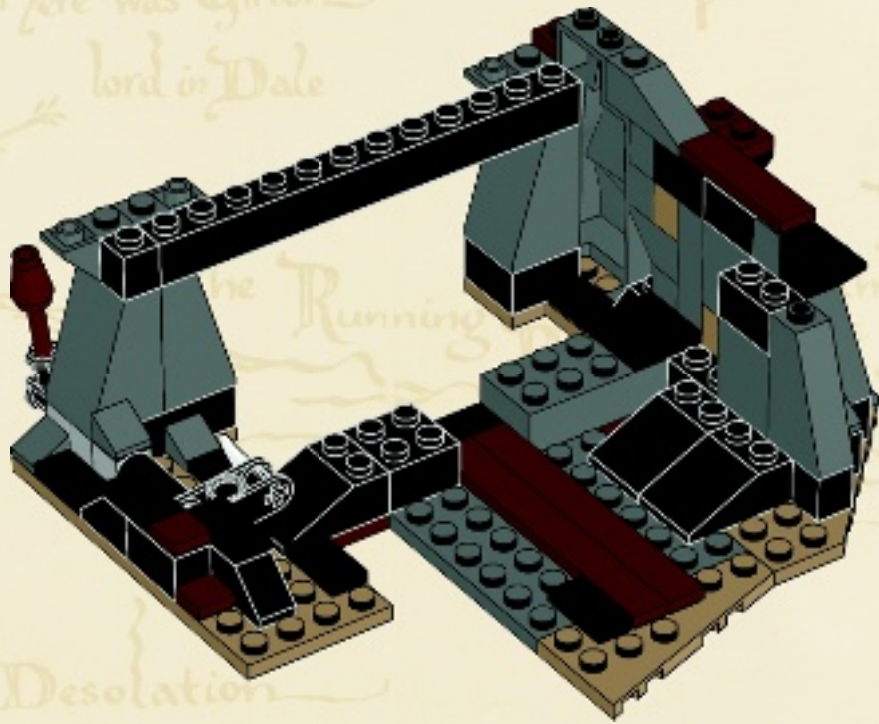

Here was Girion
lord in Dale

Here is
the gateway
to the Long
Lake

The Desolation
of Smaug

In Esgaroth upon
the Long Lake
dwell Men

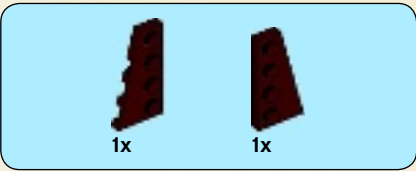
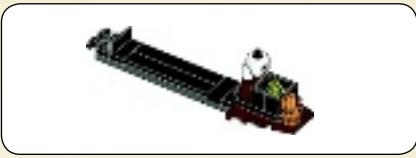

1

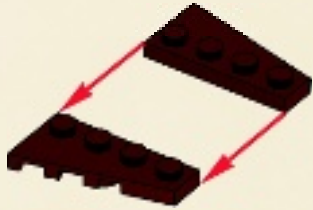

2

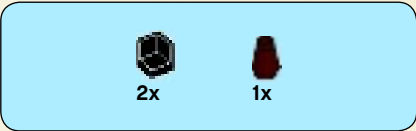

3

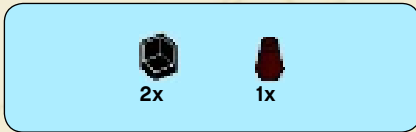

4



5

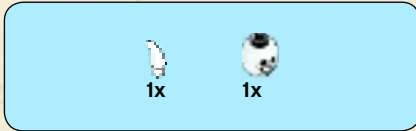

6



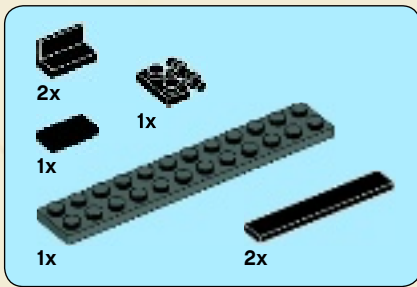

7

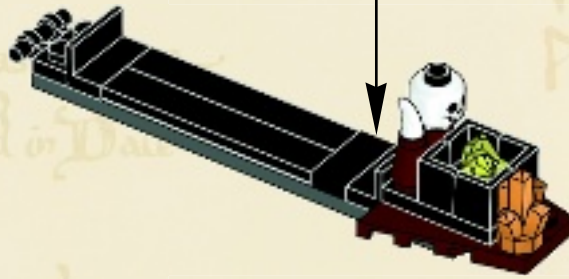
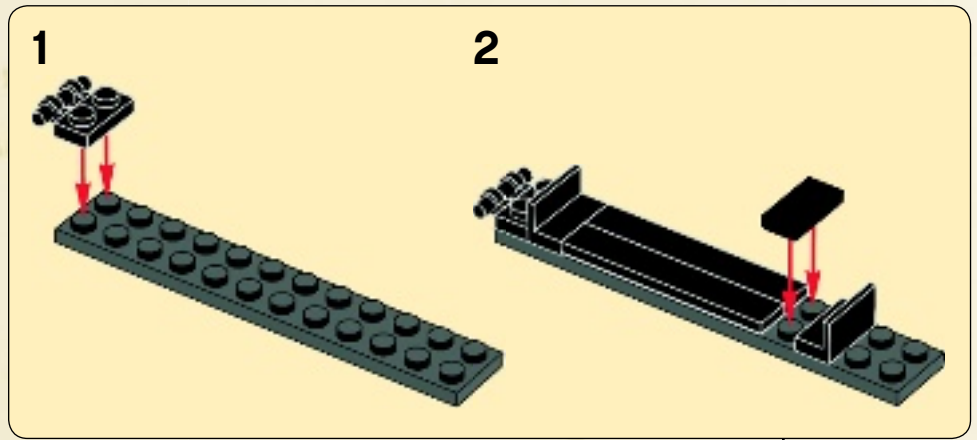

23

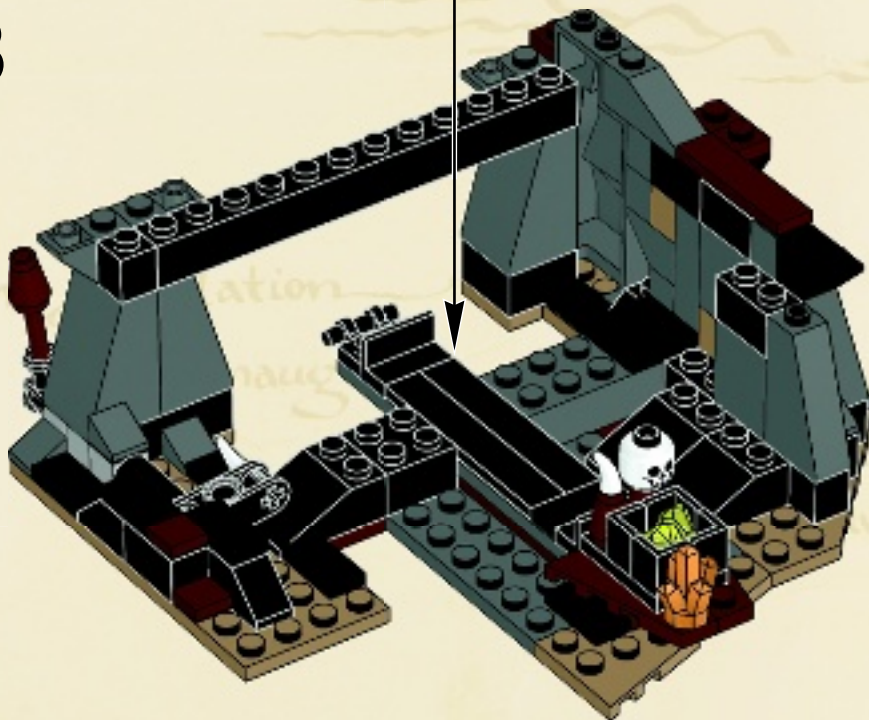

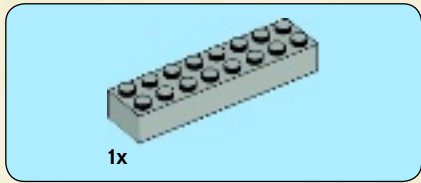

24

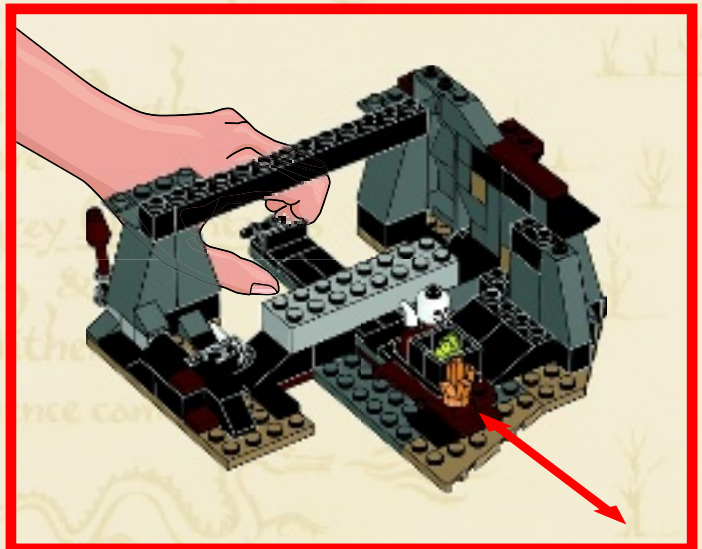
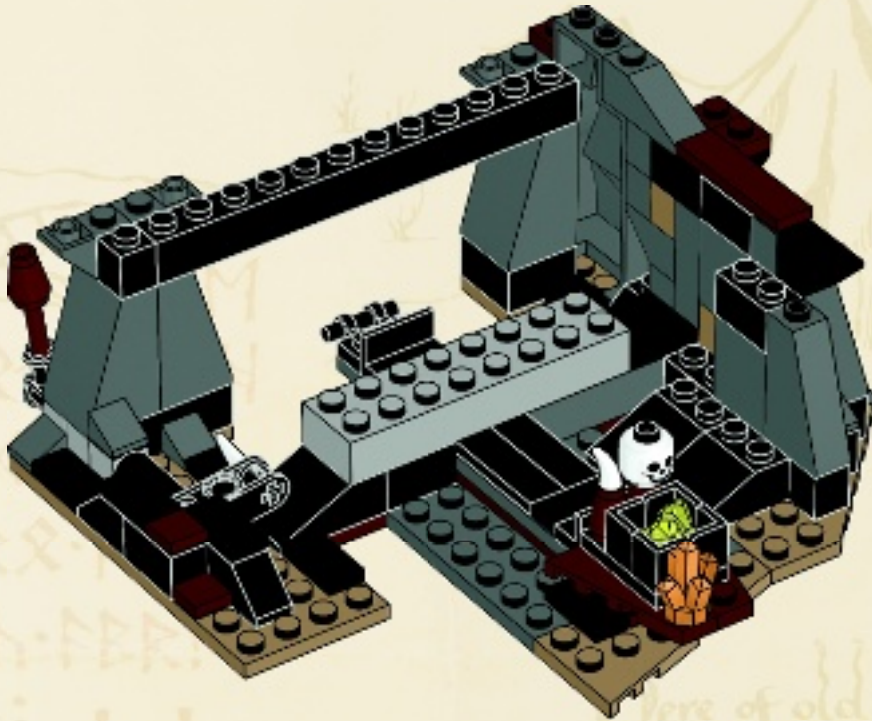



4x

25

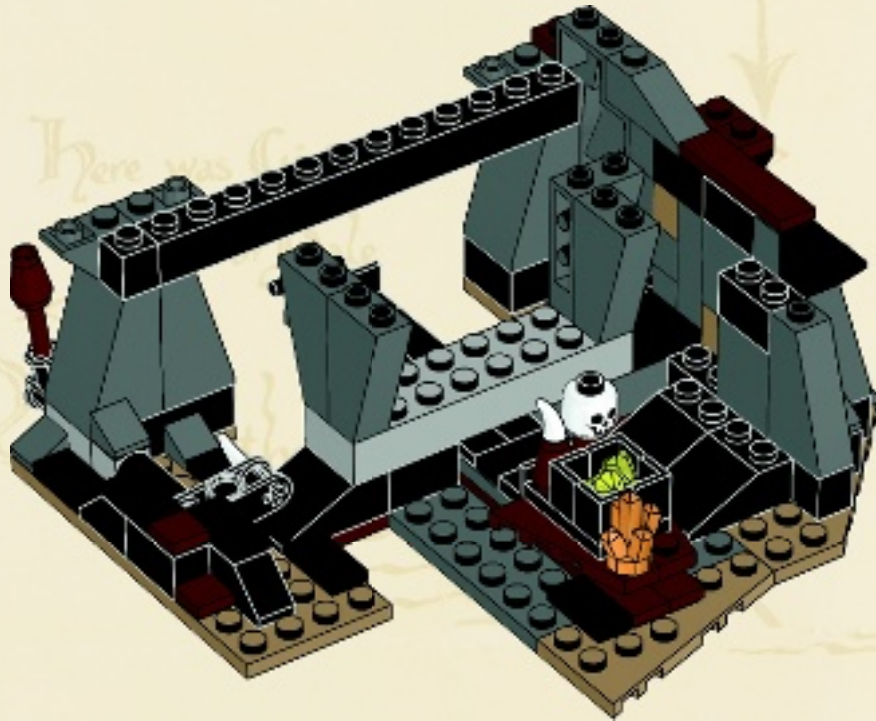

on Hills
air
Here was
Amaly
Ravenhill
The Desolation
of Smaug
Here is
the gateway
of the Long
Lake
In Esgaroth upon
the Long Lake
dwell Men



26





27

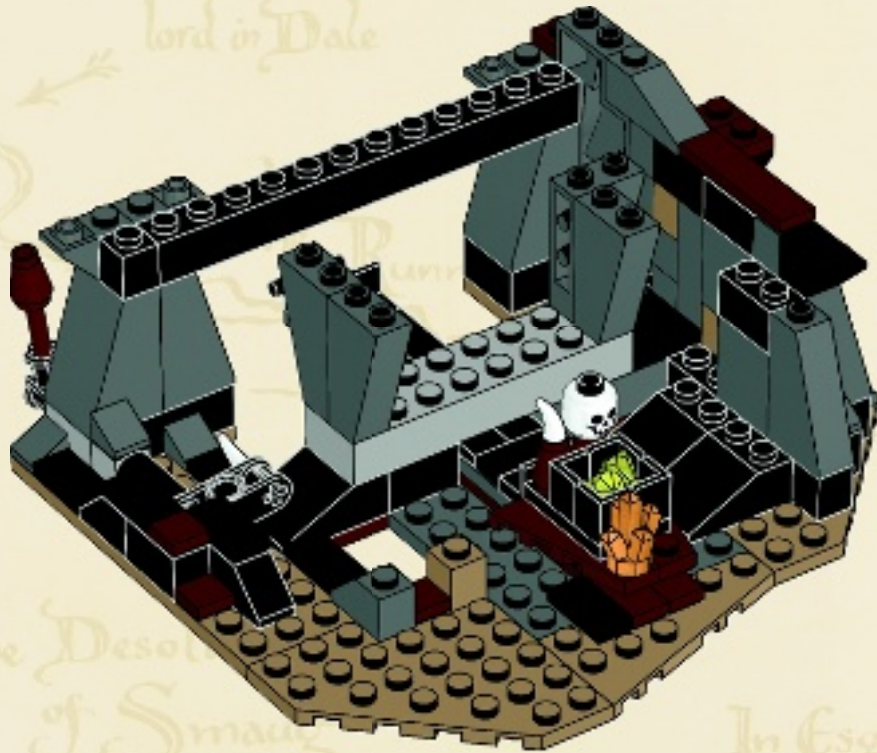



1x



1x

28

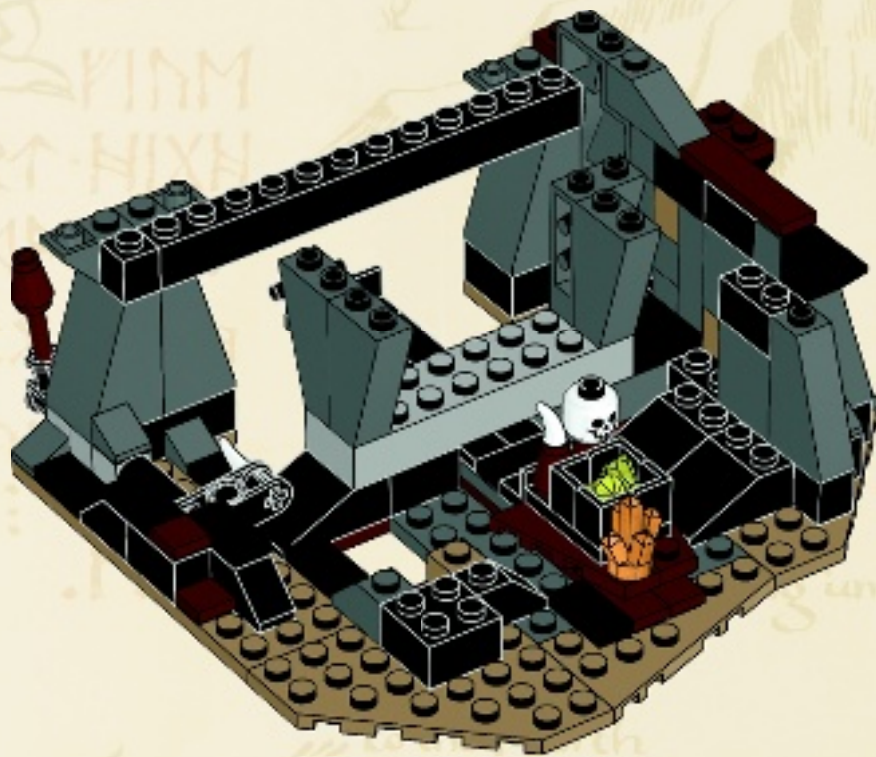

The
Lonely
Mountain

was Thror
under the Mountain

are
the Grey Mountains
&
the Withered Heath
whence came the



29

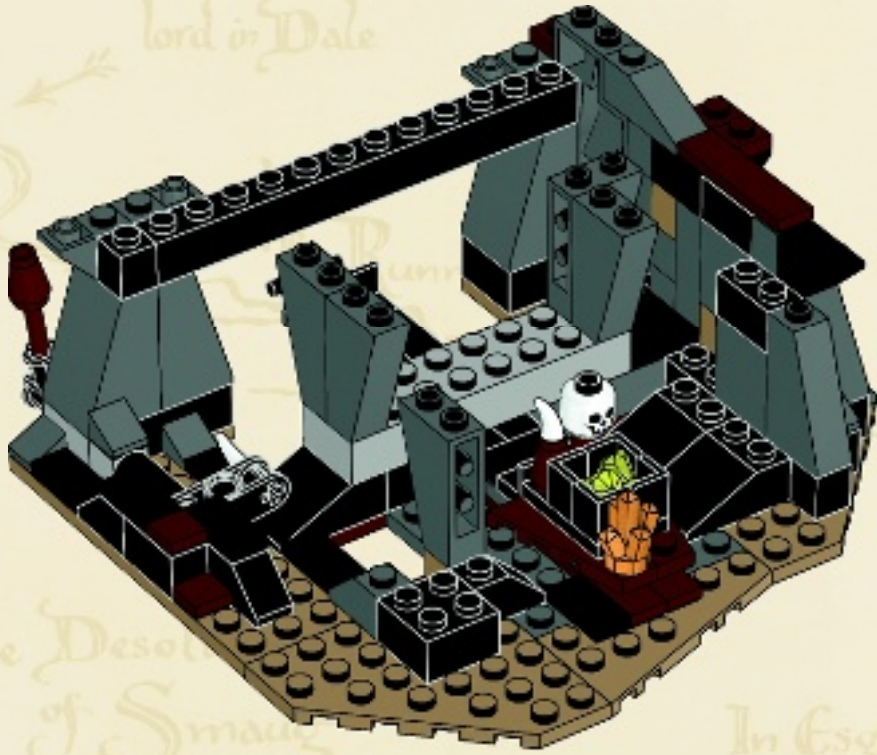

on Hills
hair

M

Here was Girton
lord in Dale

Here is
the gateway
of the Long
Lake

The Desol
of Smaug

In Esgaroth upon
the Long Lake
dwell Men

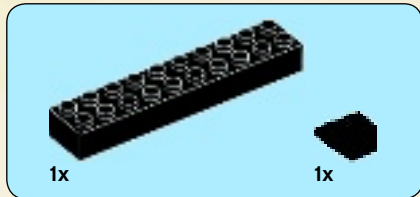

30

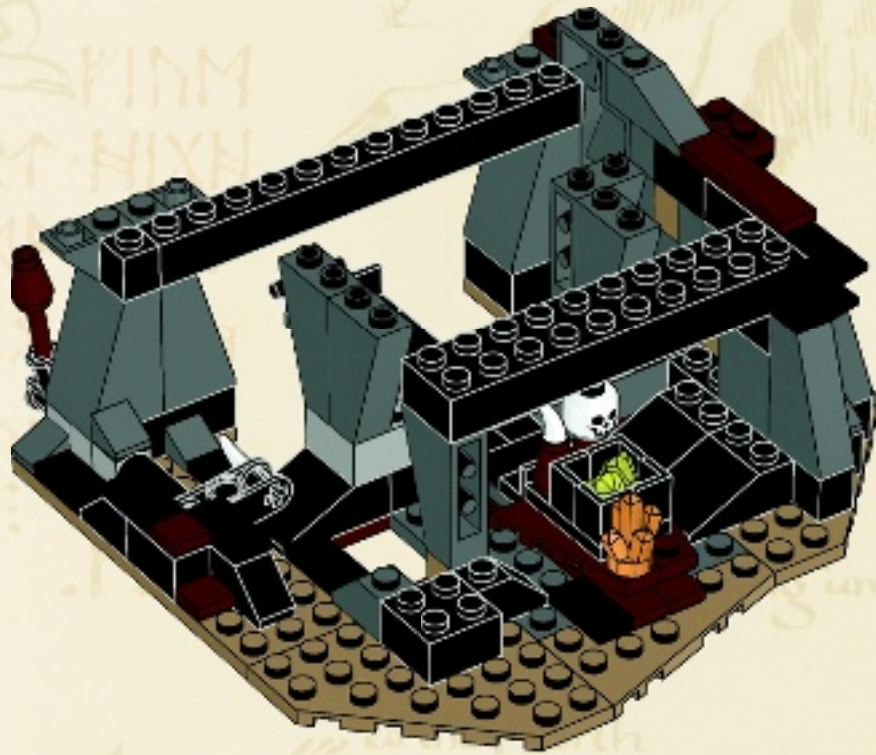

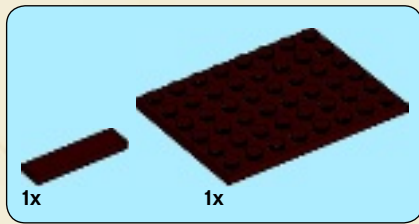

31

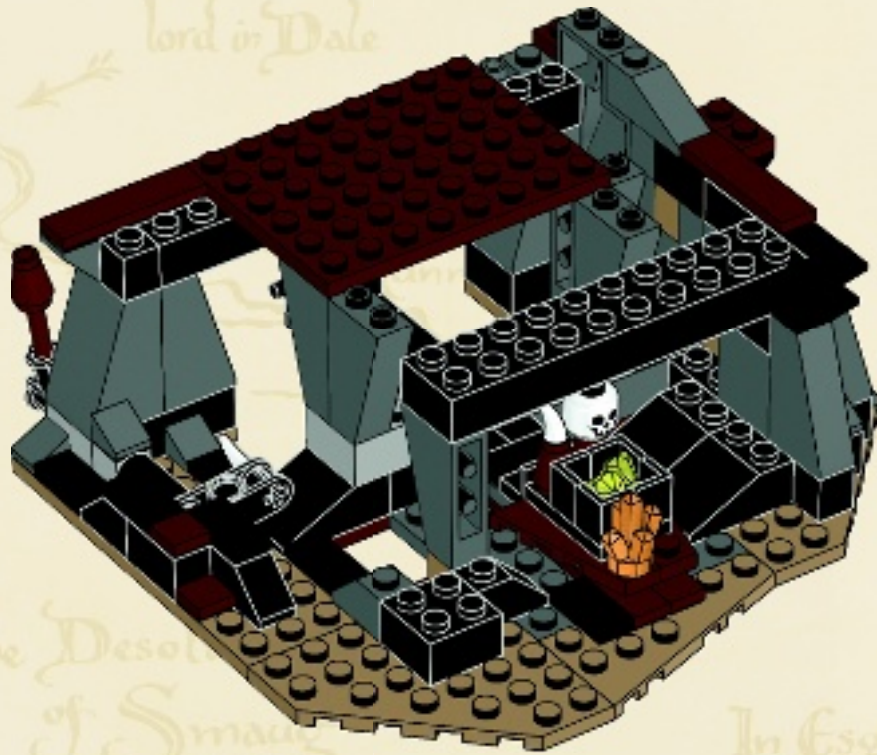

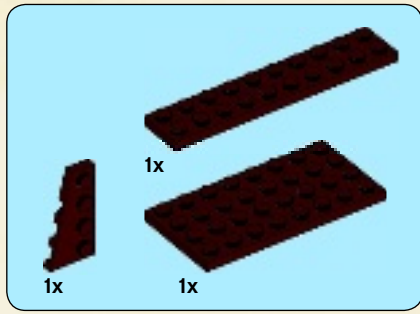

32

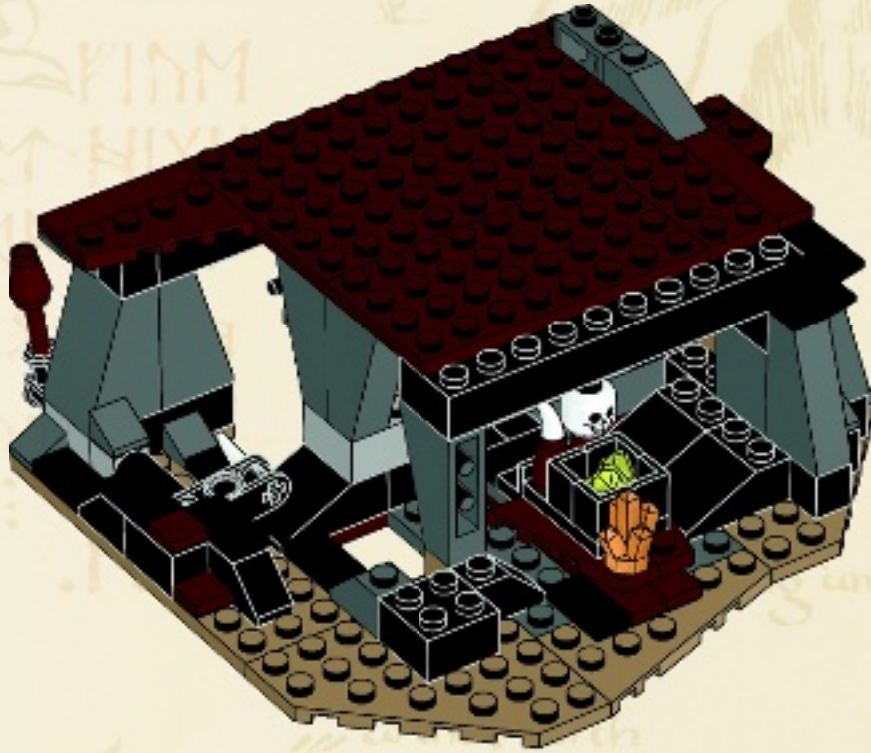

the Grey Mountains

the Withered Heath
whence came the

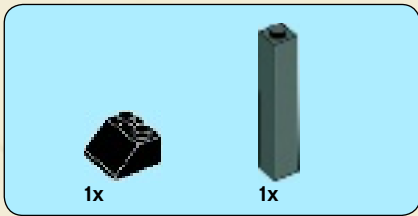

33

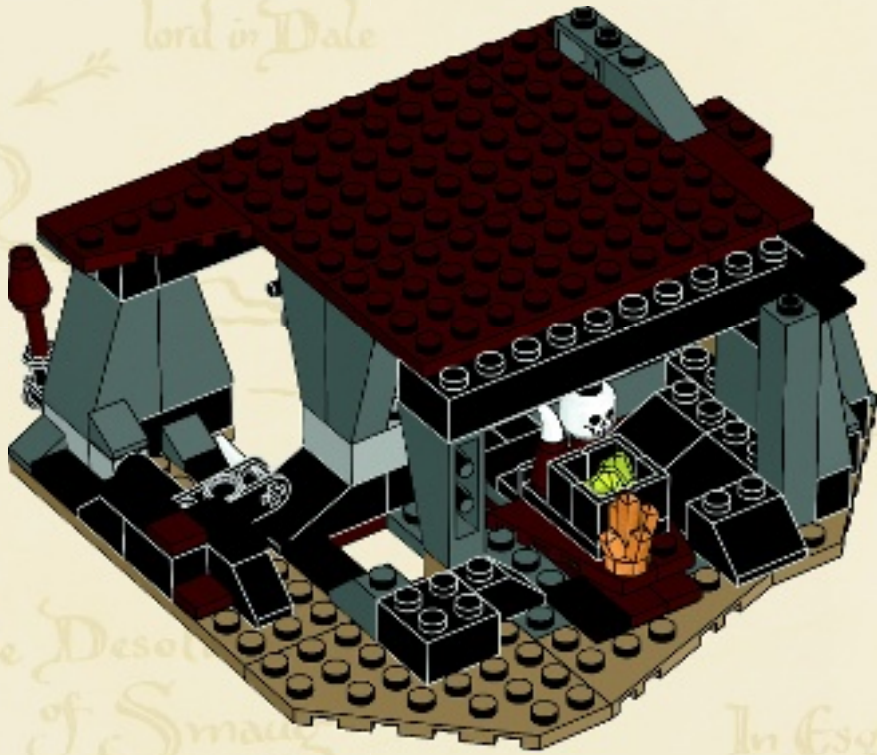

*Here was Girion
lord in Dale*

*Here is
the gateway
of the Long
Lake*

*The Desolation
of Smaug*

*In Esgaroth upon
the Long Lake
dwell Men*

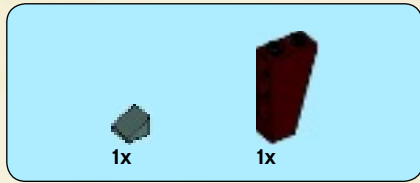

34

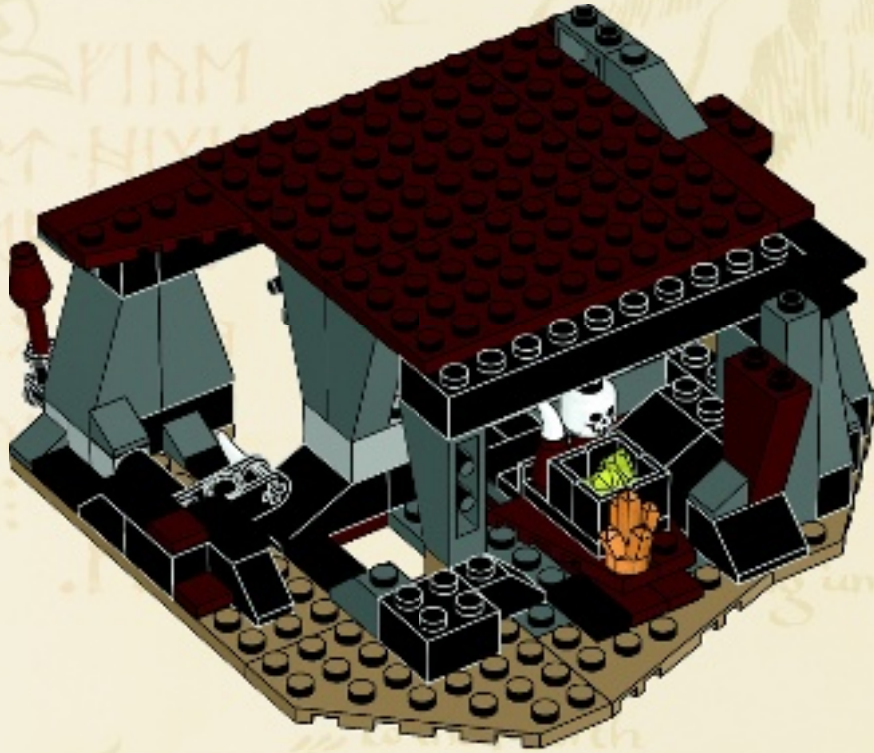



1x



1x

35

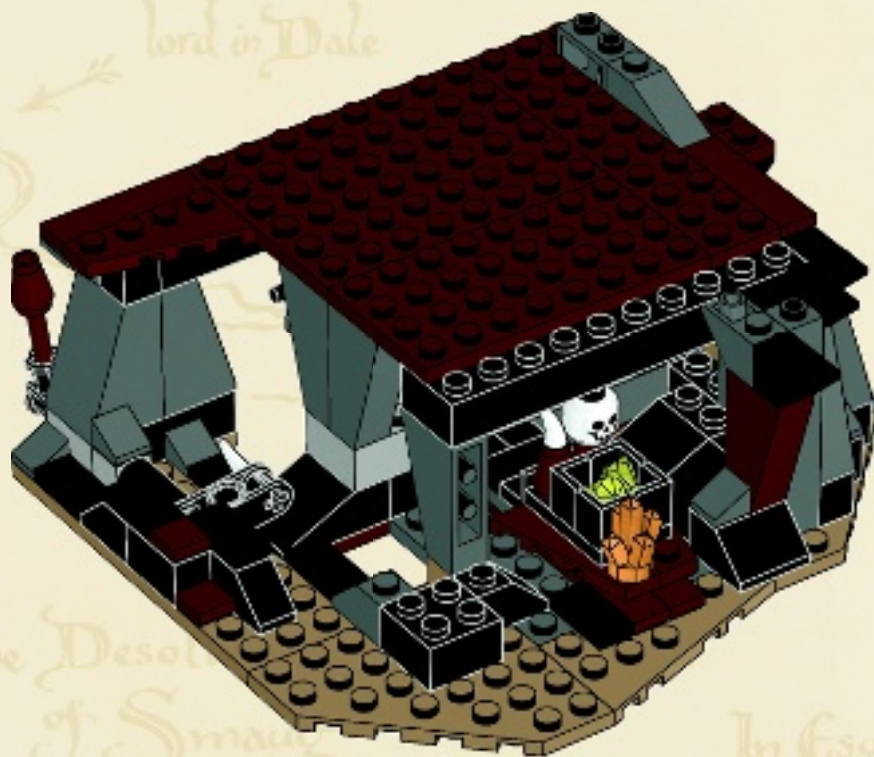

on Hills
where is Dair

Here was Girion
lord in Dale

Here is
the gateway
of the Long
Lake

The Desolation
of Smaug

In Esgaroth upon
the Long Lake
dwell Men

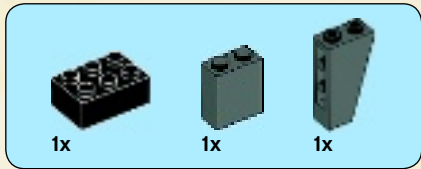

36



The
Lonely
Mountain

was Thror
under the Mount

are
the Grey Mountains
&
the Withered Heath
whence came the

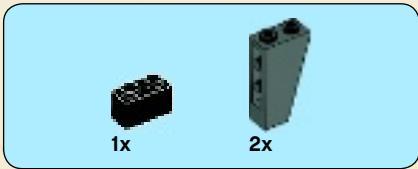

37

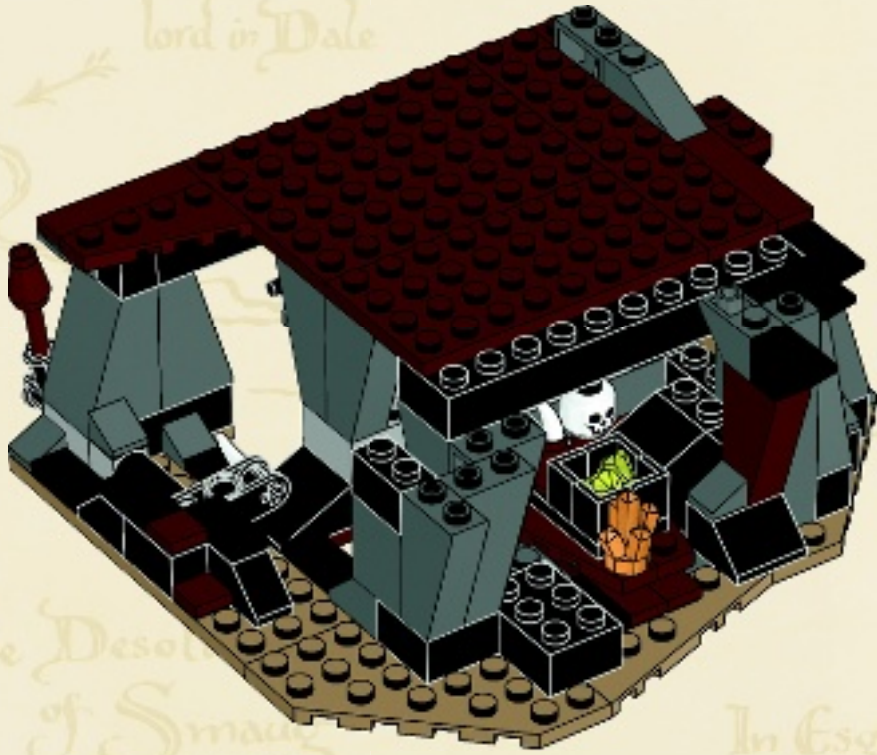

on Hills
hair

M

Here was Girion
lord in Dale

Here is
the gateway
of the Long
Lake

The Desolation
of Smaug

In Esgaroth upon
the Long Lake
dwell Men

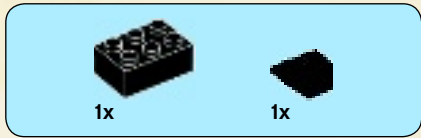

38

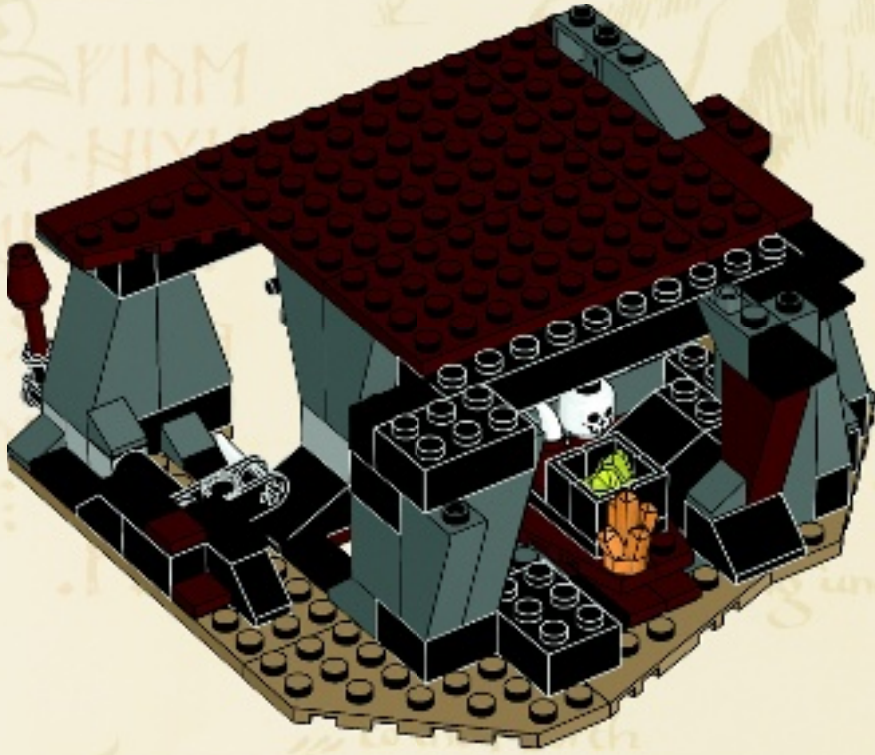

The
Lonely
Mountain

was Thror
under the Mountain

are
the Grey Mountains
&
the Withered Heath
whence came the

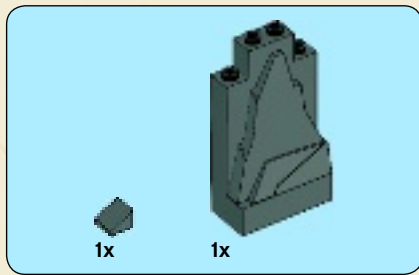

39

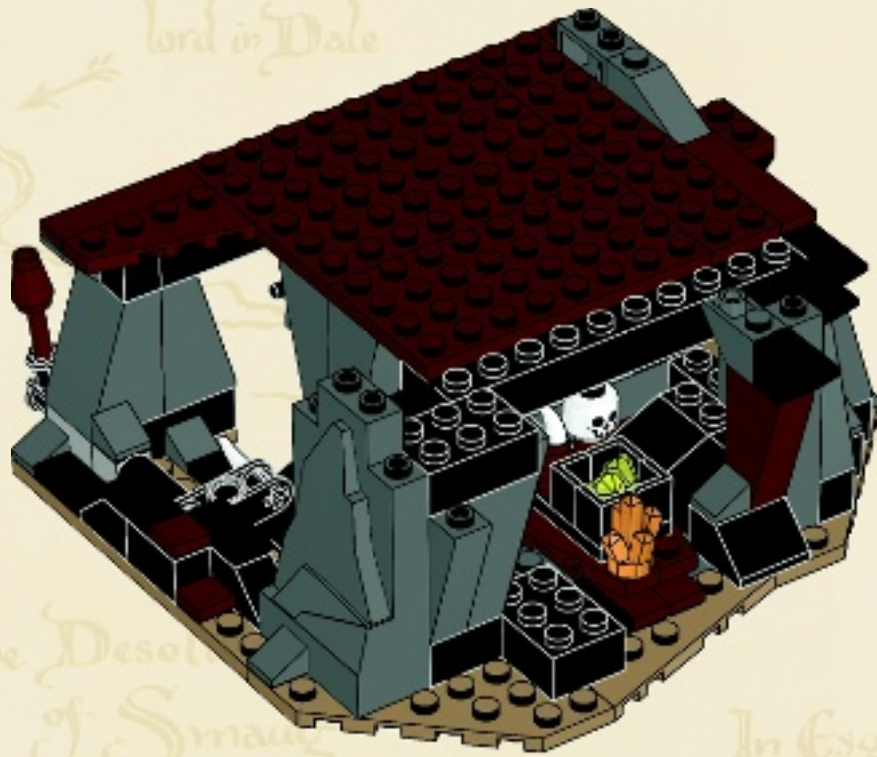



1x



3x

40



The
Lonely
Mountain

was Thoror
under the Mount

are
the Grey Mountains
&
the Withered Heath
whence came the



41

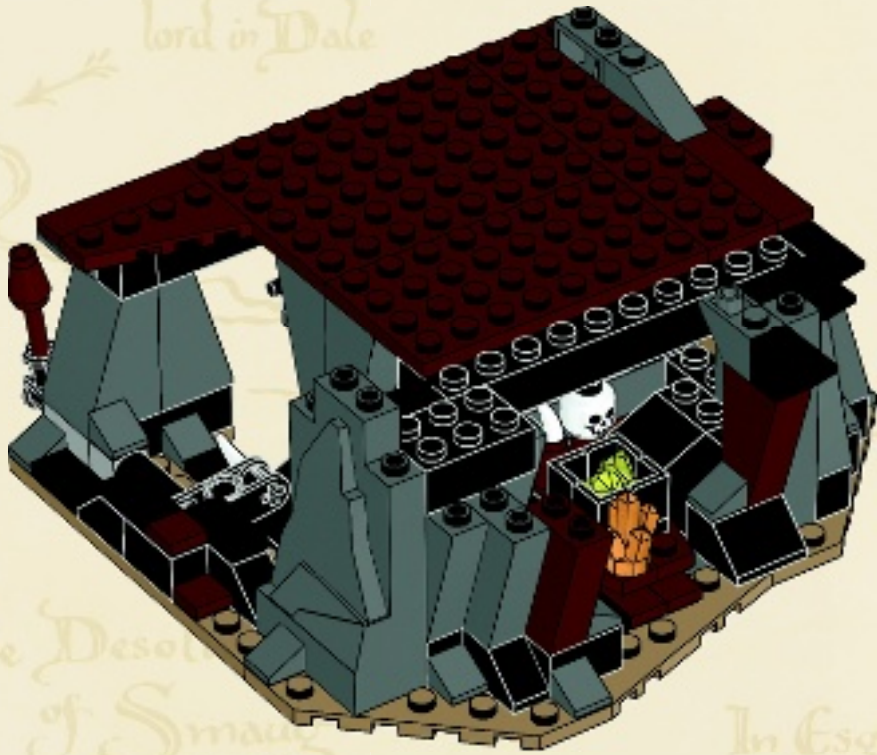



1x



1x

42

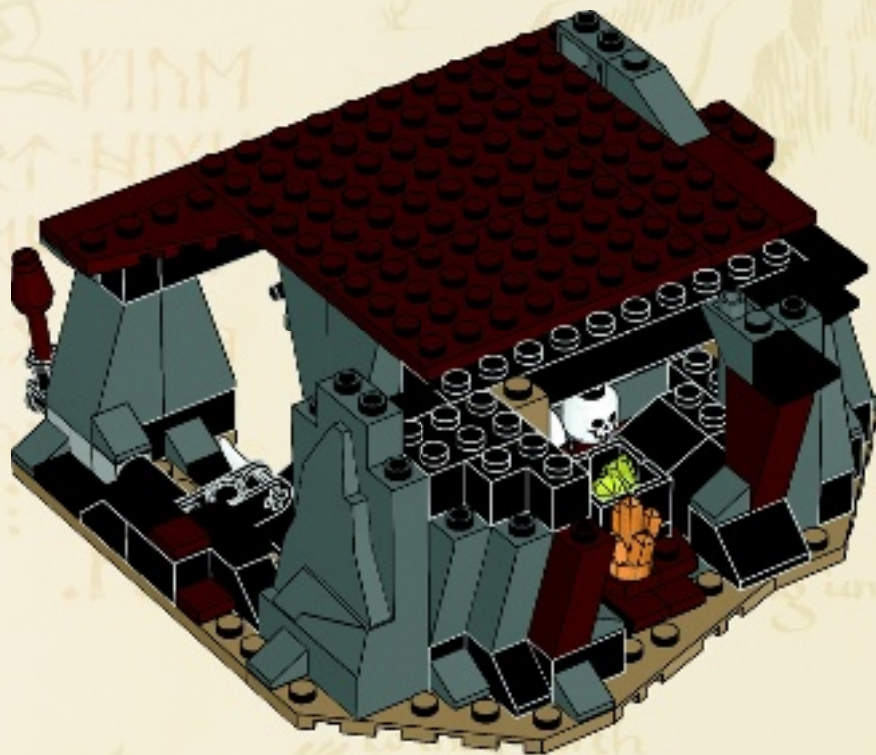

The
Lonely
Mountain

VINM
KRT·HIX
FM·M
W·PR
PENN
MHT:

was Thror
S under the Mount

are in
the Grey Mountains

&
the Withered Heath
whence came the



1x



2x

43

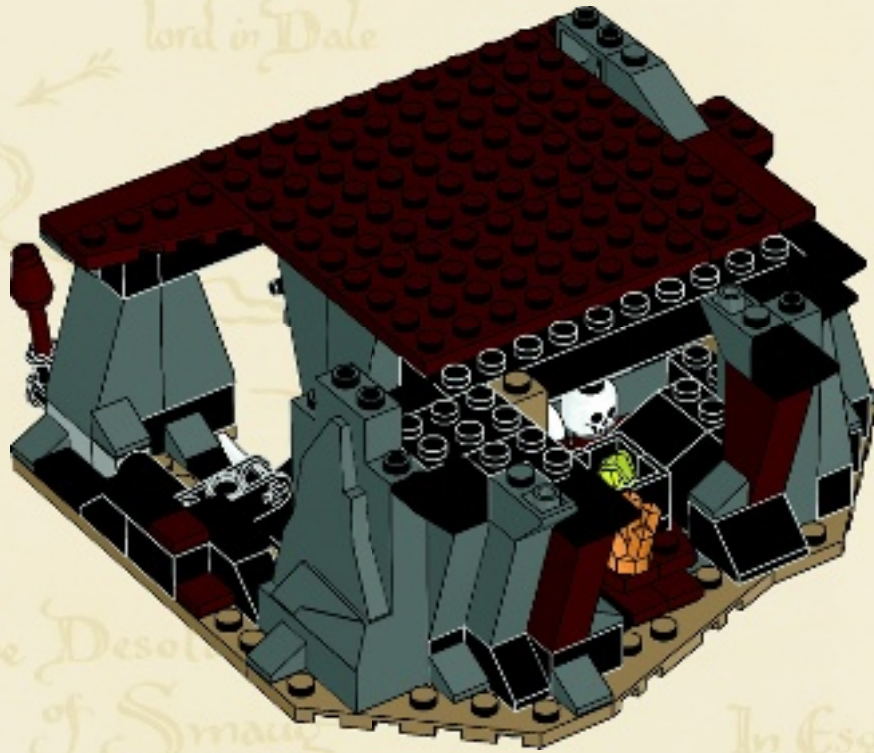

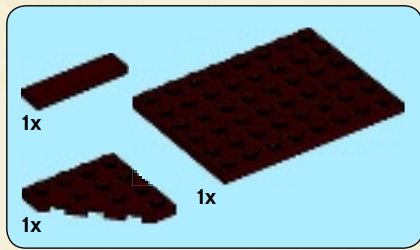

44

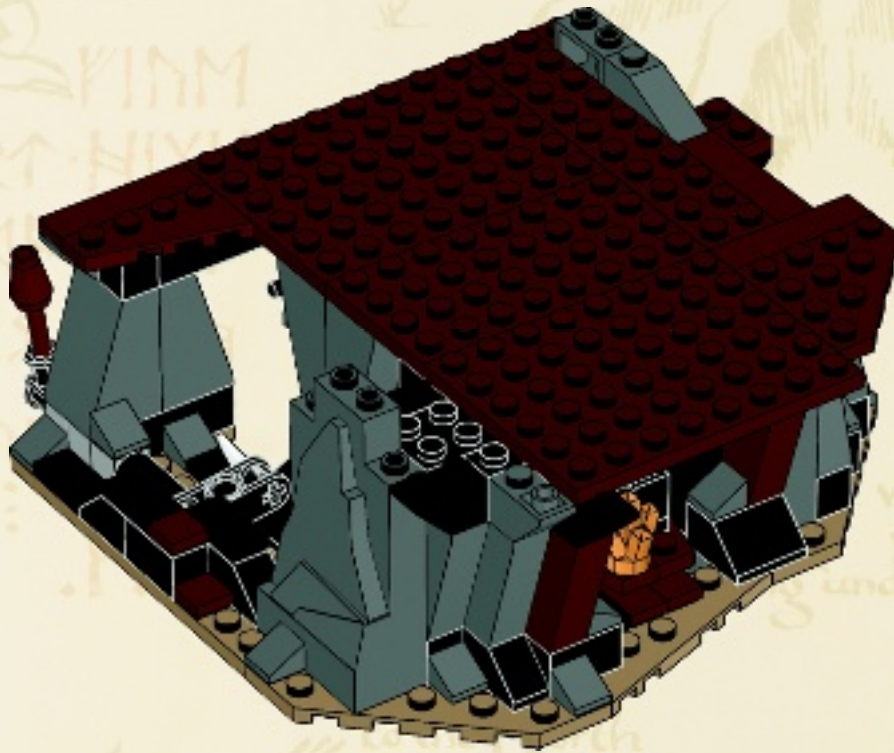

the Grey Mountains
&
the Withered Heath
whence came the

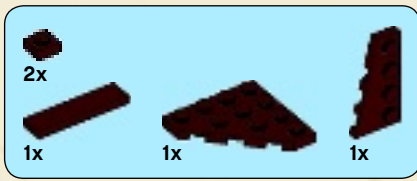

45

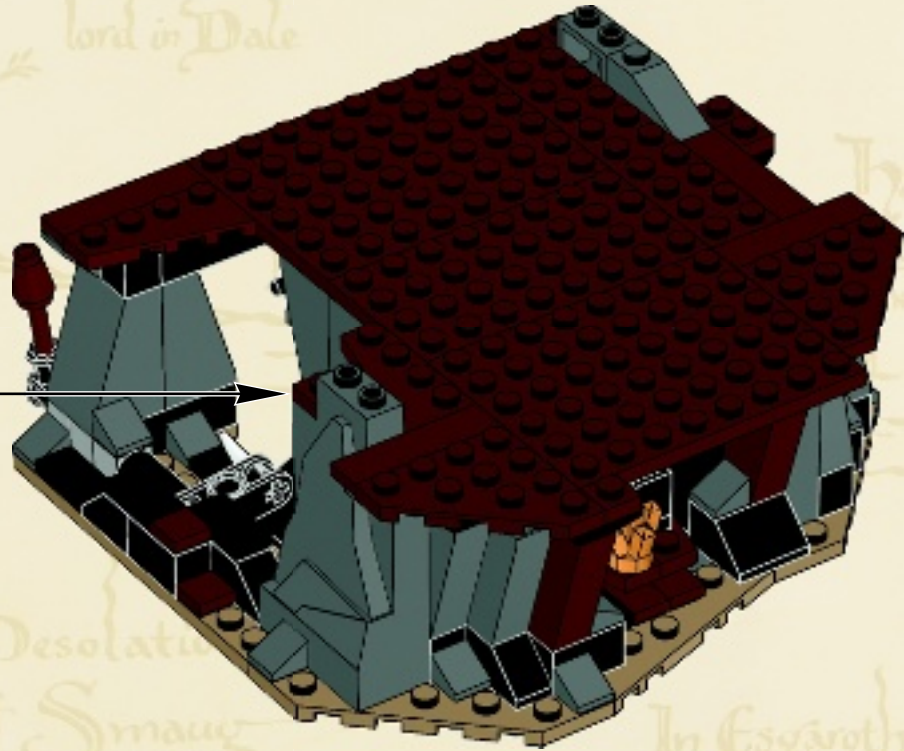

Here was Girion
lord in Dale

Here is
Gateway
to Long
Lake

The Desolation
of Smaug

In Esgaroth upon
the Long Lake
dwell Men



46

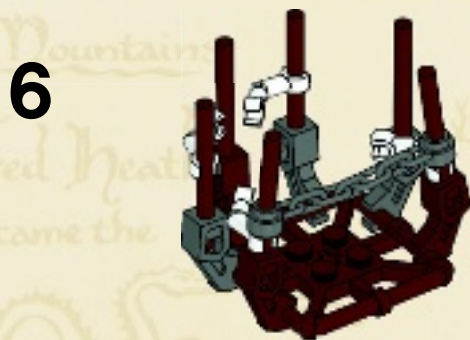
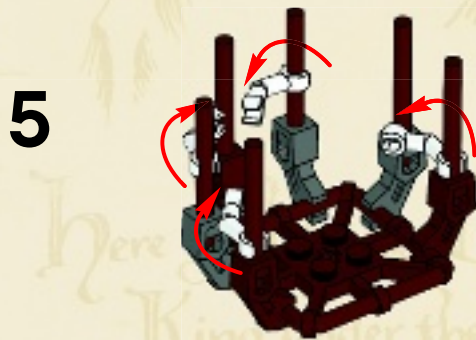
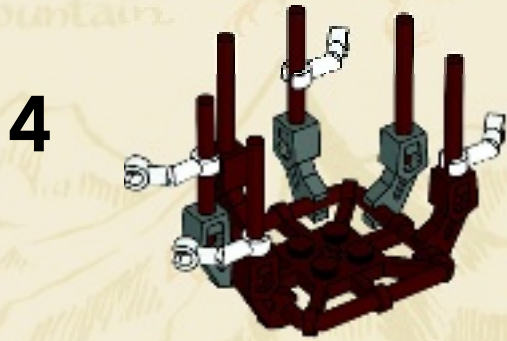
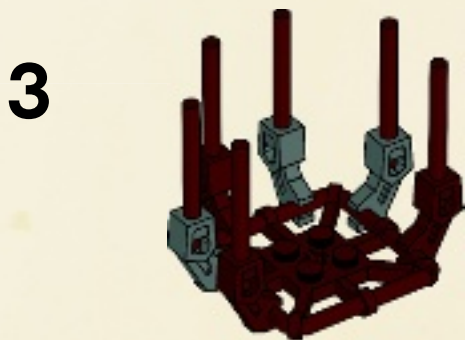
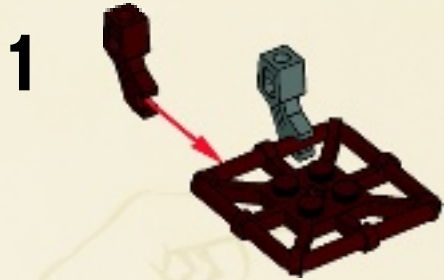



lie the Iron Hills
here is Dain

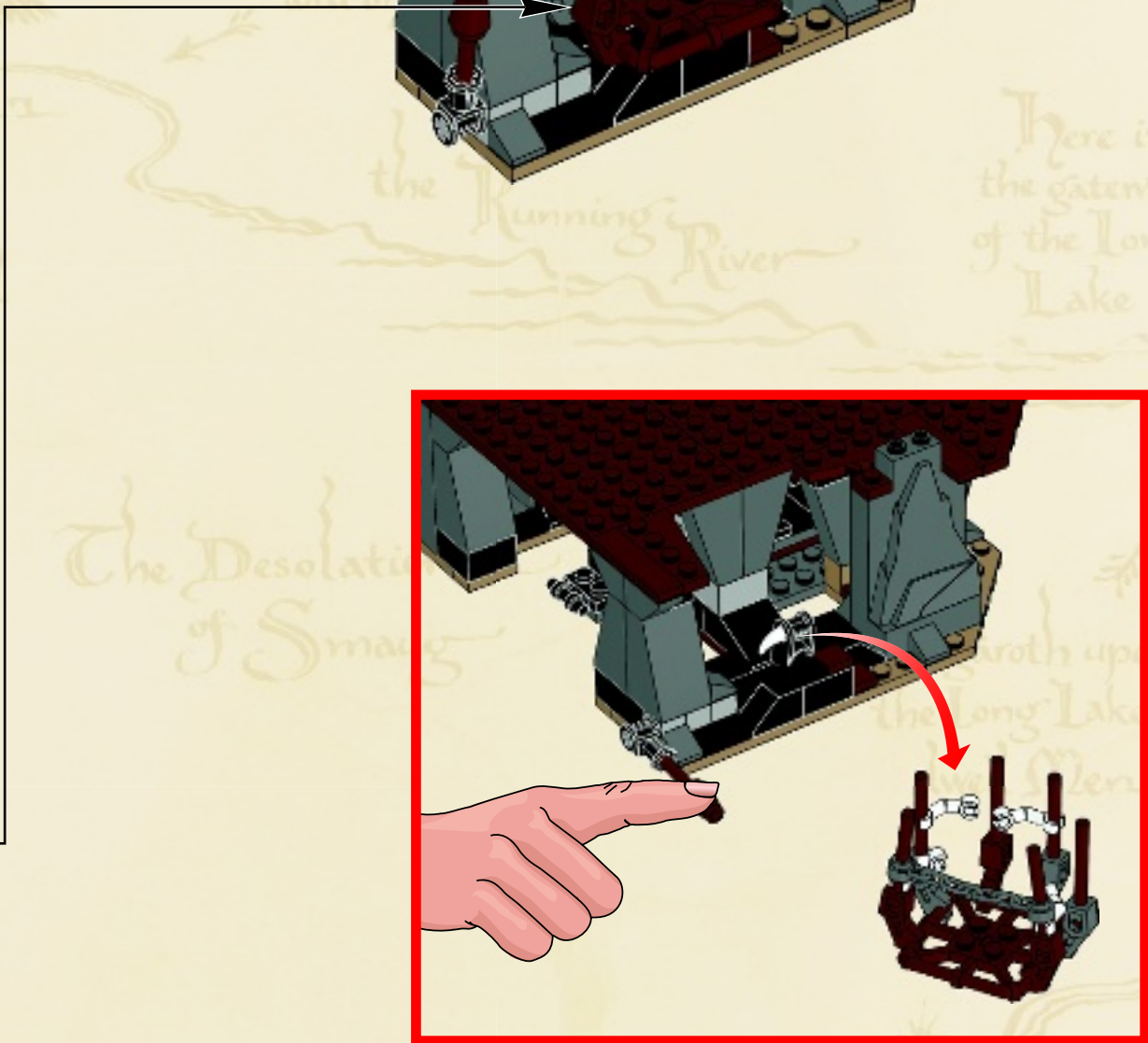
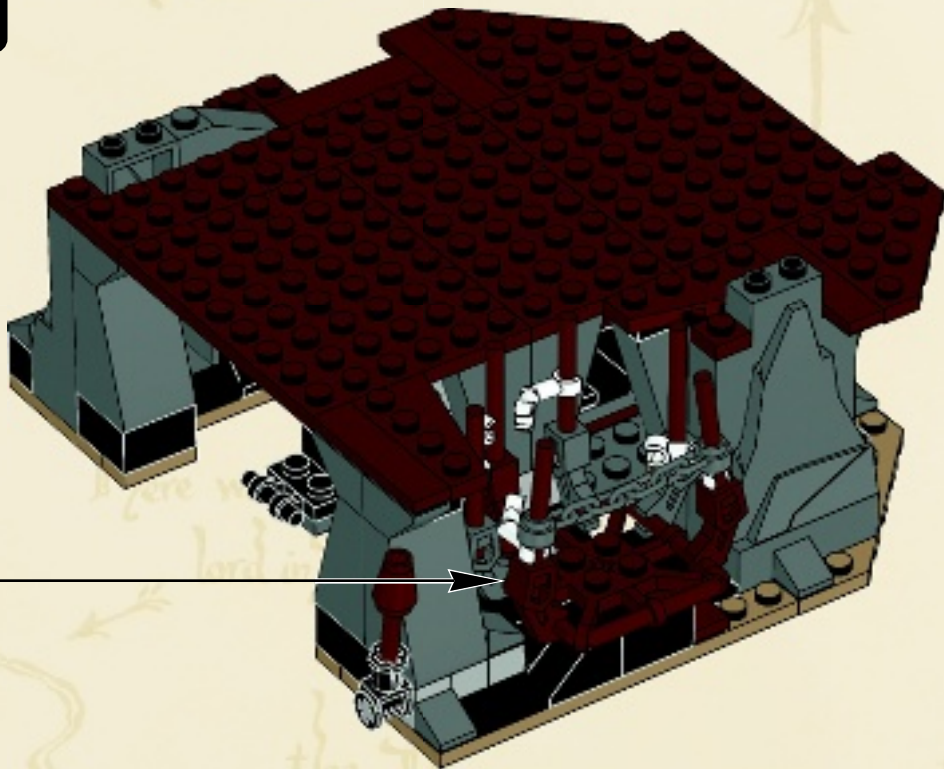

the Running River

Here is
the gateway
of the Long
Lake

The Desolation
of Smaug

Brothup
the Long Lake
Men

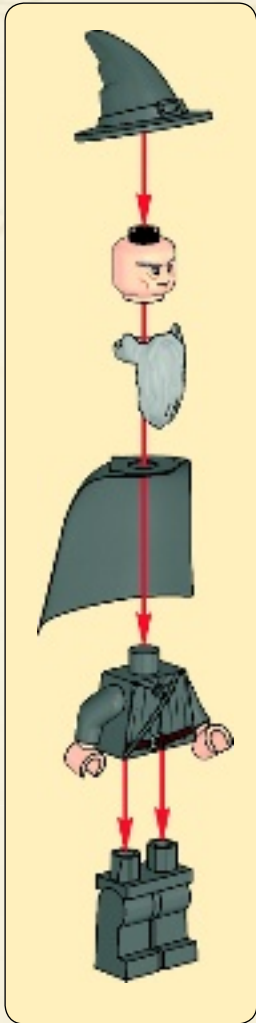
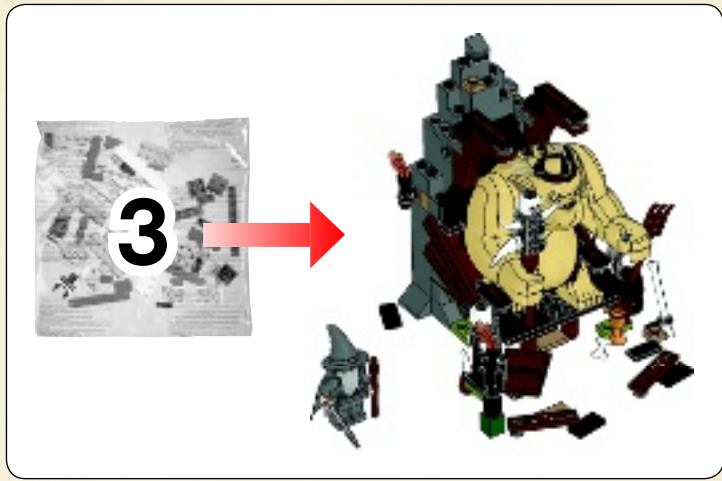

1



2

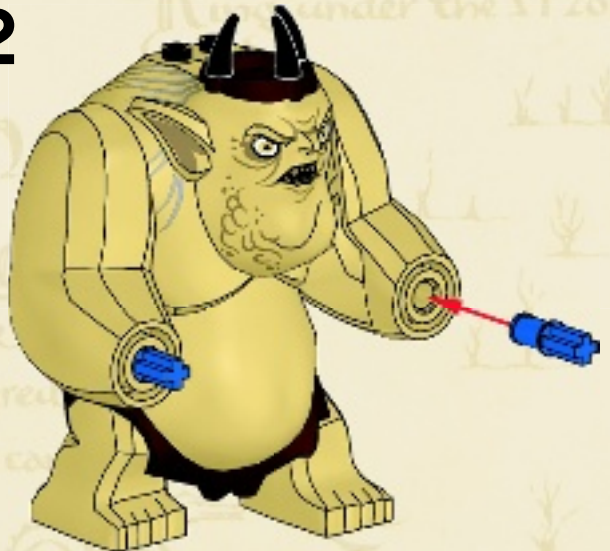



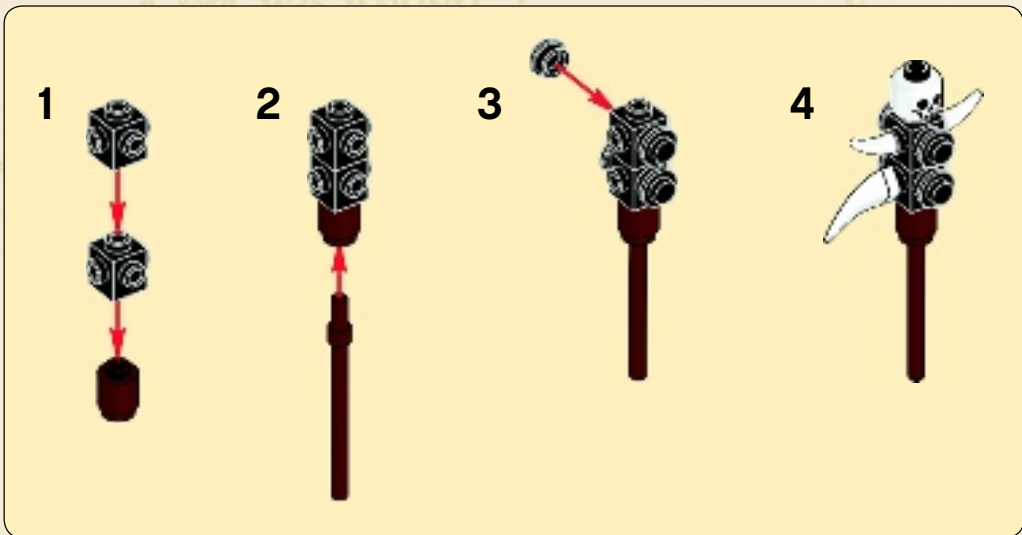

3

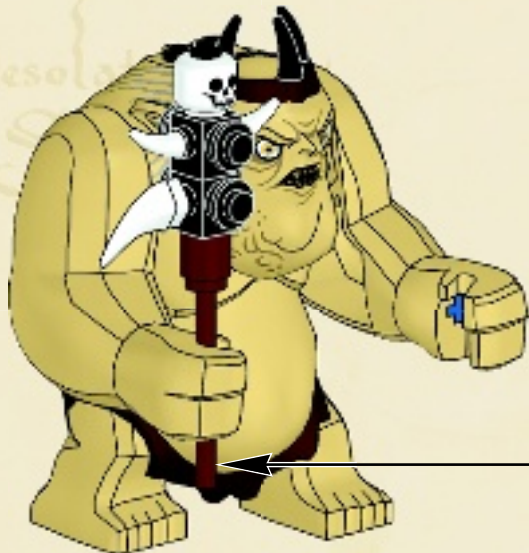

4



 1x	 1x	
 2x	 1x	 1x

47



the Grey Mountains
&
the Withered Heath
whence came the



48

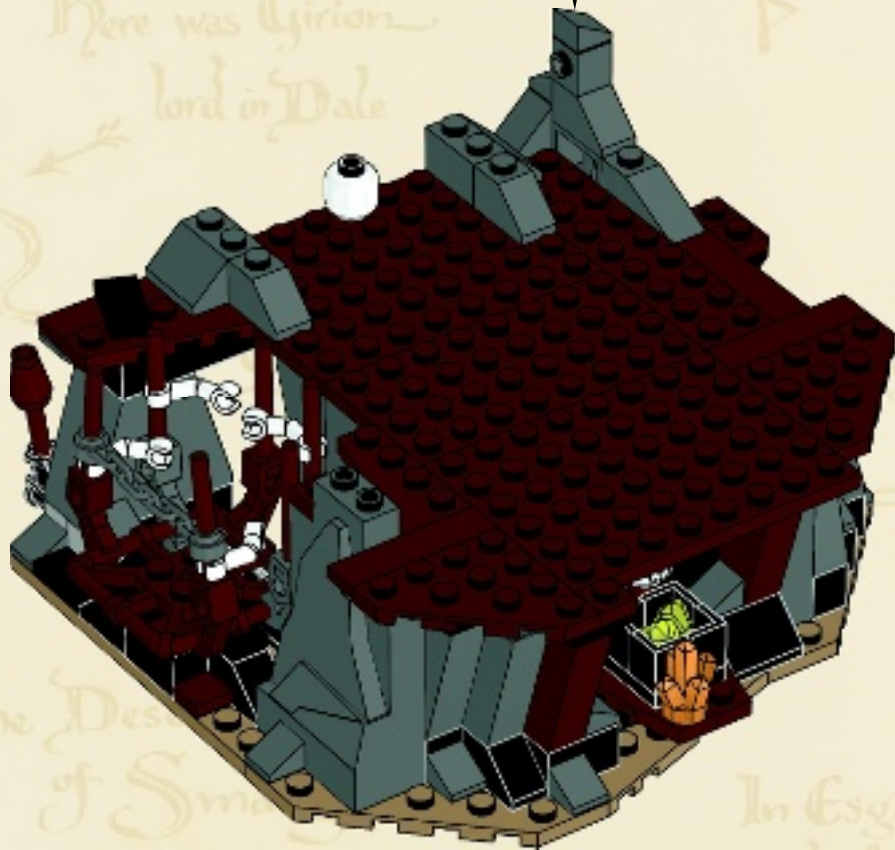
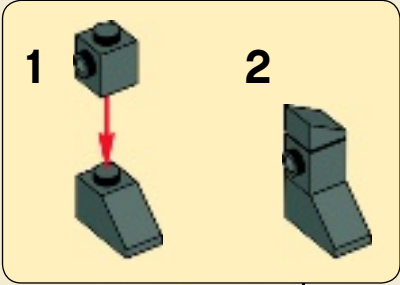

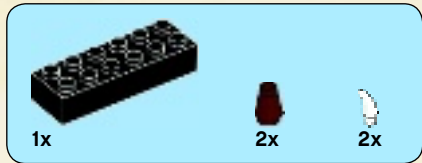

49

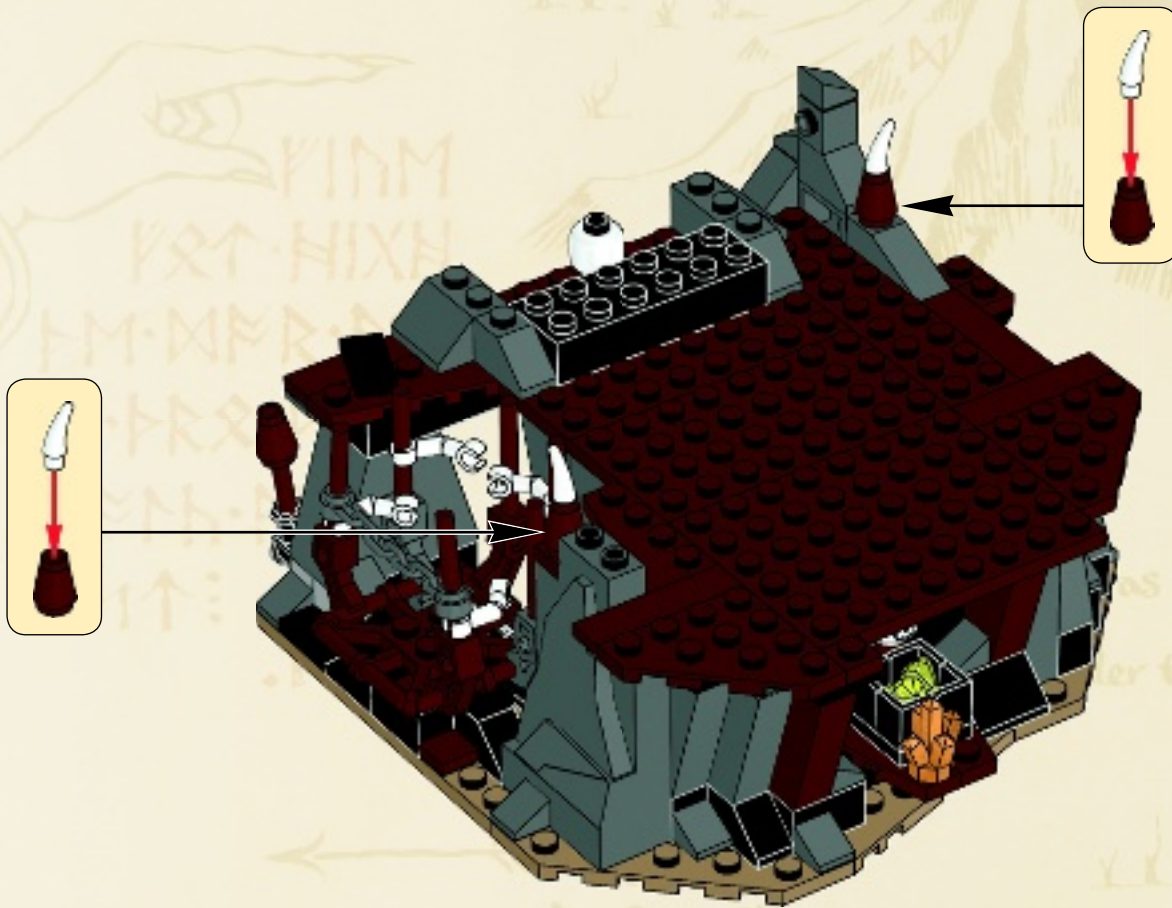



50

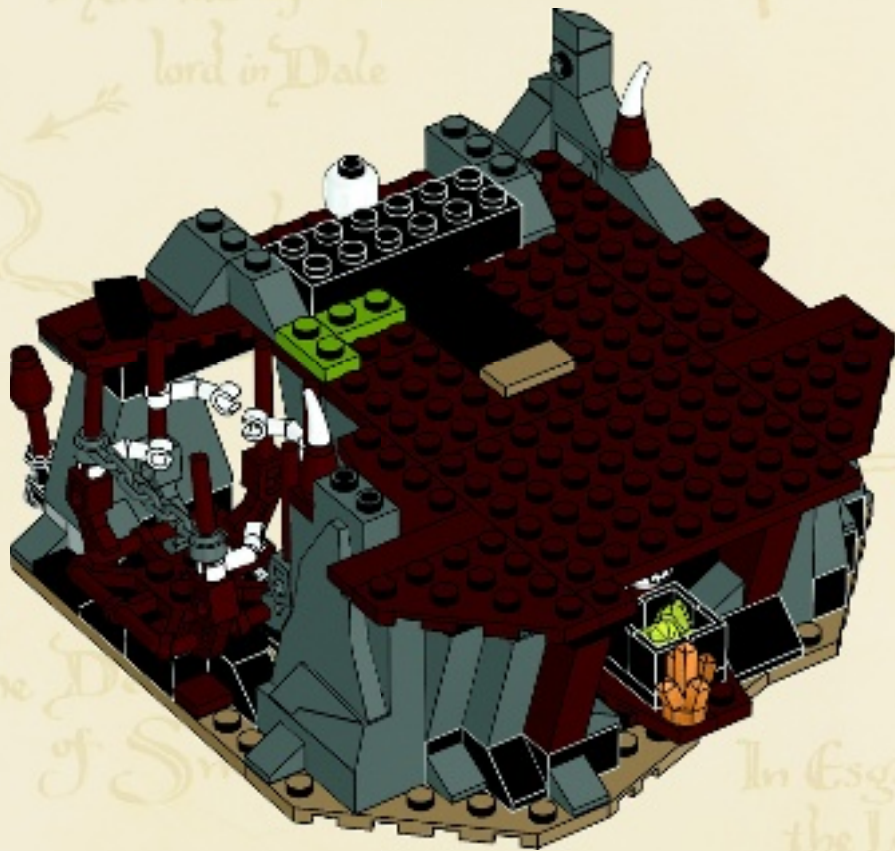

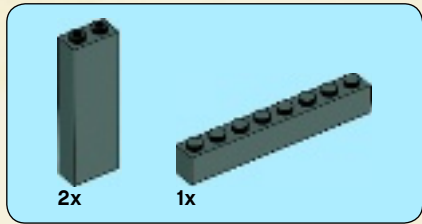

51



The
Lonely
Mountain

was Thror
under the Mountain

the Grey Mountains
&
the Withered Heath
whence came the



2x



2x

52

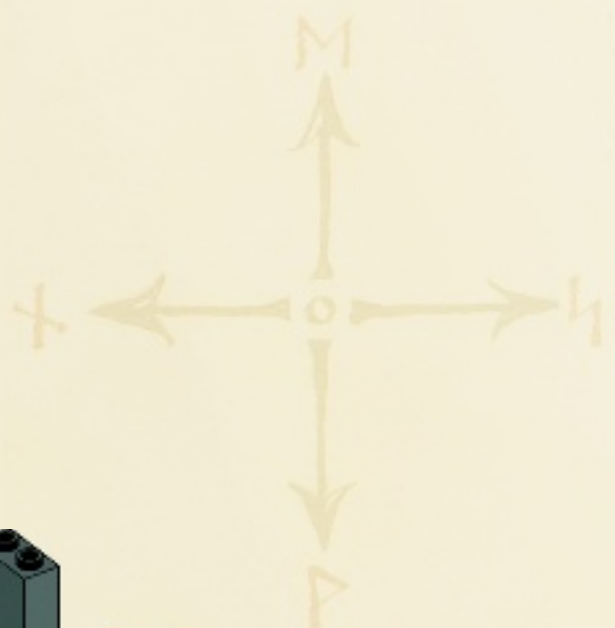
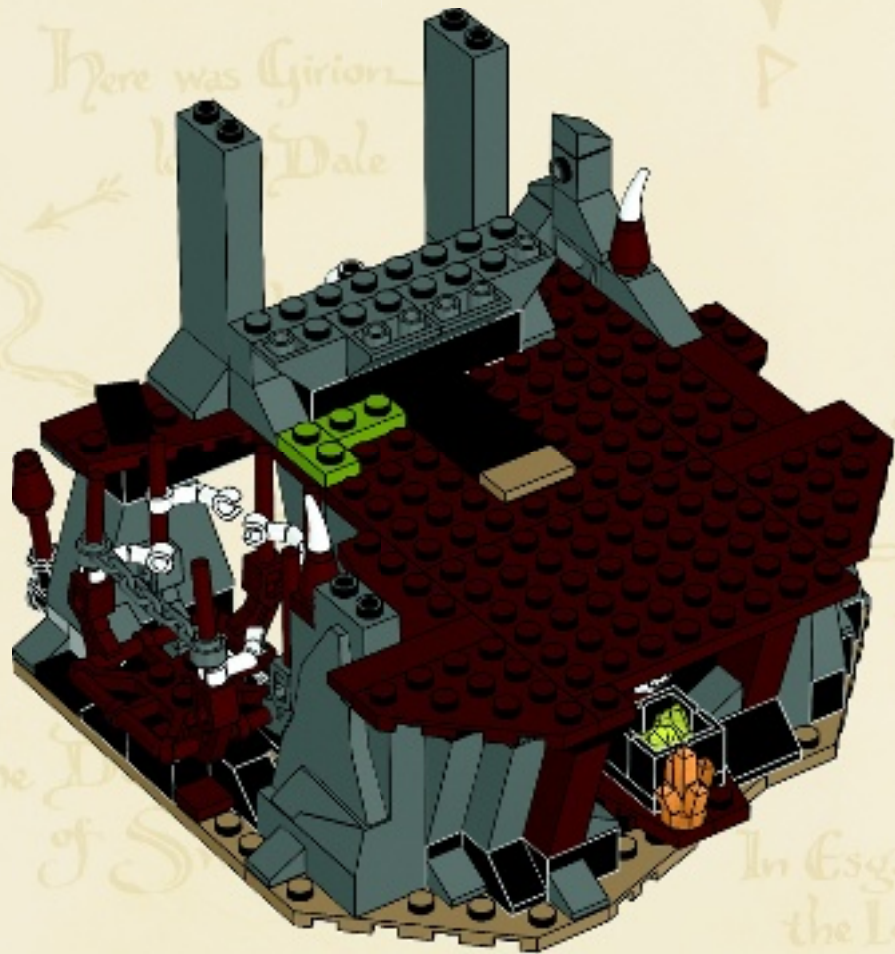

Don Hills
where is Dair

Here was Giron
Dale

Here is
the gateway
of the Long
Lake

The D
of S

In Esgaroth upon
the Long Lake
dwell Men



2x



1x

53



*the Grey Mountains
&
the Withered Heath
whence came the*



2x

54

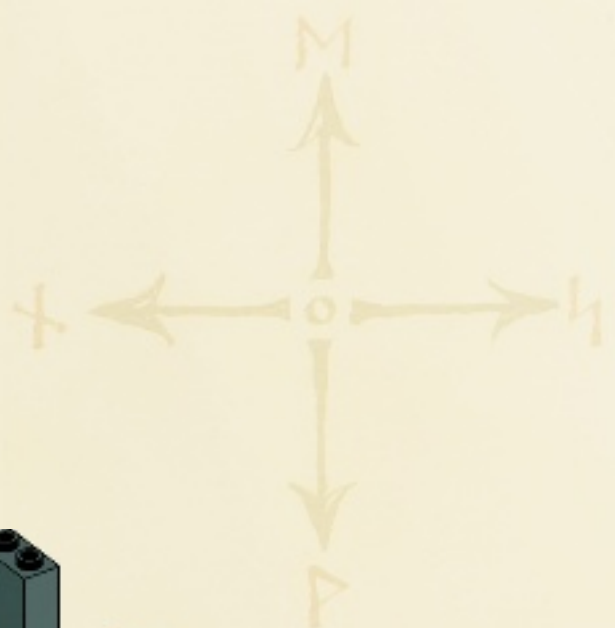

*on Hills
where is Dair
Here was Giron
Dale
Here is
the gateway
of the Long
Lake
In Esgaroth upon
the Long Lake
dwell Men*

2x 2x 4x

55

1 2 3

2x

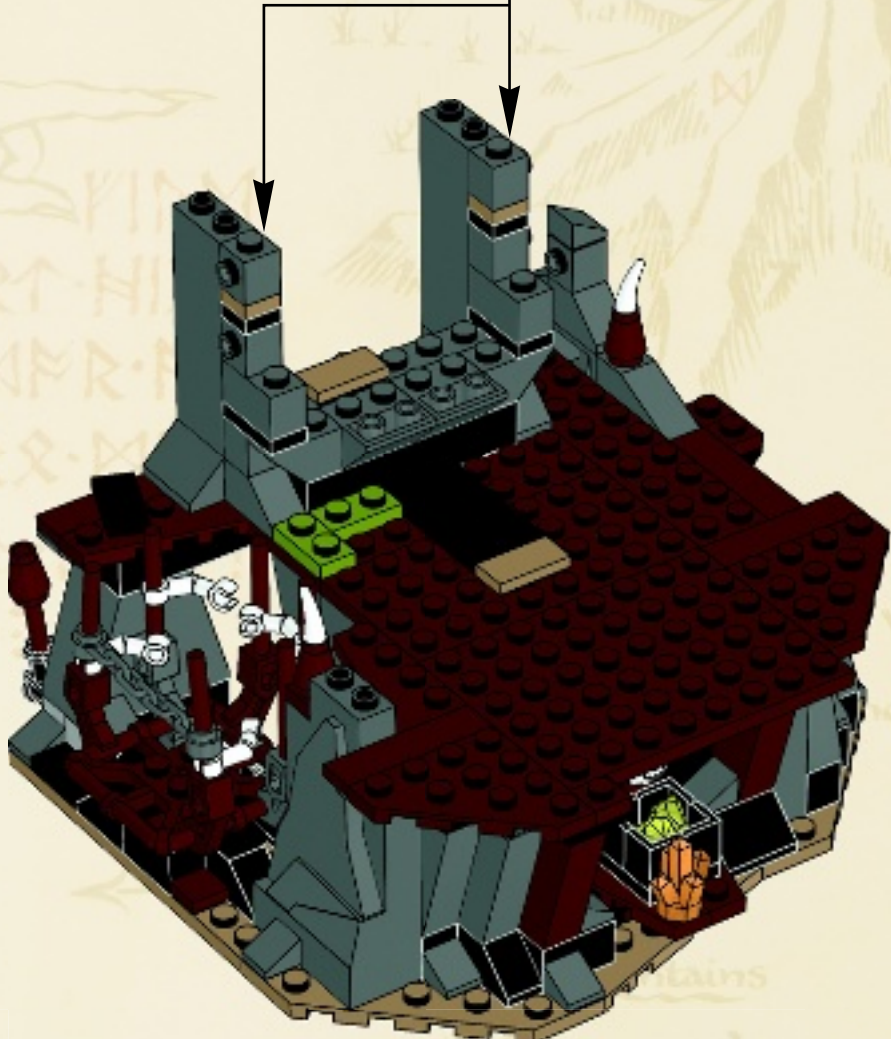



2x



2x



2x

56

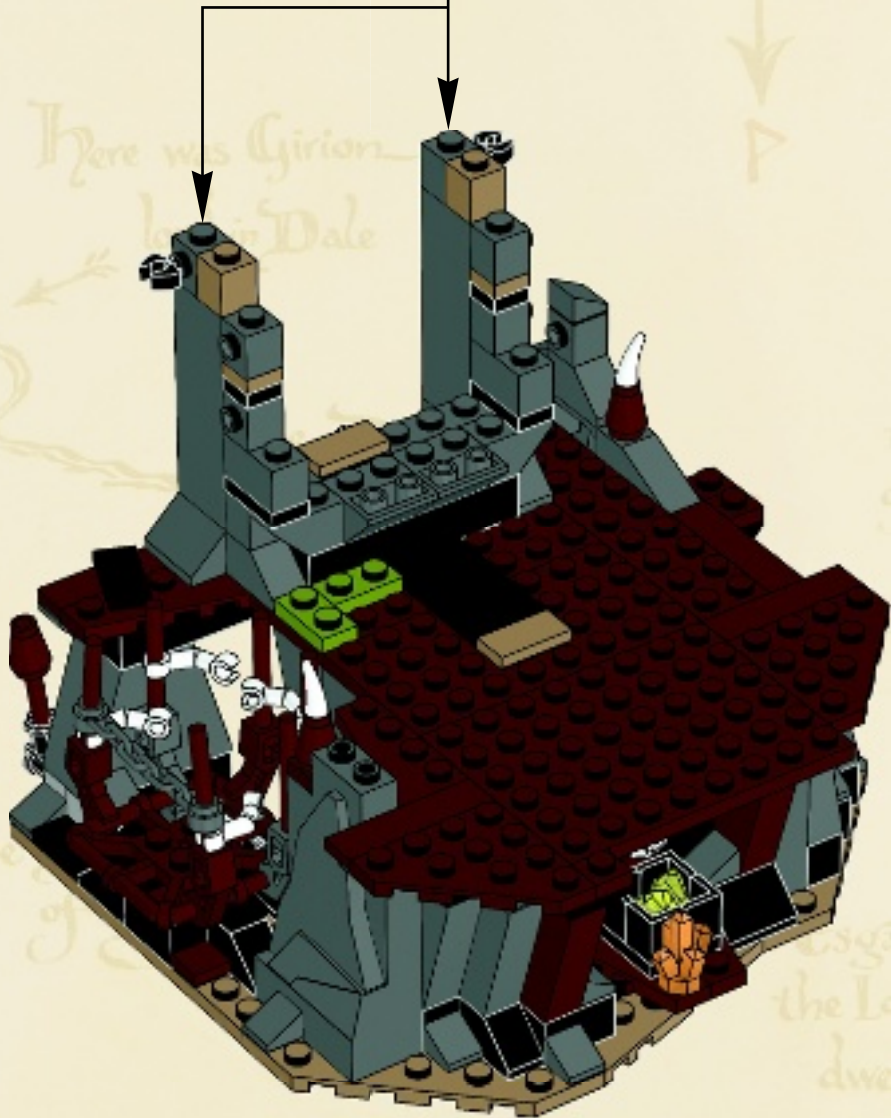
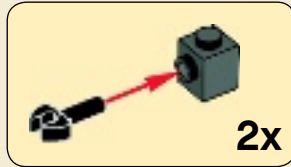

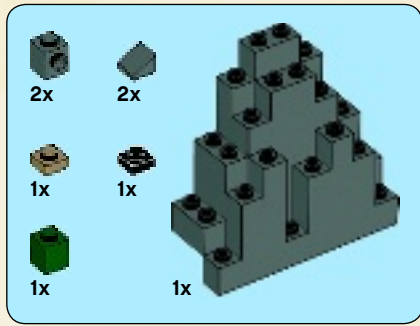

57

1

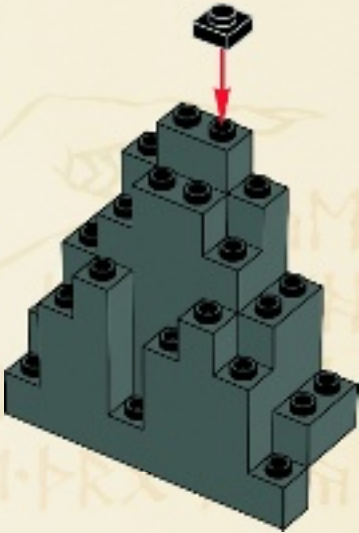

3

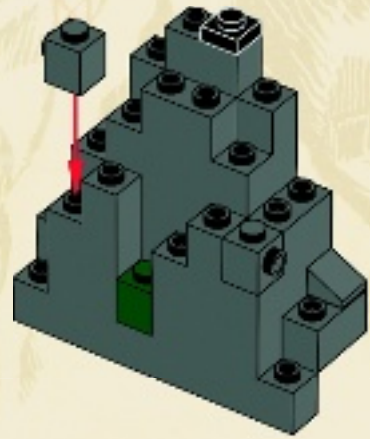

2

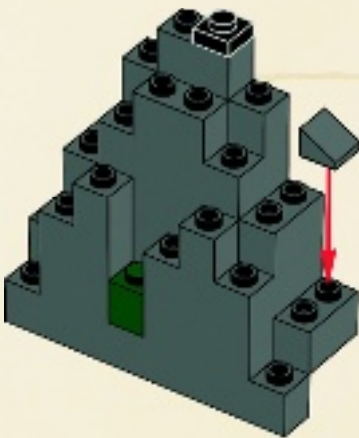

4

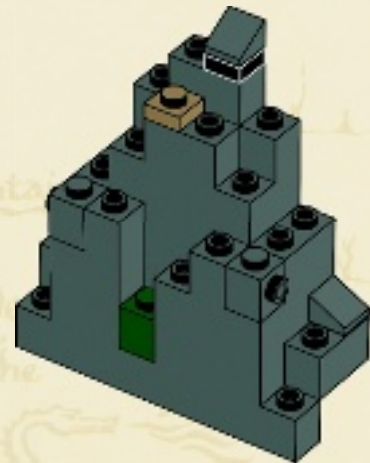

↑ East lie the Iron Hills
where is Dain



Here was the
lord in

Here is
the gateway
of the Long
Lake

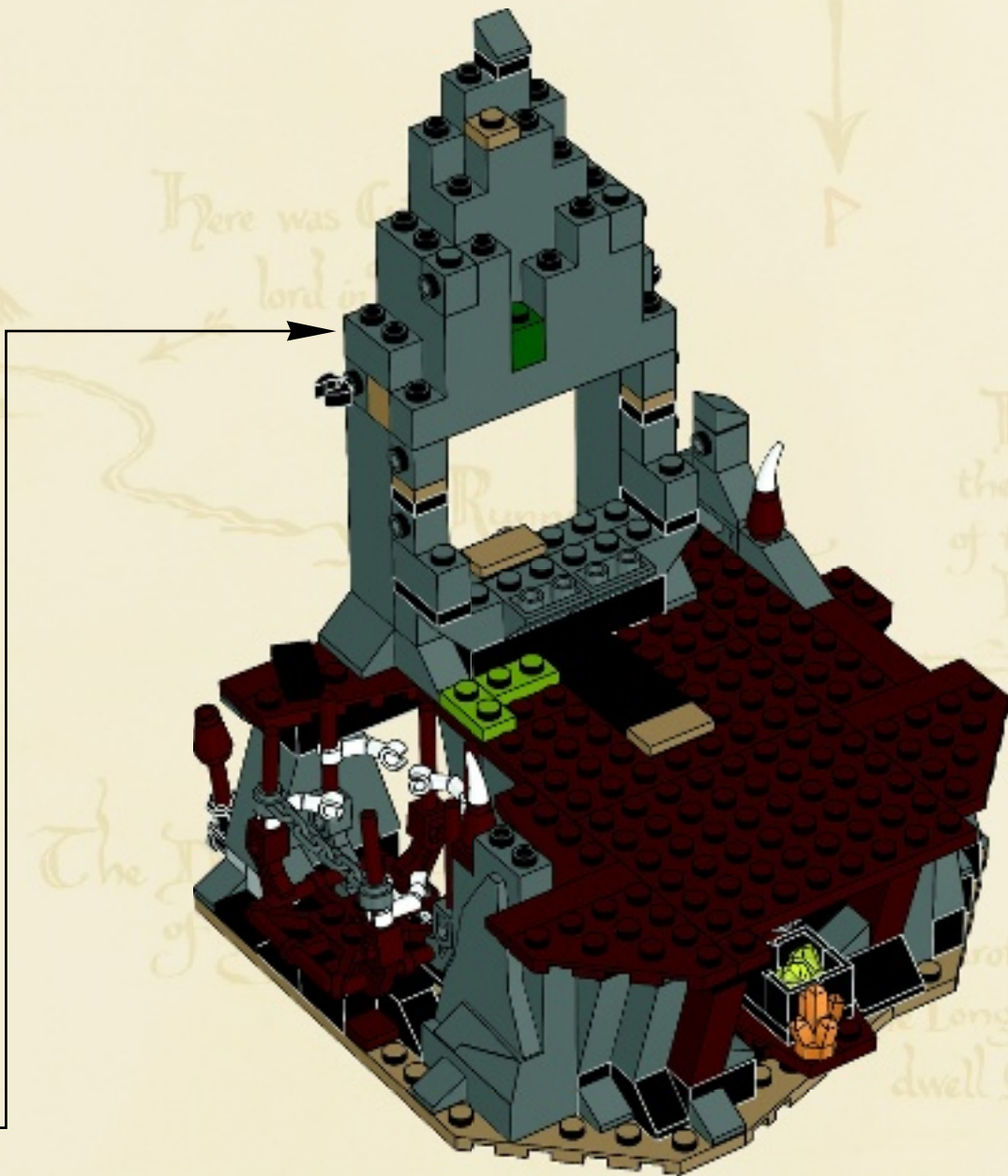



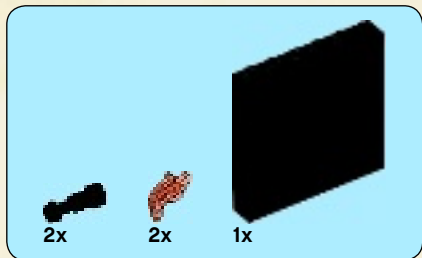

The J
of

roth upon
Long Lake
dwell Men

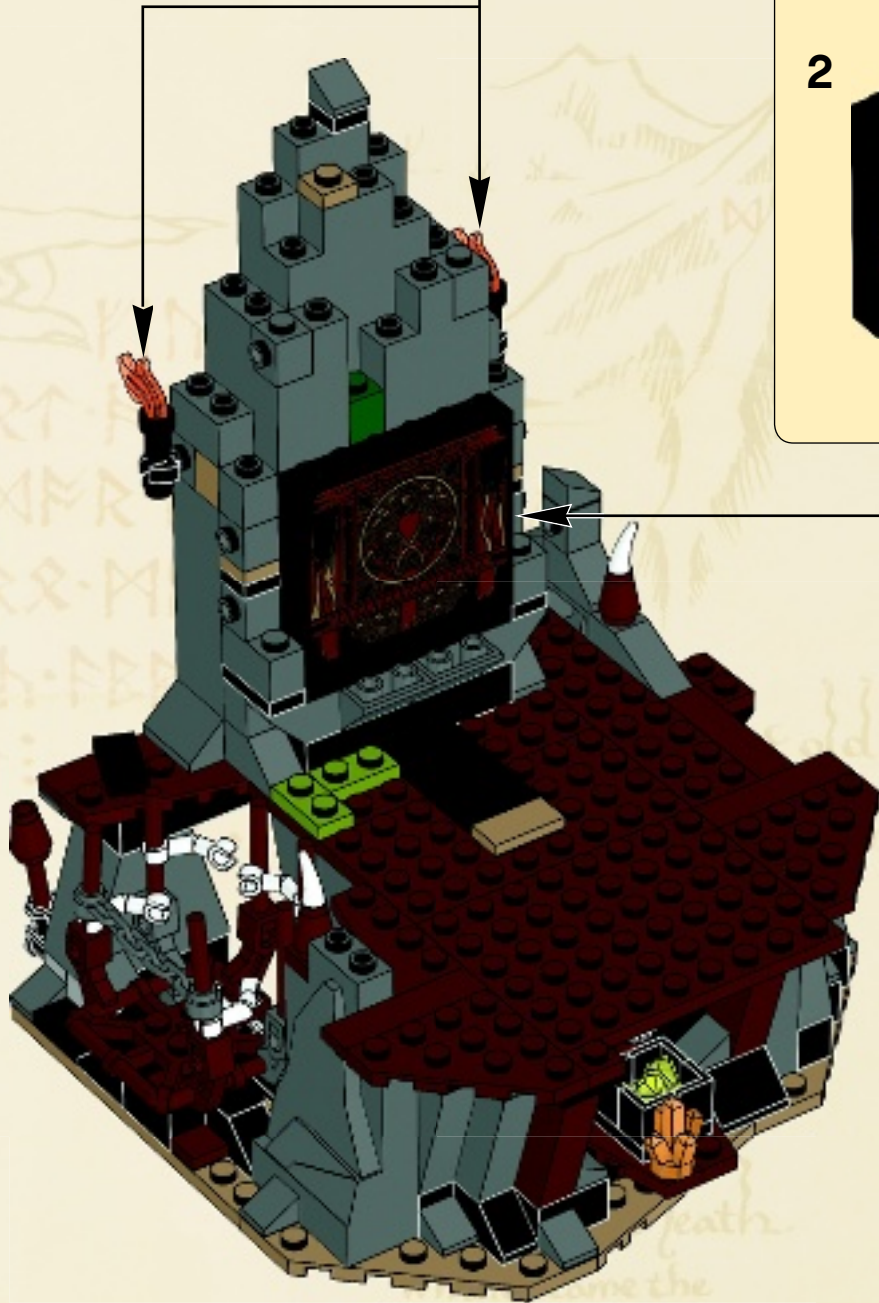
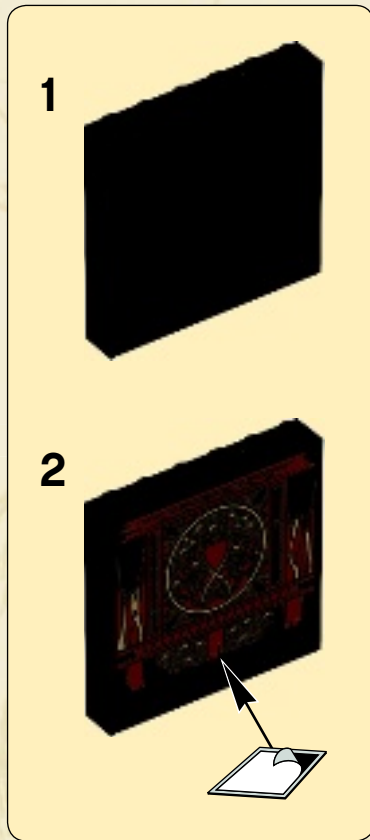
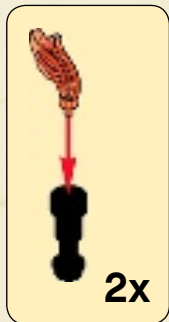

58



- 1x 
- 1x 
- 1x 
- 1x 

59

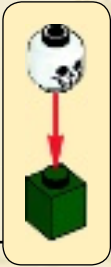
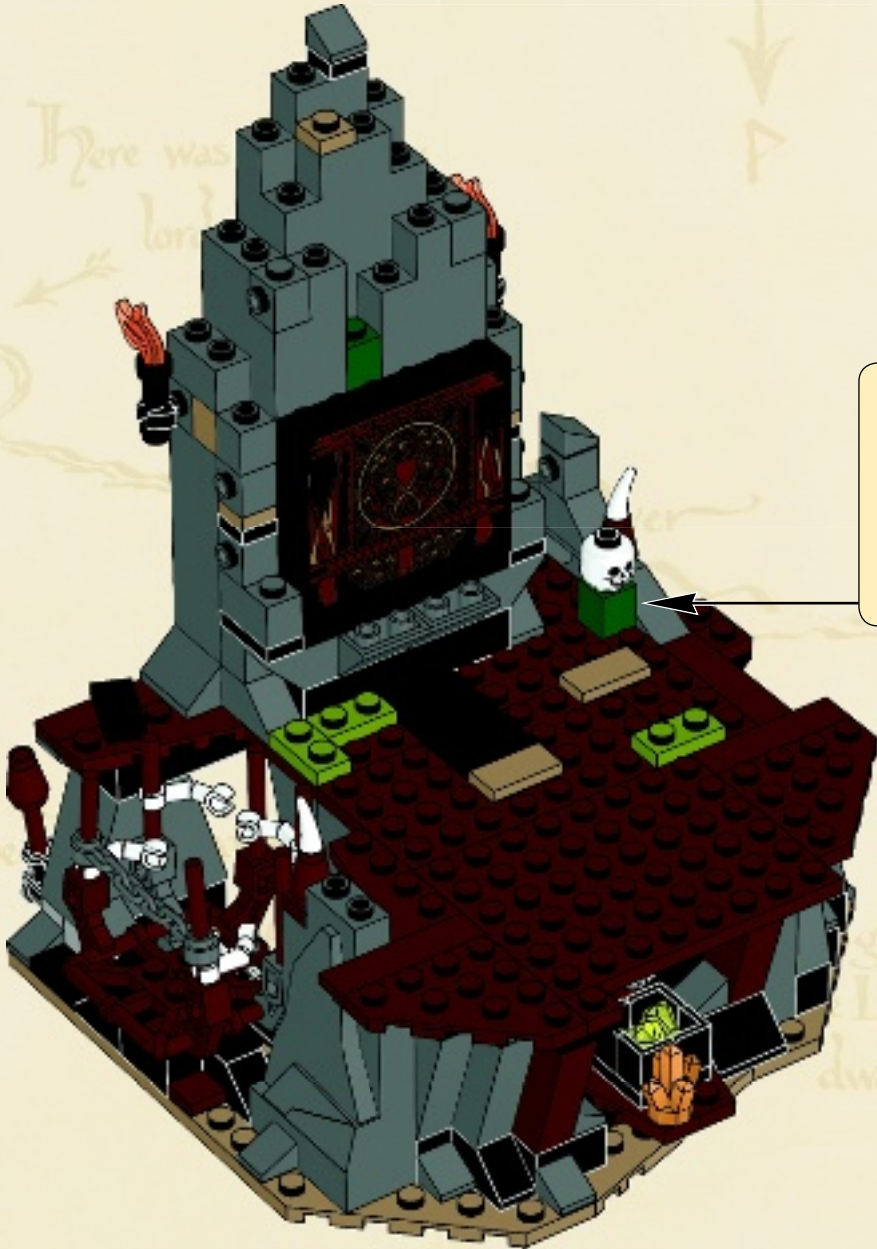



2x



4x

60

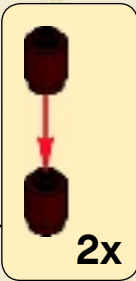
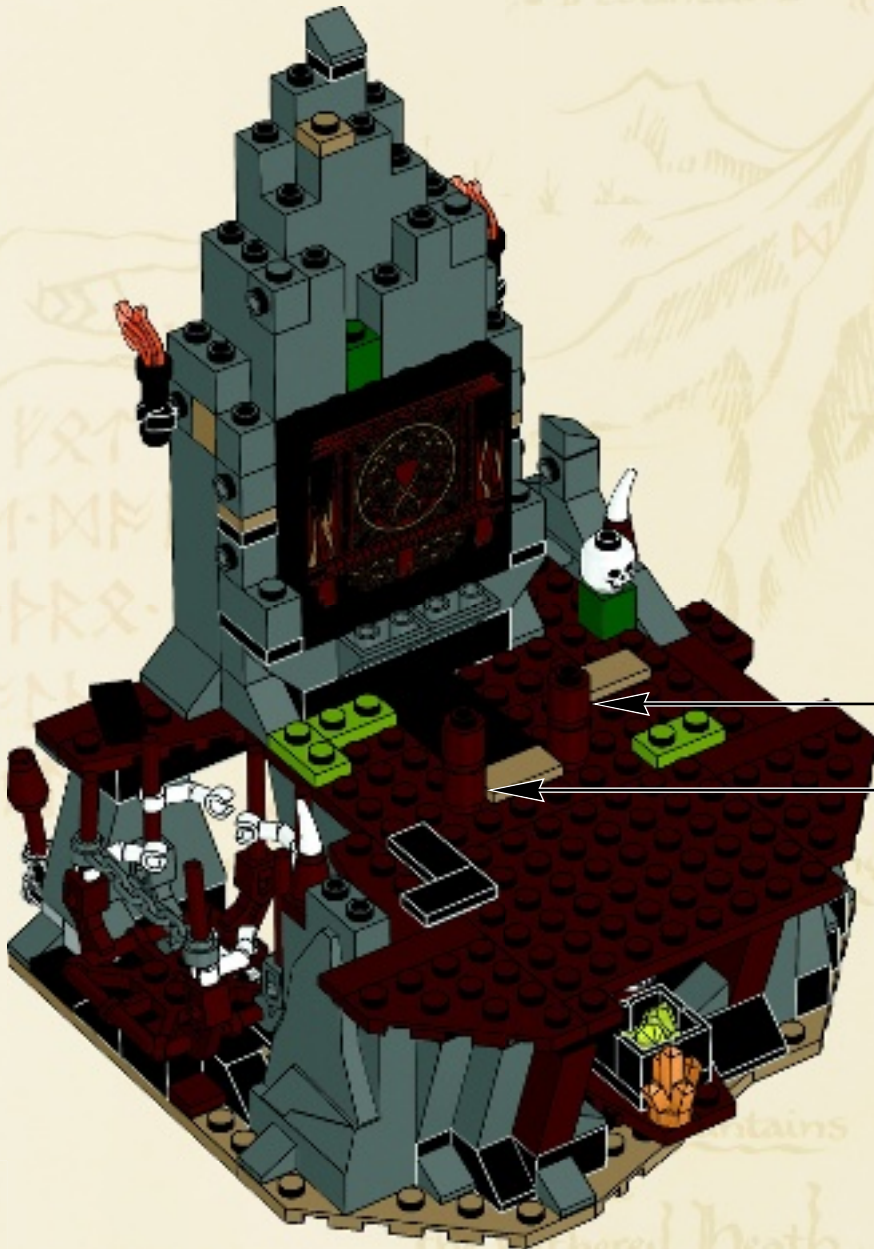

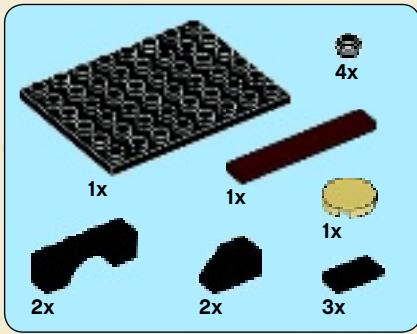

61

1



2

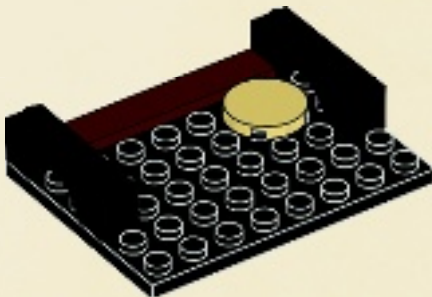

3

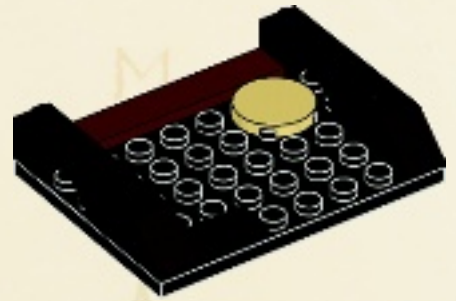

4



5

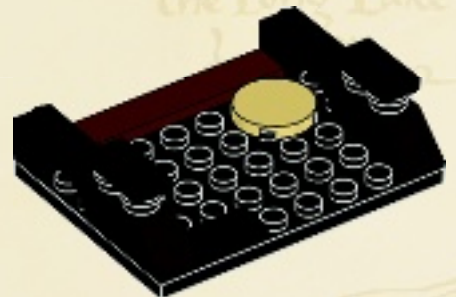

6

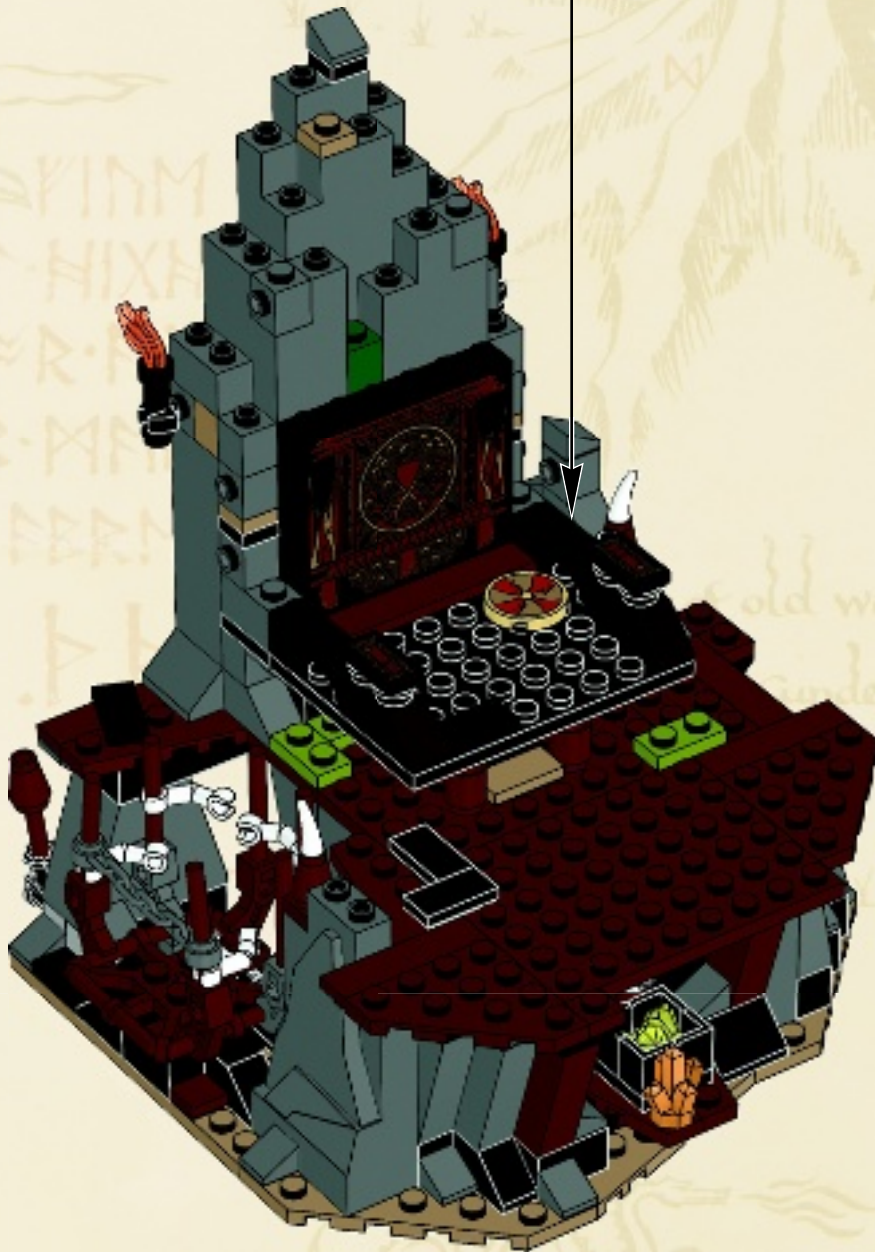
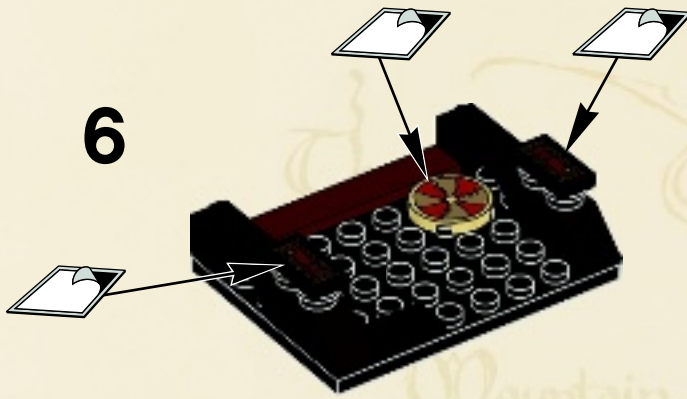



62

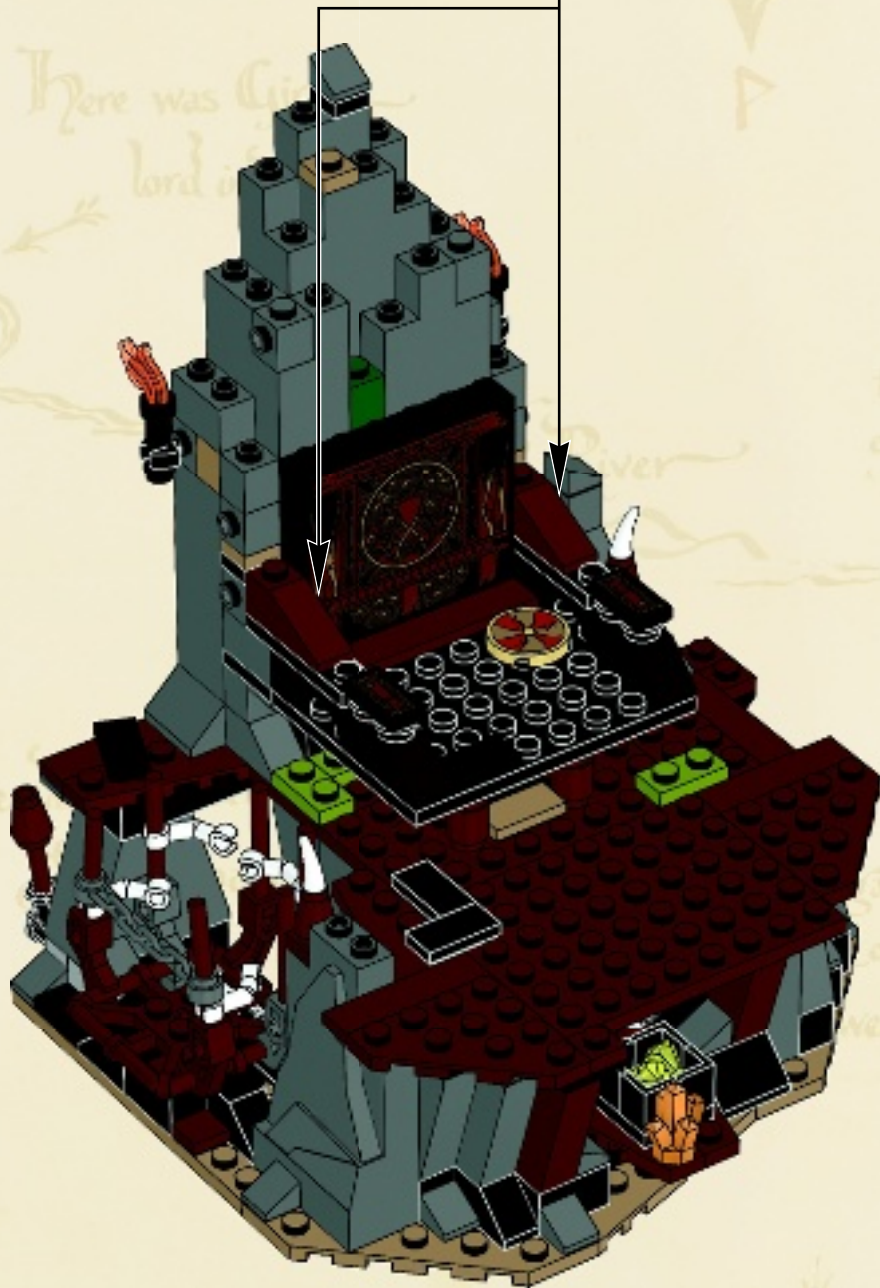
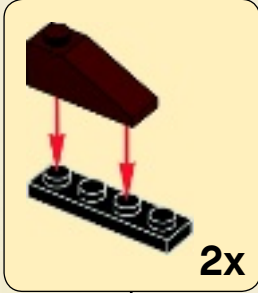

2x 4x

63

1 2

2x

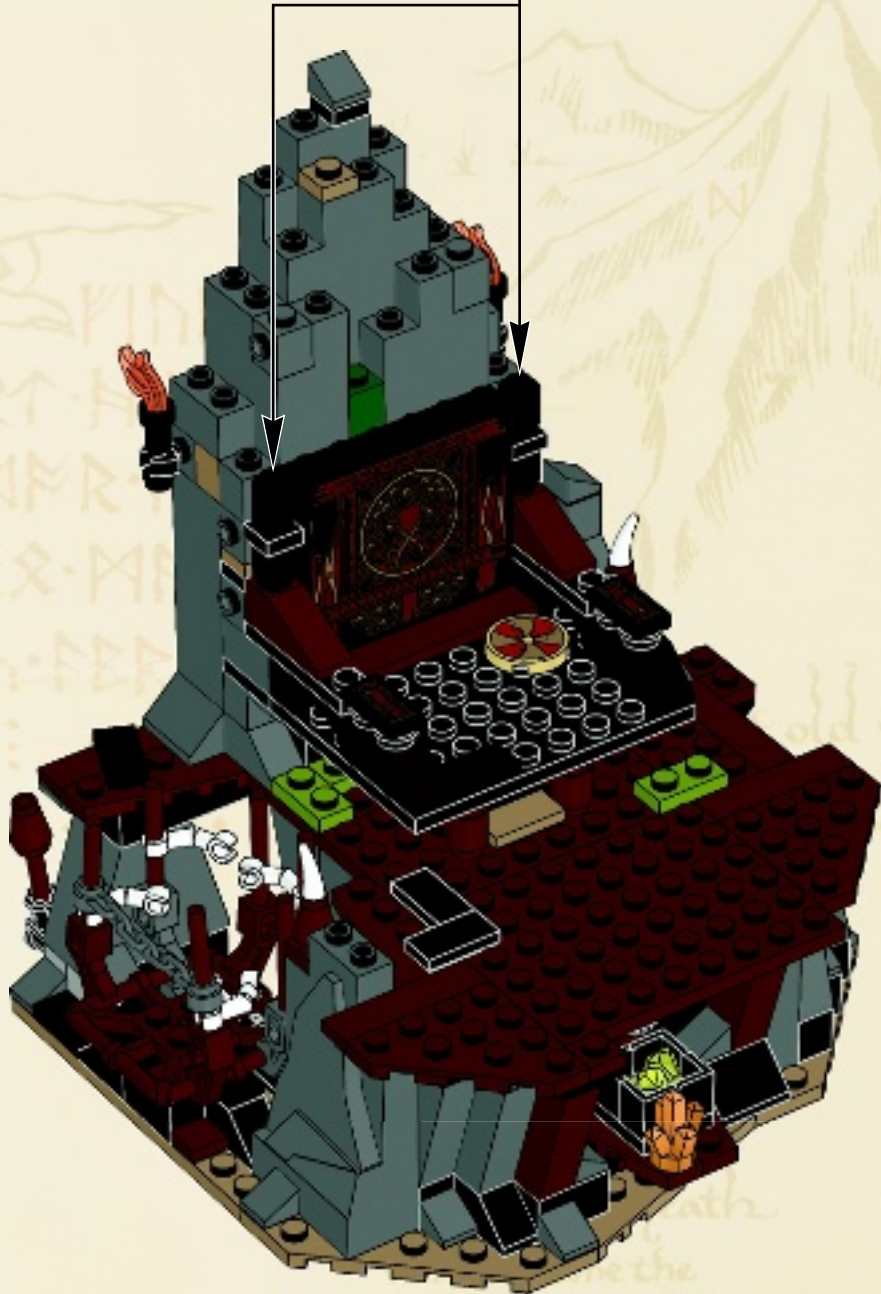

2x

2x

64





2x



1x

65

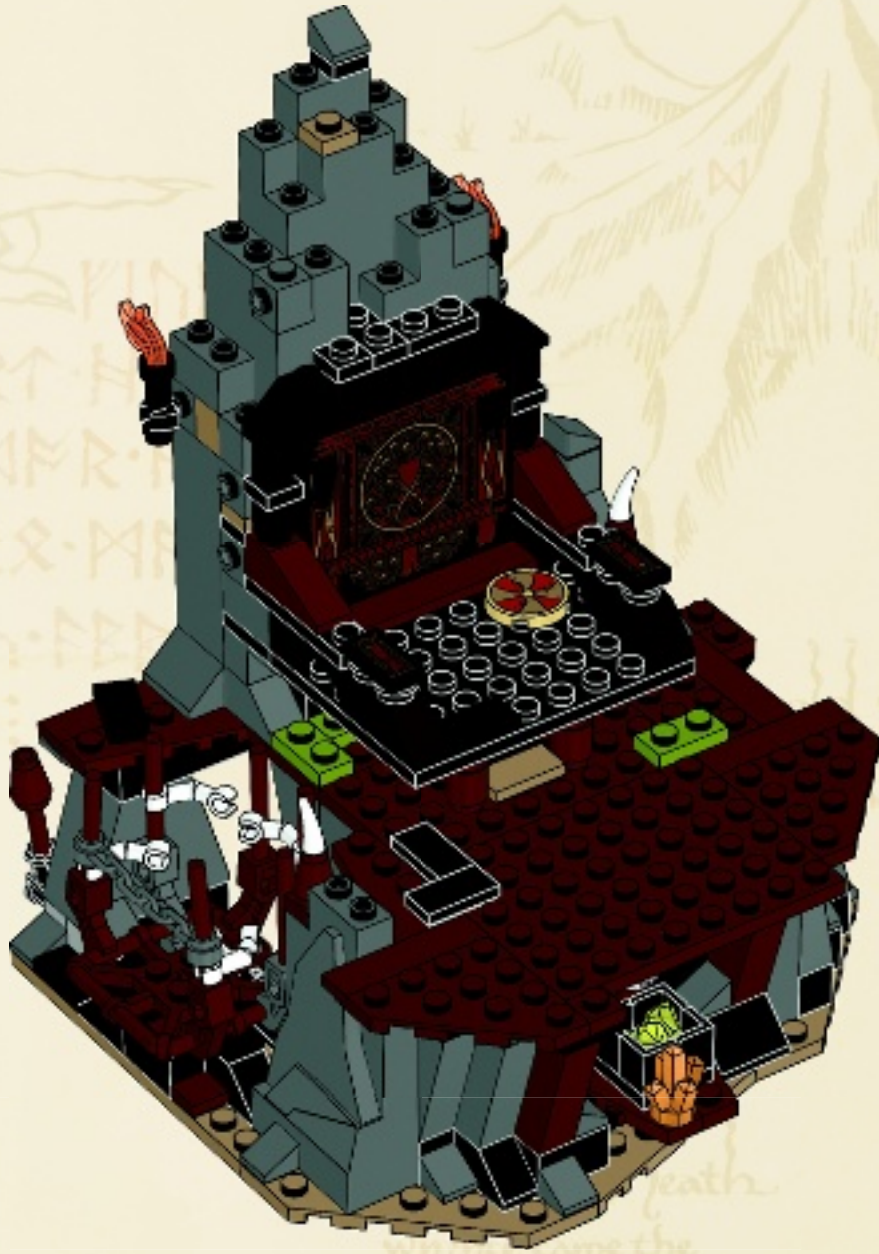

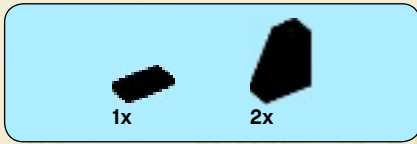

66



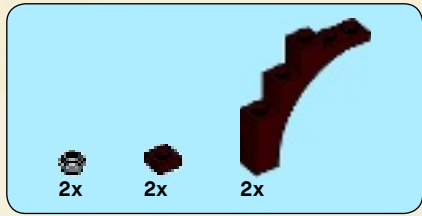

67

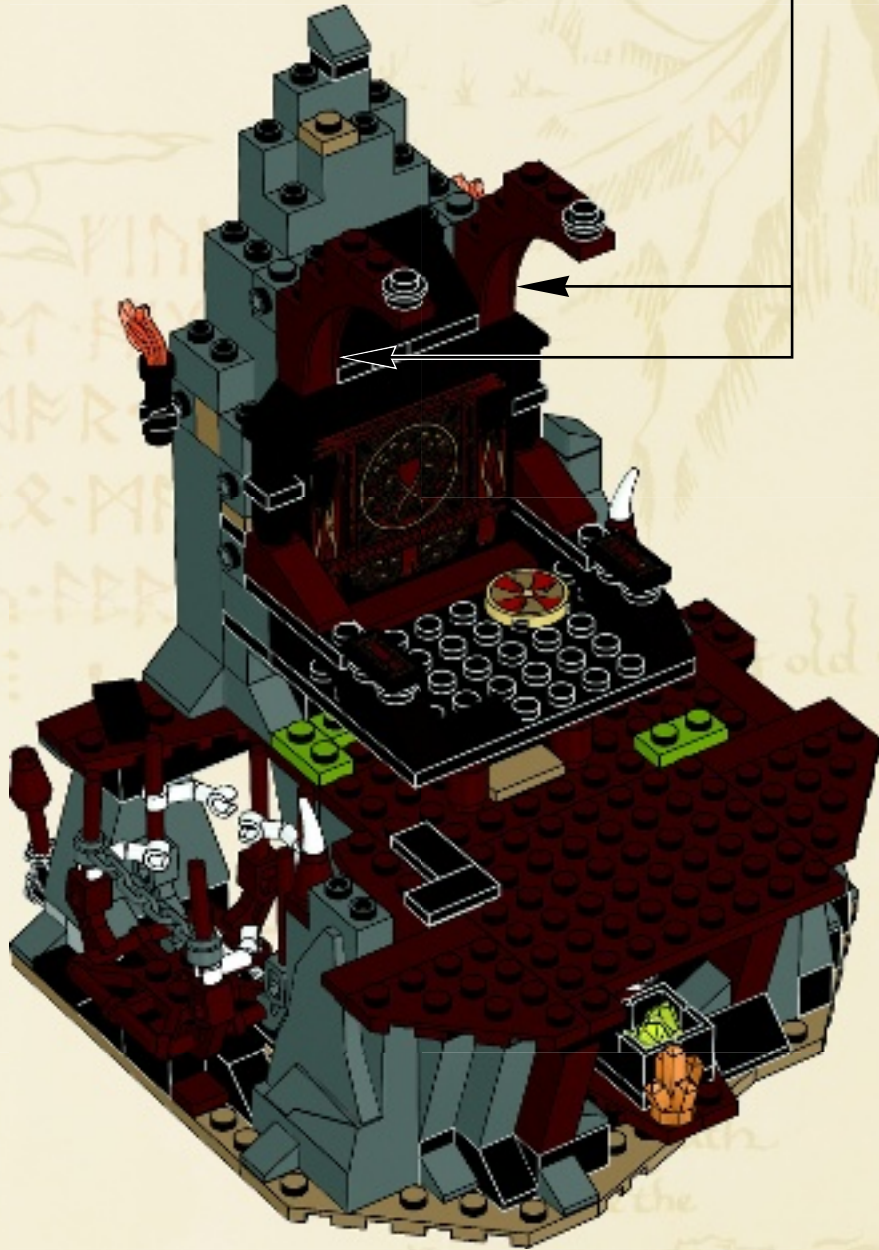
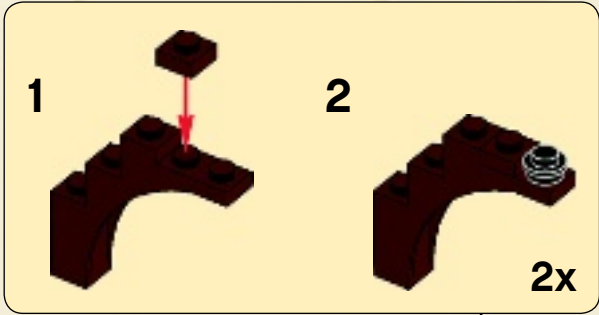

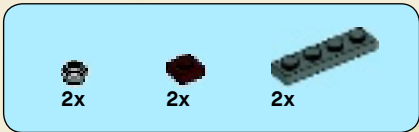

68

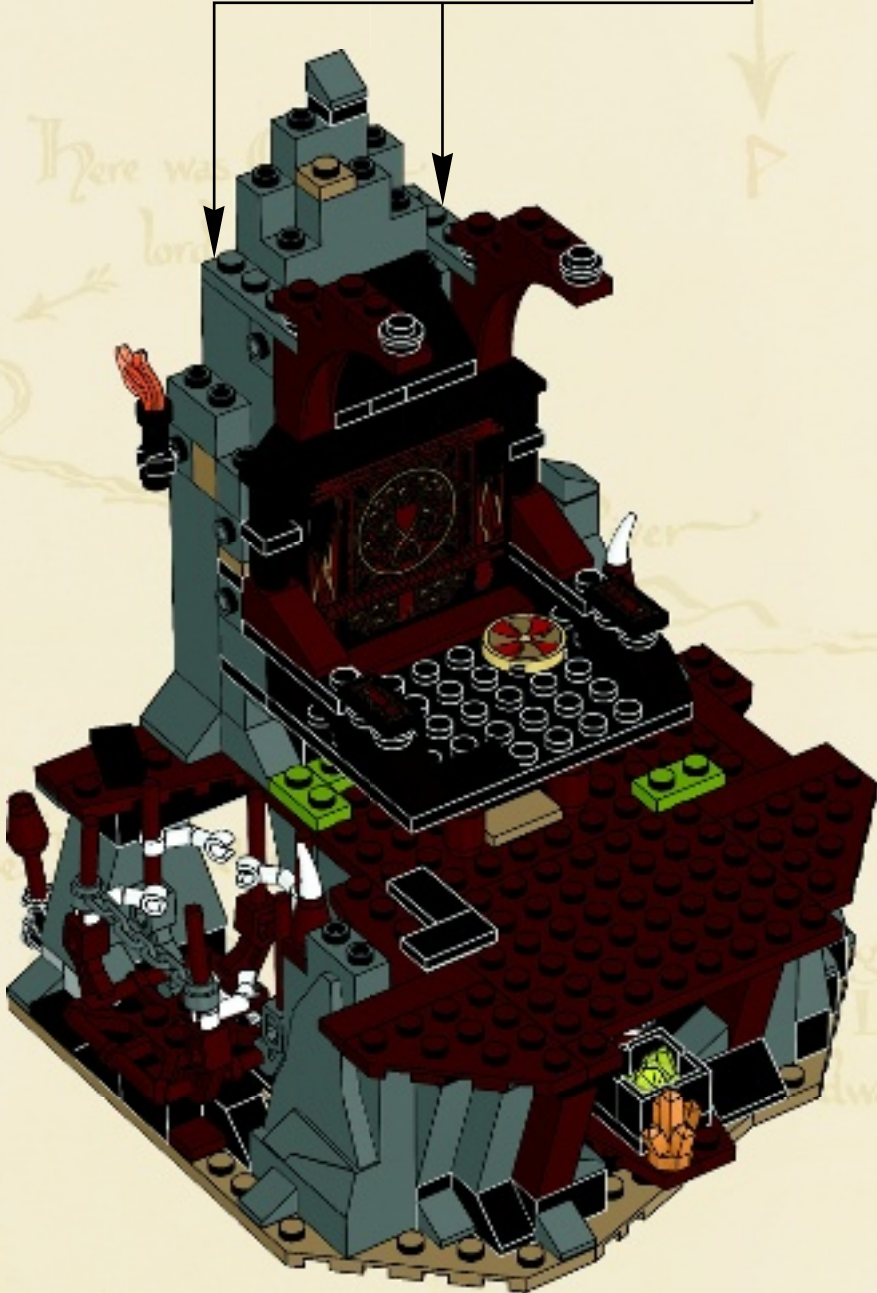
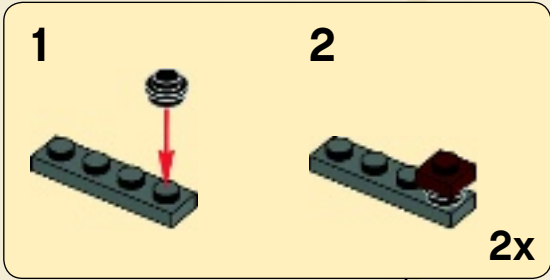

 1x	 1x	 2x
--	--	--

69

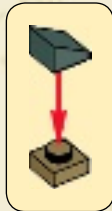

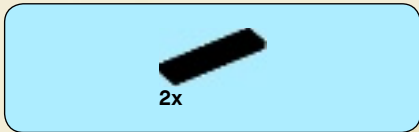

70

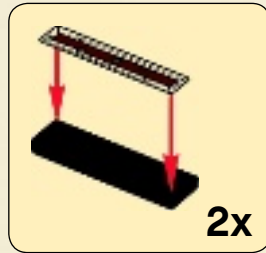

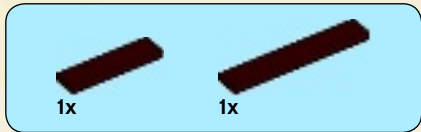

71

The
Lonely
Mountain

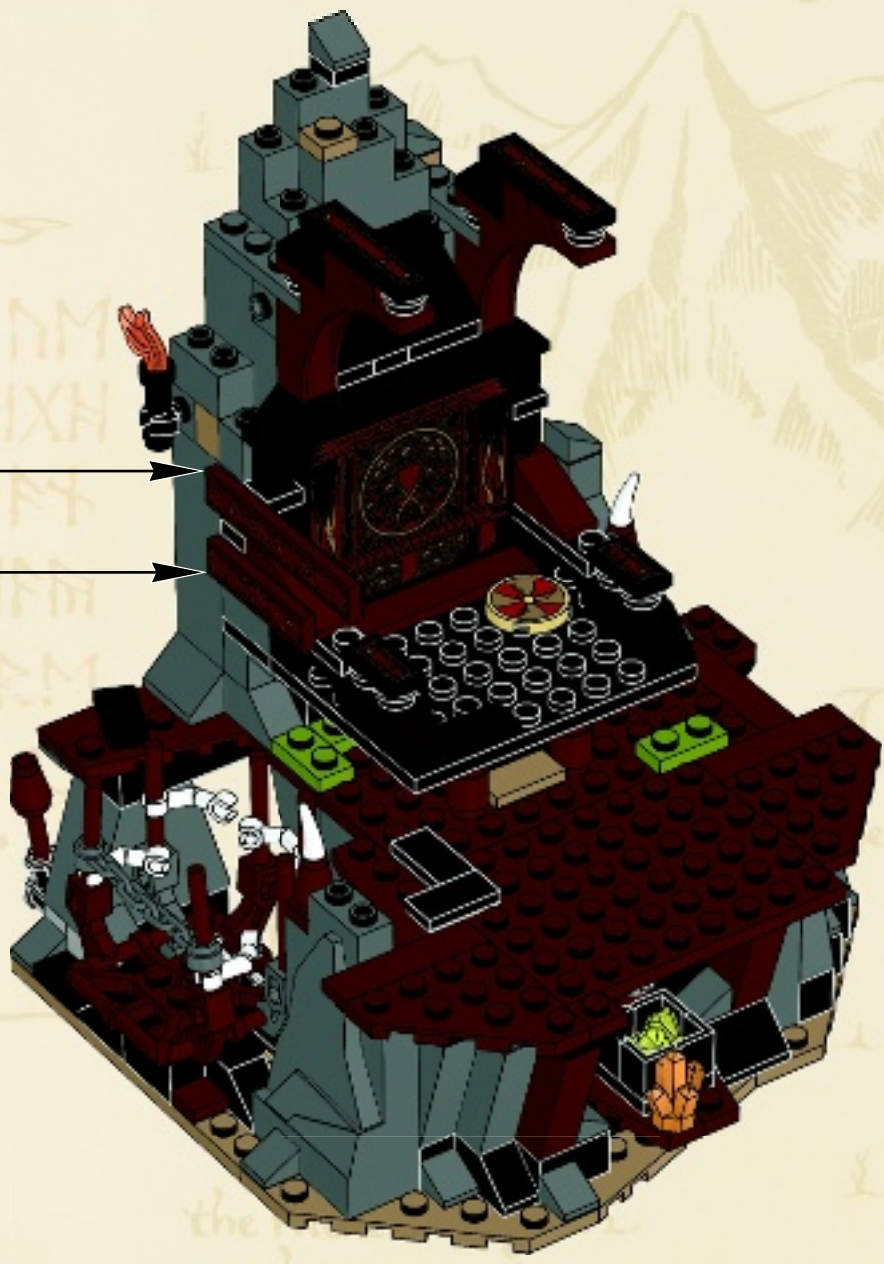
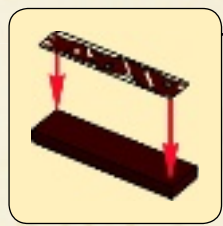
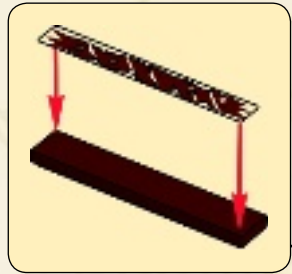

Horror
Mountain

the
whence came the

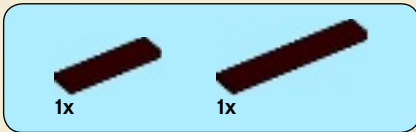

72

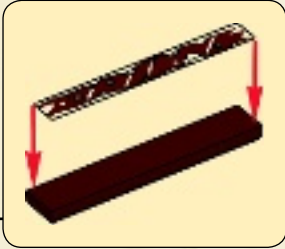
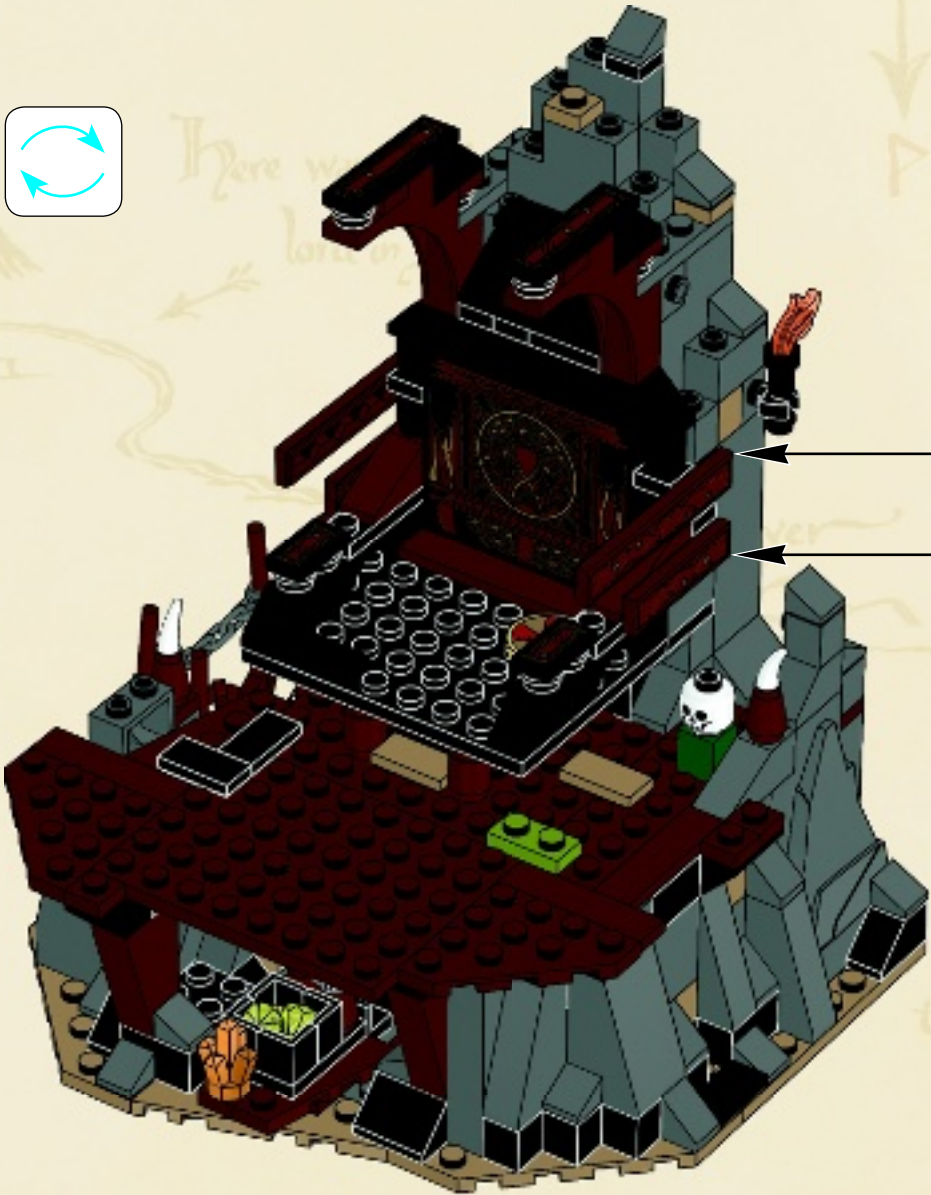
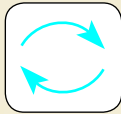



1x



1x

73

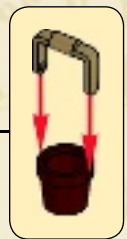
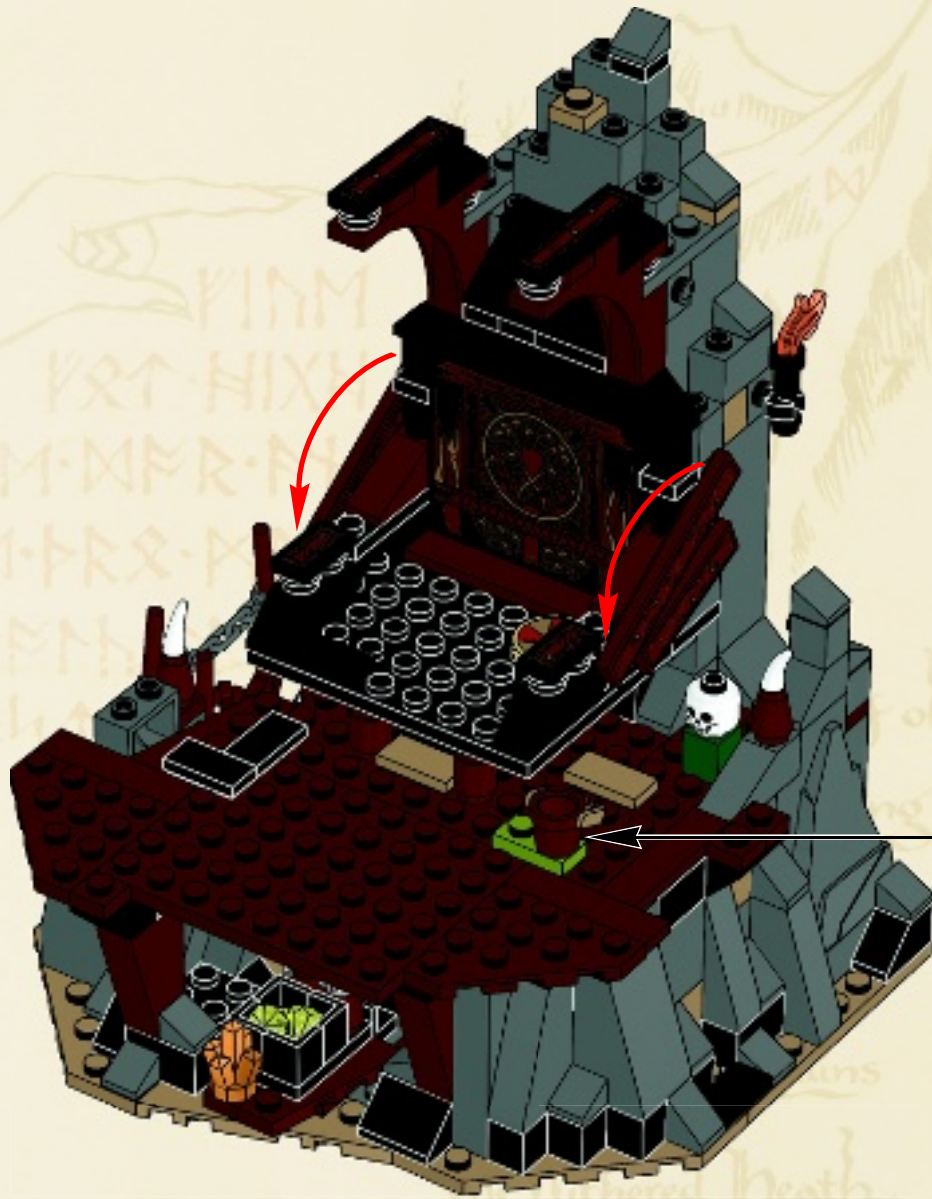



74



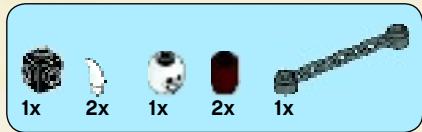

75

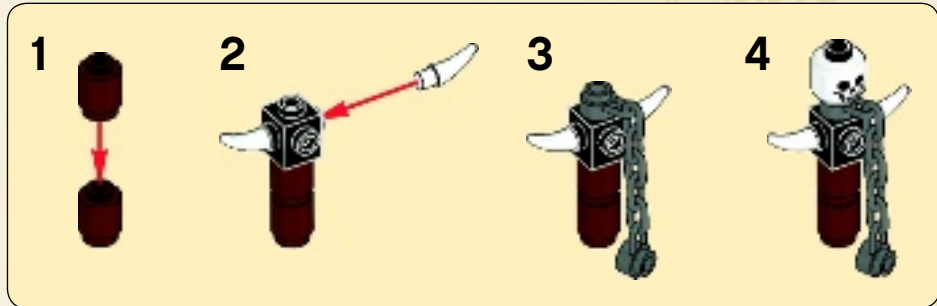

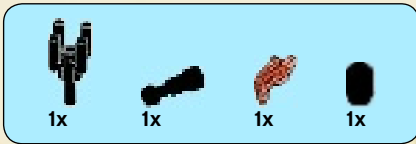

76

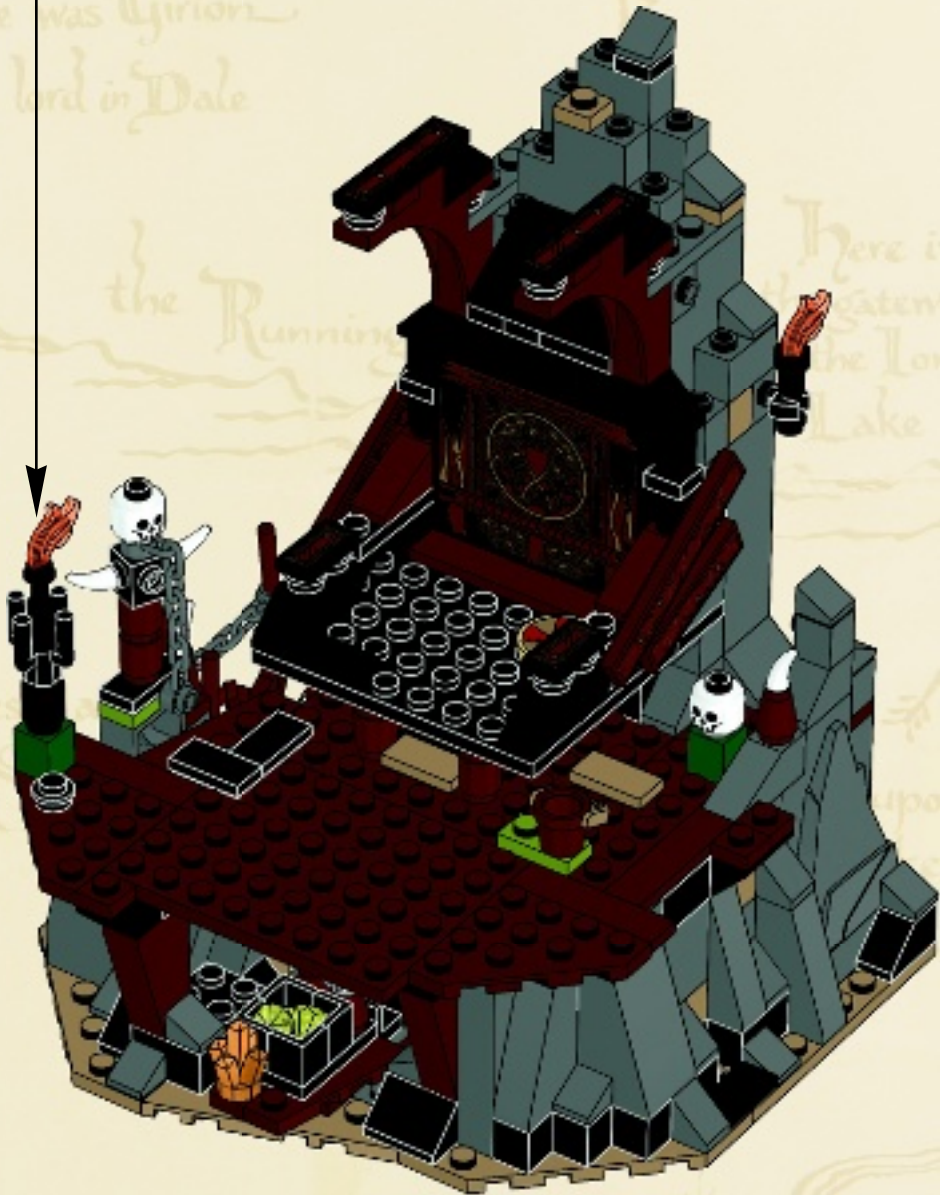
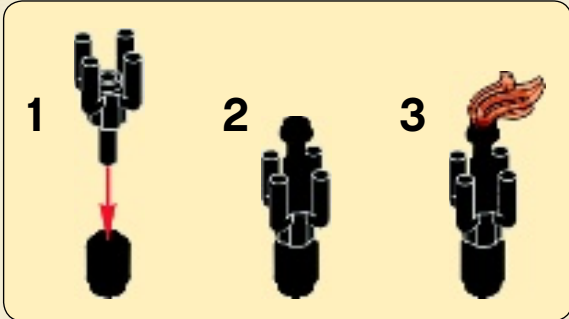

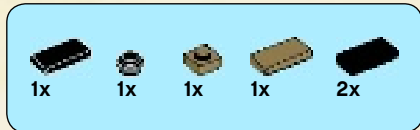

77





78

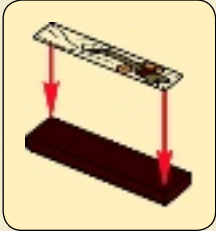
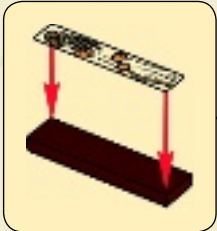
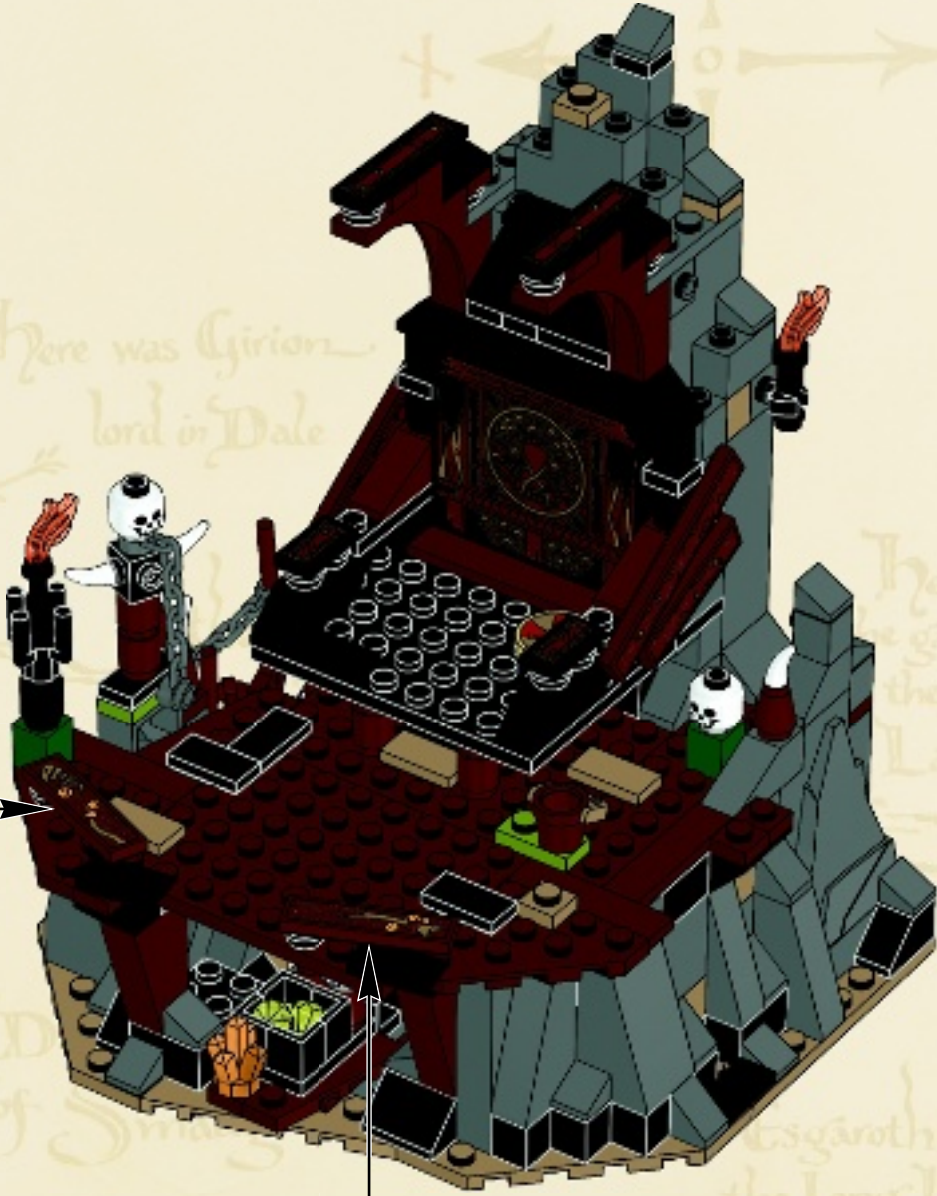



2x

79



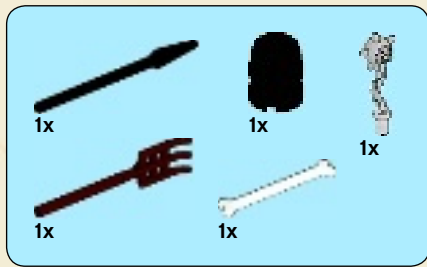

80

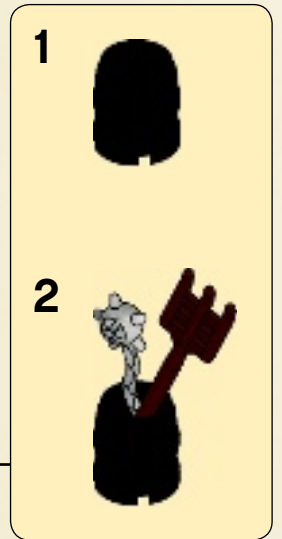
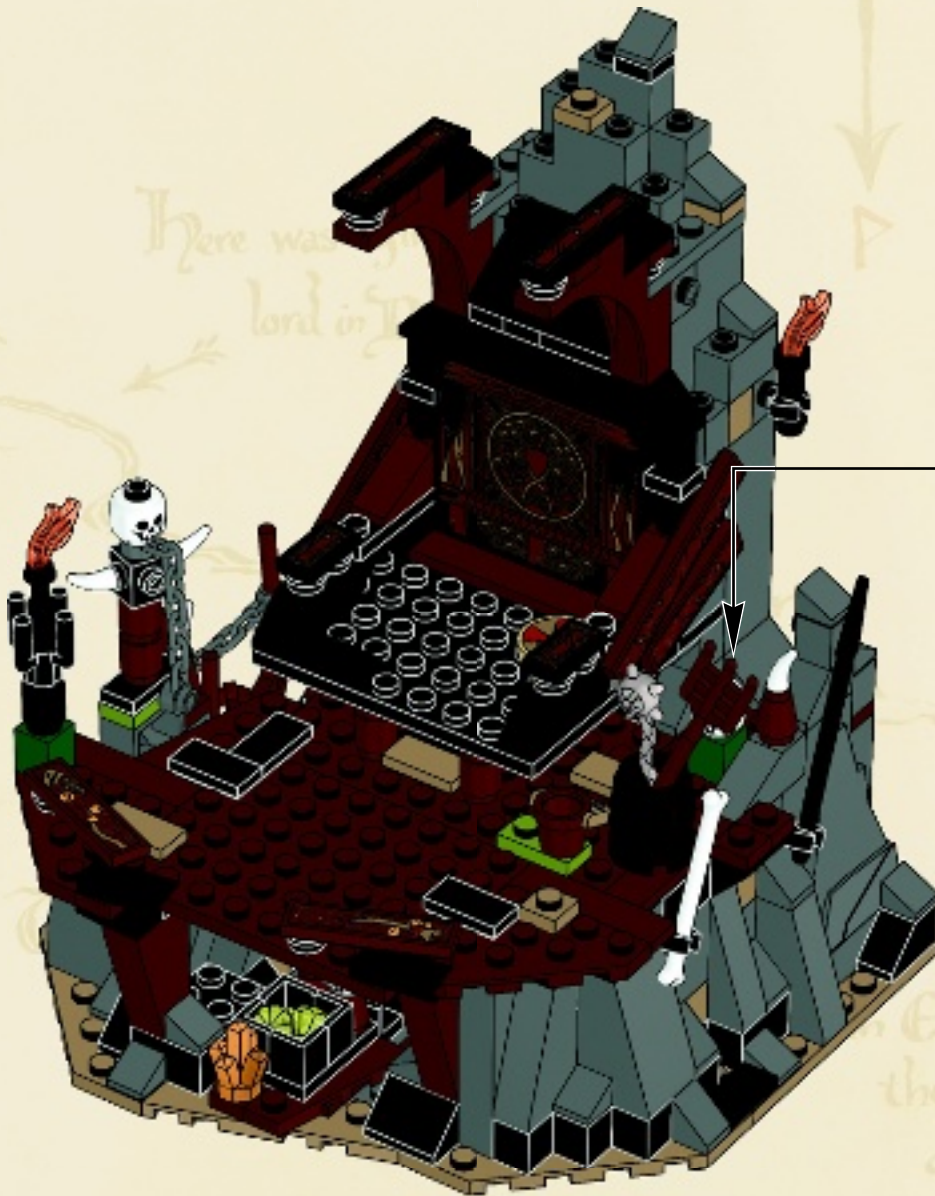

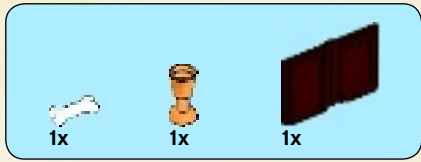

81

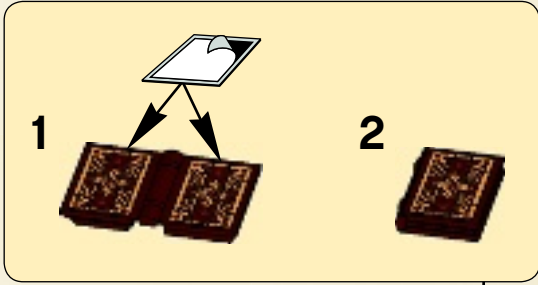

East lie the Iron Hills
where is Dain



Here was Gollum

Here is
the gateway
of the Long
Lake

Escape upon
the Long Lake
Men



WIN!

Go to www.LEGOsurvey.com/product to fill out a survey for a chance to win a cool LEGO® Product.

No purchase necessary.

Open to all residents where not prohibited.



www.LEGOsurvey.com/product

GEWINNE!

Nimm an der Umfrage auf www.LEGOsurvey.com/product teil und hab die Chance ein cooles LEGO® Produkt zu gewinnen!

Die Teilnahme am Gewinnspiel führt zu keinerlei Kaufverpflichtungen. Teilnahme in allen nicht ausgeschlossenen Ländern möglich.

WIN!

Ga naar www.LEGOsurvey.com/product, vul een enquêteformulier in en maak kans op een cool LEGO® product.

Geen aankoopverplichting. Iedereen mag deelnemen, uitgezonderd ingezetenden van landen waar een enquêteverbod geldt.

GAGNE!

Visite www.LEGOsurvey.com/product pour répondre à un questionnaire et avoir une chance de gagner un produit LEGO® très cool!

Aucune obligation d'achat. Ouvert à tous les résidents des pays autorisés.

当てよう!

www.LEGOsurvey.com/product にアクセスして、アンケートにご記入ください。当選者にはレゴ製品を差し上げます。

お買い上げの必要はありません。禁止されていない限り、すべての皆様にご利用いただけます。



LEGO and the LEGO logo are trademarks of the/sonnt des marques de commerce de/son marcas registradas de LEGO Group.
©2012 The LEGO Group. 6036567

THE HOBBIT: AN UNEXPECTED JOURNEY: © NLP™ Middle-earth Ent. Lic. to New Line. (s12)
LE HOBBIT : UN VOYAGE INATTENDU : © NLP™ Middle-earth Ent. Lic. à New Line. (s12)
EL HOBBIT: UN VIAJE INESPERADO: © NLP™ Middle-earth Ent.; uso autorizado a New Line. (s12)