



# NINJAGO

Masters of Spinjitzu



70750



 [LEGO.com/ninjabot](http://LEGO.com/ninjabot)

 2

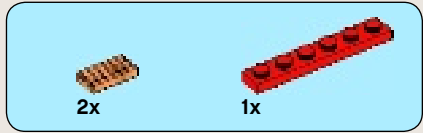
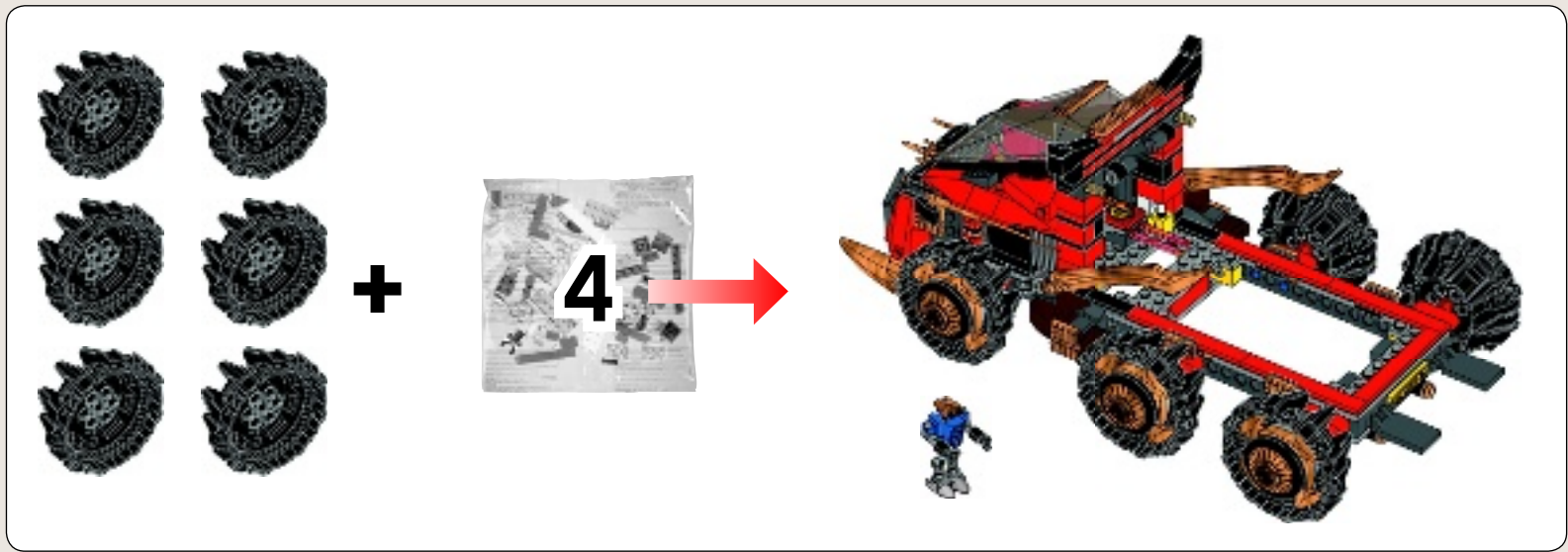

52

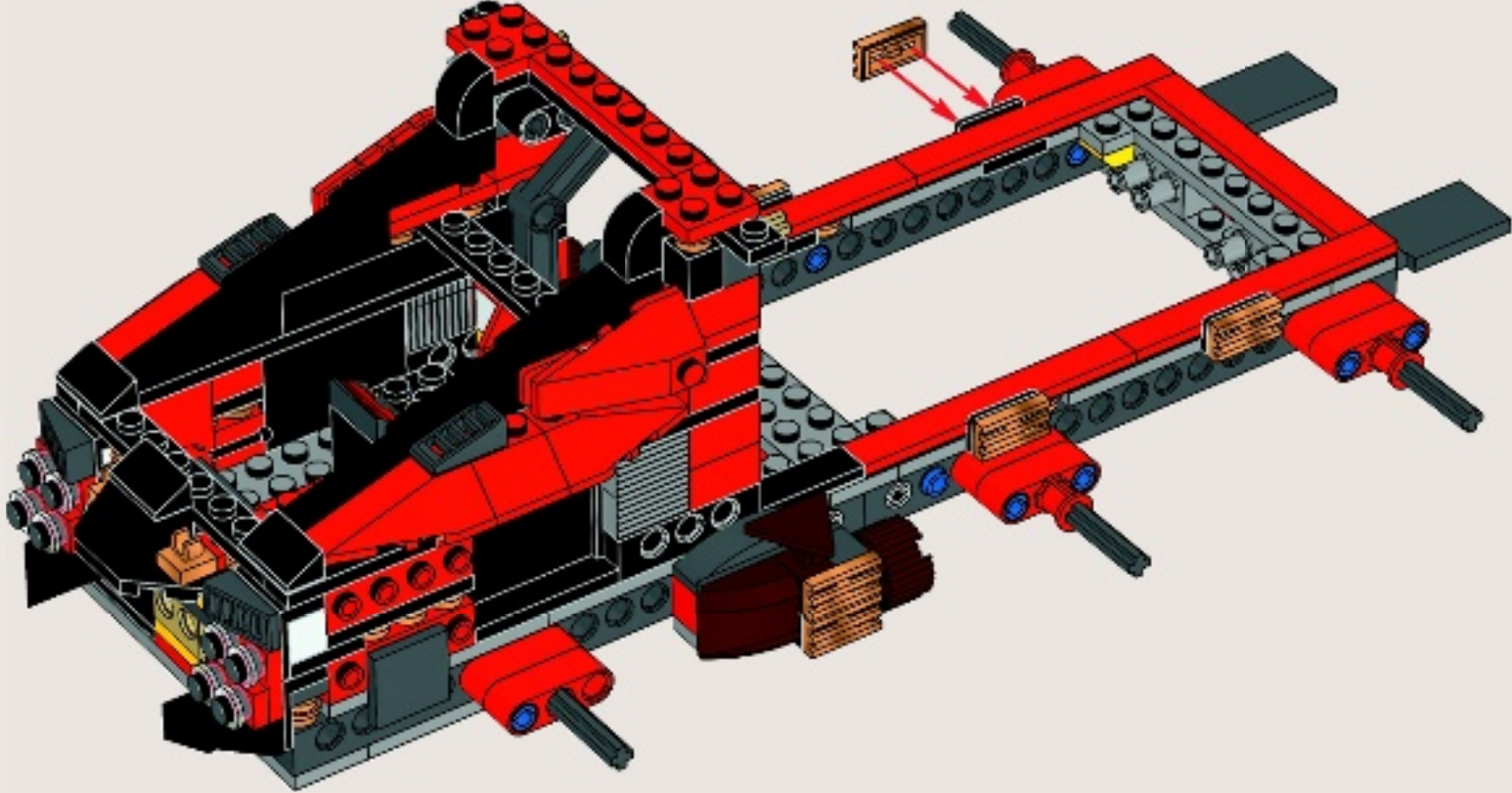



53

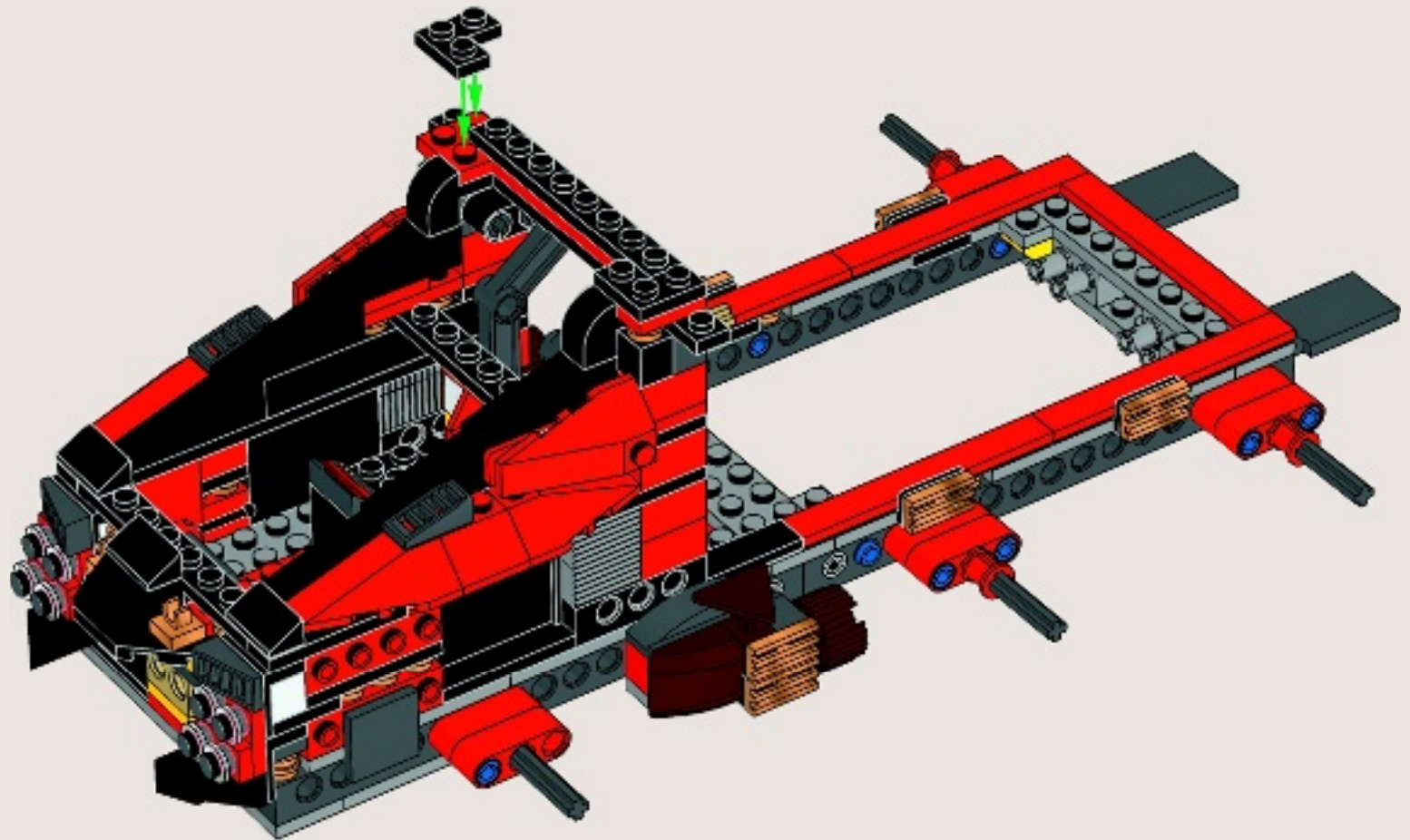

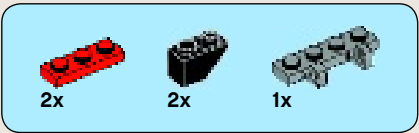

# 54

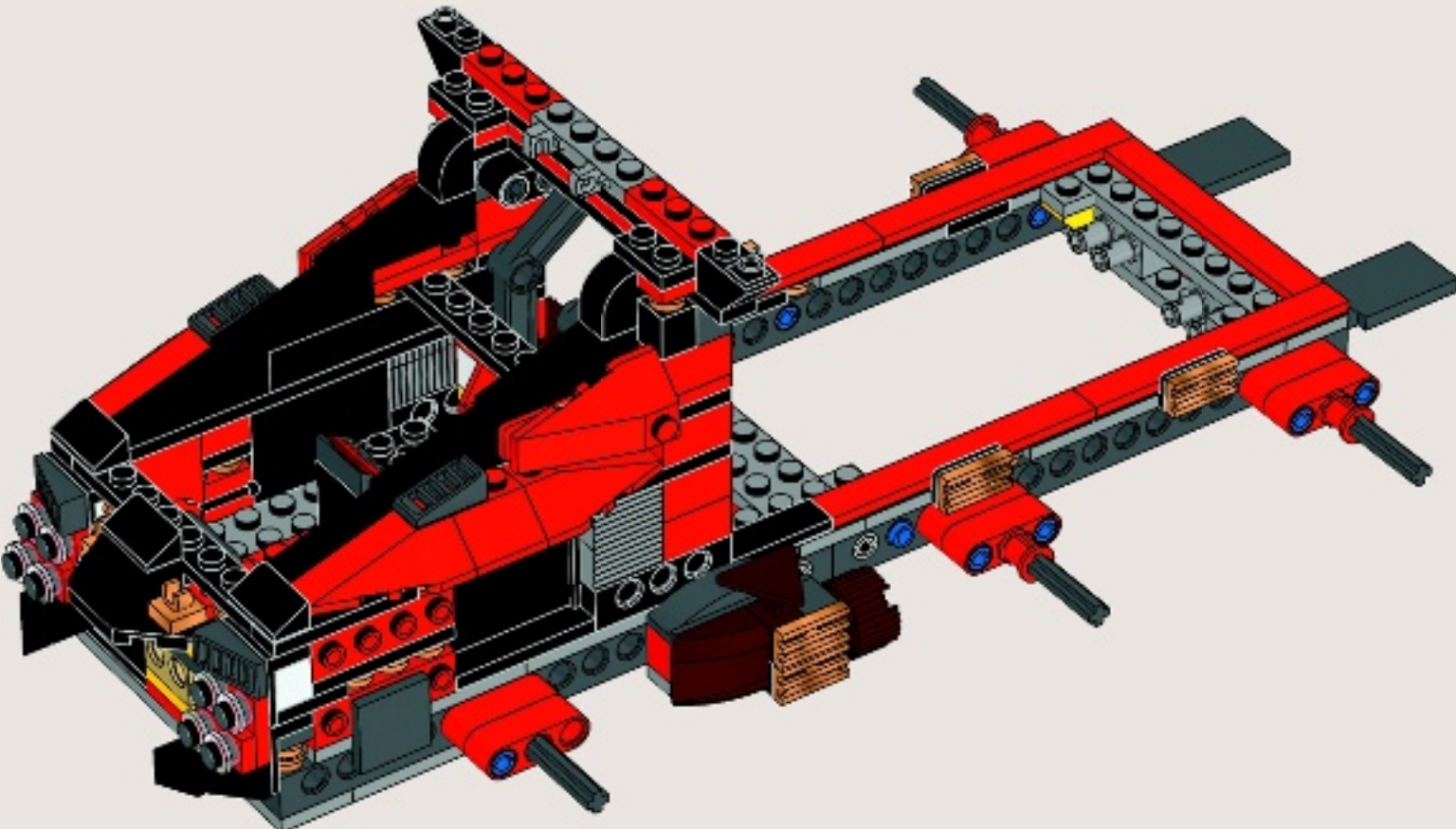



55

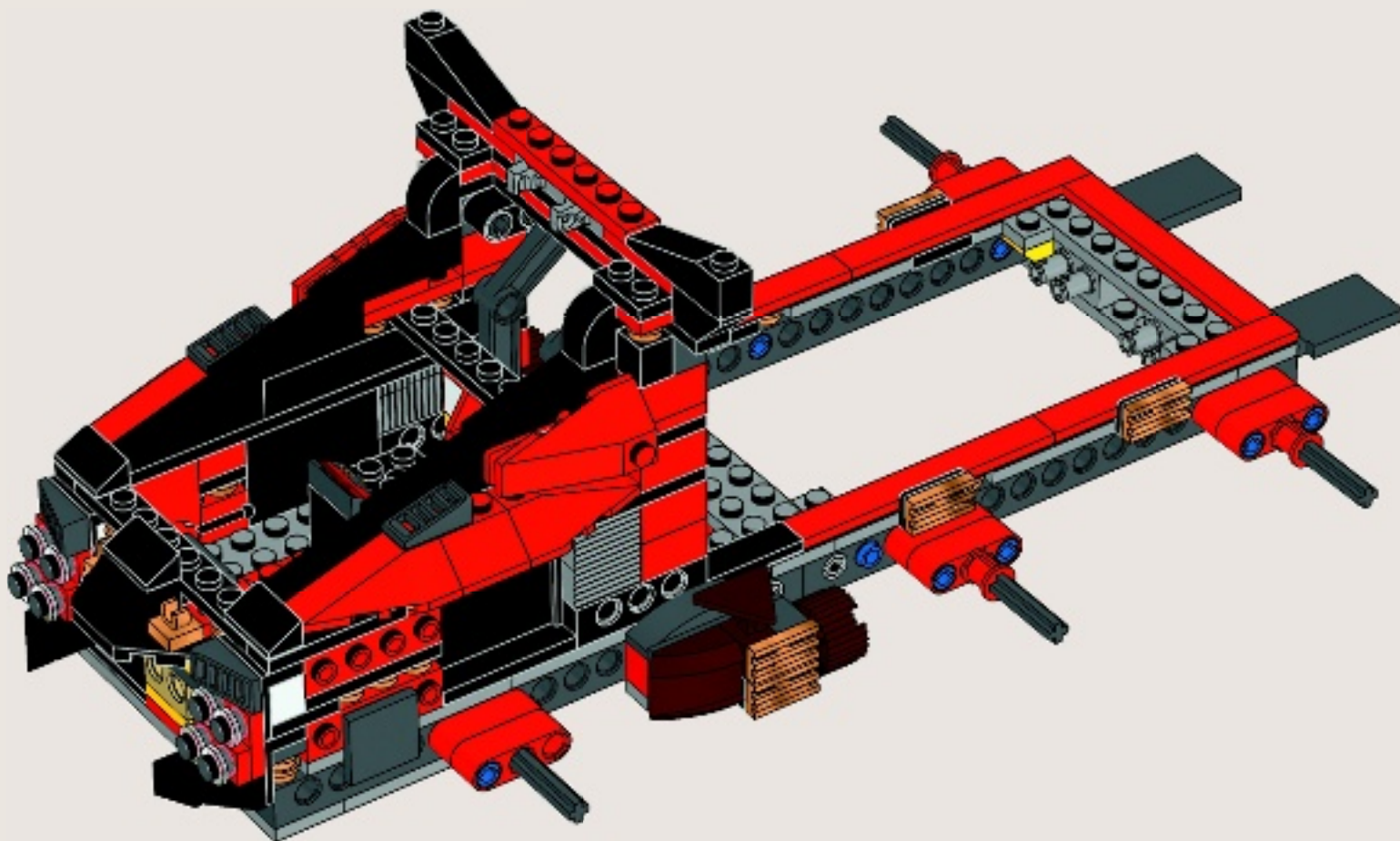

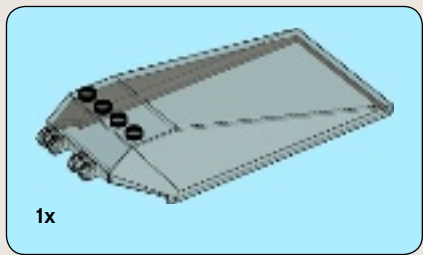

56

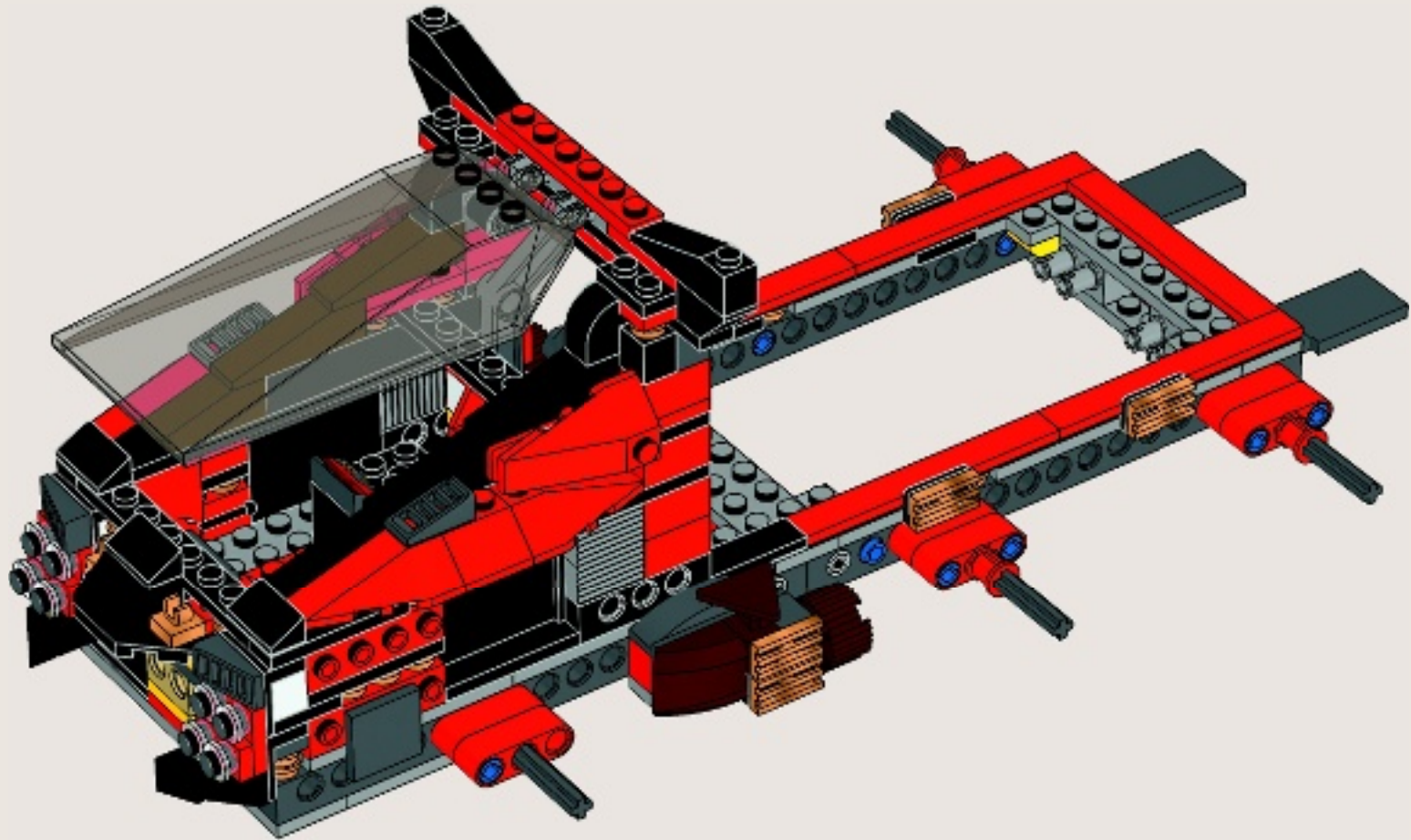

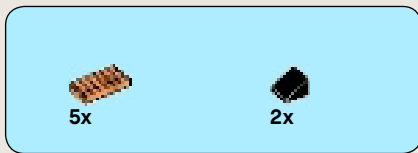

57

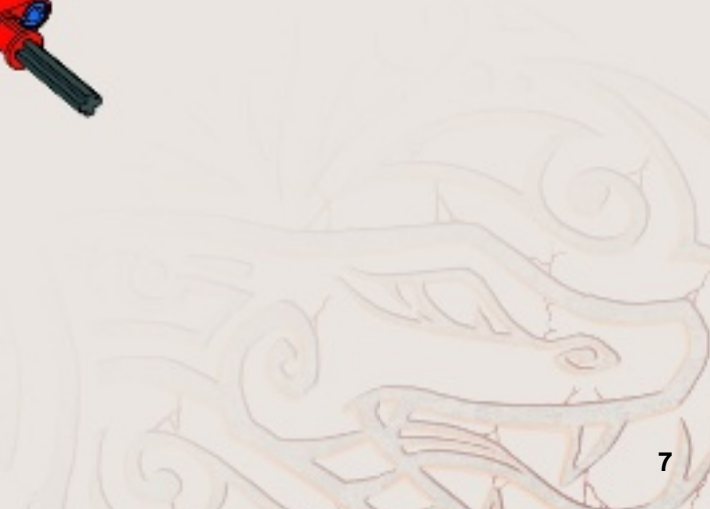

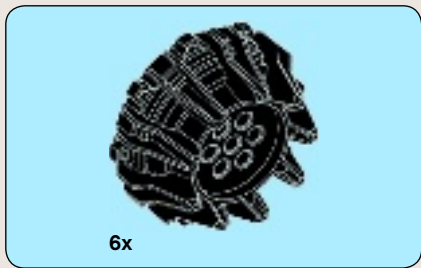

58





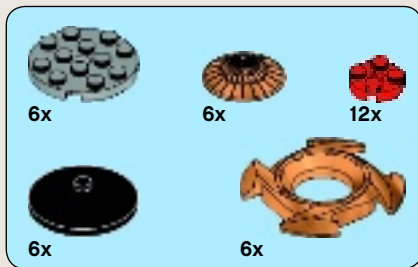

59

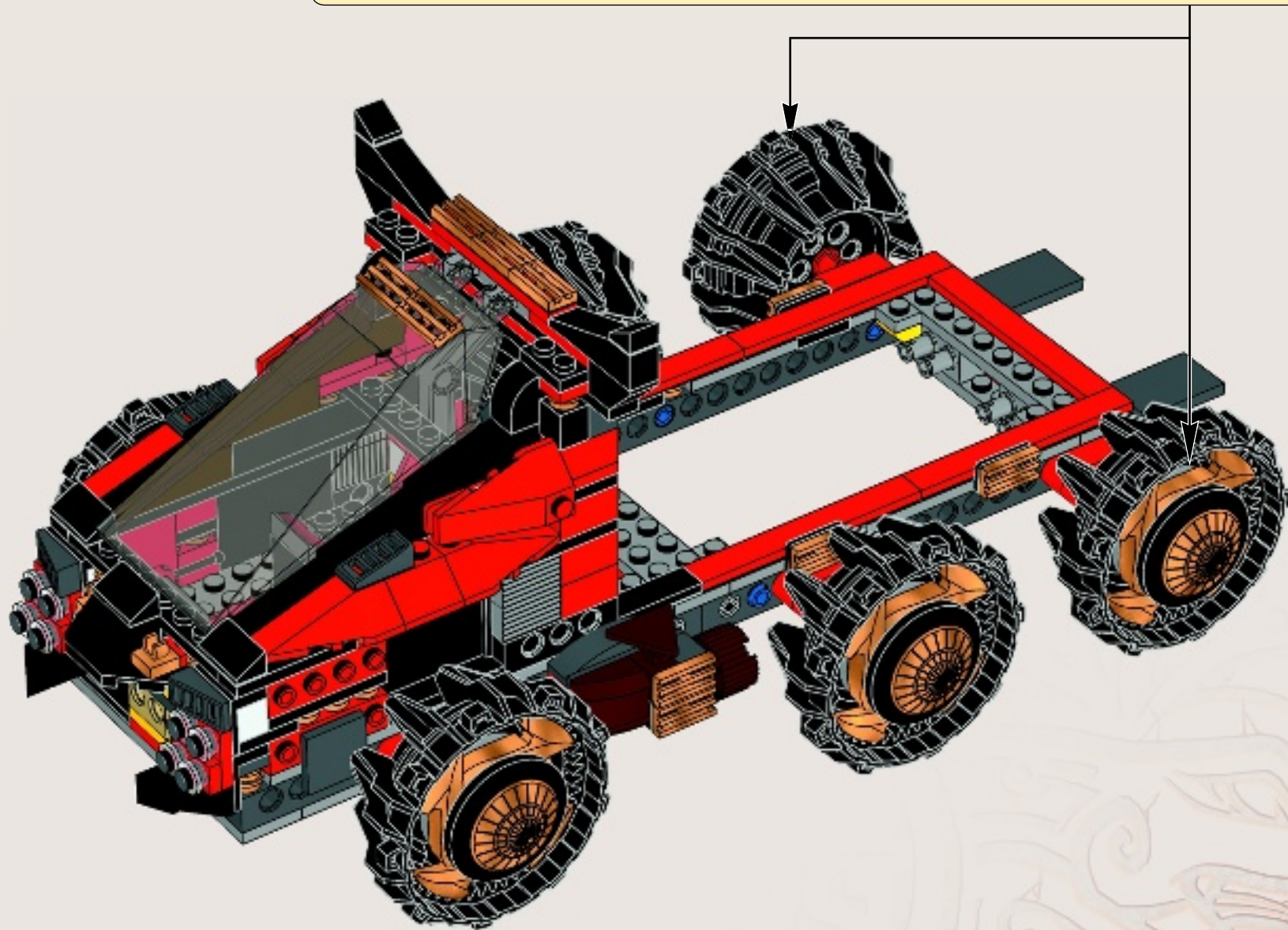

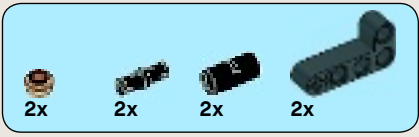

60

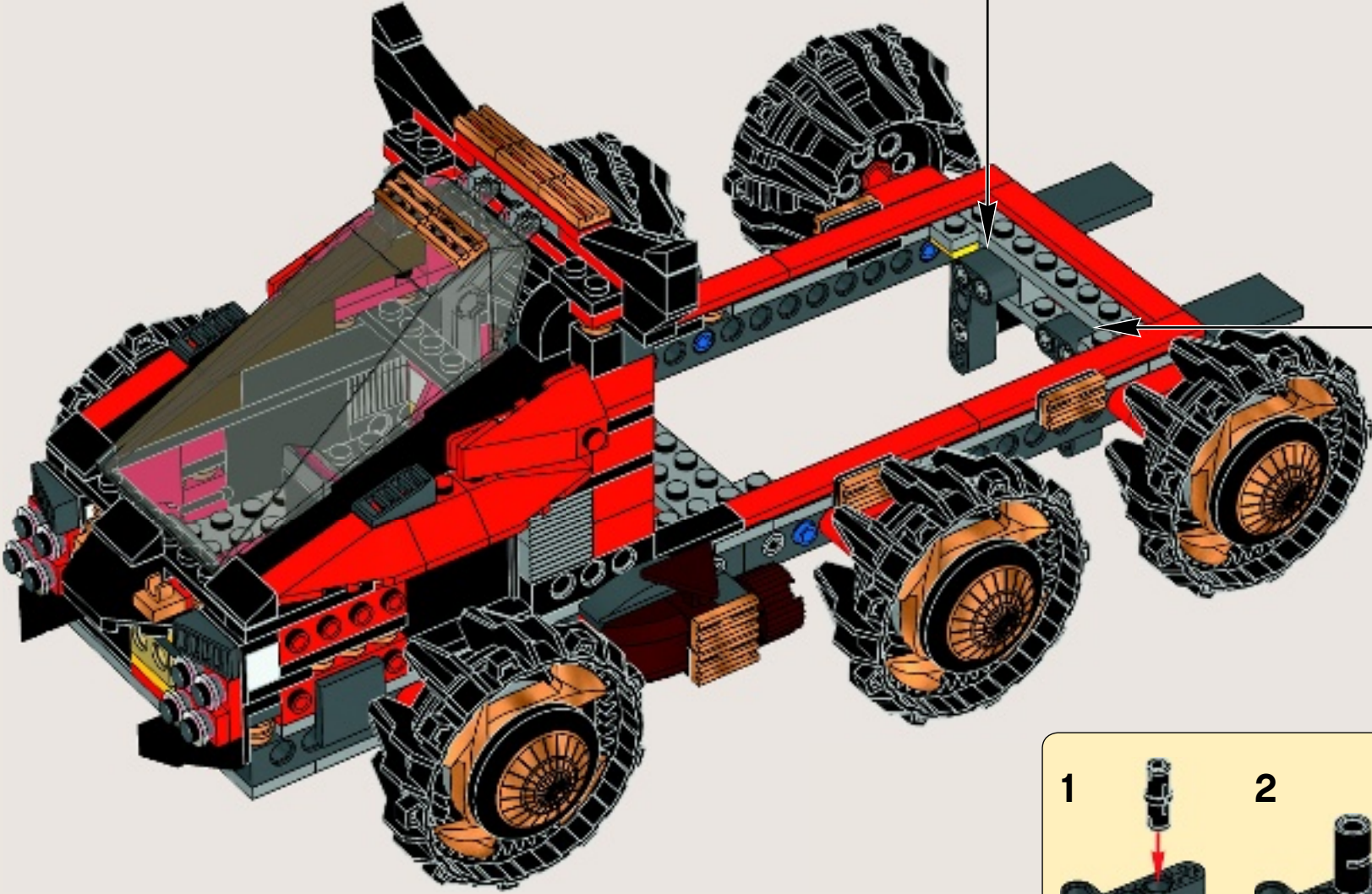
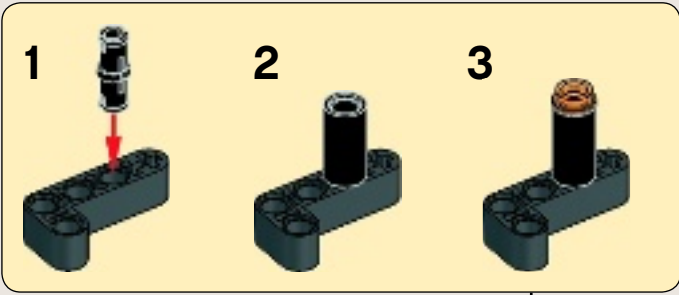

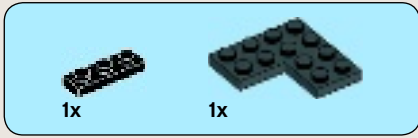

1

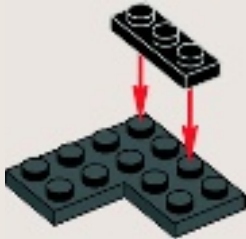

2

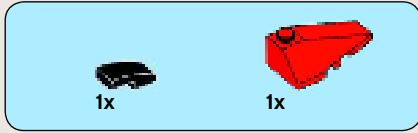

3

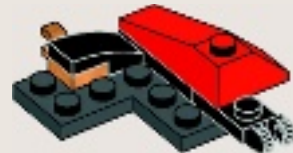



1x

4



1x



1x

5



1x

6

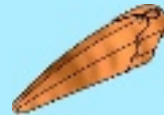
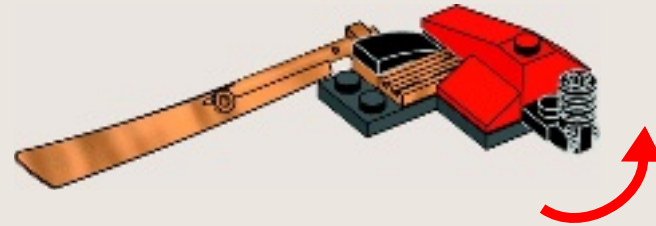

1x

7



61

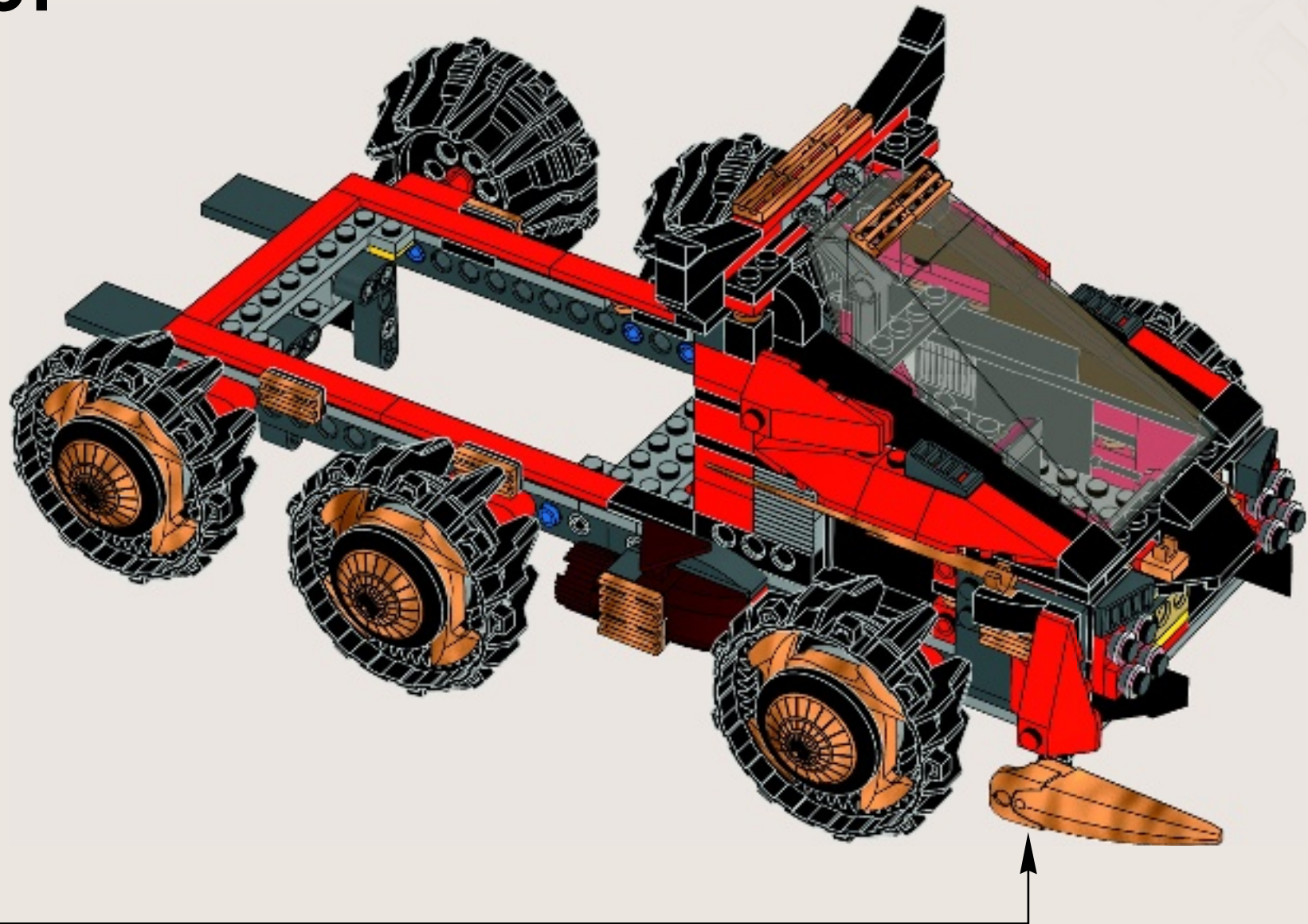
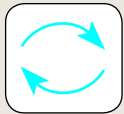

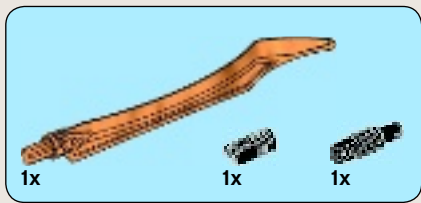

62

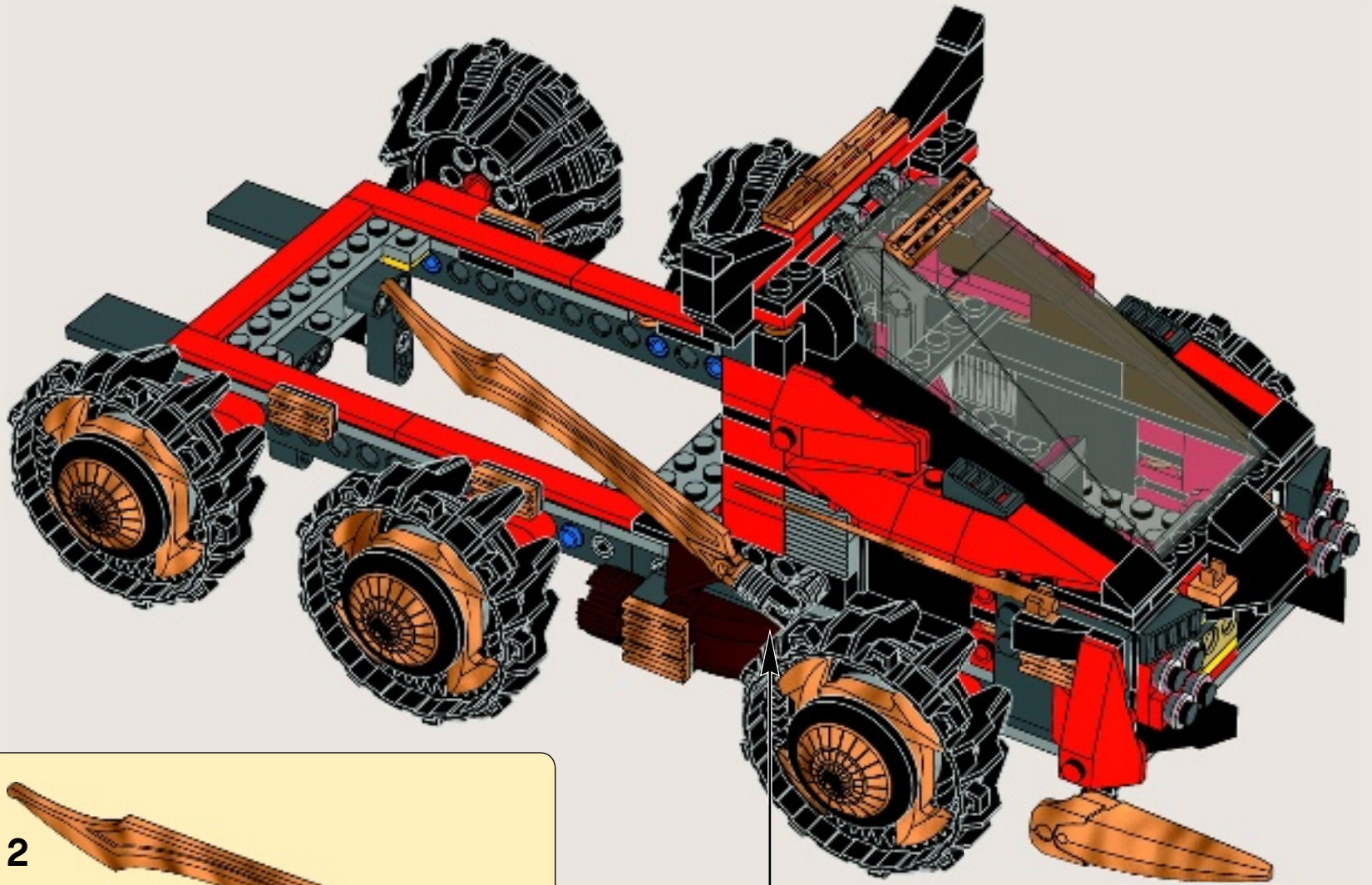

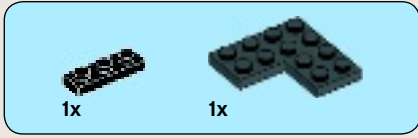
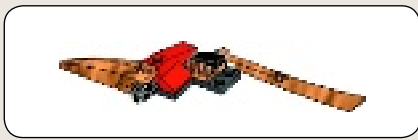

1

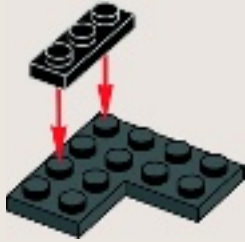

2

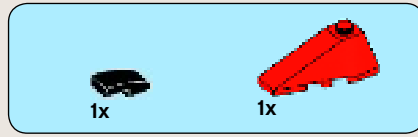

3





1x

4



1x



1x

5



1x

6

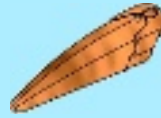
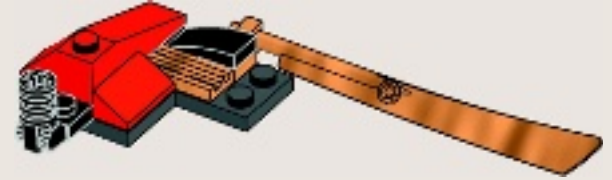

1x

7





63

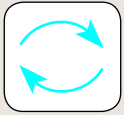

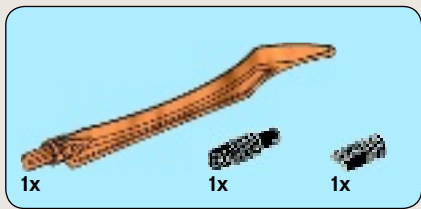

64

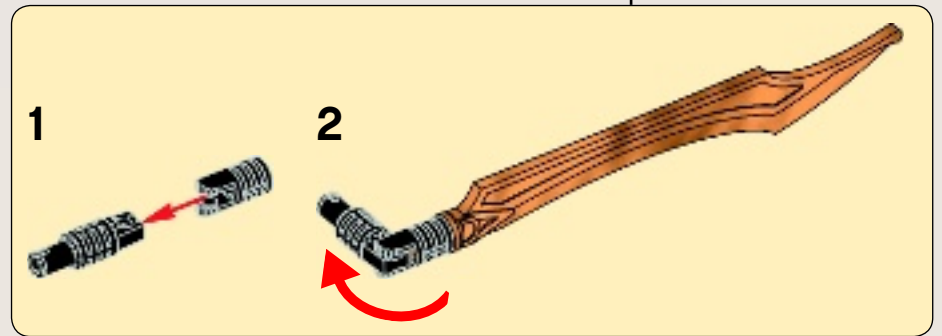

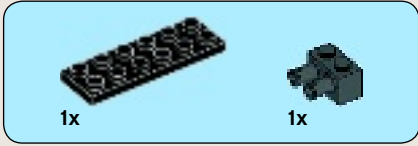

1

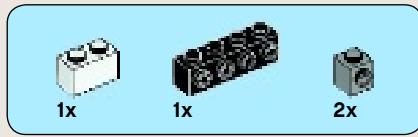

2

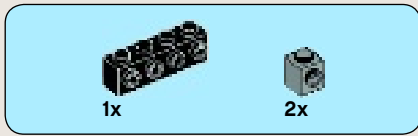
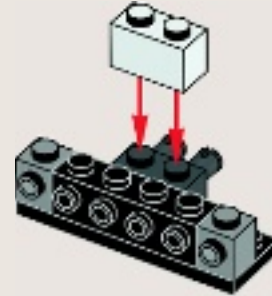

3

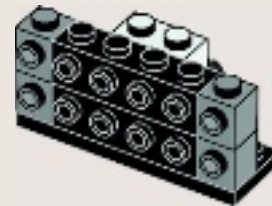



4

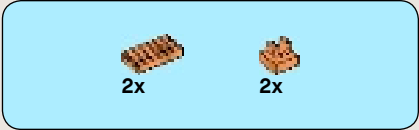
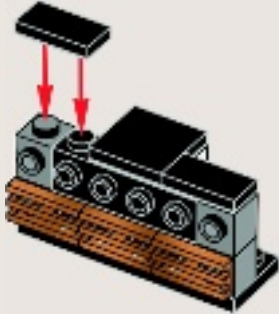

5

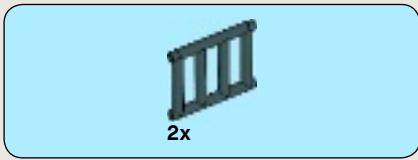
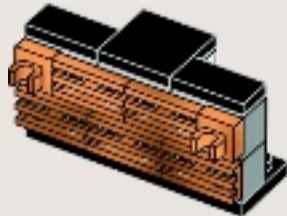

6

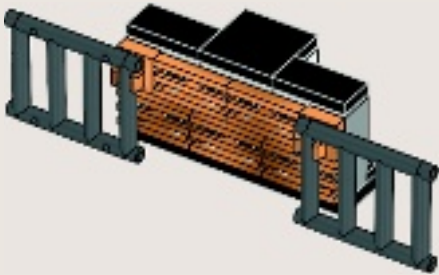

65

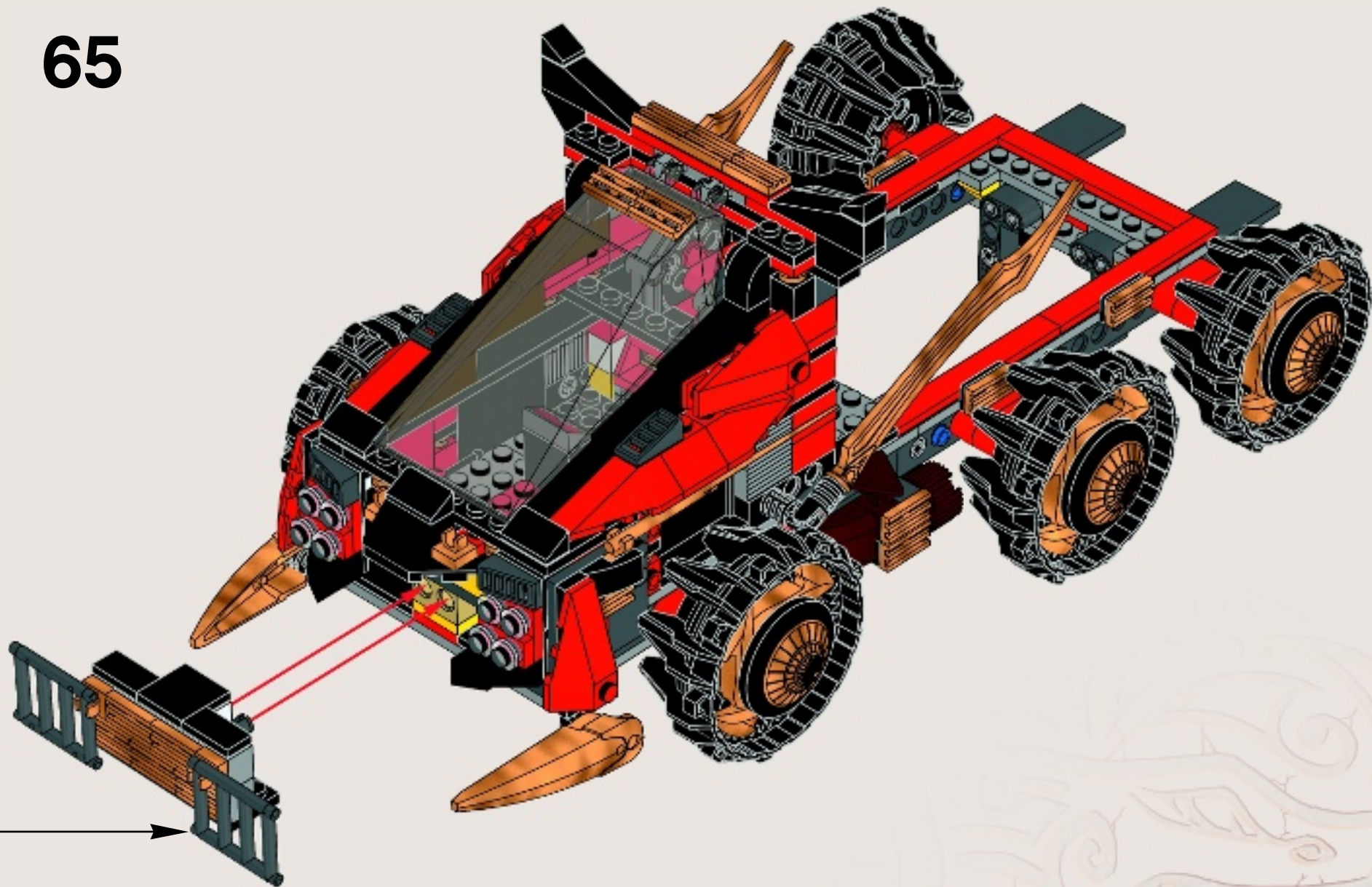



2x

# 66

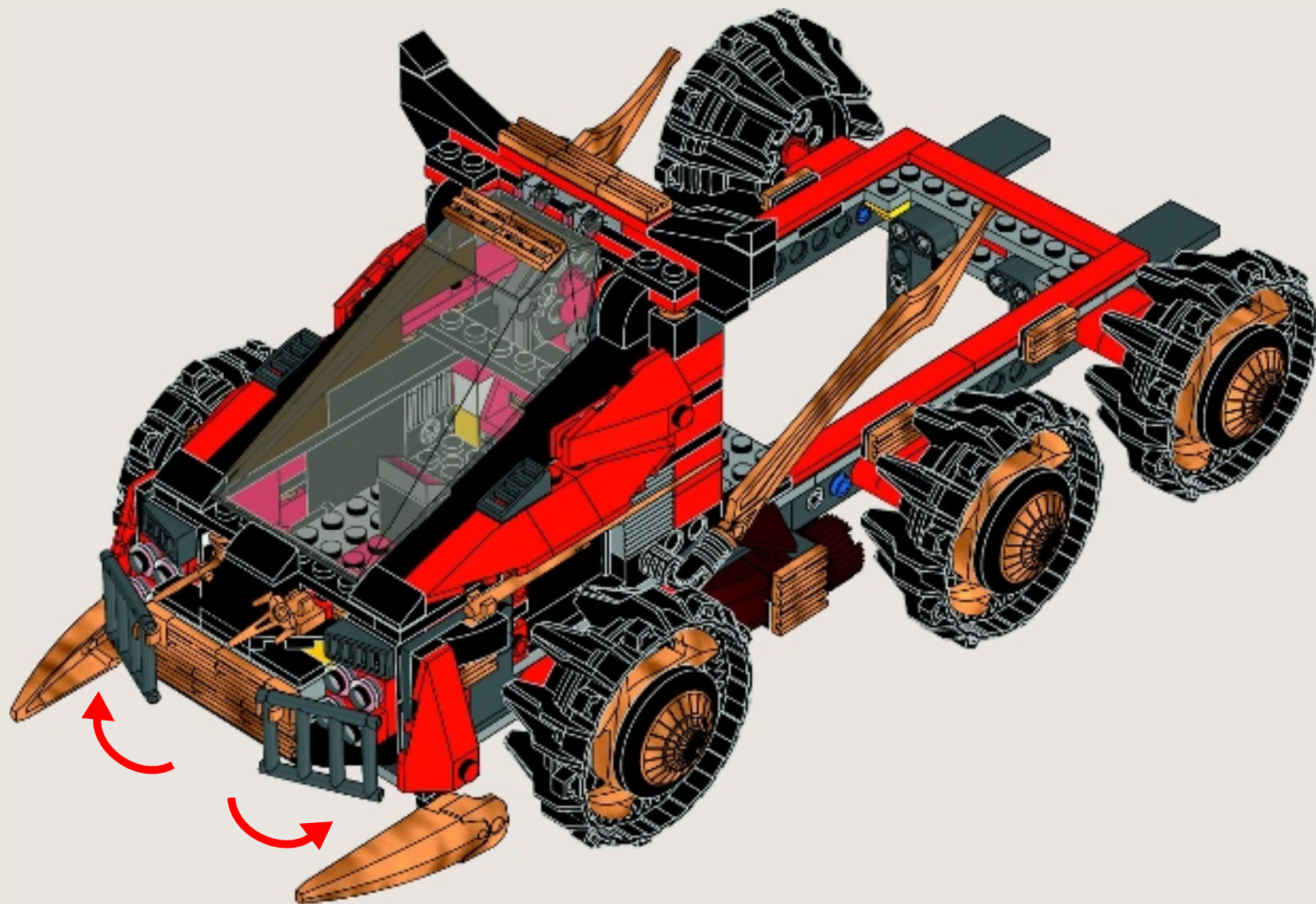

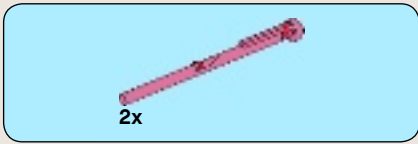

67

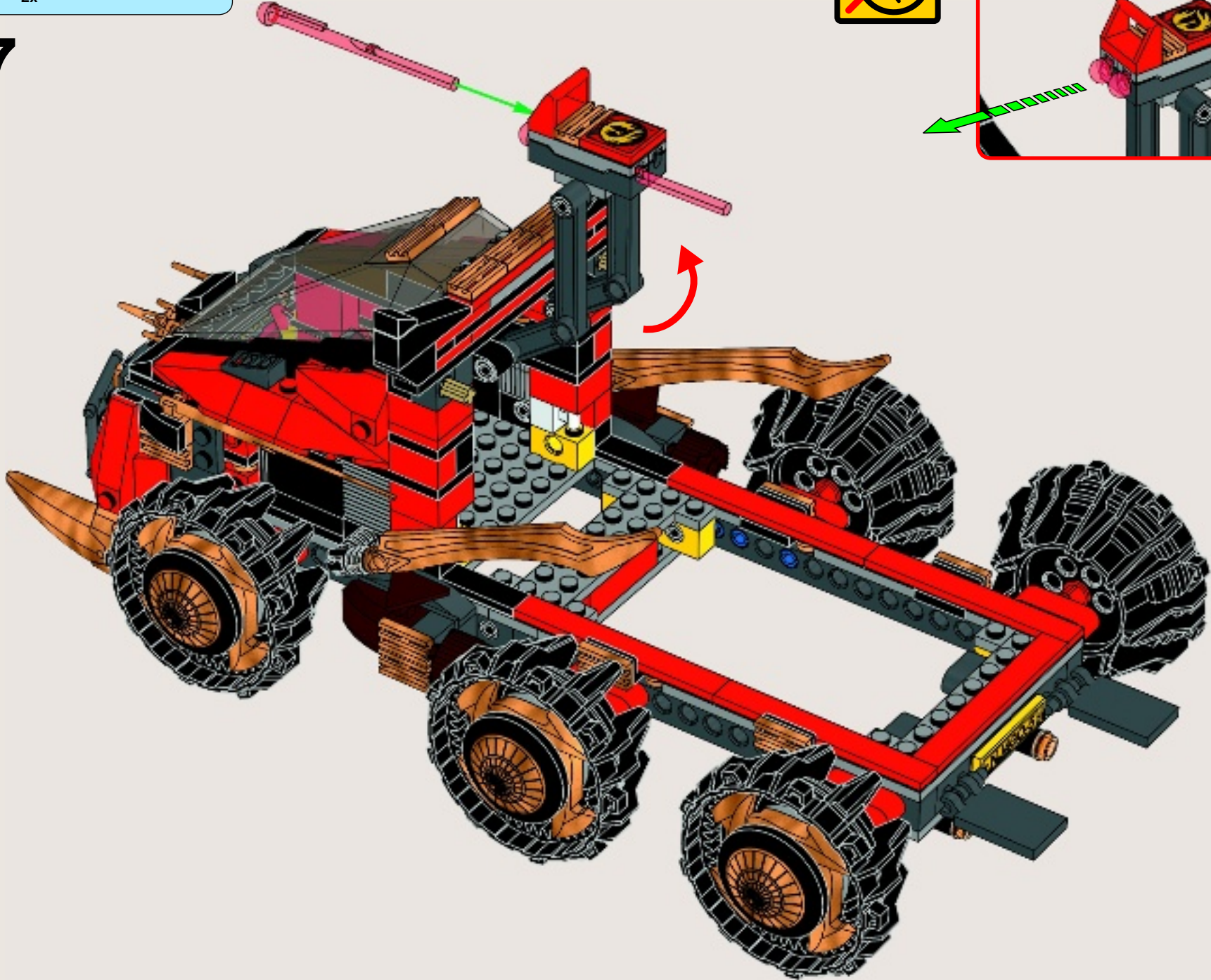
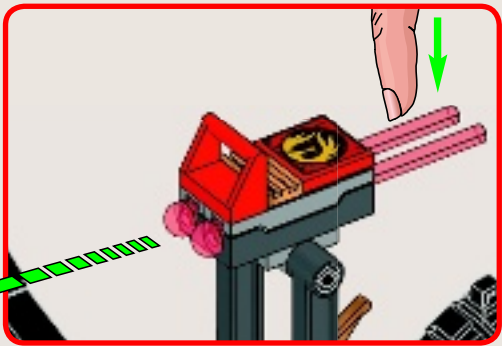

68

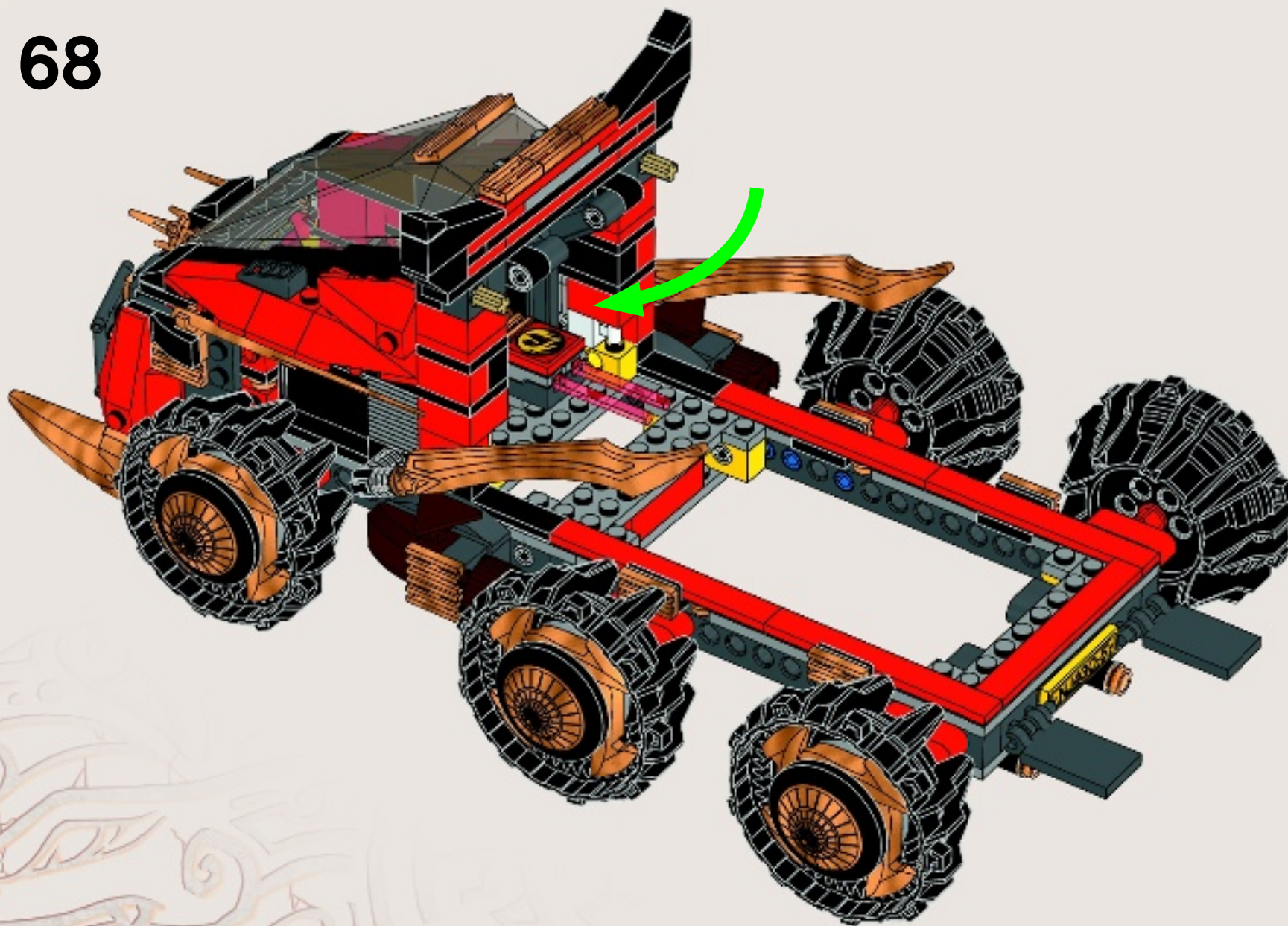



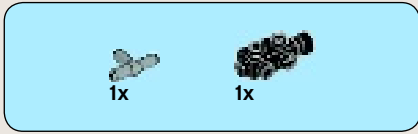

1

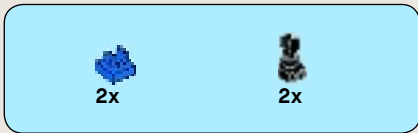

2

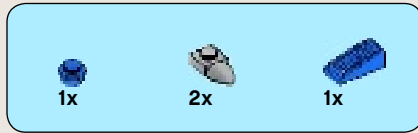

3

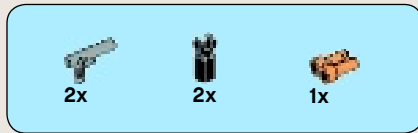

4

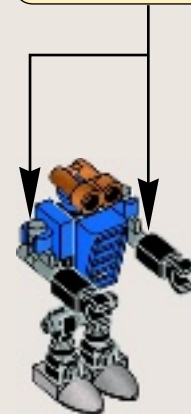
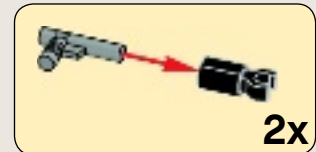

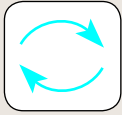
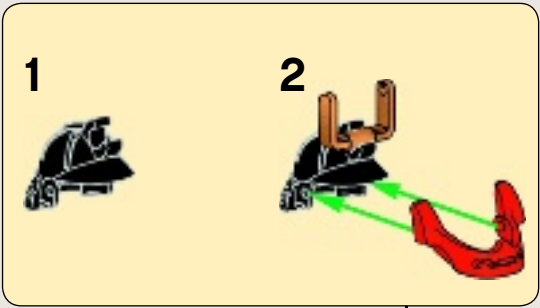
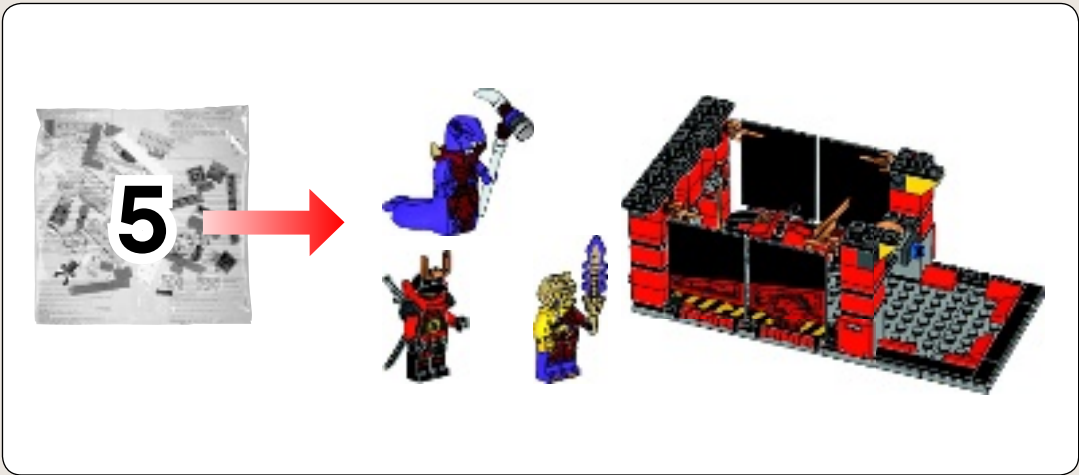

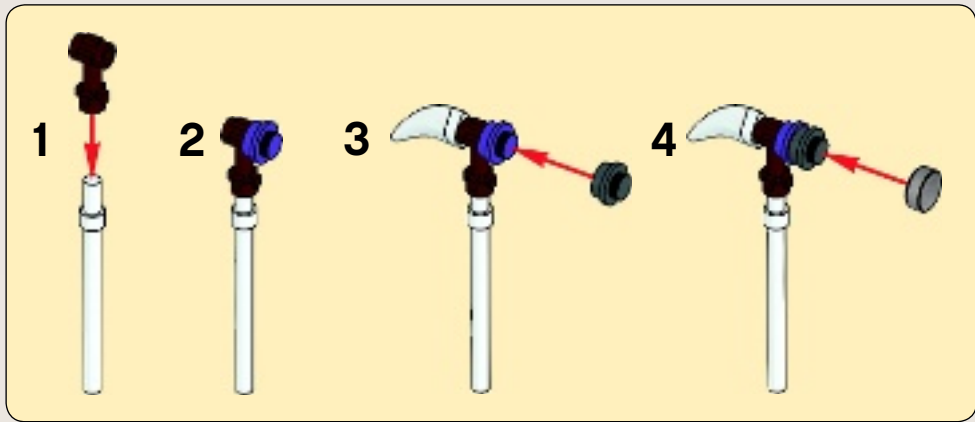

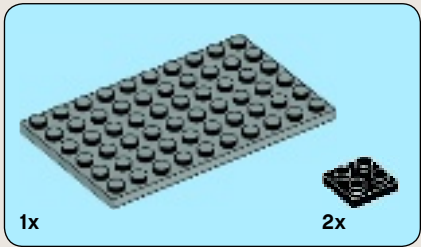
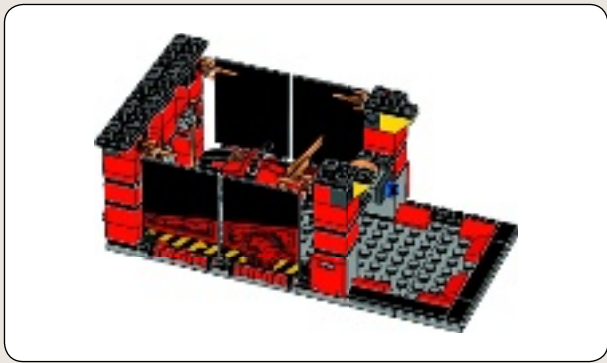

1

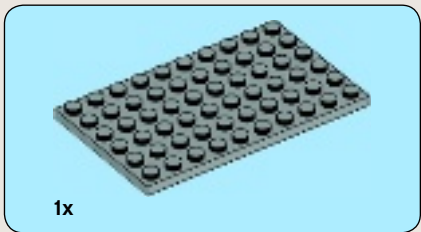
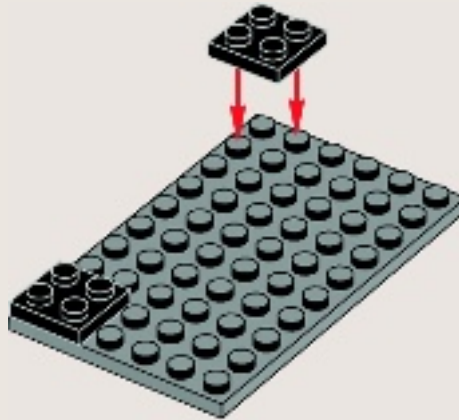

2

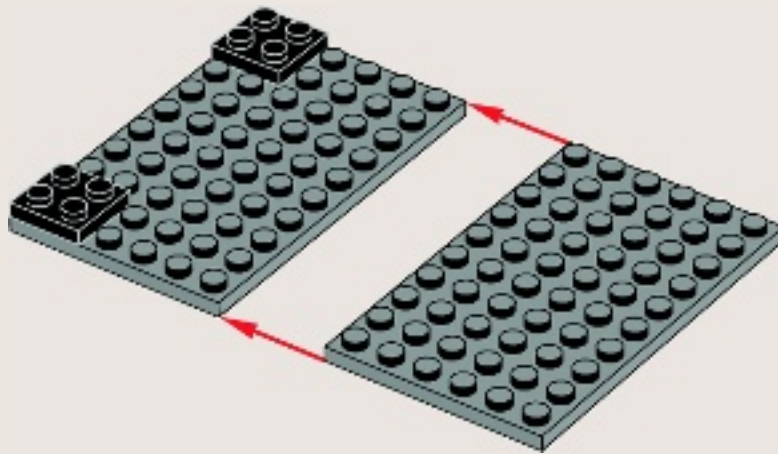



3

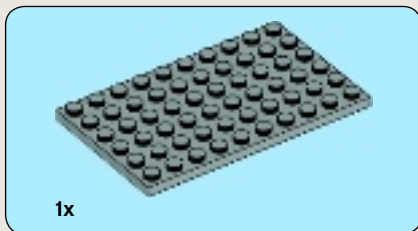
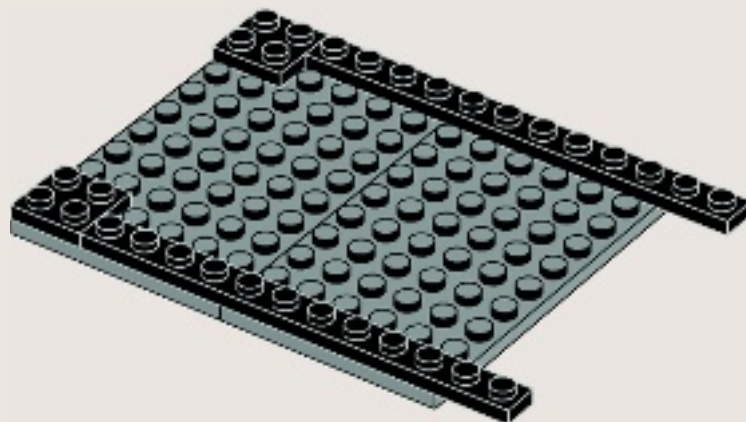

4

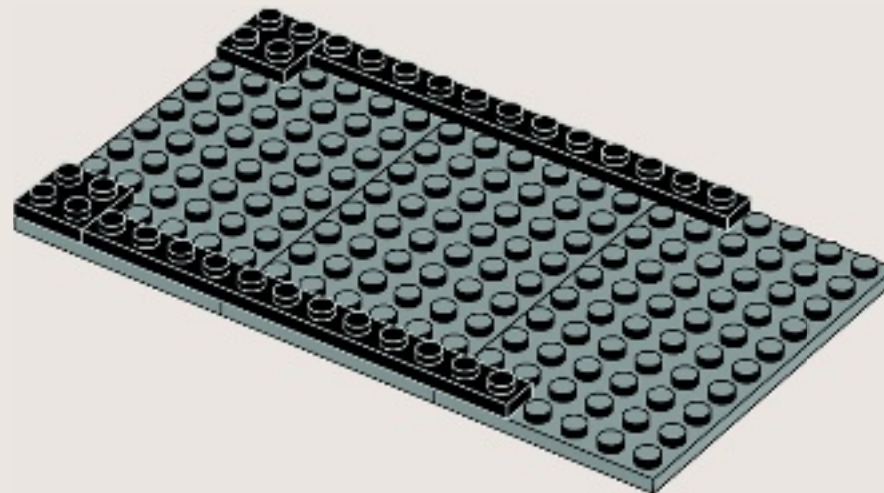



2x

5

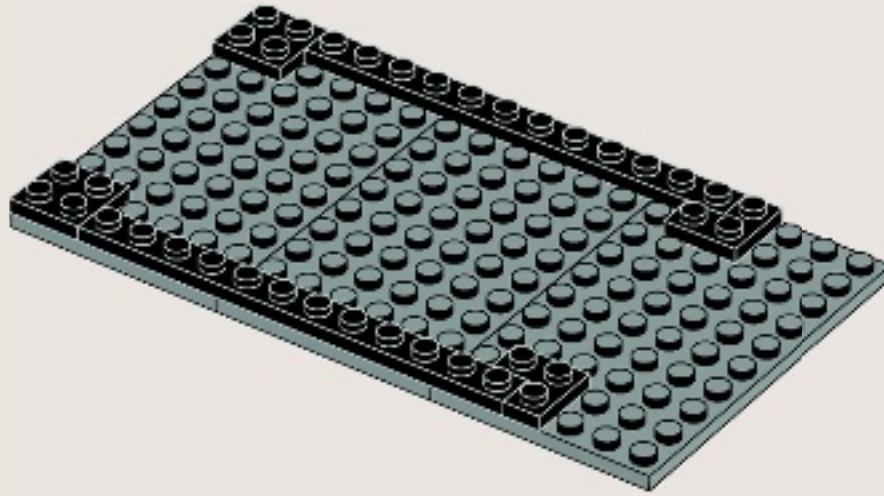

2x



2x

6

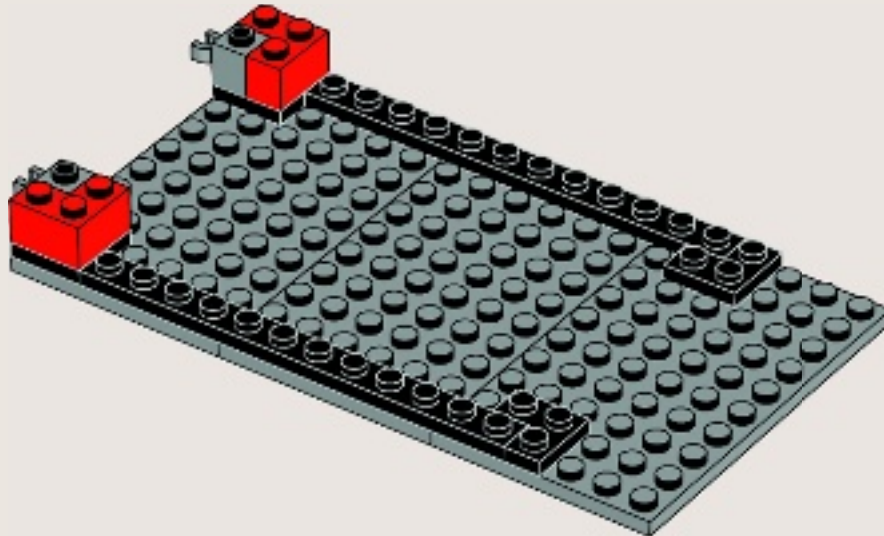

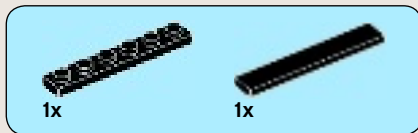

7

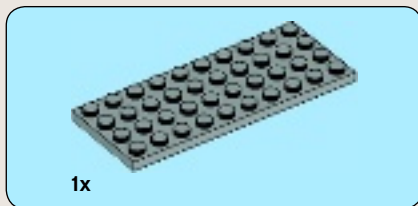
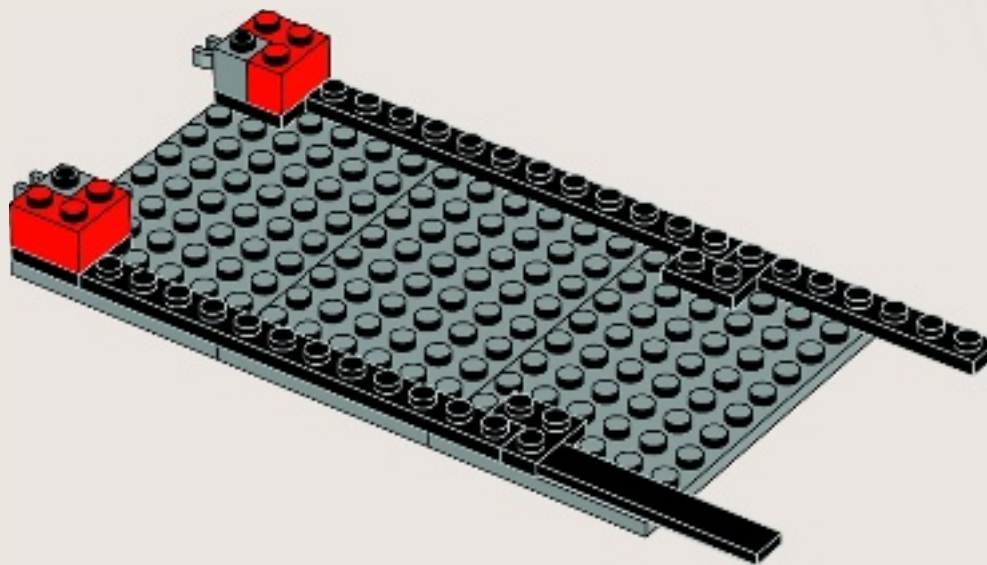

8

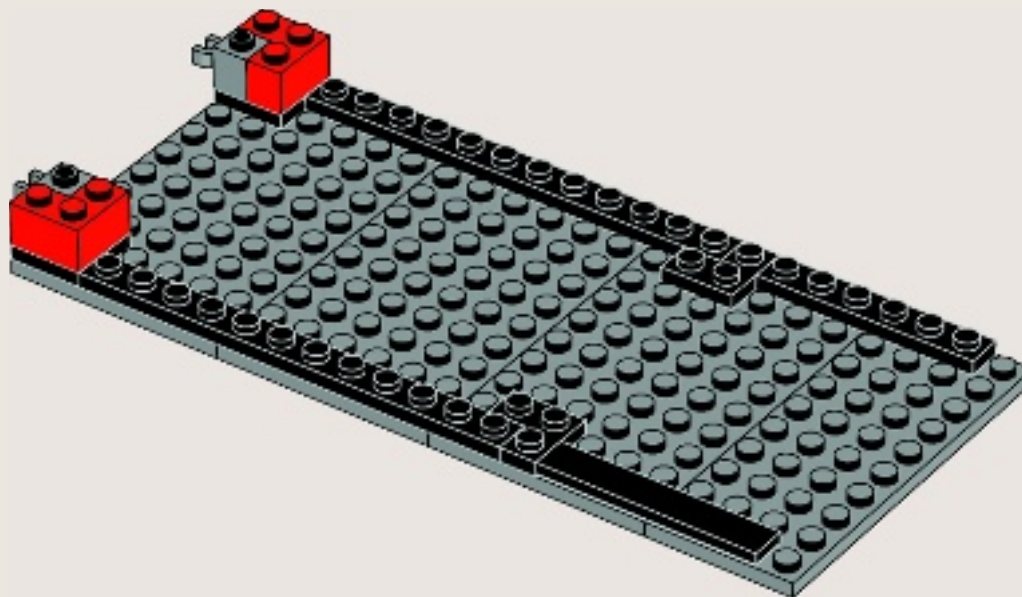

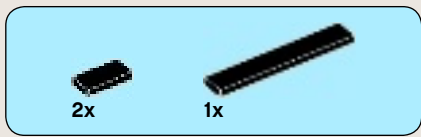

9

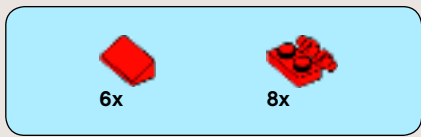
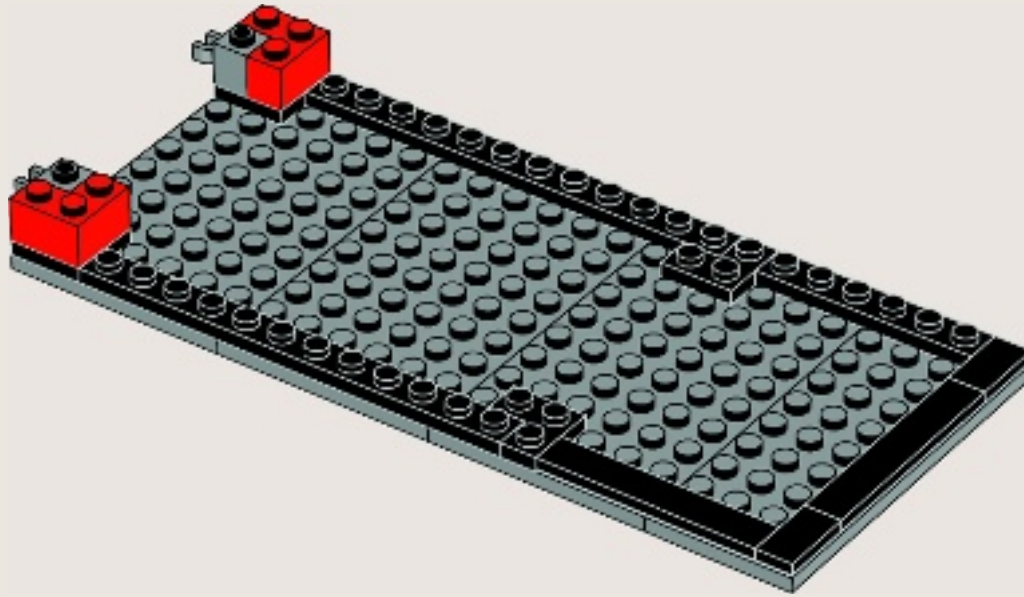

10

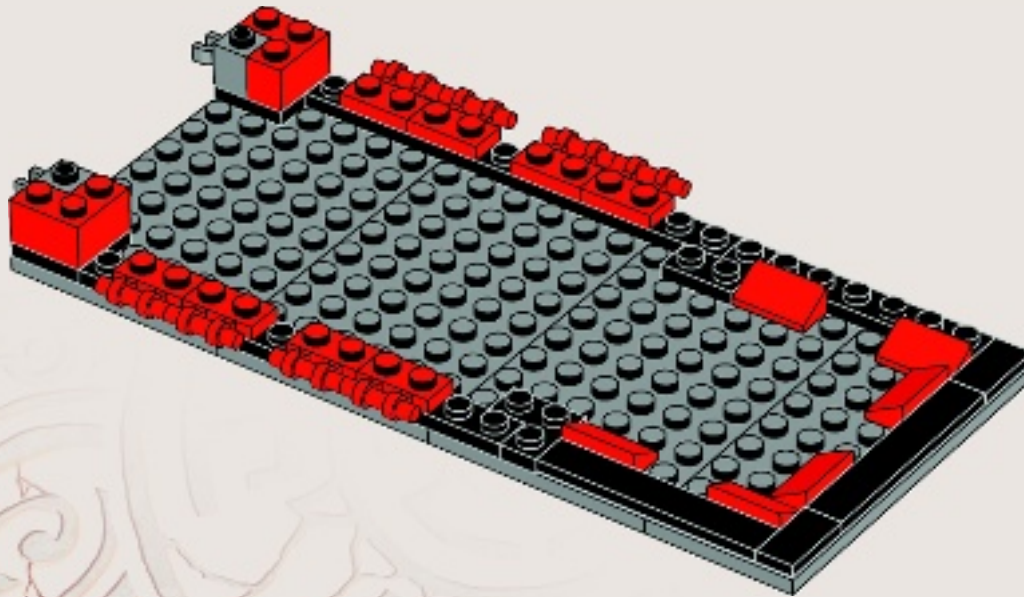



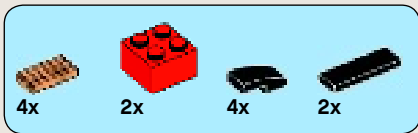

11

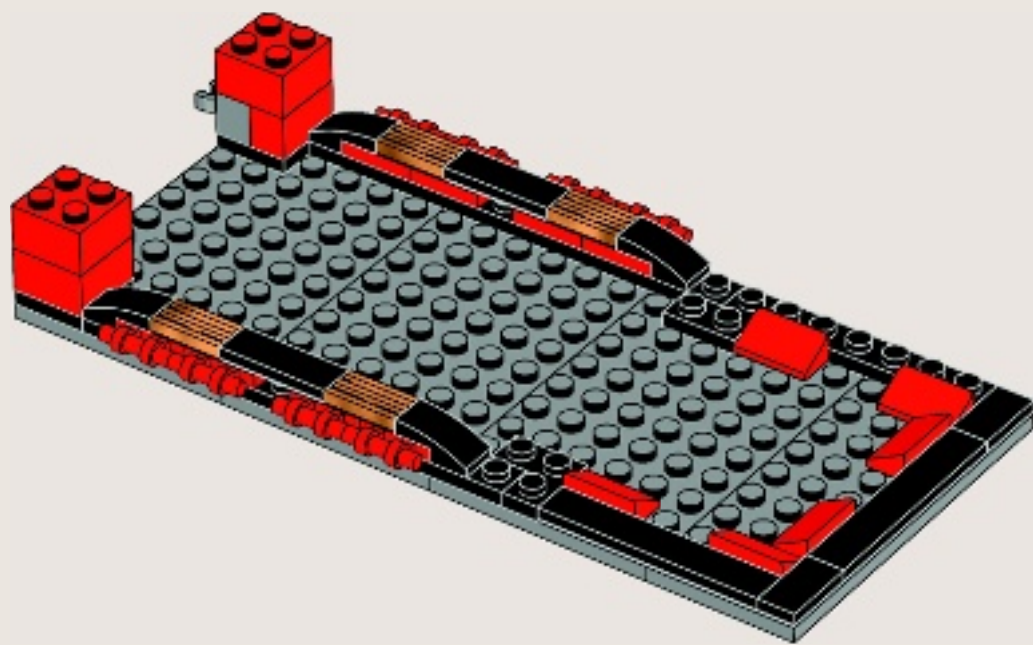

12

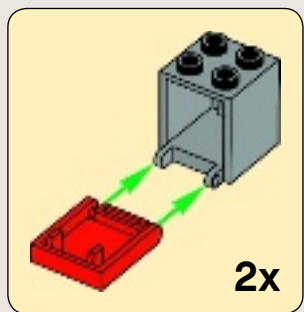
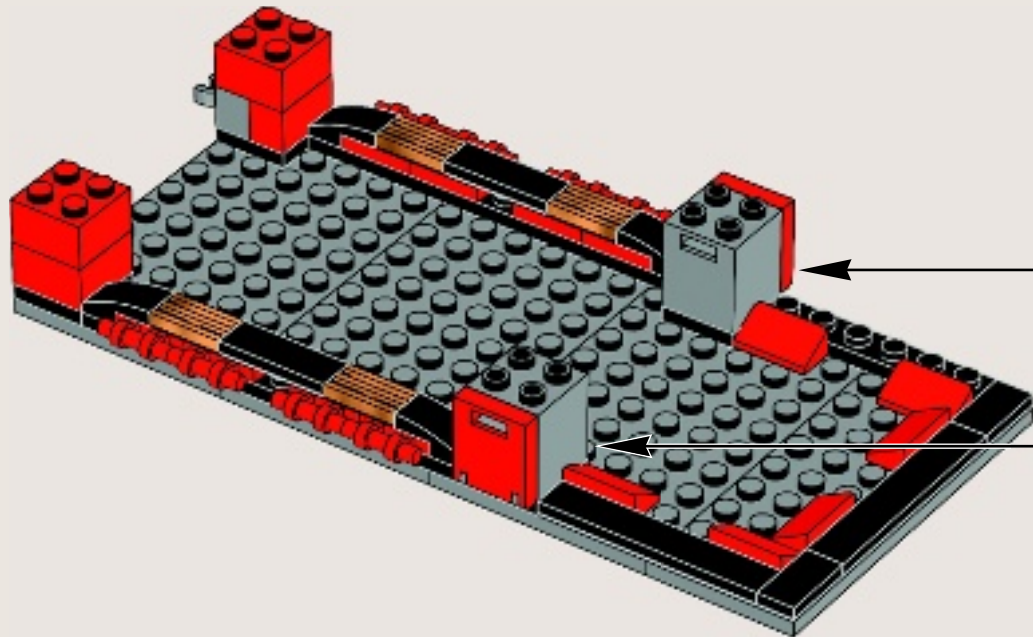



4x

13

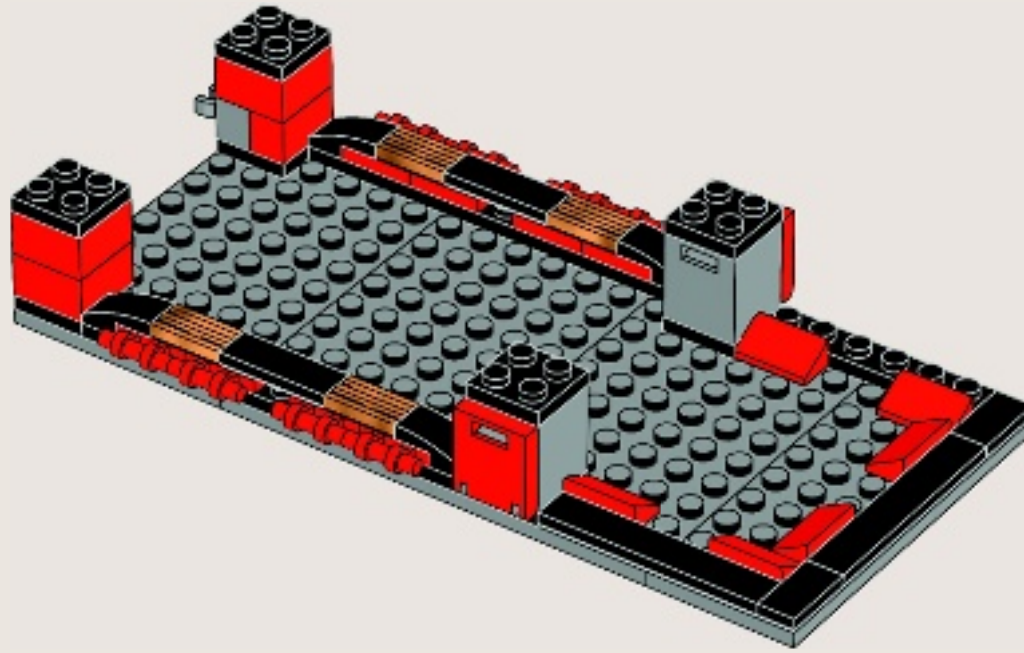

4x

14

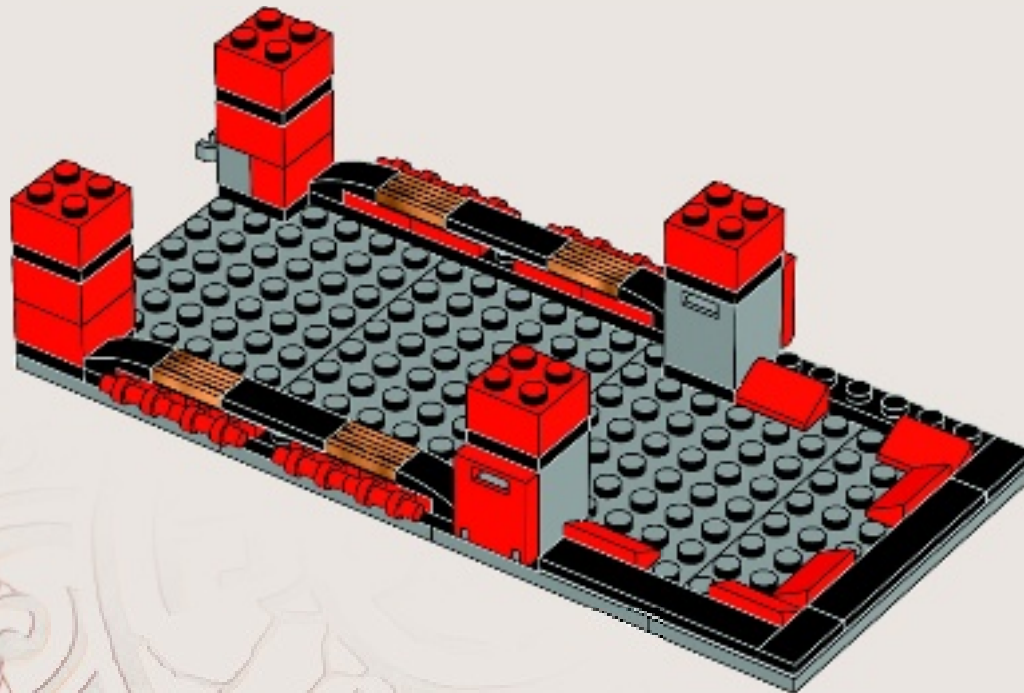

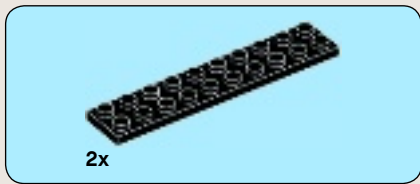

15

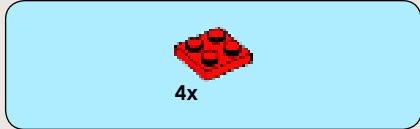
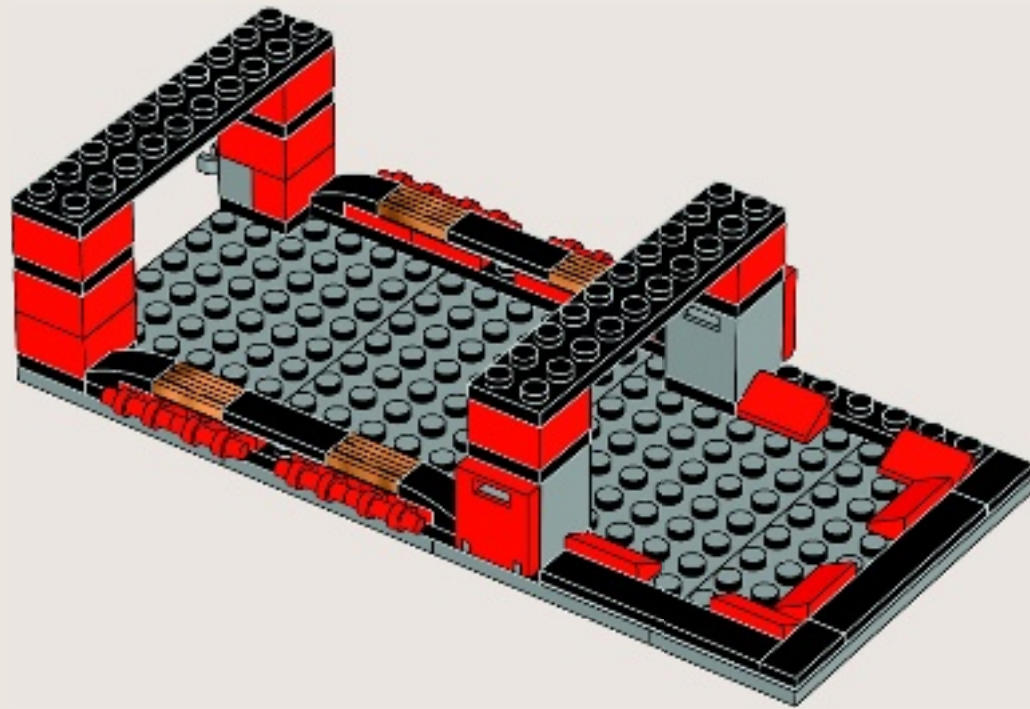

16

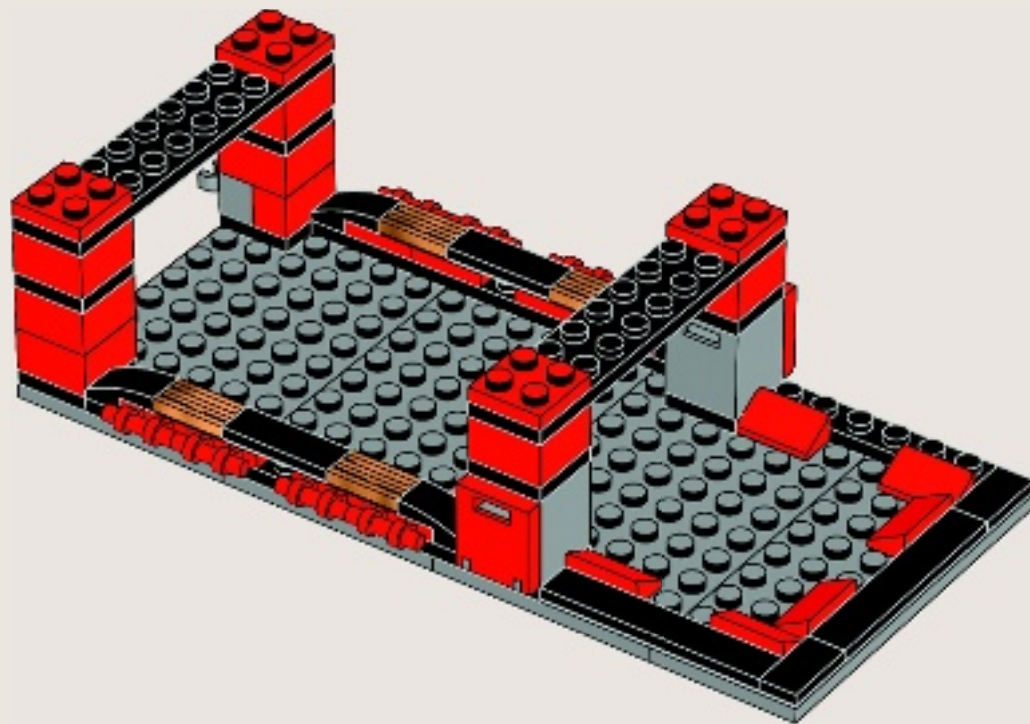



17

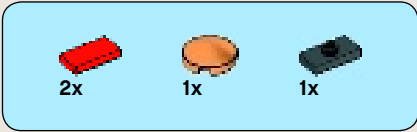
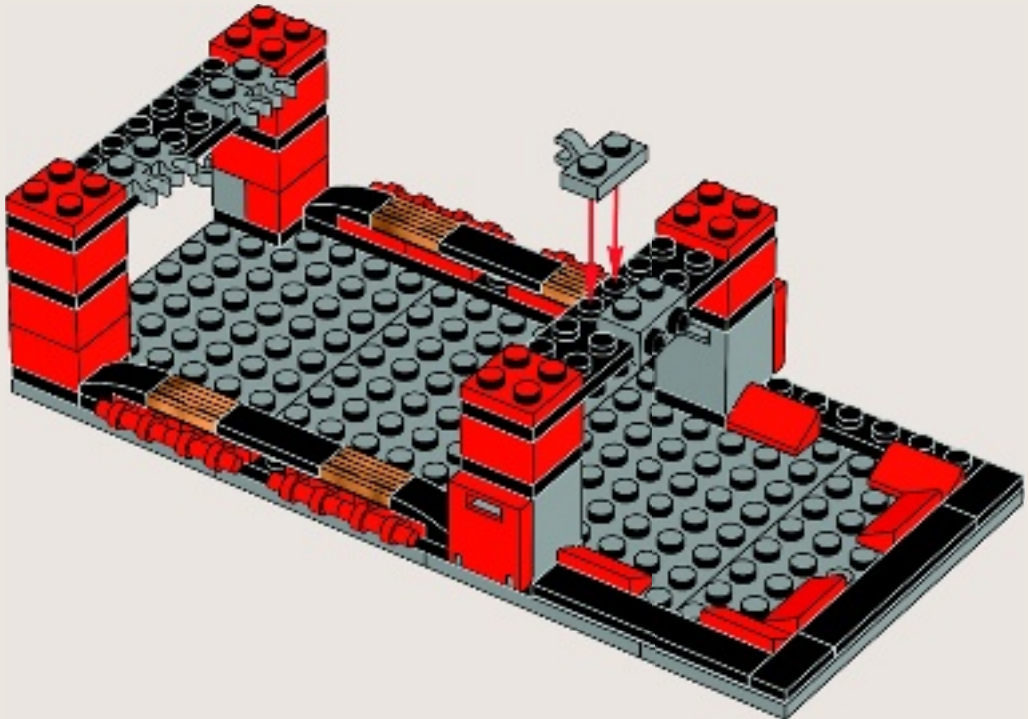

18

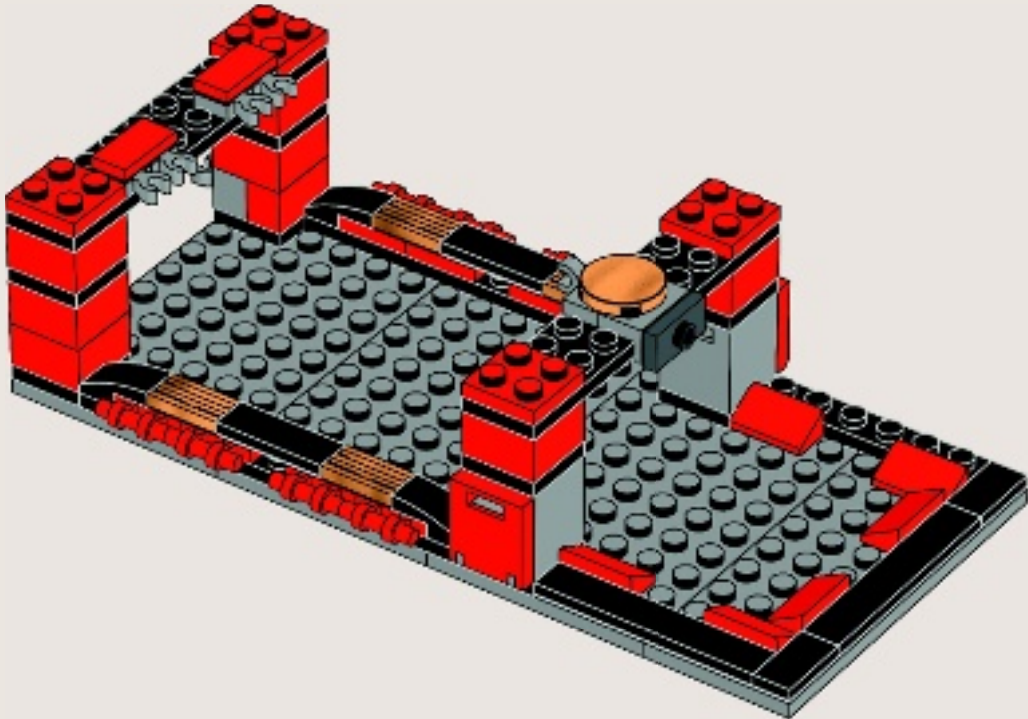

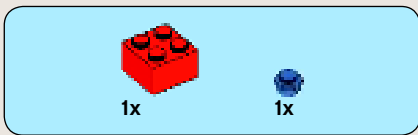

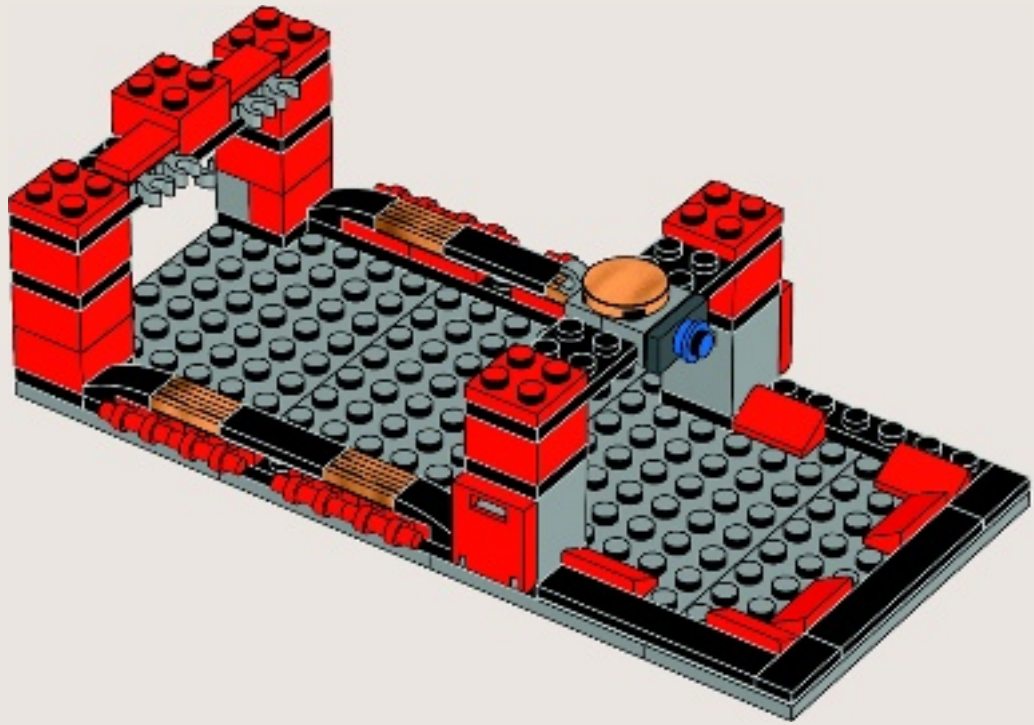

19

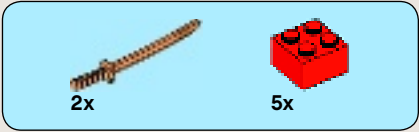

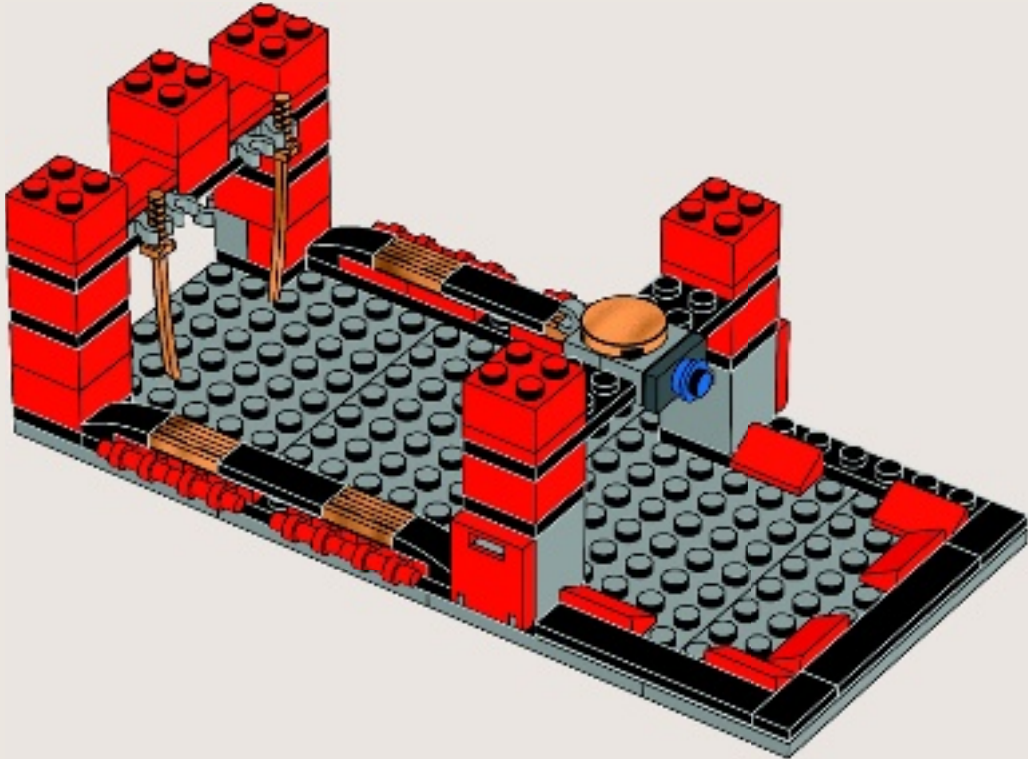

20



4x  4x 

21

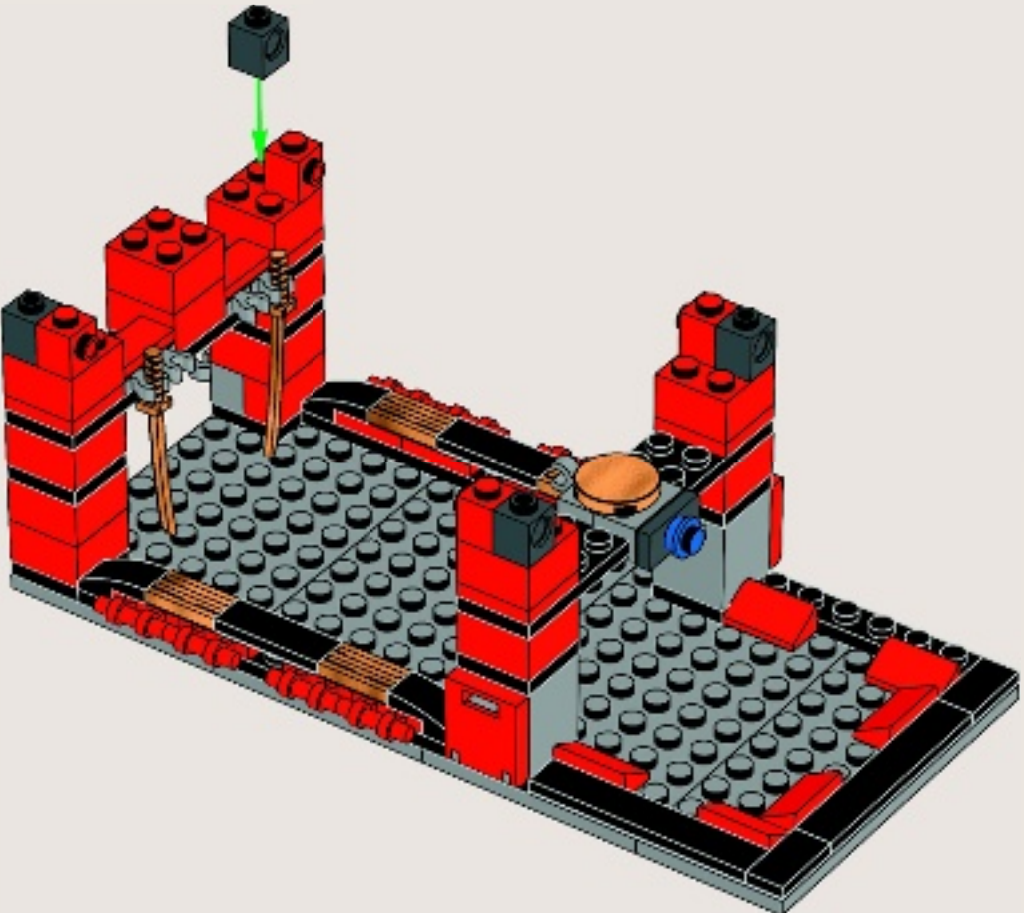



22

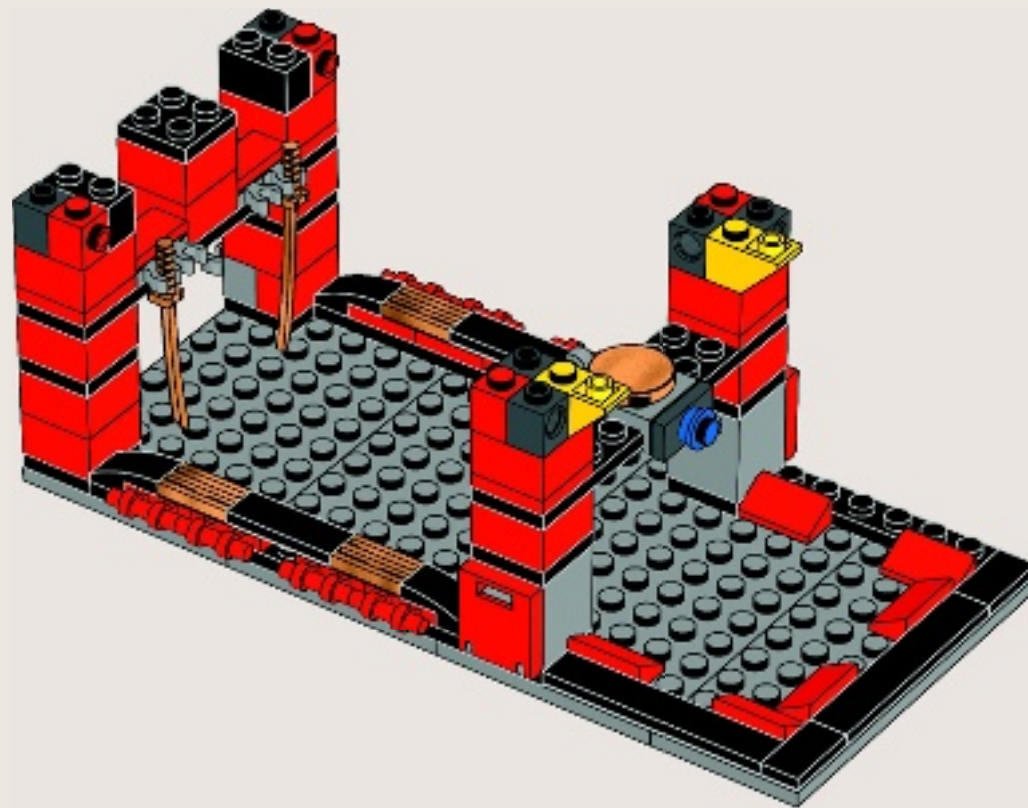



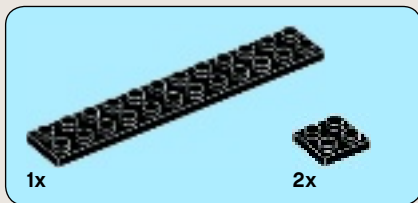

23

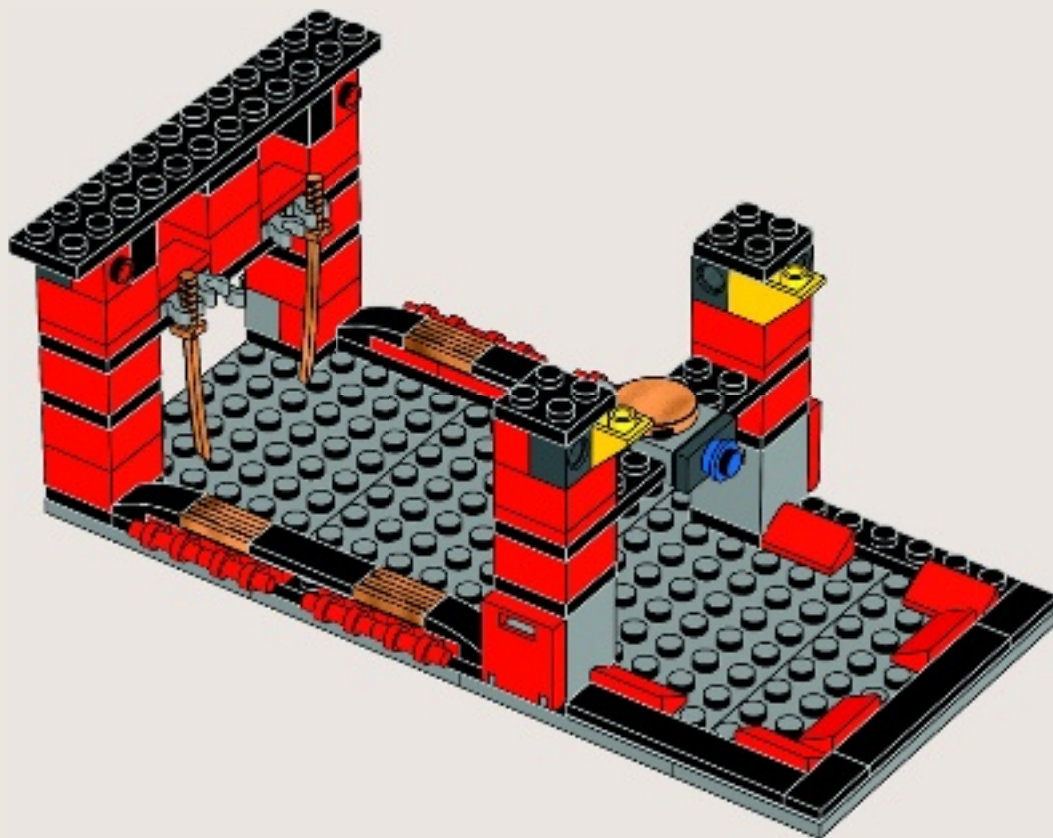



2x



4x

# 24

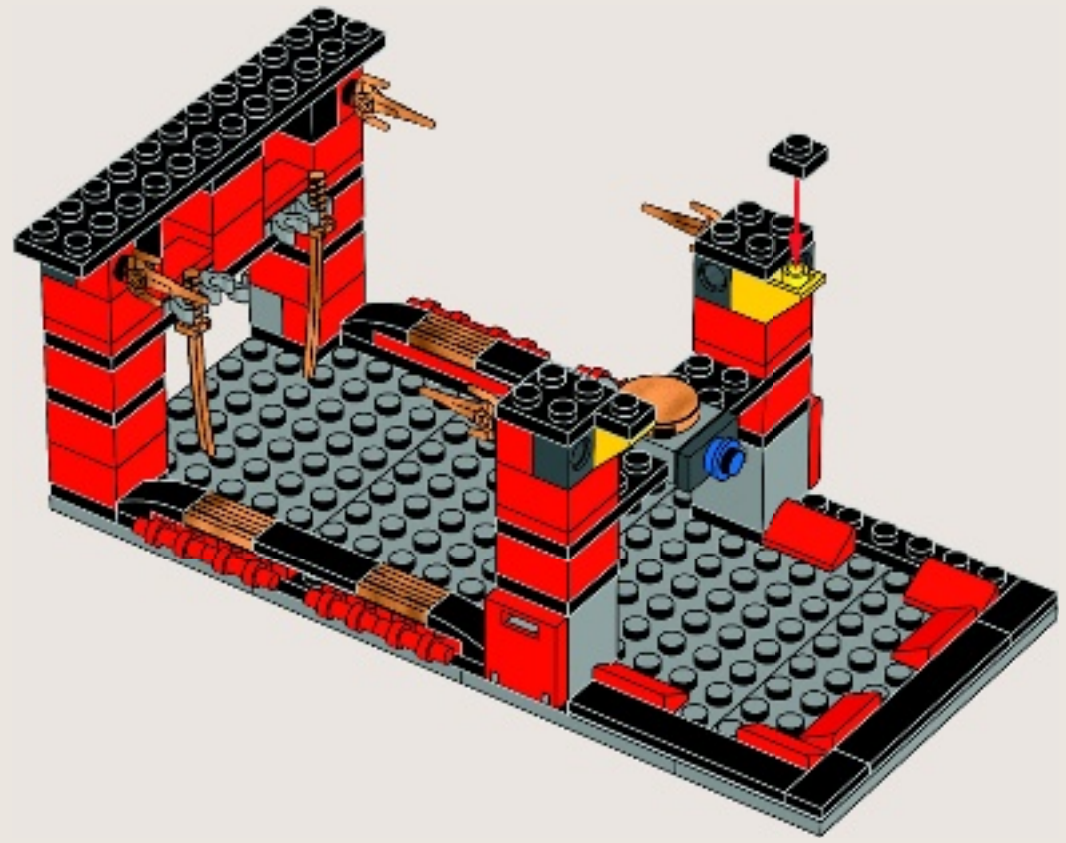

25

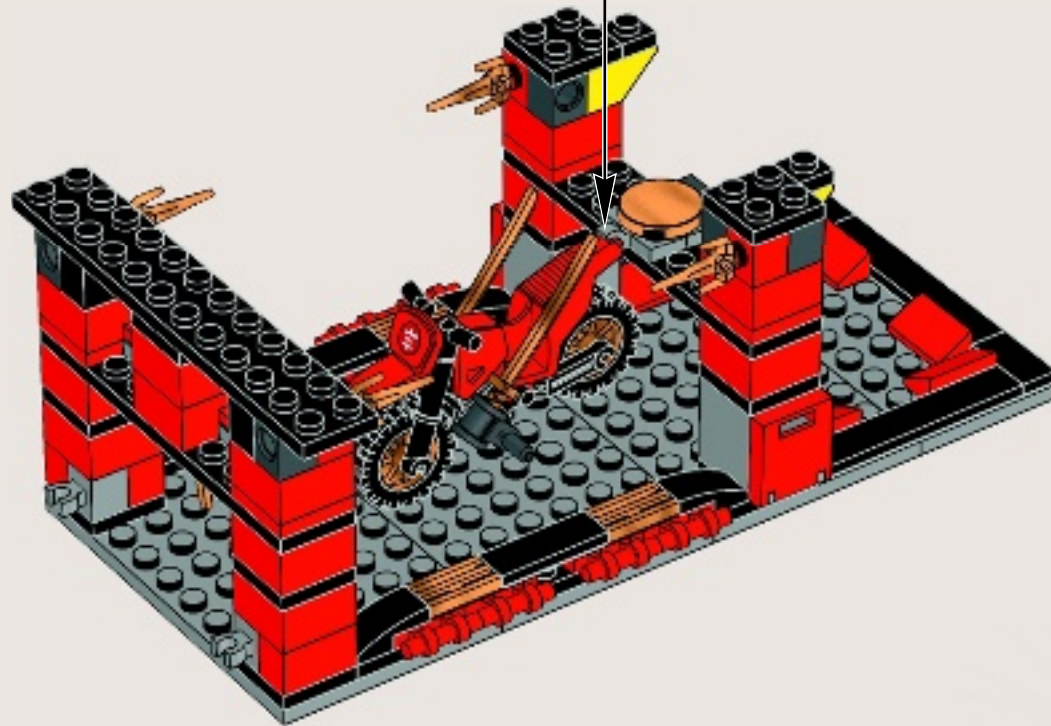

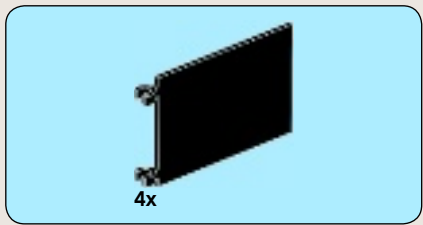

26

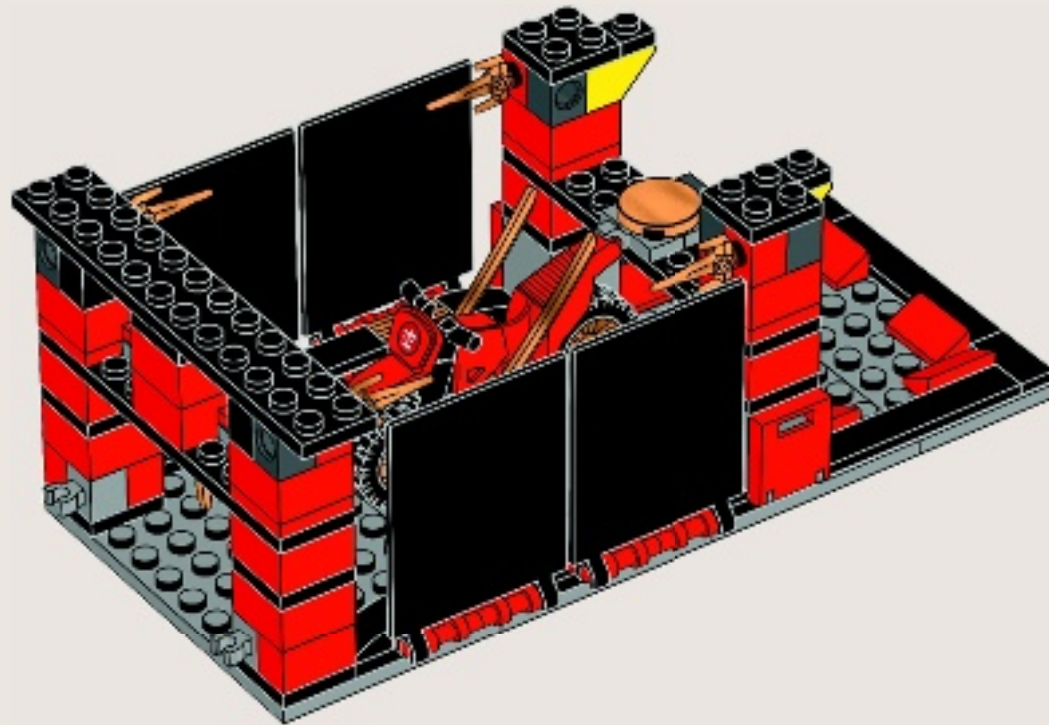

27

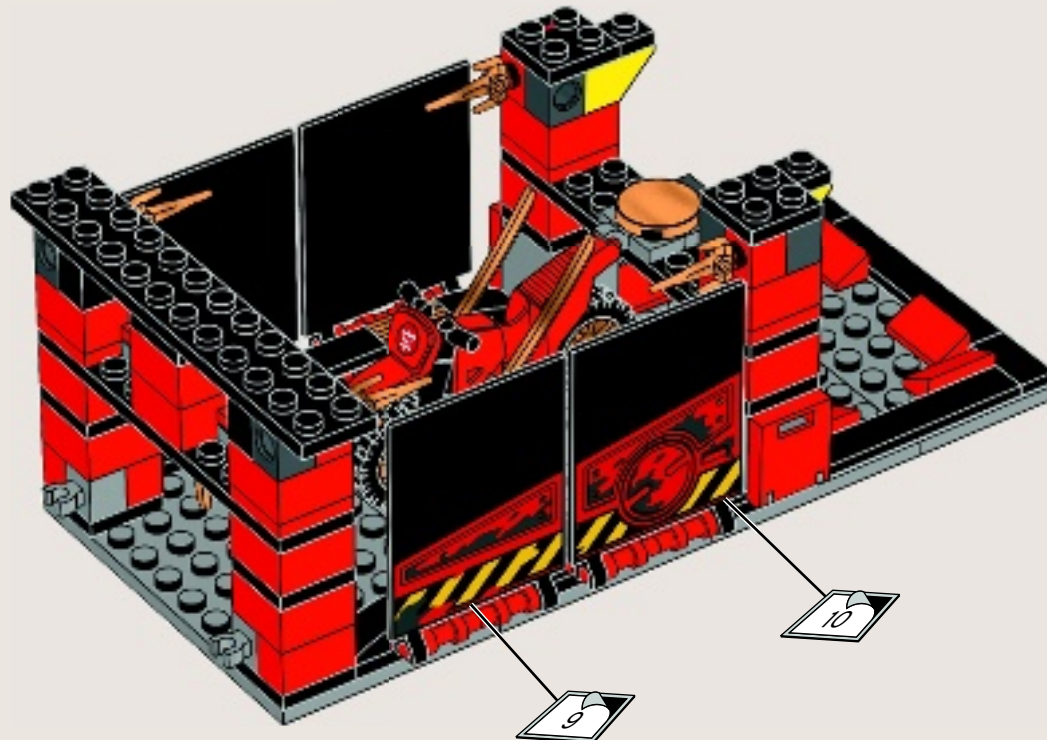

28

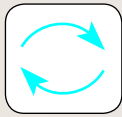

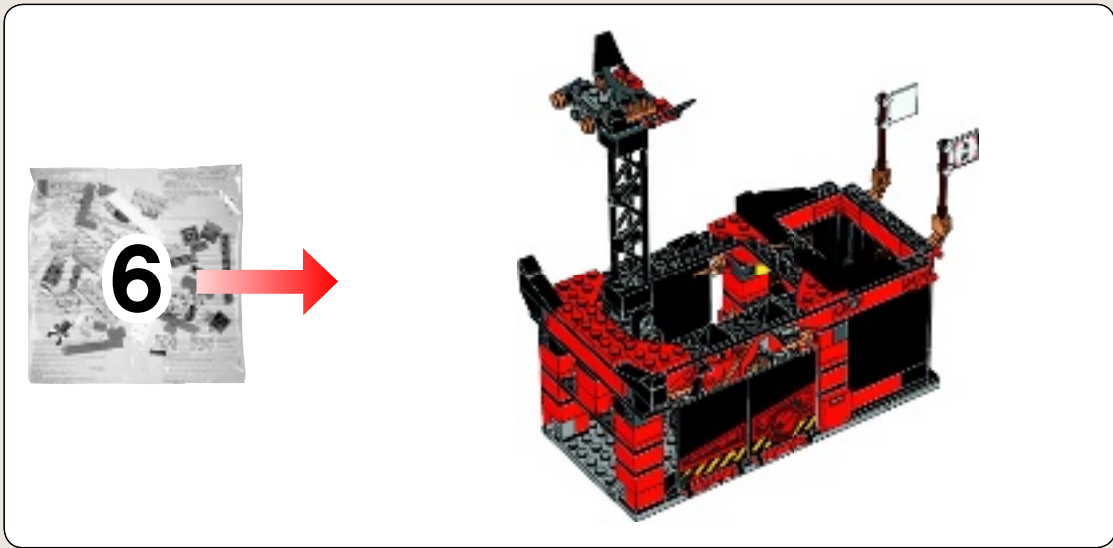

29

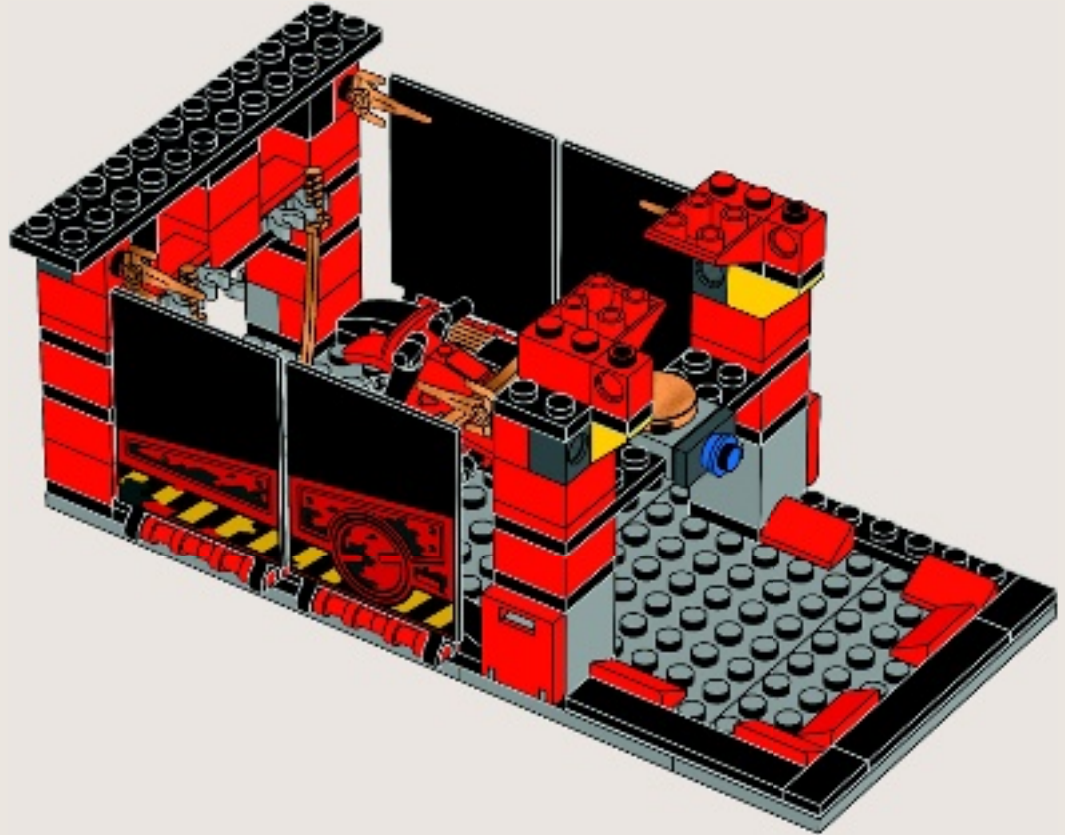
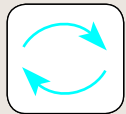



2x



2x

# 30

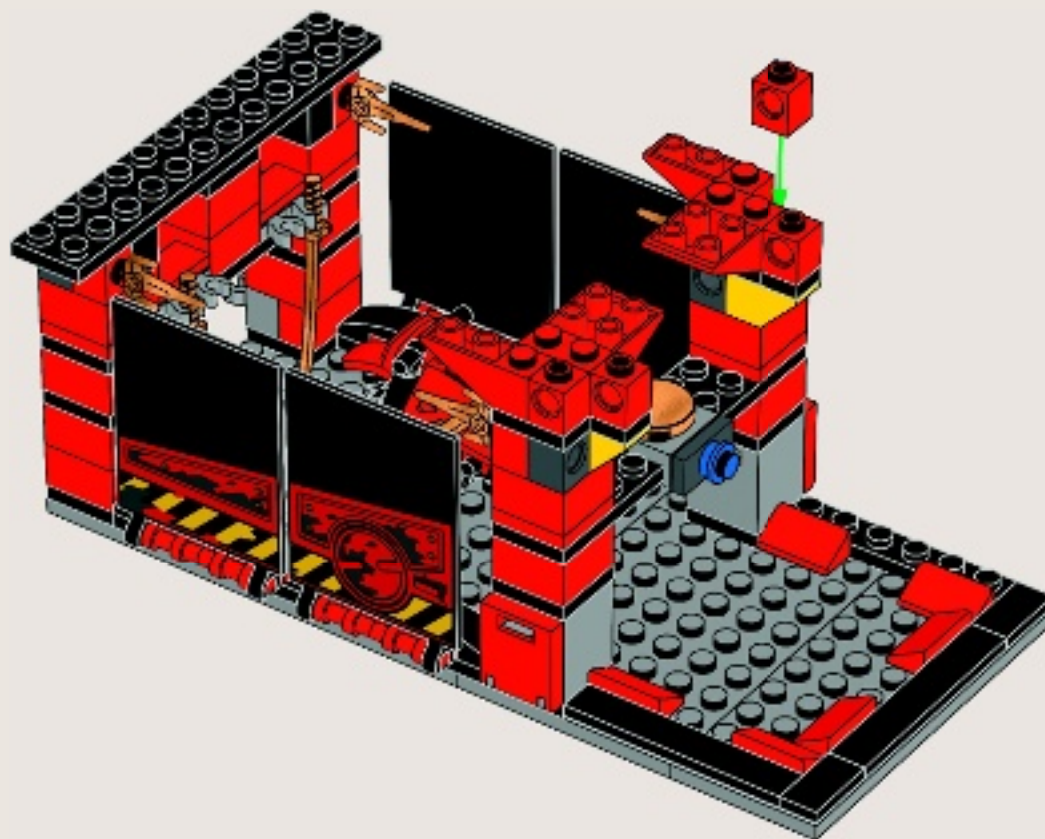



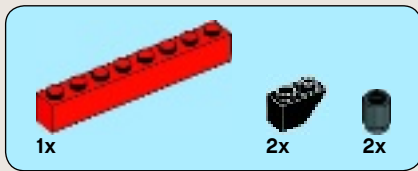

31

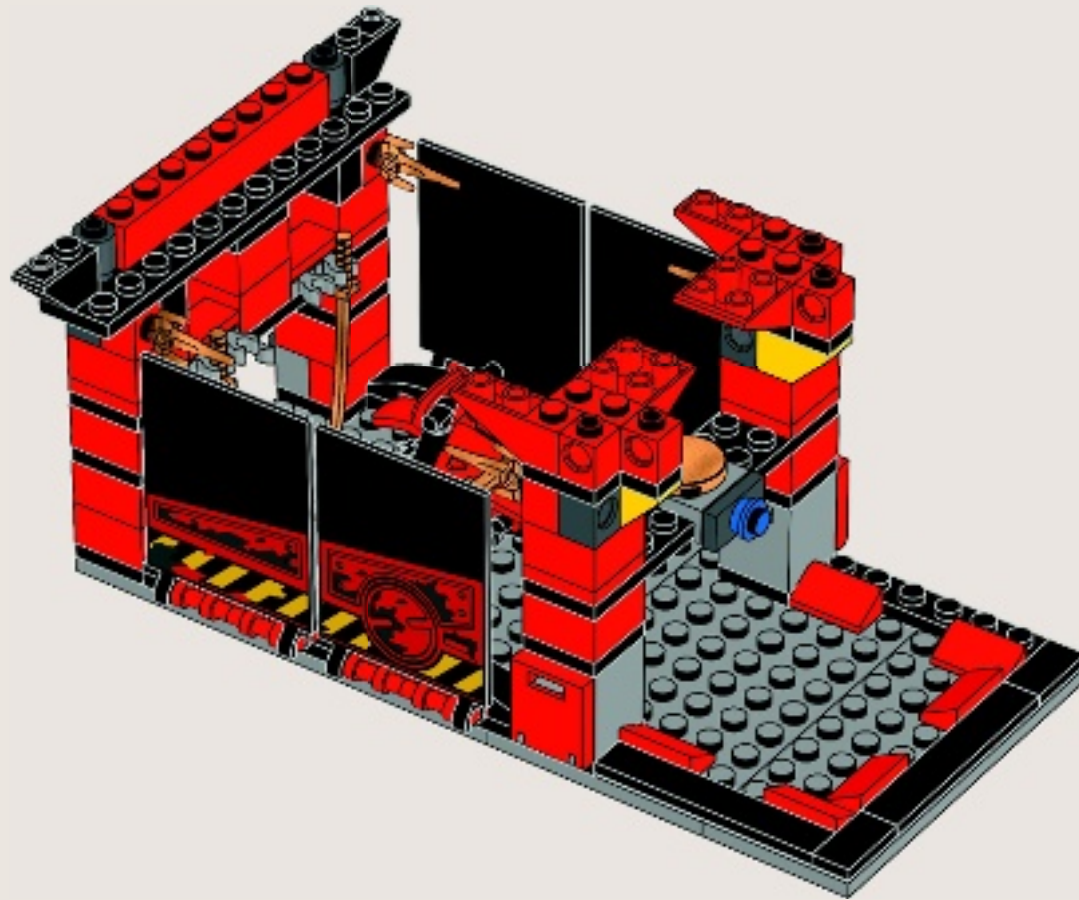



32

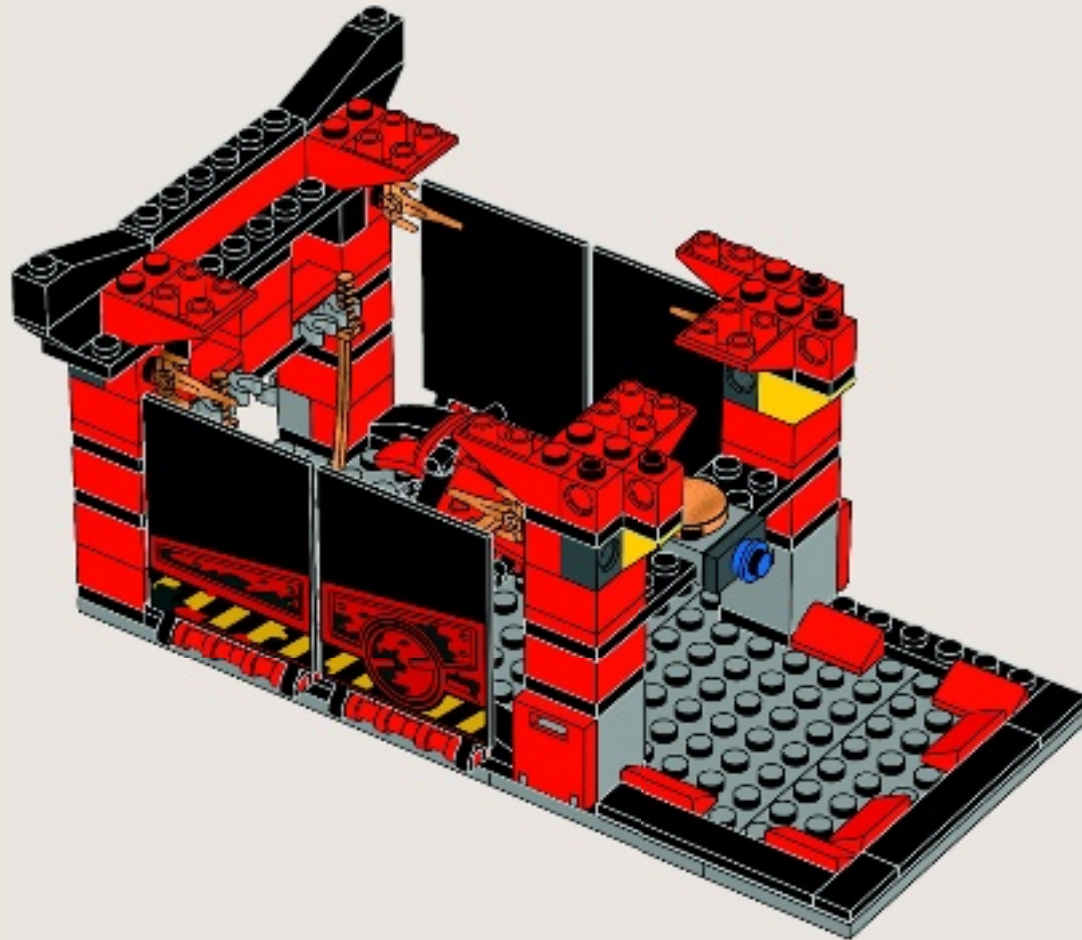



2x

33

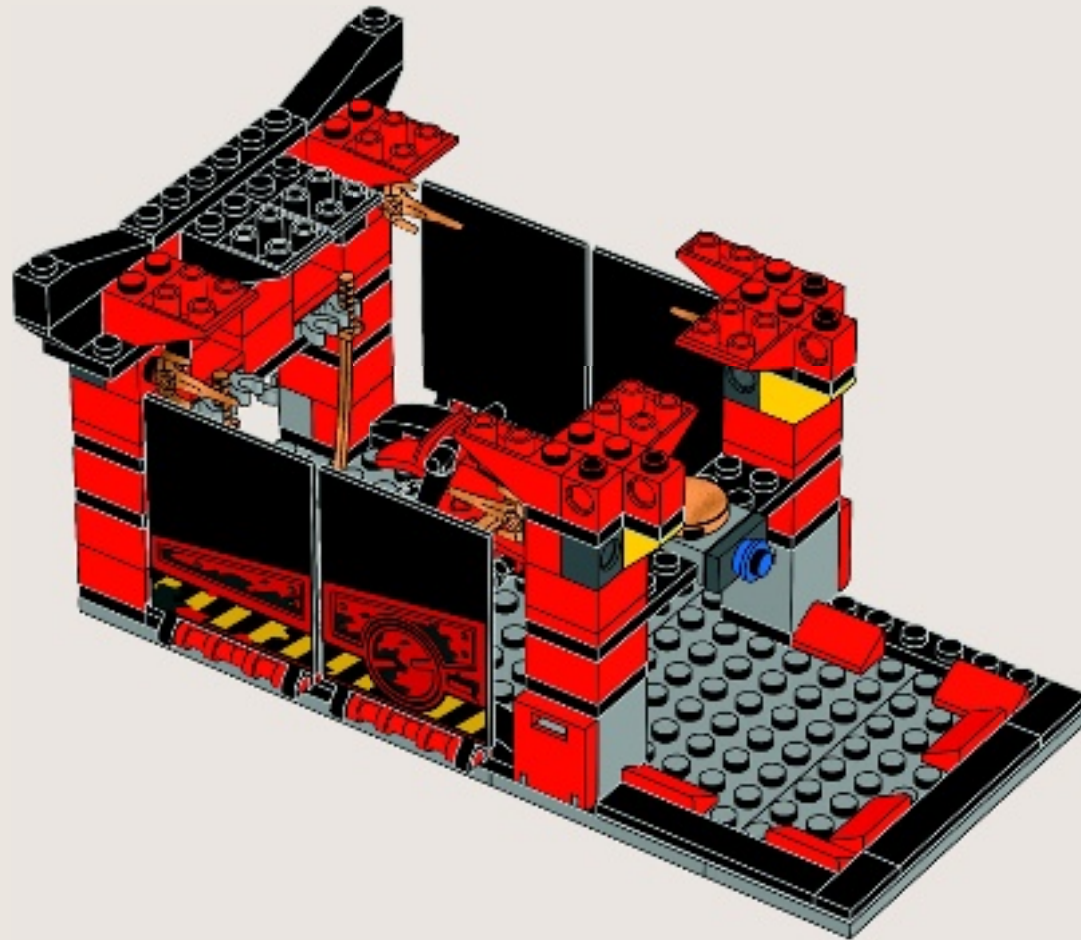



34

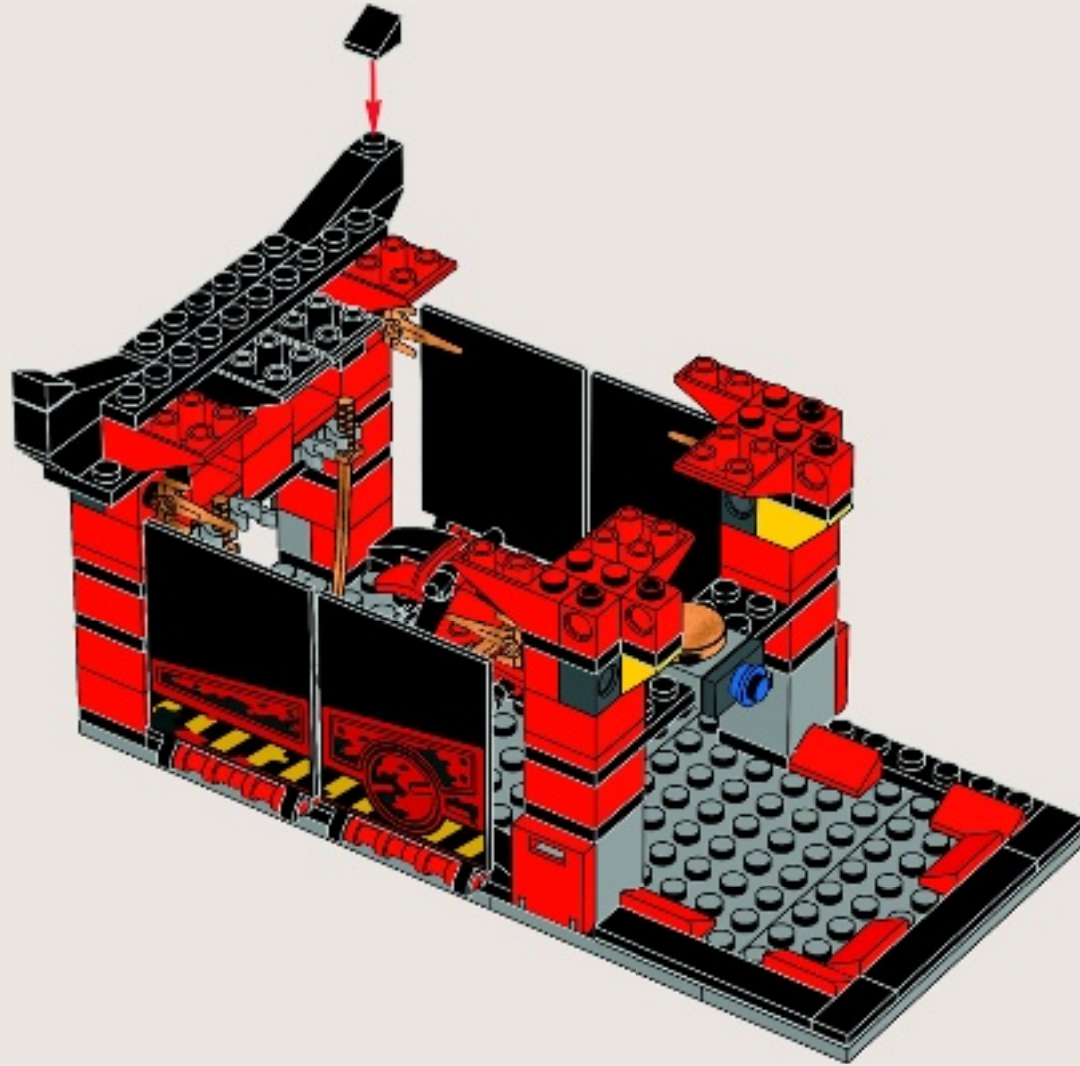

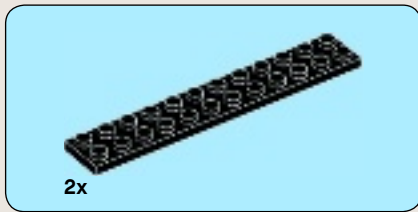

35

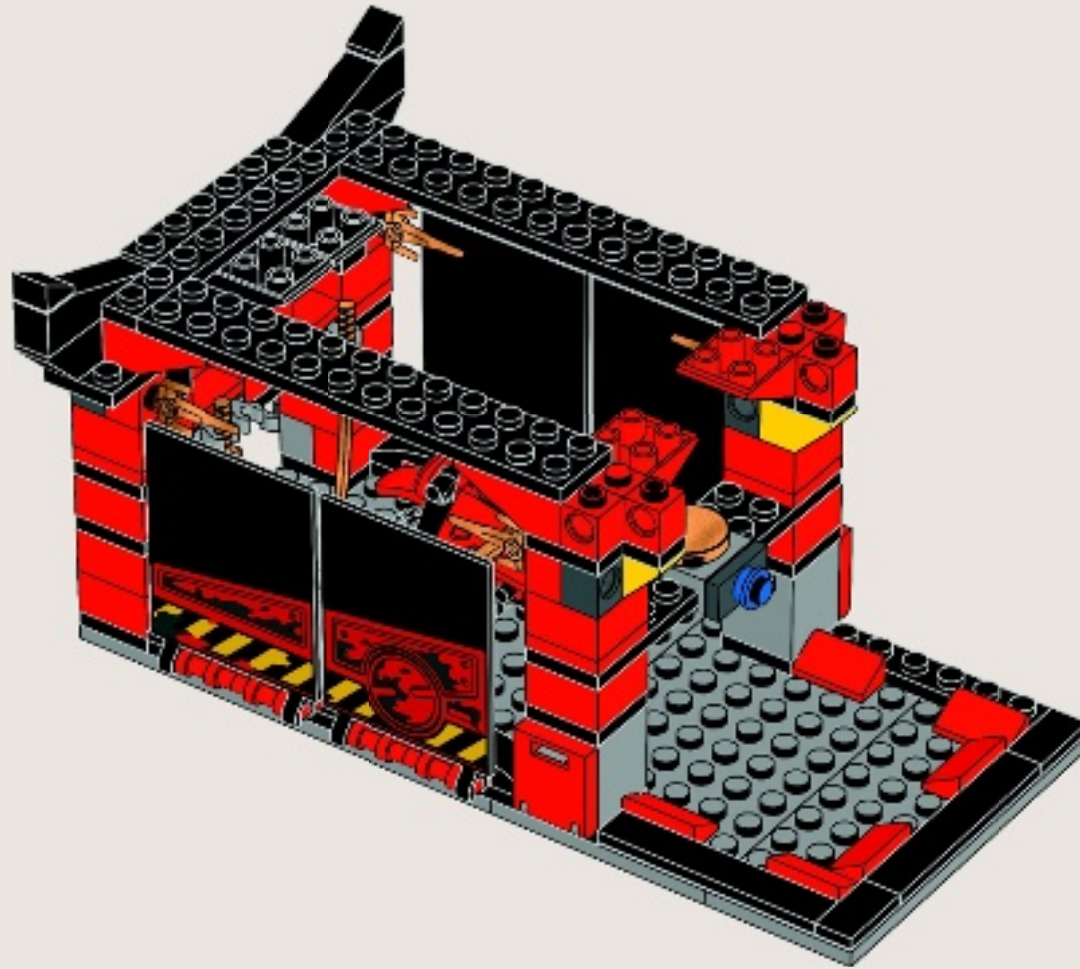

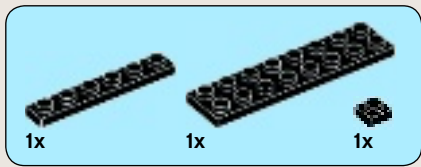

36





1

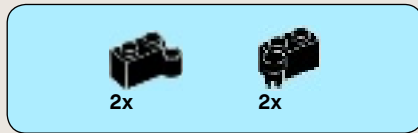

2

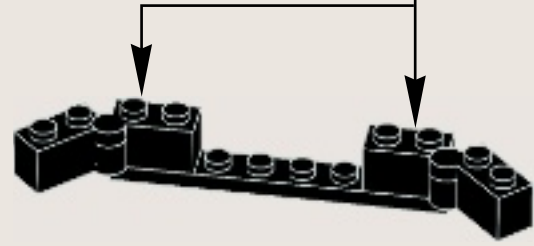
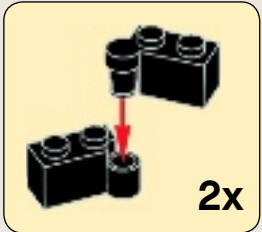

3



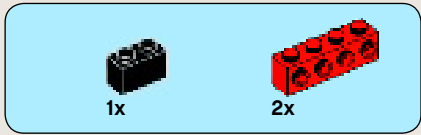

4



5

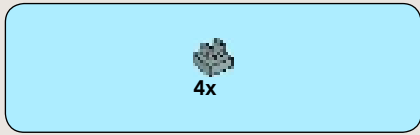
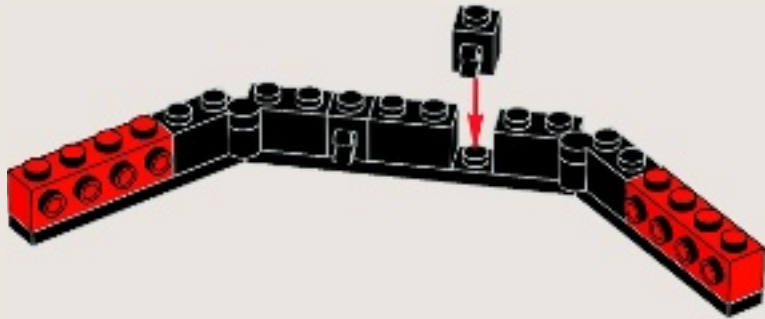

6





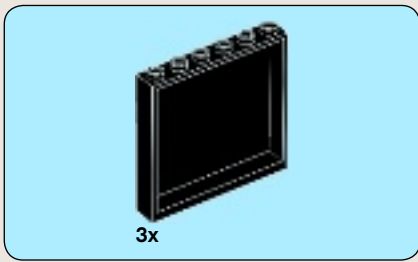

7

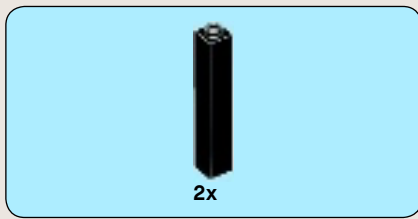
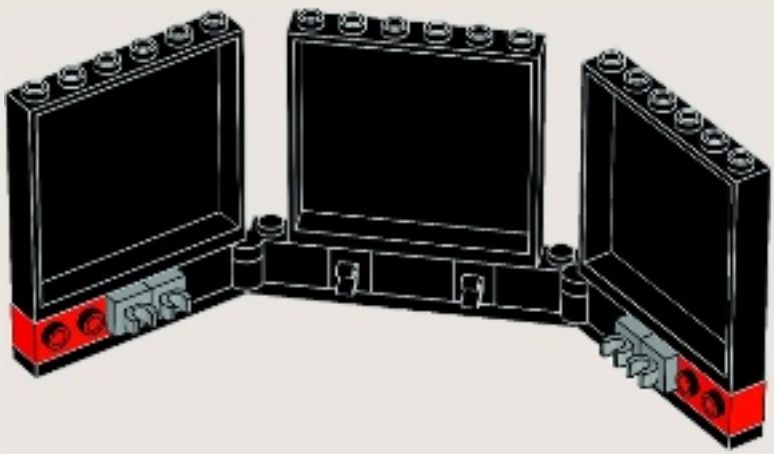

8

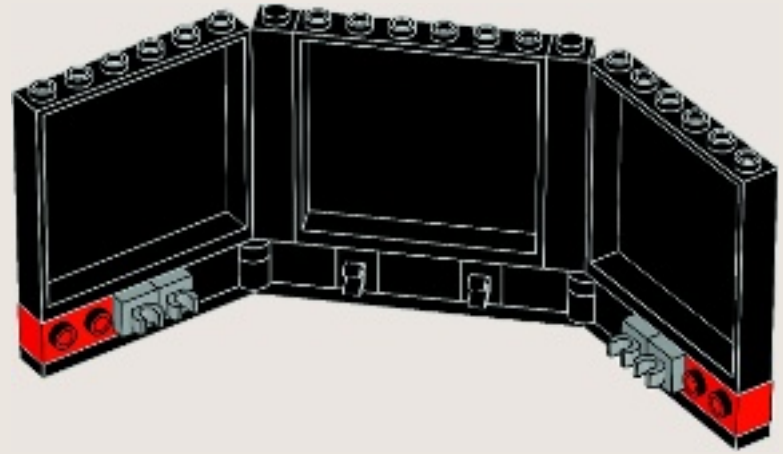



9

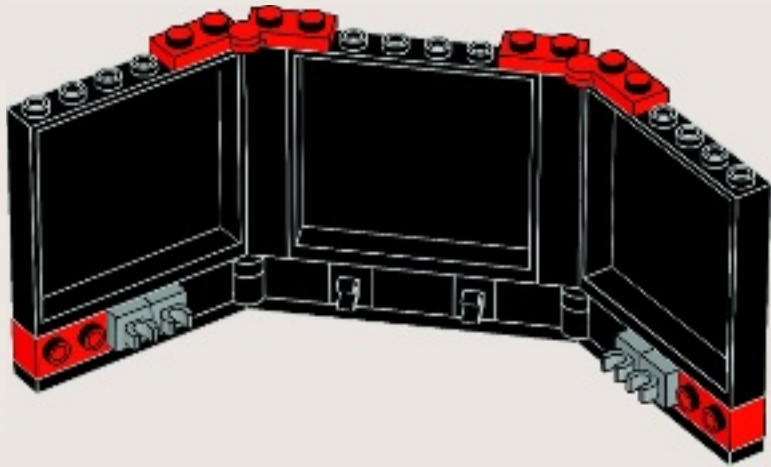

10

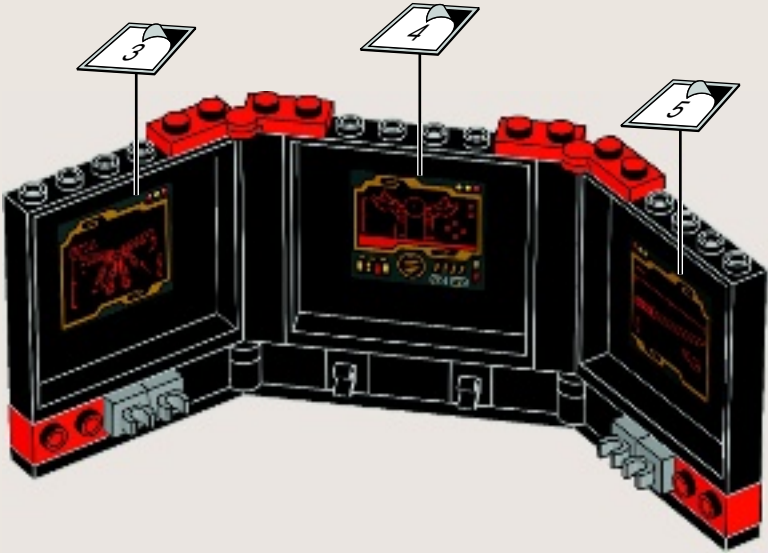

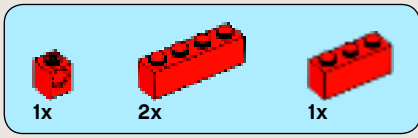

11

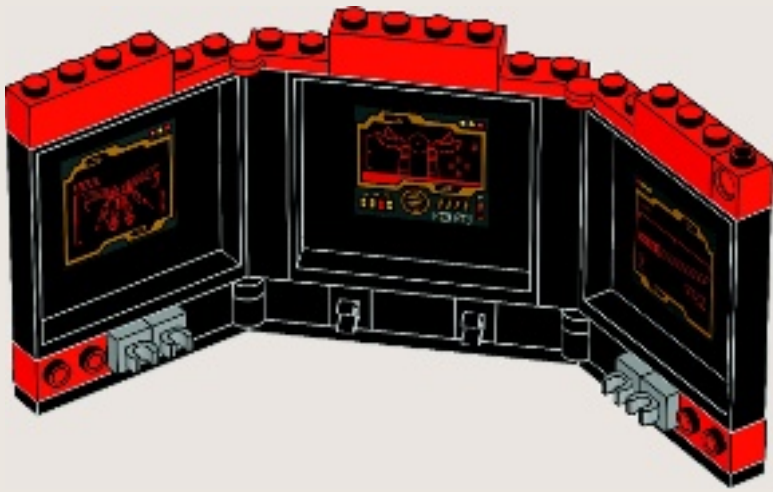

12

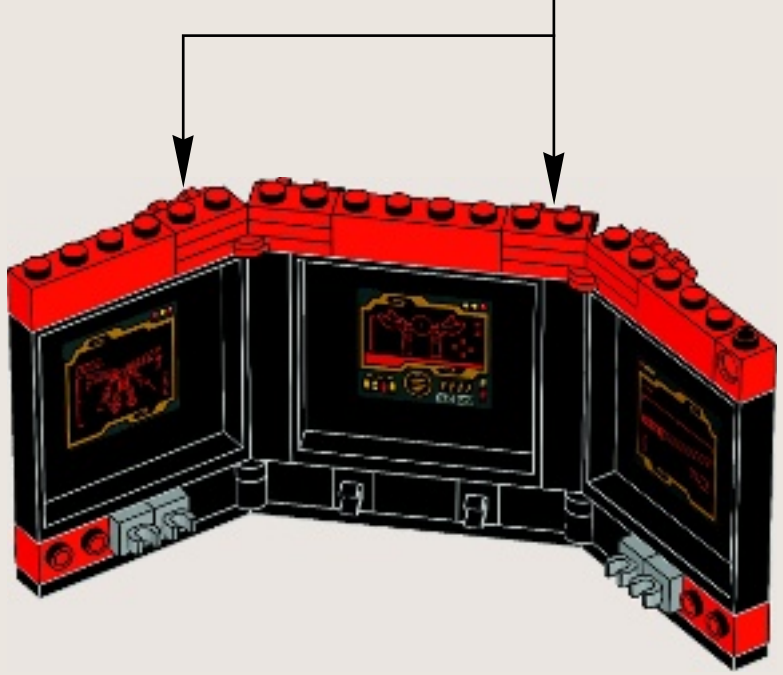
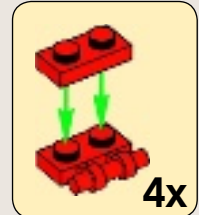

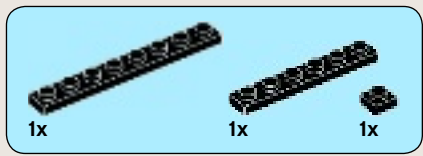

13

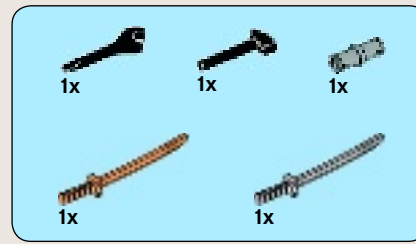

14



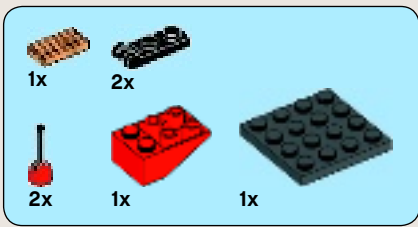

15

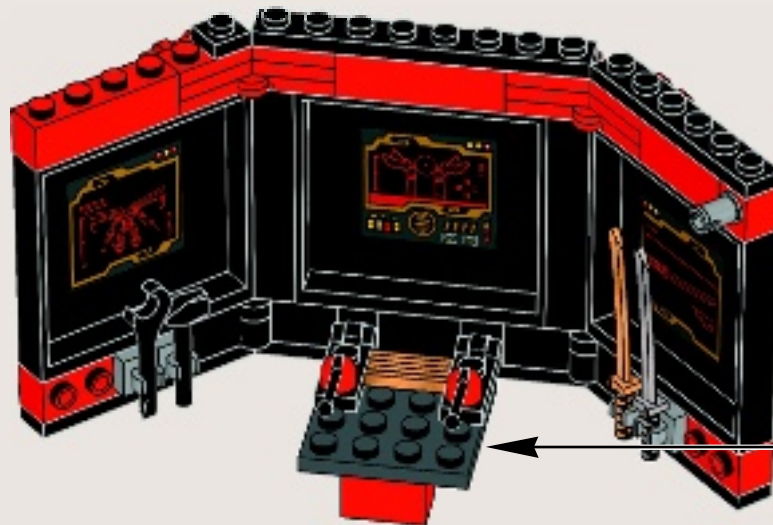
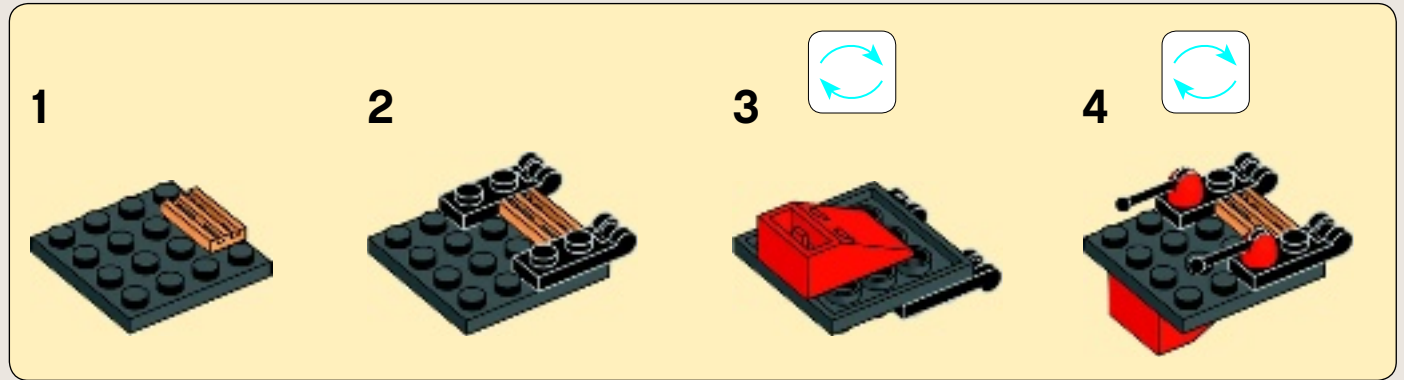

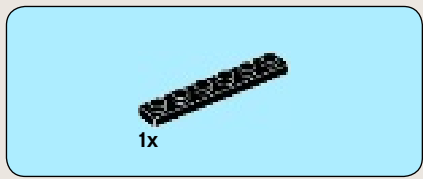

37

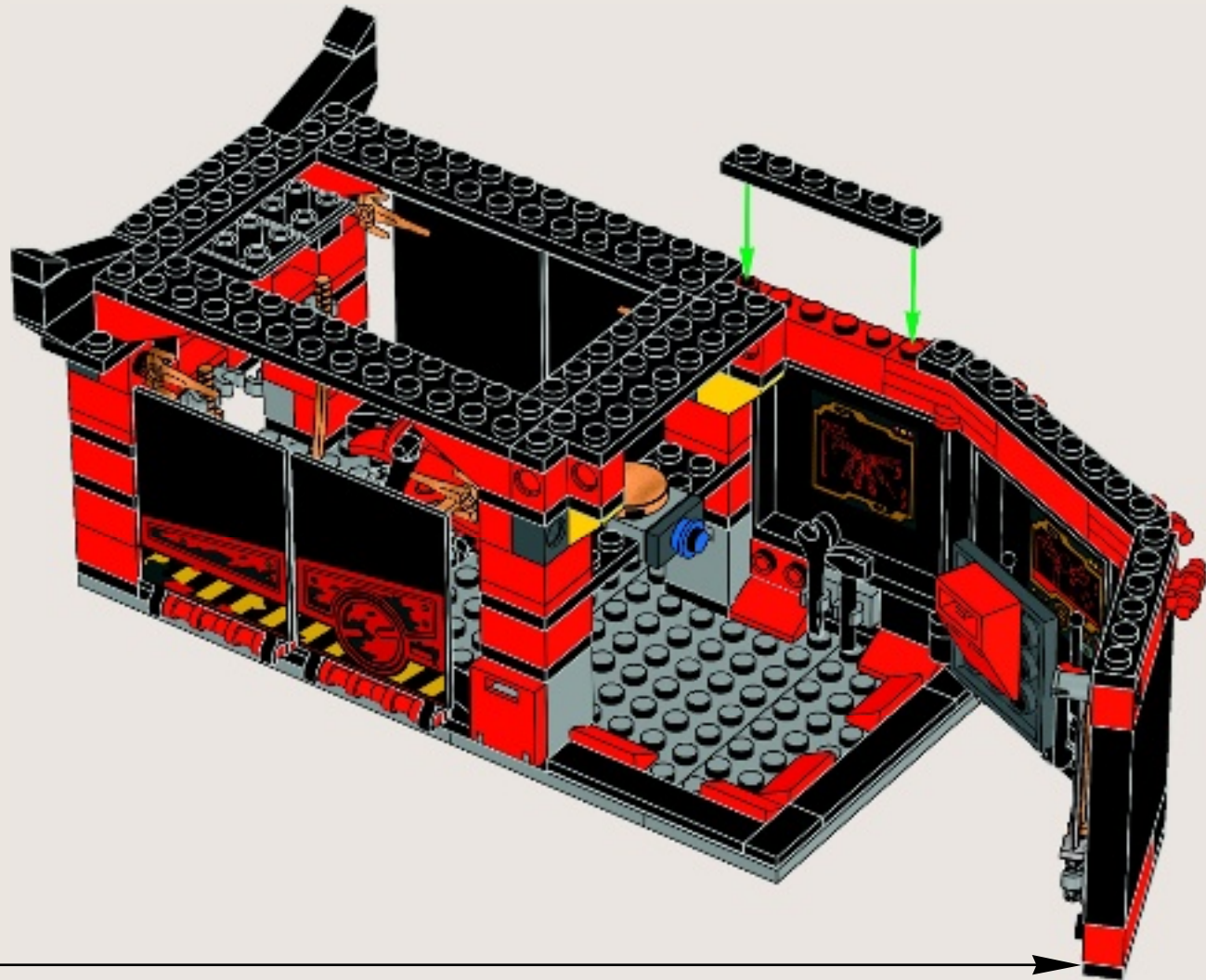

38



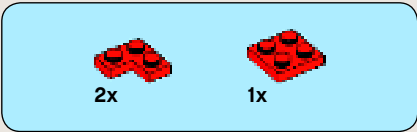

39

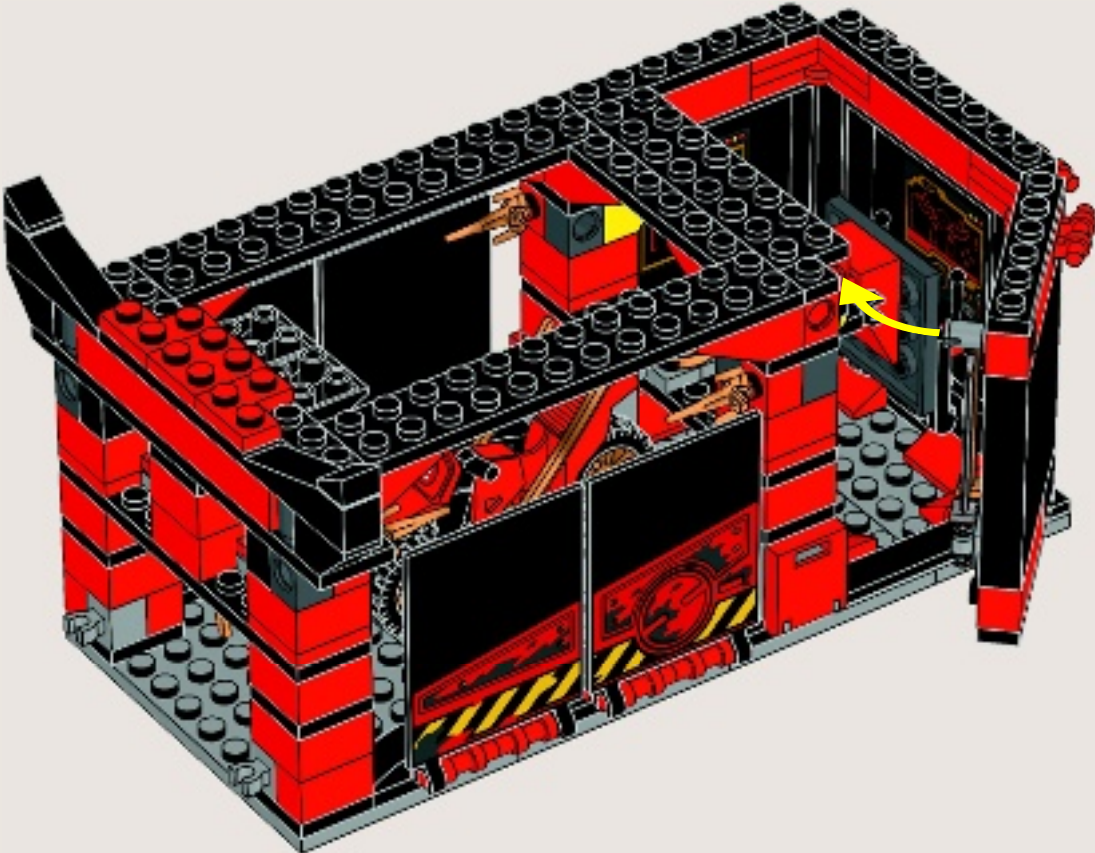



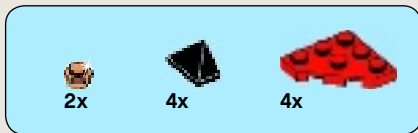

40

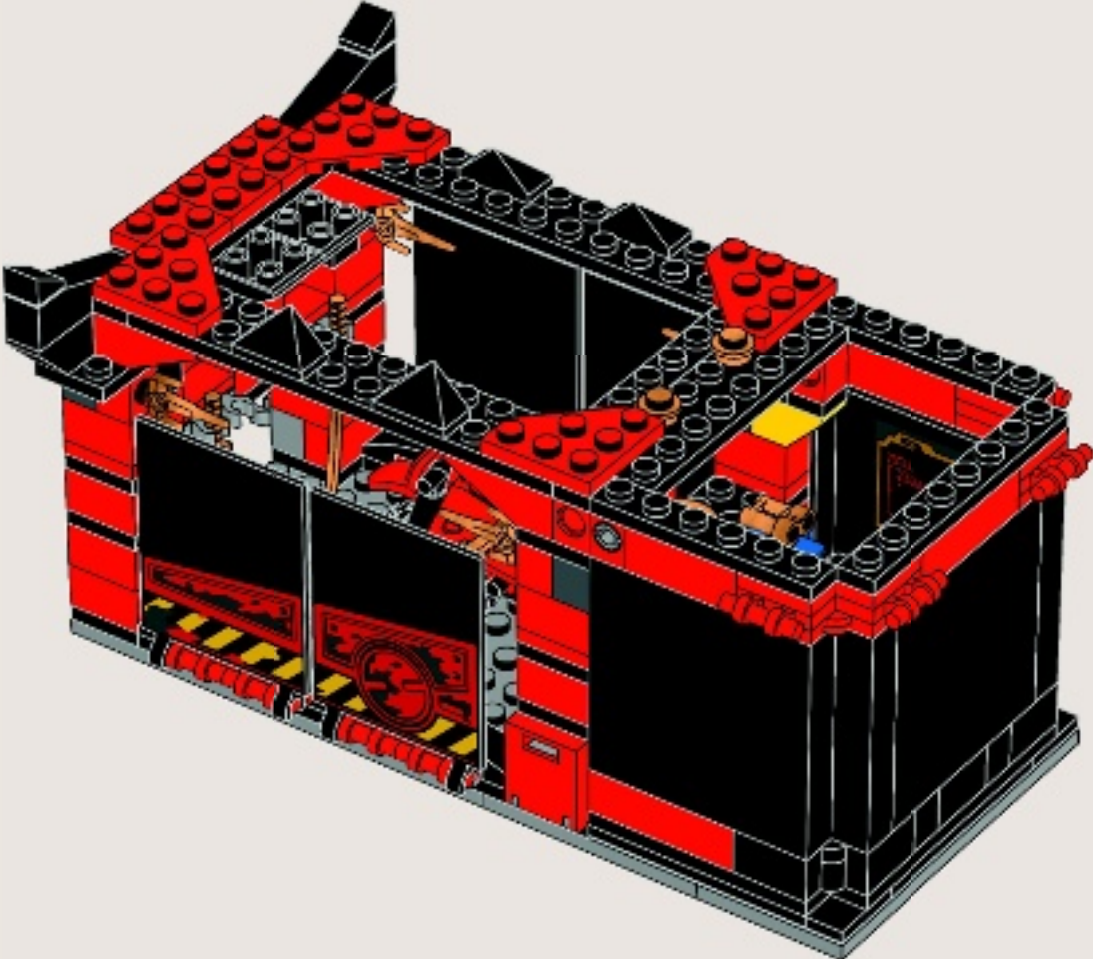

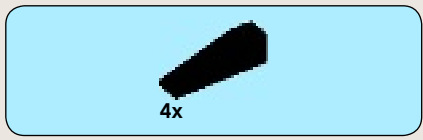

41

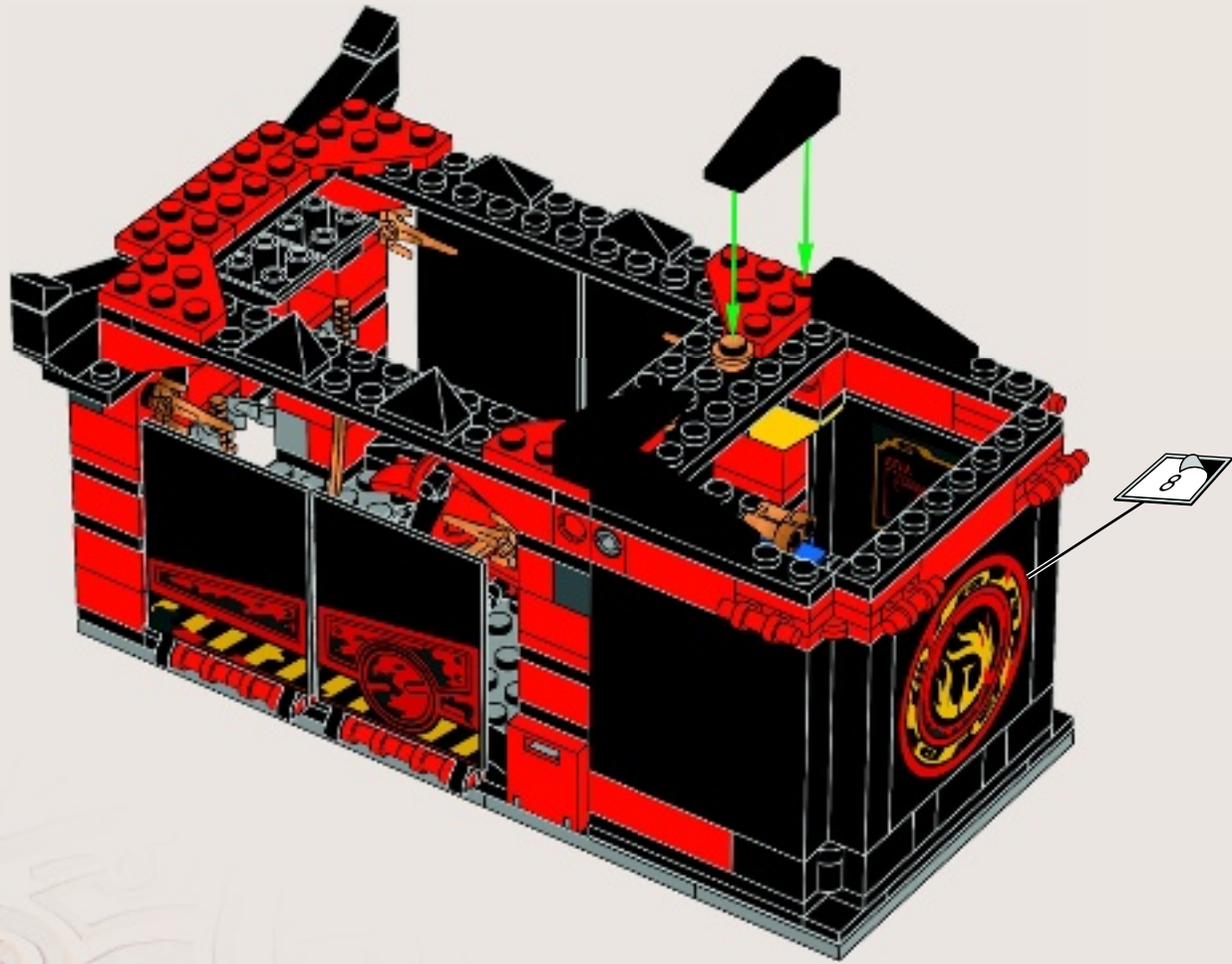

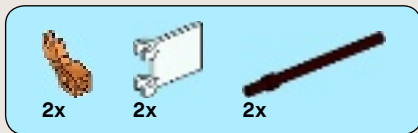

42

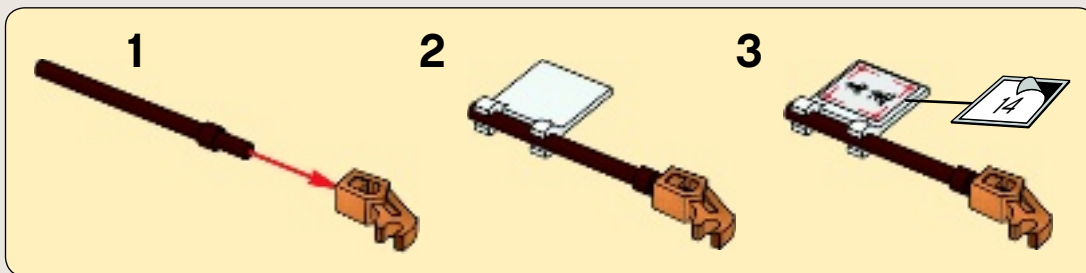
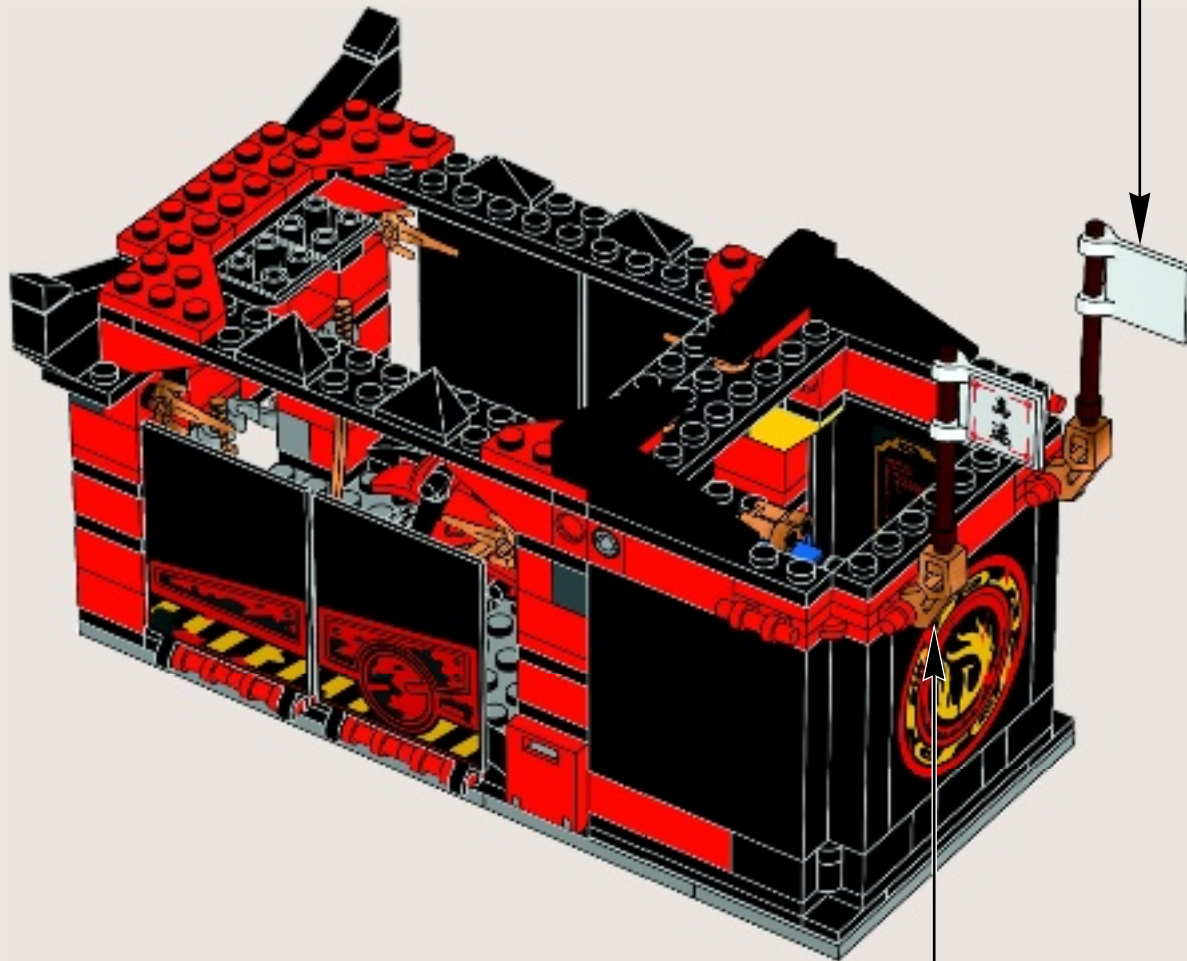

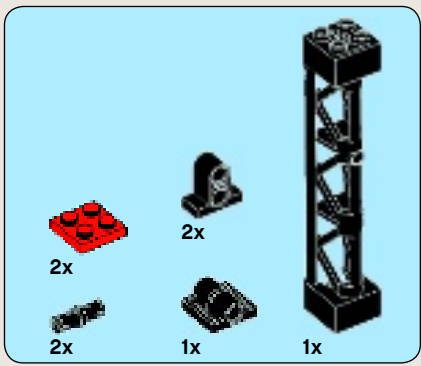

43

1



2

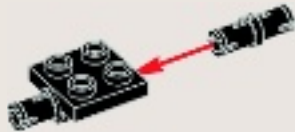

3



4



5

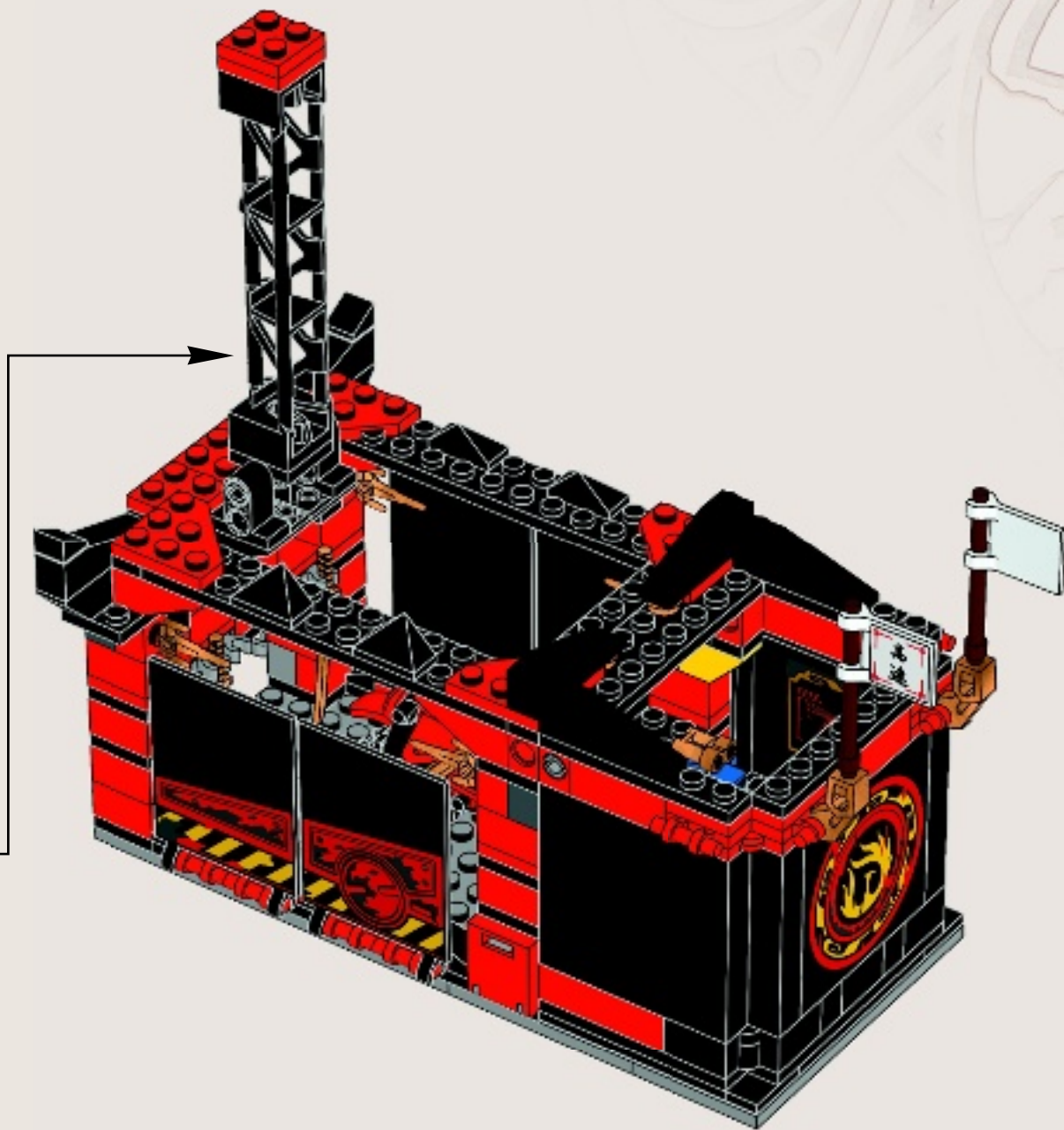



1

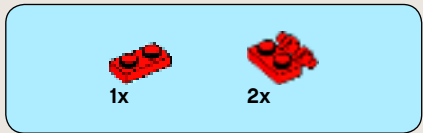

2

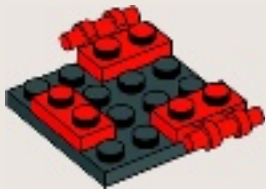

3

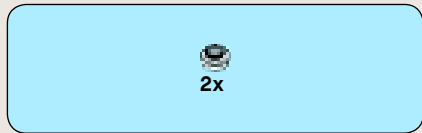

4

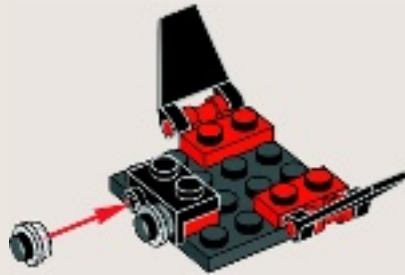

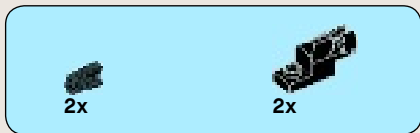

5

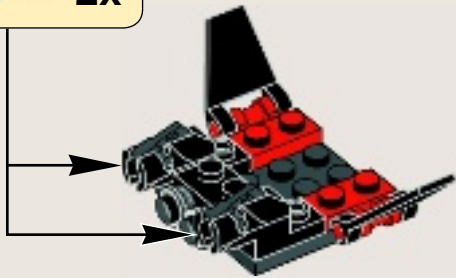
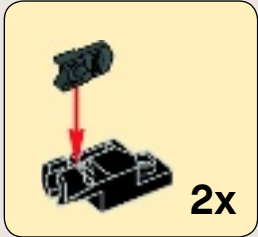

6

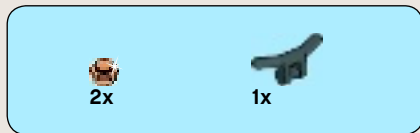
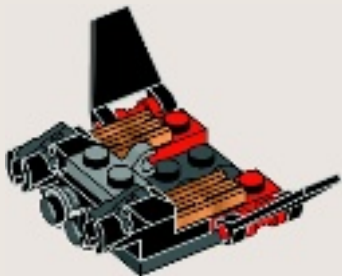

7

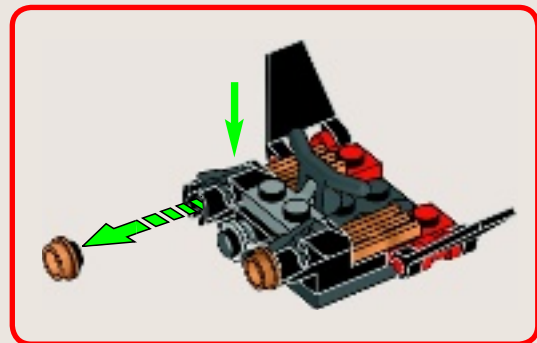
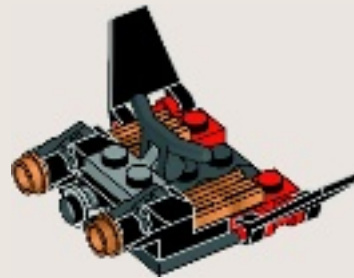

44

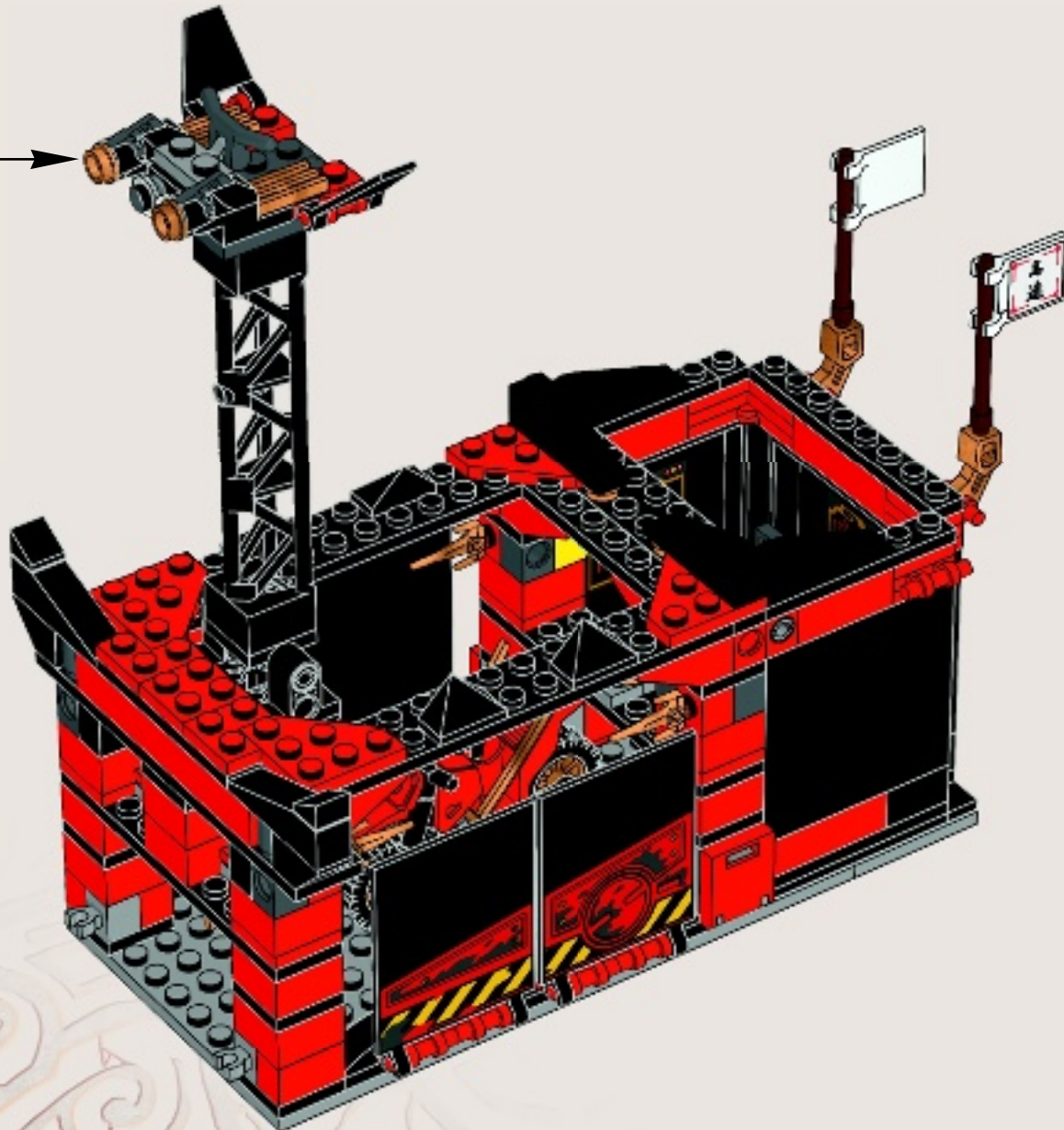





# 45

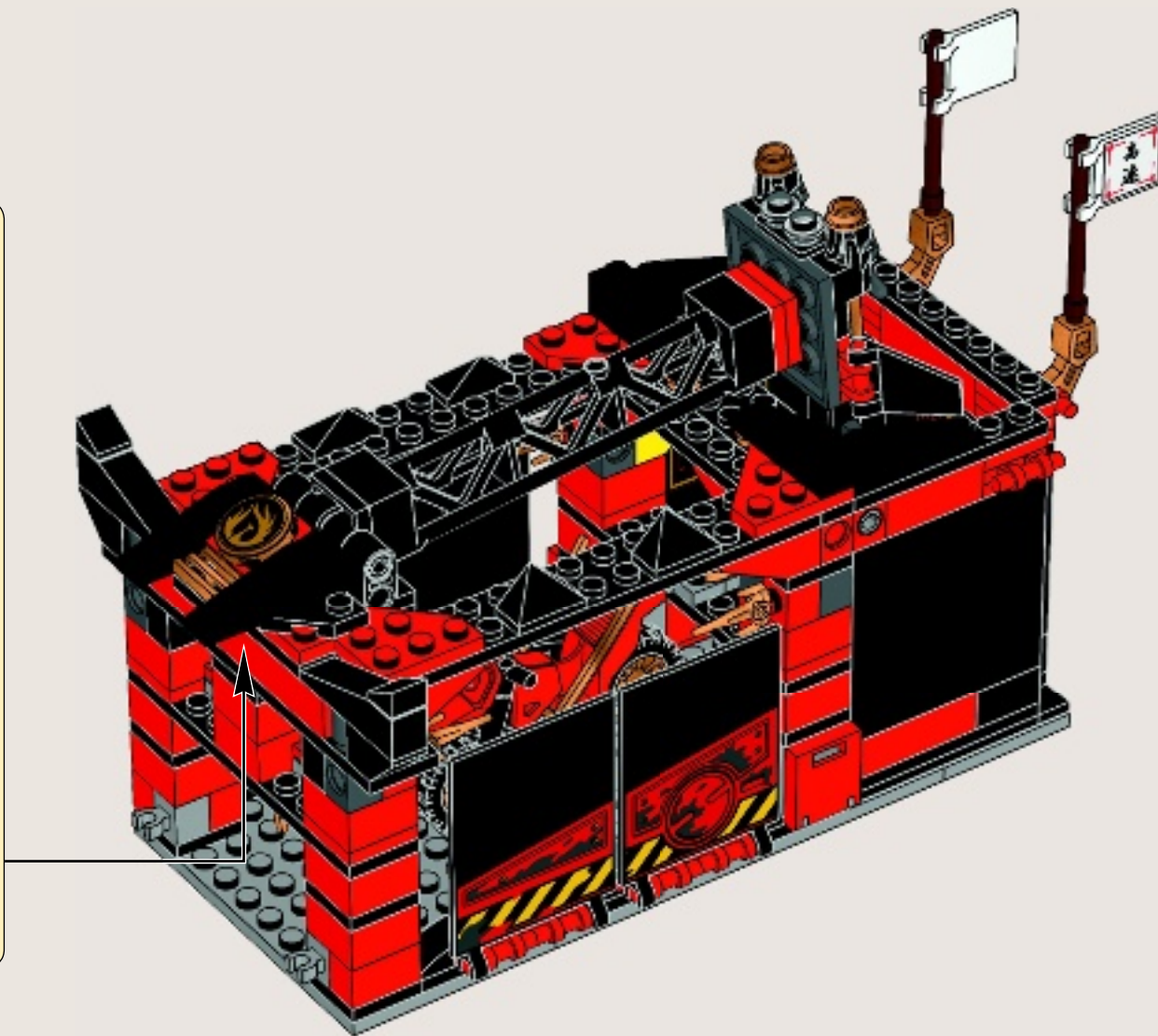
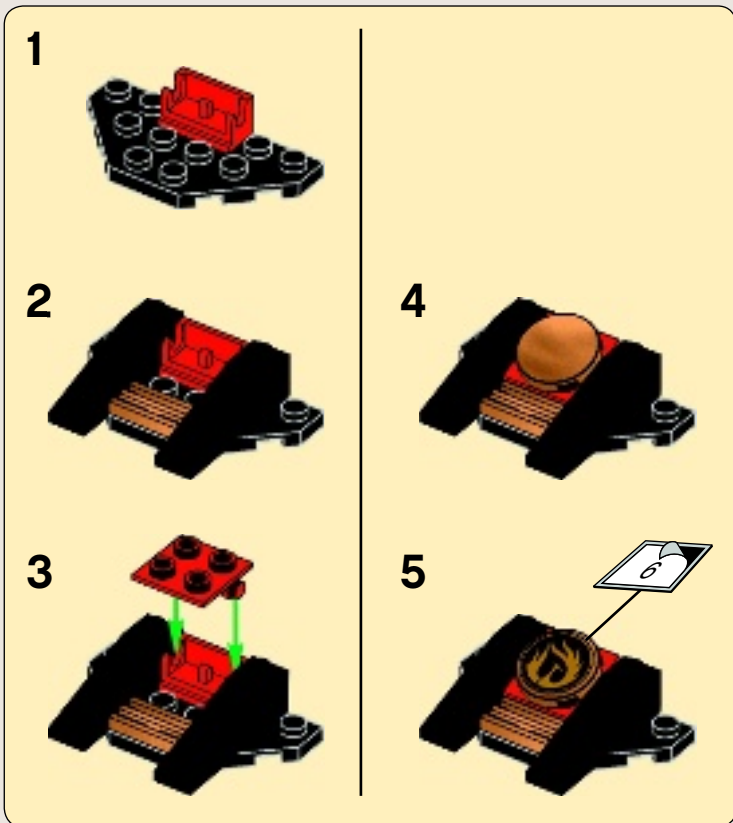

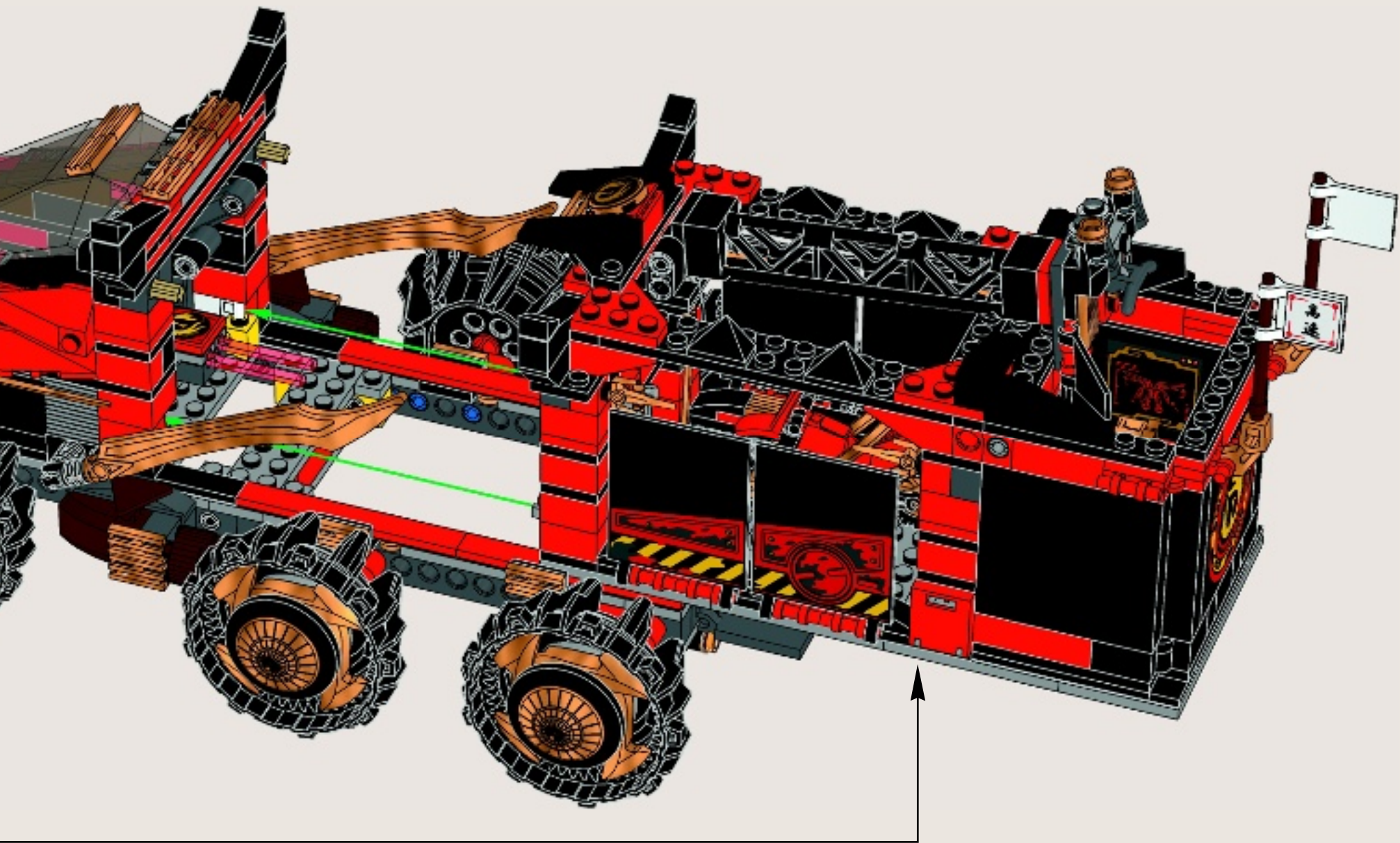

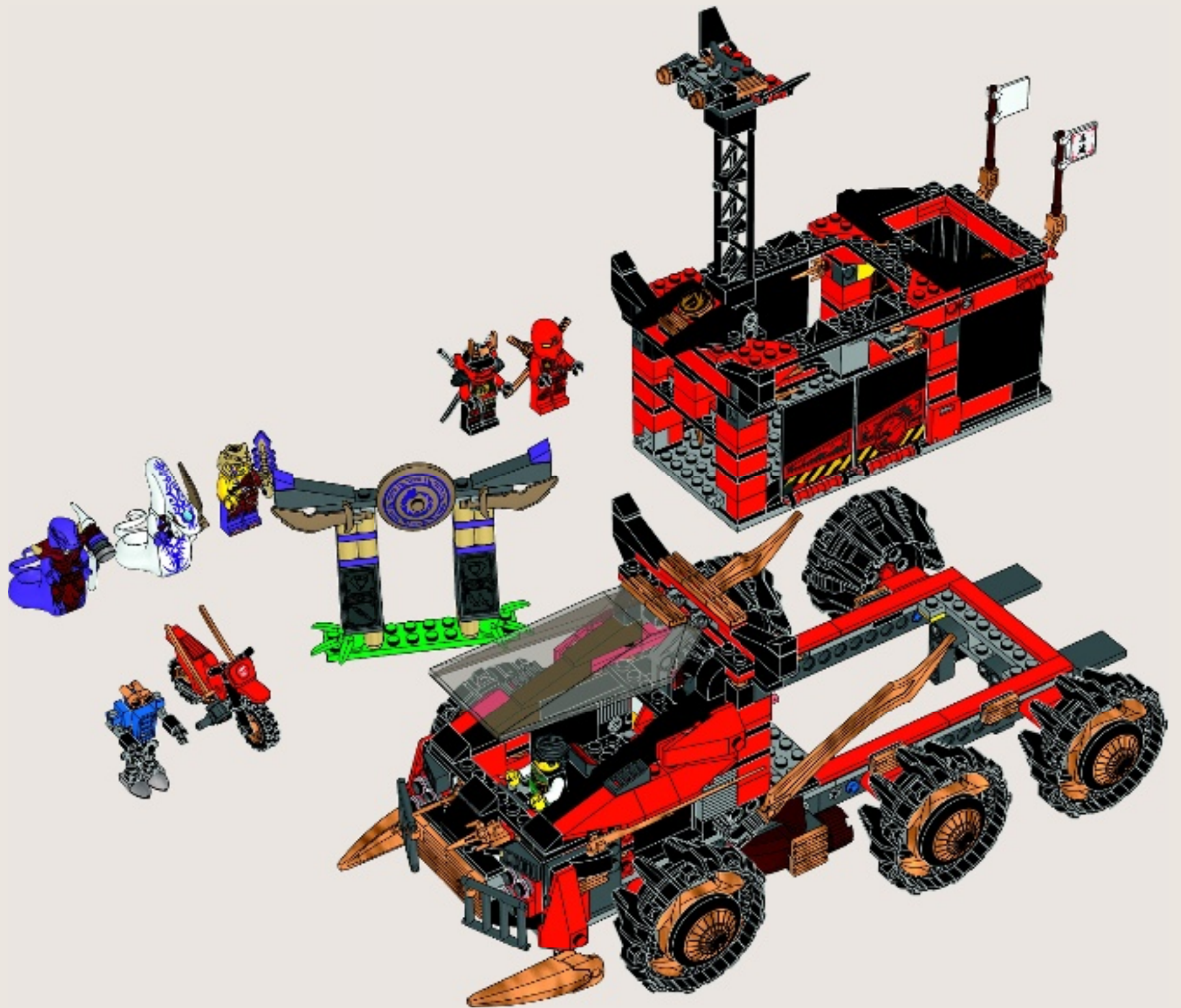

|               |               |                |                |               |               |               |               |               |
|---------------|---------------|----------------|----------------|---------------|---------------|---------------|---------------|---------------|
| 3x<br>300401  | 2x<br>4143832 | 14x<br>302221  | 2x<br>306921   | 1x<br>300924  | 2x<br>4535765 | 1x<br>281726  | 2x<br>6011458 | 6x<br>6047276 |
| 2x<br>4119013 | 16x<br>300321 | 2x<br>242021   | 8x<br>302321   | 4x<br>370024  | 2x<br>4162443 | 2x<br>4183060 | 2x<br>383126  | 4x<br>306926  |
| 2x<br>6011794 | 2x<br>362321  | 4x<br>362321   | 1x<br>306821   | 2x<br>370124  | 1x<br>6012983 | 2x<br>4515368 | 2x<br>6102734 | 6x<br>242026  |
| 1x<br>6081986 | 2x<br>235721  | 1x<br>371021   | 1x<br>74335    | 2x<br>370124  | 2x<br>6012983 | 1x<br>4523339 | 2x<br>4142822 | 4x<br>362326  |
| 1x<br>6096596 | 1x<br>362221  | 1x<br>302021   | 1x<br>6099484  | 4x<br>366524  | 2x<br>370126  | 1x<br>6089577 | 2x<br>4121715 | 6x<br>4558170 |
| 1x<br>6100075 | 2x<br>301021  | 2x<br>366621   | 1x<br>6099779  | 1x<br>302324  | 4x<br>4504382 | 6x<br>396026  | 1x<br>6022242 | 4x<br>371026  |
| 1x<br>6096376 | 2x<br>300121  | 5x<br>416221   | 1x<br>6099779  | 1x<br>243124  | 4x<br>6051508 | 2x<br>241926  | 2x<br>6038453 | 2x<br>663626  |
| 1x<br>4566256 | 2x<br>300121  | 1x<br>243221   | 1x<br>6101997  | 1x<br>6097796 | 3x<br>4548180 | 2x<br>4558209 | 1x<br>452226  | 7x<br>366626  |
| 6x<br>4218749 | 1x<br>300821  | 4x<br>4558886  | 1x<br>4651462  | 1x<br>6057957 | 4x<br>366526  | 2x<br>4558209 | 1x<br>400626  | 1x<br>379526  |
| 2x<br>4117070 | 4x<br>4558886 | 14x<br>4140585 | 1x<br>6058147  | 1x<br>6097799 | 2x<br>374726  | 3x<br>4513539 | 2x<br>4114206 | 5x<br>346026  |
| 1x<br>4523145 | 7x<br>4157223 | 2x<br>6089576  | 1x<br>393721   | 1x<br>6057688 | 4x<br>4515362 | 2x<br>4184617 | 2x<br>6064174 | 2x<br>303426  |
| 1x<br>6092587 | 5x<br>654121  | 12x<br>403221  | 1x<br>613421   | 4x<br>300526  | 2x<br>609126  | 2x<br>4184617 | 1x<br>4530673 | 2x<br>300826  |
| 4x<br>4666579 | 6x<br>4500462 | 2x<br>303921   | 2x<br>6102786  | 3x<br>300426  | 4x<br>302426  | 1x<br>6099462 | 4x<br>6096655 | 1x<br>447726  |
| 1x<br>6097210 | 4x<br>6074895 | 2x<br>428721   | 12x<br>4153718 | 2x<br>4526982 | 1x<br>6016172 | 1x<br>6099466 | 1x<br>6099810 | 2x<br>383226  |
| 8x<br>300421  | 4x<br>6074956 | 4x<br>245021   | 4x<br>4227155  | 1x<br>306826  | 4x<br>6048855 | 1x<br>6099810 | 6x<br>4538782 | 3x<br>4514845 |
| 8x<br>4651524 | 2x<br>4521851 | 2x<br>6102398  | 1x<br>6102398  | 11x<br>302226 | 5x<br>6020193 | 1x<br>6099809 | 5x<br>244526  |               |

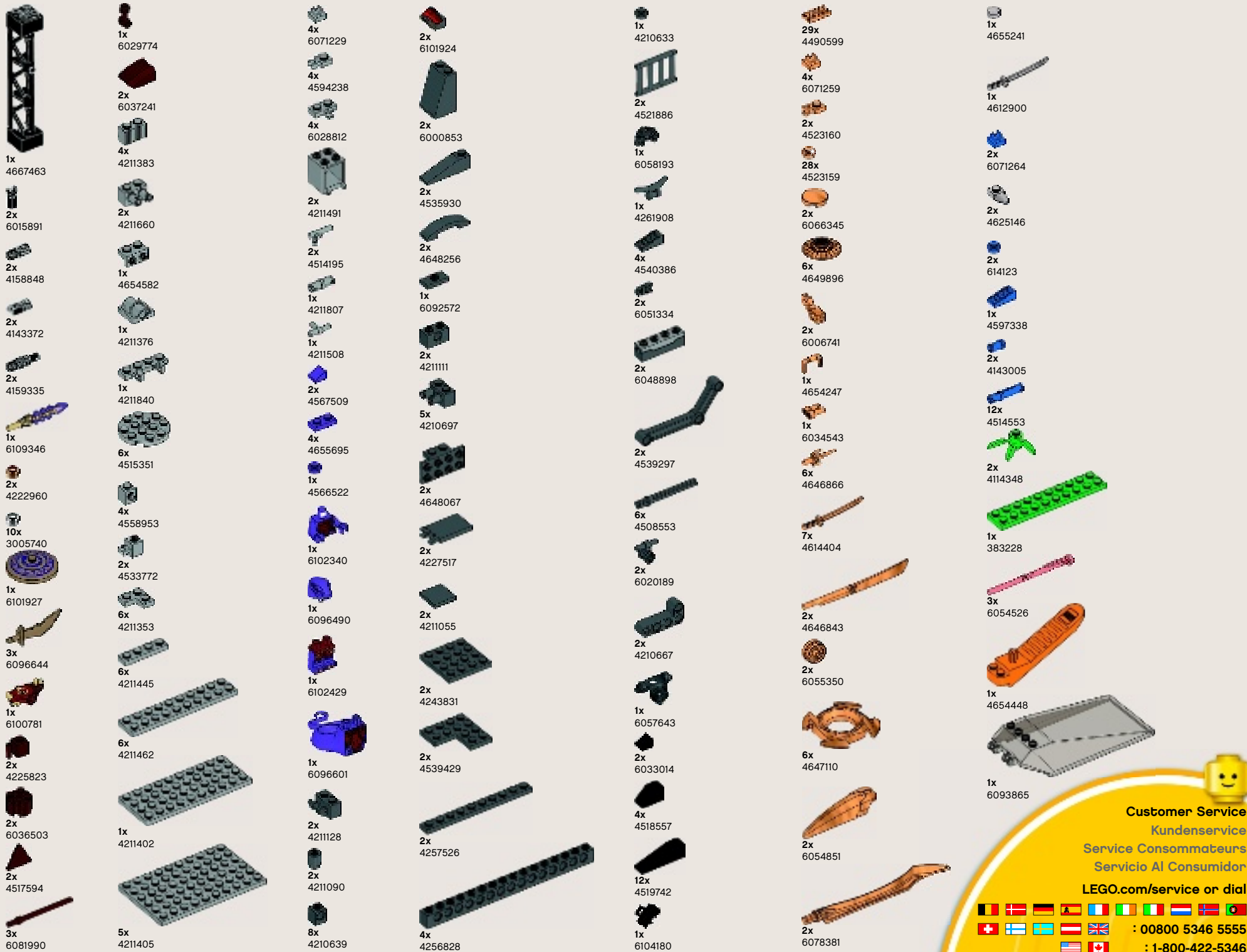

**Customer Service**  
**Kundenservice**  
**Service Consommateurs**  
**Servicio Al Consumidor**

**LEGO.com/service or dial**

: 00800 5346 5555  
: 1-800-422-5346



# NINJAGO

Masters of Spinjitzu



[LEGO.COM/NINJAGO](http://LEGO.COM/NINJAGO)



# club™

## Free\*! Gratuit!

\* Paid subscription in Australia and New Zealand.  
Abonnement payant en Australie et Nouvelle-Zélande.



[LEGO.com/club](http://LEGO.com/club)