



NEXO KNIGHTS



70325







1

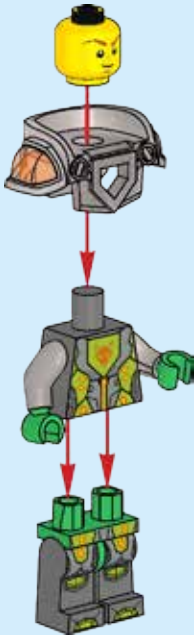

2

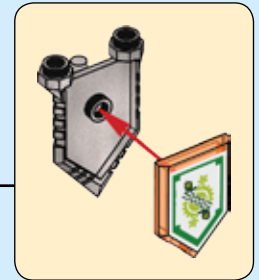
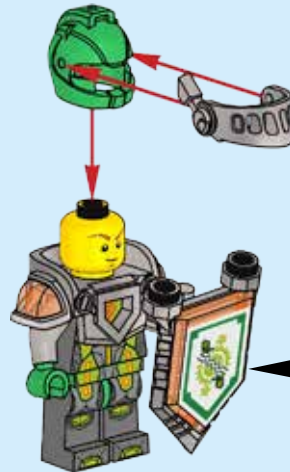

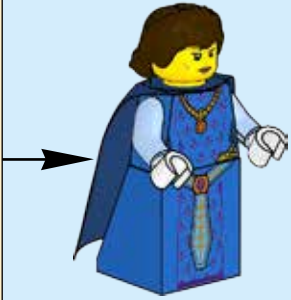
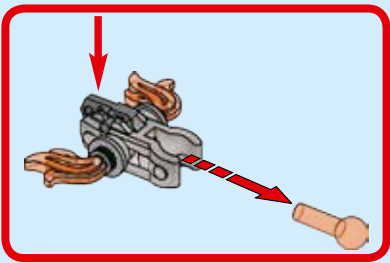
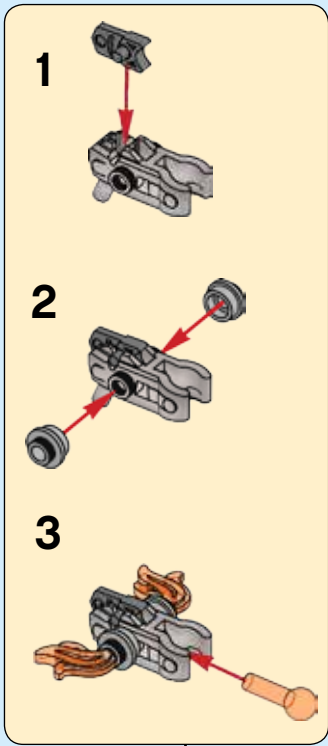

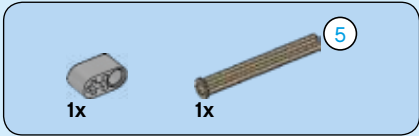

1

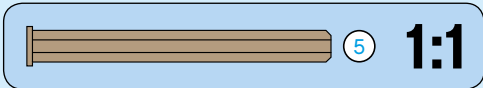
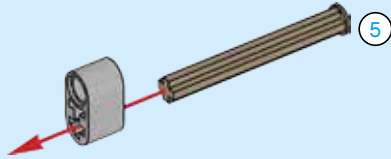

2

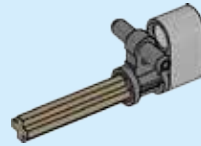



3x

3

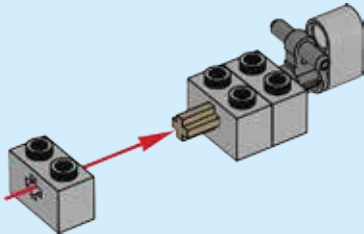

1x



1x



1x

4

1

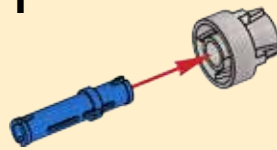

2

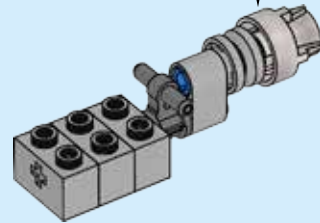
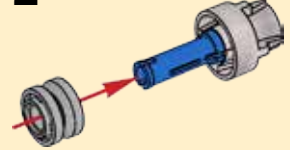

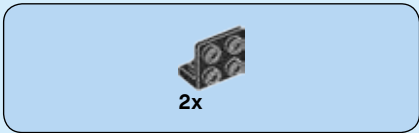

5

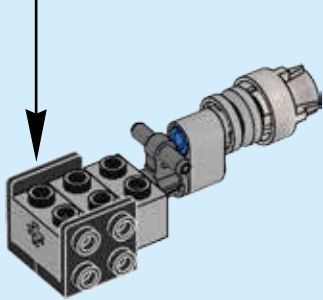
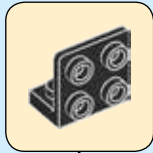

6

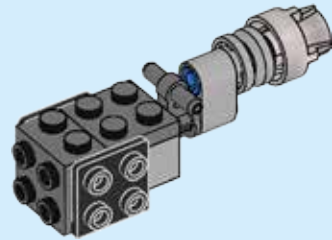



2x

7

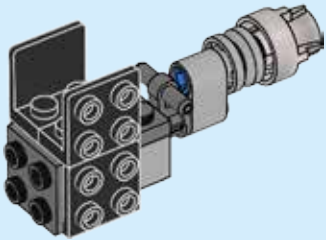

2x

8

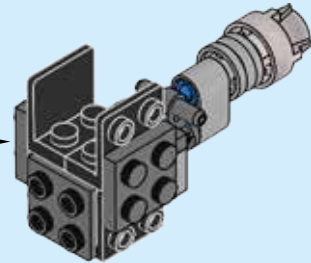
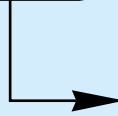



2x

9

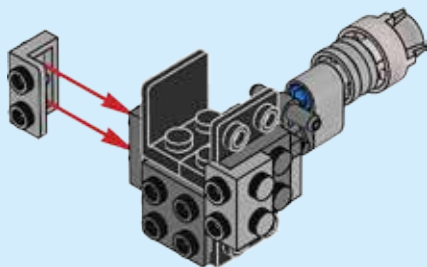

2x

10

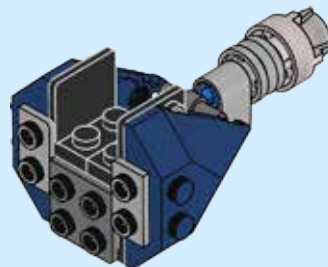



2x



1x

11

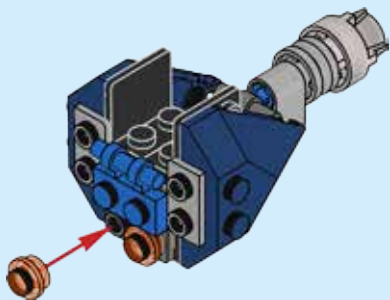

2x

12

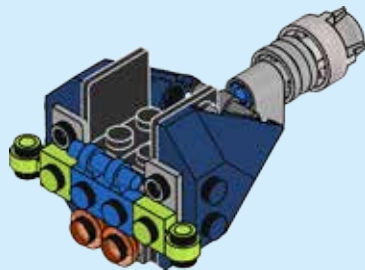



2x



2x

13

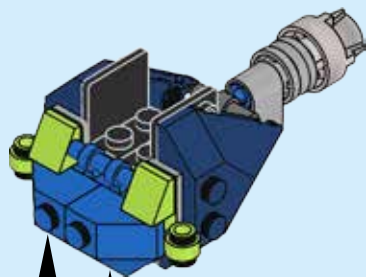

2x

14

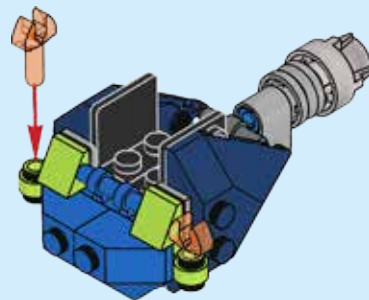

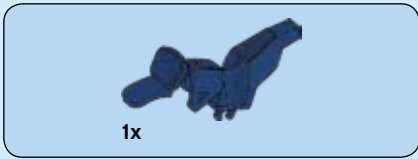

15

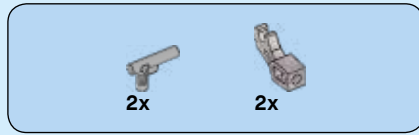
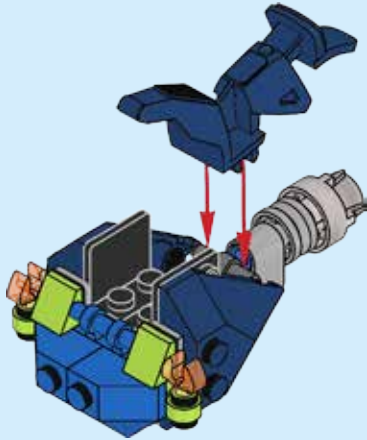

16

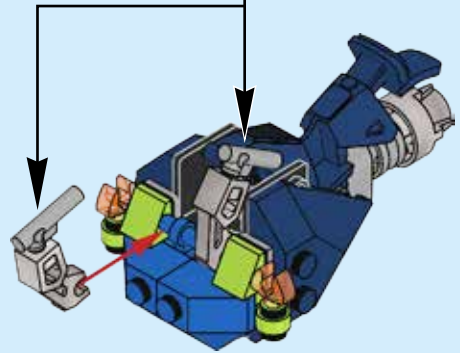
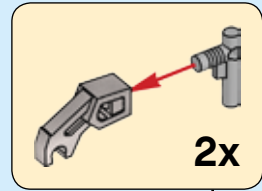

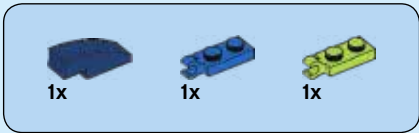

17

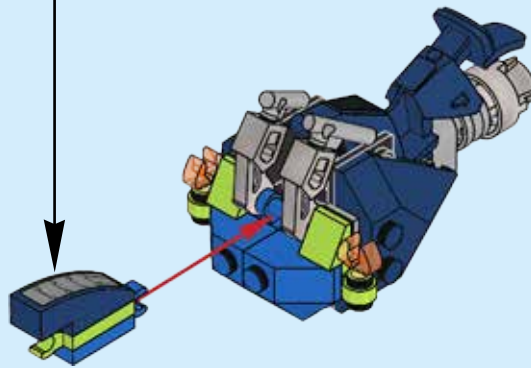
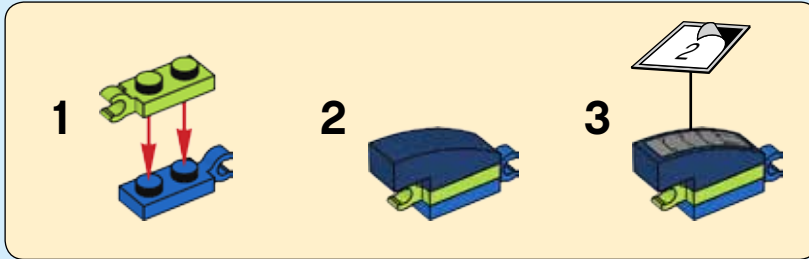

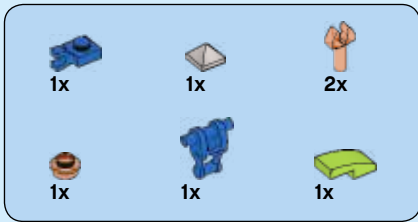

18

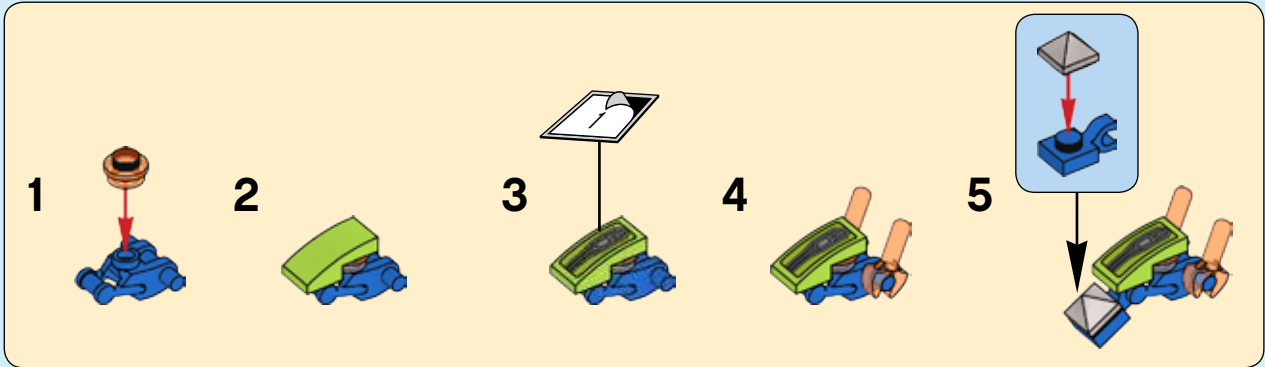

19

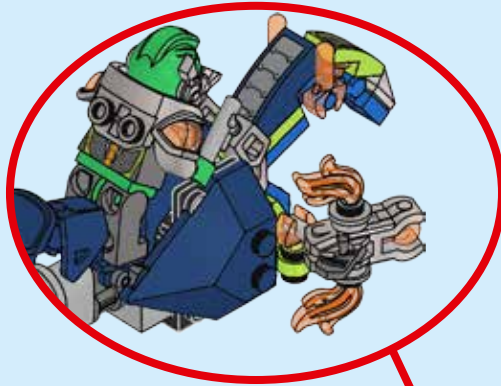

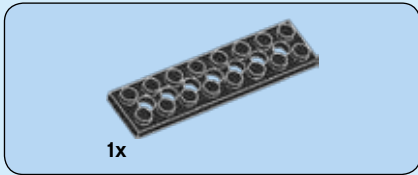

1

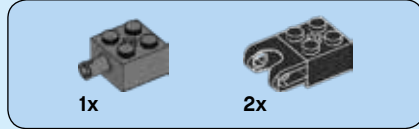
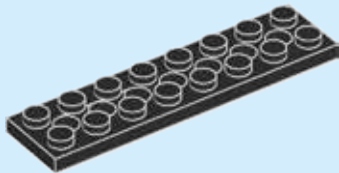

2

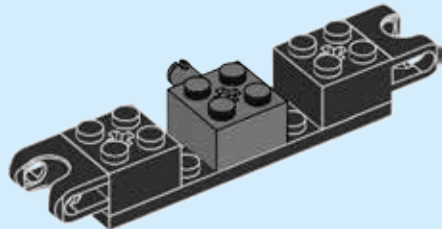

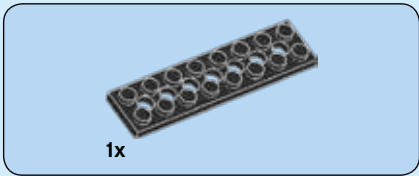

3

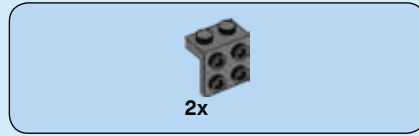
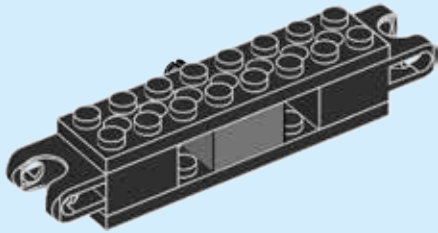

4

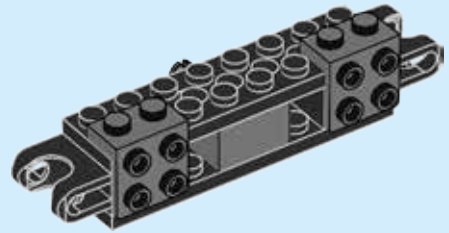



2x

5

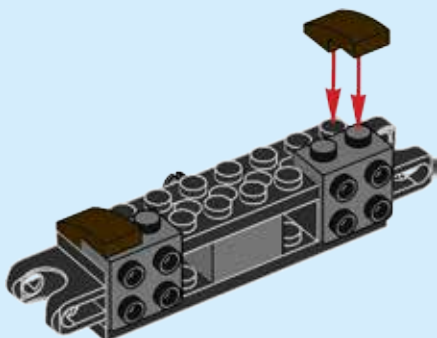

2x

6

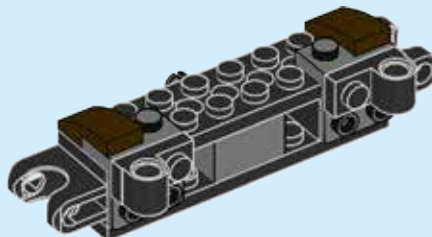



7

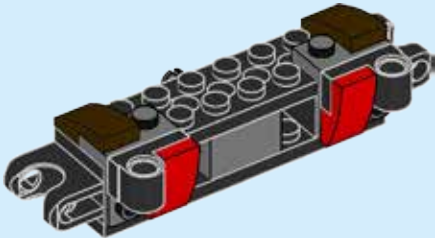

8

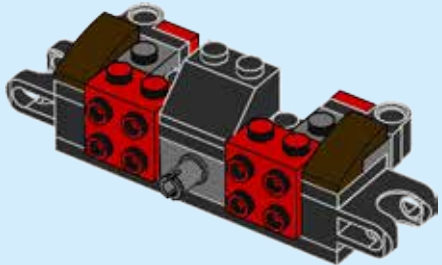
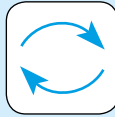



2x



2x

9

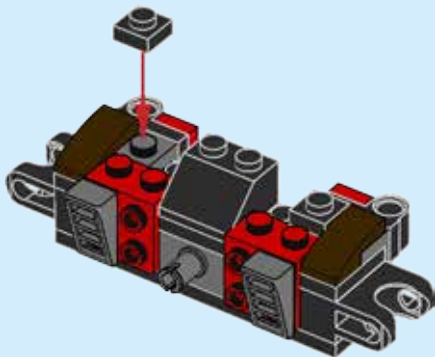

2x

10

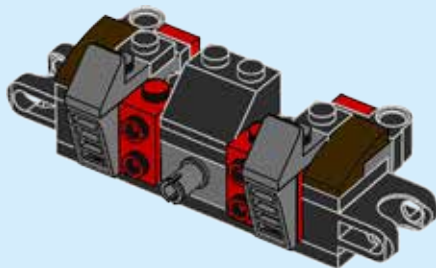

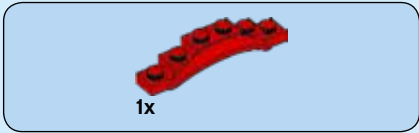

11



12

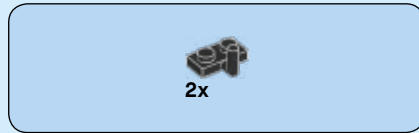

13

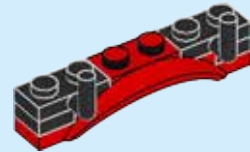



2x

14

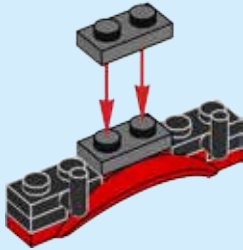

2x



2x

15

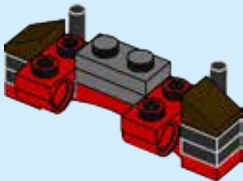
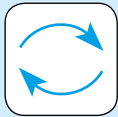

1x

16

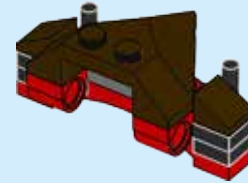

2x

17

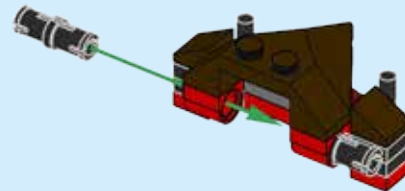



2x



2x

18

1



2



2x

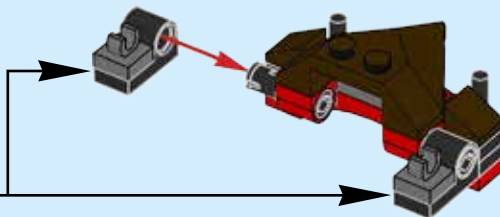

19

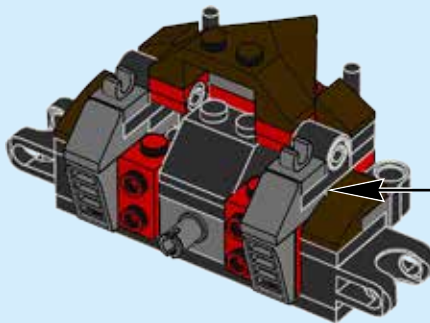

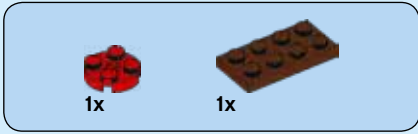

20

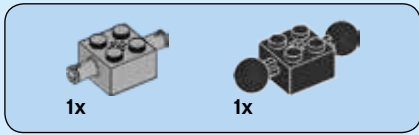

21

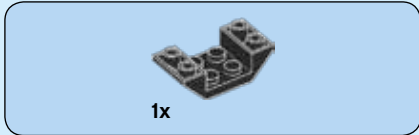
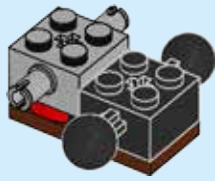

22

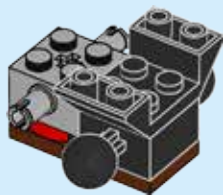

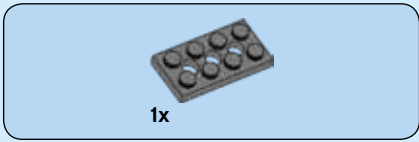

23

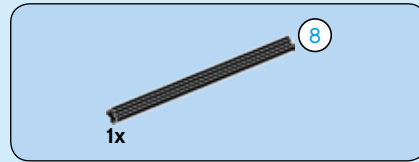

24

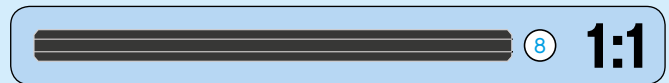
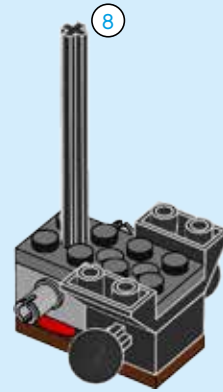



1x

25

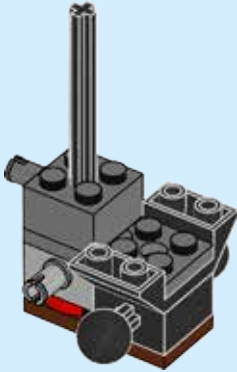

1x

26

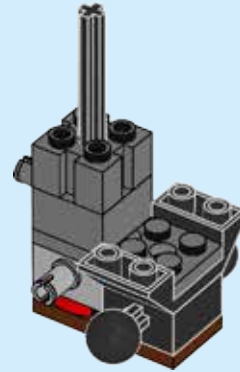



1x

27

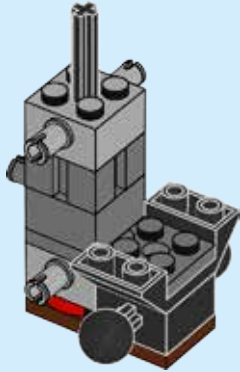

2x

28

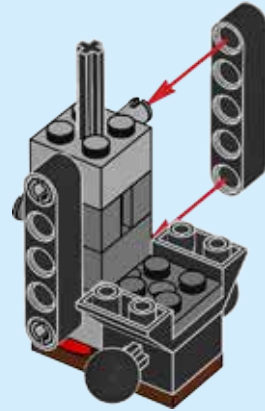



2x

29

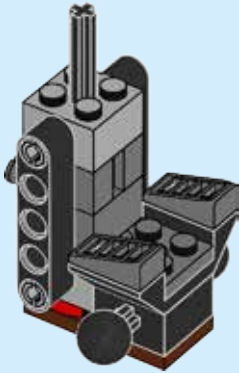

30

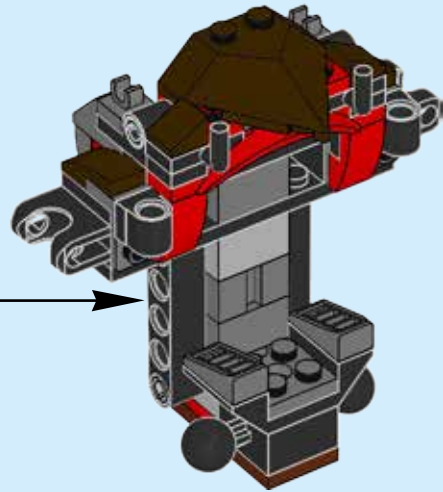
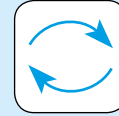

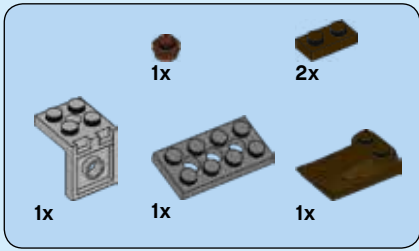

31

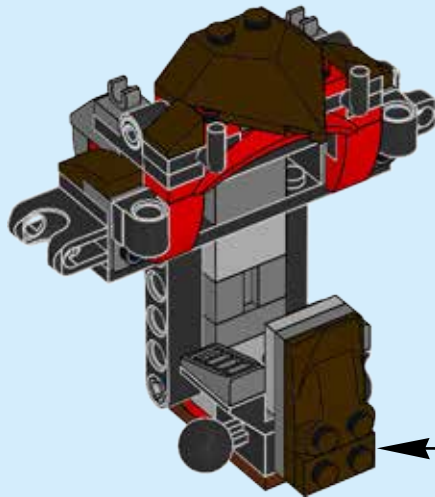
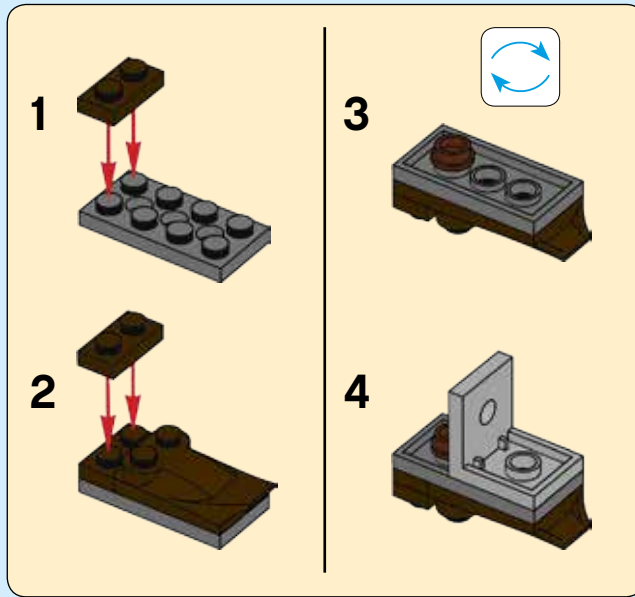



32

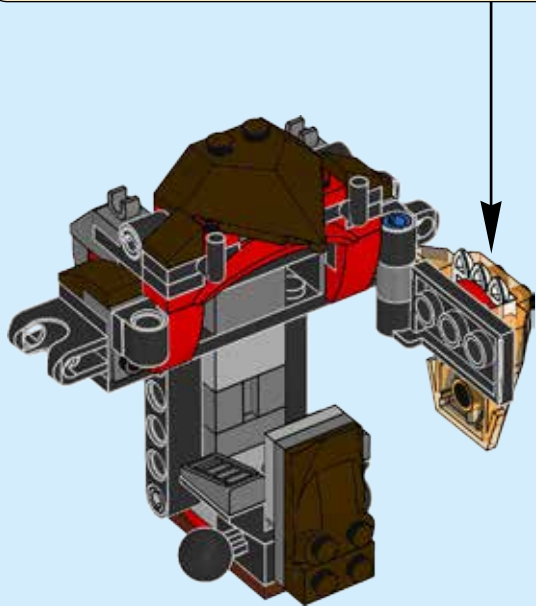
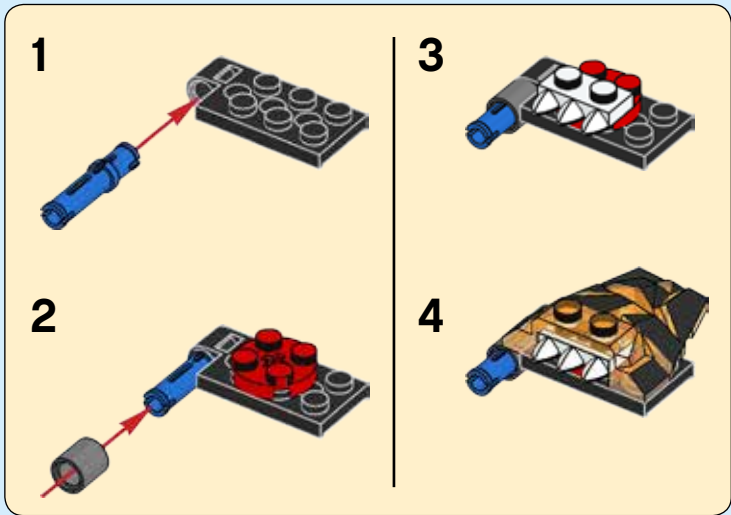

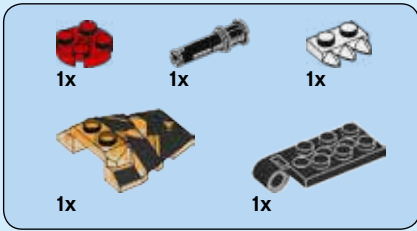

33

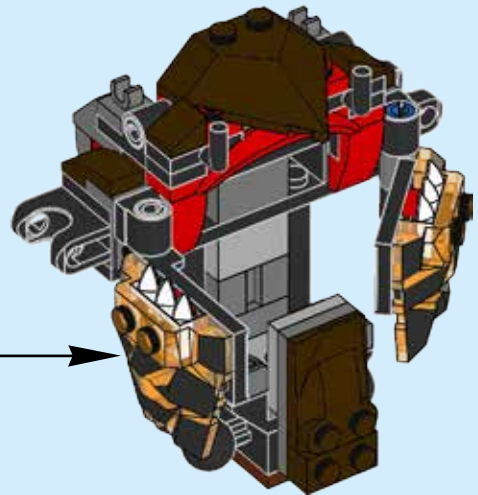
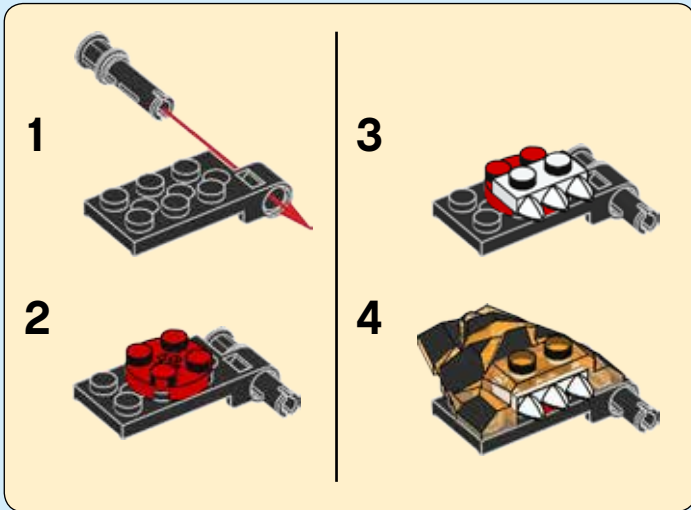

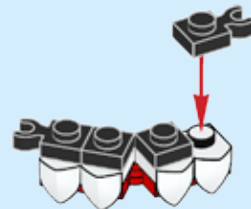
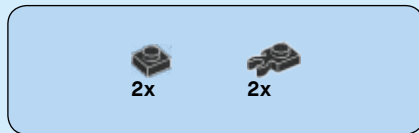
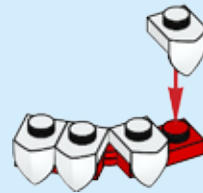
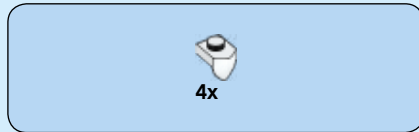
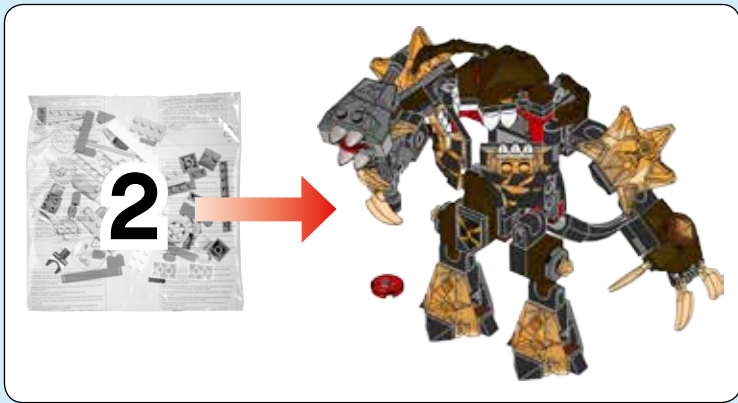



37



38



39





2x

40

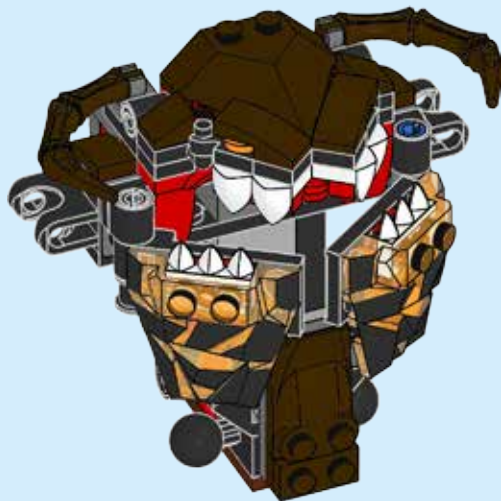



2x



1x

41

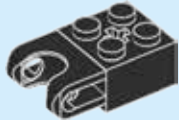

1x

42

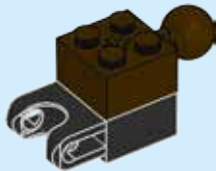

1x

43

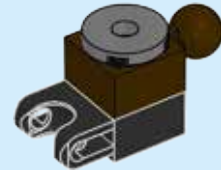

1x

44

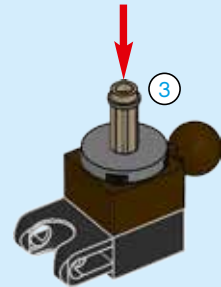

3

1:1



1x

45

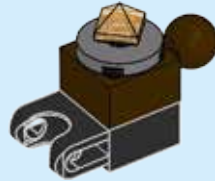

2x

46

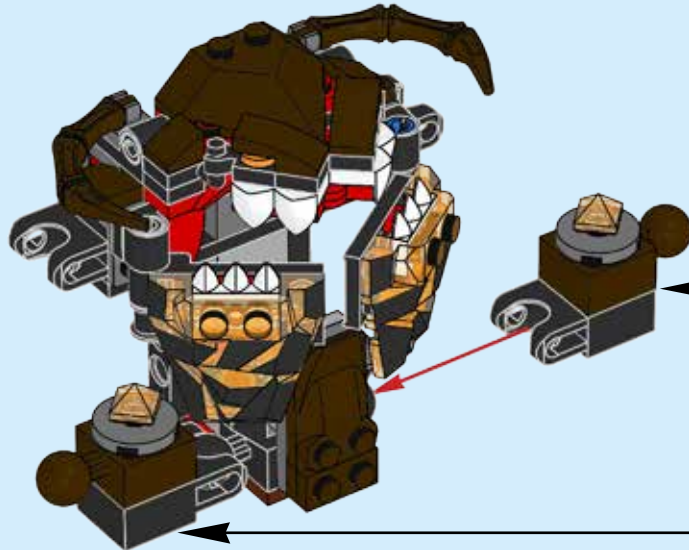



2x

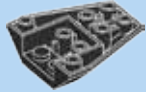

1x

47

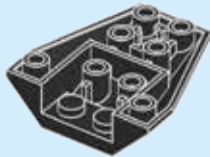

1x

48

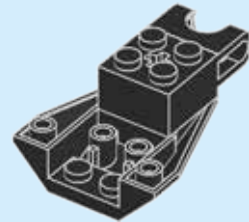

1x

49

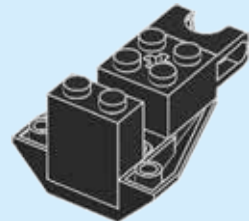



1x



2x

50

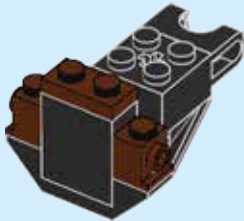

1x

51



1x



2x

52

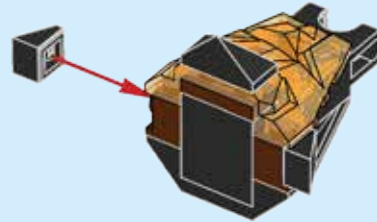

2x

53

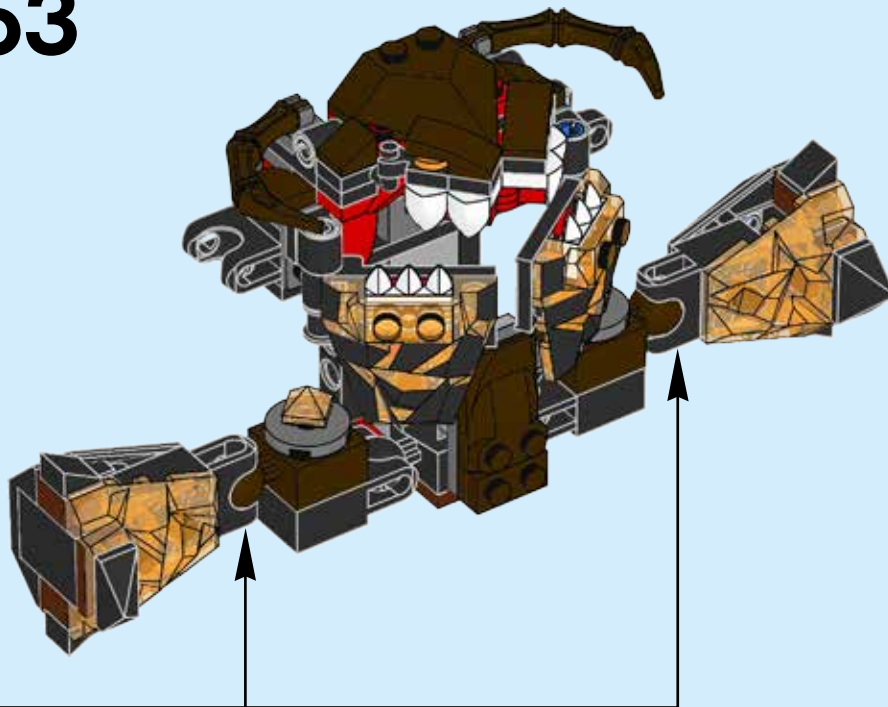



1x

54

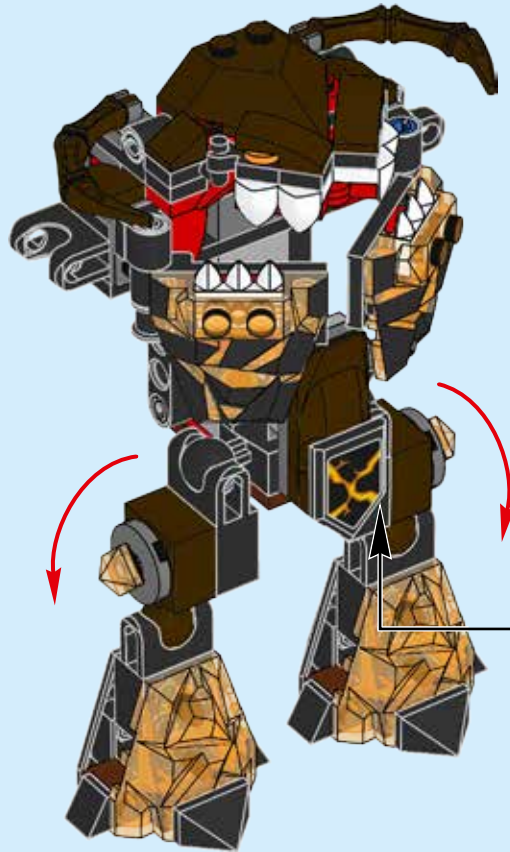

1



2



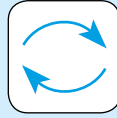
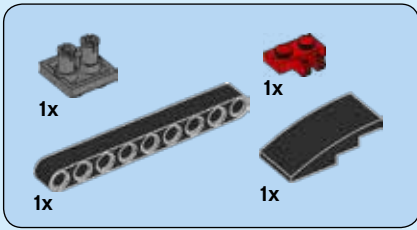

55

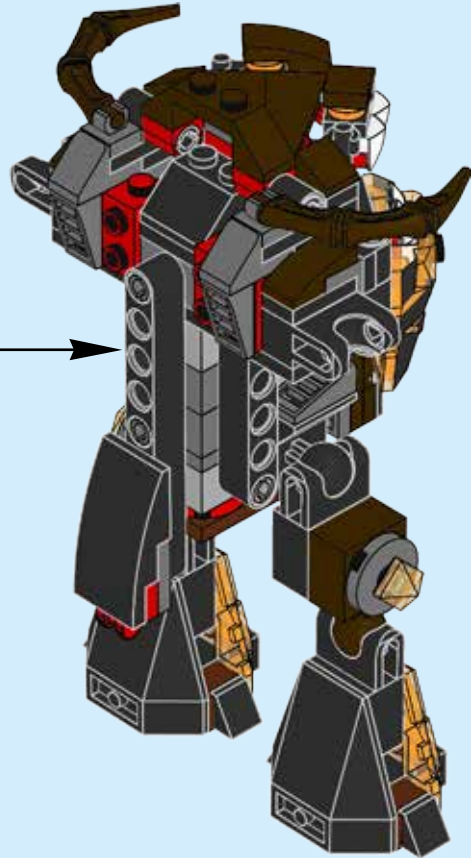
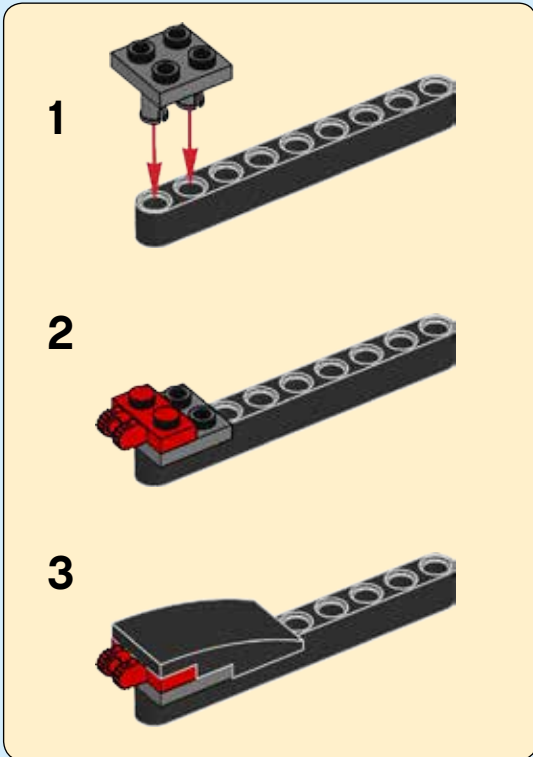

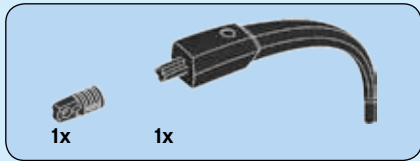

56

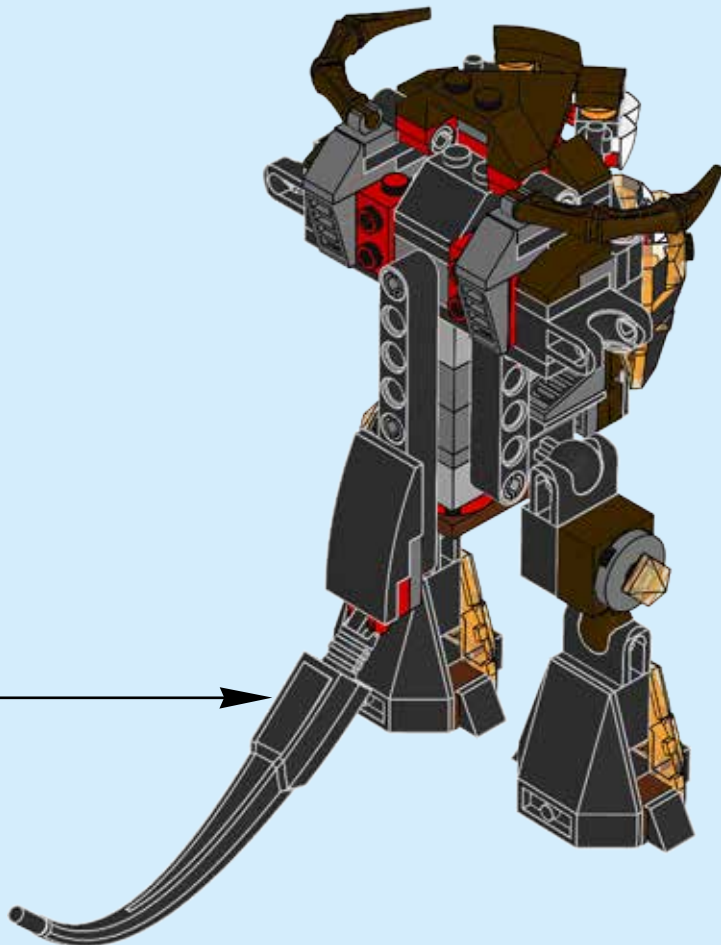
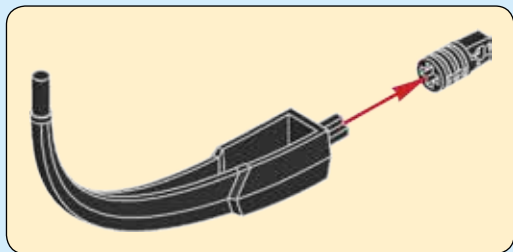

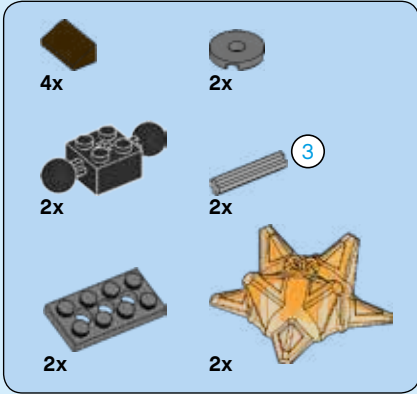
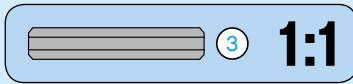

57

1

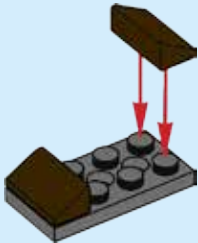

2

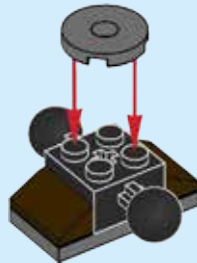

3

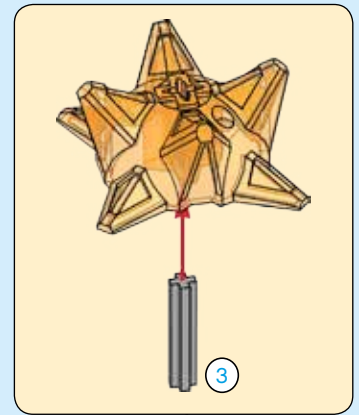
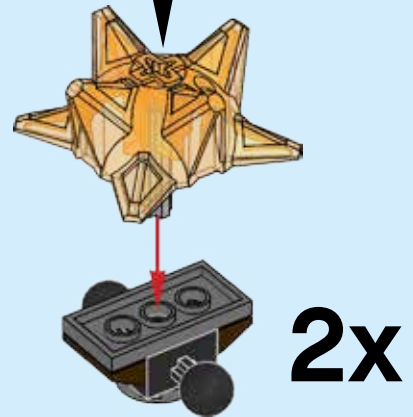

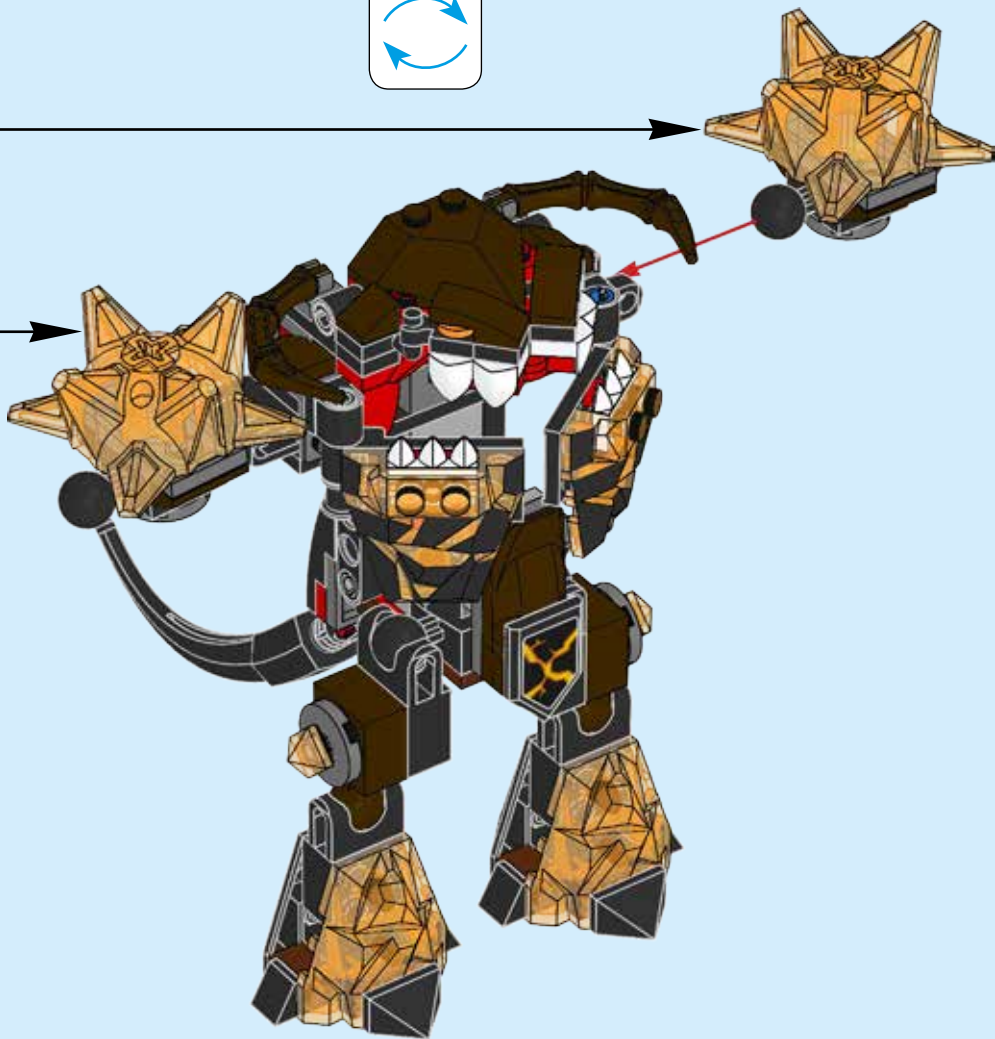
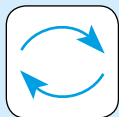



2x



1x

58

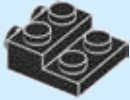

1x

59

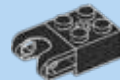
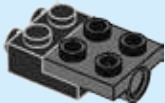

1x

60

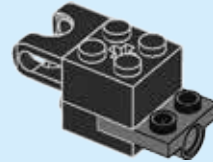

1x

61

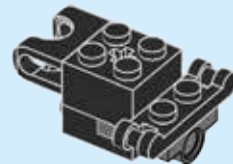



62



63



64

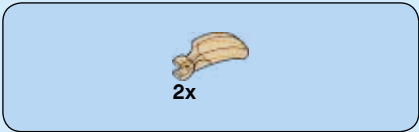

65

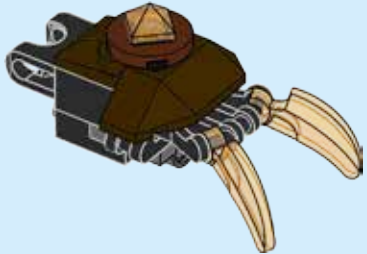

2x

66

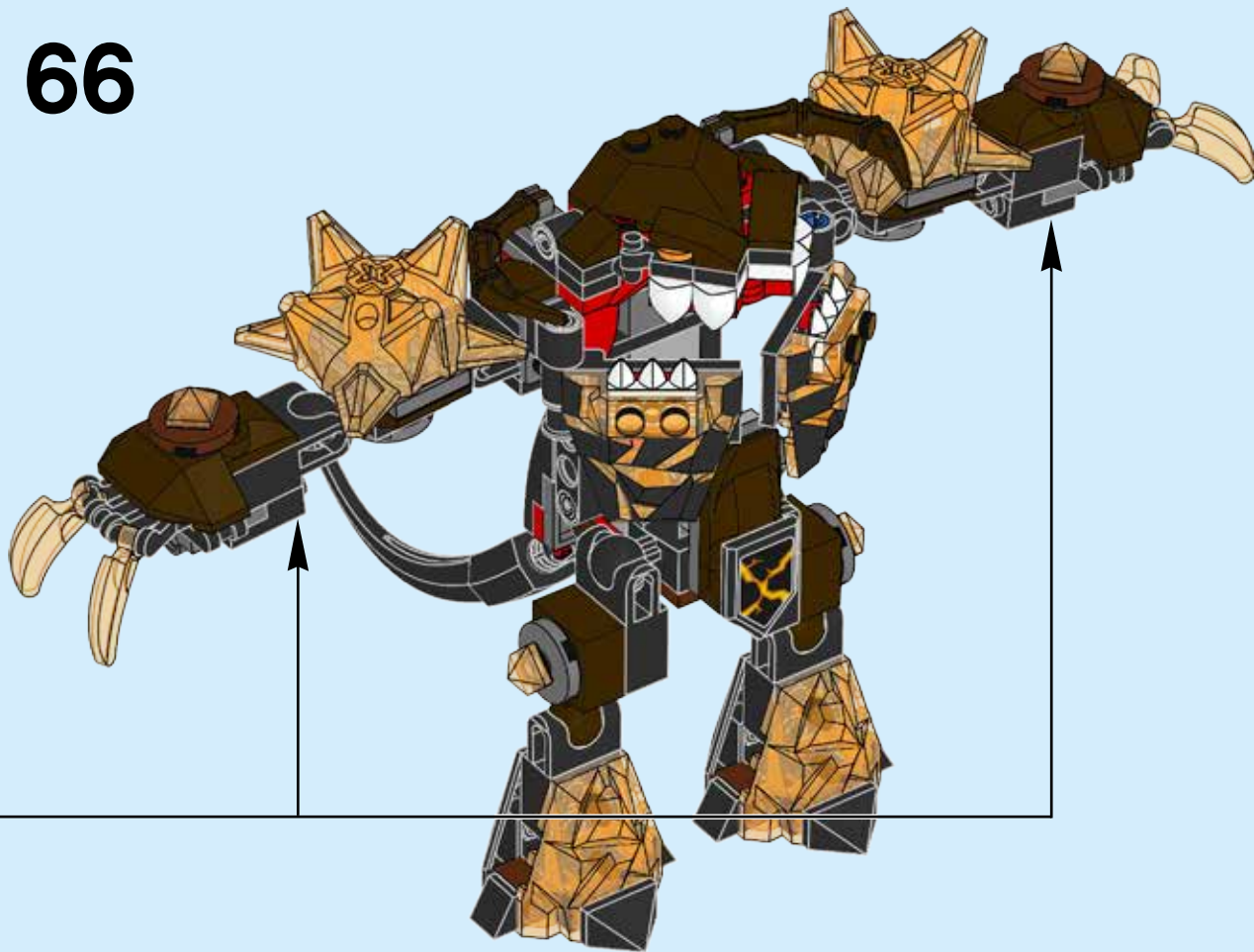



2x

67

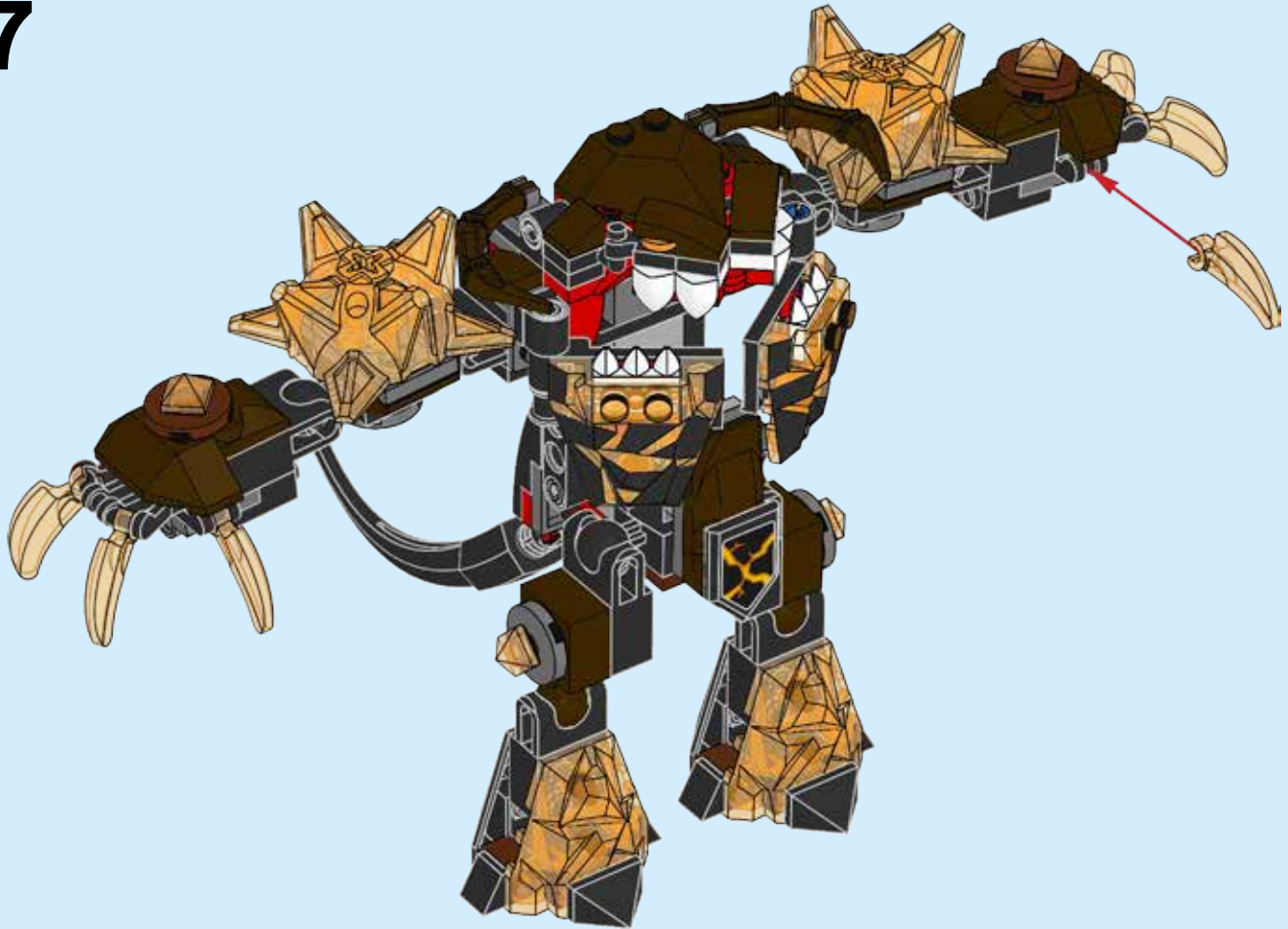

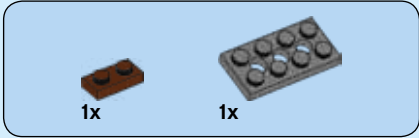
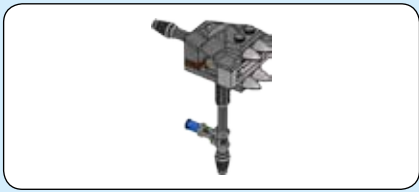

68

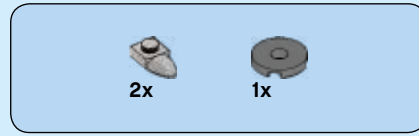
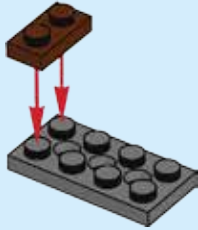

69

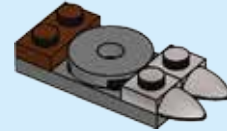

70

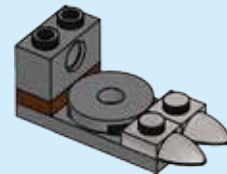

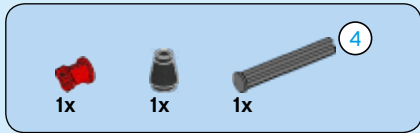

71

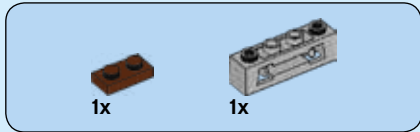
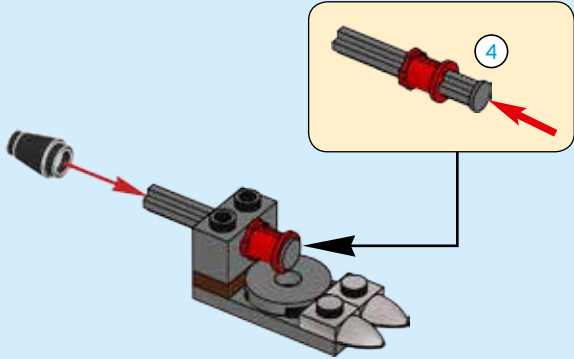

72

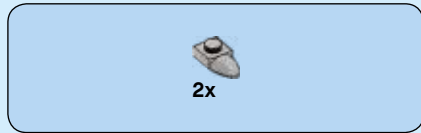
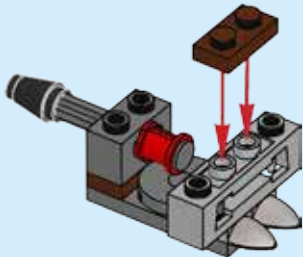

73

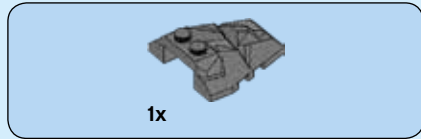
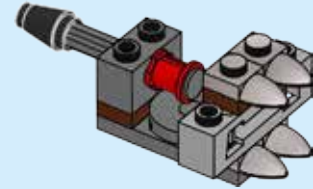

74

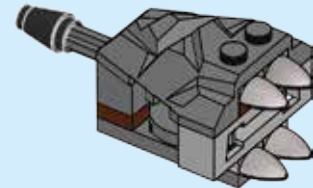

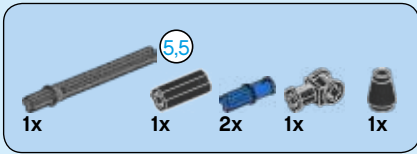

75

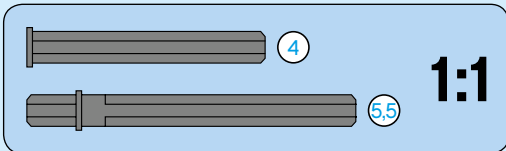
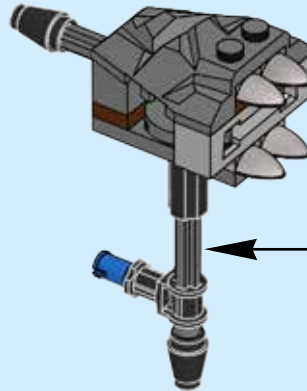
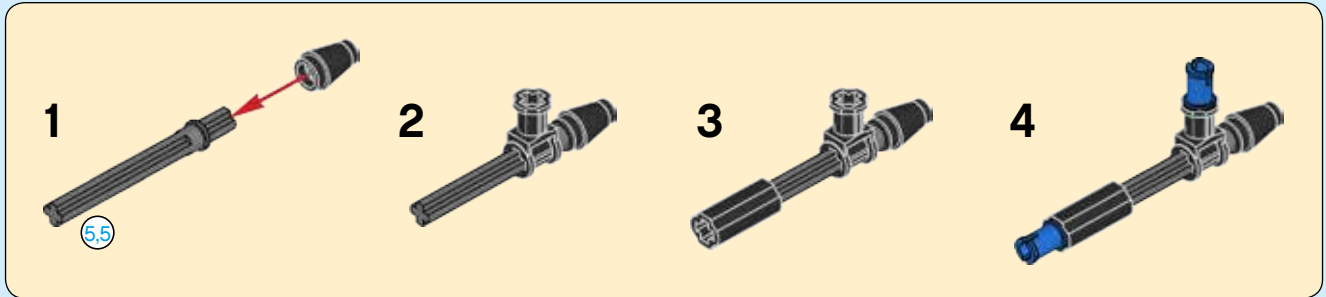

76

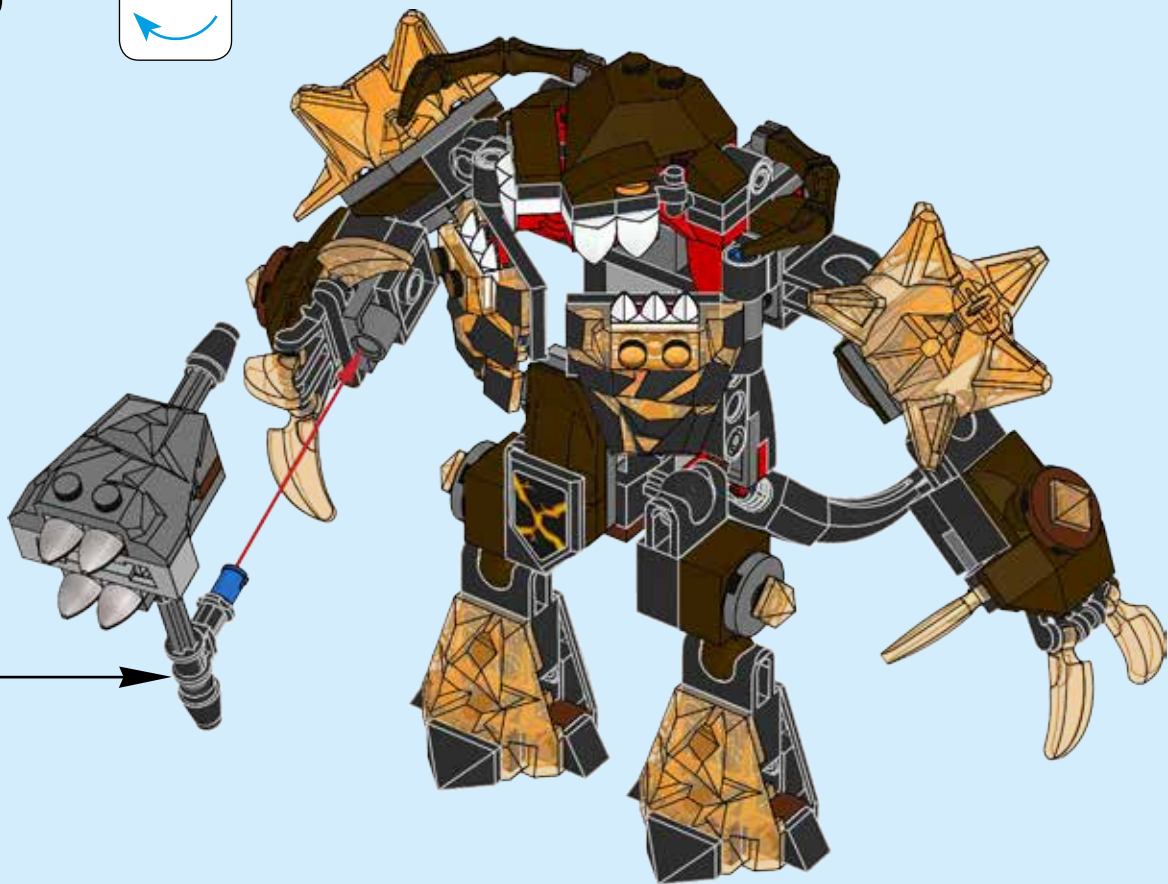
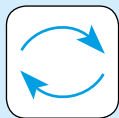



2x



77

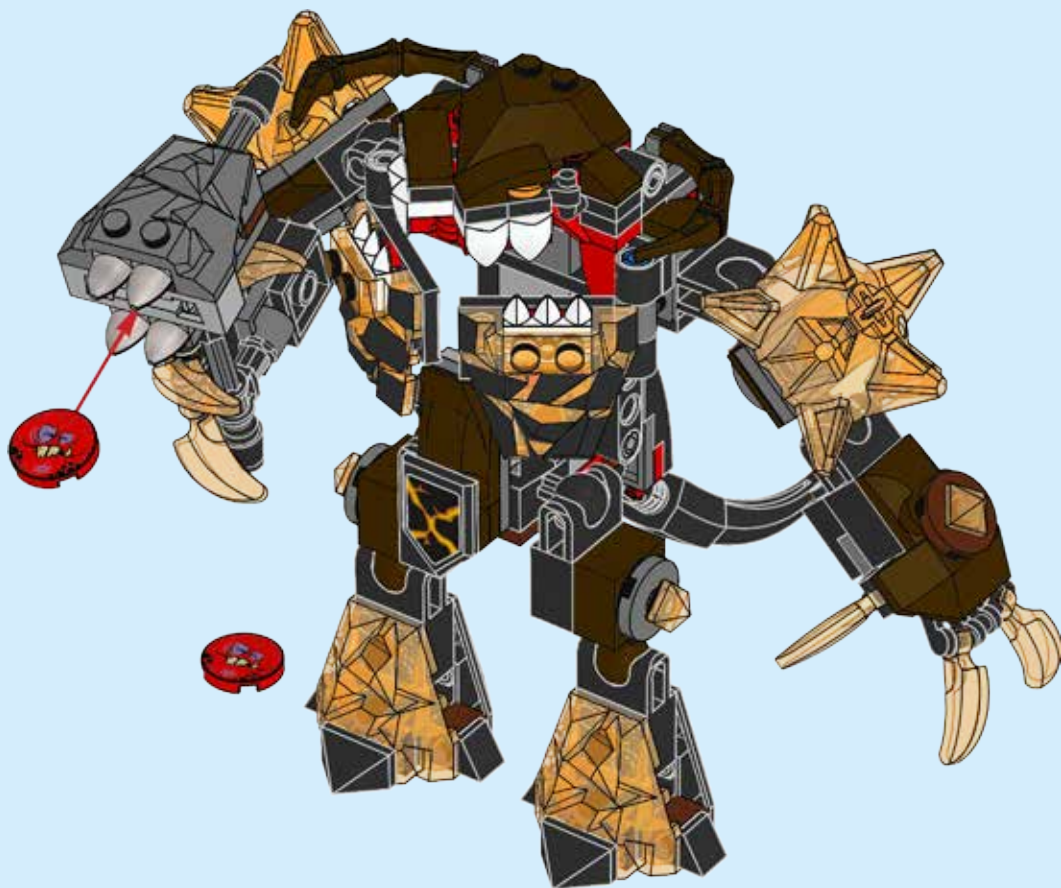

78

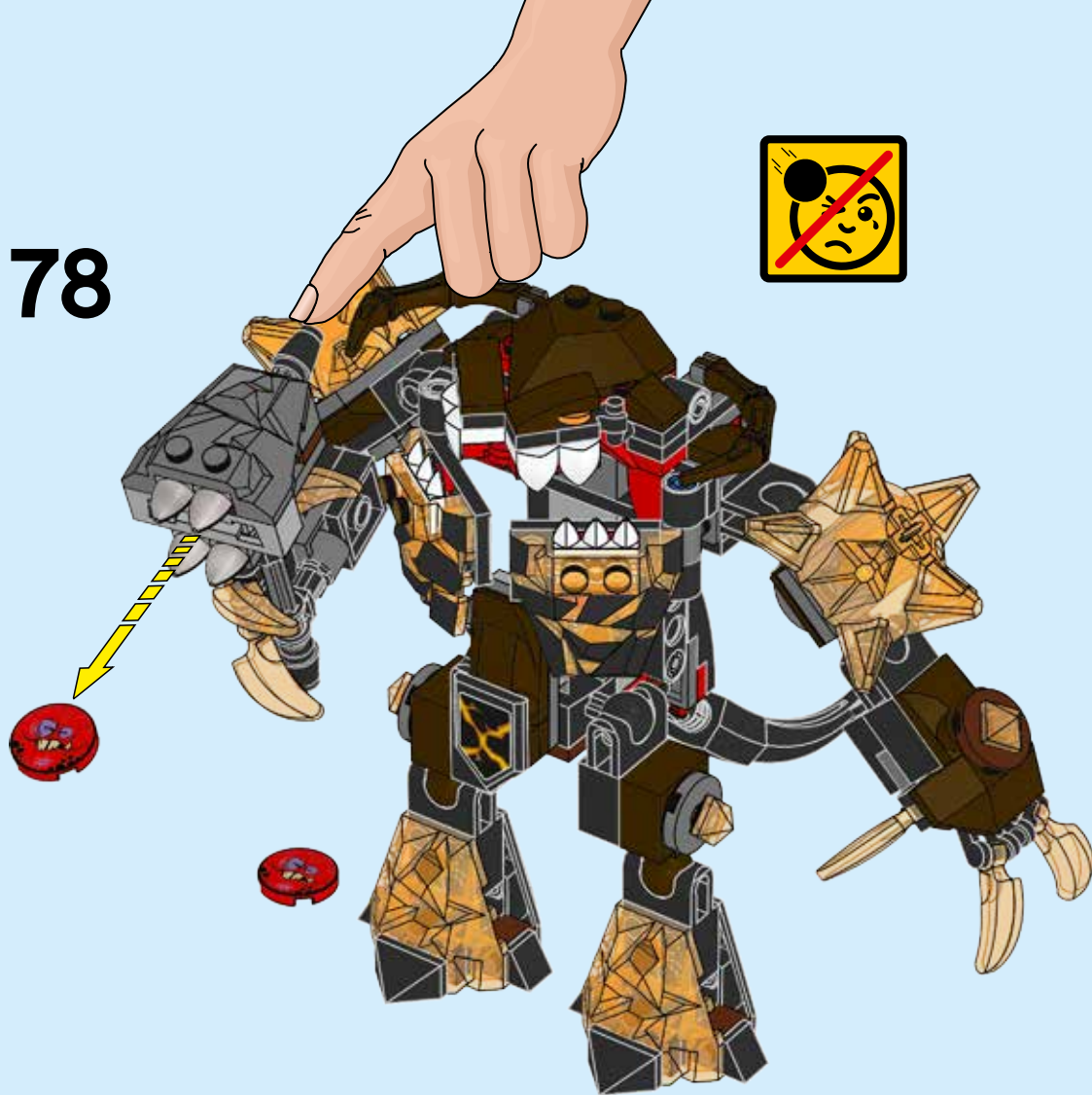





NEXO KNIGHTS



05813.240070

7500896.554100

70325 + 70317



05813.240070

LEGO

NEXO KNIGHTS 

DOWNLOAD
THE FREE APP



TÉLÉCHARGE
L'APPLI
GRATUITE

DESCARGA
LA APP
GRATIS



LEGO® NEXO KNIGHTS™: MERLOK 2.0



1



2



3

DEVICE CHECK: VÉRIFICATION DE COMPATIBILITÉ: /COMPRUEBA TU DISPOSITIVO: LEGO.com/devicecheck



NEXO KNIGHTS

Scanning Tips / Conseils de scannage / Consejos para escanear



LEGO

**NEXO
KNIGHTS**



LEGO
DISCOVERY CENTER

LEGO

LEGOLAND



DOWNLOAD THE FREE APP:
TÉLÉCHARGE L'APPLI GRATUITE :
DESCARGA LA APP GRATIS:
LEGO® NEXO KNIGHTS™: MERLOK 2.0

ALL MATERIALS MIGHT NOT BE AVAILABLE IN ALL MARKETS.
CERTAINS MATÉRIELS PEUVENT NE PAS ÊTRE DISPONIBLES DANS CERTAINS MARCHÉS
CIERTOS MATERIALES PODRÍAN NO ESTAR DISPONIBLES EN TODOS LOS MERCADOS.

LEGO.COM/NEXOKNIGHTS

LEGO

NEXO KNIGHTS







NEXO KNIGHTS



SPARKKS
70316



JESTRO
70316



BOOK OF MONSTERS
LIVRE DES MONSTRES
LIBRO DE LOS
MONSTRUOS
70316



MOLTOR
70313



BEAST MASTER
MAÎTRE DES BÊTES
MAESTRO DE LAS
BESTIAS
70314



CRUST SMASHER
ÉCRASEUR D'ÉCORCE
70311



ASH ATTACKER
ATTAQUANT DES CENDRES
* 70310 / 70315 / 70317



FLAME THROWER
LANCEUR DE FLAMMES
70312



SCURRIER
COURSIER
DIABLITO
* 70315 / 70317



ULTIMATE BEAST MASTER
LE MAÎTRE DES BÊTES ULTIMATE
MAESTRO DE LAS BESTIAS ULTIMATE
70334



ULTIMATE LAVARIA
LAVARIA ULTIMATE
70335

* Weapons and decorations vary by set/Les armes et les décorations varient selon l'ensemble/Las armas y accesorios varían según el set



ULTIMATE CLAY
CLAY ULTIMATE
70330



ULTIMATE MACY
MACY ULTIMATE
70331



ULTIMATE AARON
AARON ULTIMATE
70332



ULTIMATE ROBIN
ROBIN ULTIMATE
70333

NEXT POWER UP

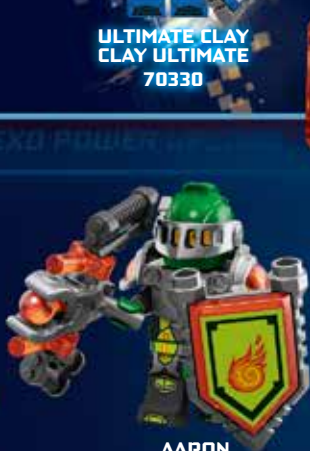

AARON
* 70313 / 70317



AXL
70317



LANCE
* 70312 / 70316



CLAY
* 70315 / 70317



MACY
70314



CHEF ÉCLAIR
70317



LANCE BOT
BOT DE LANCE
70312



CLAY BOT
BOT DE CLAY
70315



ROYAL SOLDIER
SOLDAT ROYAL
SOLDADO REAL
* 70310 / 70311



MERLOK 2.0
70317





NEXO KNIGHTS





NEXO KNIGHTS



PER UPLOAD



70317



70316



70315



70314



70313



70312



70311



70310



70330



70331



70332



70333



70334



70335



NEXO KNIGHTS



LEGO.COM/NEXOKNIGHTS



Customer Service

Kundenservice

Service Consommateurs

Servicio Al Consumidor

LEGO.com/service or dial



: 00800 5346 5555

: 1-800-422-5346