

**LEGO**

# NEXO KNIGHTS



7 [LEGO.com/nexoknights](http://LEGO.com/nexoknights)

70320



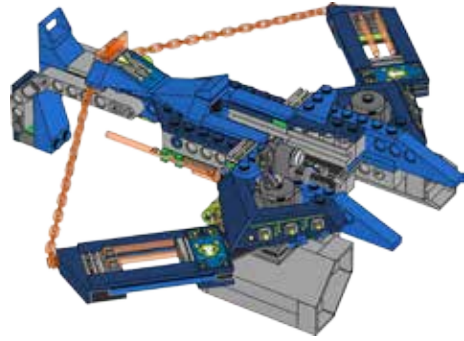

2x



1x

1



1x



1x

2





2x



2x

# 3

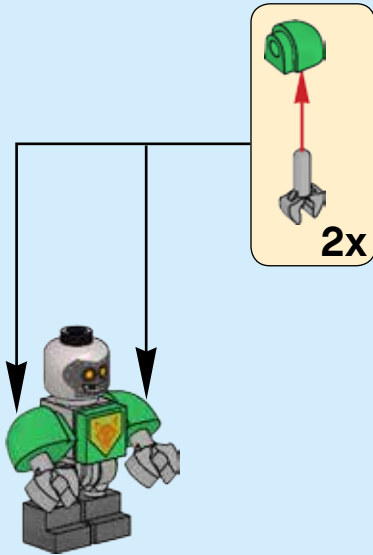

1x



1x

# 4

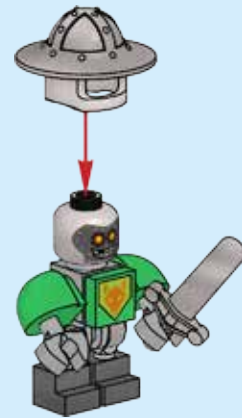

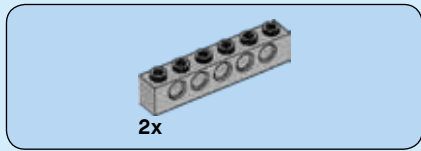

17

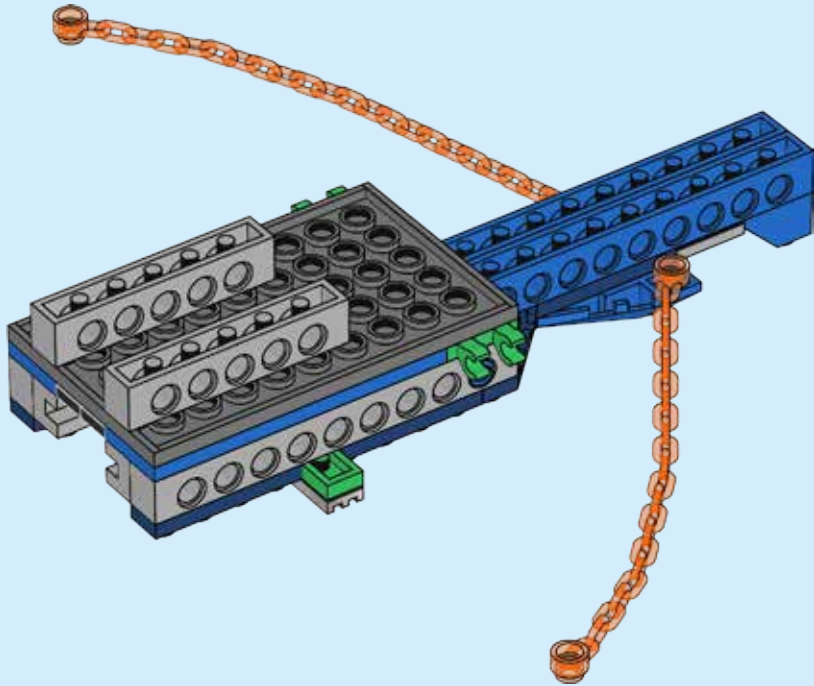



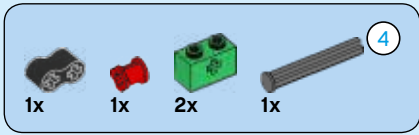

# 18

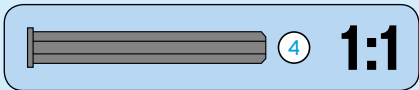
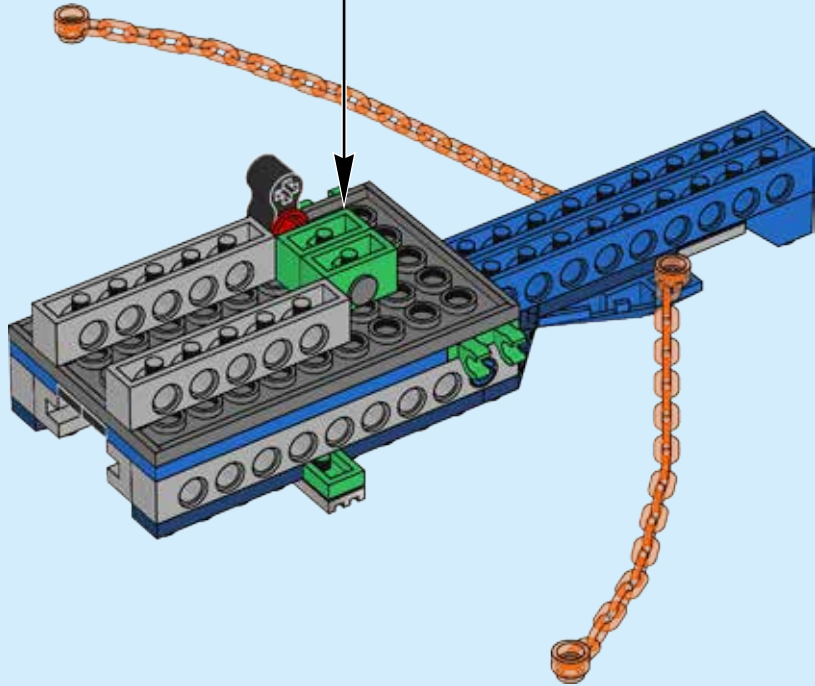
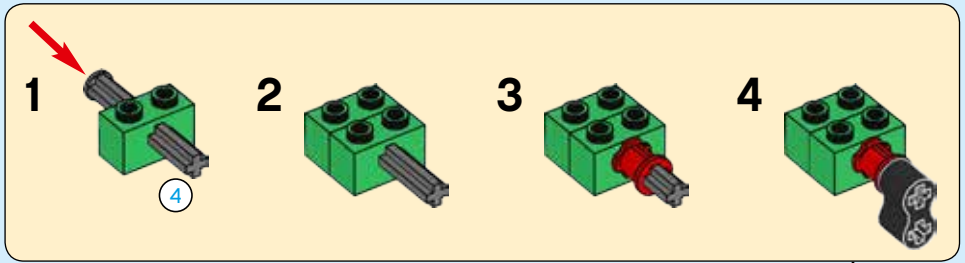



2x

# 19

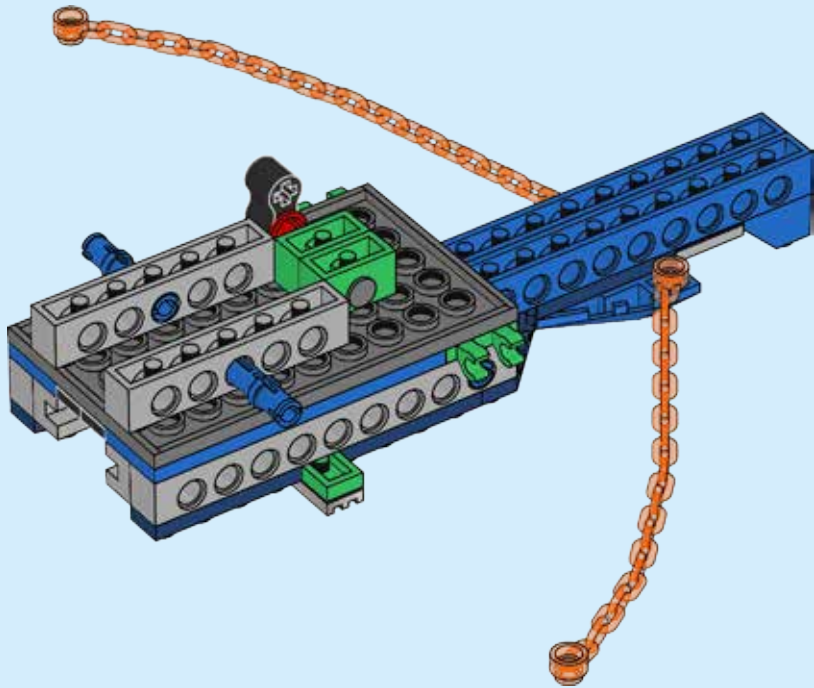

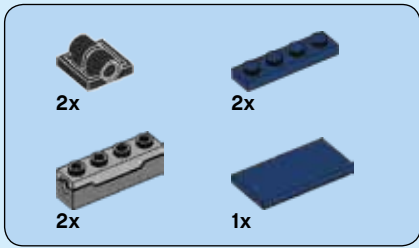

20

1

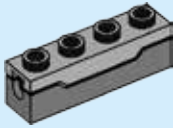

2

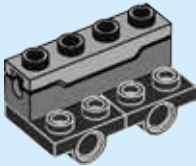

3



4



5



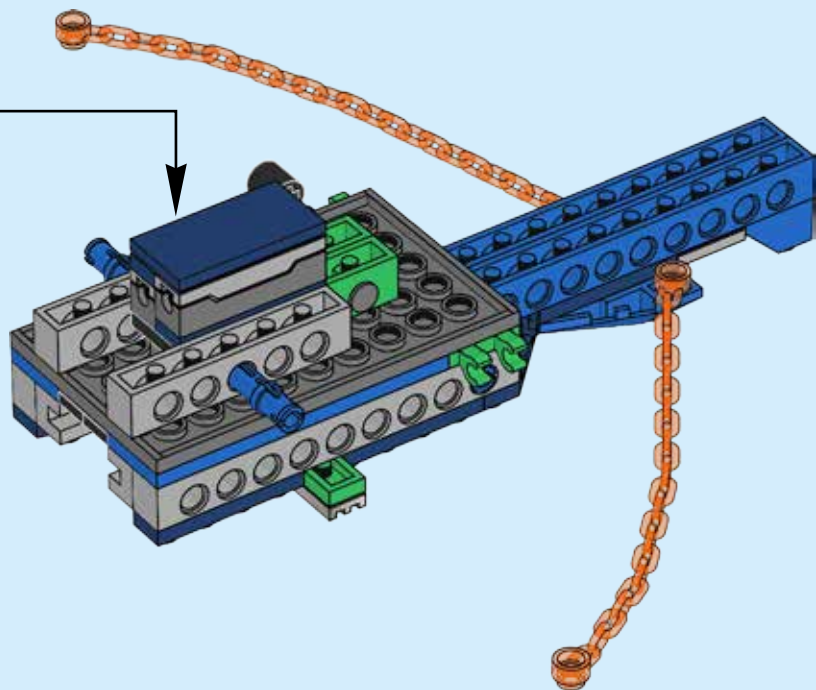

21

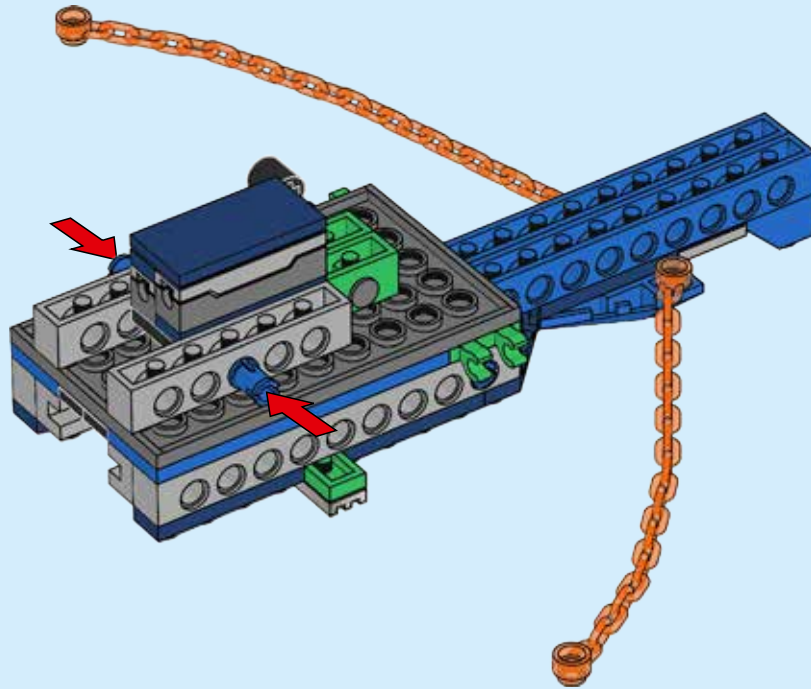





2x

# 22

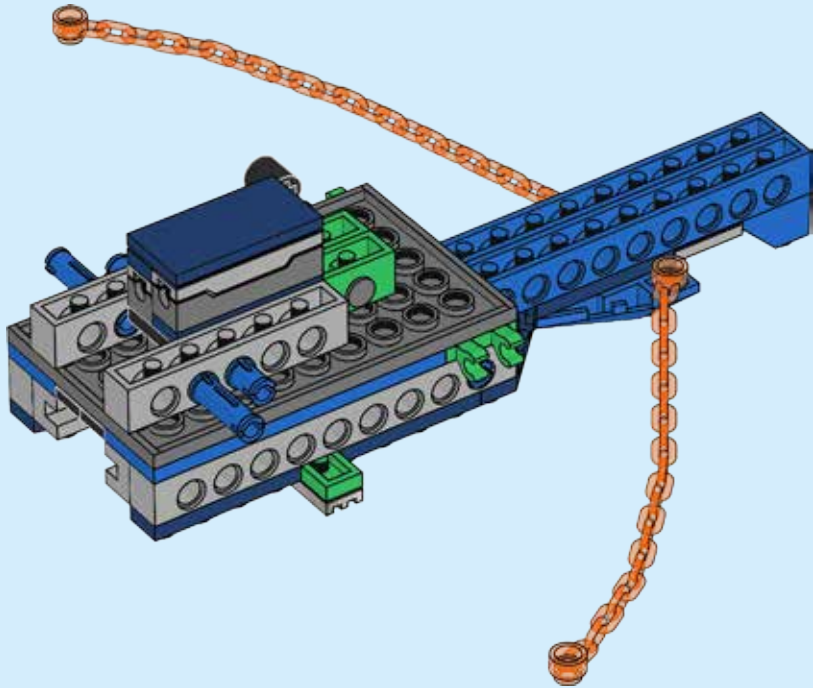

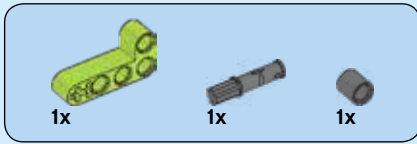

# 23

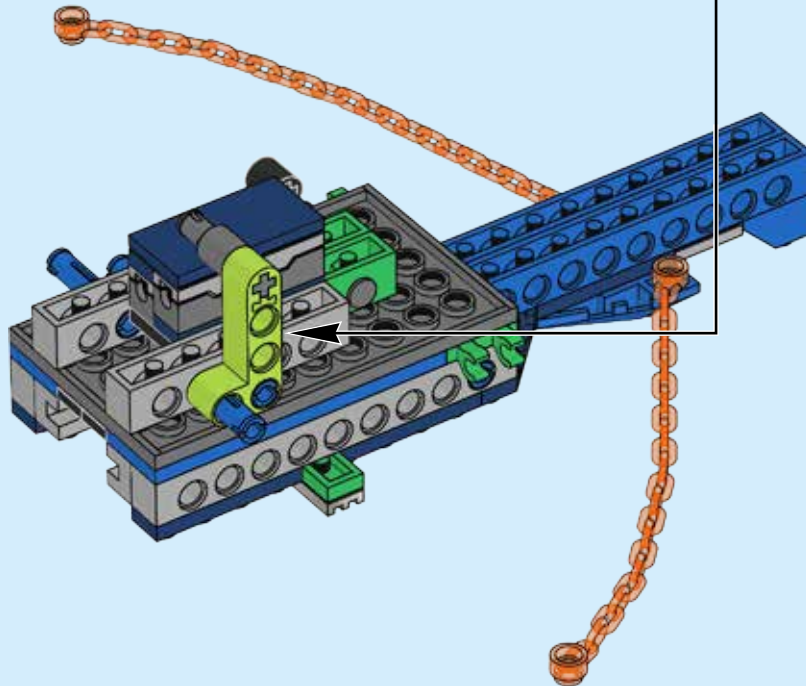
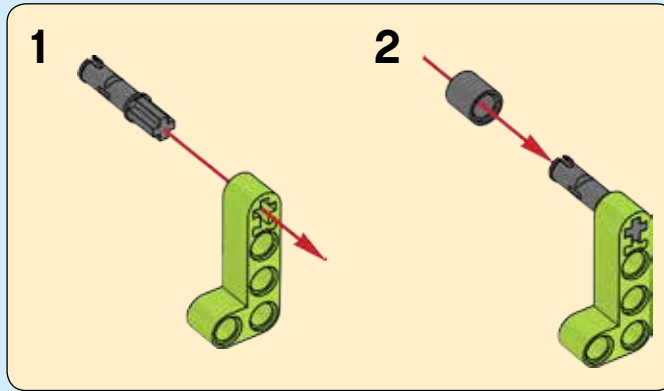

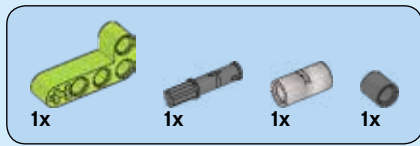

# 24

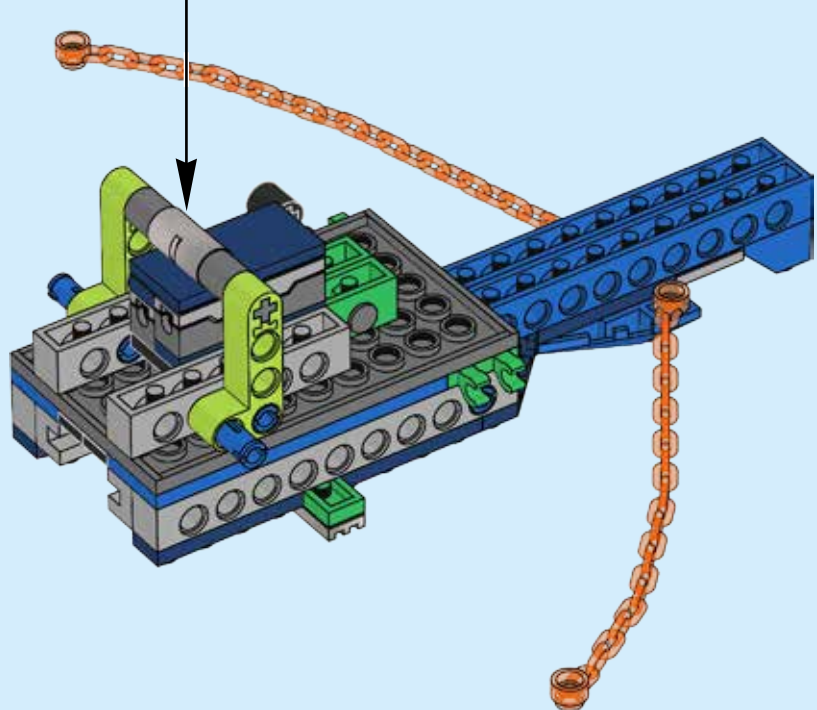
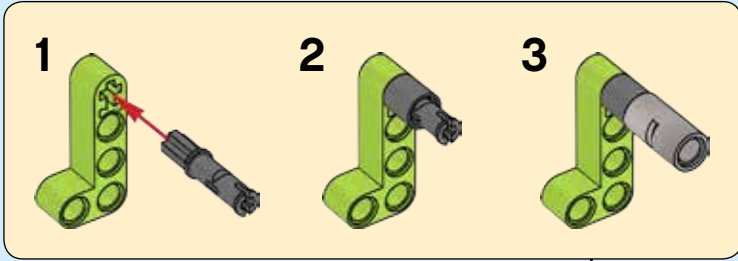

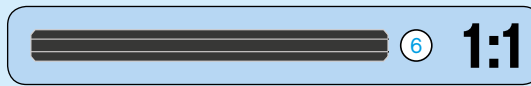
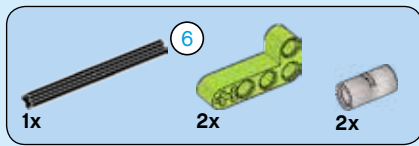

# 25

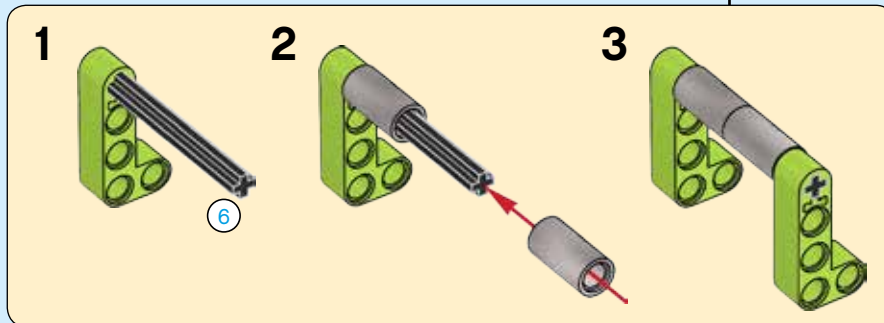
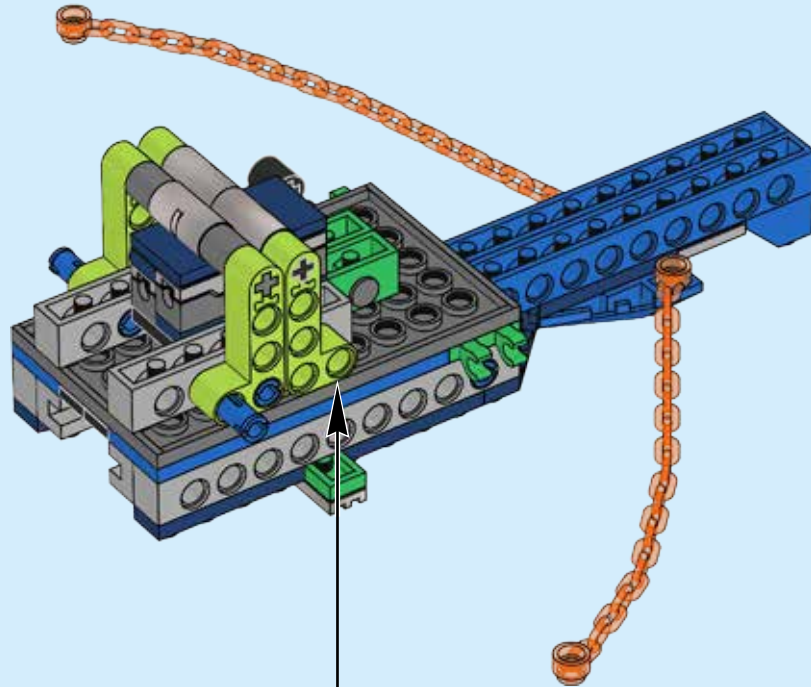

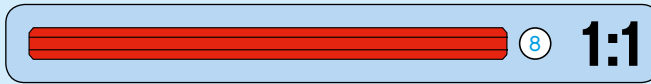
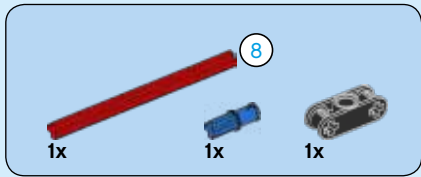

# 26

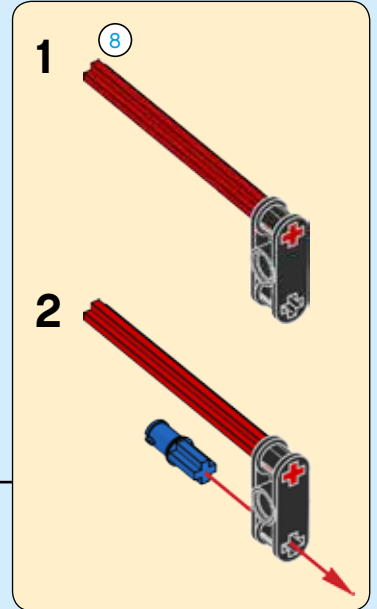
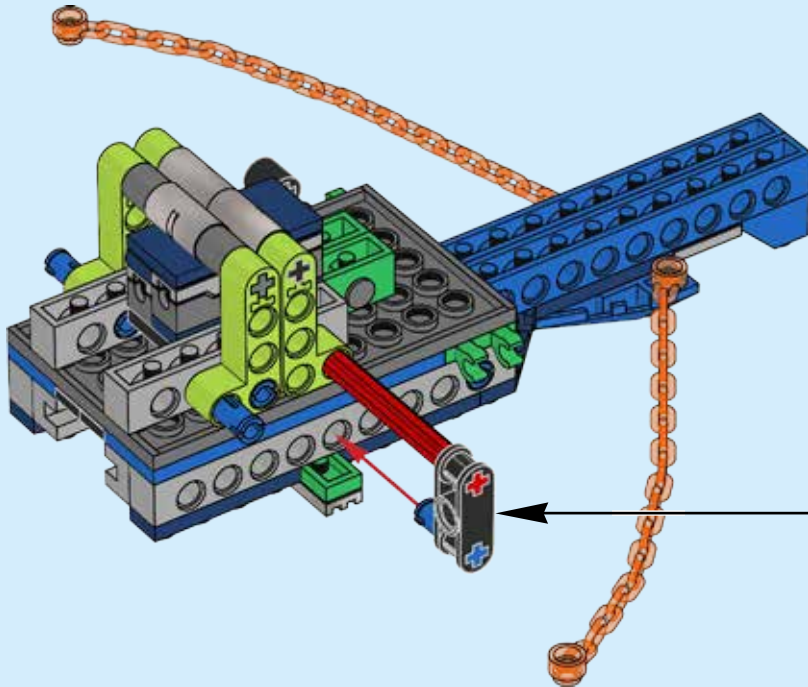



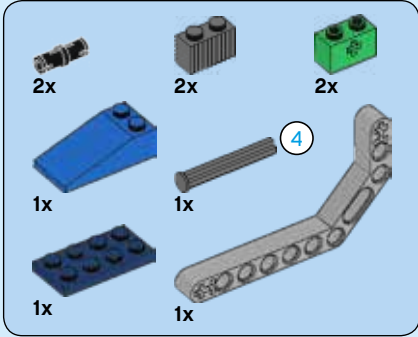
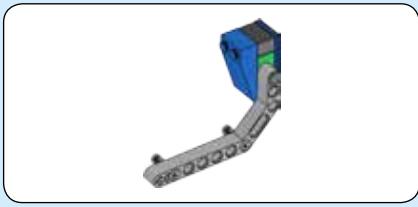

# 27

1



2

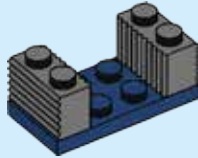

3

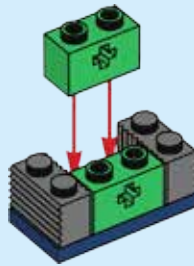

4

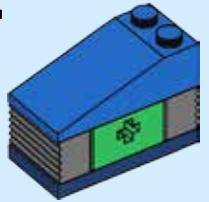

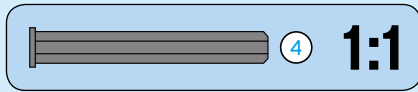
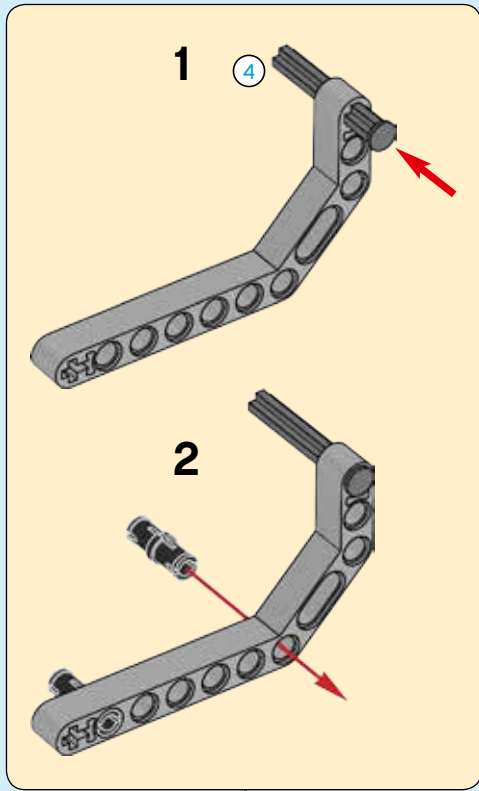

5

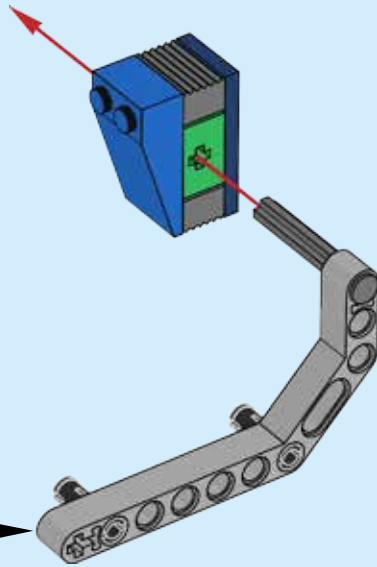
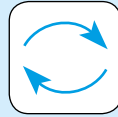

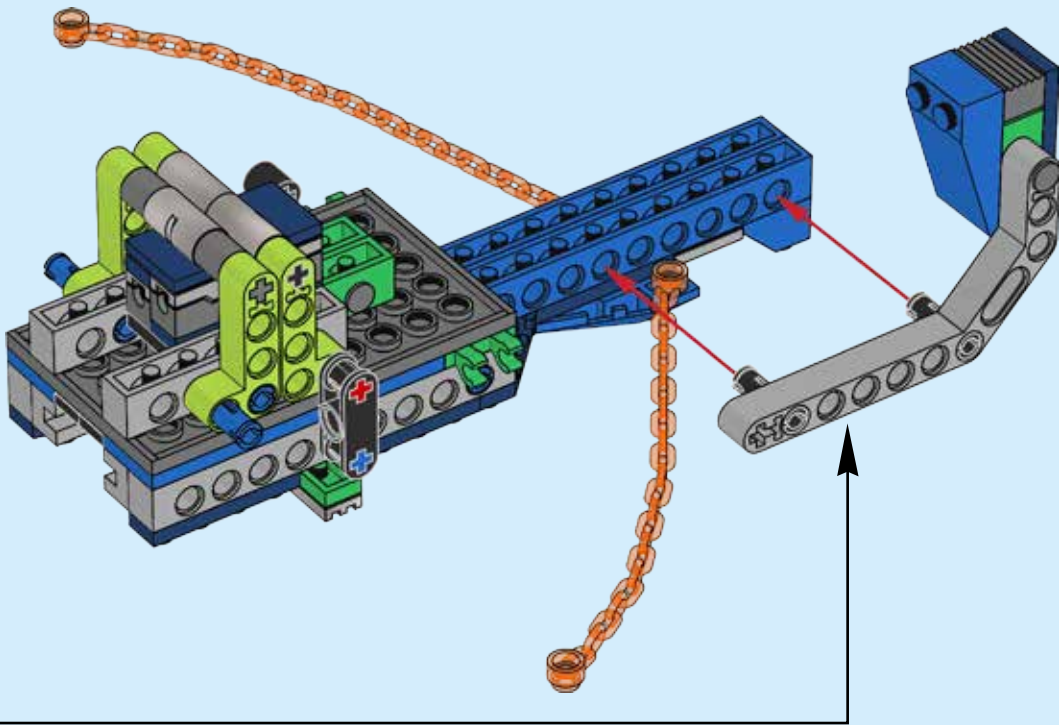



2x

# 28

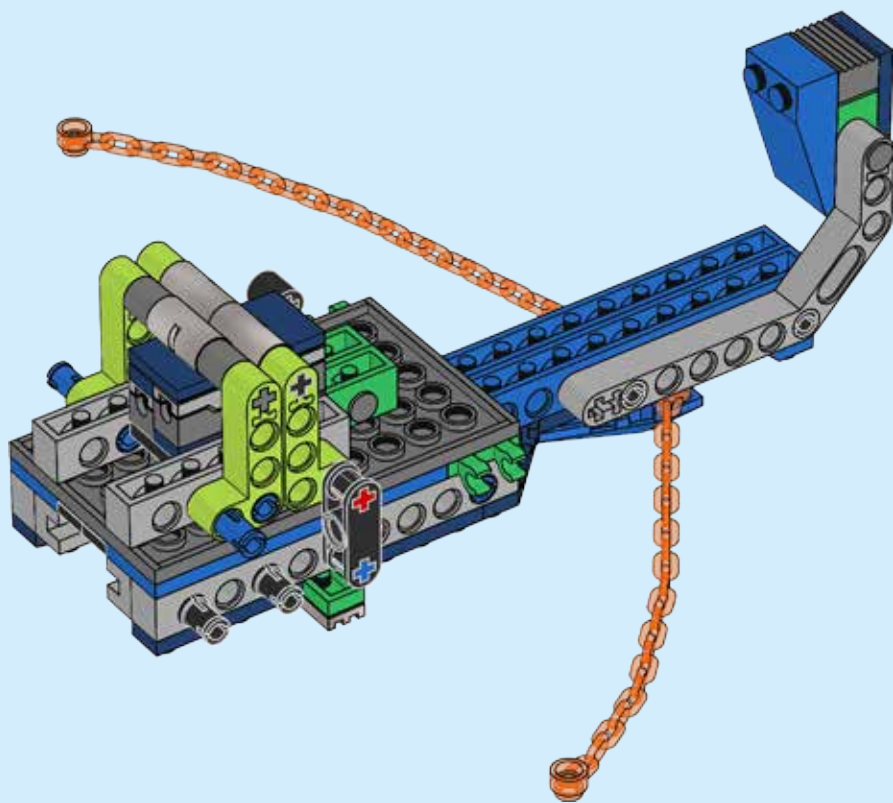



2x

# 29

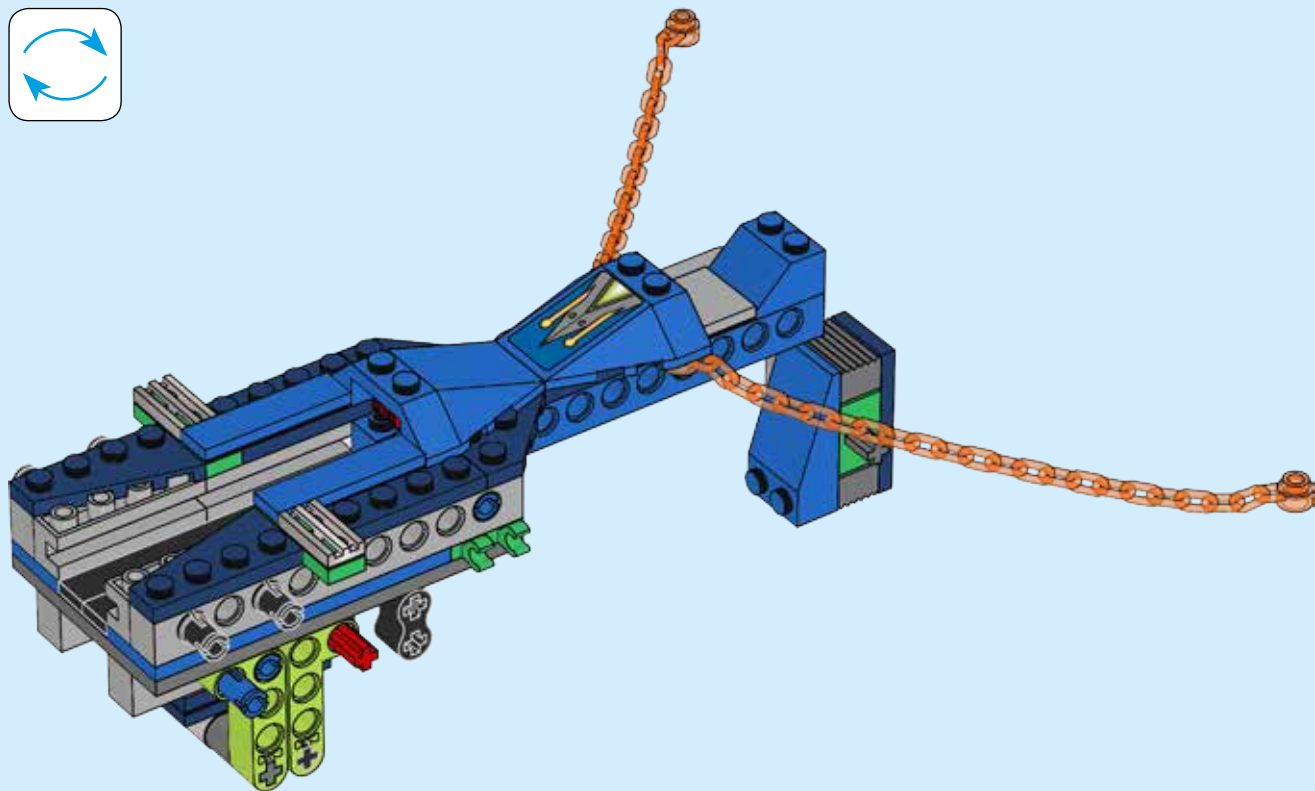
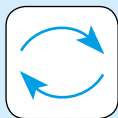



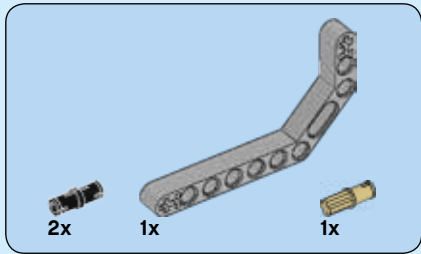

30

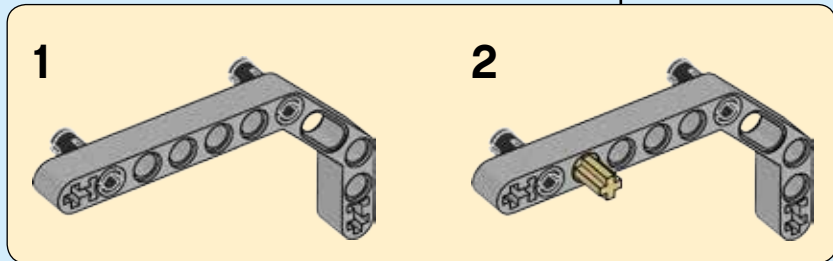
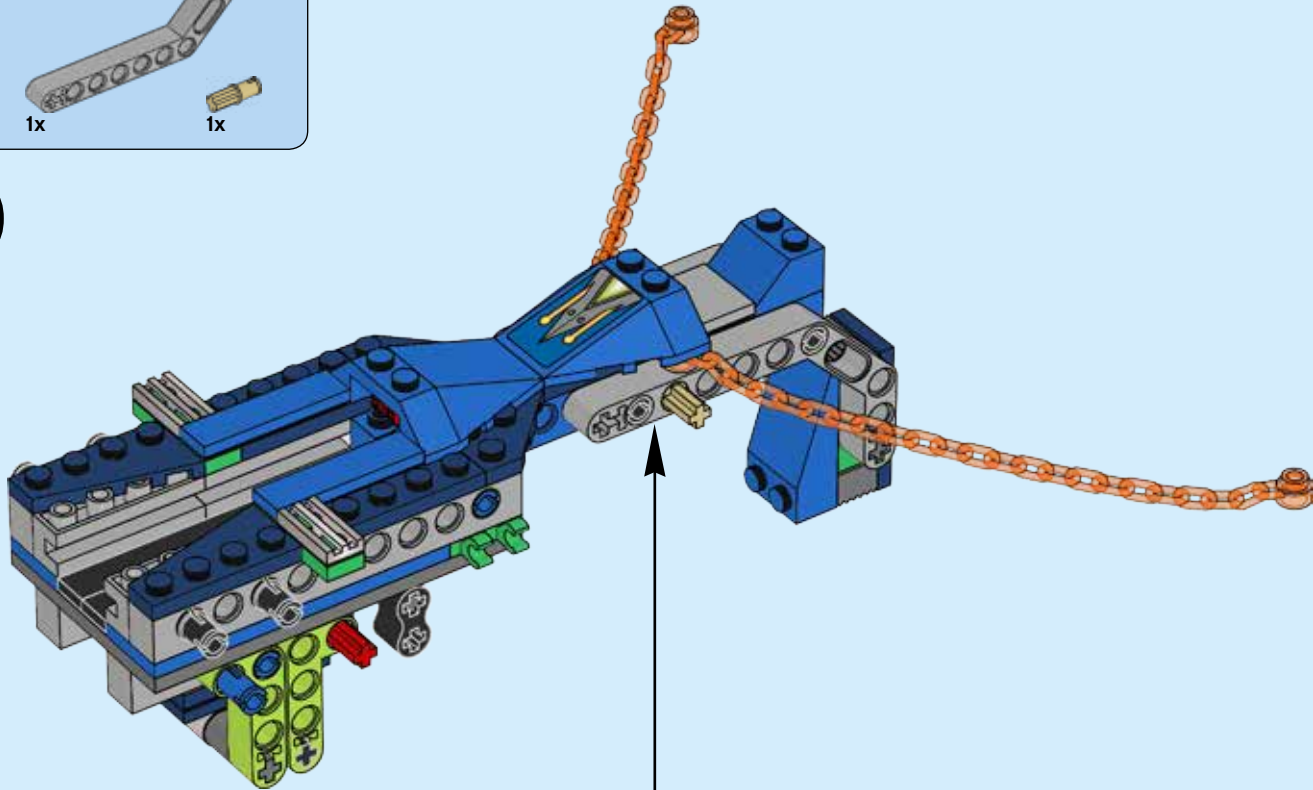



1x



1x

# 31

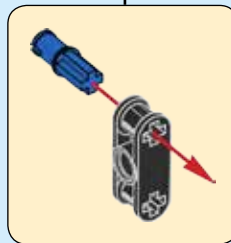
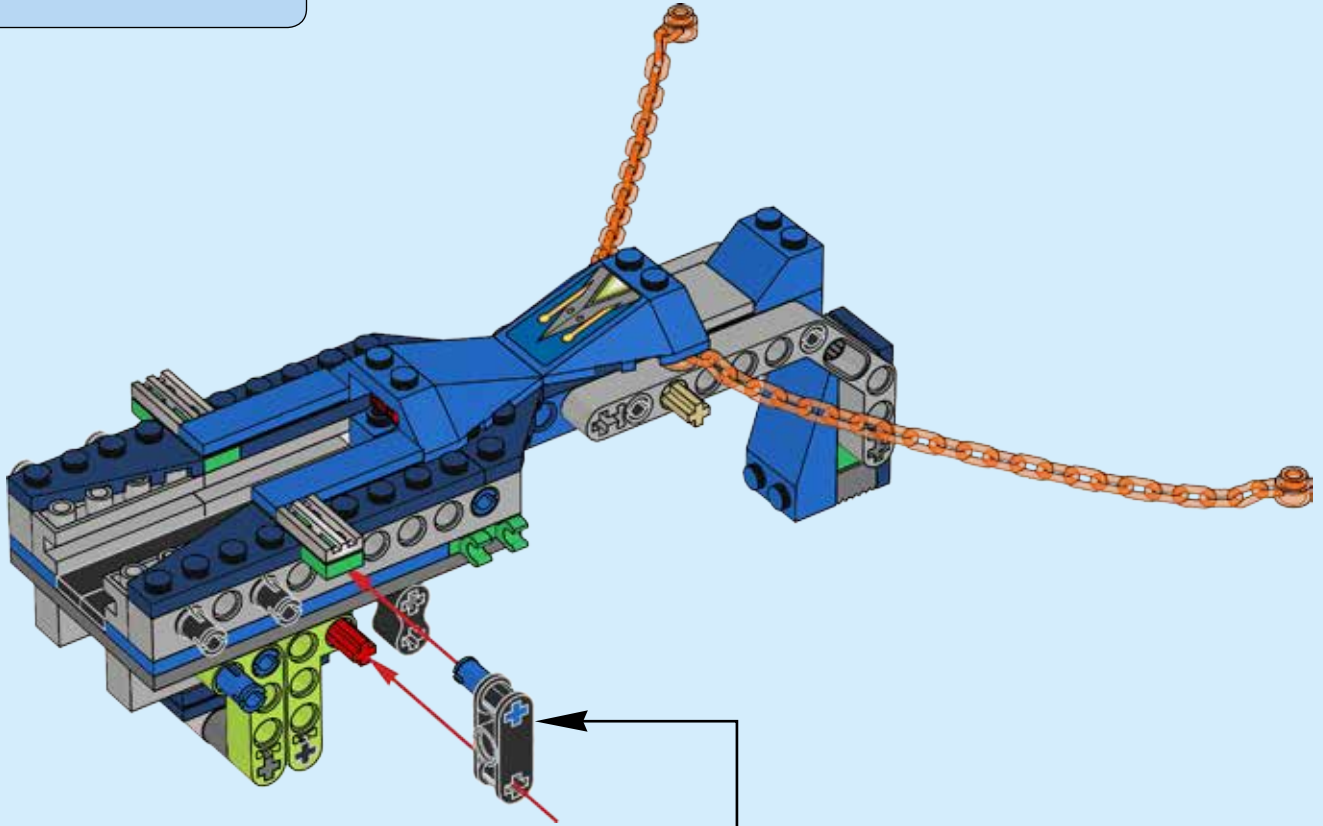



# 32

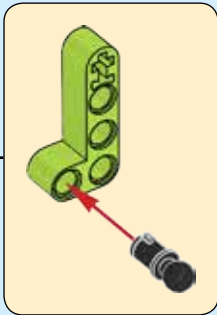
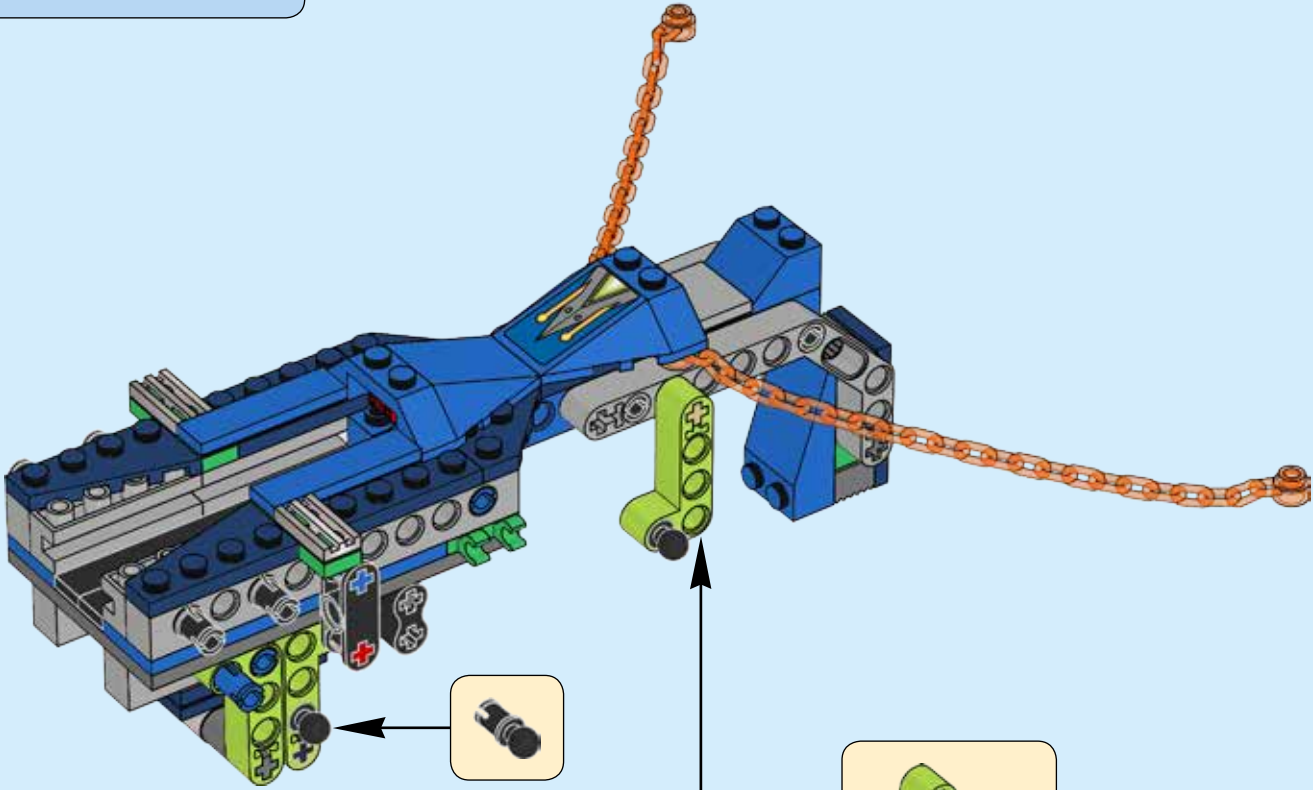

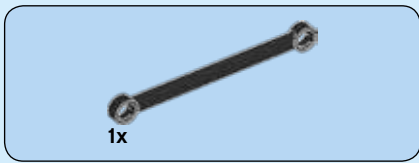

33

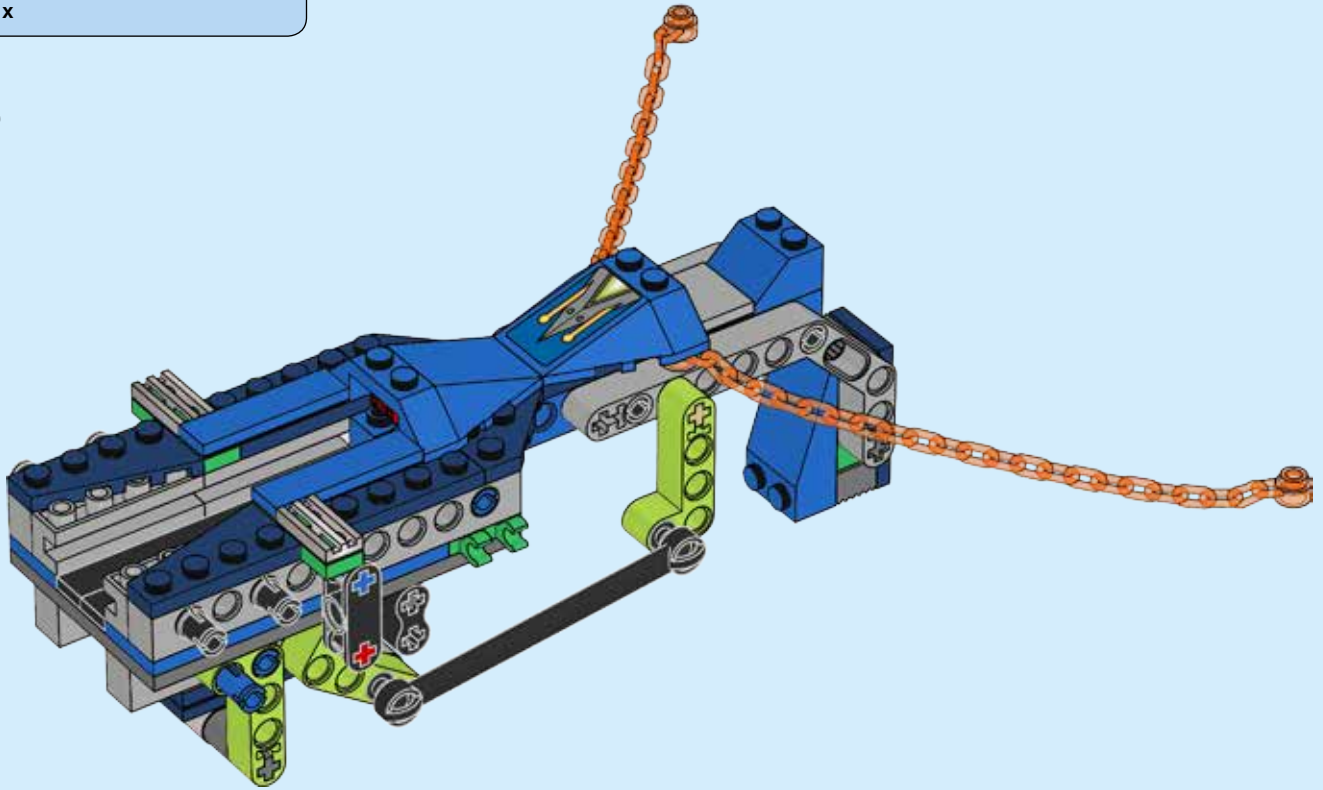

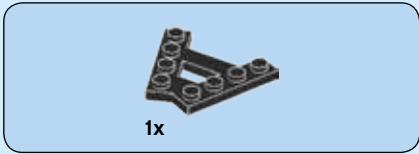
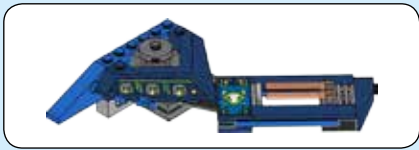

**34**

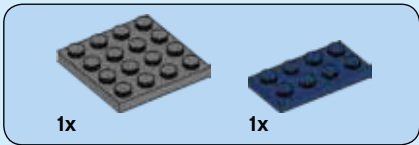
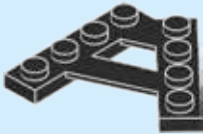

**35**

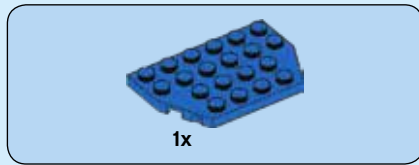
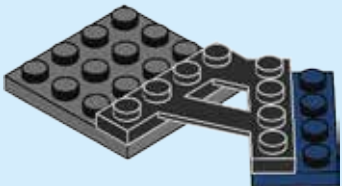

**36**

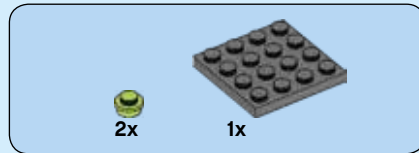
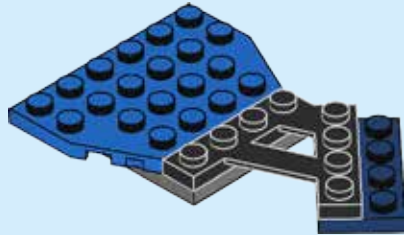

**37**

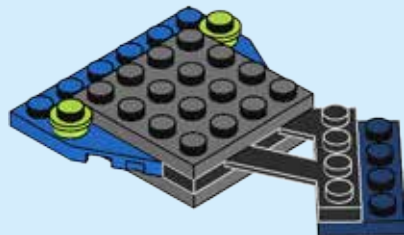



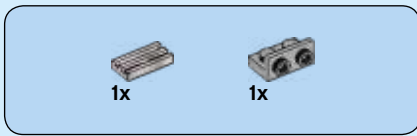

# 38

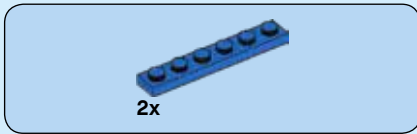
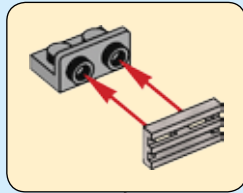

# 39

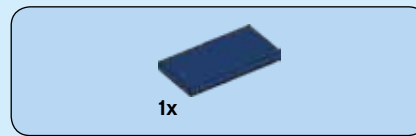
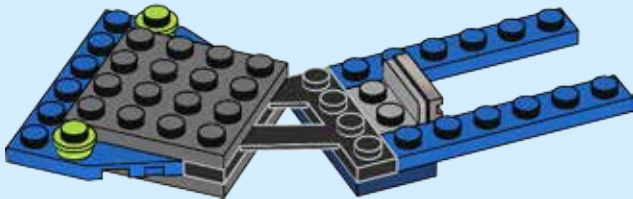

# 40





2x

# 41



1x

# 42



1x



2x

# 43



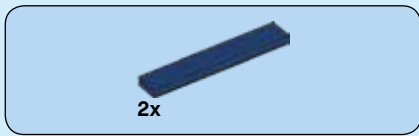

# 44

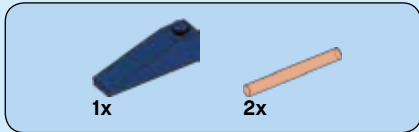
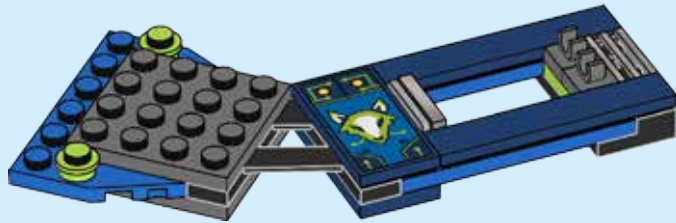

# 45

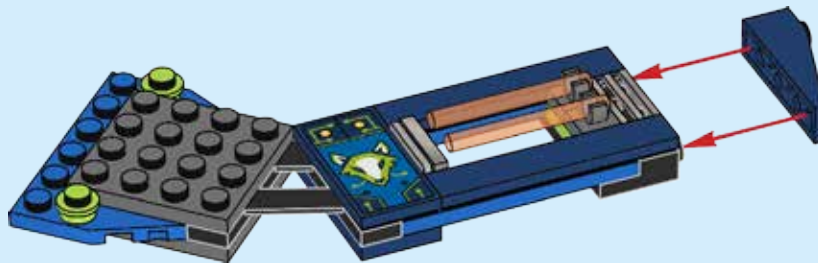



46

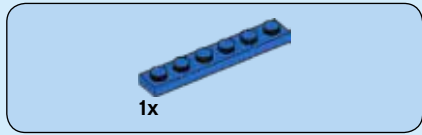
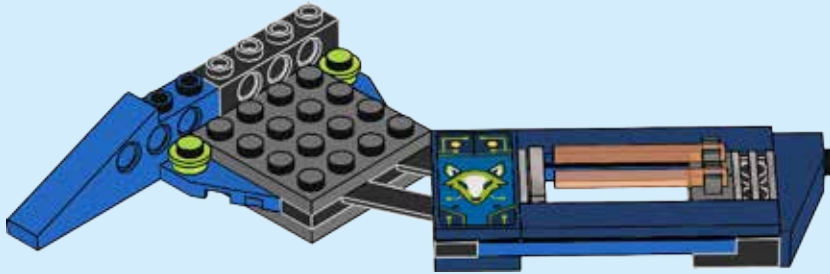

47



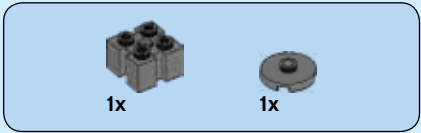

48

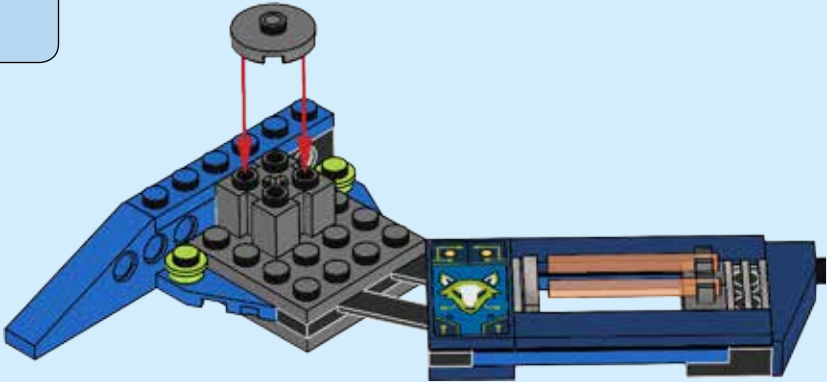

49

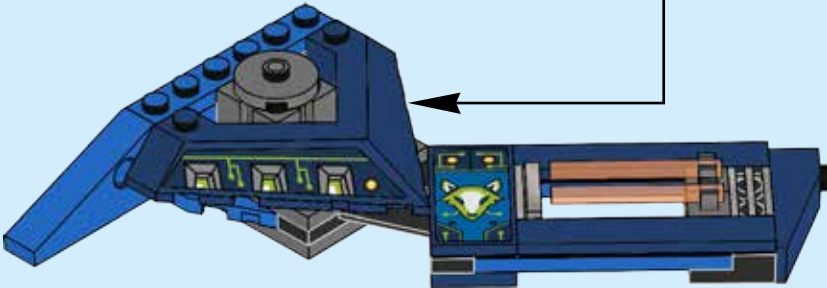

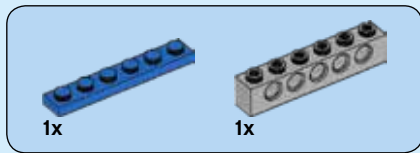

# 50

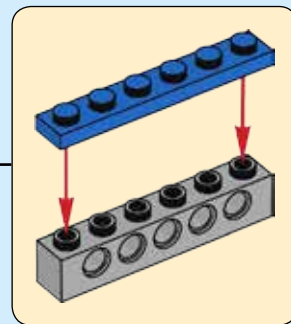
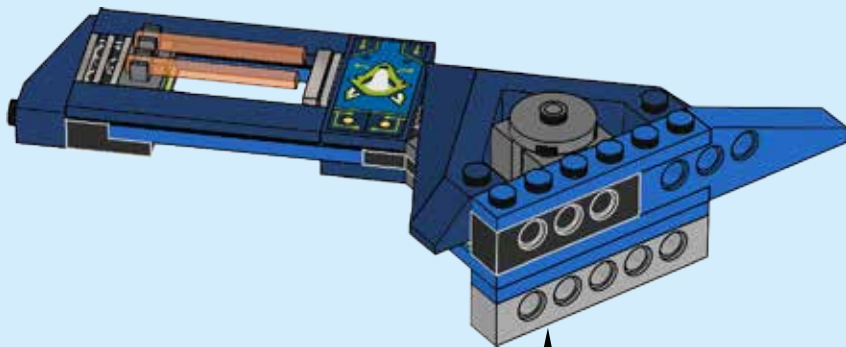
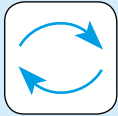

51

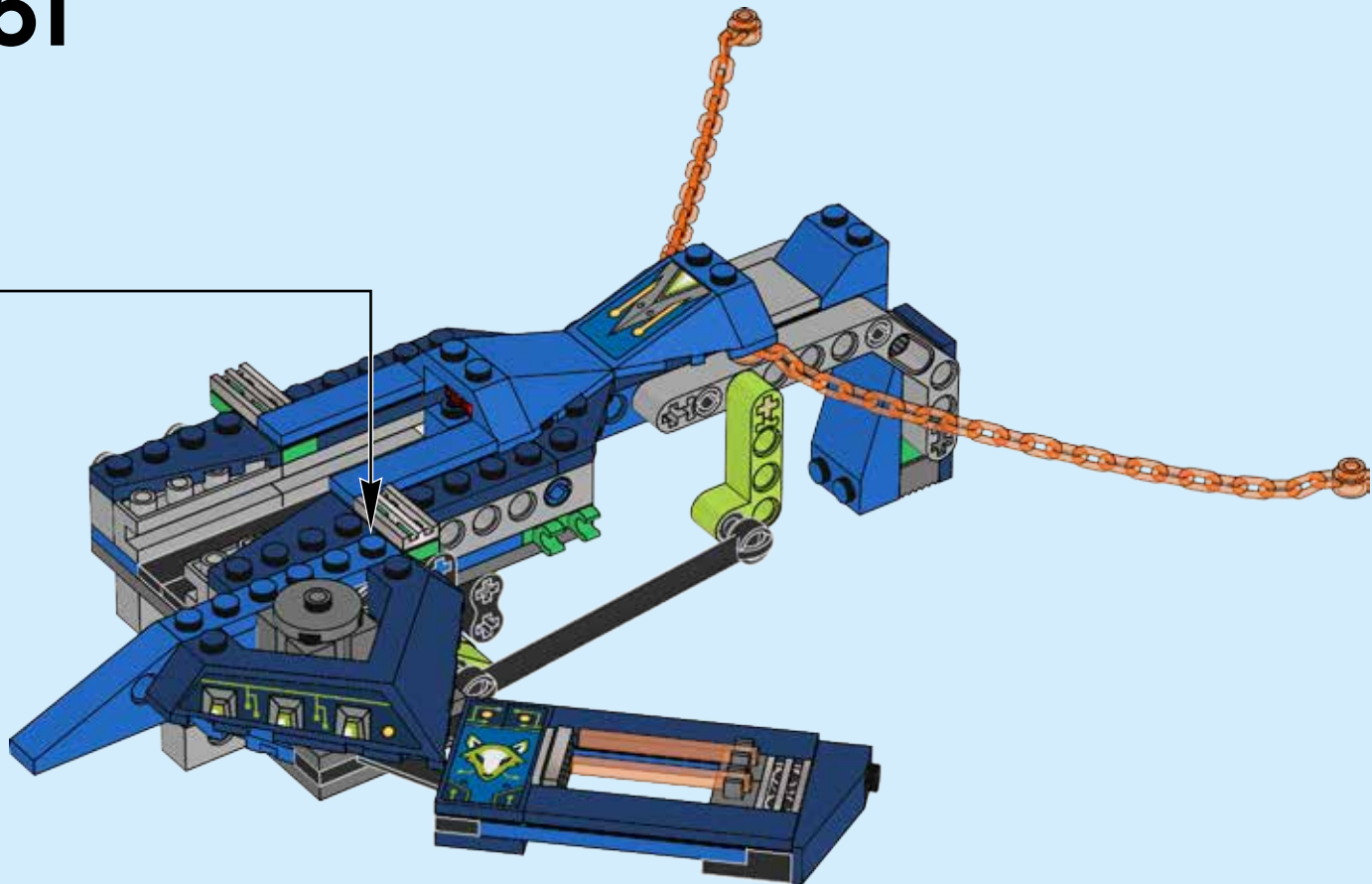

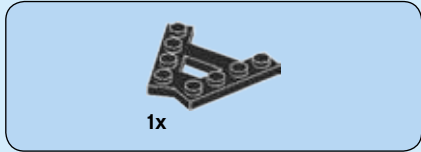
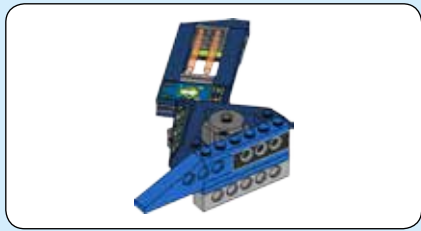

**52**

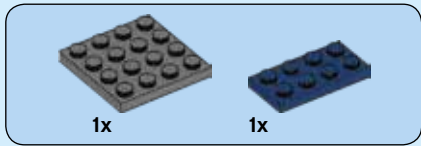
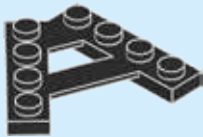

**53**

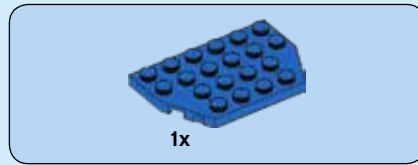
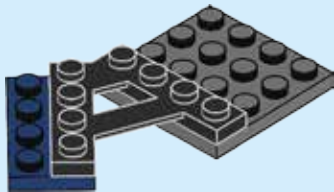

**54**

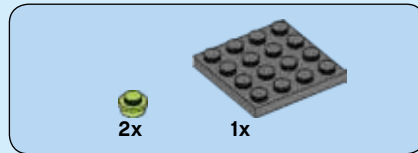
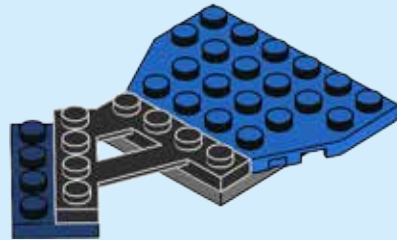

**55**

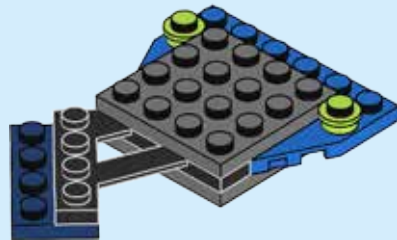



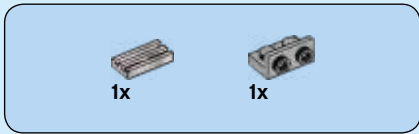

# 56

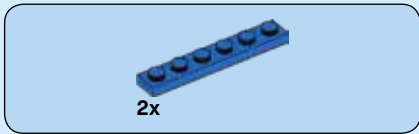
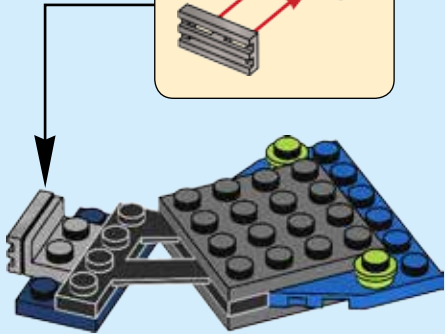
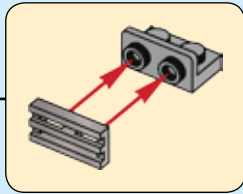

# 57

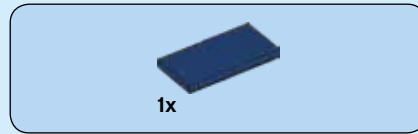
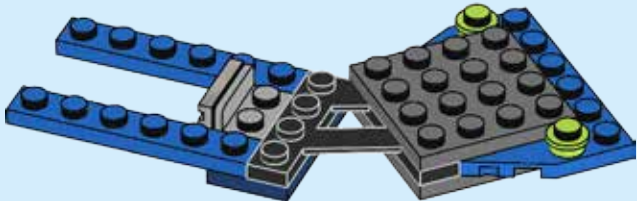

# 58





2x

# 59



1x

# 60



1x



2x

# 61



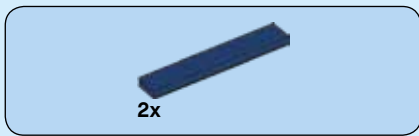

# 62

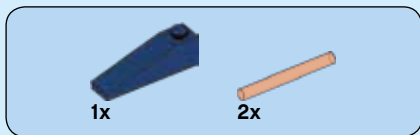

# 63

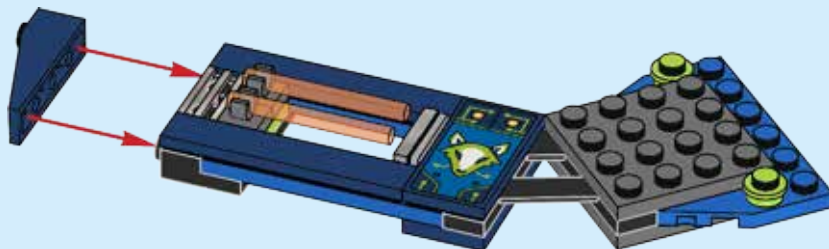



64

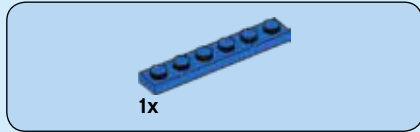
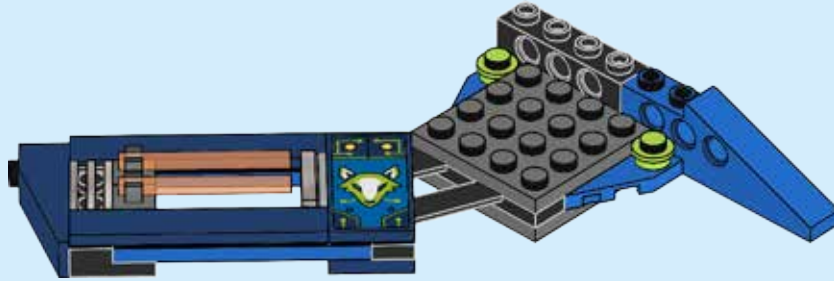

65

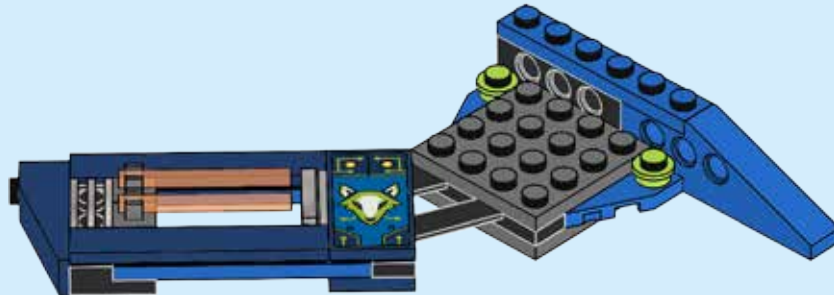

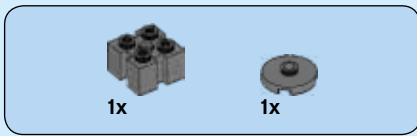

66

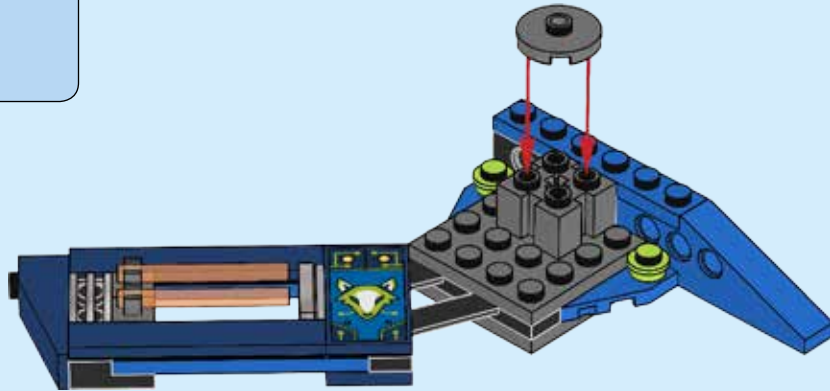

67

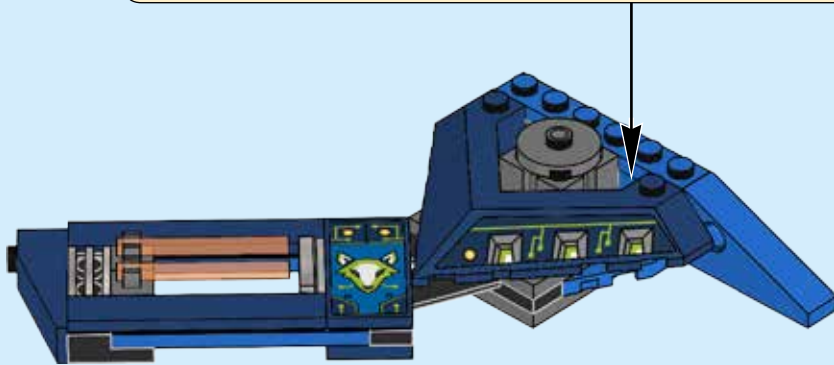
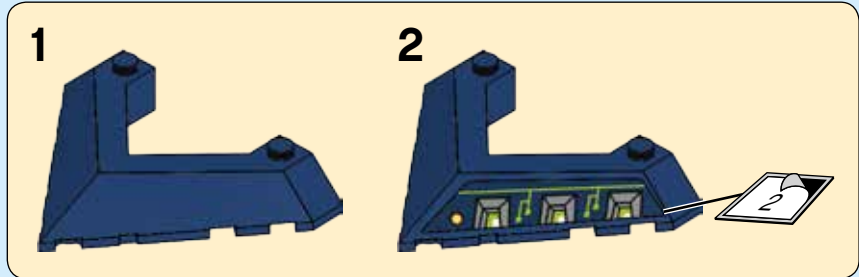

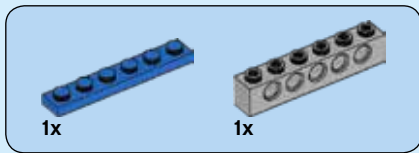

# 68

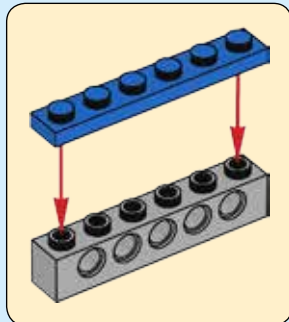
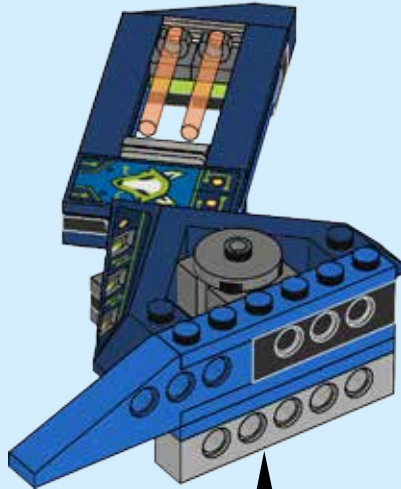
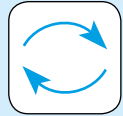

69

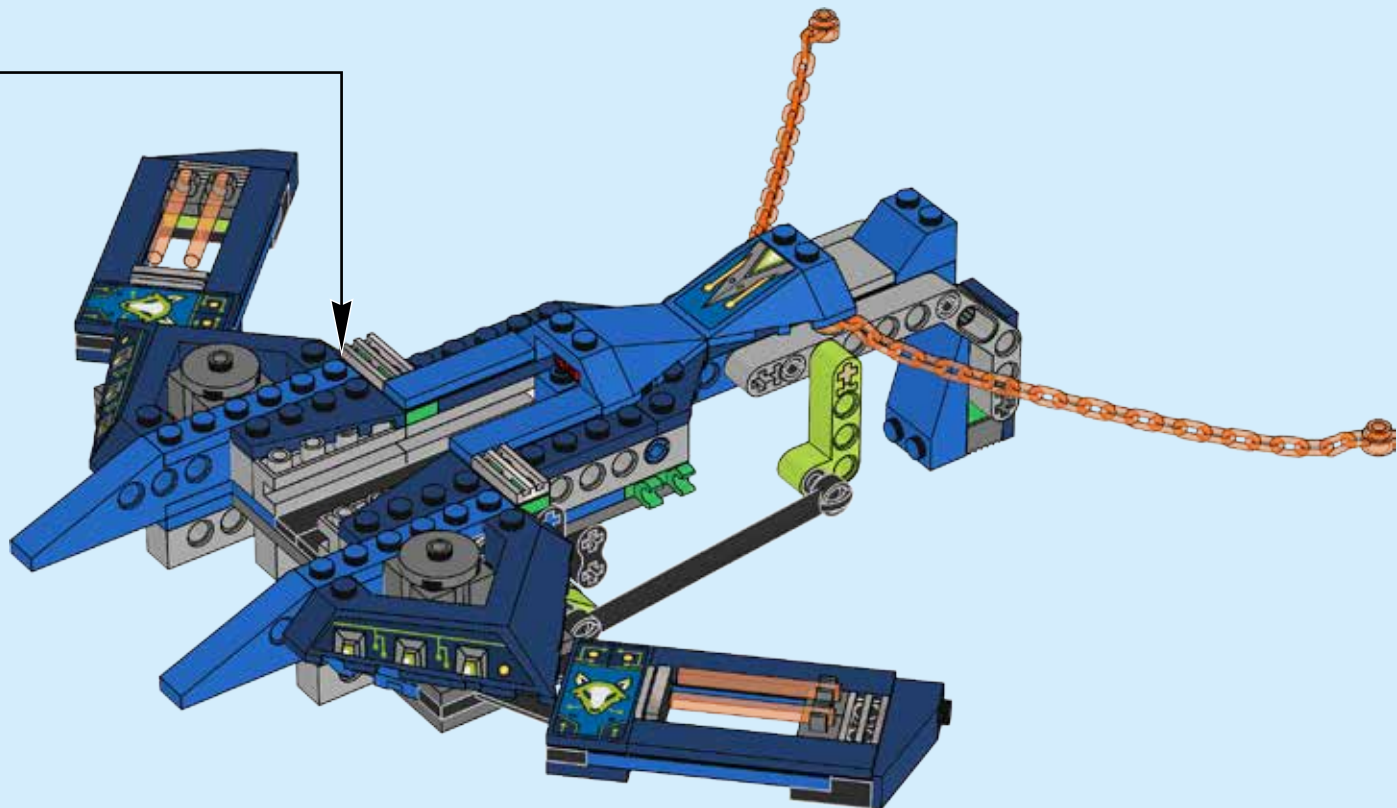

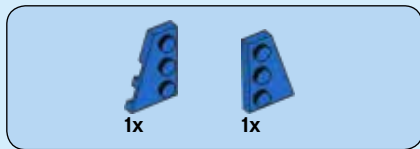

70

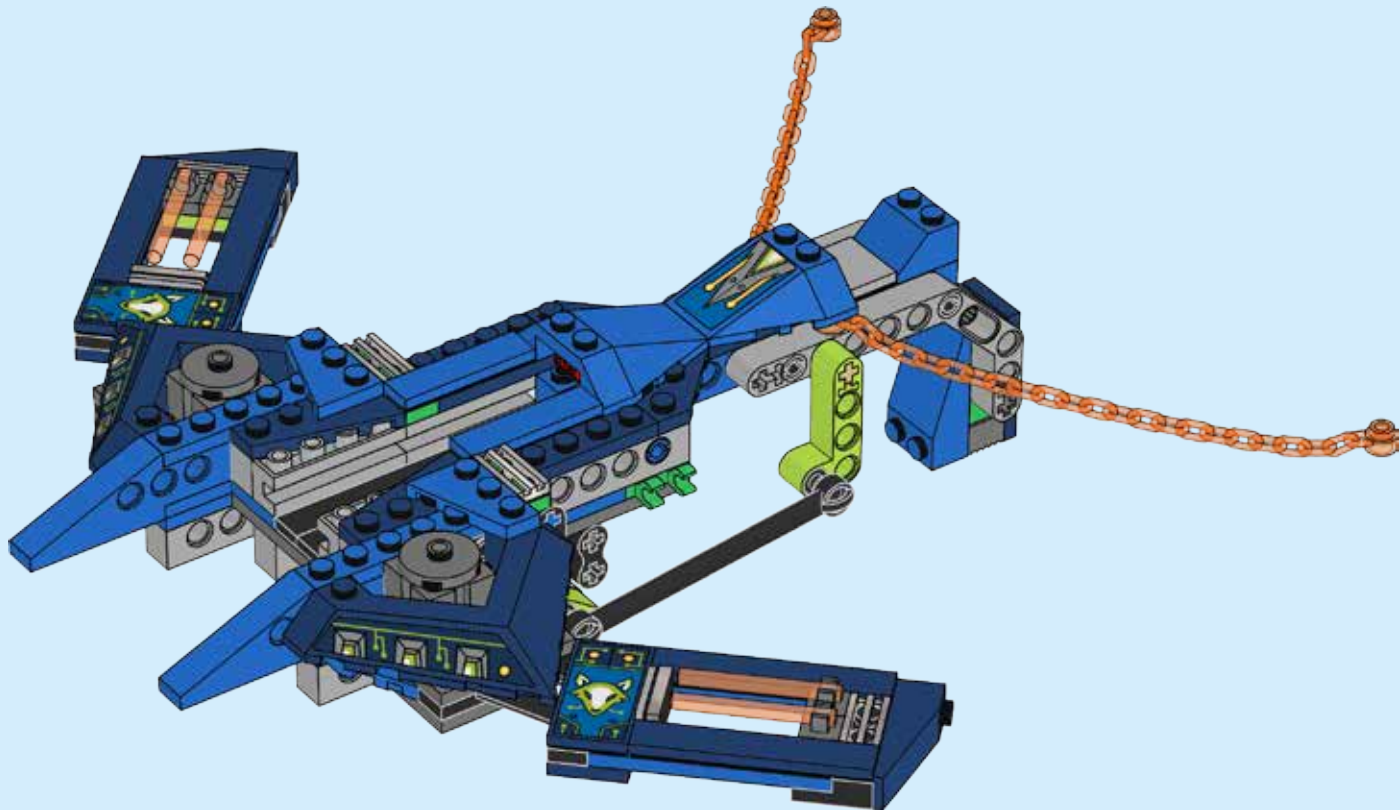



71

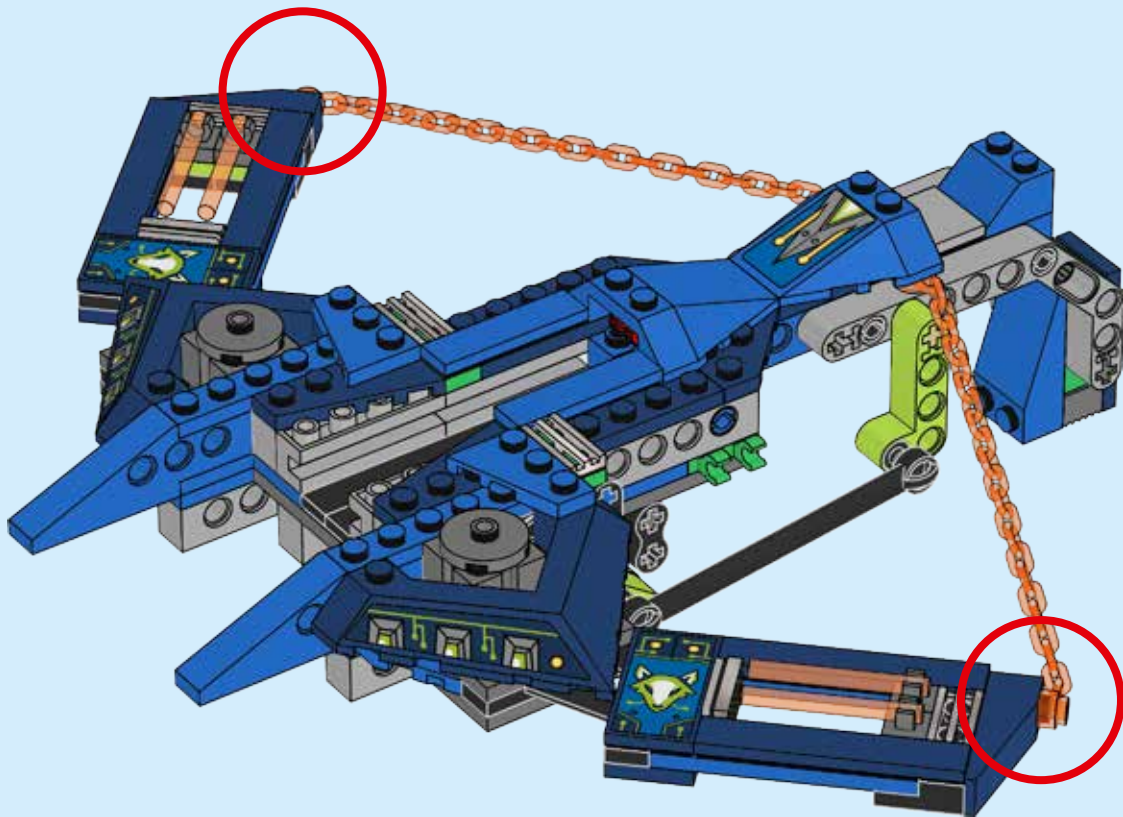



72



73



74



75





1x

# 76

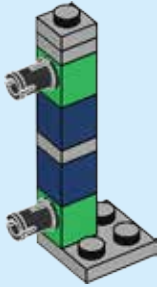

1x

# 77

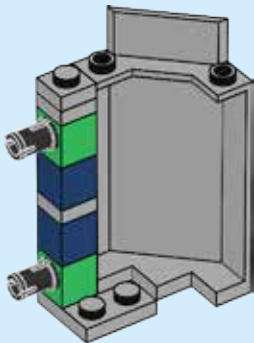

1x

# 78

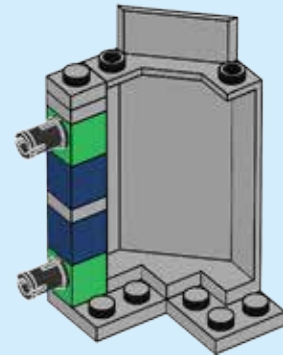

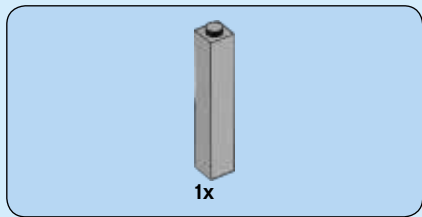

79

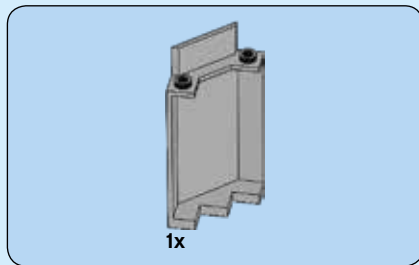
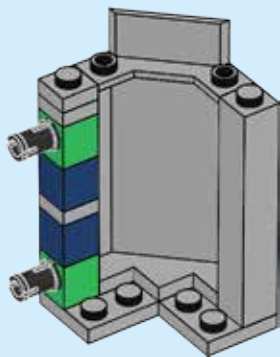

80

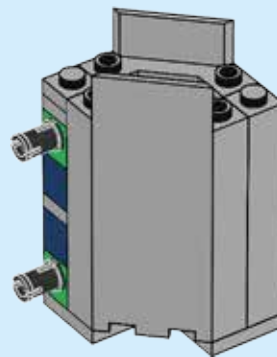



2x

# 81

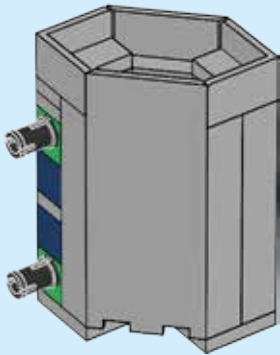

2x

# 82

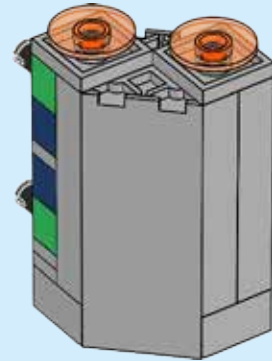
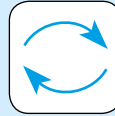

# 83

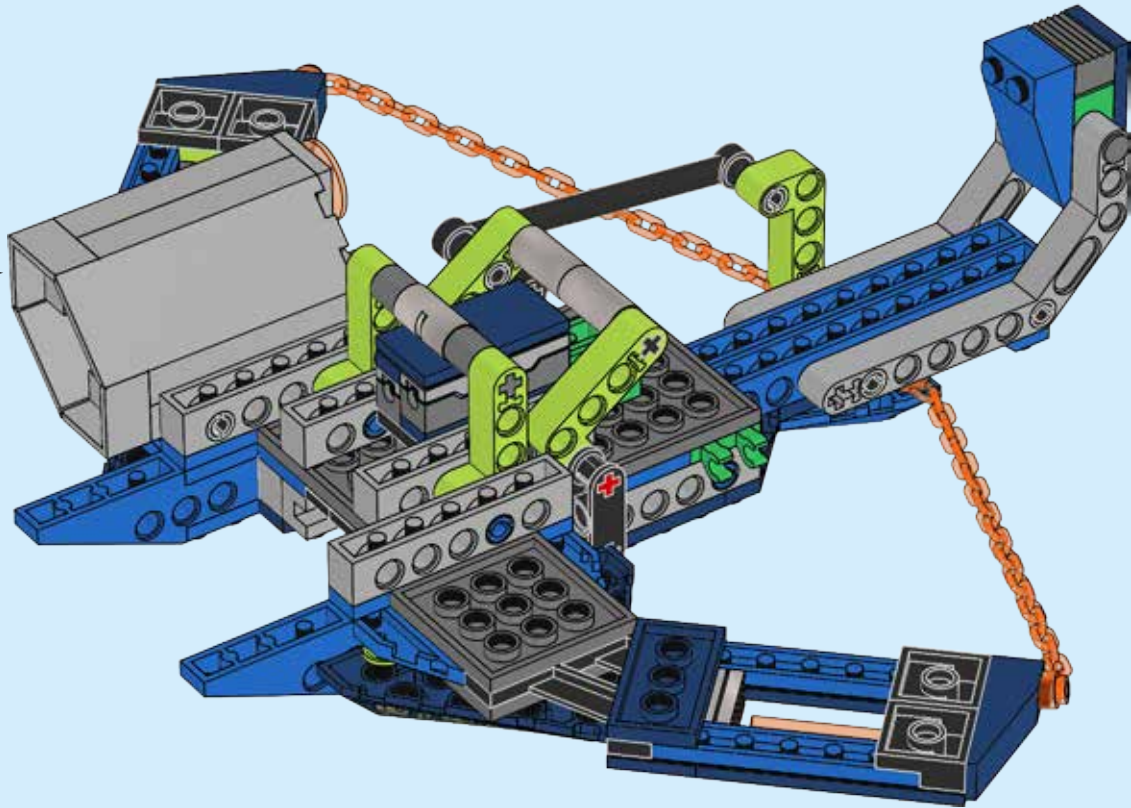
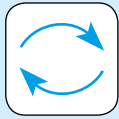



1x



1x

# 84



1x



1x

# 85



2x



1x

# 86



2x

# 87





1x

88



1x

89

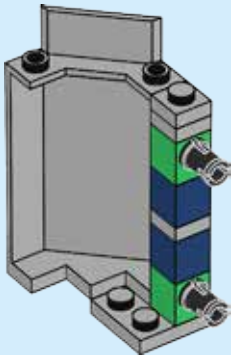

1x

90

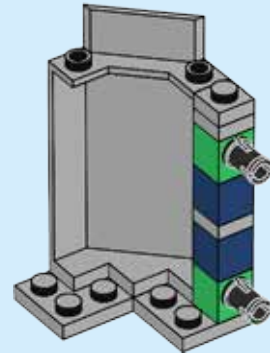



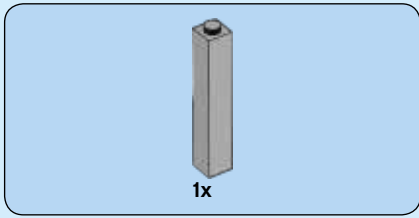

91

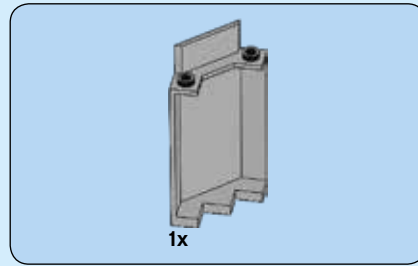
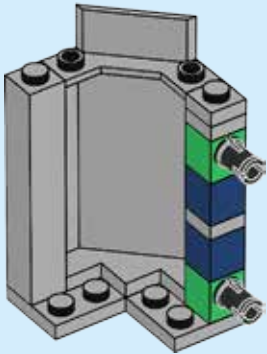

92

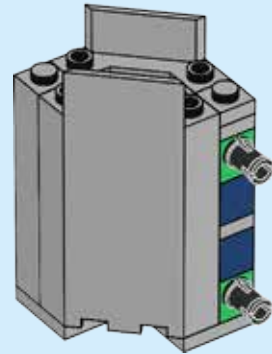



2x

# 93

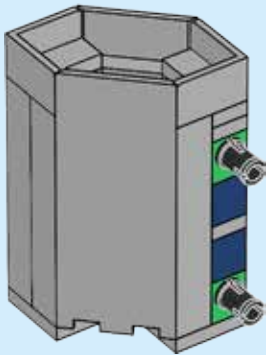

2x

# 94

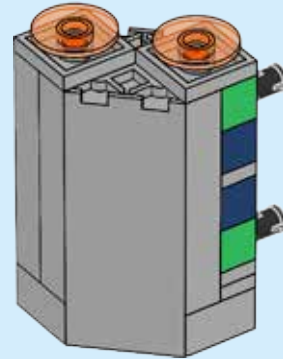
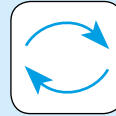

95

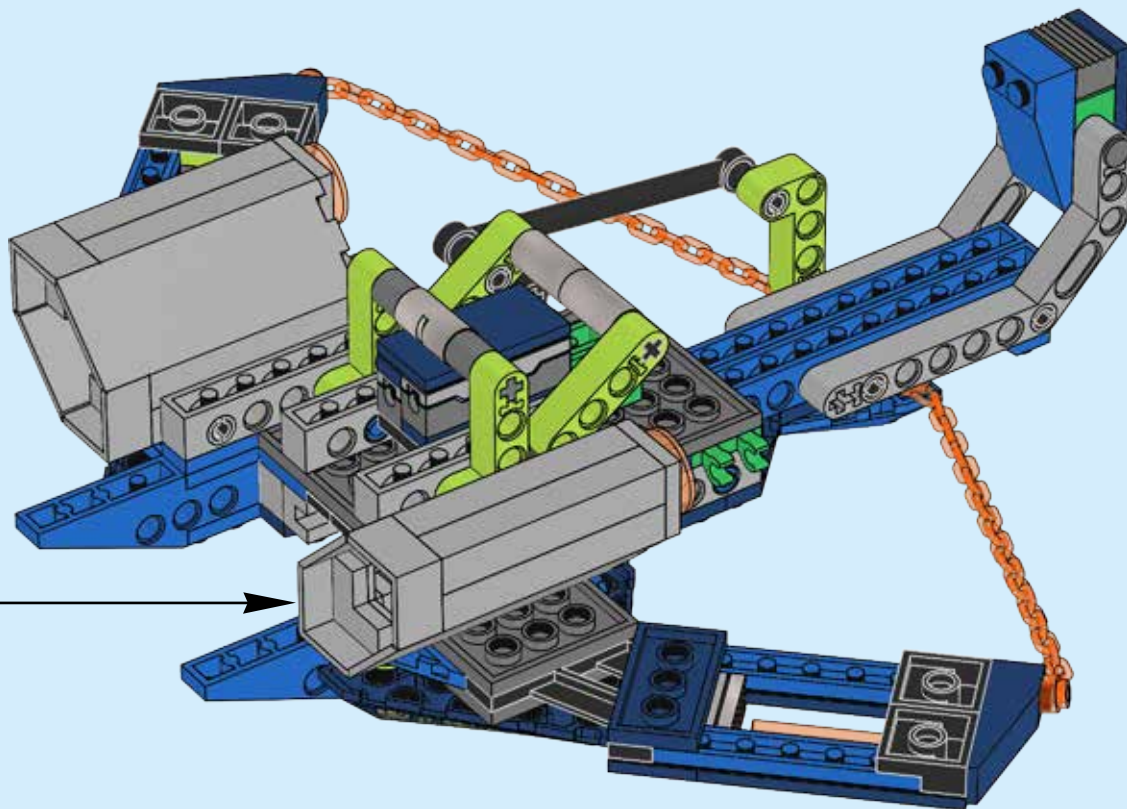

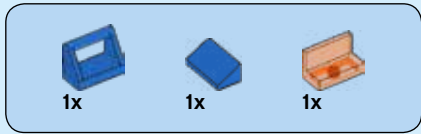

# 96

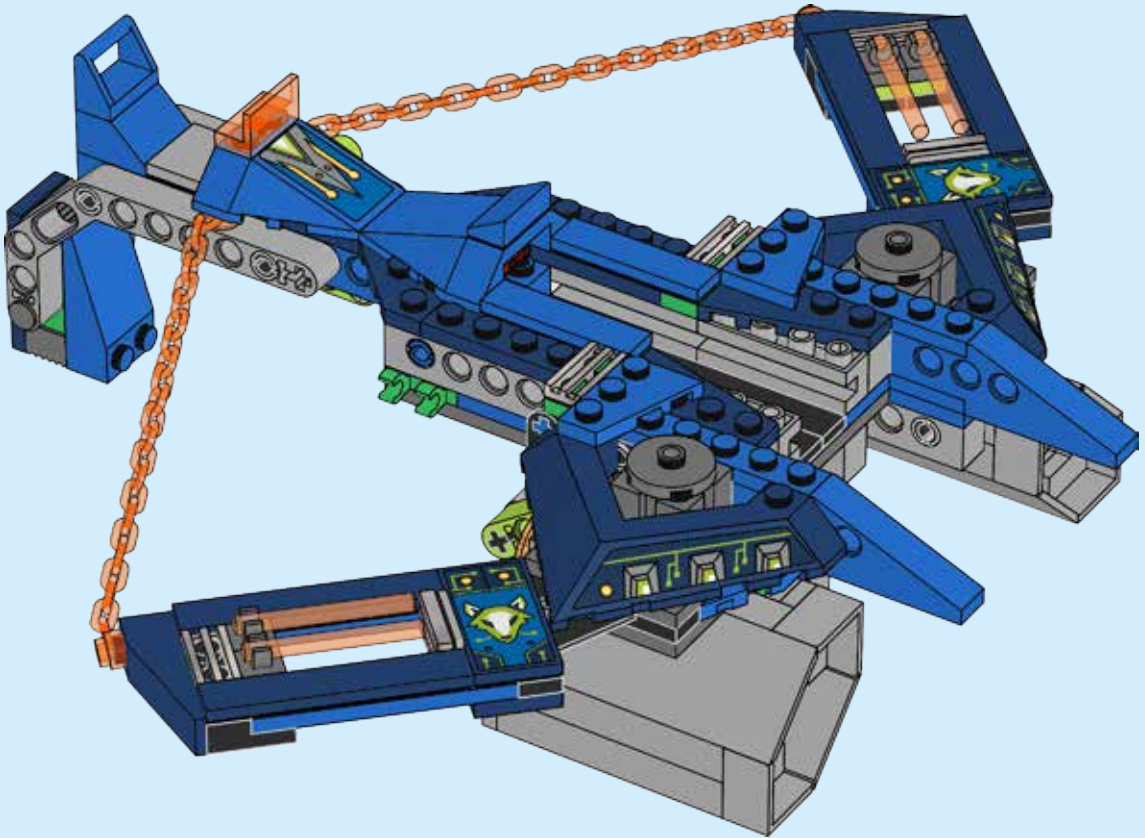
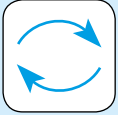

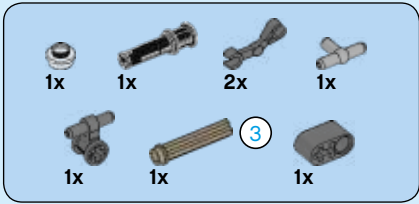
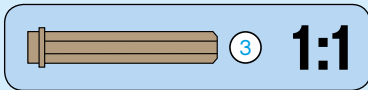

# 97

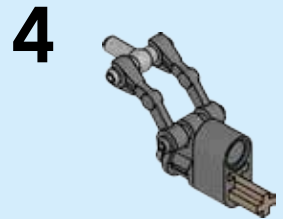
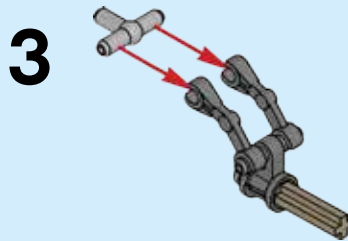
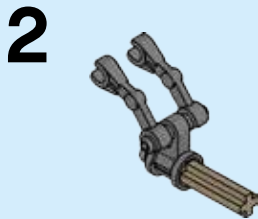
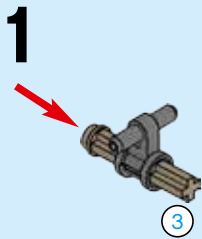

5

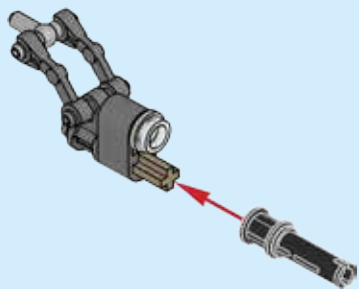

6

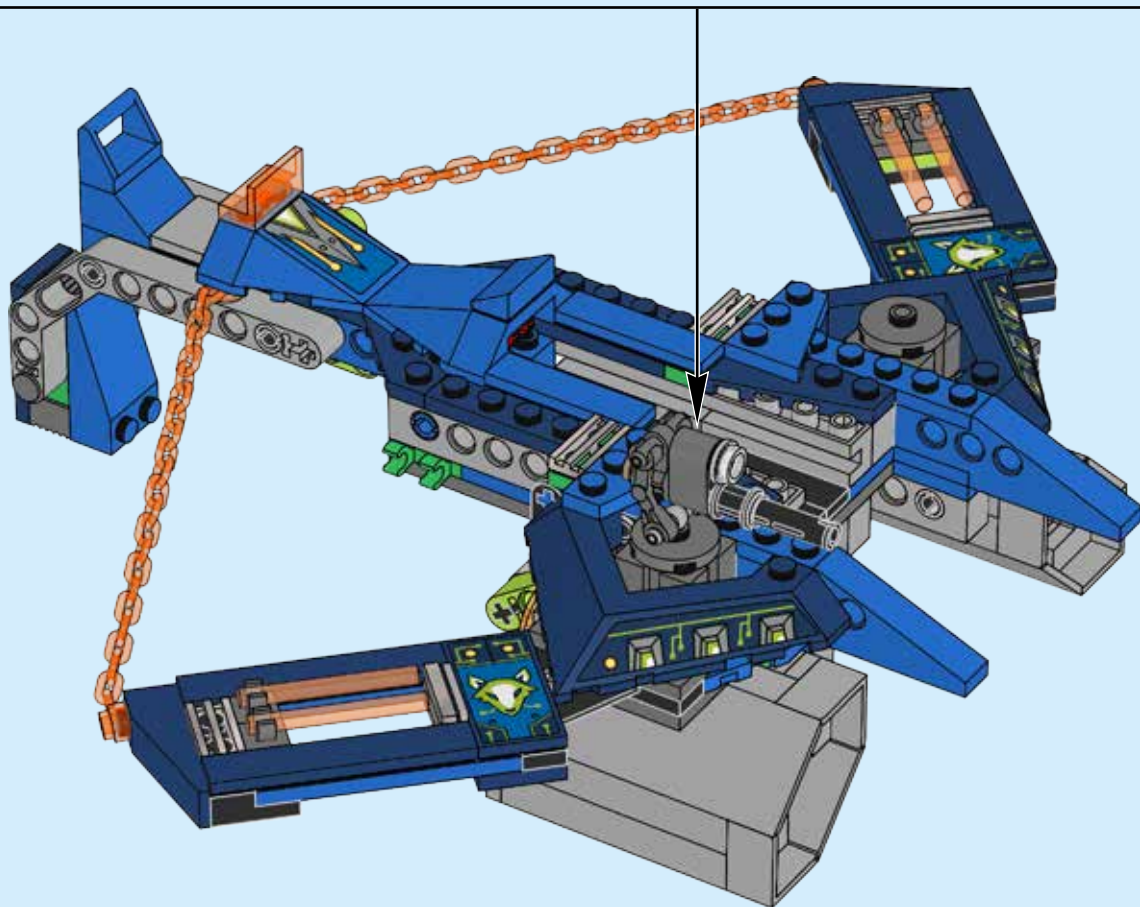
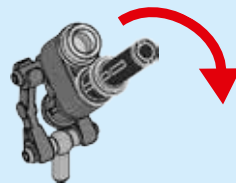
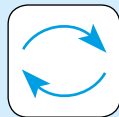



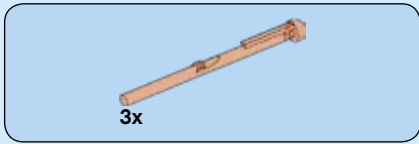

# 98

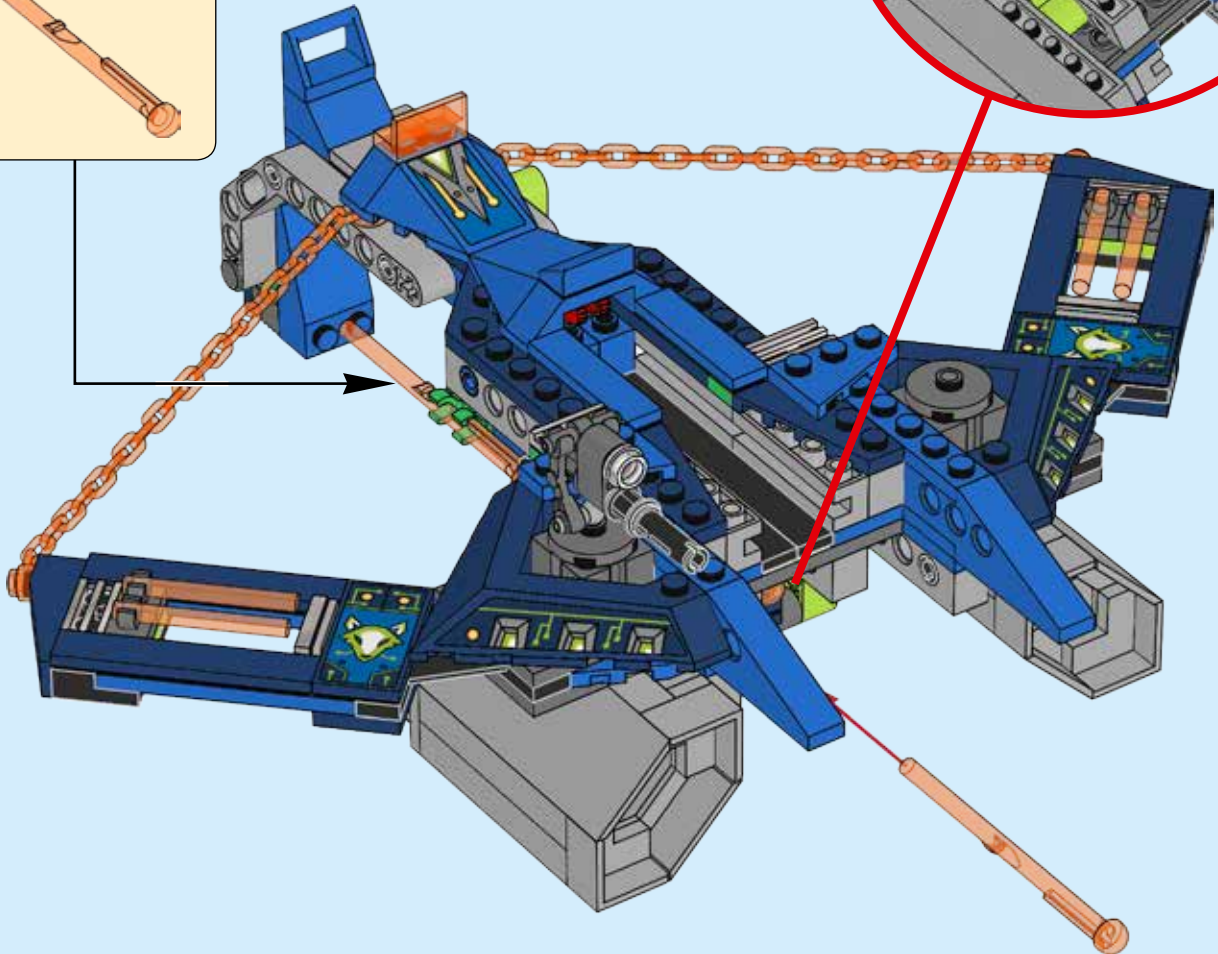
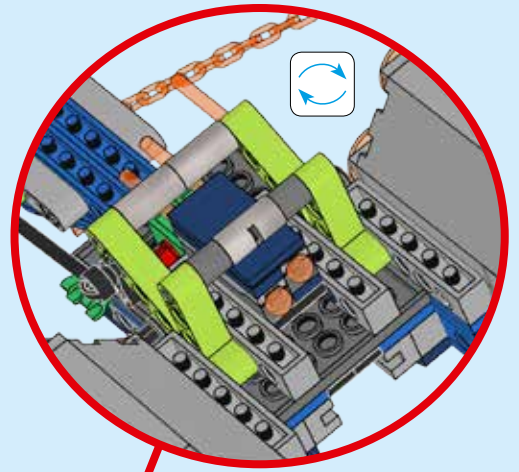
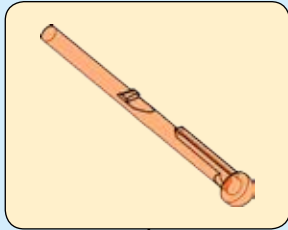

99

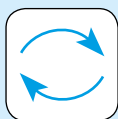



100

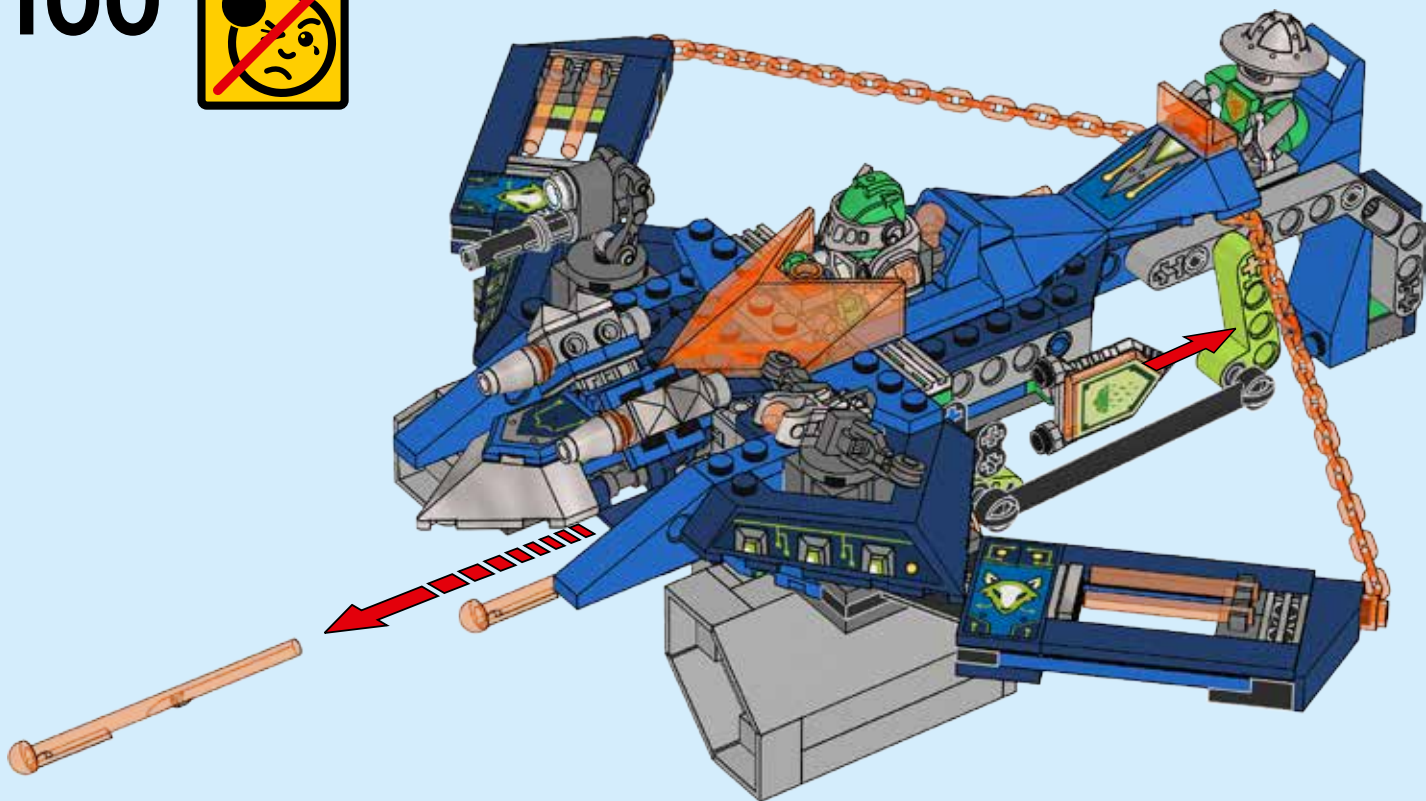

# 101

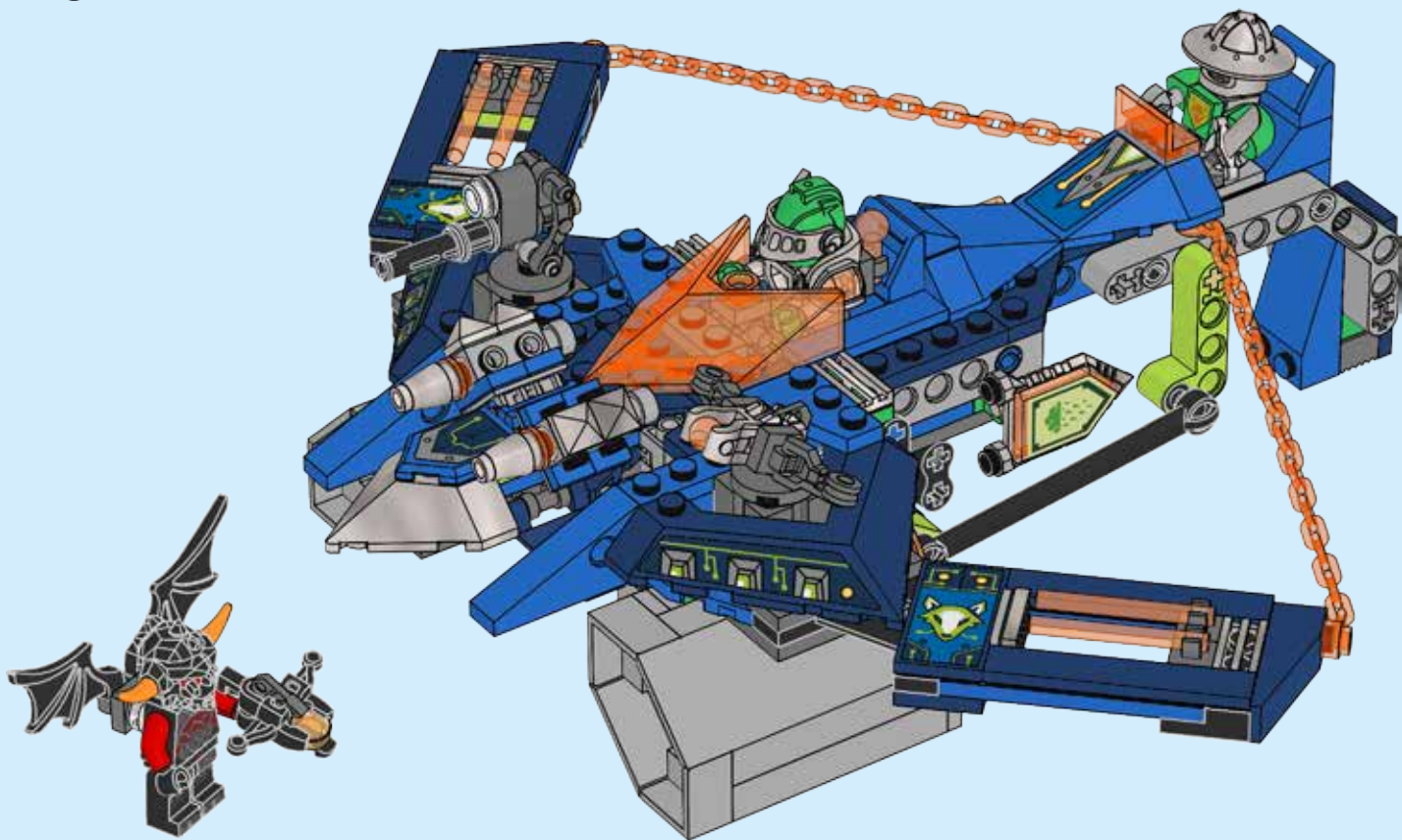



2x  
370001



1x  
4666579



1x  
6125678



1x  
4227155



1x  
4515338



1x  
6130004



1x  
6125693



1x  
6125717



2x  
4184169



12x  
4121715



1x  
6129250



1x  
4198367



2x  
281726



4x  
6052126



1x  
4140801



2x  
4121667



1x  
6117858



2x  
6051532



2x  
370126



2x  
6054852



1x  
370626



2x  
416226



1x  
4141300



1x  
3005740



1x  
6100958



1x  
6100958



1x  
6100958



1x  
4498155



1x  
4498156



1x  
4651236



2x  
4206482



2x  
6069163



4x  
6092582



2x  
243223



2x  
393723



1x  
302223



1x  
303923



6x  
4514553



1x  
6128871



2x  
243123



1x  
6065880



2x  
6030195



2x  
6127332



8x  
366623



2x  
389523

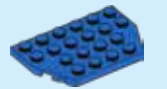

2x  
6016165



3x  
303423



1x  
6124875



1x  
6132187



3x  
3005747



2x  
6131711



4x  
3006347



1x  
6127431



1x  
6131738



4x  
6120914



1x  
6129592



3x  
6124908



2x  
6114250



2x  
6096683



1x  
6031821



2x  
4646865



4x  
4255413



1x  
4529954



1x  
4502091



2x  
4529551



2x  
4613335



2x  
4502089



2x  
6101304



2x  
6110050



9x  
4667595



3x  
4569836



4x  
4252437



2x  
6131732

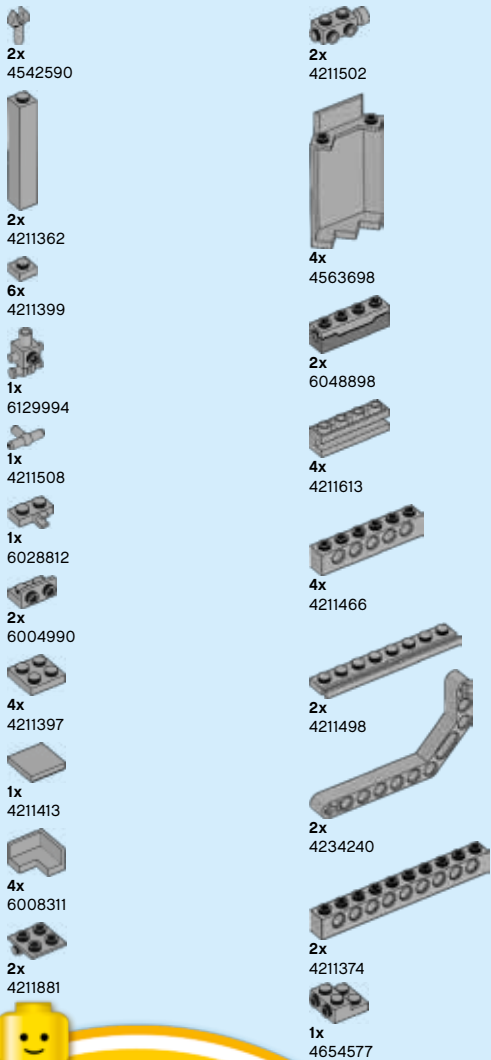



4



**Customer Service**  
 Kundenservice  
 Service Consommateurs  
 Servicio Al Consumidor

[LEGO.com/service](http://LEGO.com/service) or dial

00800 5346 5555 : 

1-800-422-5346 : 





# NEXO KNIGHTS™



DOWNLOAD  
THE FREE APP



TÉLÉCHARGE  
L'APPLI  
GRATUITE

DESCARGA  
LA APP  
GRATIS



LEGO® NEXO KNIGHTS™: MERLOK 2.0



1



2



3



# NEXO KNIGHTS



Scanning Tips / Conseils de scannage /  
Consejos para escanear







# NEXO KNIGHTS



# LEGOLAND



DOWNLOAD THE FREE APP:  
TÉLÉCHARGE L'APPLI GRATUITE :  
DESCARGA LA APP GRATIS:  
LEGO® NEXO KNIGHTS™: MERLOK 2.0

ALL MATERIALS MIGHT NOT BE  
AVAILABLE IN ALL MARKETS.  
CERTAINS MATÉRIELS PEUVENT  
NE PAS ÊTRE DISPONIBLES  
DANS CERTAINS MARCHÉS  
CIERTOS MATERIALES PODRÍAN  
NO ESTAR DISPONIBLES EN  
TODOS LOS MERCADOS.

[LEGO.COM/NEXOKNIGHTS](http://LEGO.COM/NEXOKNIGHTS)





# NEXO KNIGHTS











# NEXO KNIGHTS



SCURRIER  
COURSIER  
DIABLITO  
70323



SCURRIER  
COURSIER  
DIABLITO  
70323



BOOKKEEPER  
GARDIEN DES LIVRES  
GUARDIÁN DEL LIBRO  
70323



ULTIMATE GENERAL MAGMAR  
L'ULTIME GÉNÉRAL MAGMAR  
GENERAL MAGMAR ULTIMATE  
70338



BURNZIE  
70322



BOOK OF MONSTERS  
LE LIVRE DES MONSTRES  
LIBRO DE LOS MONSTRUOS  
70323



JESTRO  
70323



FLAMA  
70321



GENERAL MAGMAR  
GÉNÉRAL MAGMAR  
70321



CRUST SMASHER  
ÉCRASEUR D'ÉCORCE  
70319



ASH ATTACKER  
ATTAQUANT DES CENDRES  
\* 70320 / 70322 / 70323



FLAME THROWER  
LANCEUR DE FLAMMES  
70318



LAVARIA  
70323



ULTIMATE FLAMA  
L'ULTIME FLAMA  
FLAMA ULTIMATE  
70339



ULTIMATE LANCE  
L'ULTIME LANCE  
LANCE ULTIMATE  
70337



ULTIMATE AXL  
L'ULTIME AXL  
AXL ULTIMATE  
70336



AARON  
70320



LANCE  
70323



CLAY  
70321



AXL  
\* 70322 / 70323



MACY  
\* 70319 / 70323



AXL BOT  
BOT DE AXL  
70322



MACY BOT  
BOT DE MACY  
70319



AARON BOT  
BOT DE AARON  
70320



ROYAL GUARD  
GARDE ROYAL  
GUARDIA REAL  
70318







# club™

1



[LEGO.com/club](http://LEGO.com/club)

**JOIN  
FREE TODAY!**

**JOIGNEZ-VOUS  
GRATUITEMENT!**

2



**MAGAZINE INCLUDES:**

- > Building Ideas and Game Tips
- > Kids' Creations
- > Comic Adventures



**LE MAGAZINE COMPREND :**

- > Des idées de construction
- > Des créations super cool
- > Des bandes dessinées

3



**LEGO.com/club | 1-877-518-5346**