

**LEGO**<sup>®</sup>

# ULTRA AGENTS

70172



[LEGO.com/ultraagents](http://LEGO.com/ultraagents)



[LEGO.com/brickseparator](https://LEGO.com/brickseparator)

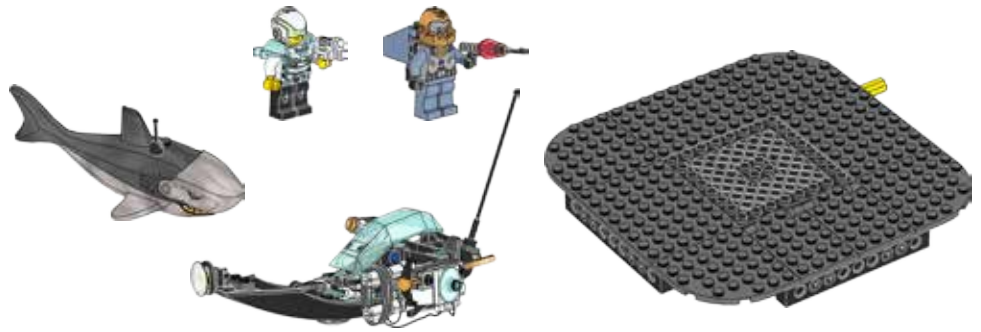

IMPORTANT: Never modify the elements or use other projectiles than provided with this toy.  
IMPORTANT : Ne jamais modifier les éléments ni utiliser d'autres projectiles que ceux fournis avec ce jouet.  
IMPORTANTE: No modifique los elementos ni utilice otros proyectiles diferentes a los suministrados junto con este juguete.

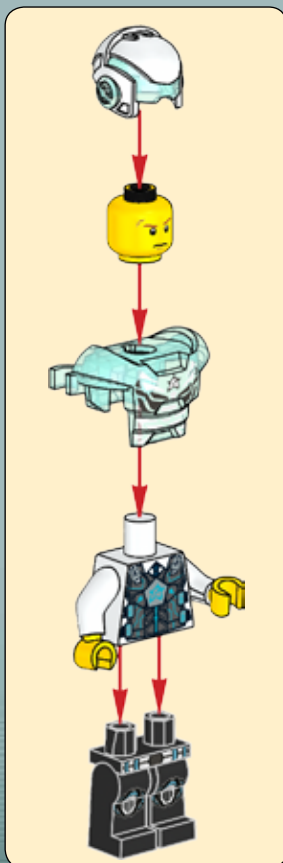

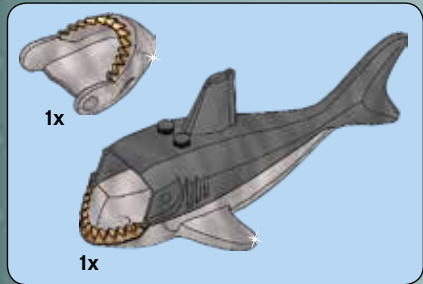
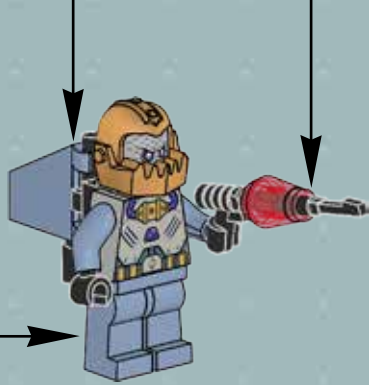
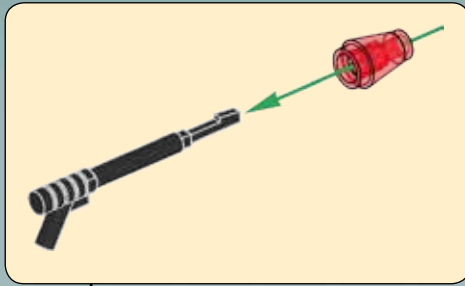
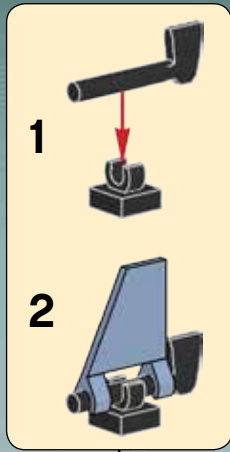
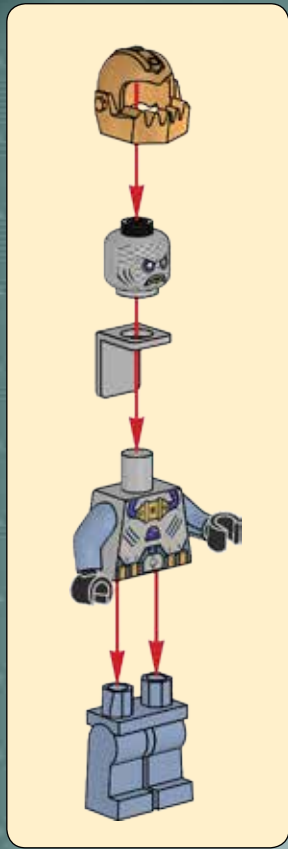

1

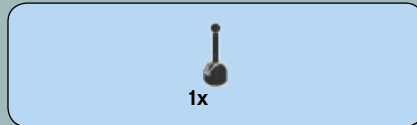
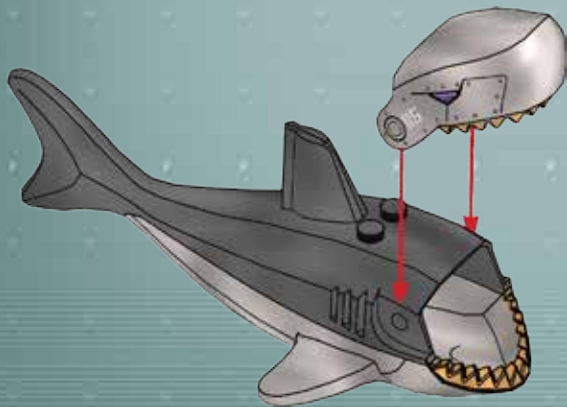

2

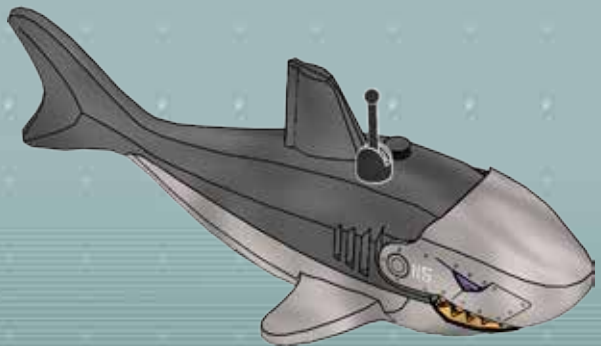

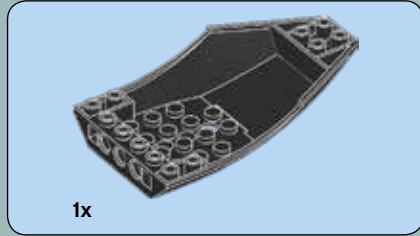
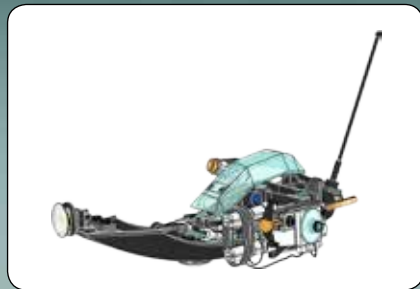

1

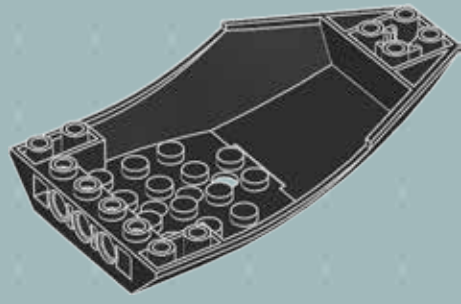

2

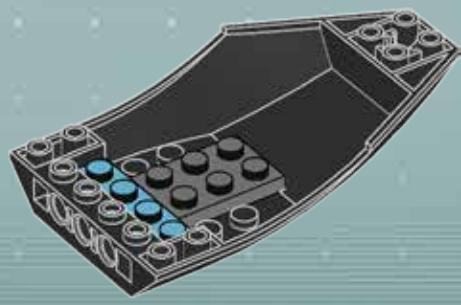

30 mm

20 mm

10 mm

10 mm

20 mm

30 mm

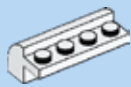

1x

3

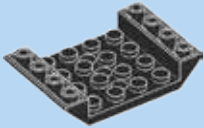
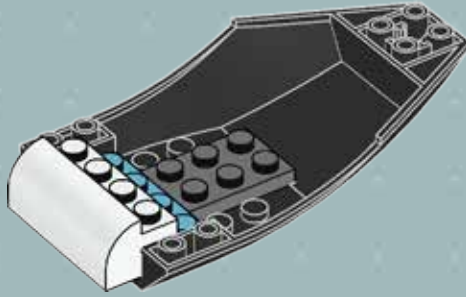

1x

4

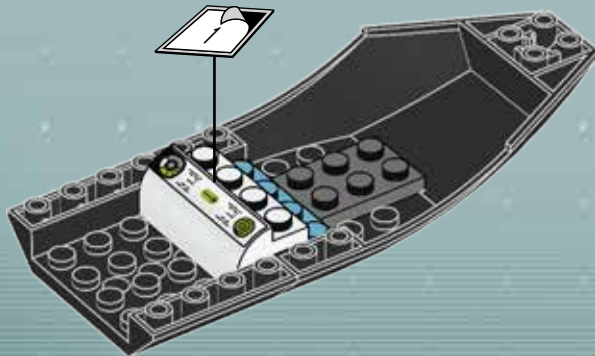

10 20 30 40



5

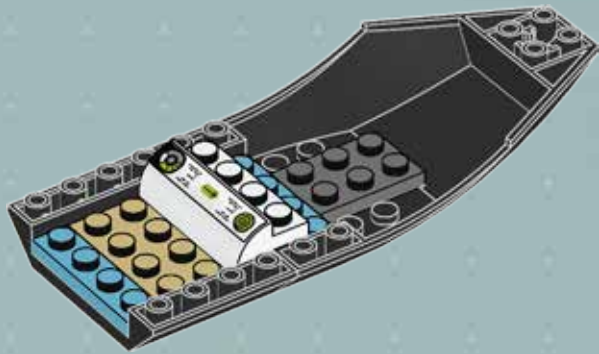

30 mm

20 mm

10 mm



6

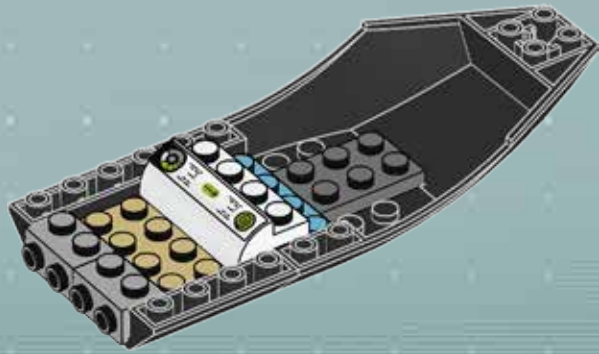

10 mm

20 mm

30 mm



3x

# 7

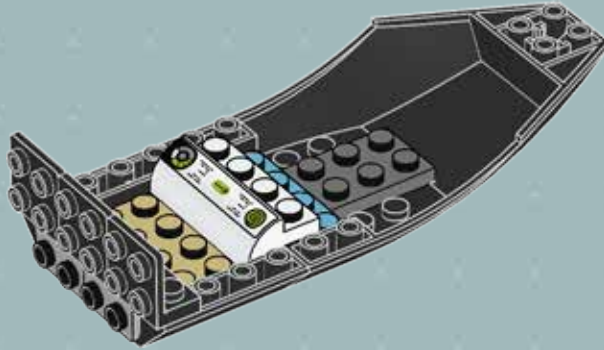

1x



2x

# 8







2x



2x



# 9



30 mm

20 mm

10 mm



2x



2x

# 10



10 mm

20 mm

30 mm



# 11

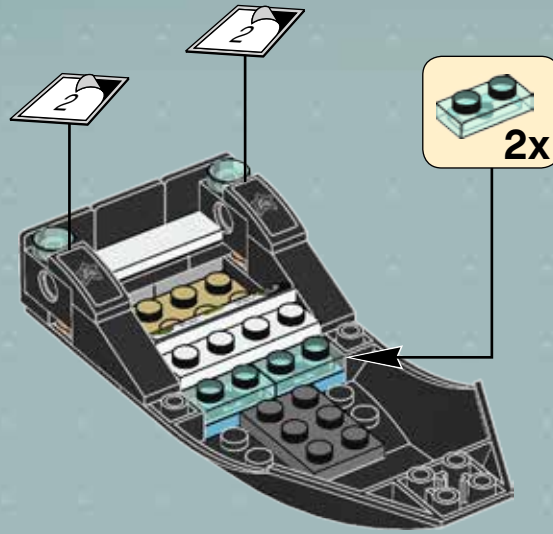

# 12

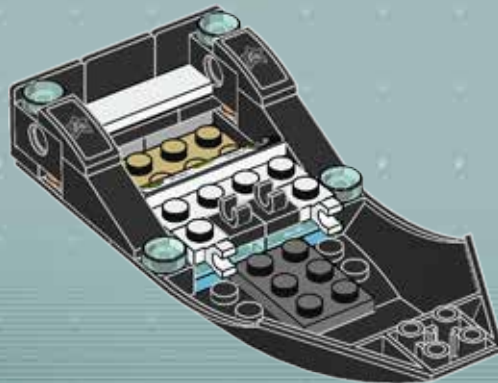



1x



2x



1x

10

20

30

40



# 13

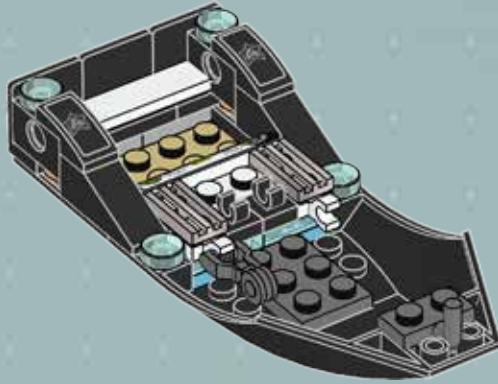

30 mm

20 mm

10 mm



5x

# 14

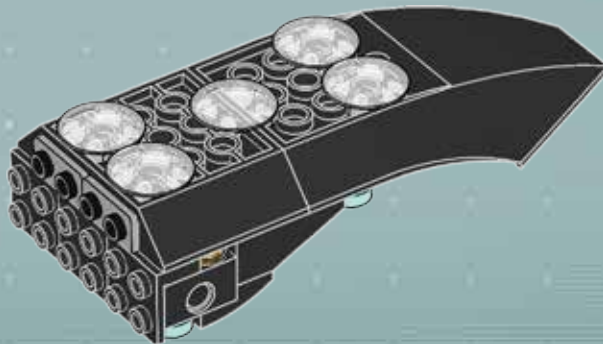

10 mm

20 mm

30 mm



# 15

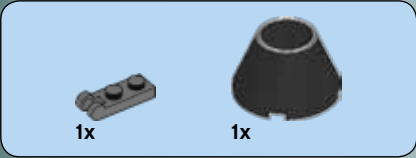
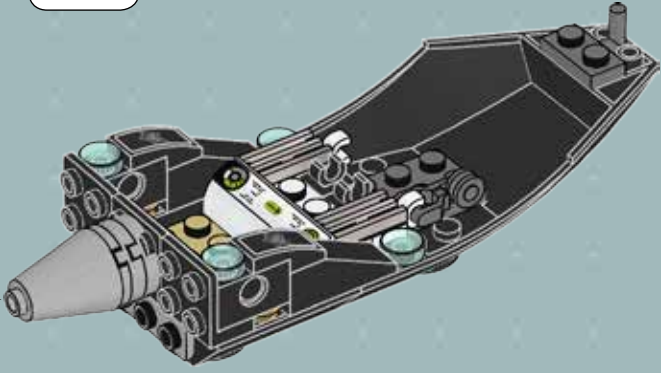
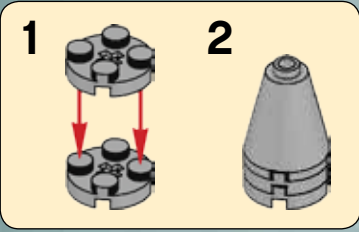

# 16

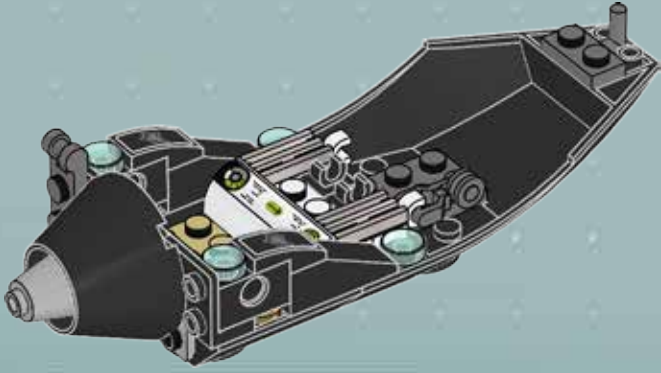

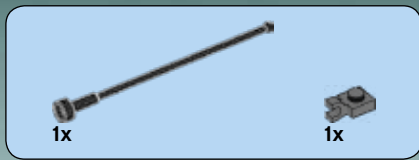

# 17



30 mm

20 mm

10 mm

10 mm

20 mm

30 mm

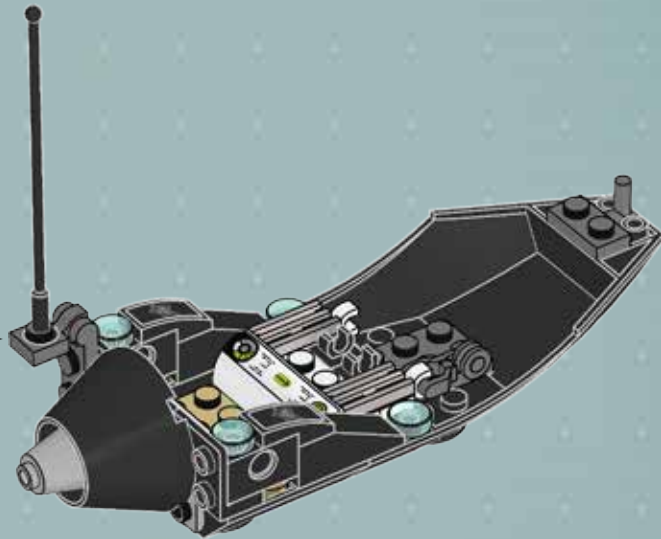
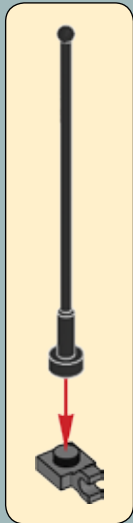

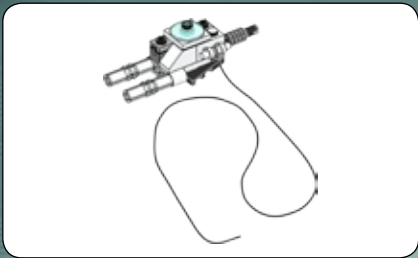

1

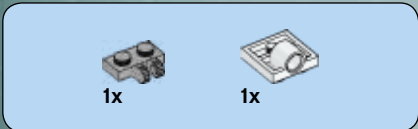
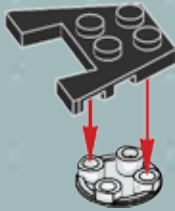

2

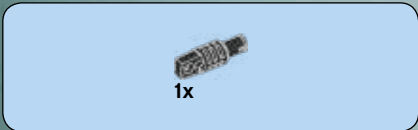

3





# 4

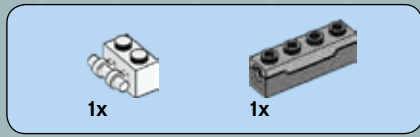
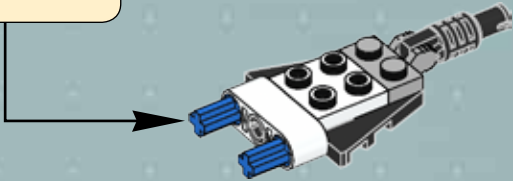
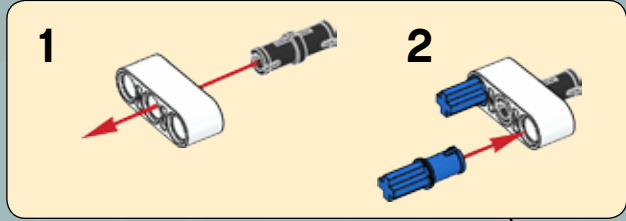

# 5

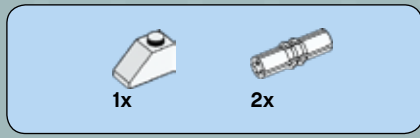
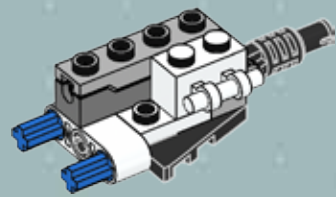

# 6

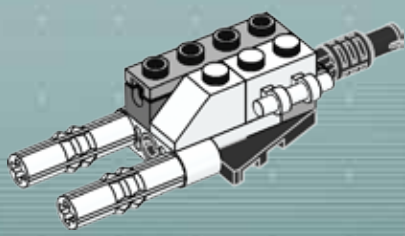



1x



1x

7

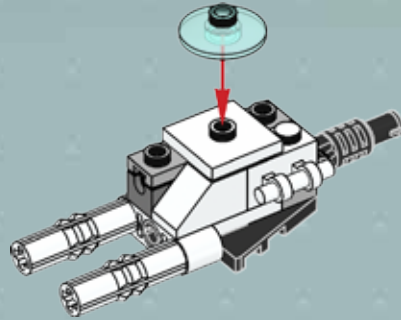

1x

8

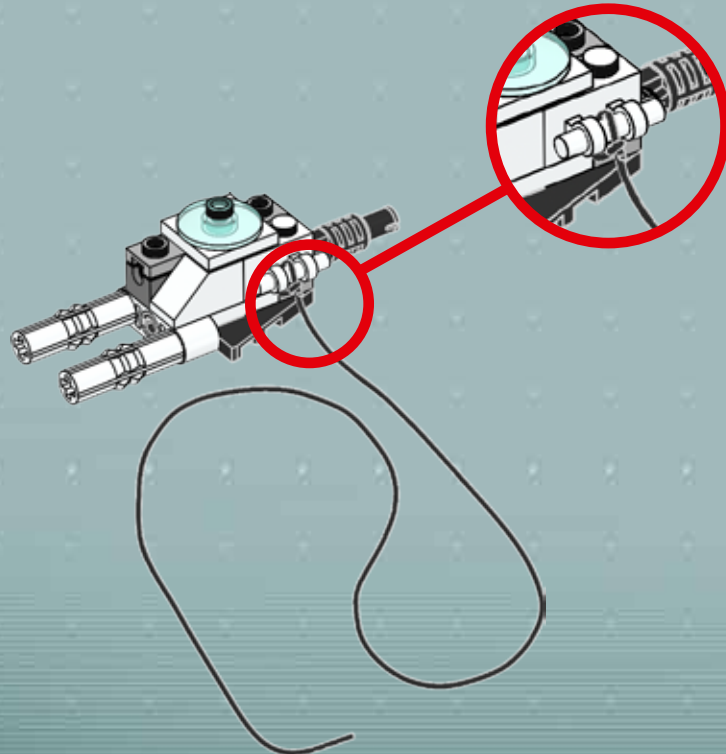



# 18

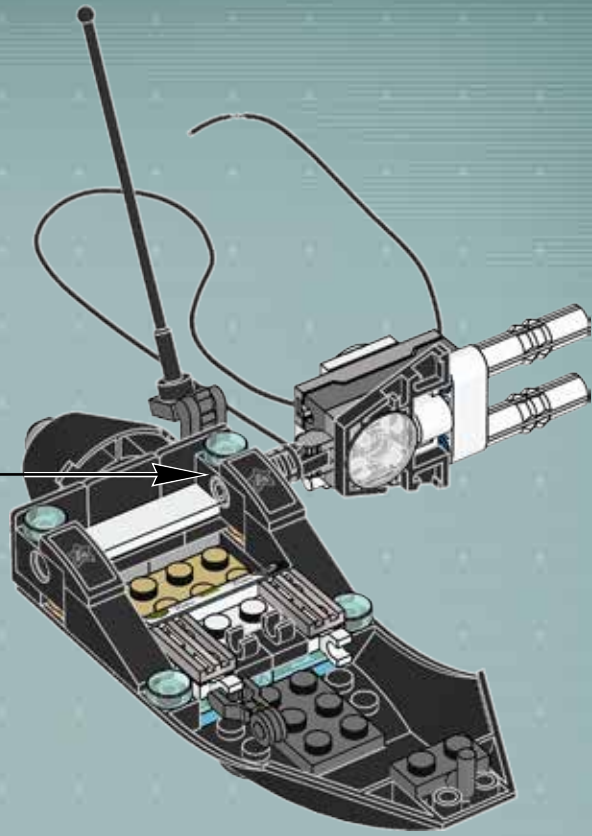

# 19

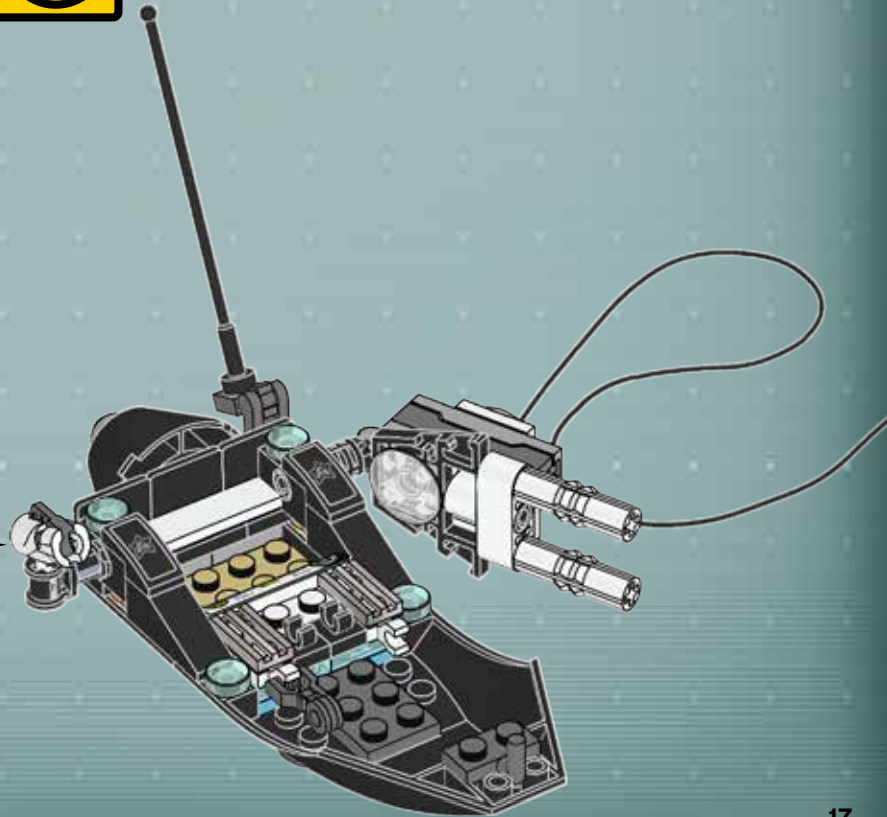
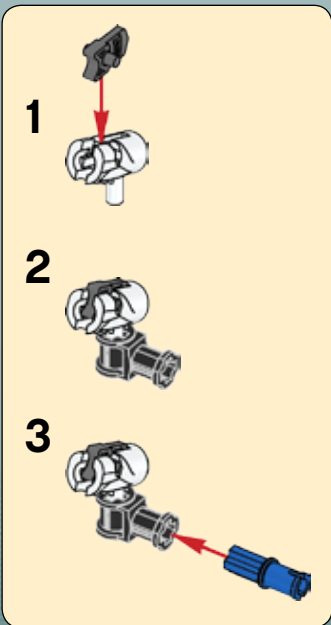



1x



1x



1x



1x

# 20

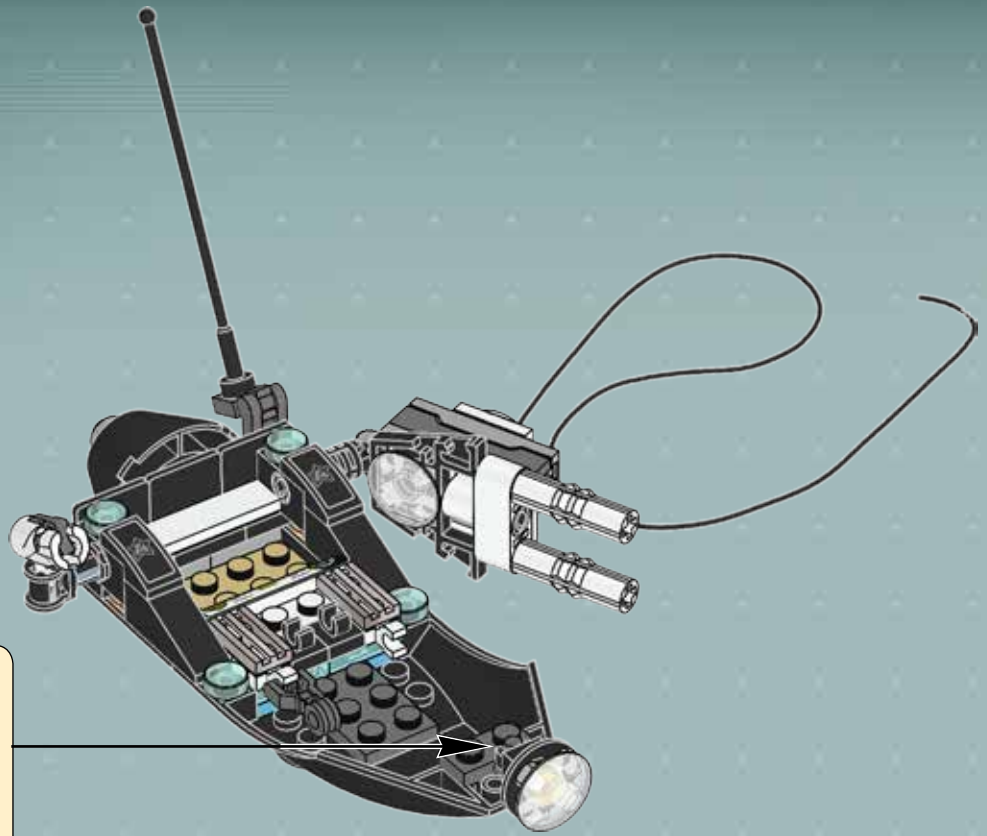

1



2

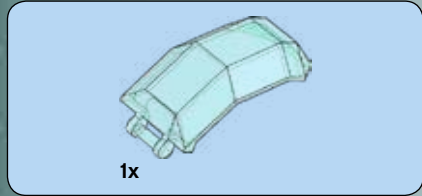

# 21

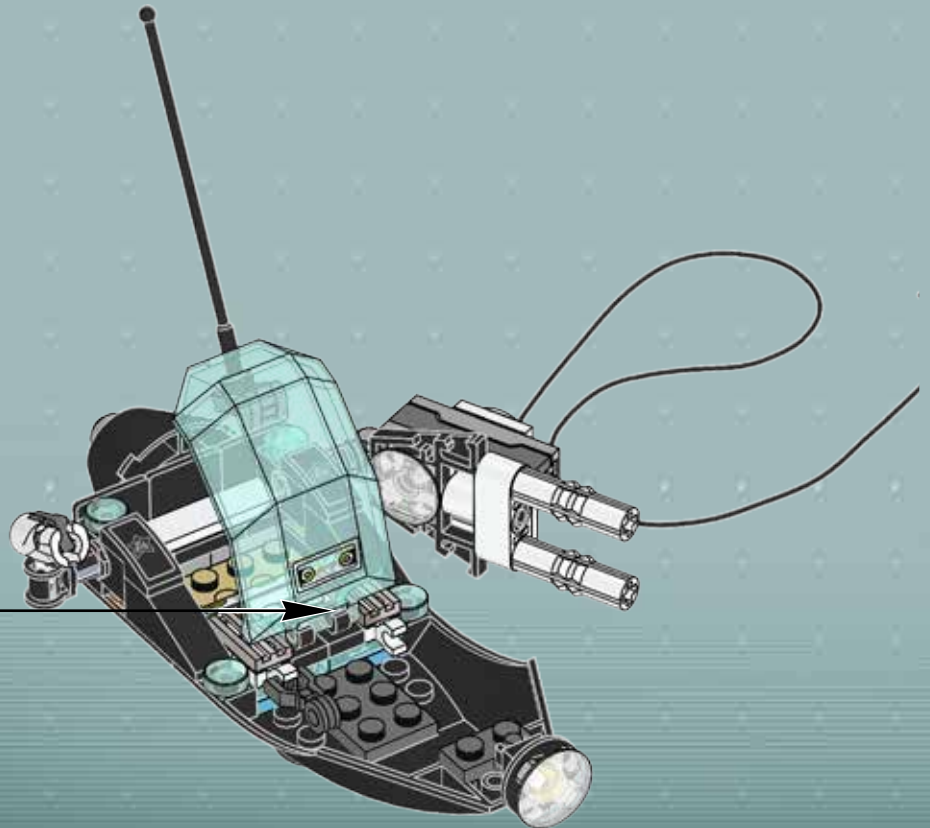

1

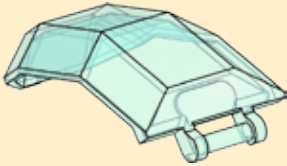

2

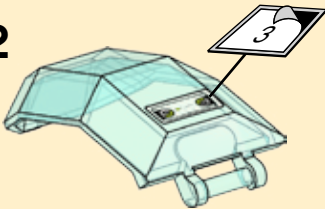



22

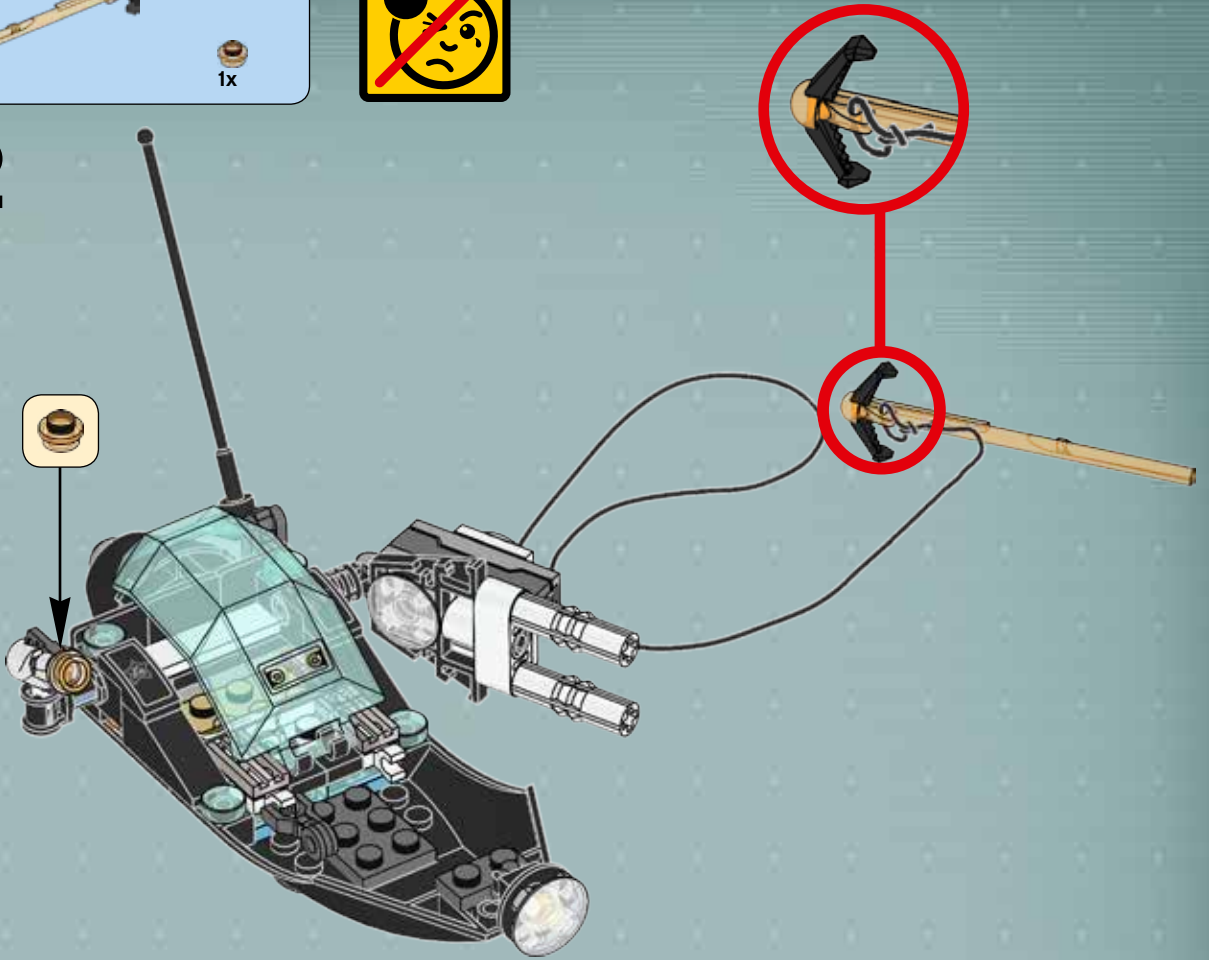

23

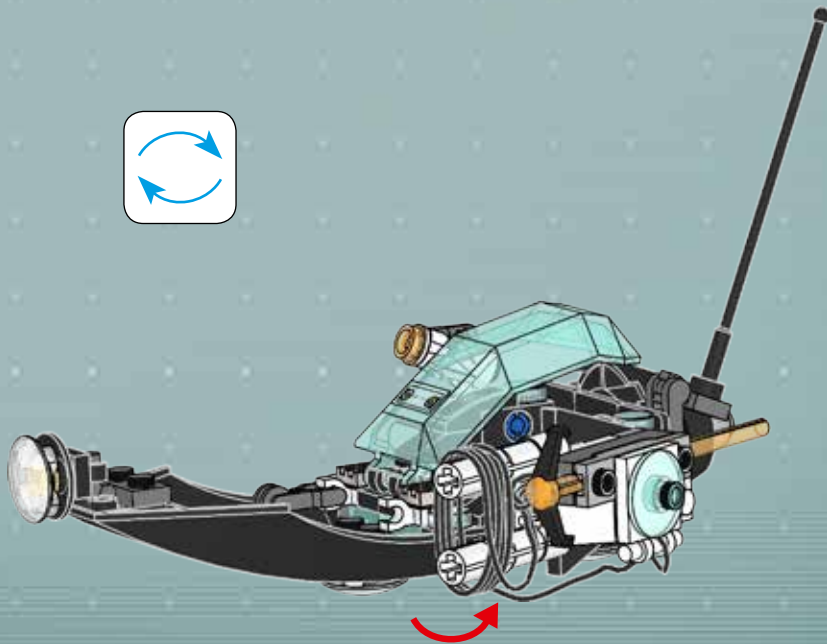

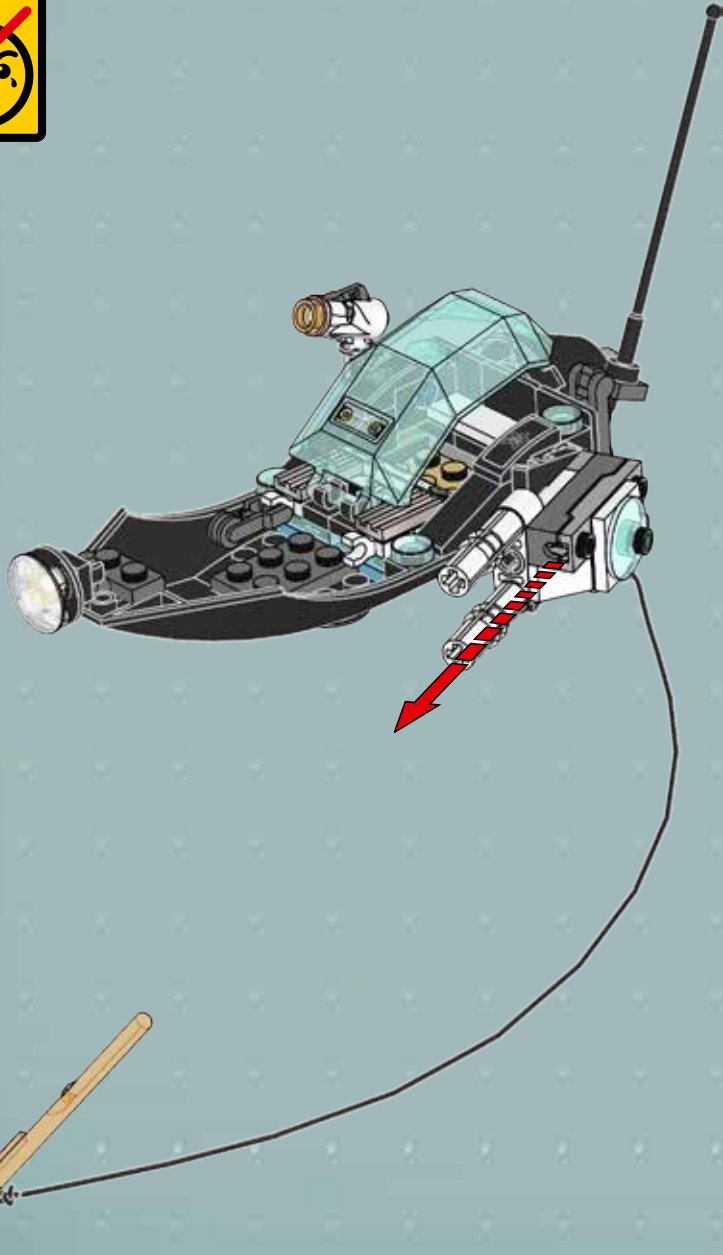

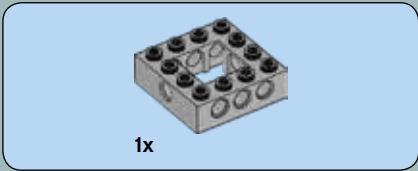
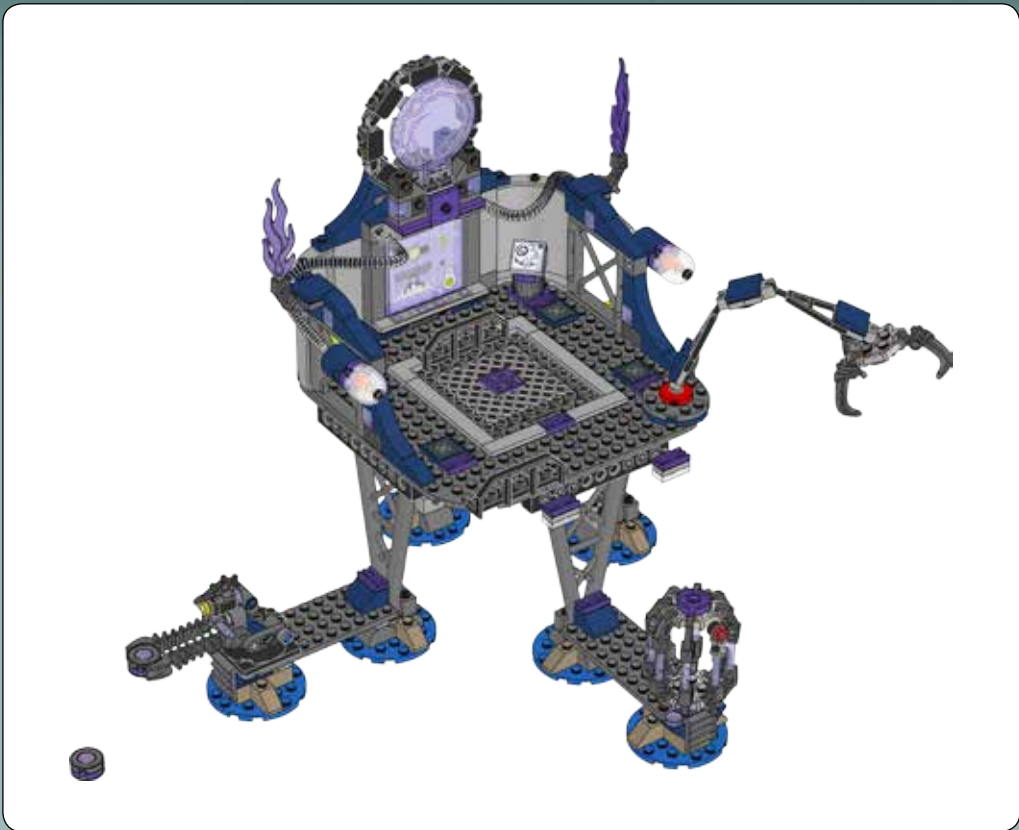

1

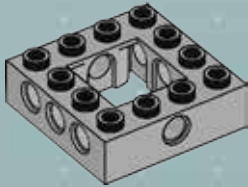



# 2

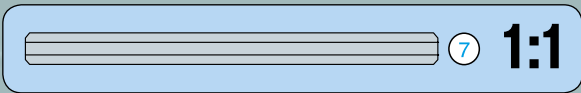
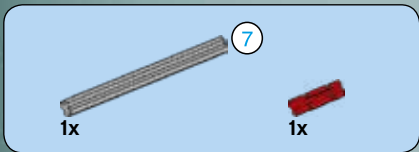
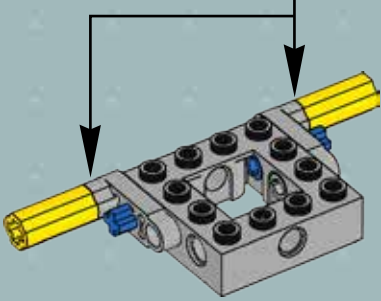
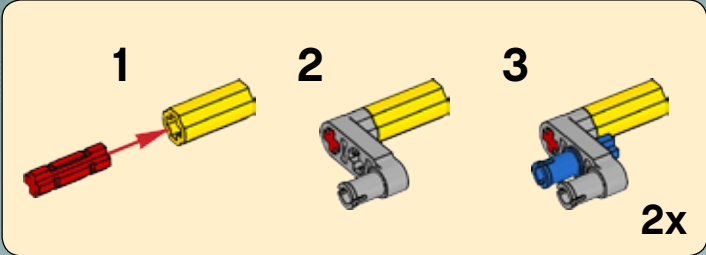

# 3

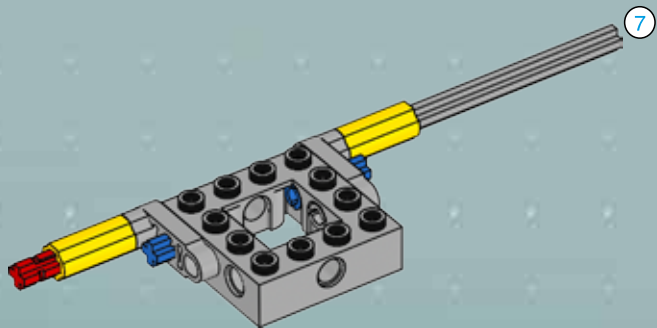



4

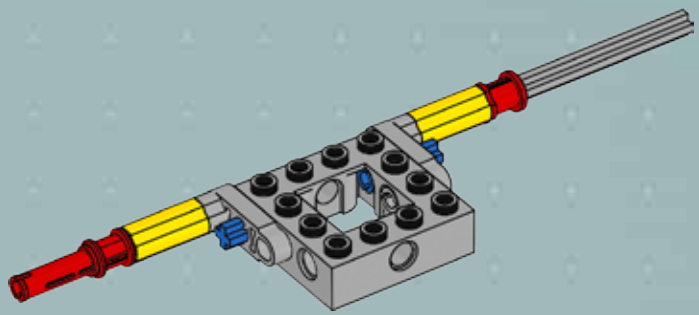

30 mm

20 mm

10 mm



5

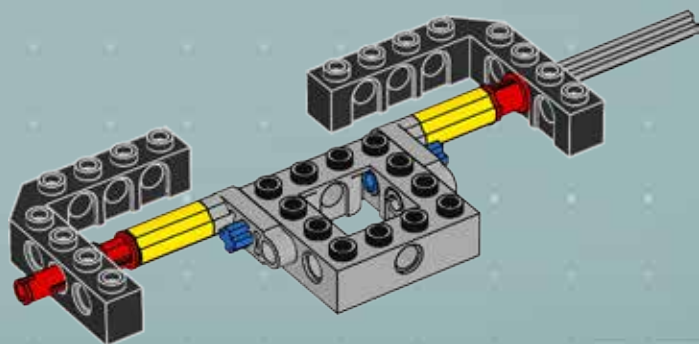

10 mm

20 mm

30 mm

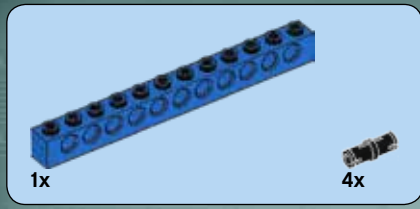

6

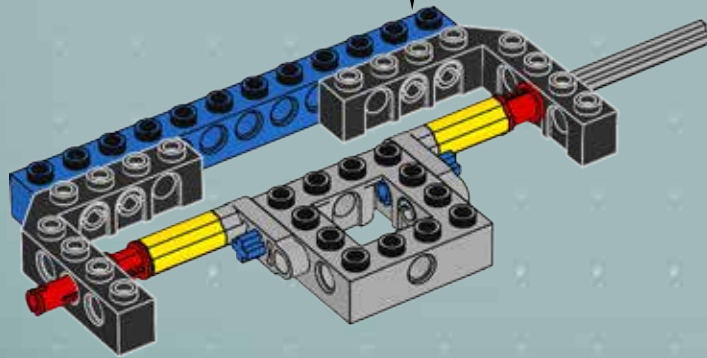
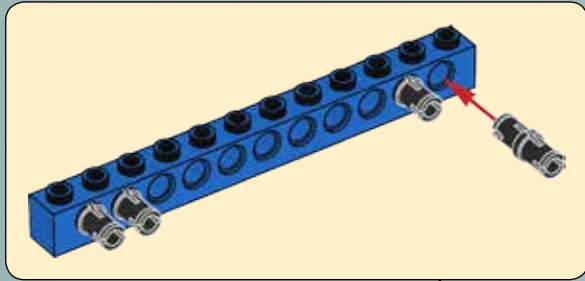



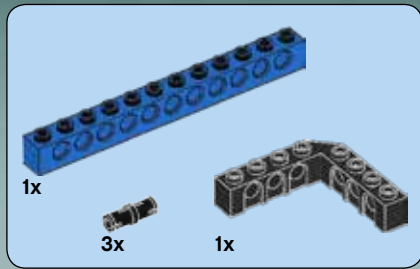

# 7

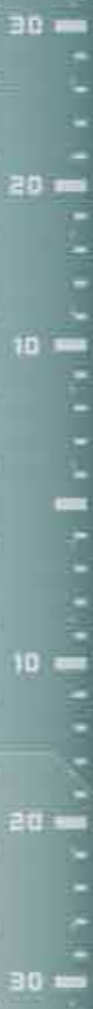
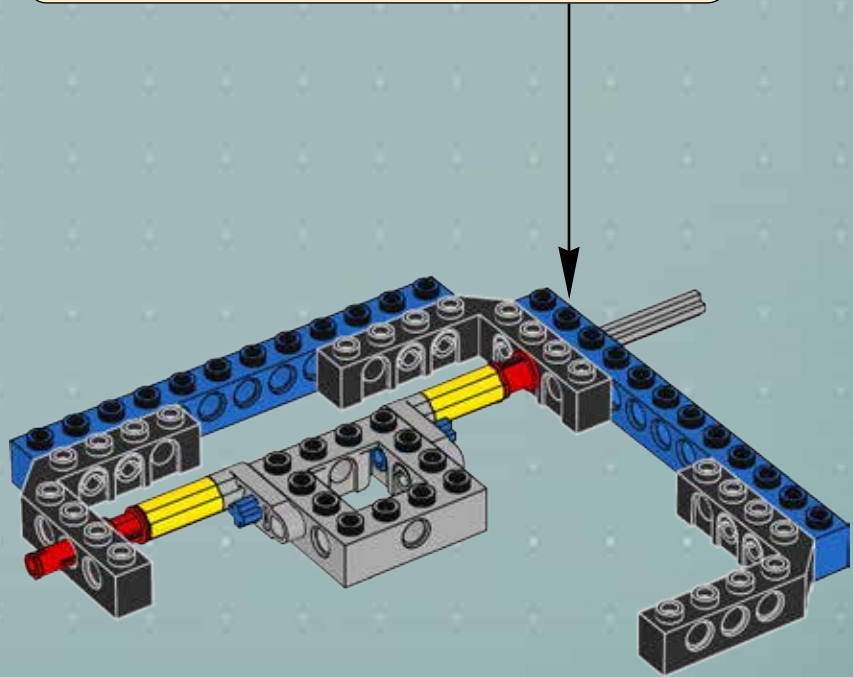
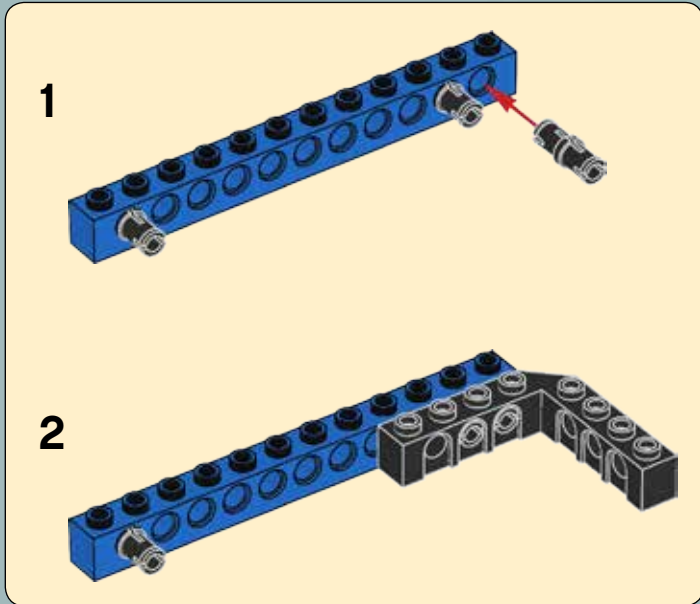

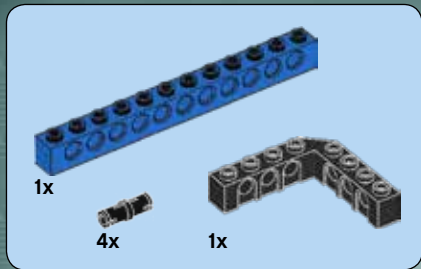

8

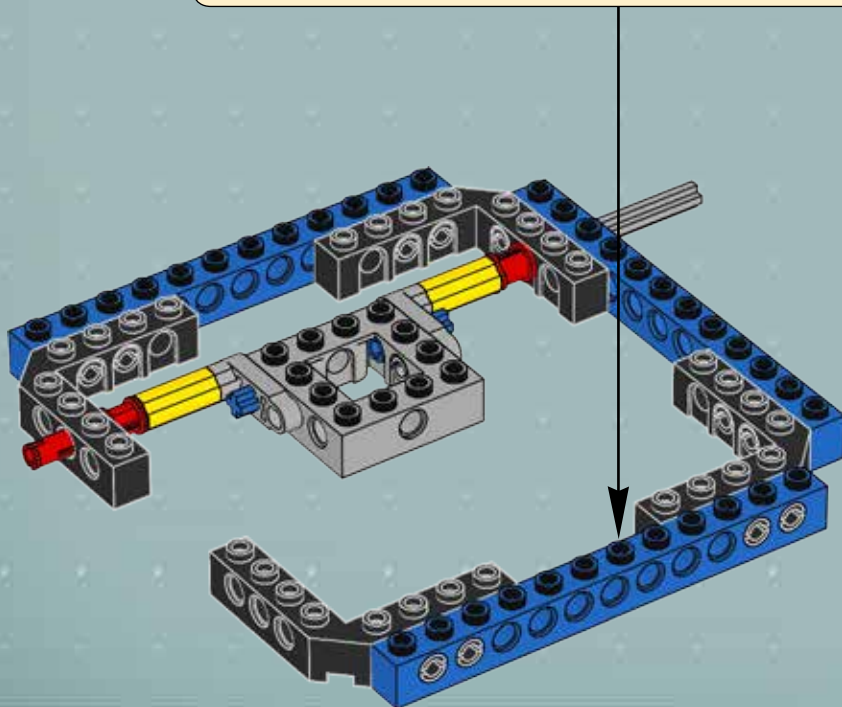
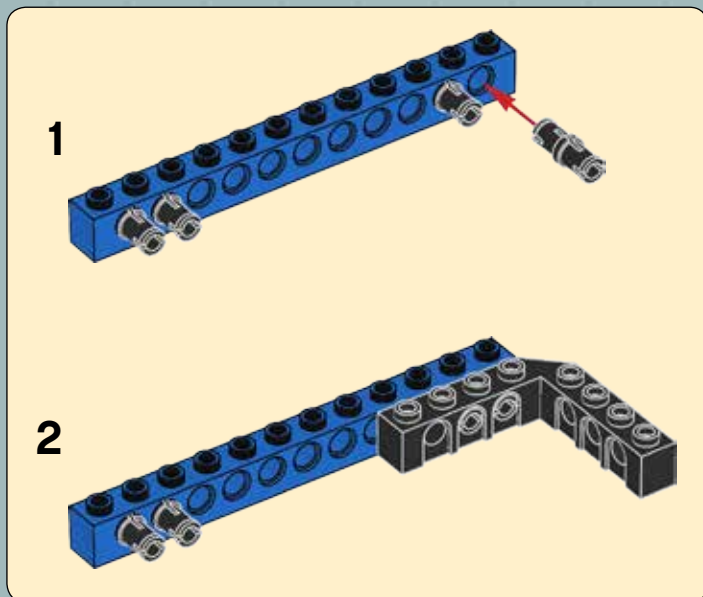

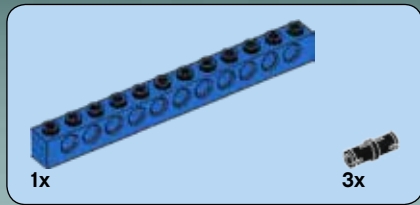

# 9

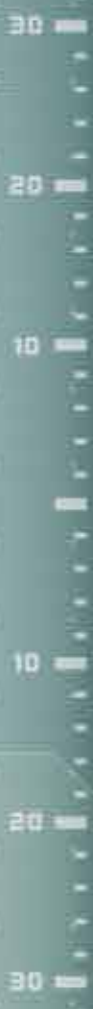
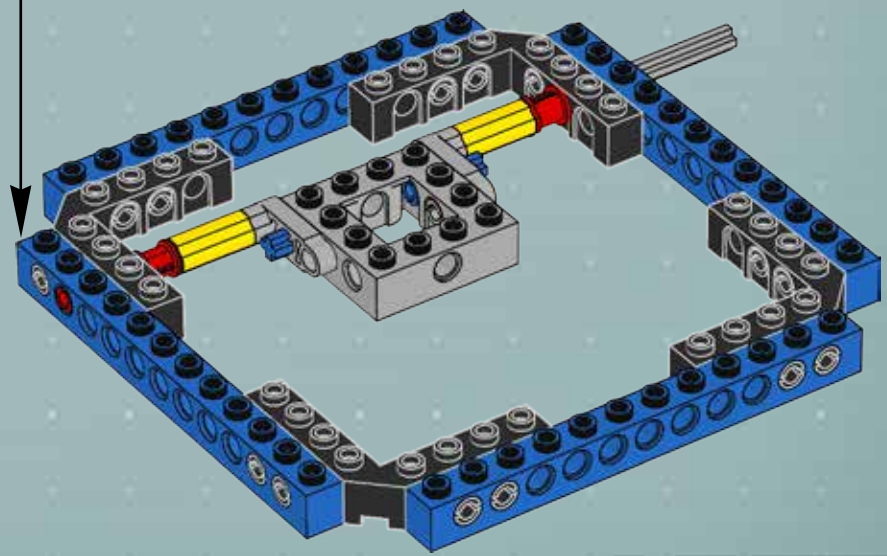
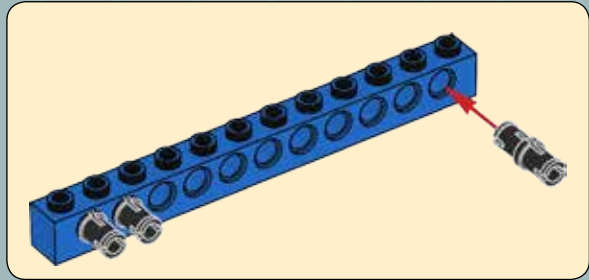

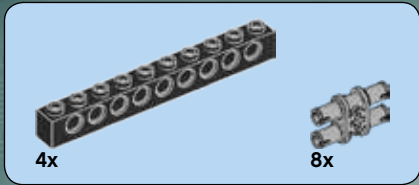

# 10

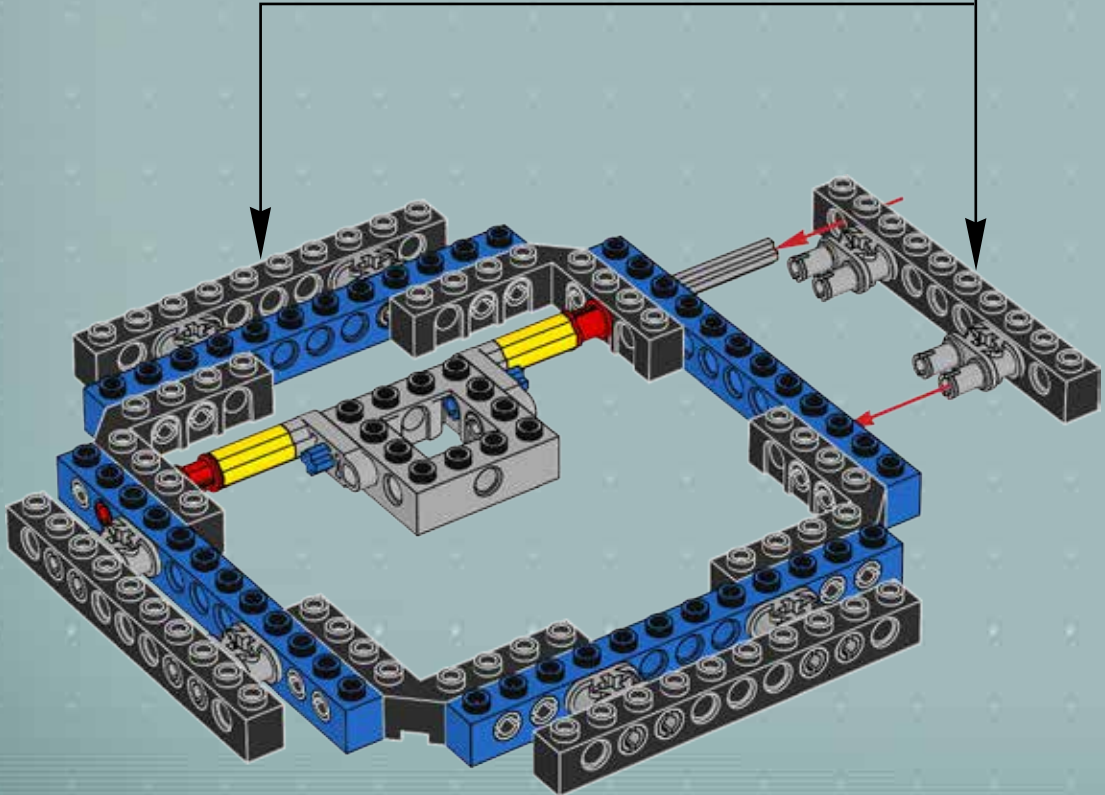
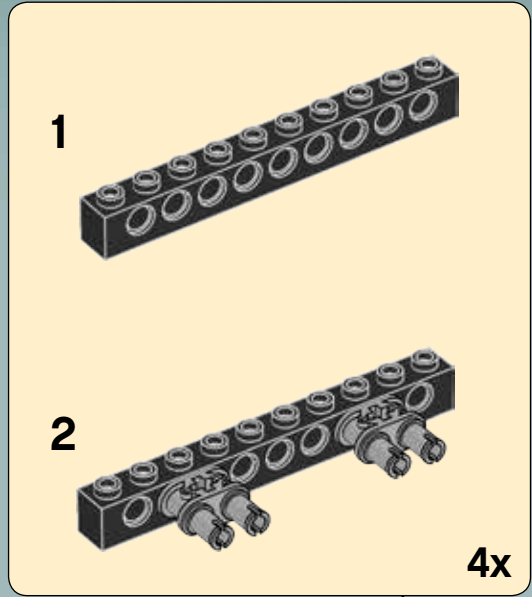



# 11

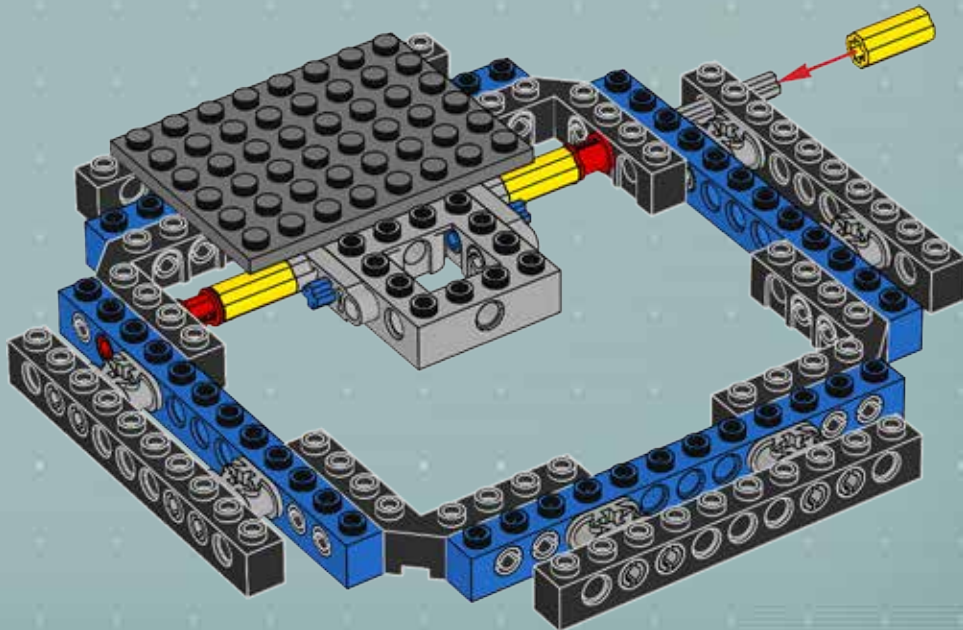

30 mm

20 mm

10 mm

10 mm

20 mm

30 mm

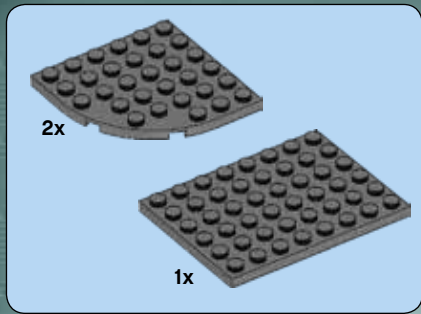

# 12

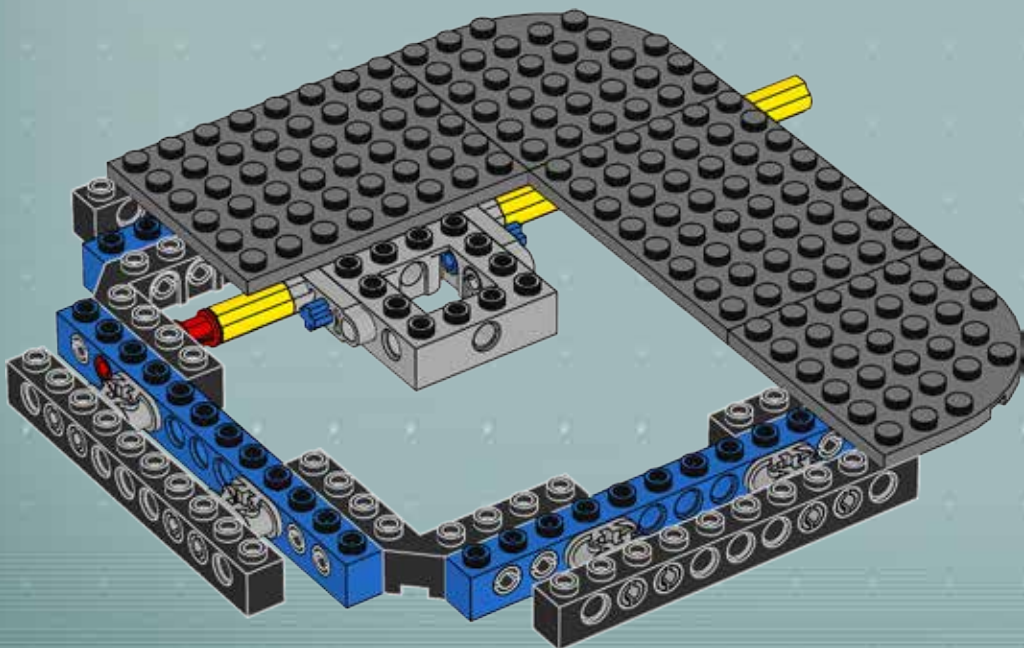

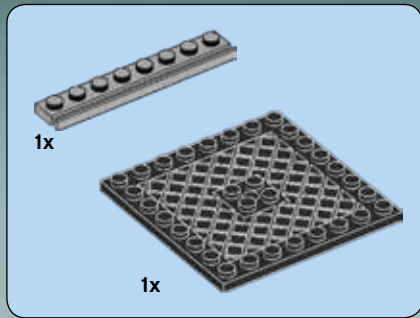

# 13

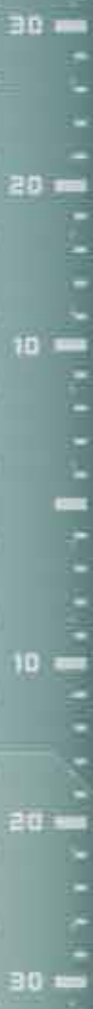
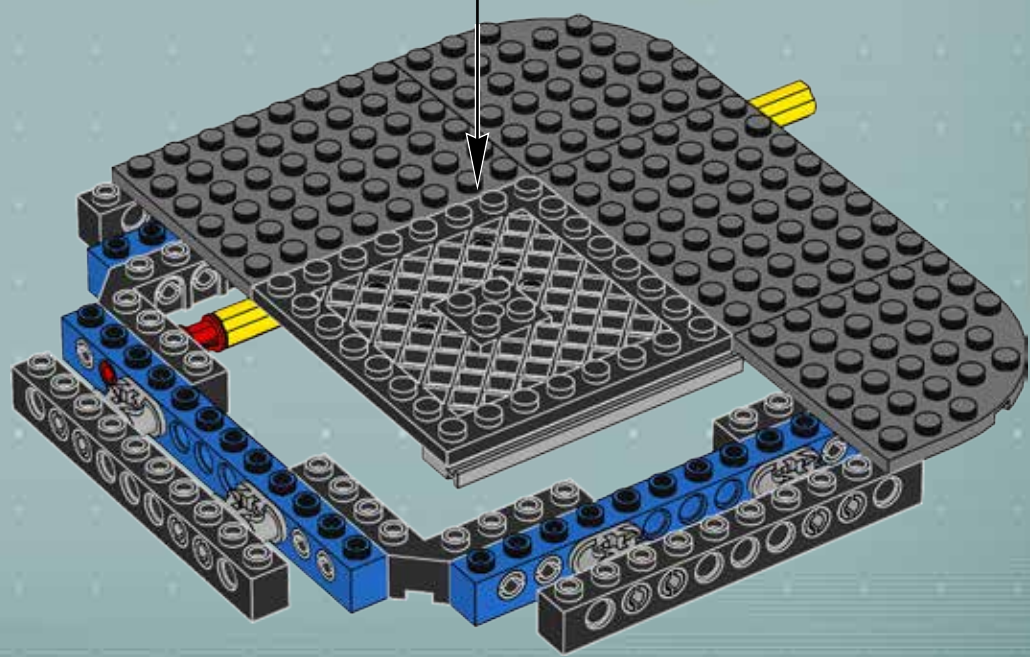
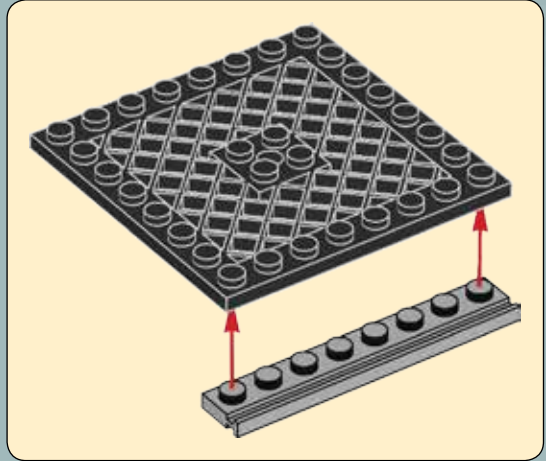



14

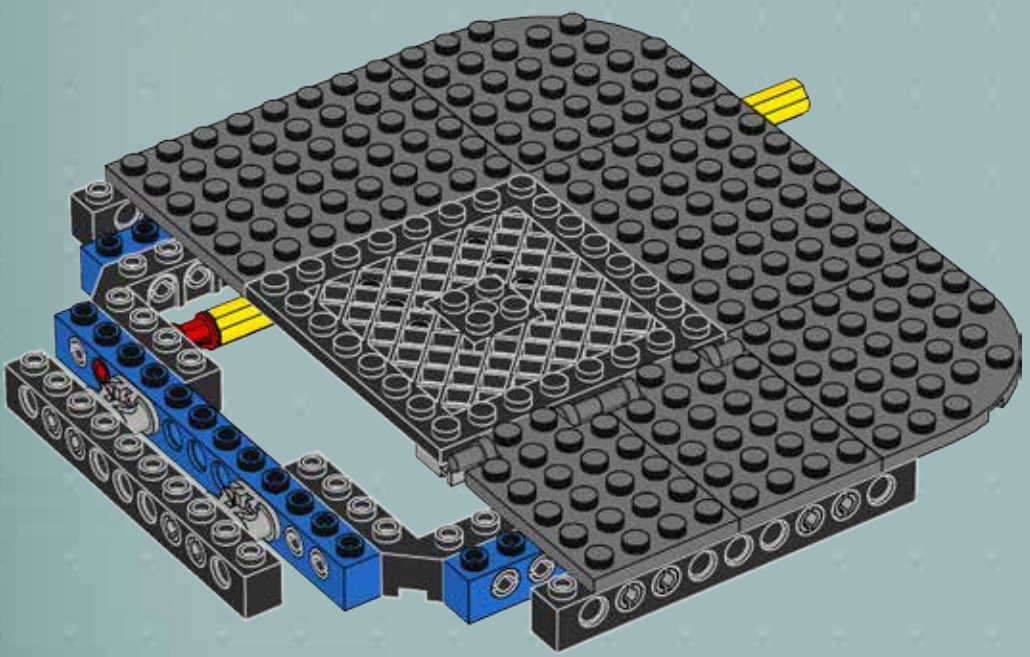



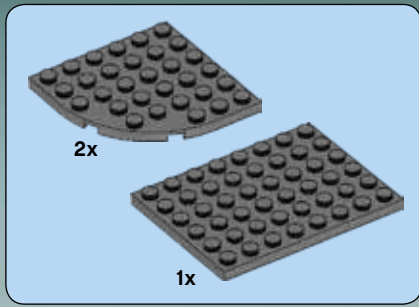

15

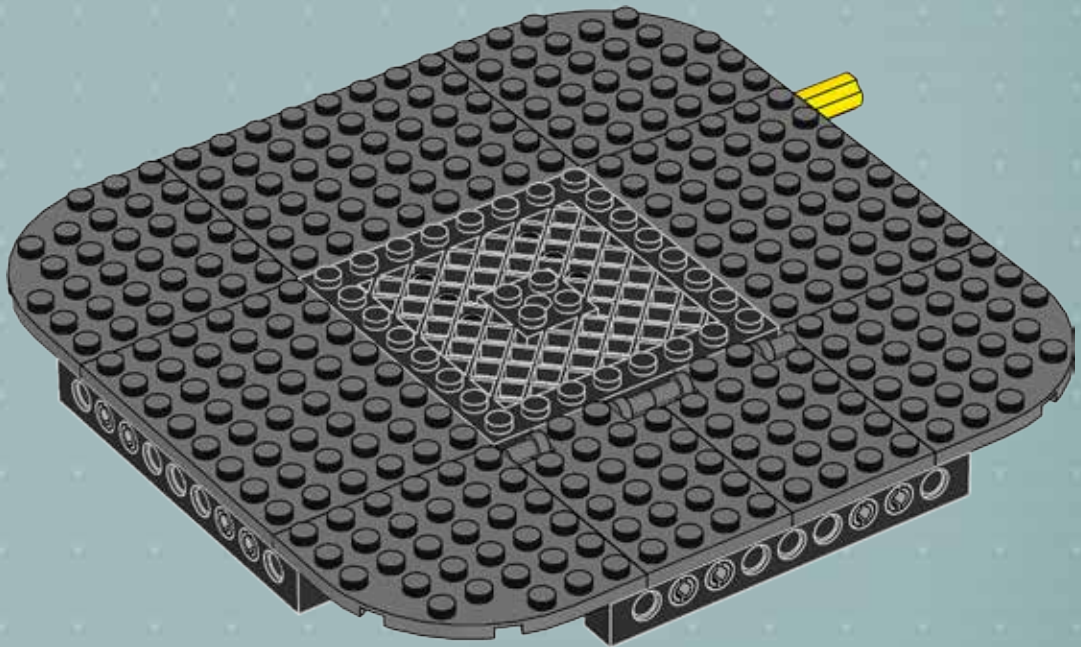



+

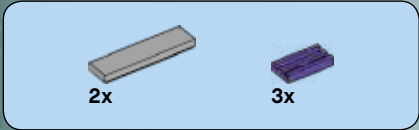
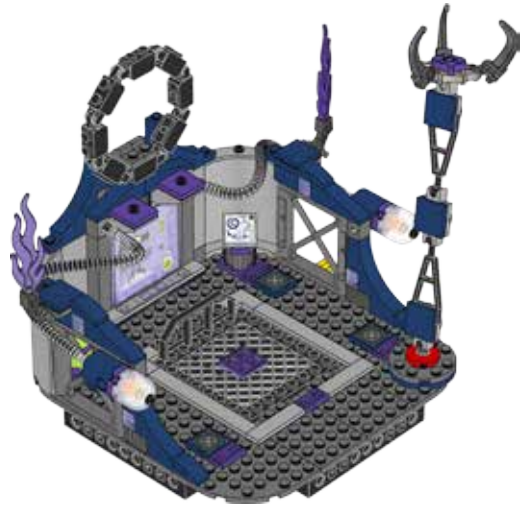

16

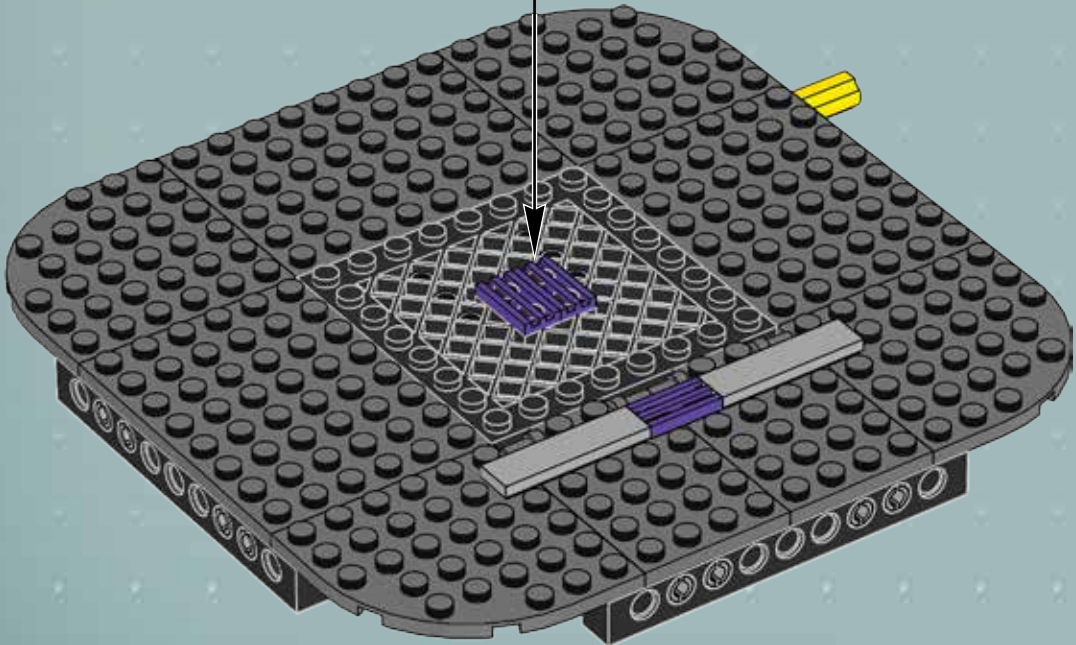

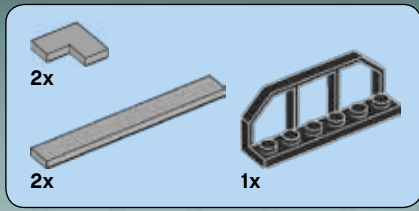

# 17

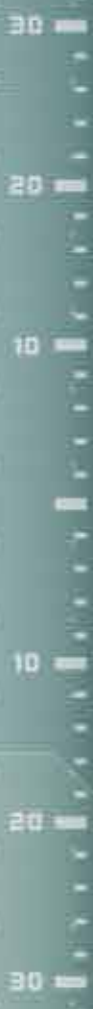
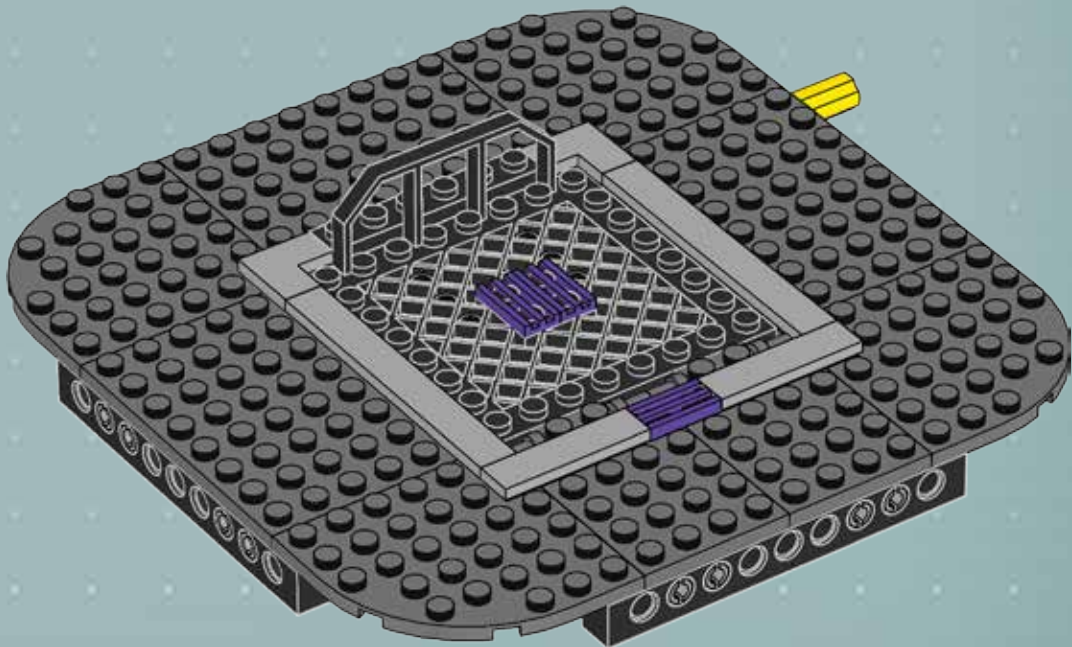



# 18

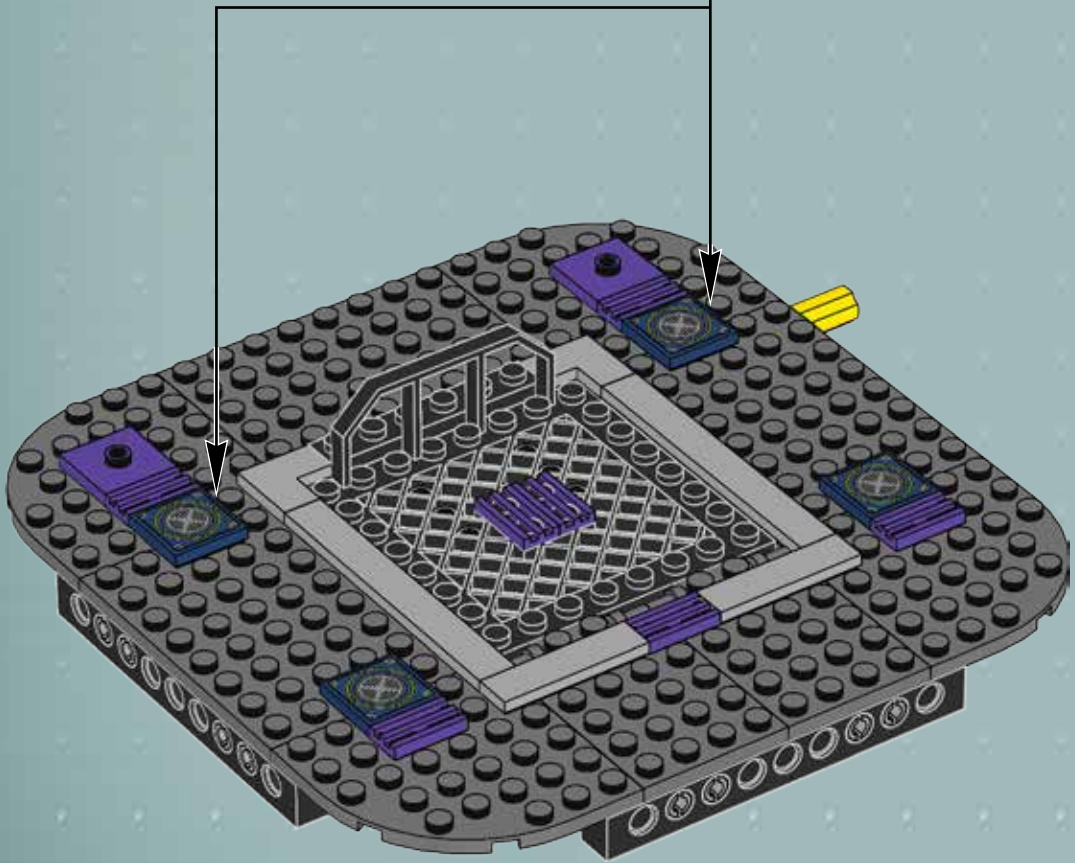
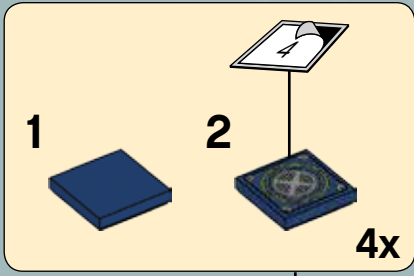

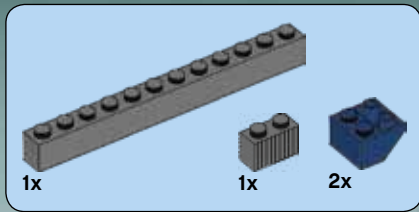

# 19



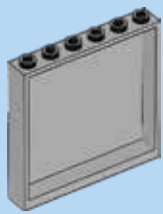

2x

20

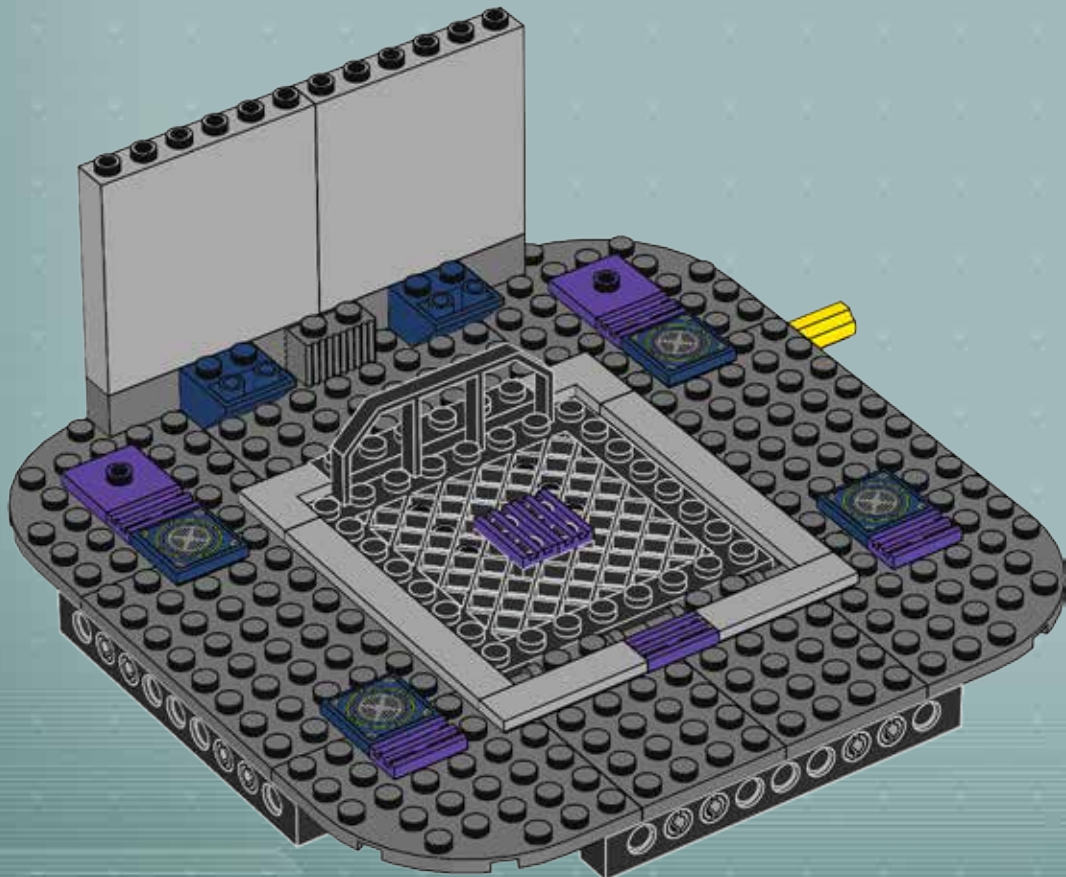

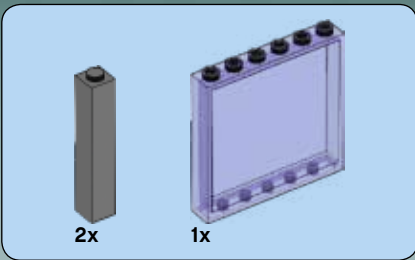

# 21

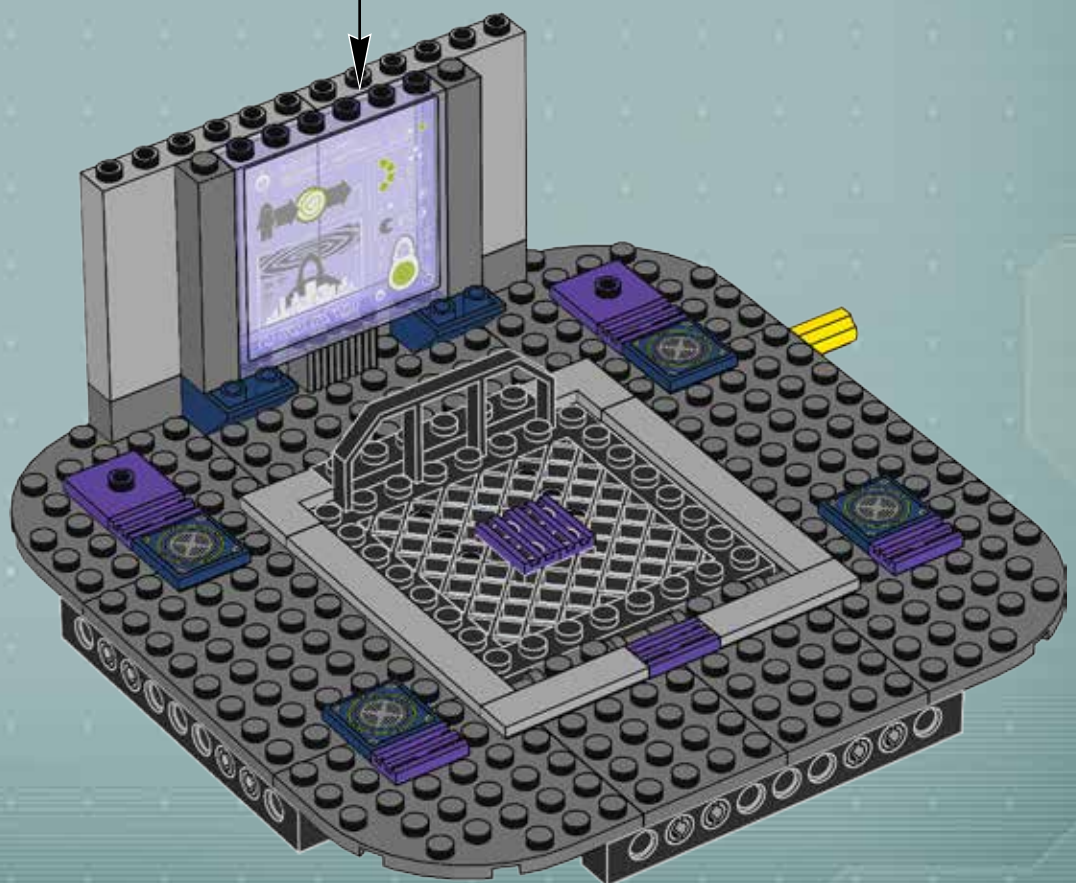
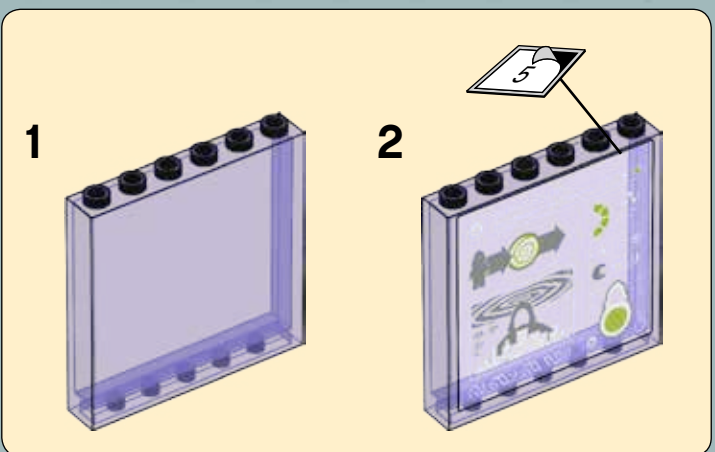



2x



1x

# 22

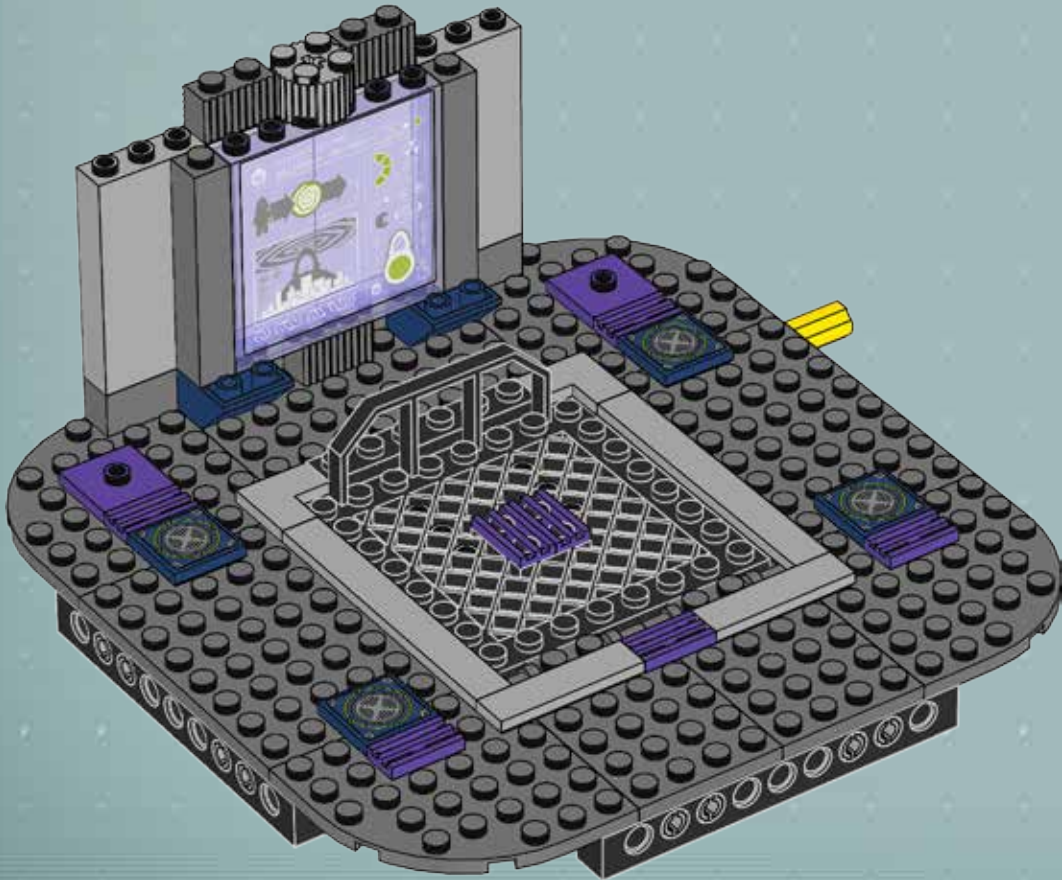





# 23

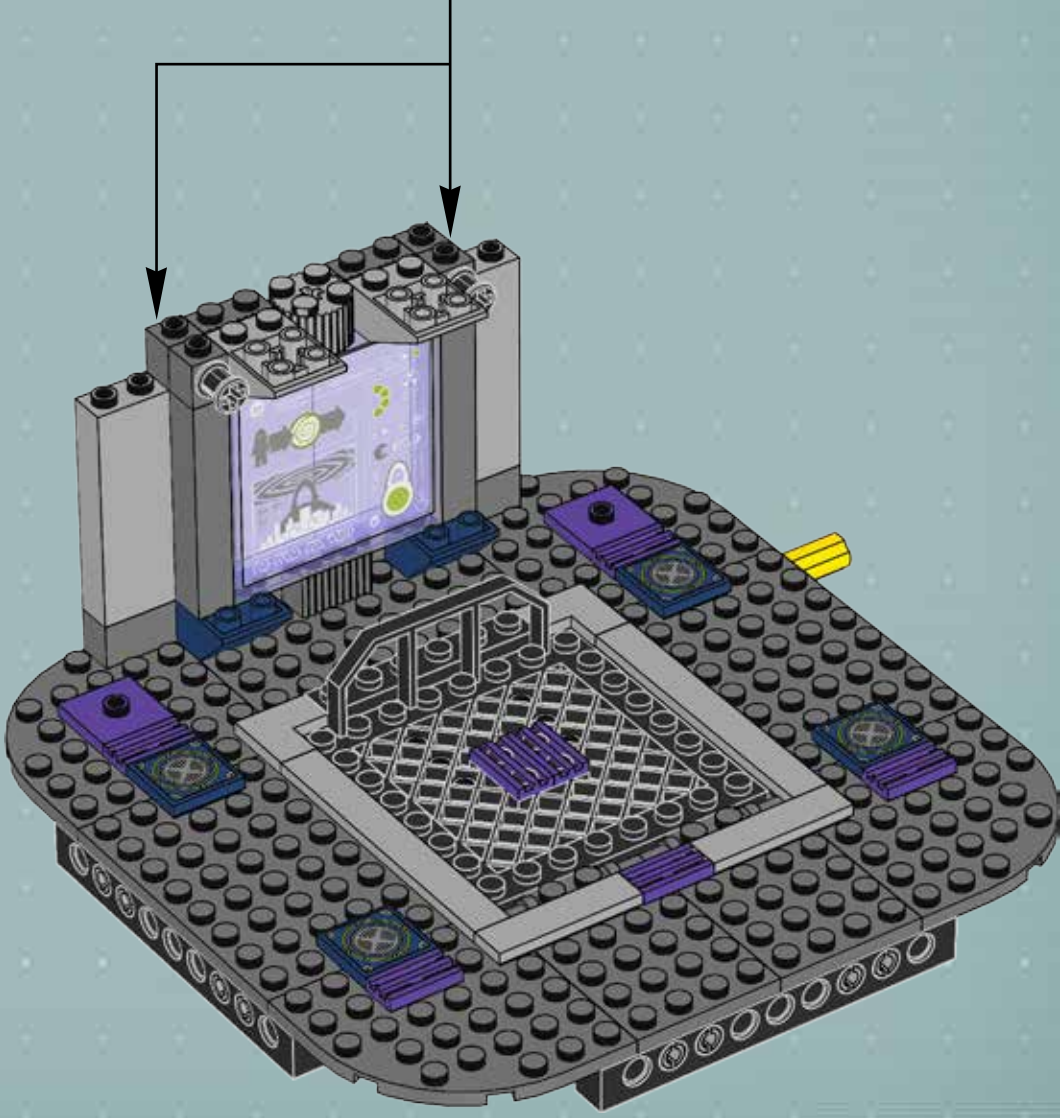
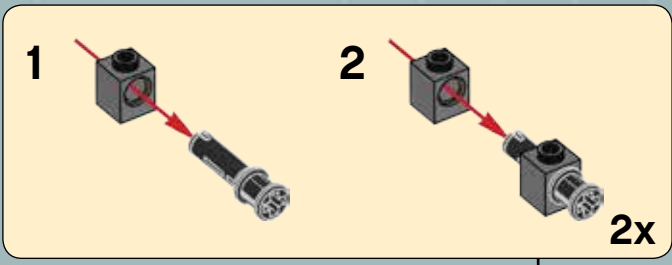

30

20

10

10

20

30

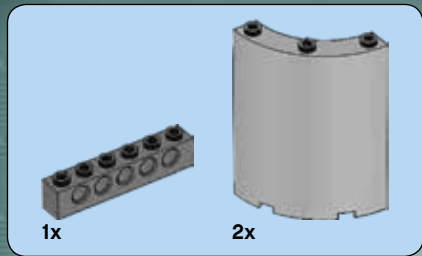

# 24

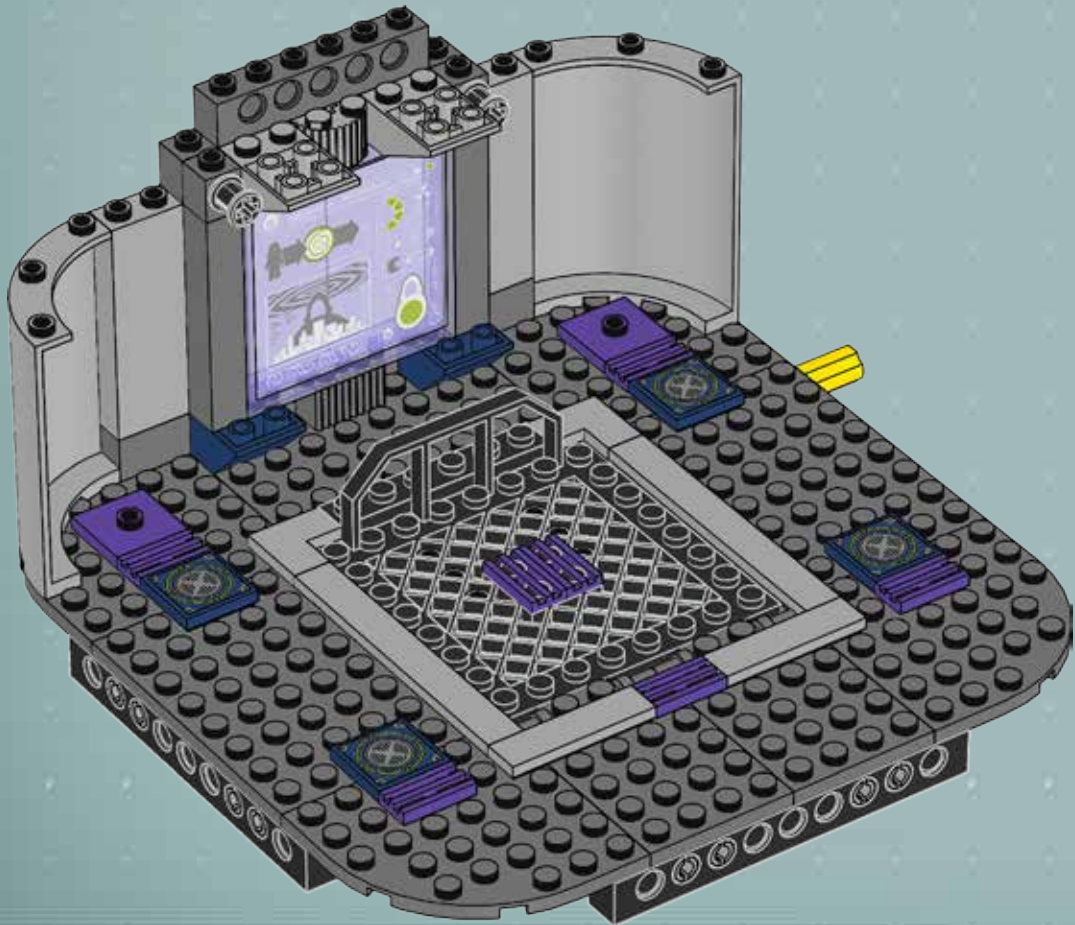

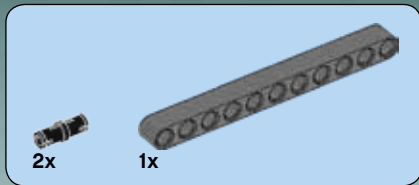

# 25

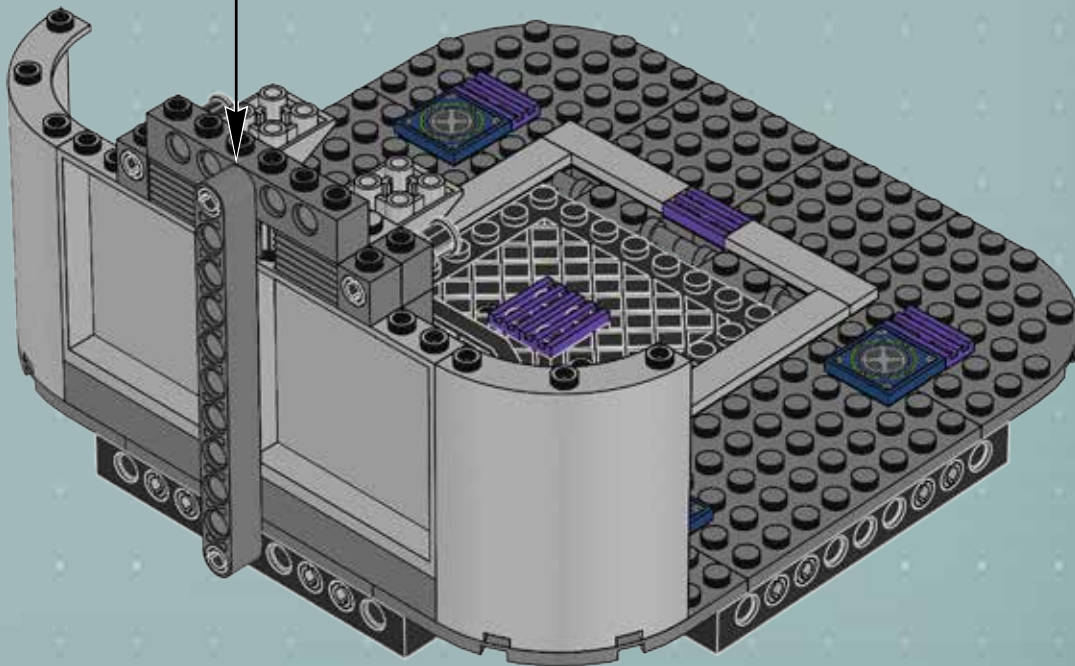
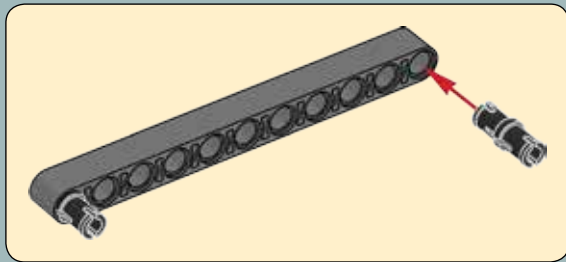

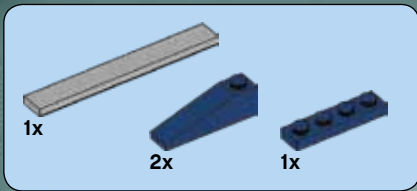

# 26

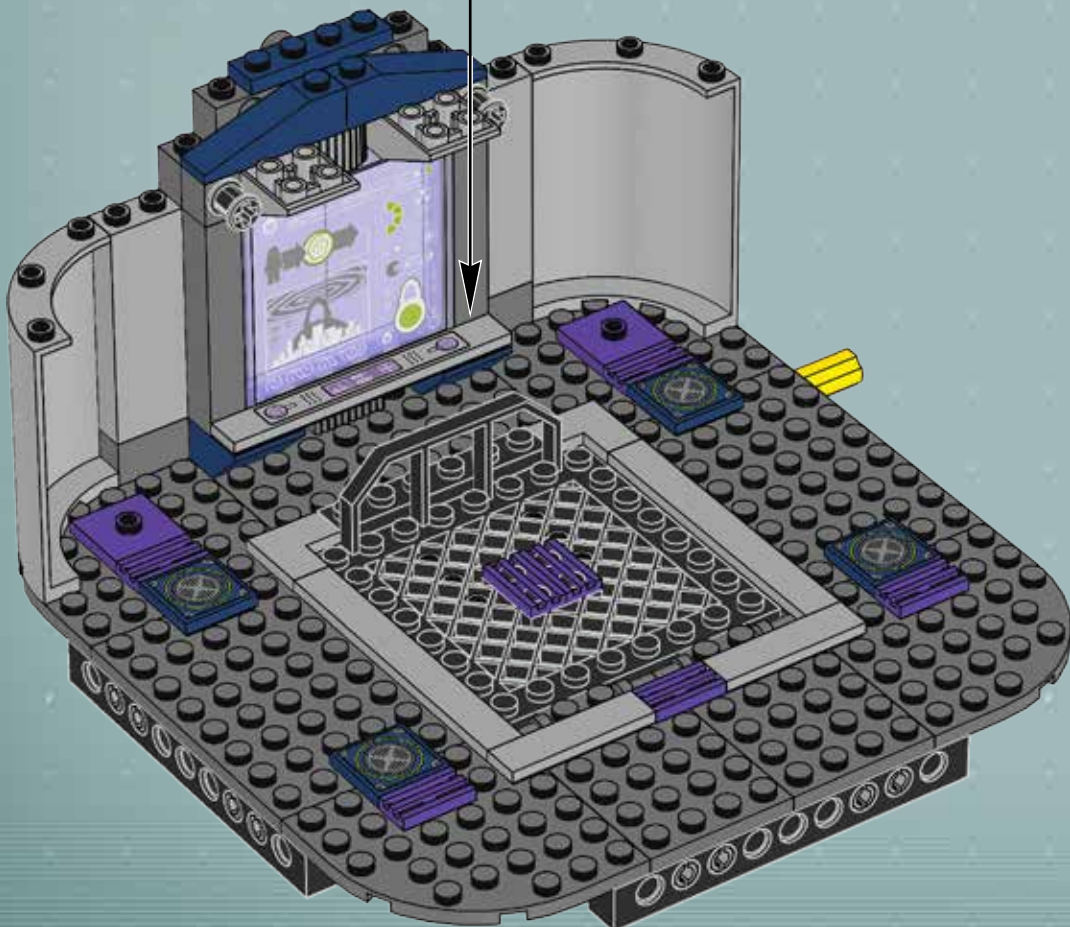
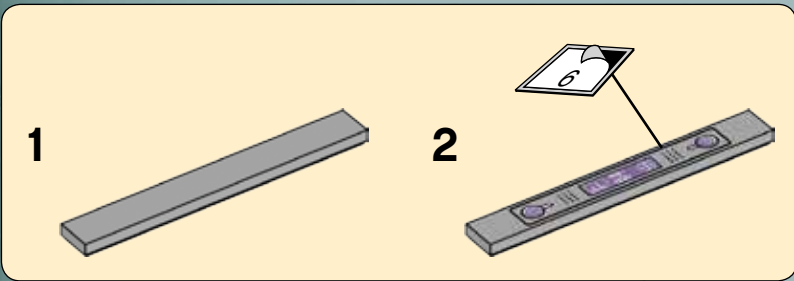

1x  2x 



# 27

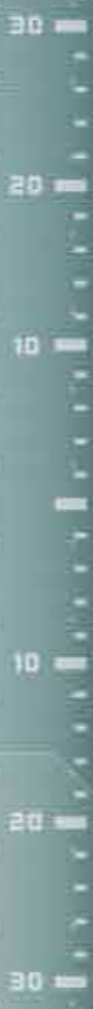
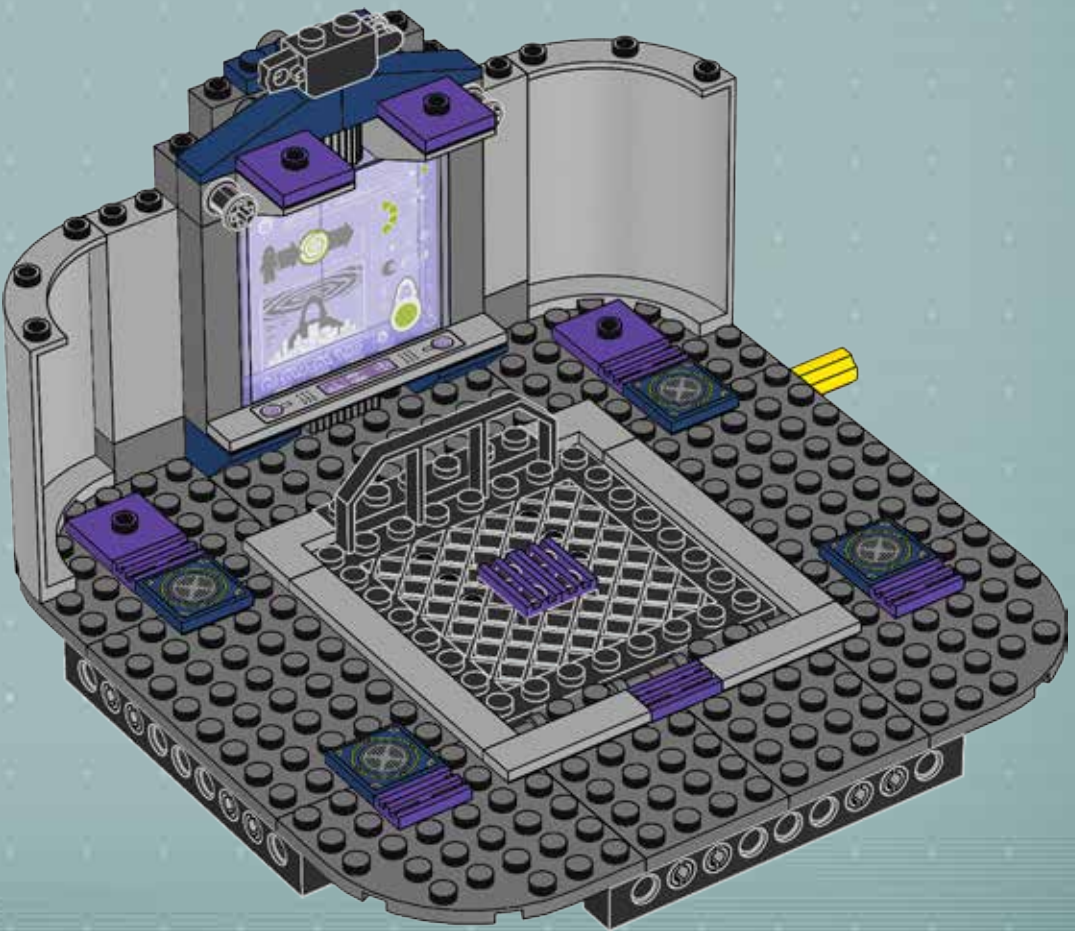



2x

# 28

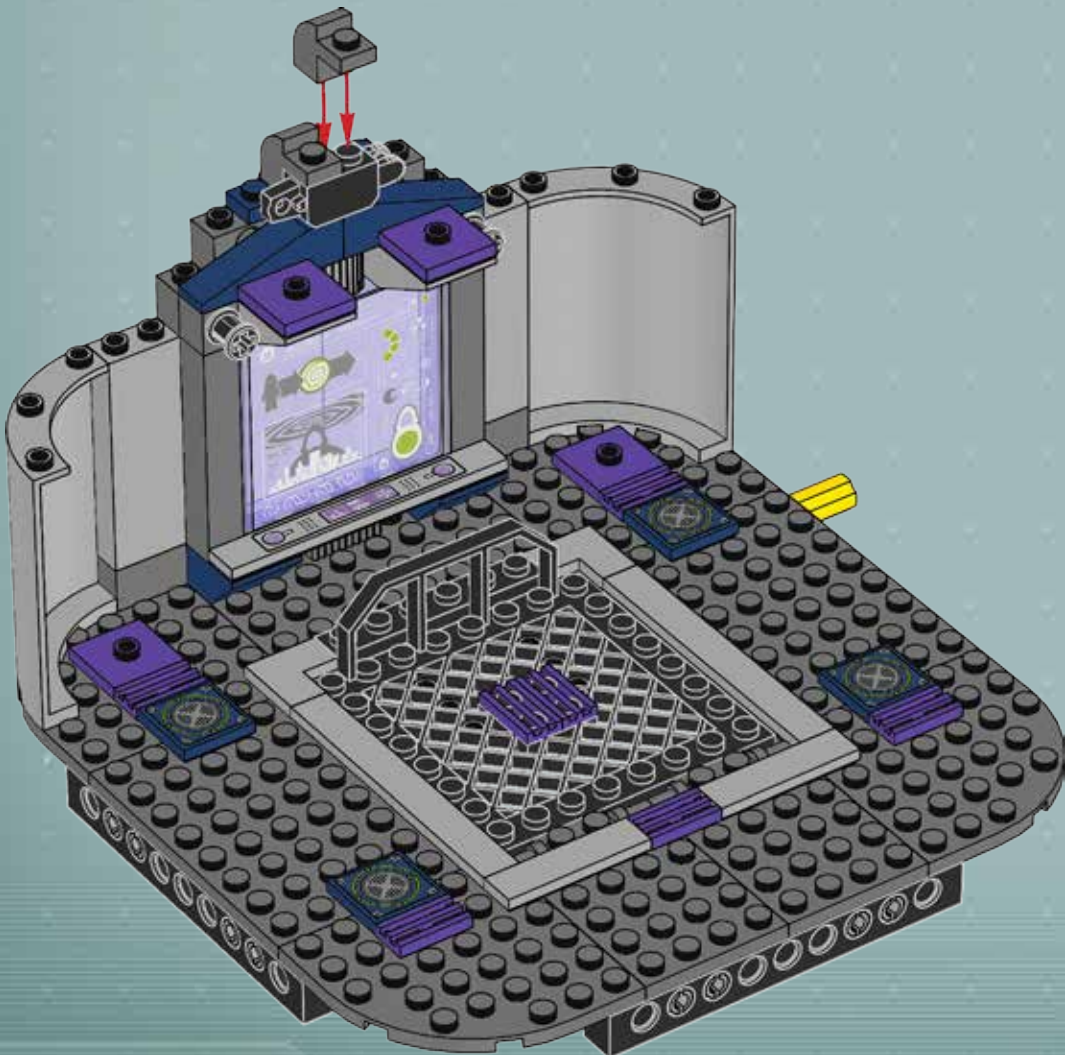

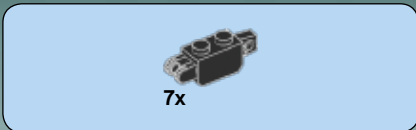

# 29

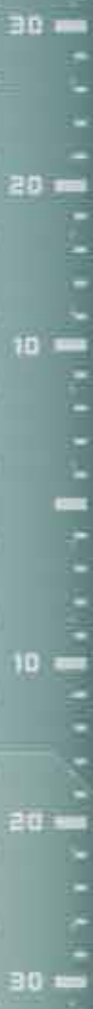
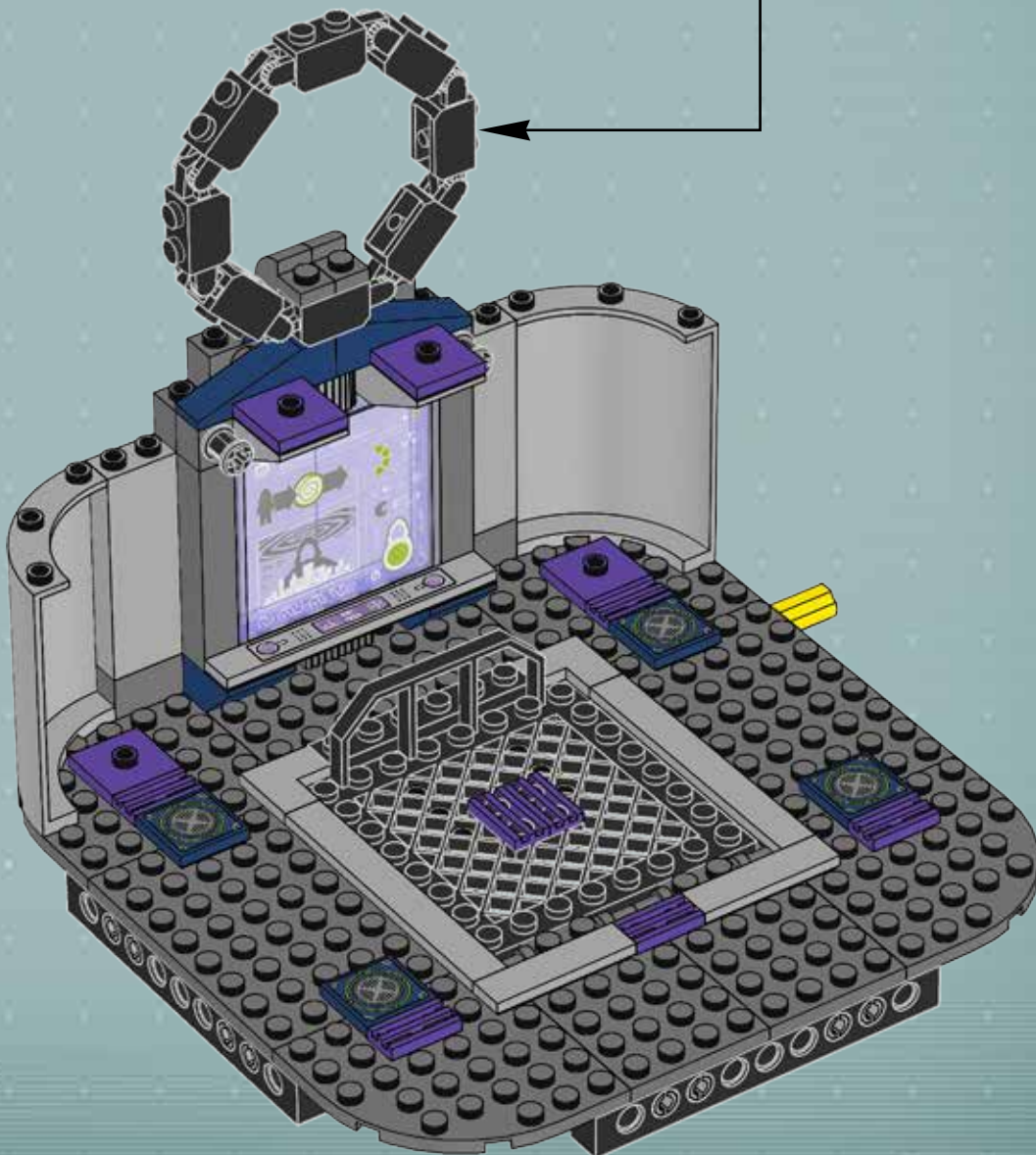
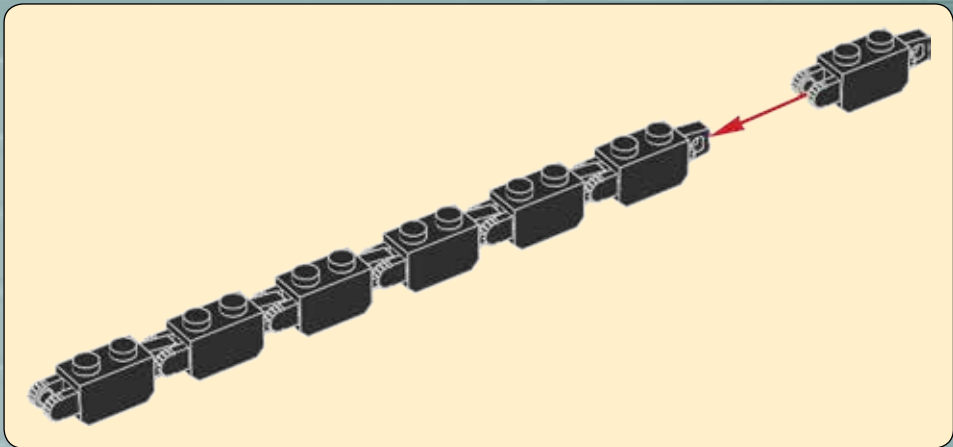



30

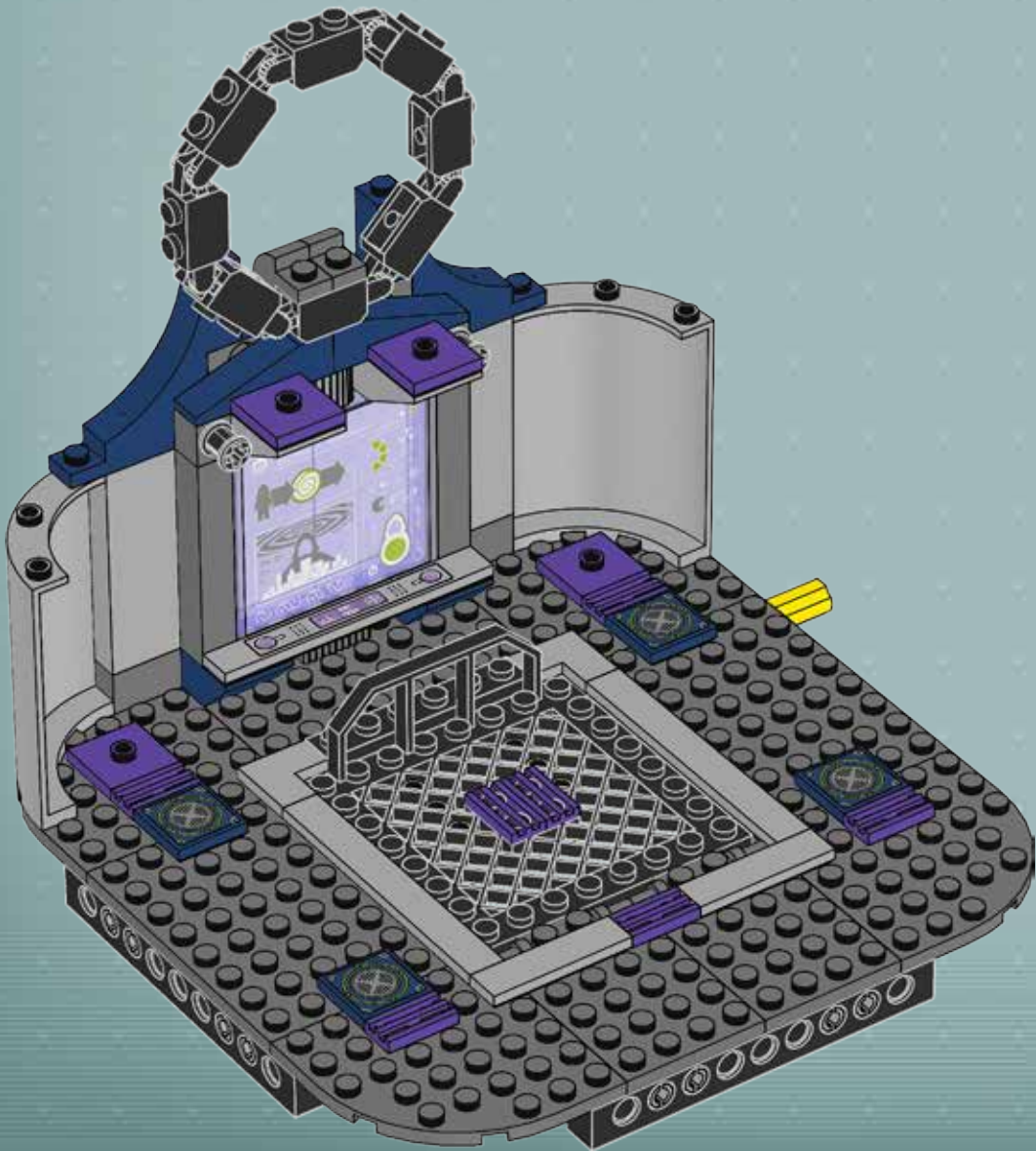





# 31

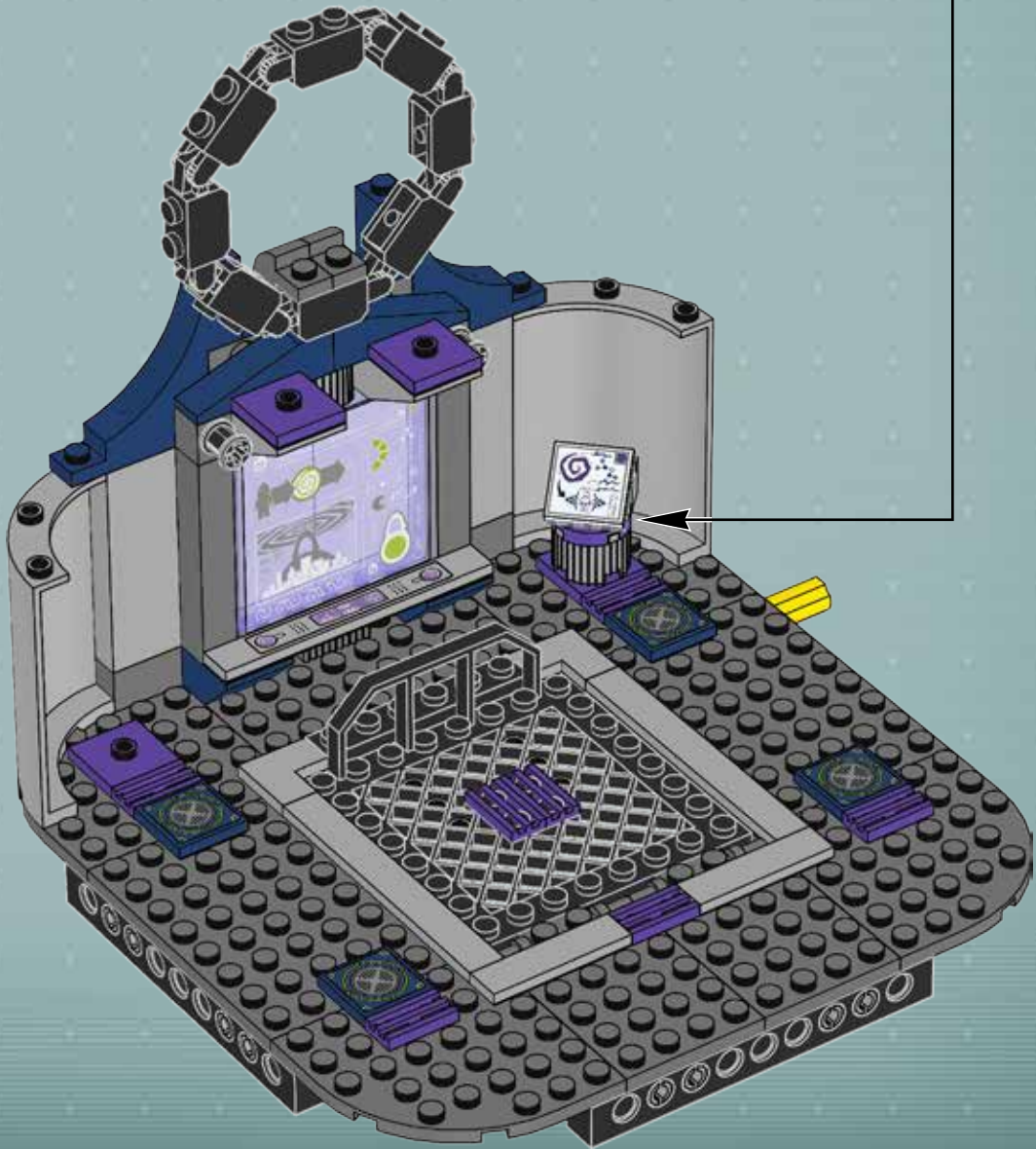
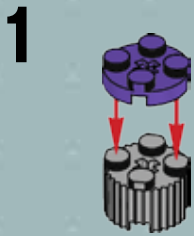

- 1x 
- 1x 
- 1x 
- 1x 

# 32

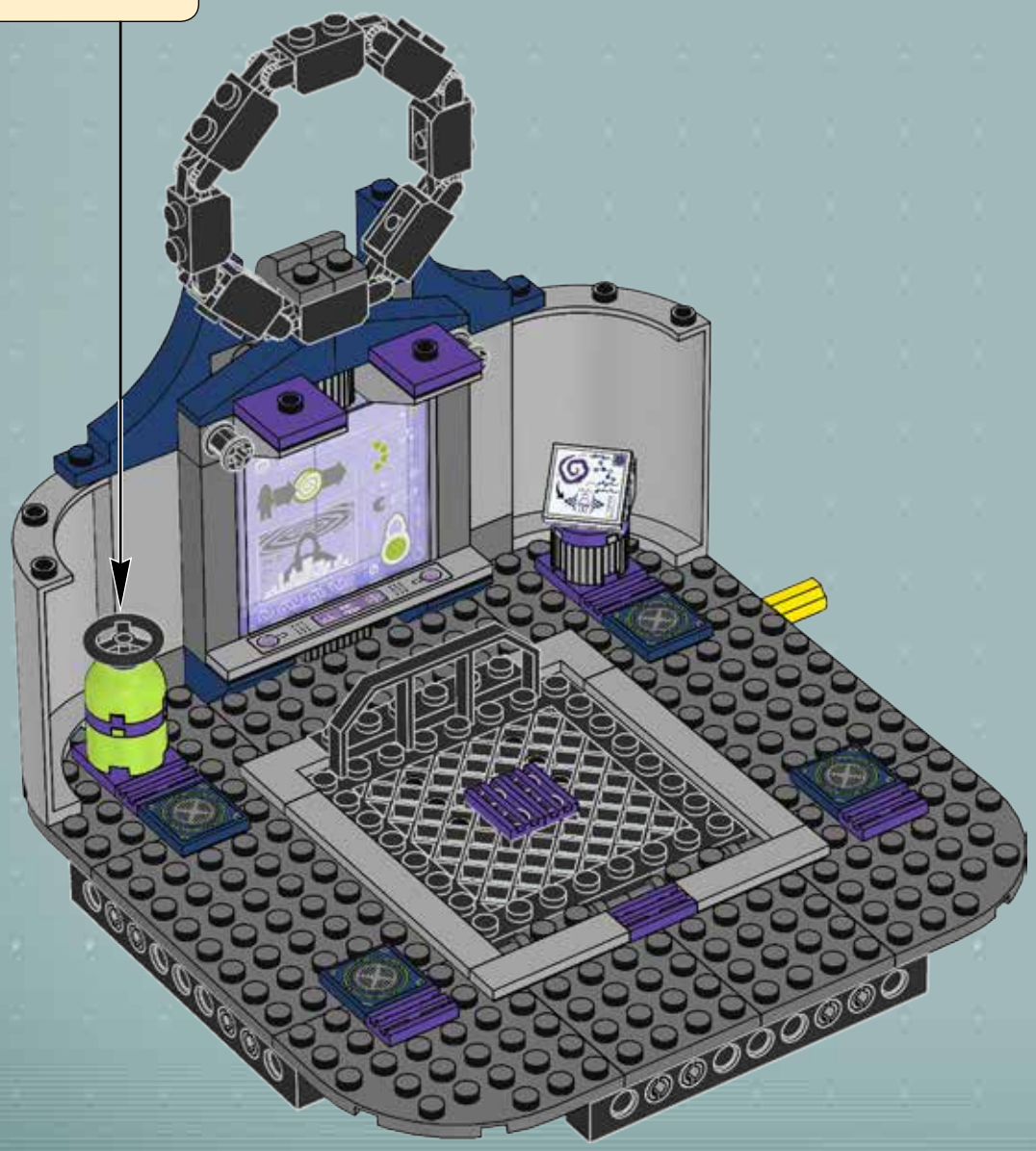
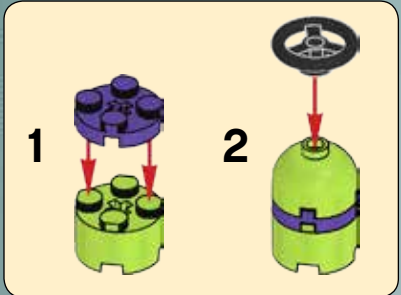

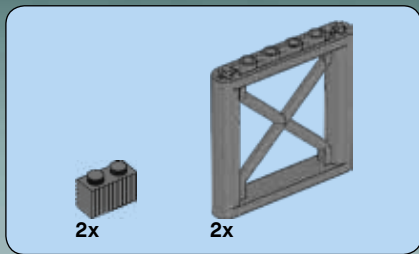

# 33

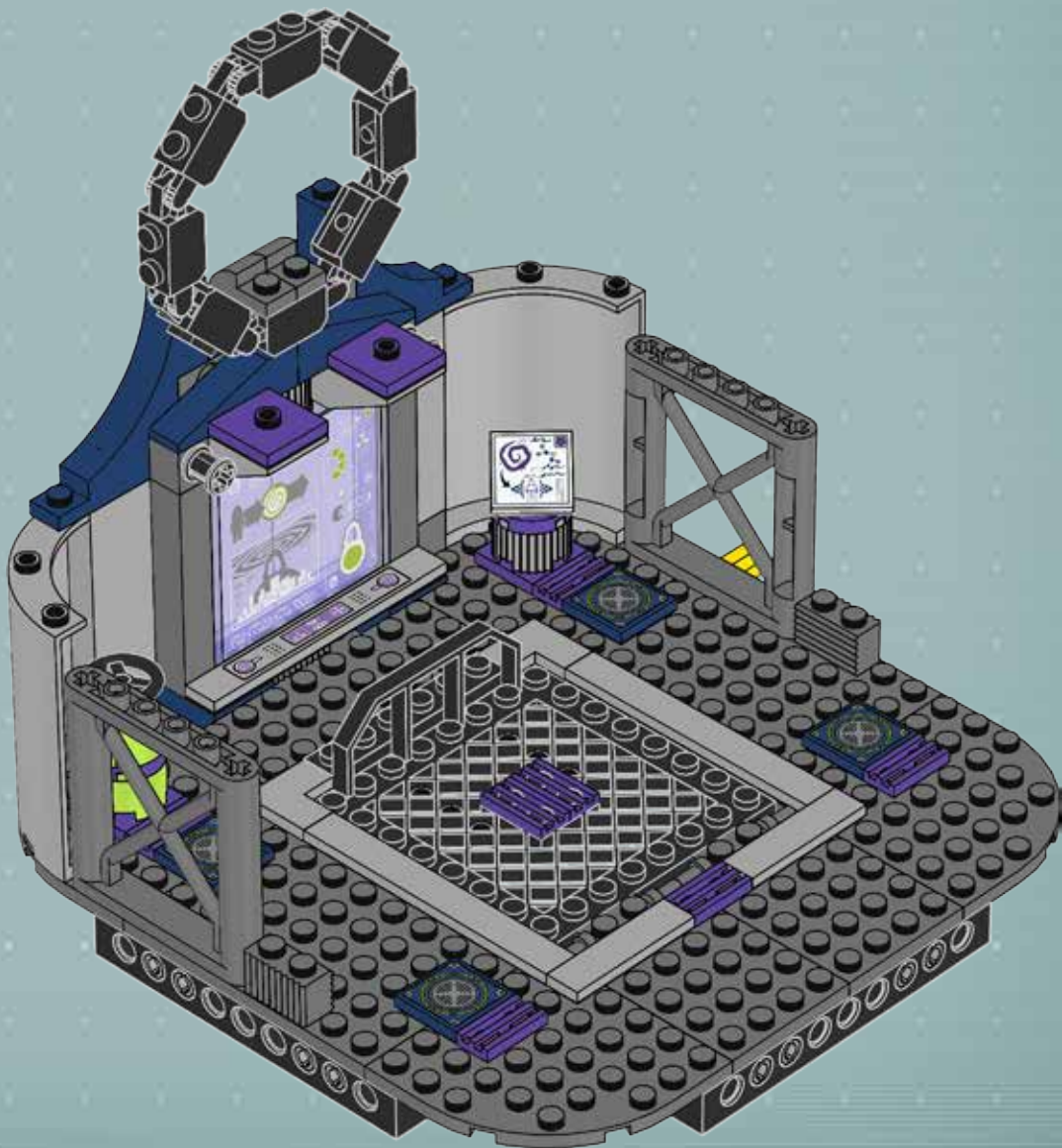



2x



4x

# 34

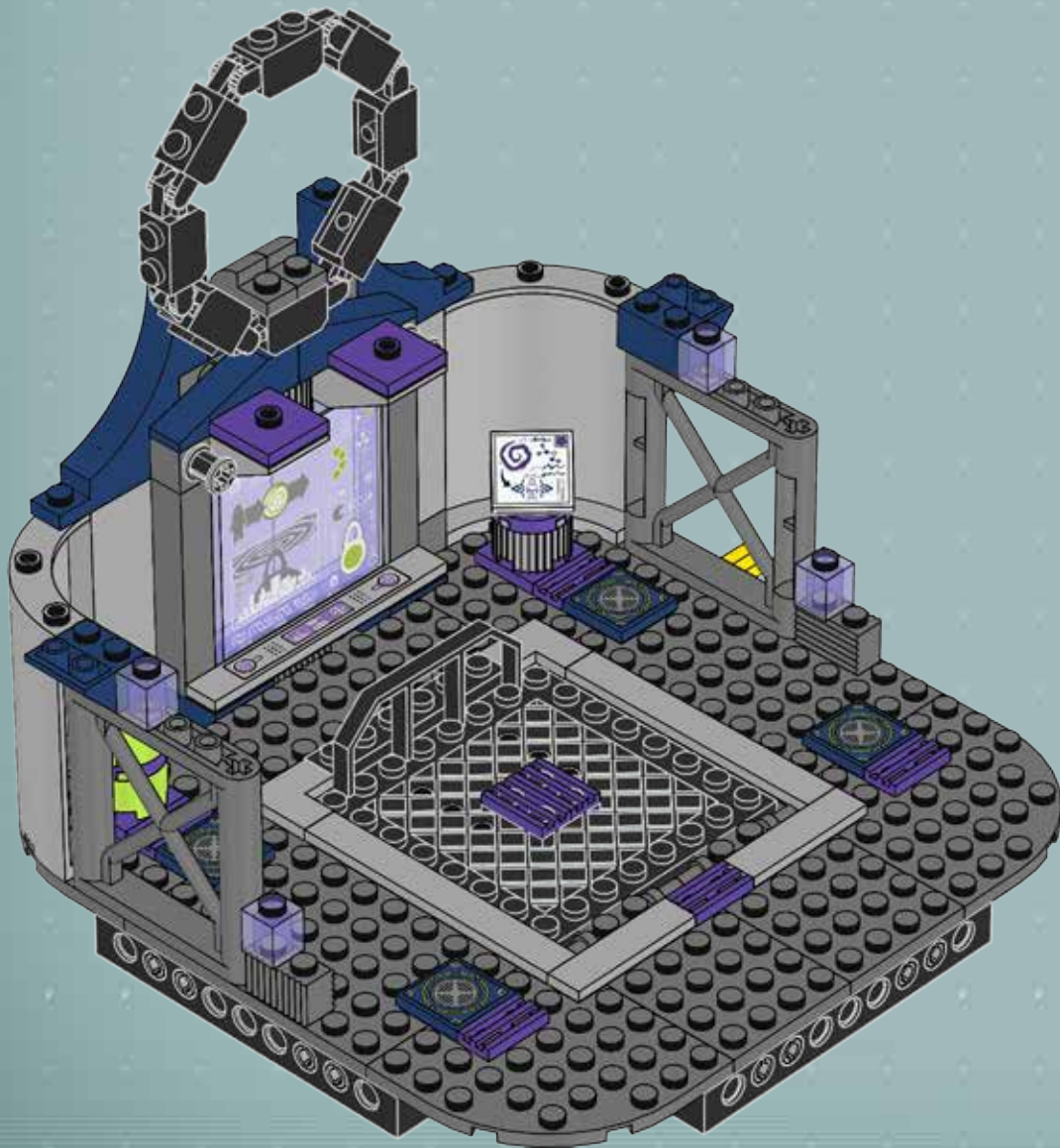



2x

# 35

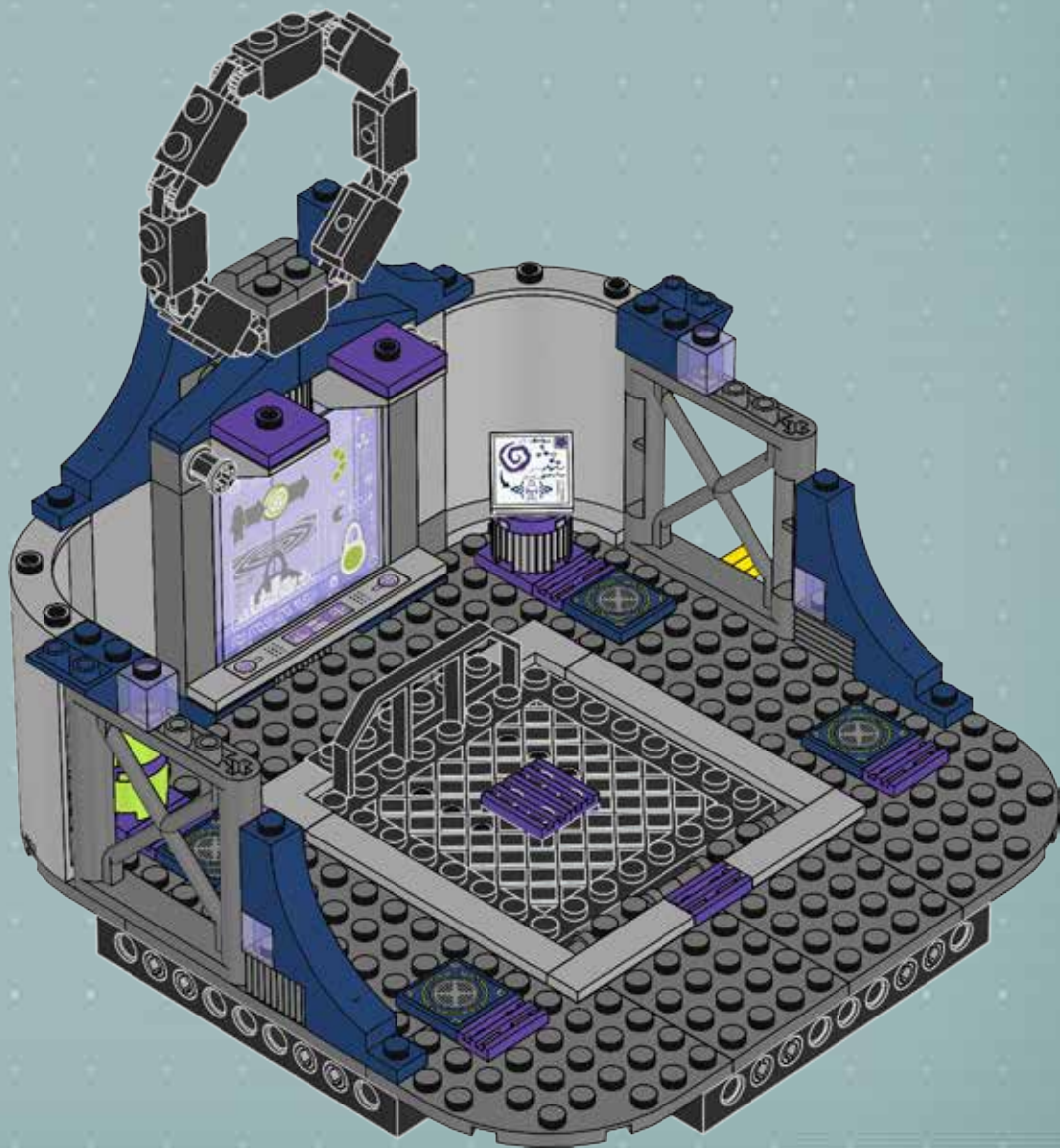

10 20 30 40

30  
20  
10  
10  
20  
30



2x



2x

# 36

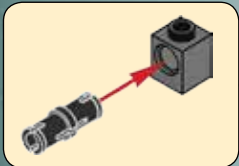
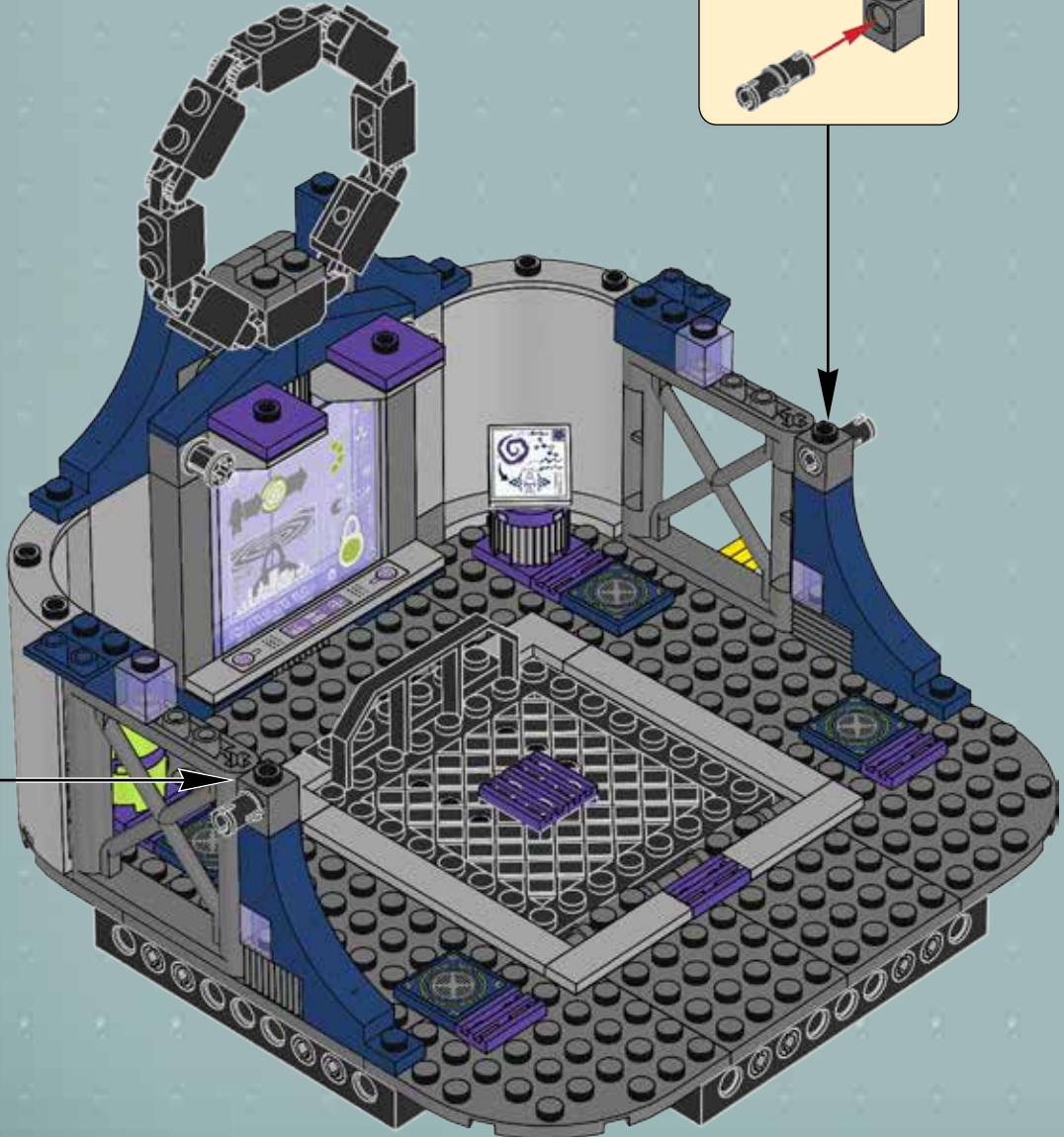
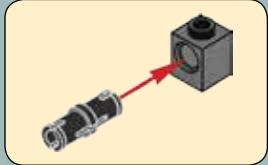



# 37

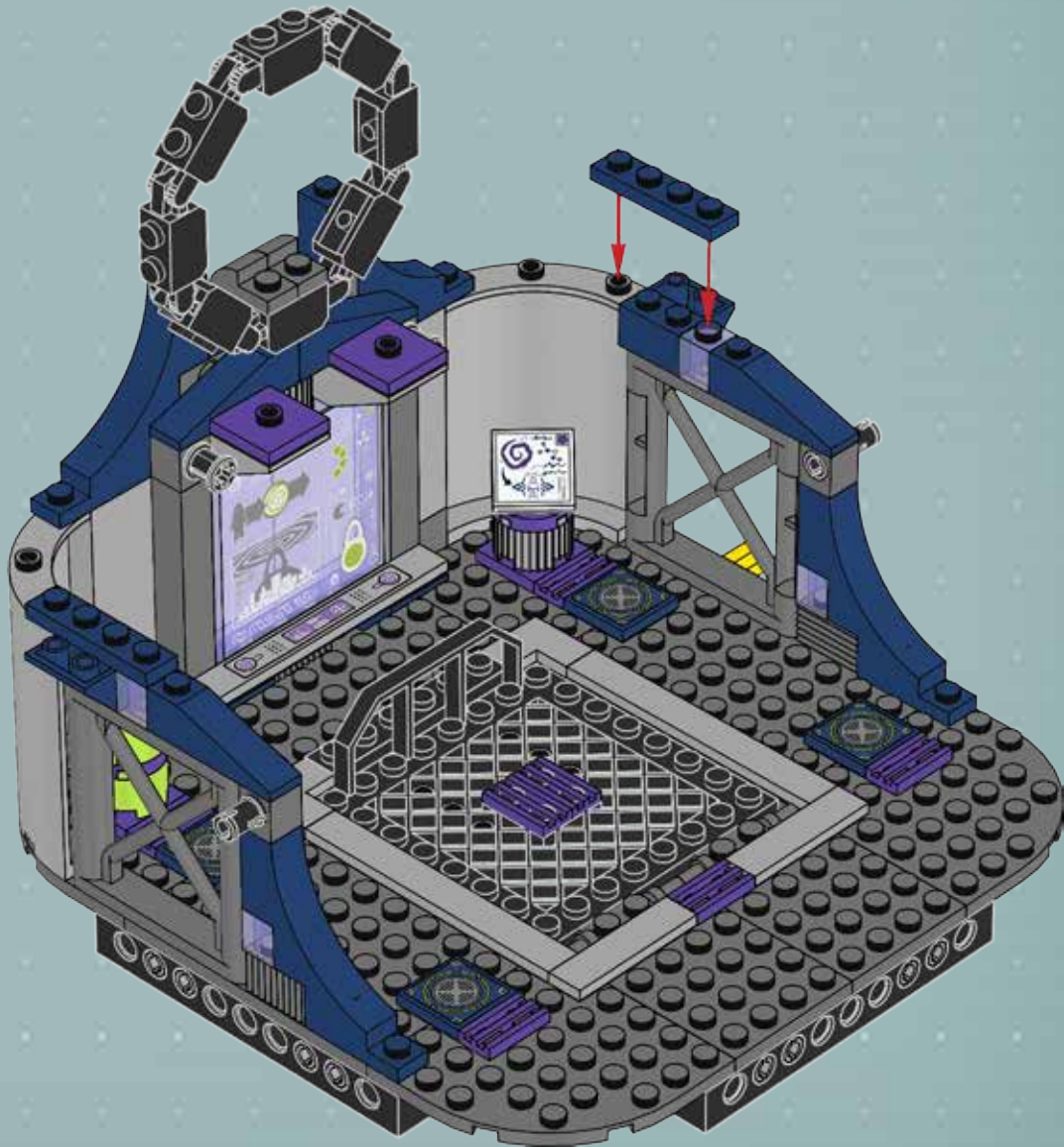



2x



2x

# 38

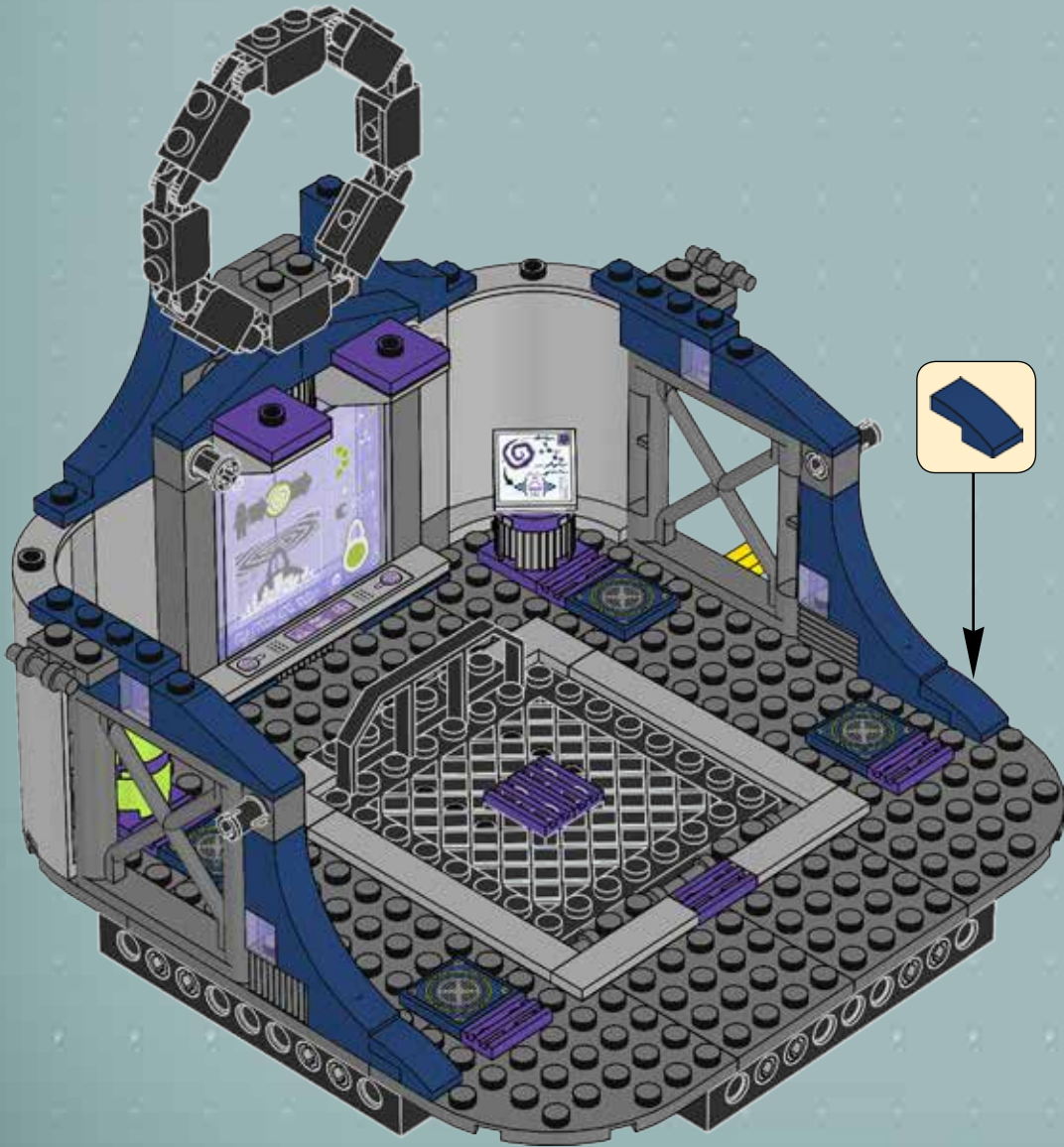





# 39





40

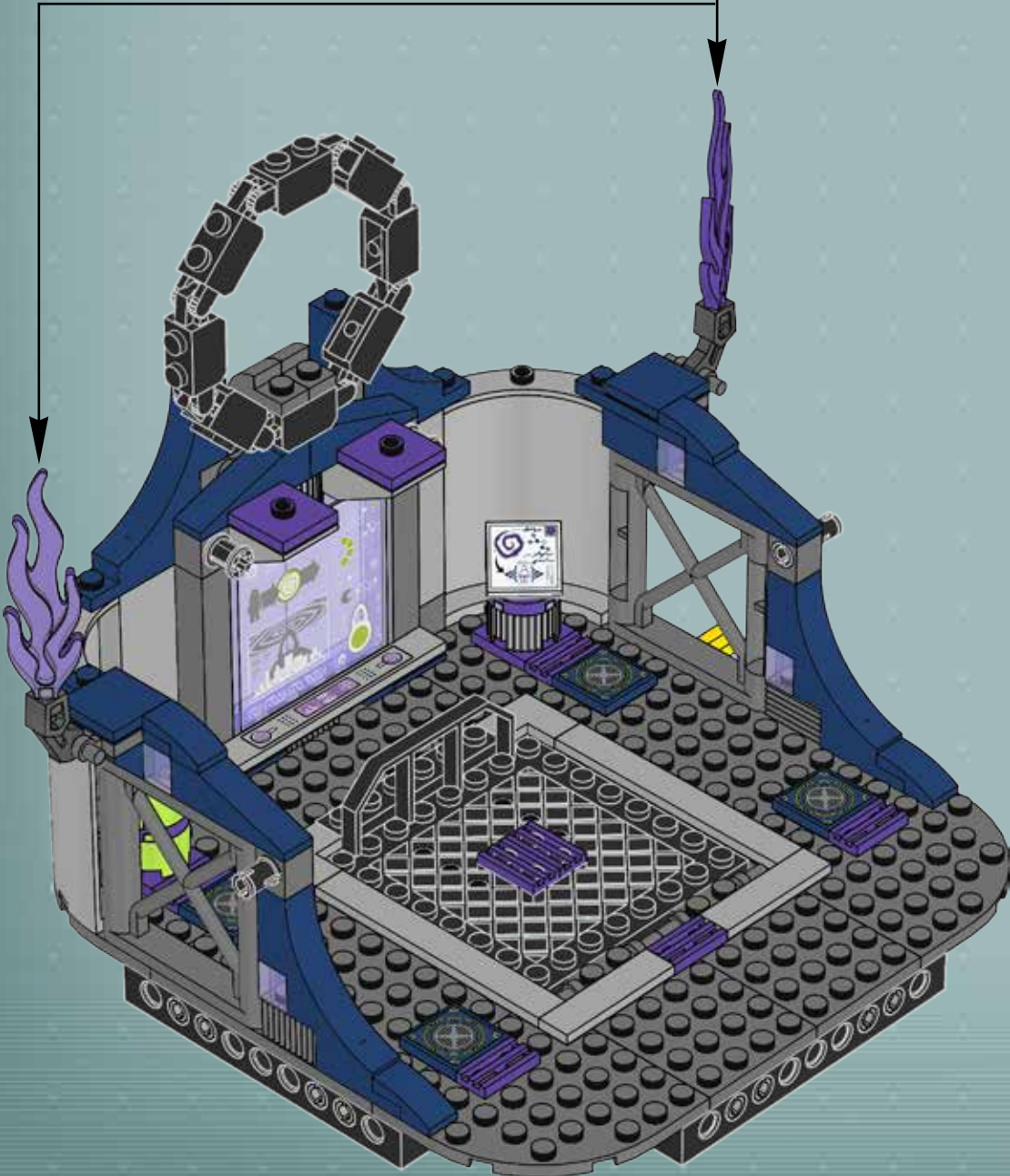

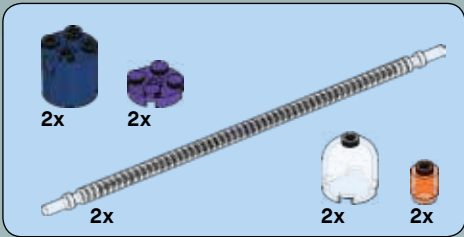

# 41

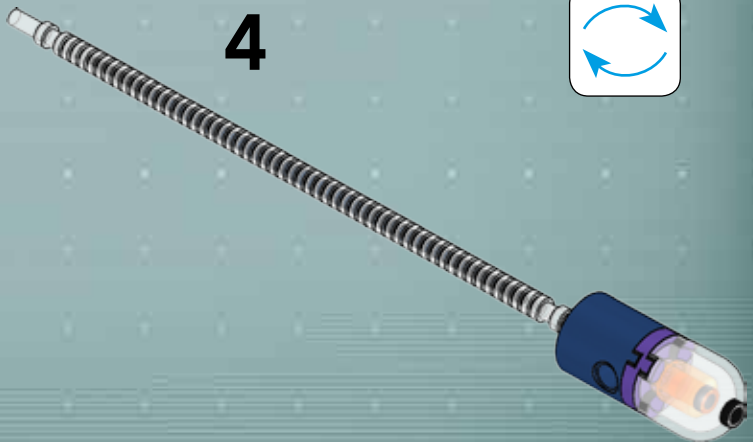

2x

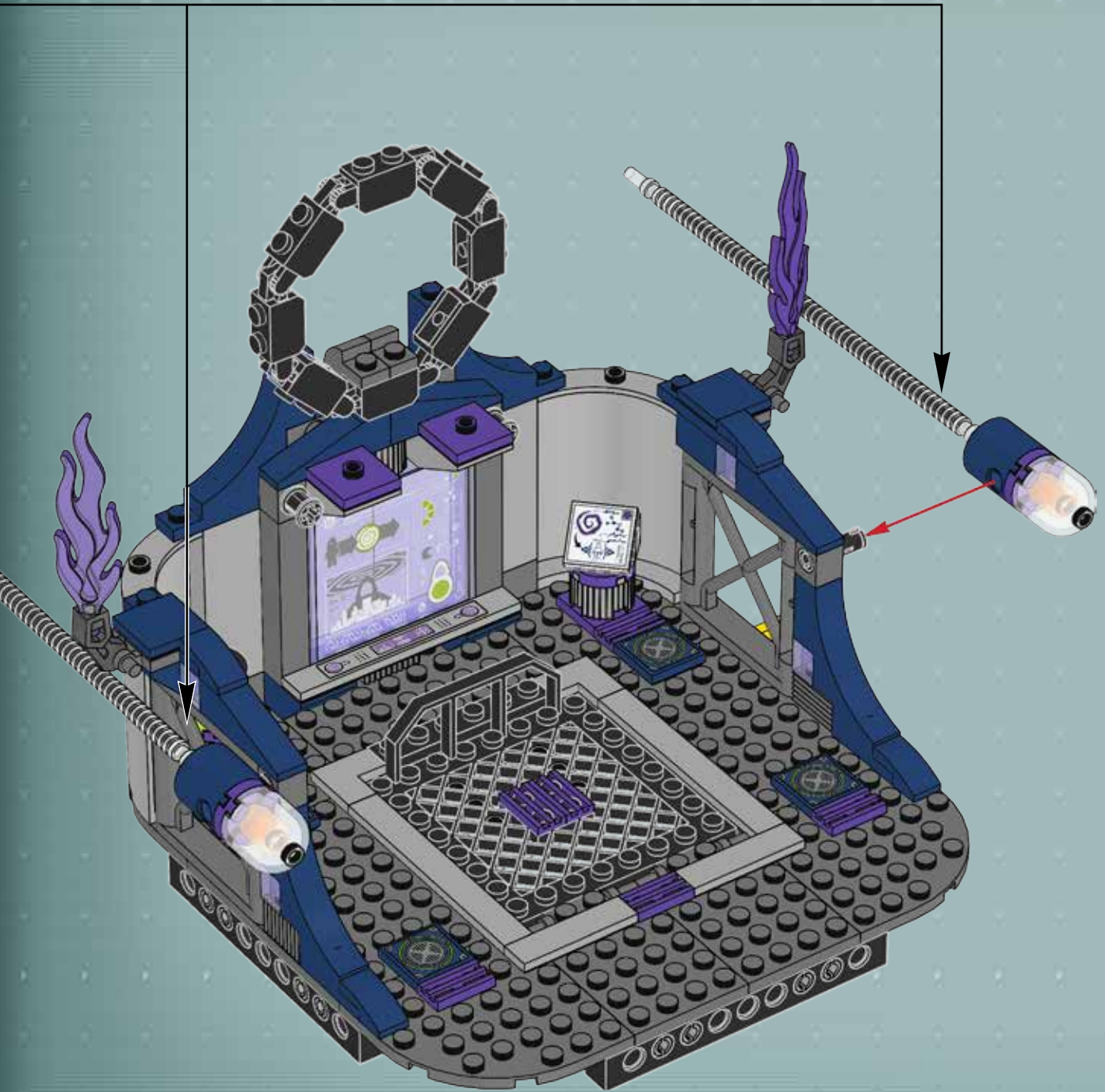



42

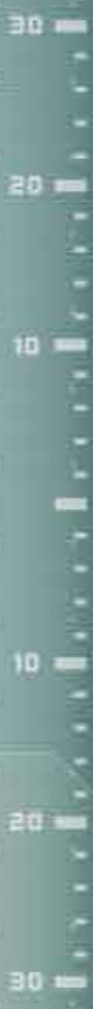
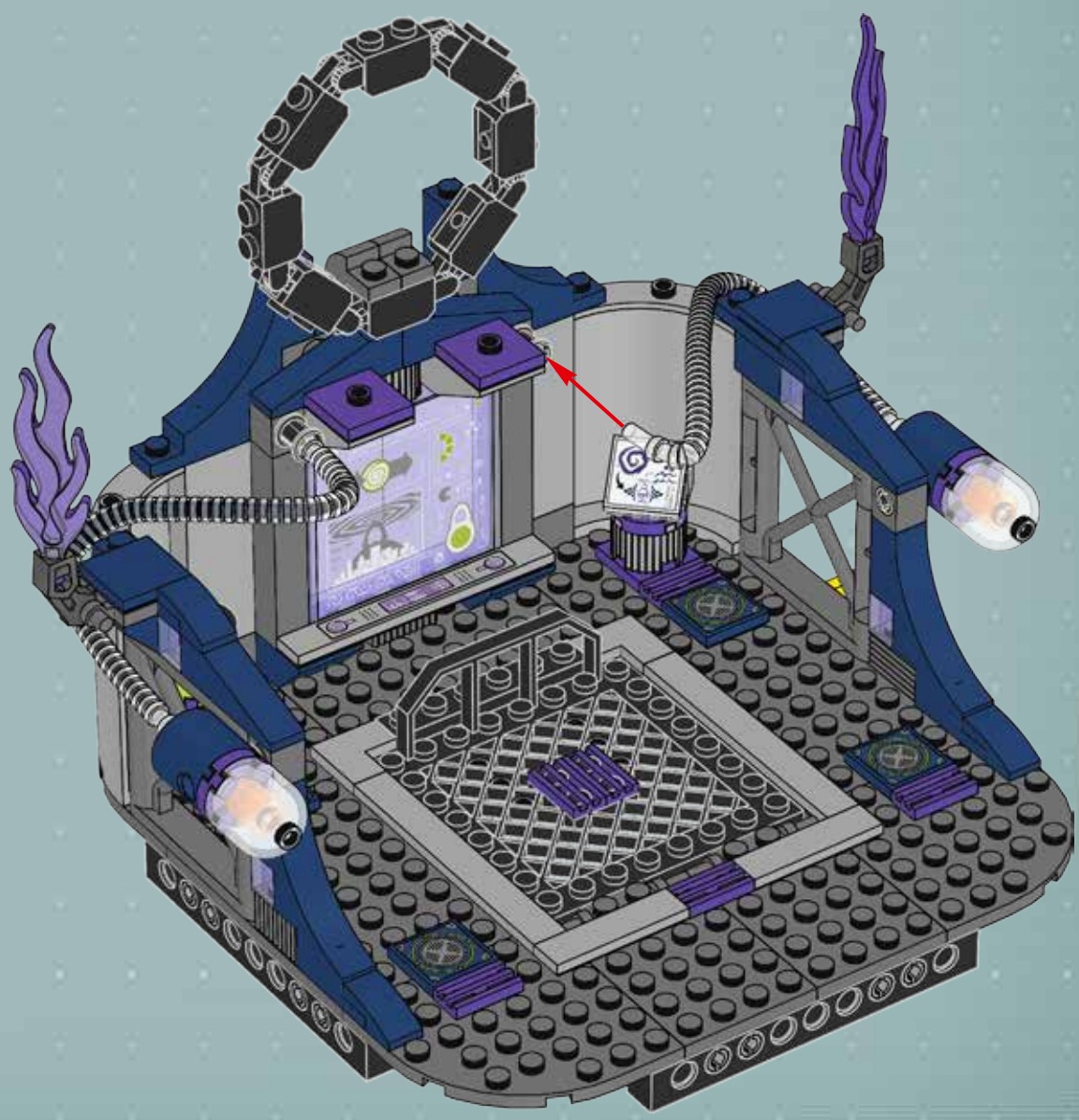



# 43

1



2



3

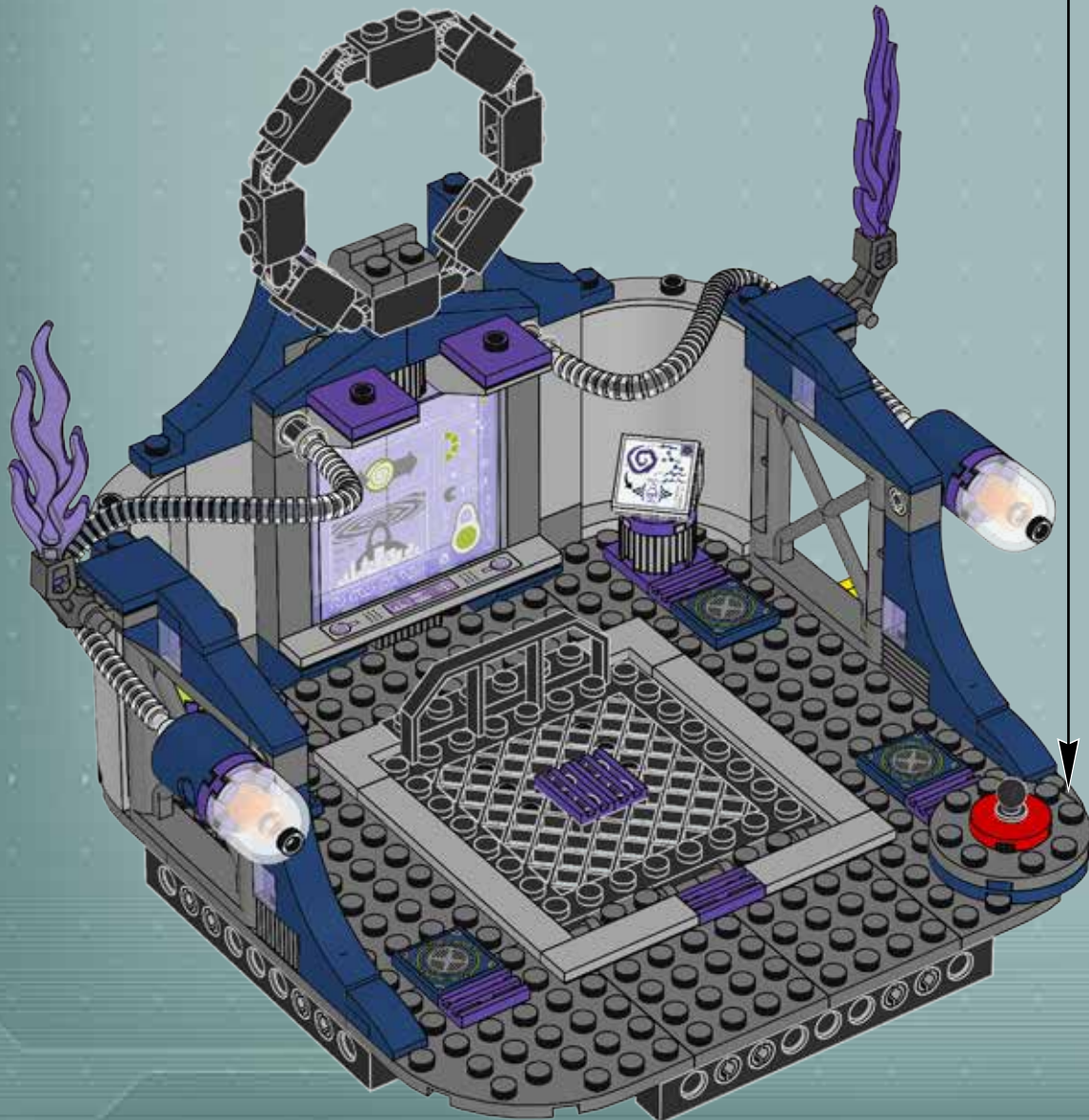

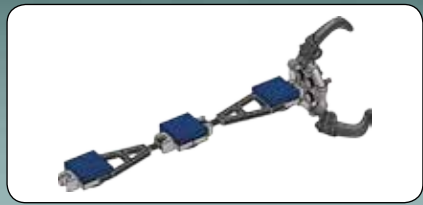

1

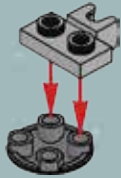

2



3

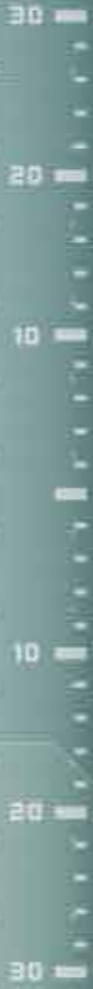



4

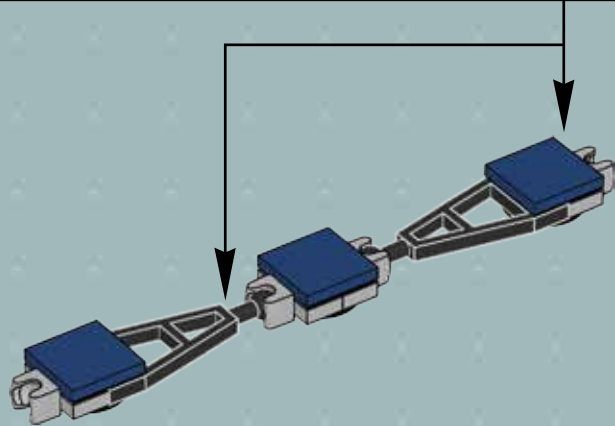
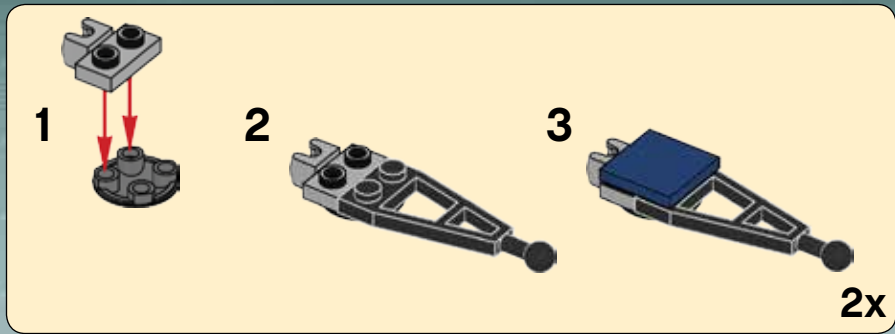

5

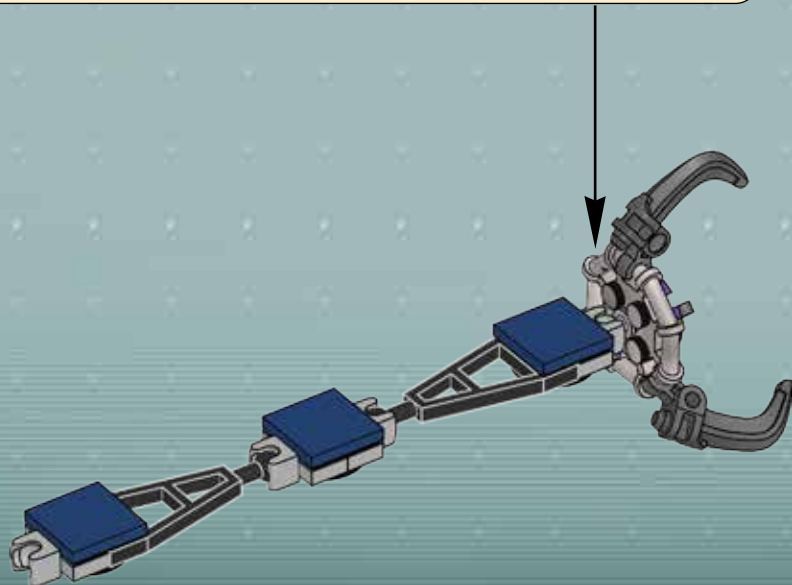
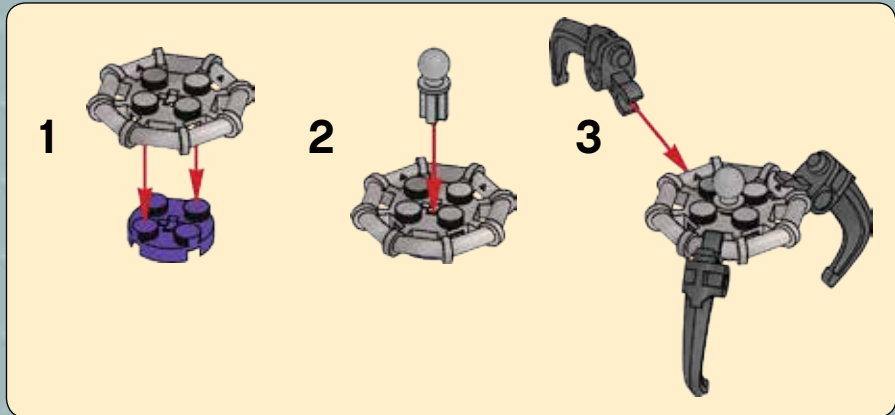





44

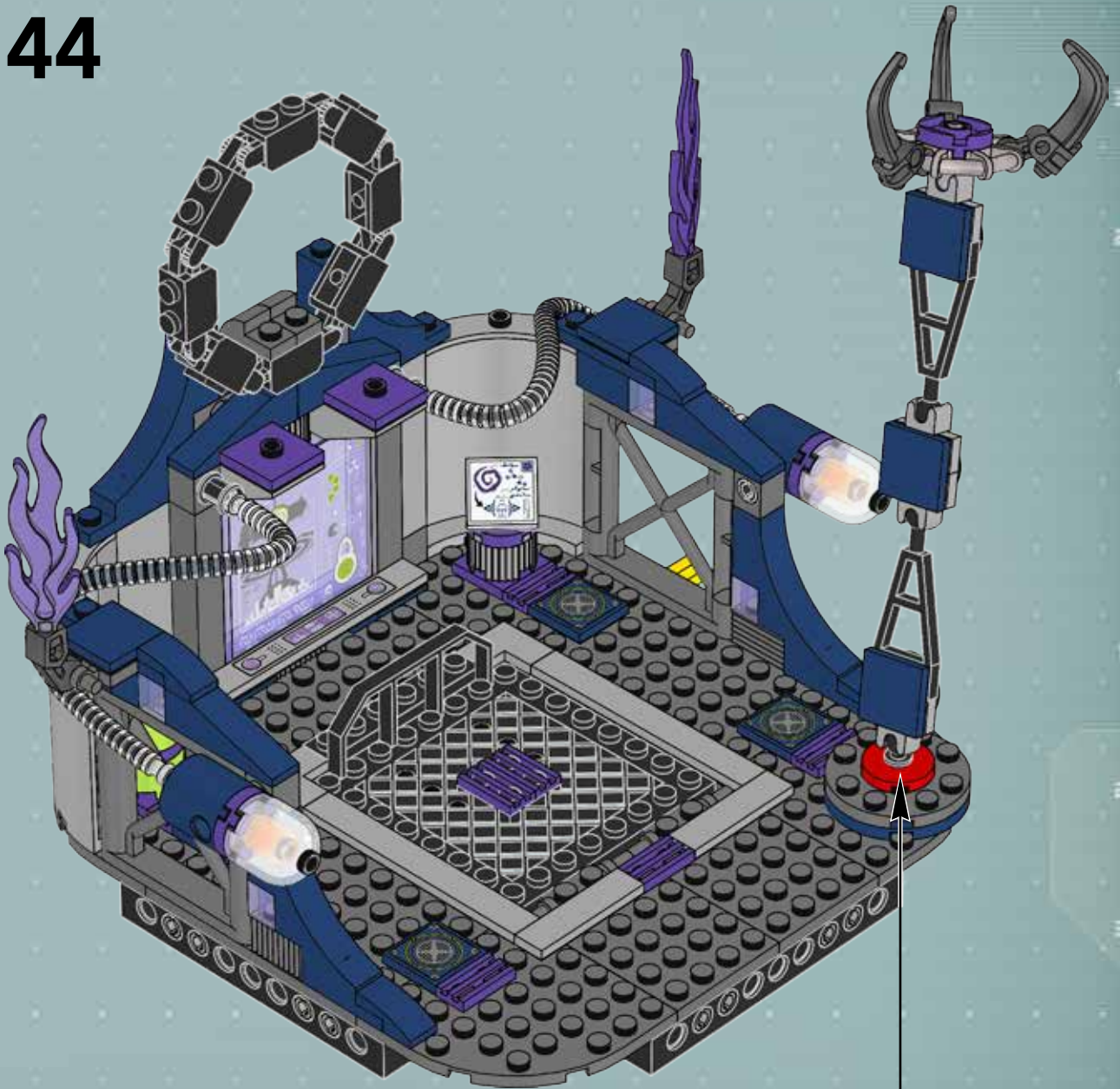

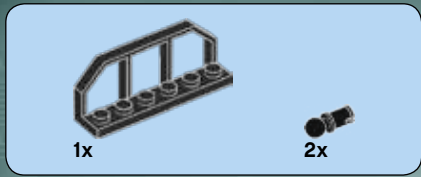

45

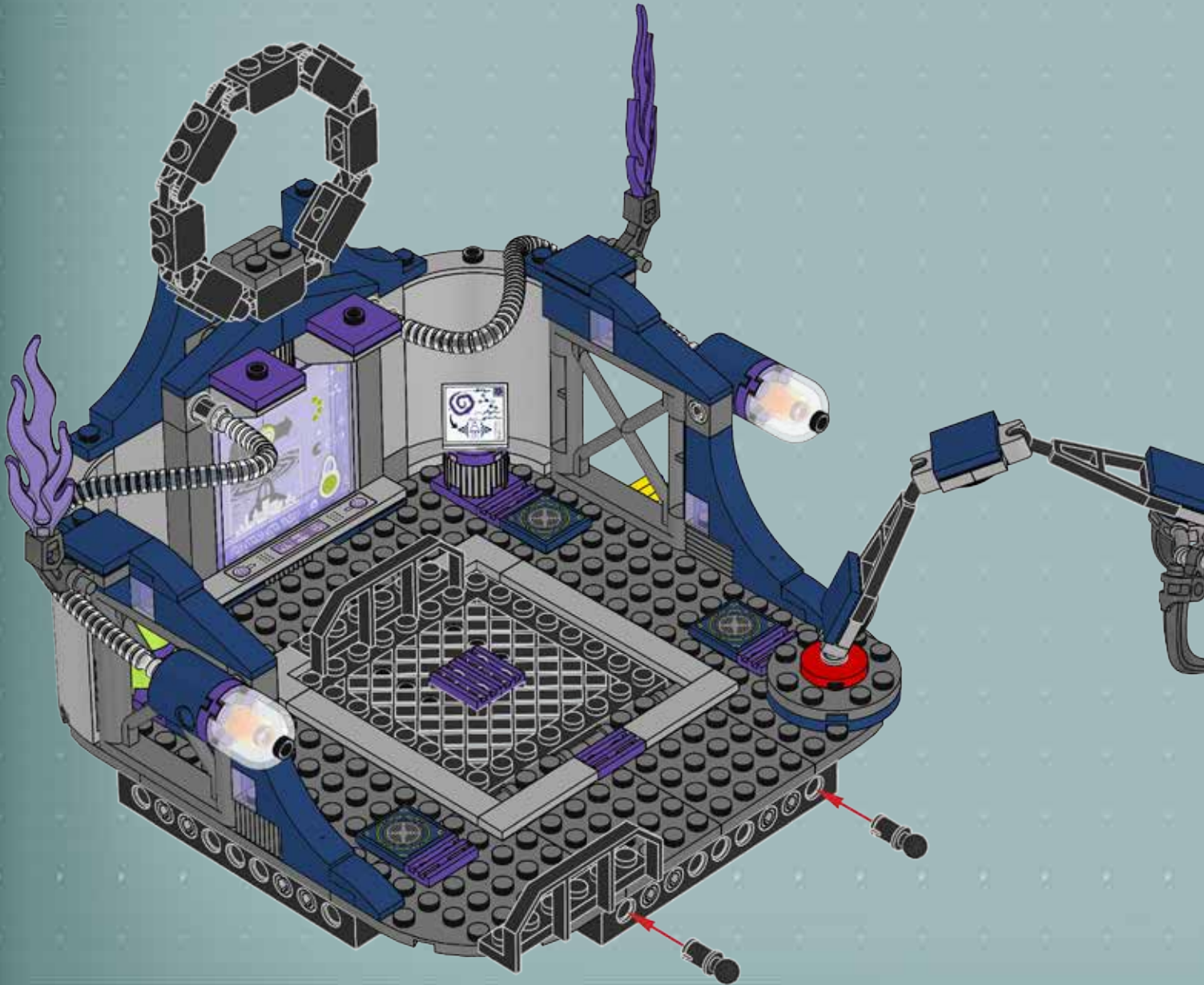



2x



2x



2x

# 46

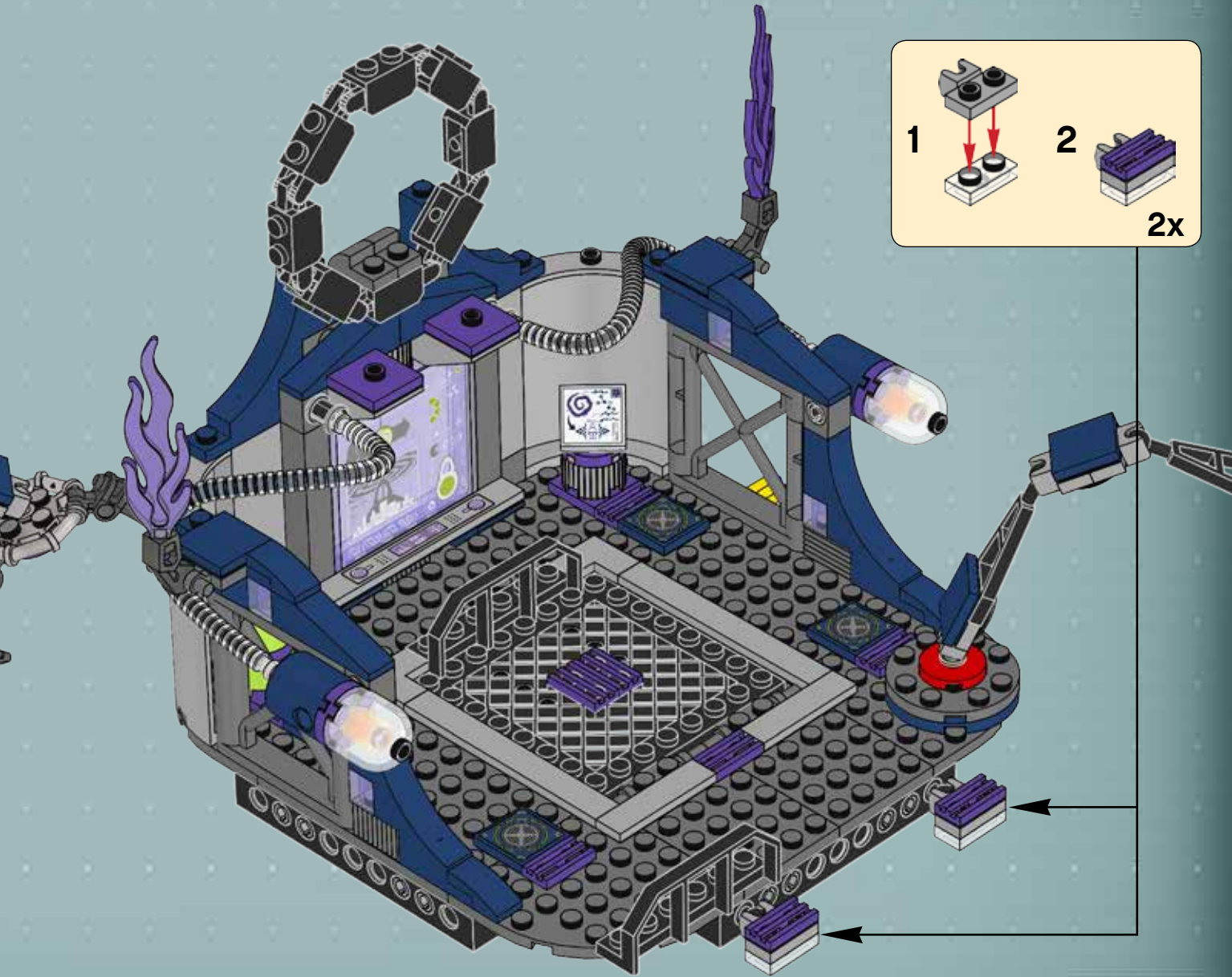
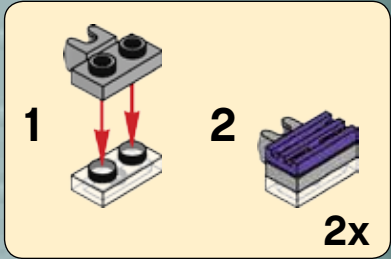

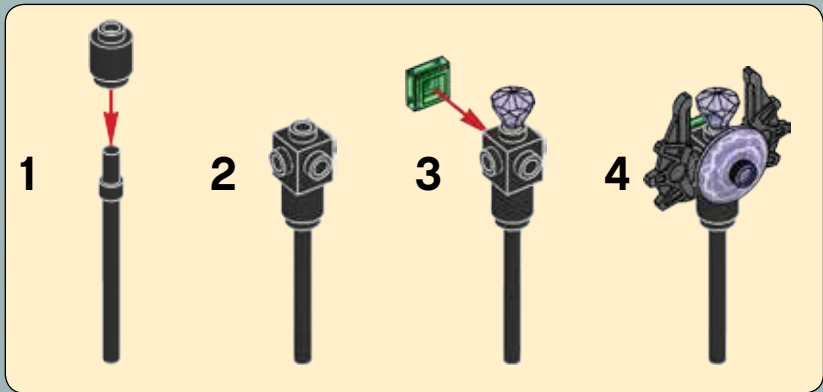
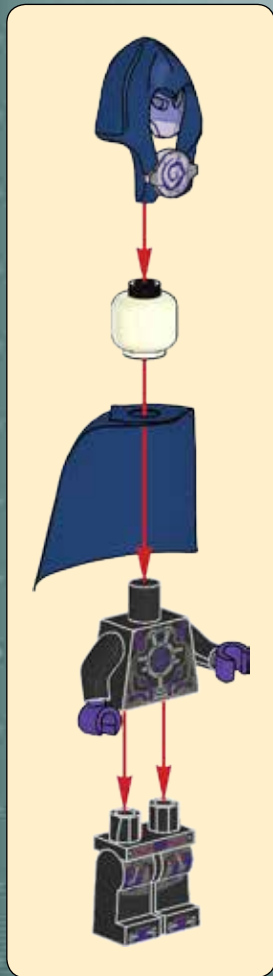
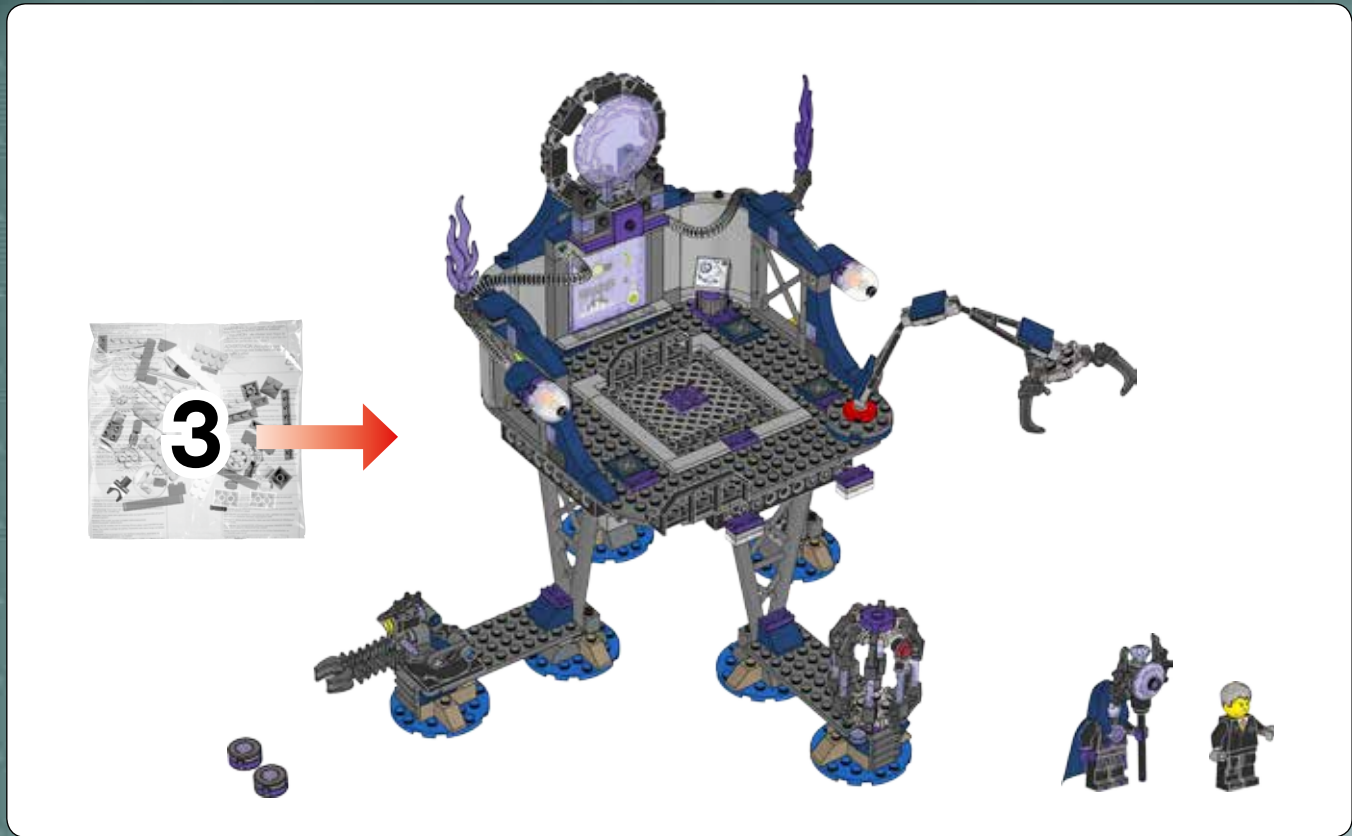

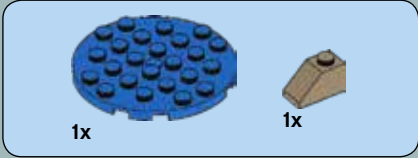
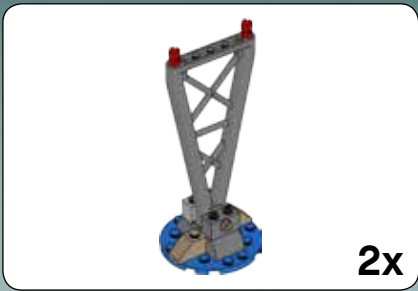

1



2



3

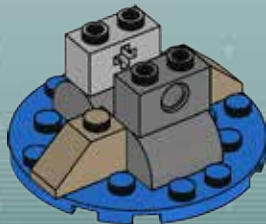

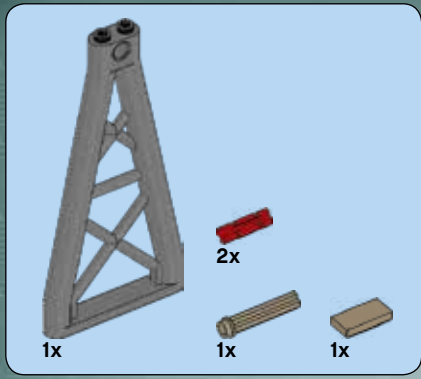

4

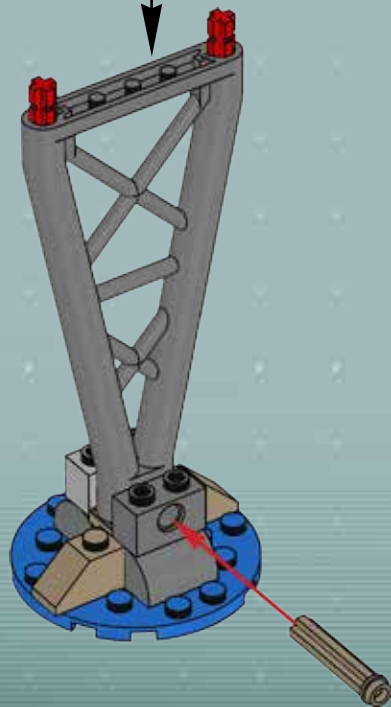
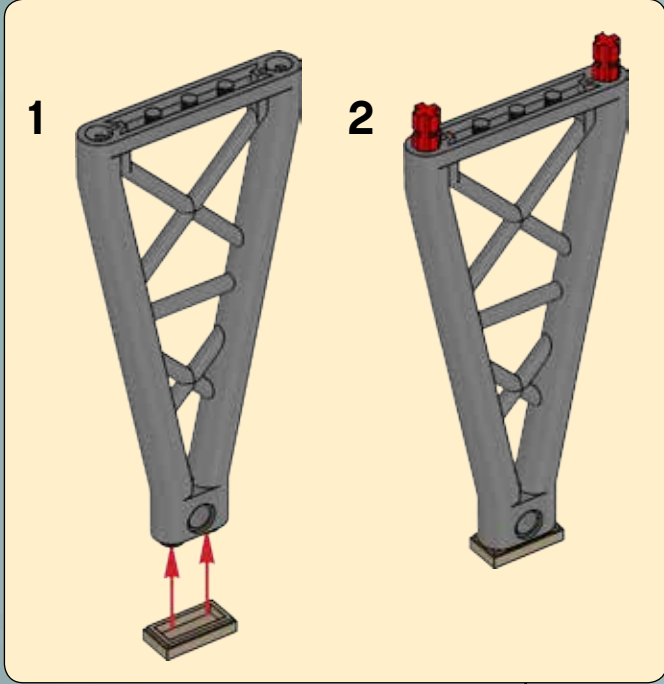



47

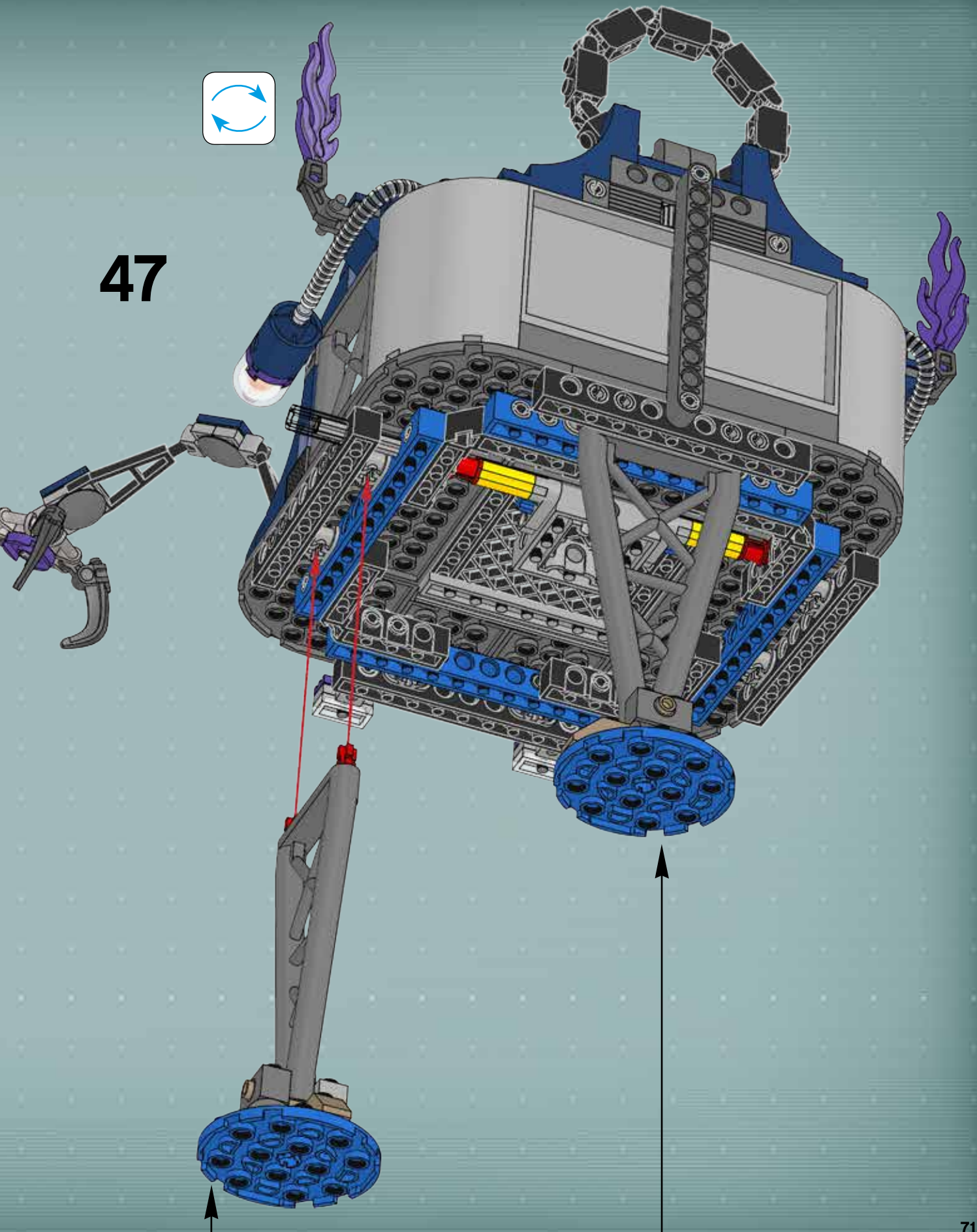

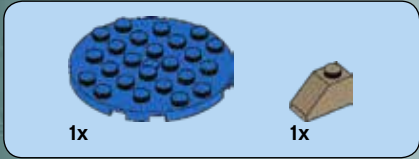
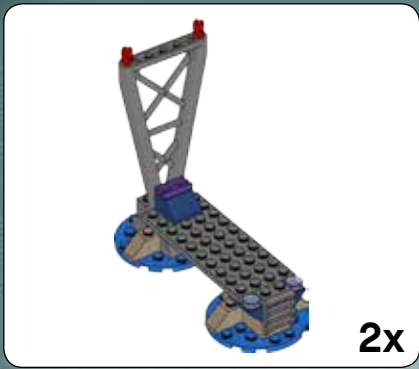

1



2



3

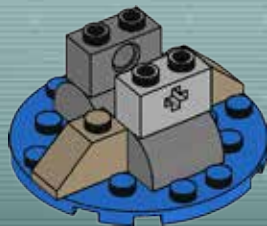



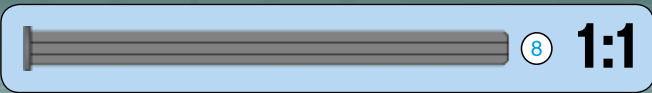
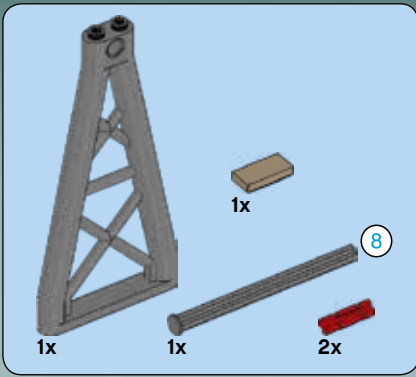

4

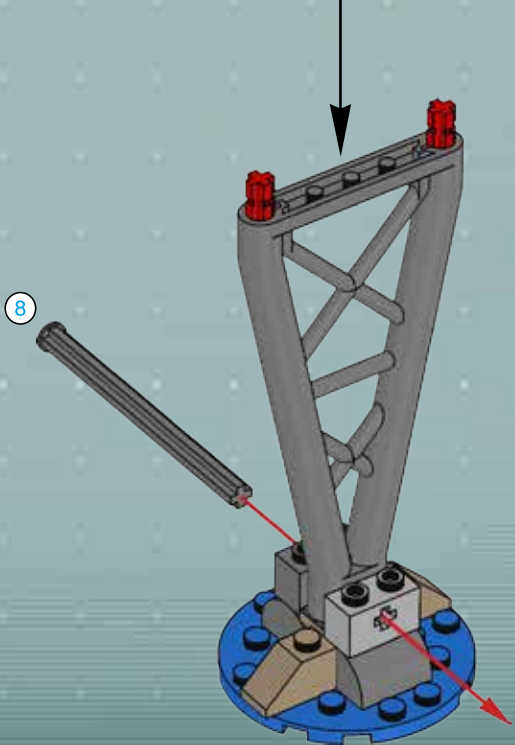
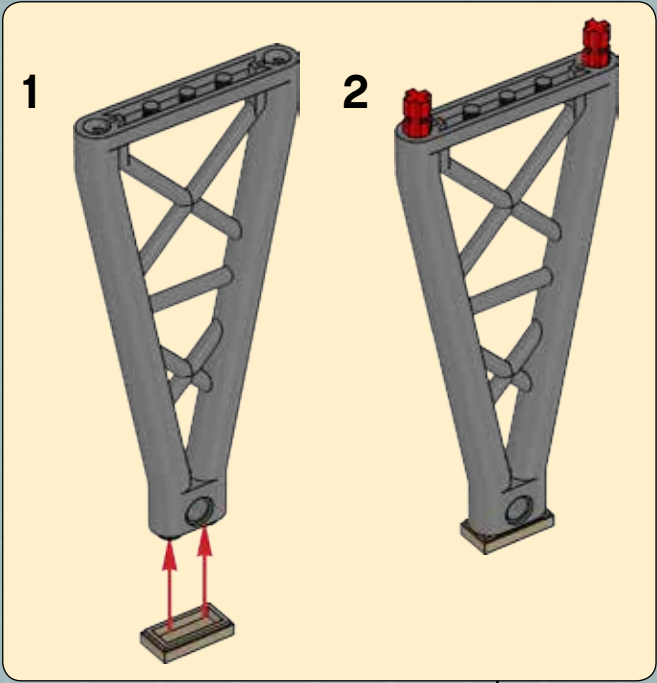



1x



1x

5

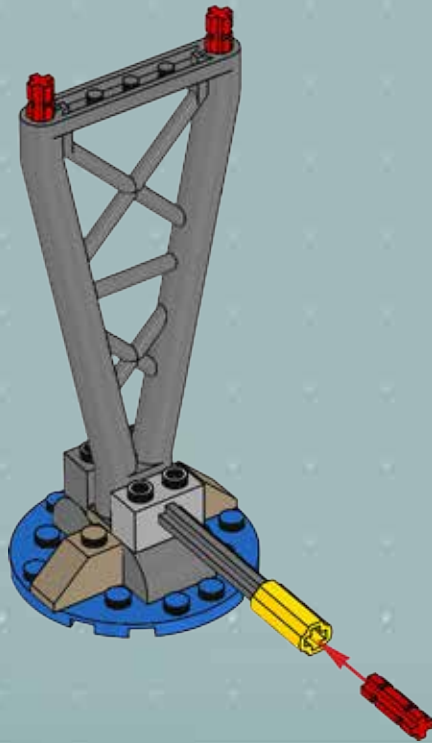



1x	2x
1x	1x

# 6

<b>1</b>	<b>2</b>	<b>3</b>

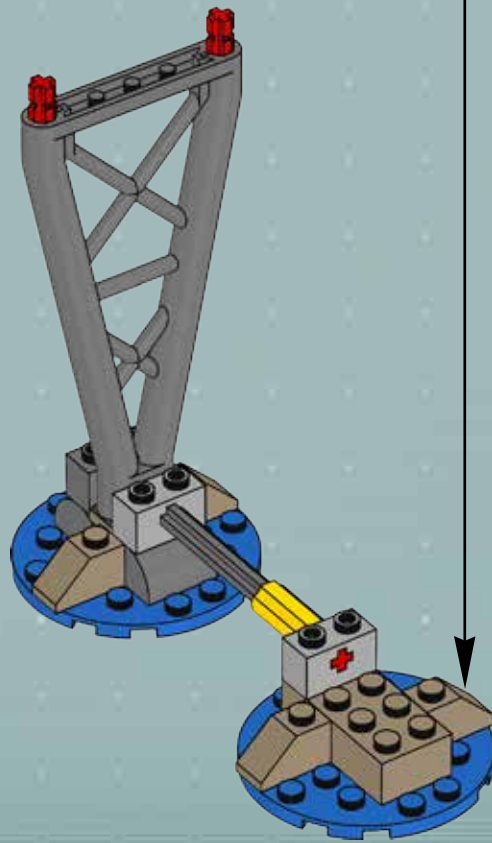



2x

7

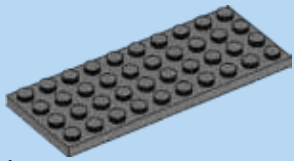
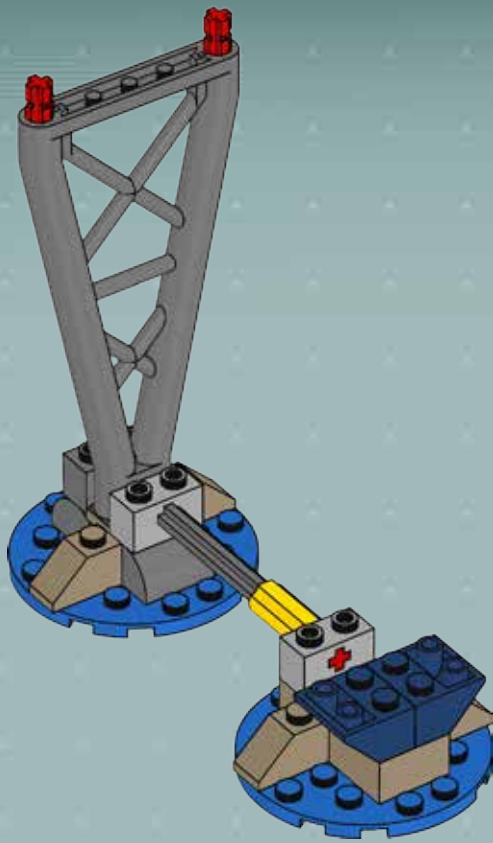

1x

8

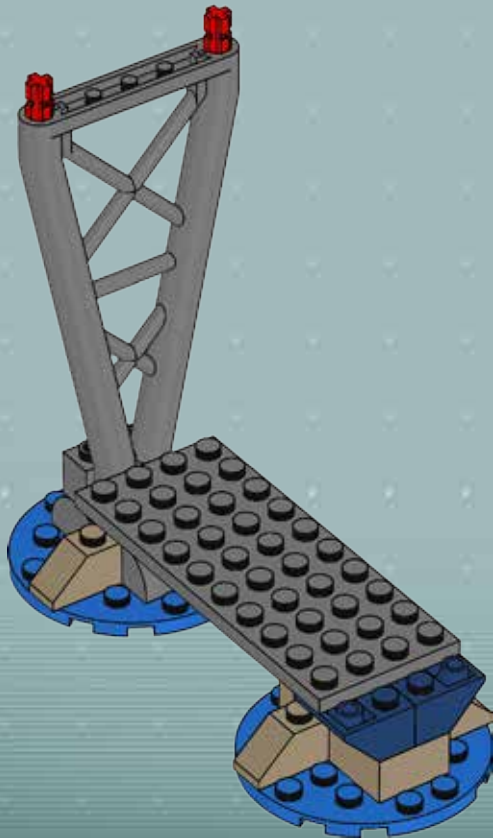



9

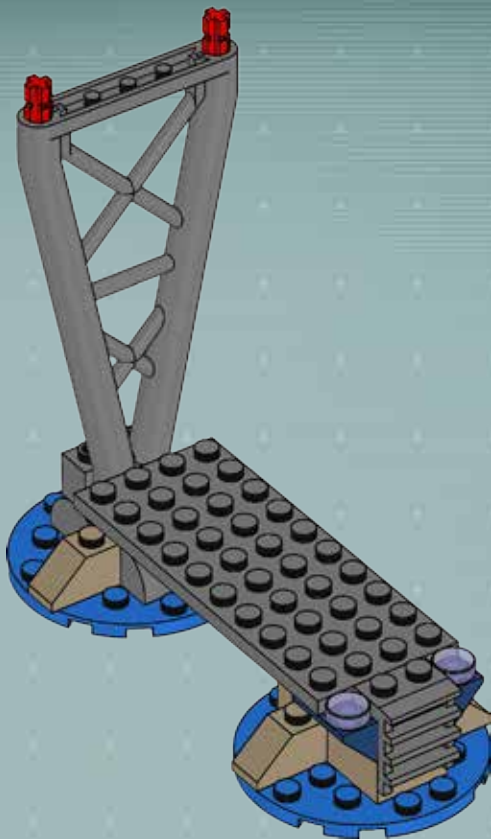

10

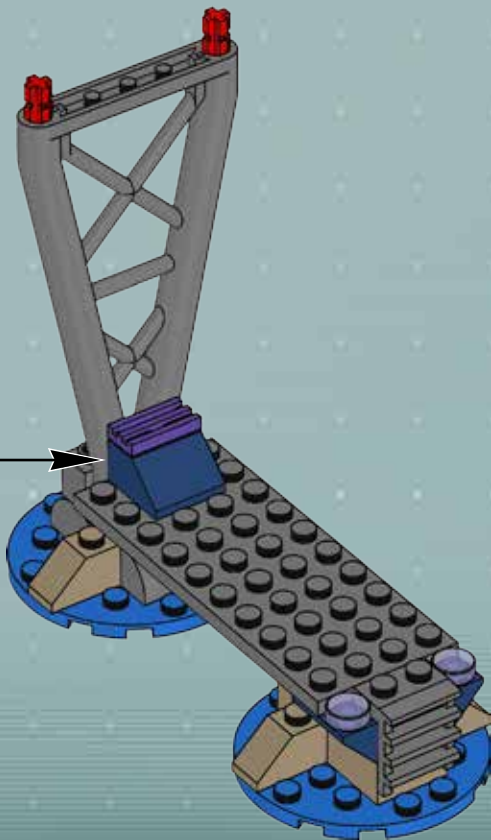
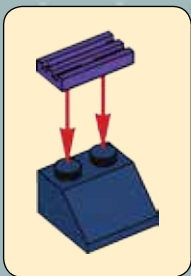

2x

48

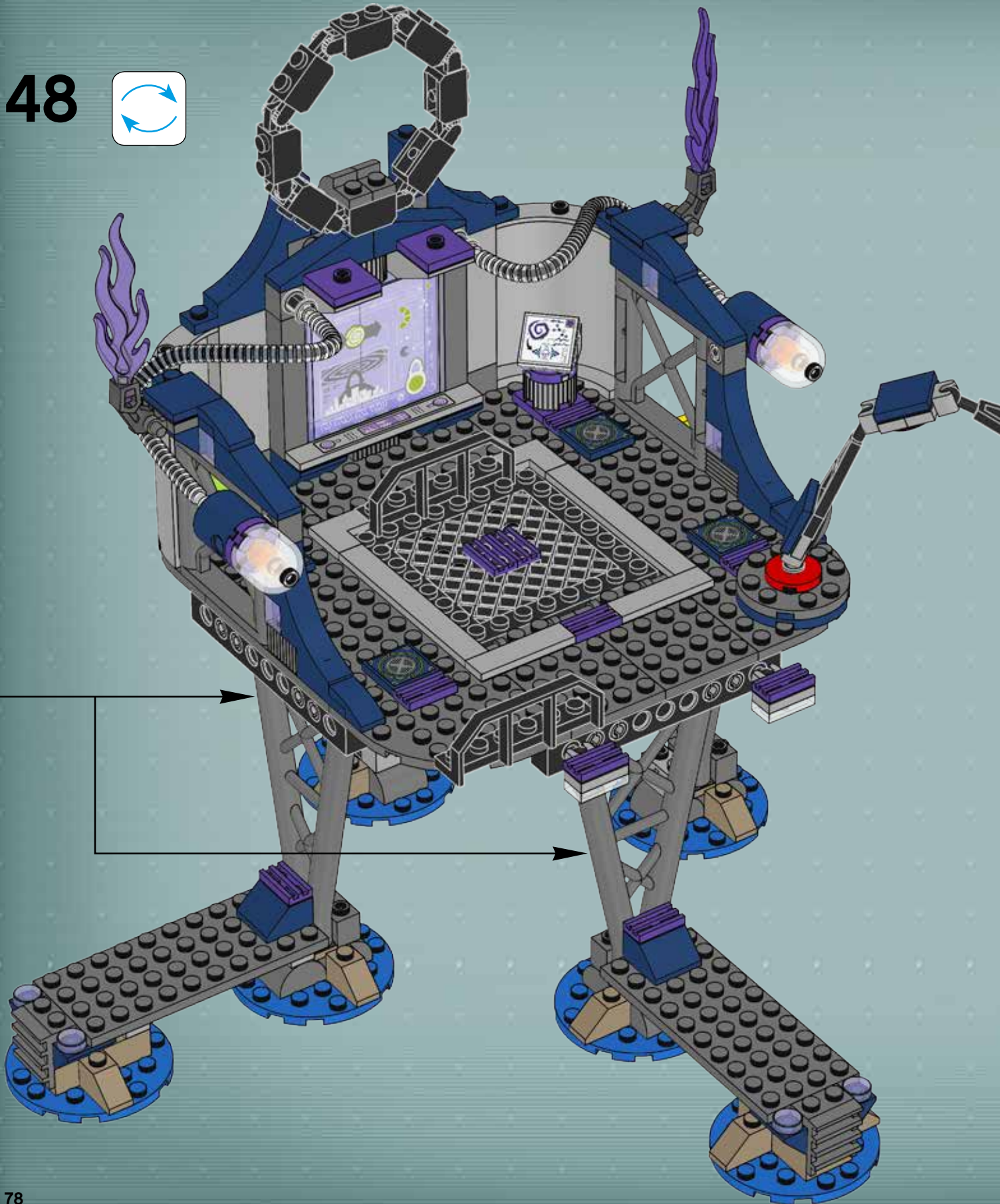

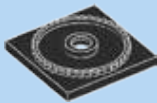

1x



1x

# 49





1



2

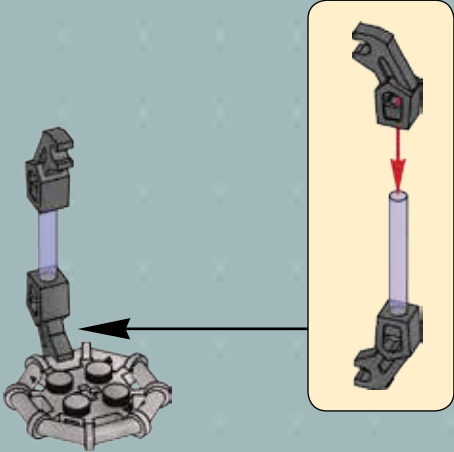

3

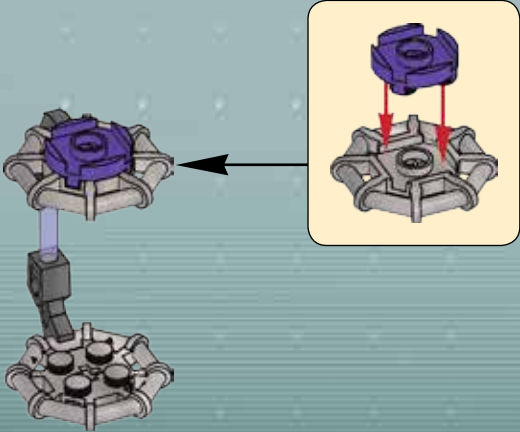







6x  12x 

4

1  2  6x

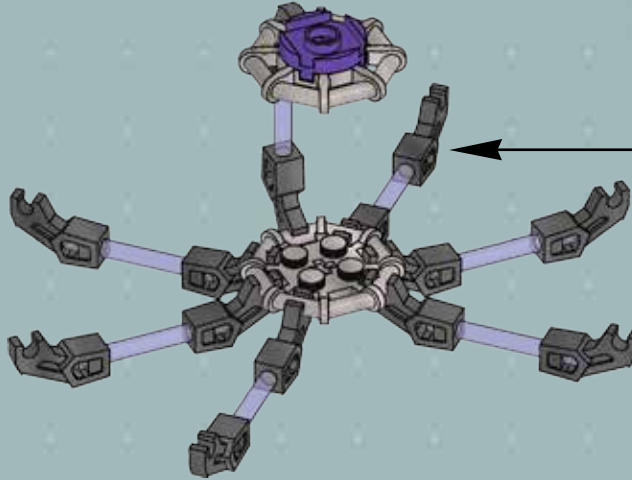

5

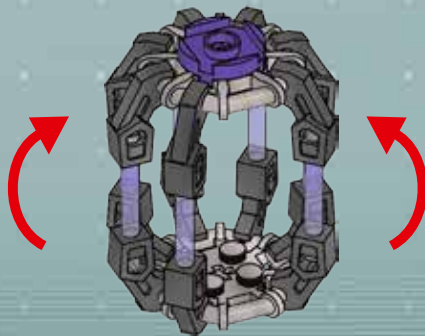

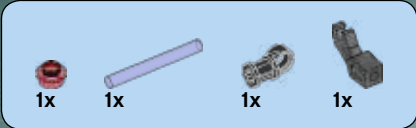

# 6

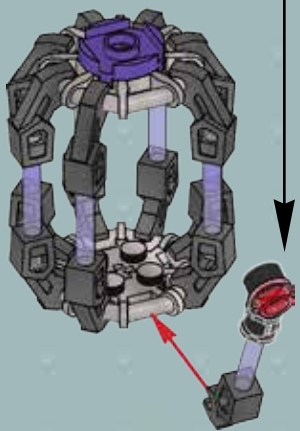
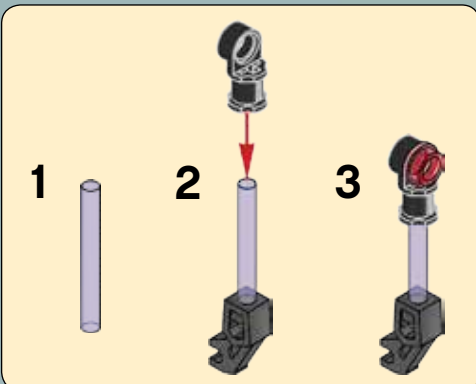

50

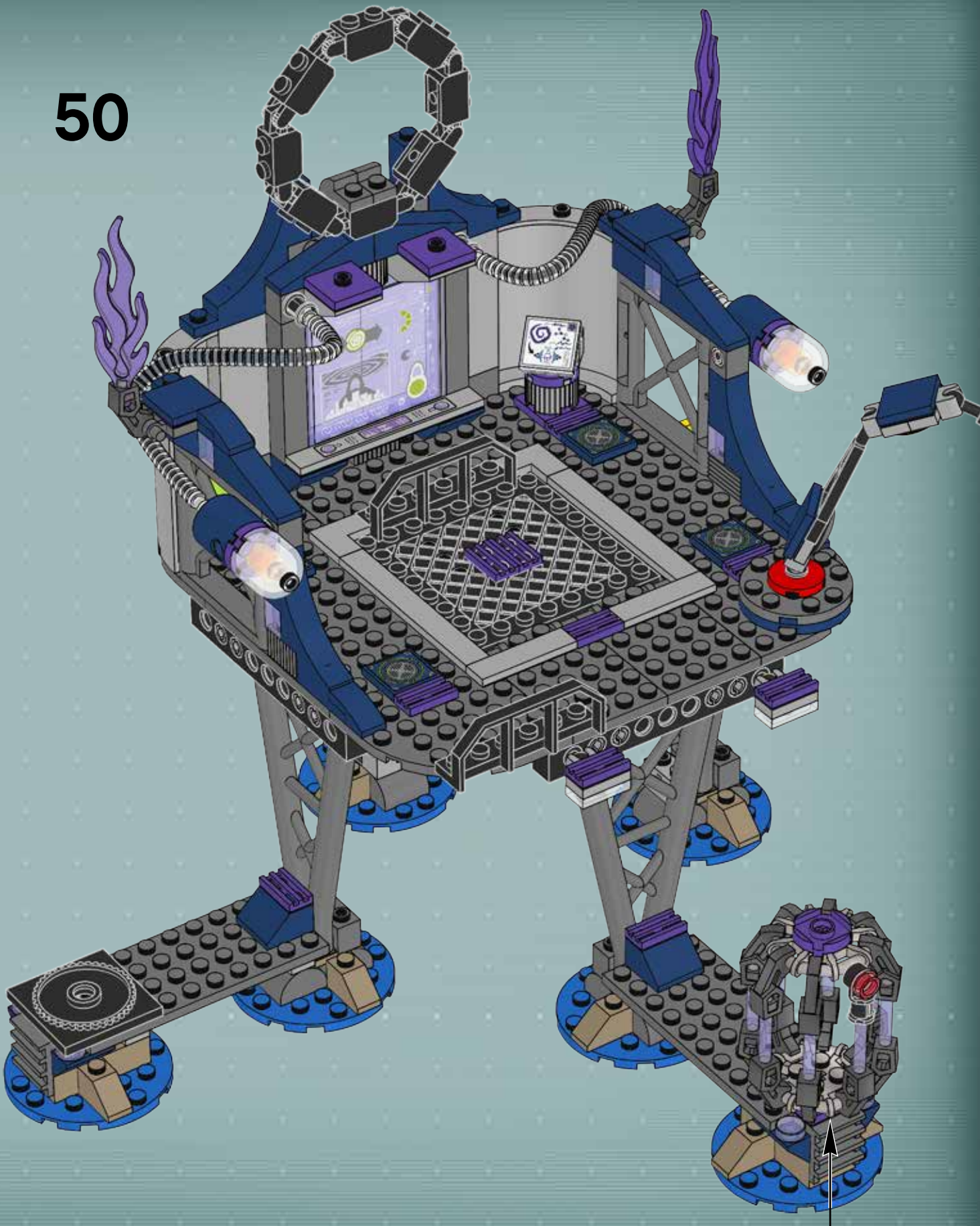



1x

1

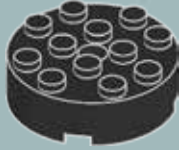

2x

2



2x



2x

3

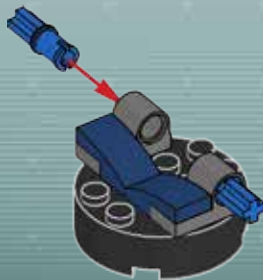

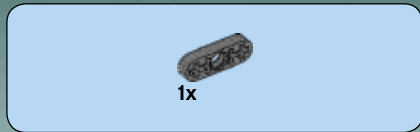

4

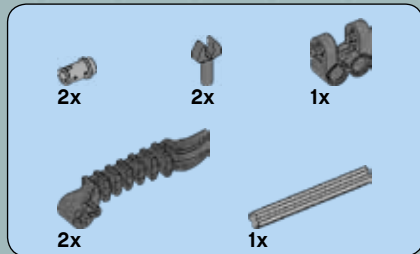
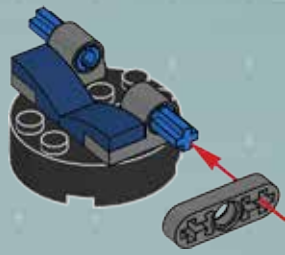

5

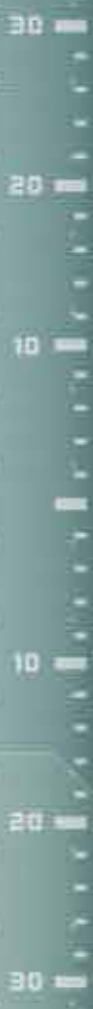
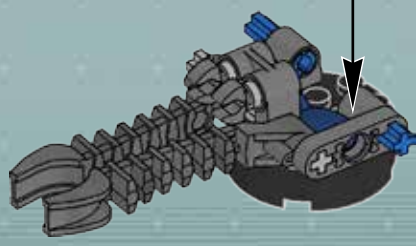
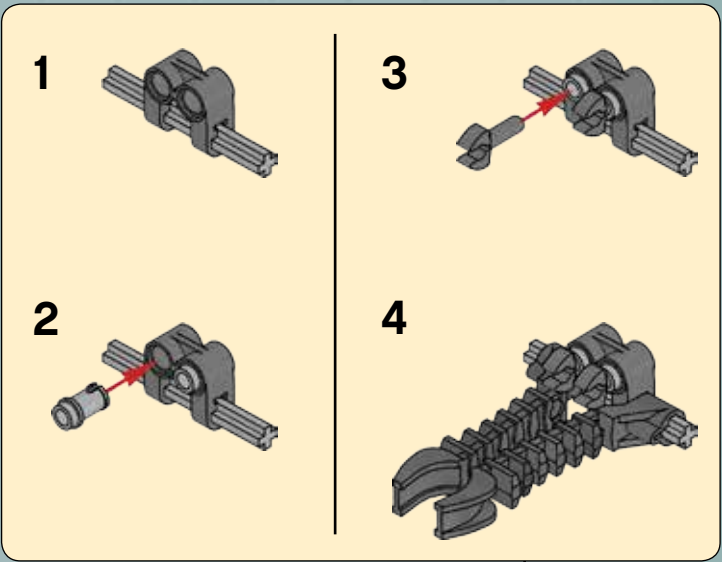



1x

6

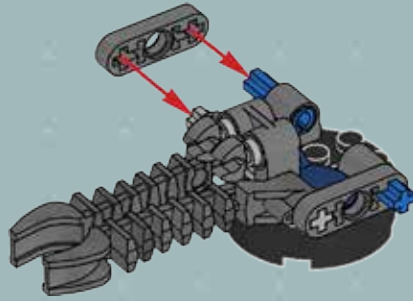

2x

7

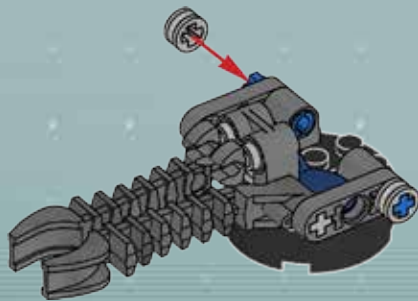

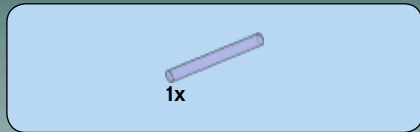

8

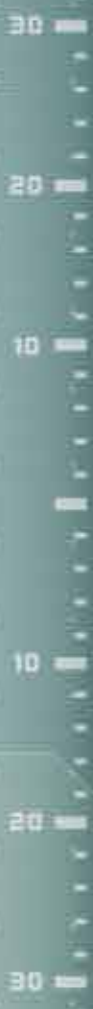
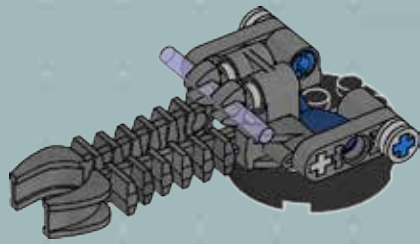

9

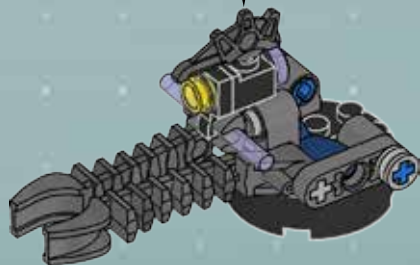

51

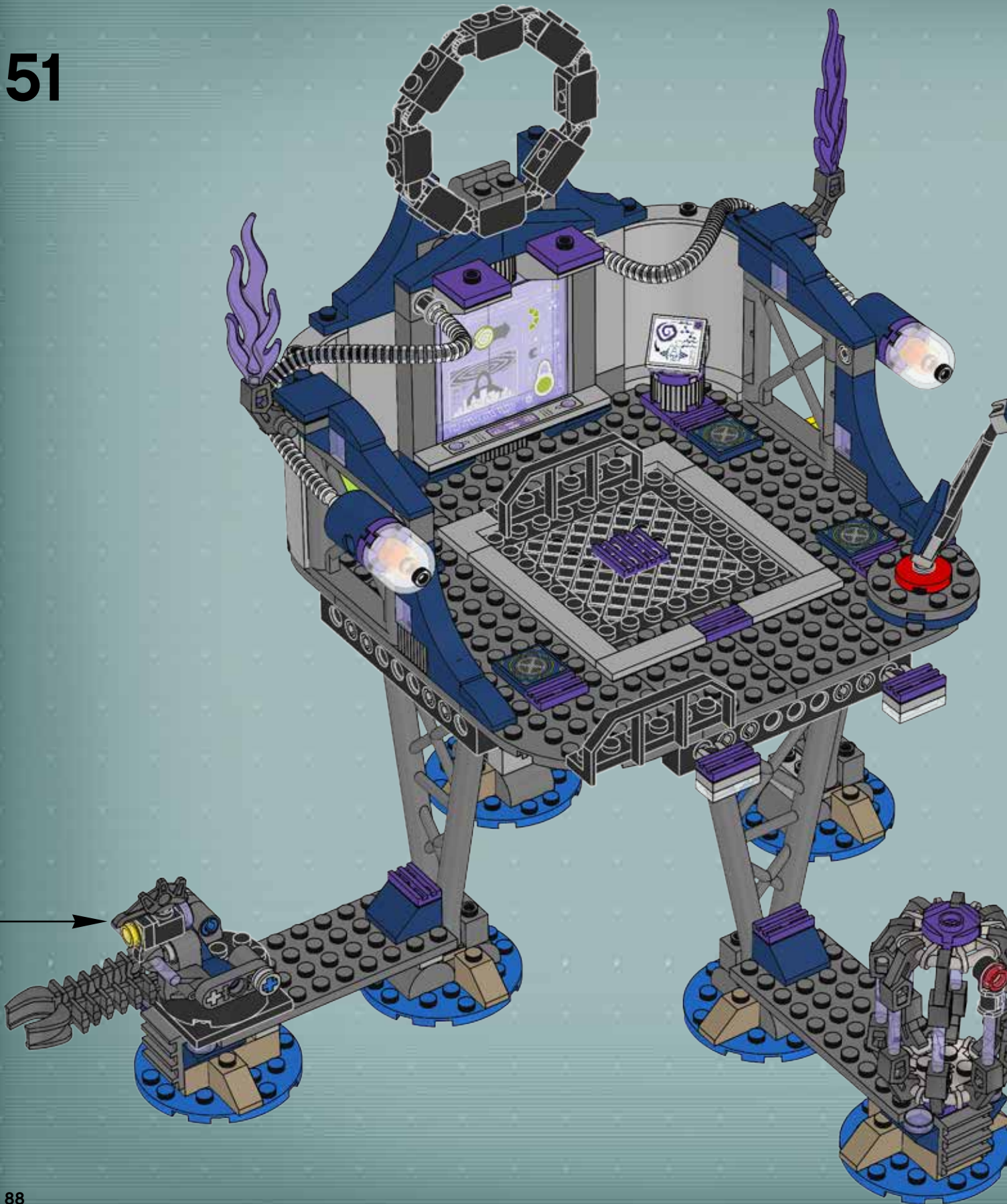





2x



2x



2x



# 52

1



2



3



2x

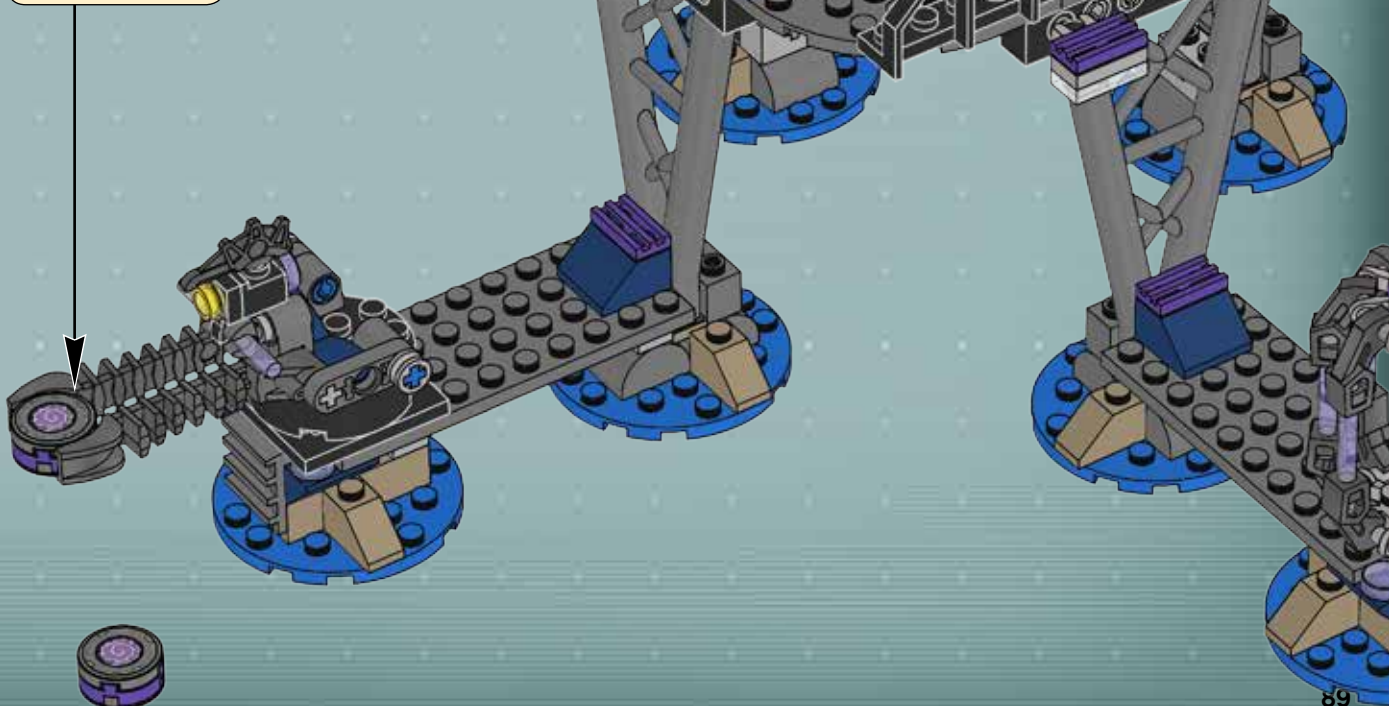

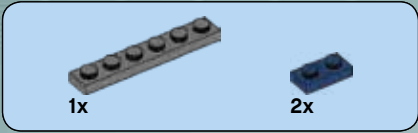

1

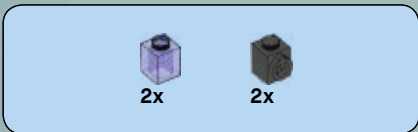
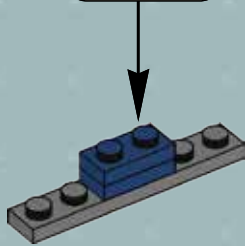
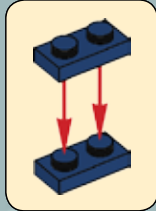

2

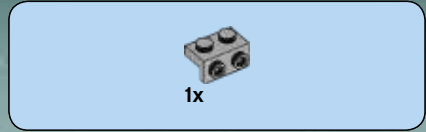
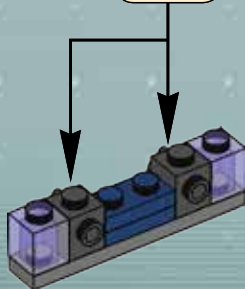

3



4

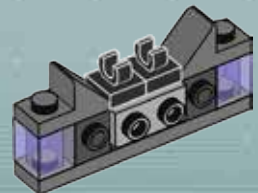



5

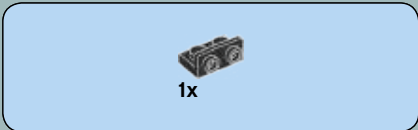
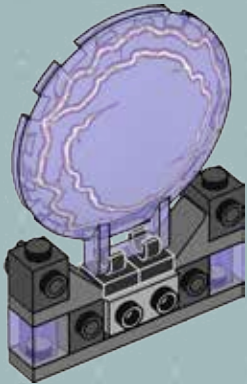

6

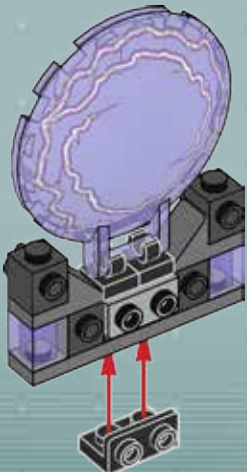

7

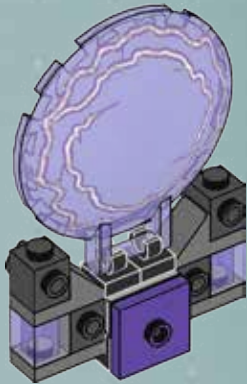



**Download the app and use the AppBrick  
Gadget to complete the mission!**

**Télécharge l'appli et utilise le gadget  
AppliBrique pour réussir la mission !**

**¡Descarga la app y usa el AppBrick  
para completar la misión!**



Apple, the Apple logo, iPad, iPhone and iPod touch are trademarks of Apple Inc.  
Apple, le logo Apple, iPad, iPhone et iPod touch sont des marques de commerce d'Apple Inc.  
Apple, el logotipo de Apple, iPad, iPhone e iPod touch son marcas comerciales de Apple Inc.

Google Play is a trademark of Google Inc.  
Google Play est une marque de commerce de Google Inc.  
Google Play es una marca comercial de Google Inc.

**Unlock the secrets  
with the new AppBrick Gadgets**

**Découvre les secrets avec les  
nouveaux gadgets AppliBrique**

**Descubre los secretos  
con los nuevos AppBricks**





# ULTRA AGENTS



70166



70171



70167



70172



70168



70169



70173



70170

**LEGO** *TECHNIC*



42037





42036



42033



42034

- 1x 3005744
- 1x 6104584
- 1x 6081908
- 5x 4519010
- 1x 4114309
- 12x 4530678
- 4x 4496699
- 2x 6031821
- 2x 4247145
- 4x 4222960
- 1x 6097148
- 2x 4153989
- 1x 4654448
- 1x 6102138
- 1x 4227155
- 13x 4142865
- 1x 4140806
- 1x 4544720
- 1x 3005741
- 1x 4625528
- 6x 6094143
- 2x 4528981
- 9x 4205004
- 2x 6079020
- 2x 4153653
- 8x 6025375
- 3x 4502089
- 4x 6101304
- 1x 6108550
- 4x 6103771
- 2x 6070757
- 1x 6097642
- 1x 4267425
- 2x 6051918
- 4x 6022171
- 1x 4581214
- 1x 6097145
- 1x 6103865
- 1x 6019162
- 1x 6083816
- 1x 4279734
- 1x 4527943
- 7x 4206482
- 6x 6096711
- 4x 389523
- 11x 4655690
- 6x 4659770
- 9x 6030534
- 2x 6118801
- 1x 6103301
- 5x 6065505
- 6x 6066120
- 1x 6104175
- 9x 4544069
- 1x 6104171
- 1x 6096709
- 1x 6118903
- 1x 4140626
- 1x 4121932
- 1x 608101
- 1x 6104200
- 1x 4565324
- 1x 243101
- 2x 4538353
- 1x 6061024
- 1x 6081466
- 1x 6076599
- 1x 4208160
- 2x 6100932
- 1x 6079760
- 2x 4167842
- 7x 4278412
- 2x 4113949
- 1x 6006525
- 1x 4211469
- 2x 4563045
- 2x 4211573
- 2x 4211483
- 1x 4211375
- 8x 4211888
- 6x 6043656
- 1x 4515341
- 3x 4654582
- 1x 6057616
- 2x 4650645
- 6x 4233493
- 1x 6119152
- 1x 6075237
- 1x 4211760
- 2x 4211475
- 1x 6119165
- 2x 6065824
- 2x 4211356
- 2x 4211570
- 1x 4211639
- 1x 4211805
- 3x 4211481
- 1x 4211498
- 1x 4211640
- 2x 4527174
- 2x 4631286
- 4x 4648252
- 2x 4542618
- 1x 4603472
- 2x 4499858

5

7

8

1x  
4211081

2x  
4289542

1x  
6051334

1x  
4579354

2x  
6019987

1x  
4611703

2x  
4210660

1x  
4521187

2x  
6069164

2x  
4210797

8x  
4211093

6x  
4210639

4x  
4211111

2x  
4223767

1x  
4234599

5x  
4210636

2x  
4603504

2x  
6056296

5x  
4278274

1x  
4528323

2x  
4210690

1x  
4211043

1x  
4211056

1x  
6048898

1x  
4210917

2x  
4595710

4x  
4500517

3x  
4210794

2x  
4211122

1x  
4210798

1x  
4667227

1x  
4209683

4x  
273026

3x  
4184169

1x  
4660886

19x  
4121715

1x  
4107081

1x  
4159335

6x  
6066102

1x  
4517925

1x  
73587

1x  
306226

1x  
407026

1x  
473326

1x  
474026

2x  
6047276

1x  
6020193

2x  
4140801

3x  
6000650

1x  
4124096

1x  
6057397

8x  
4167106

2x  
370026

2x  
428626

1x  
6021504

1x  
6083498

1x  
6104167

1x  
6104618

1x  
6081911

1x  
6104165

1x  
383526

1x  
6043130

1x  
4550922

1x  
4558957

2x  
4274405

1x  
6081988

1x  
256926

1x  
6123924

1x  
4517986

2x  
658326

4x  
4529549

1x  
4541984

4x  
6103777

1x  
6117777

2x  
4619636

3x  
6020990

1x  
6119446

1x  
6122111

17x  
6008484

3x  
4625376

3x  
6103924

2x  
6021670

Customer Service

Kundenservice

Service Consommateurs

Servicio Al Consumidor

LEGO.com/service or dial



: 00800 5346 5555

: 1-800-422-5346