



# ULTRA AGENTS

70170



 LEGO.com

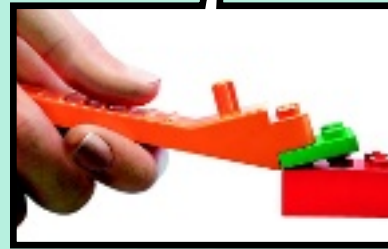
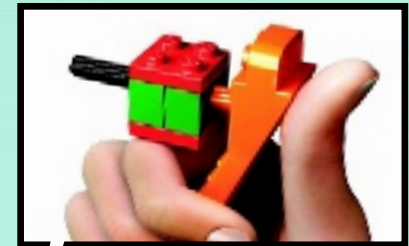

[LEGO.com/brickseparator](https://LEGO.com/brickseparator)

IMPORTANT: Never modify the elements or use other projectiles than provided with this toy.  
IMPORTANT : Ne jamais modifier les éléments ni utiliser d'autres projectiles que ceux fournis avec ce jouet.  
2 IMPORTANTE: No modifique los elementos ni utilice otros proyectiles diferentes a los suministrados junto con este juguete.

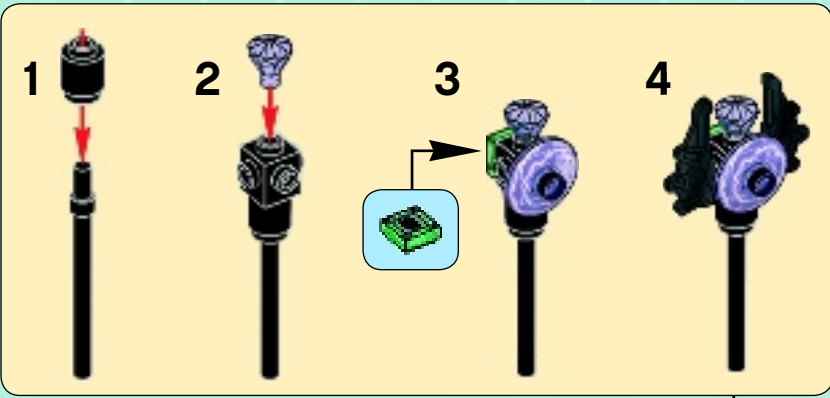
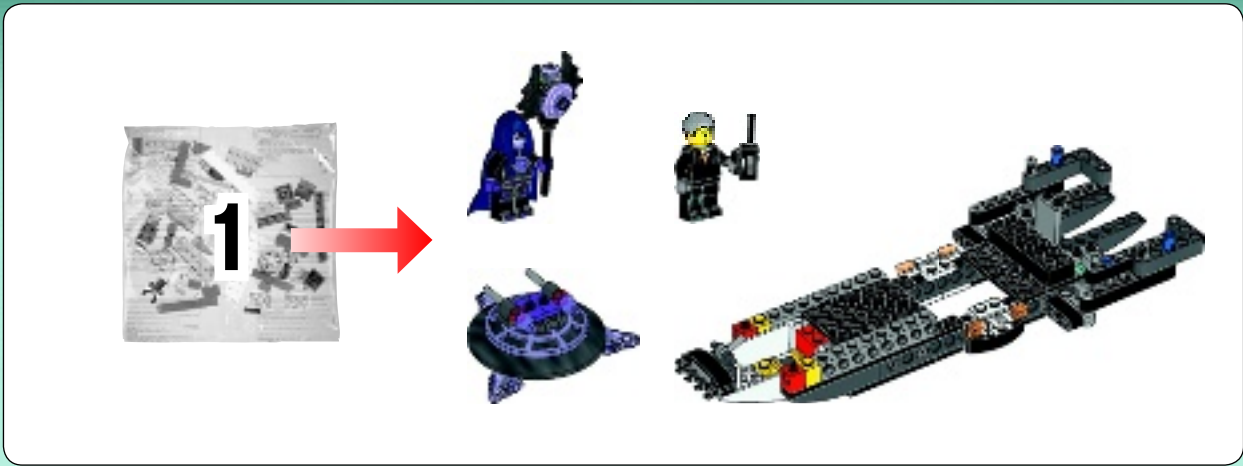



1

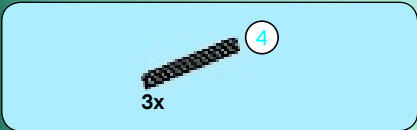

2

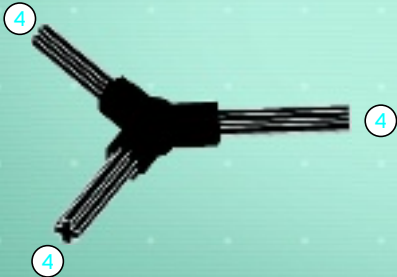

3

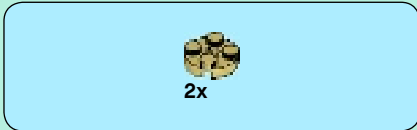
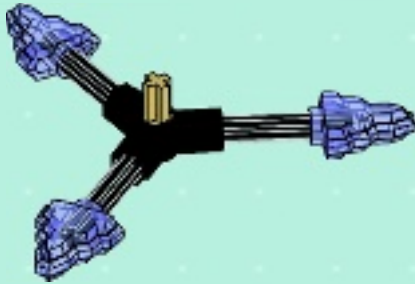

4

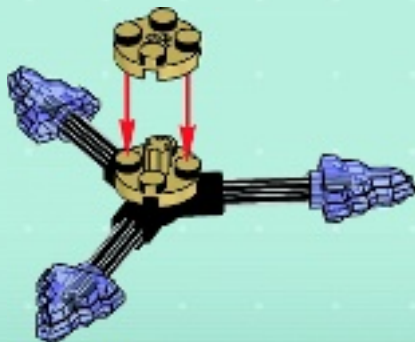

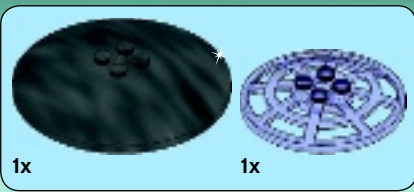

5

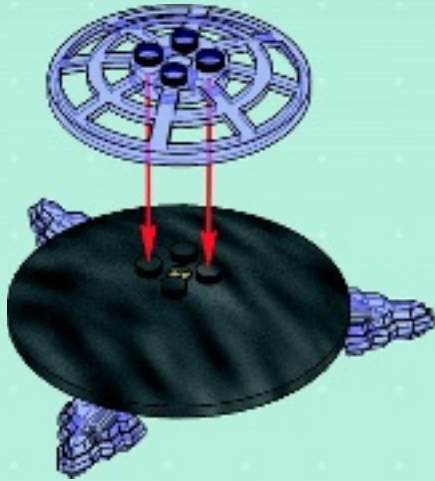

6

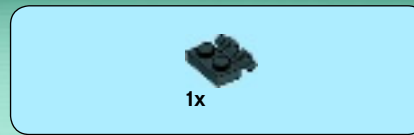

7



8





2x



2x



2x

# 9

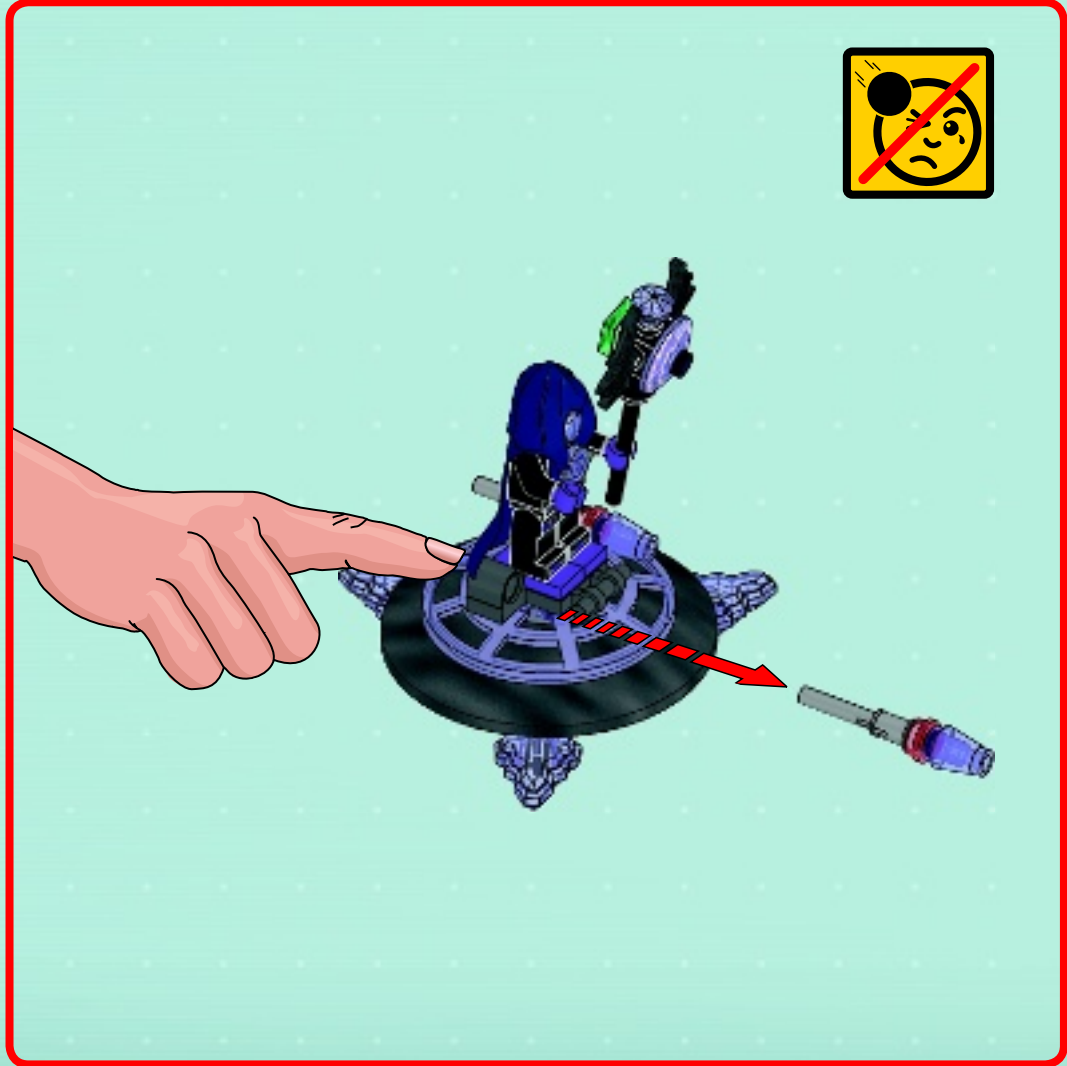
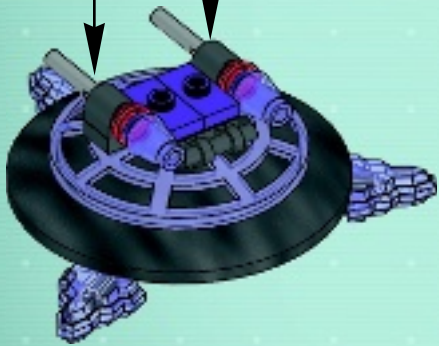

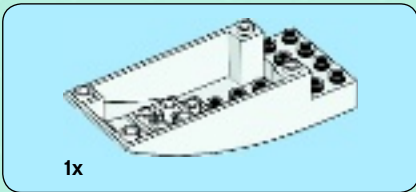

1

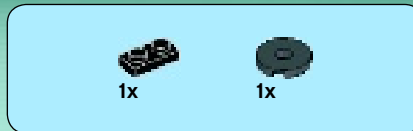
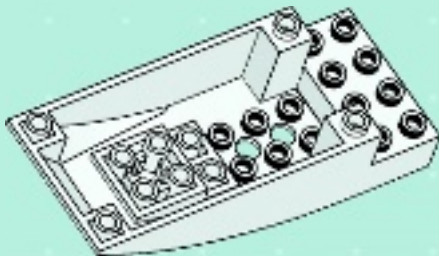

2

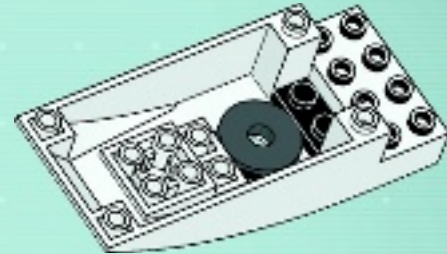

3

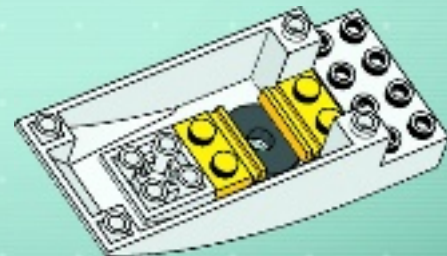

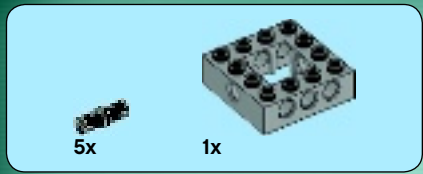

4

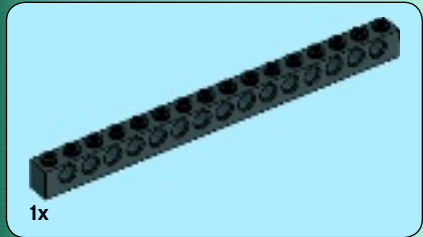
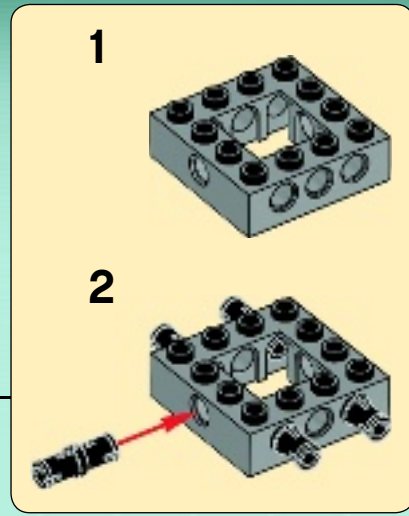
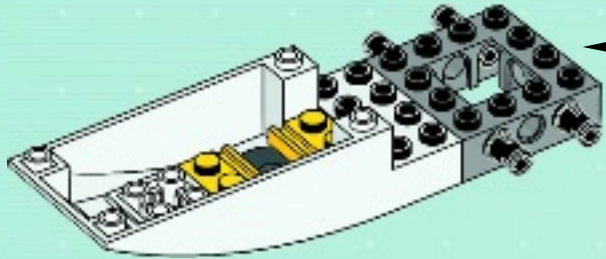

5

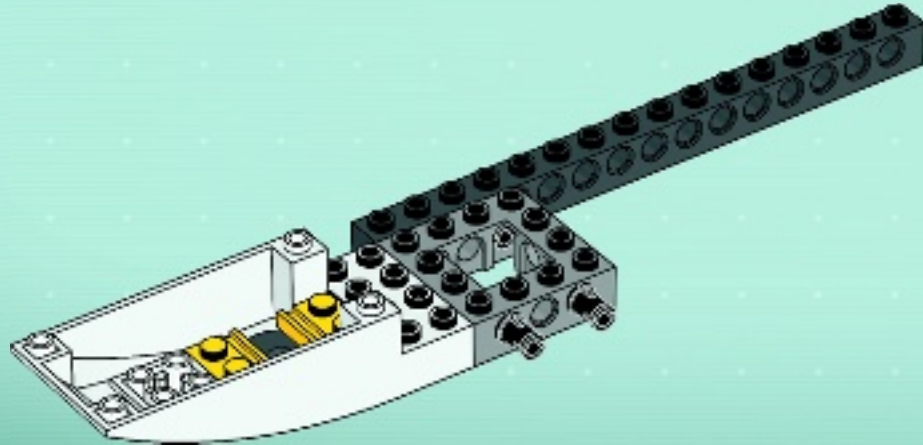



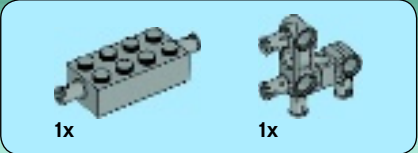

# 6

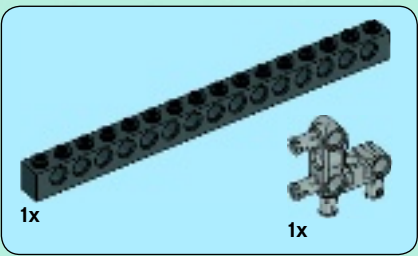
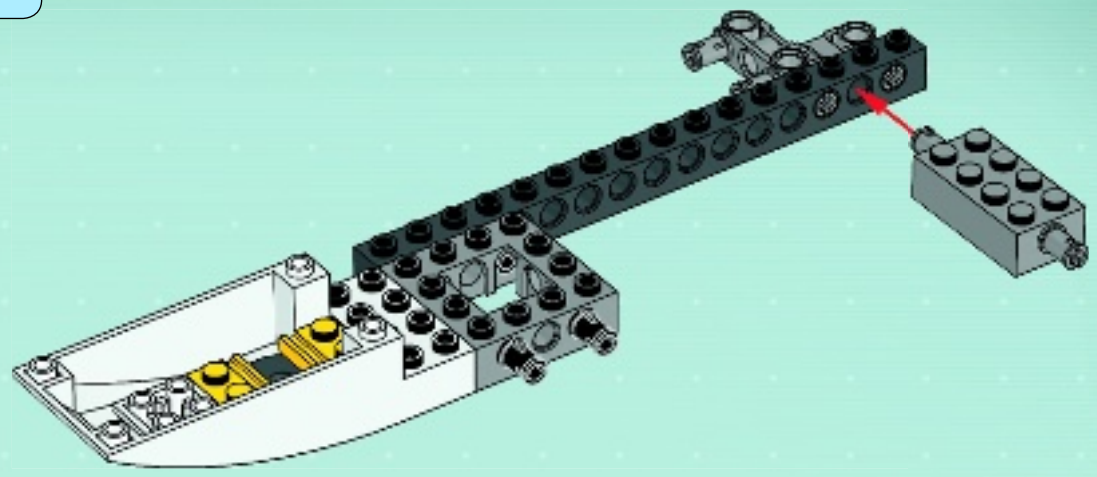

# 7

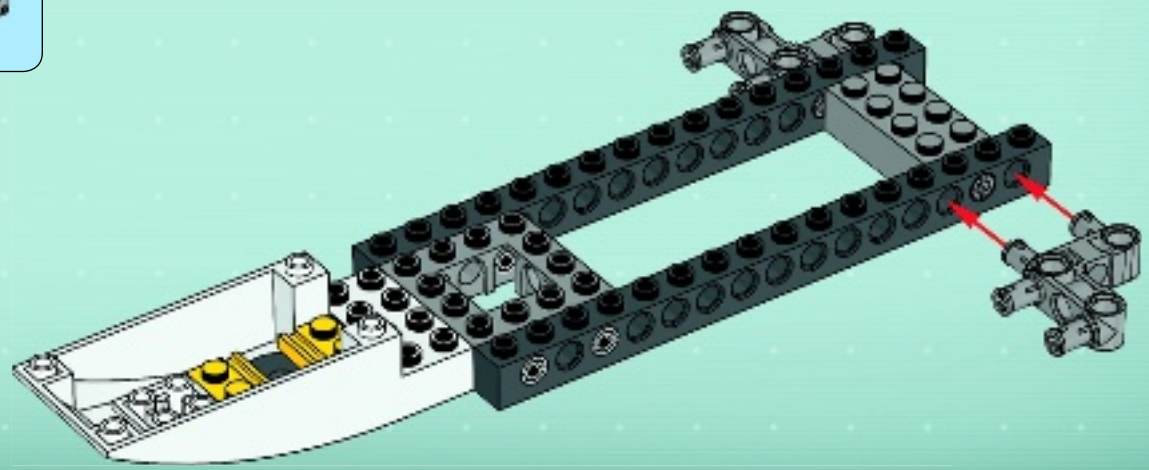



8

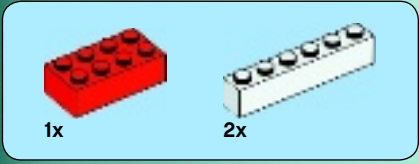
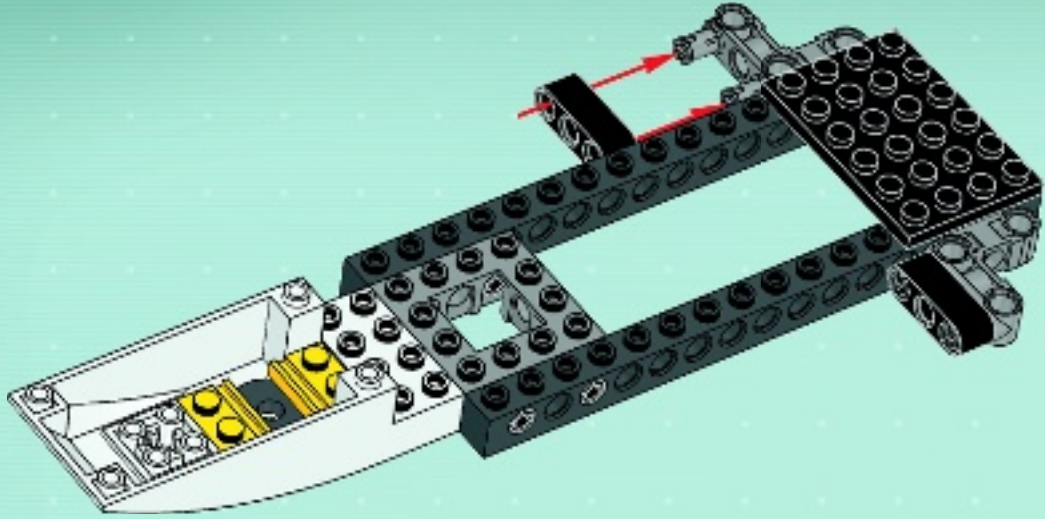

9

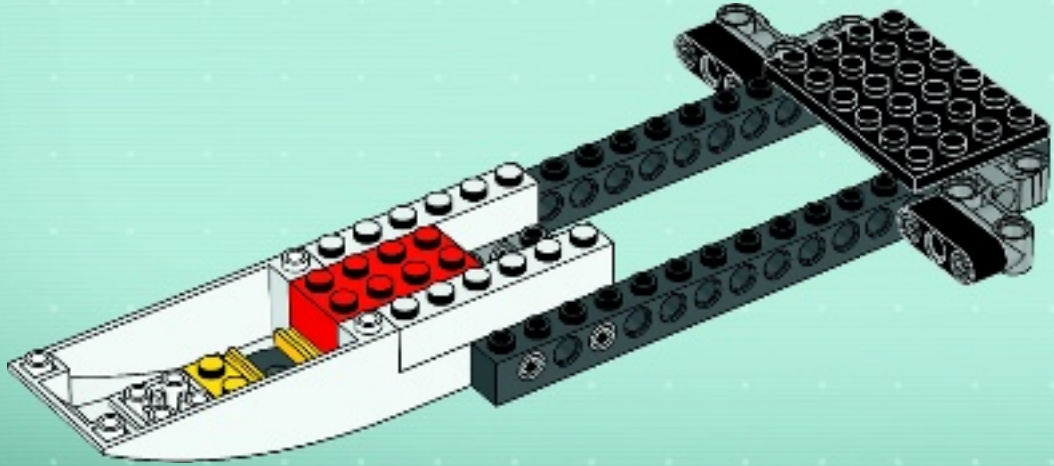



# 10

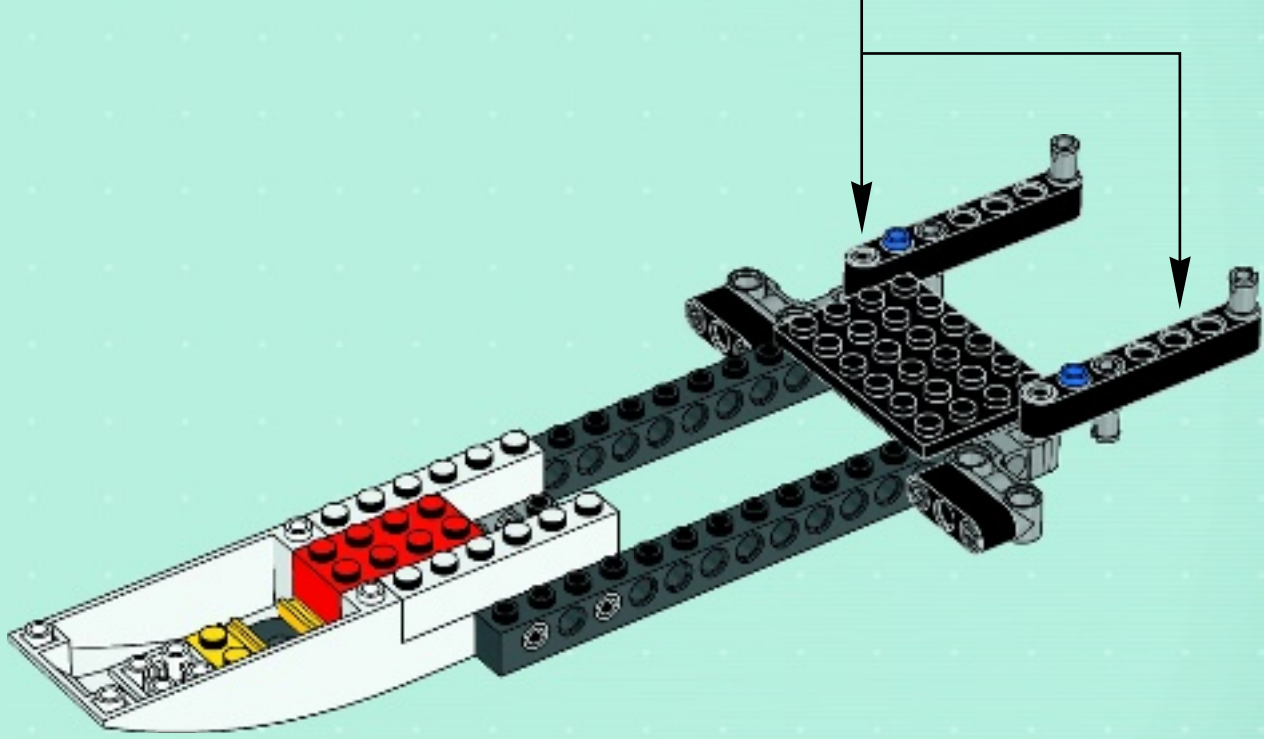
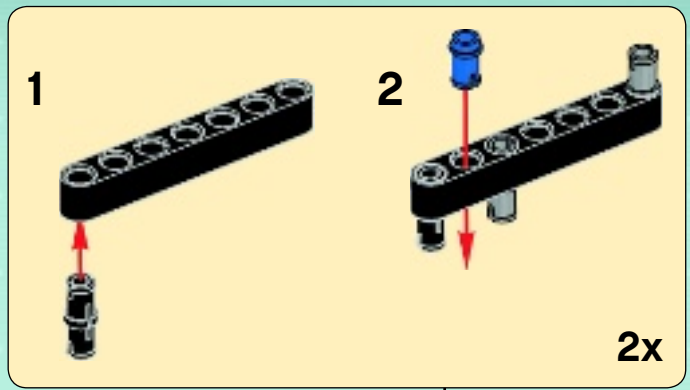

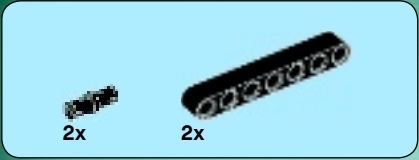

11

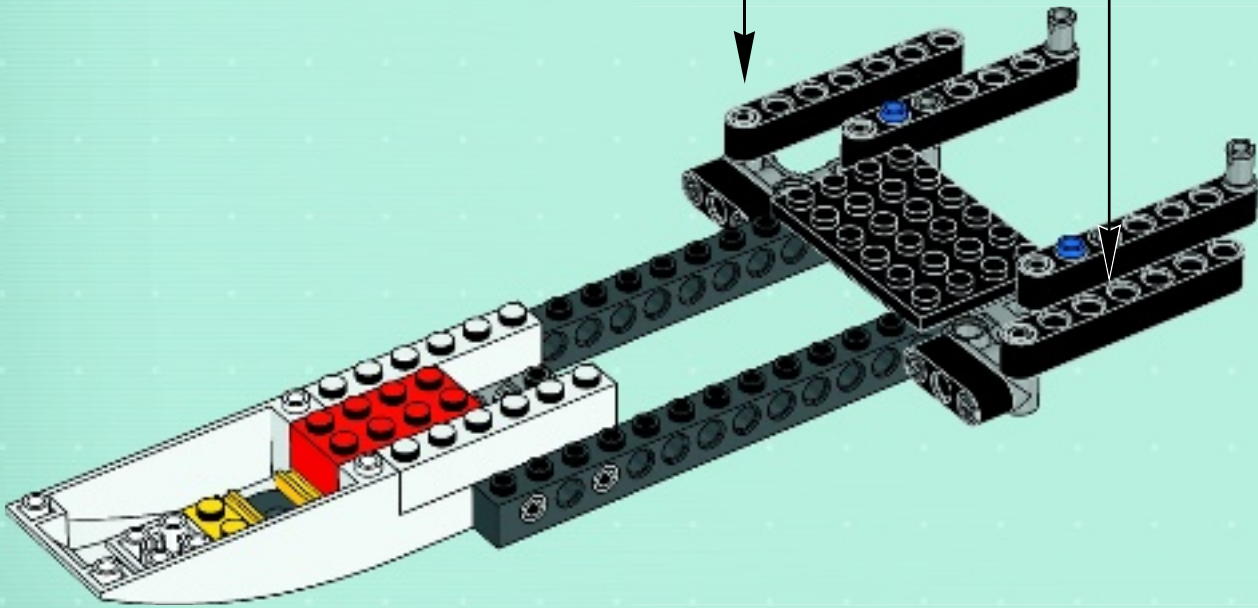
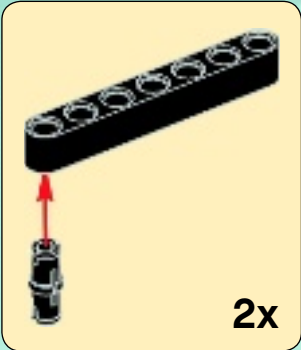



# 12

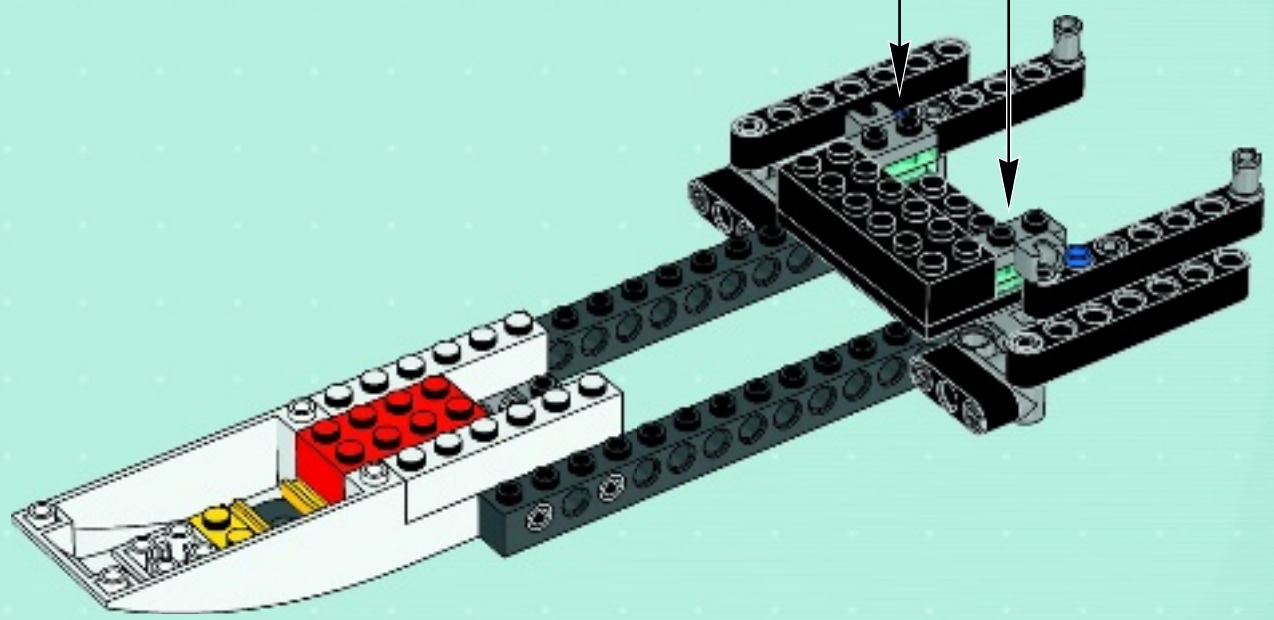
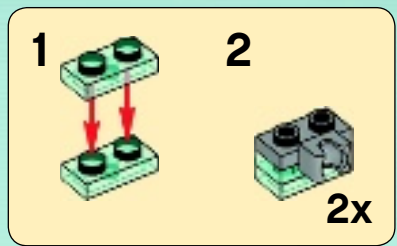

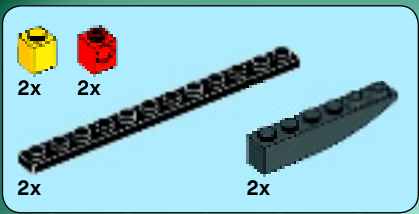

# 13

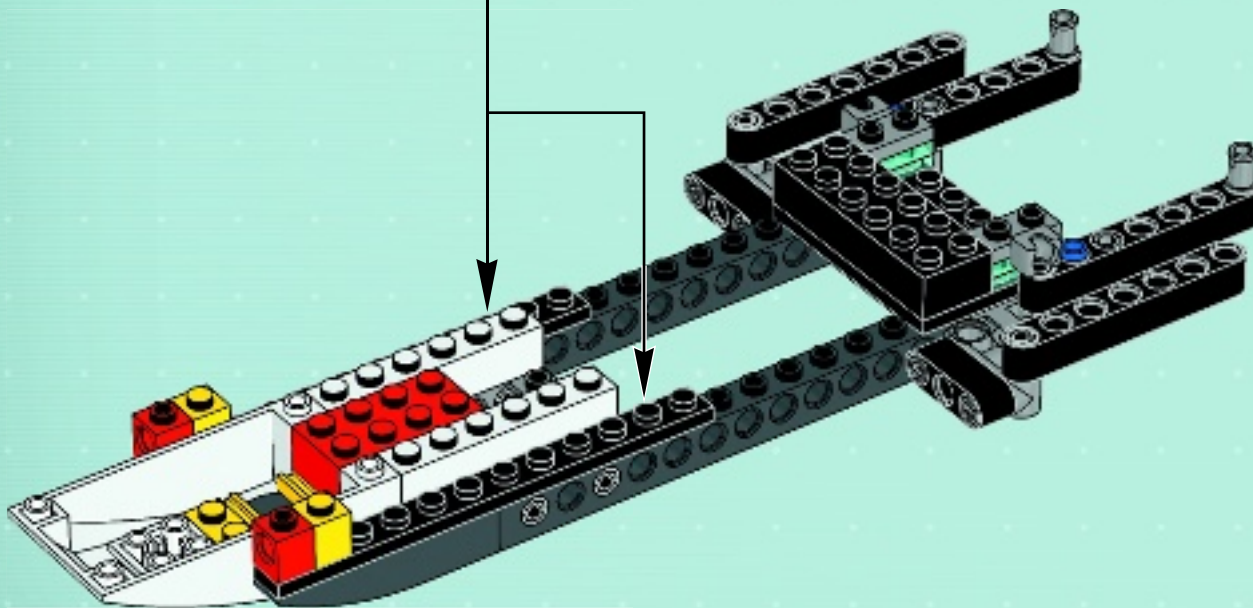
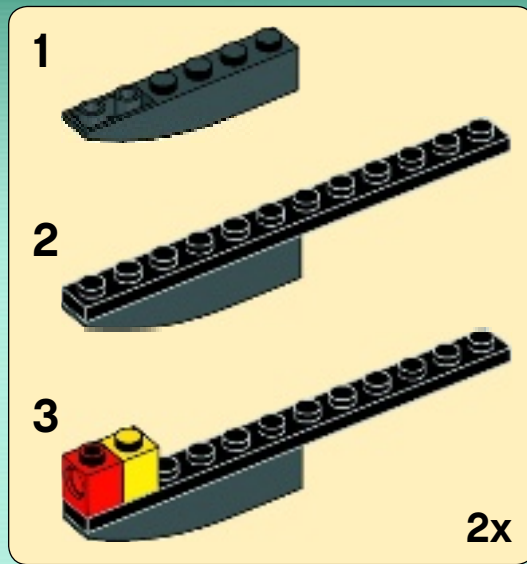



# 14

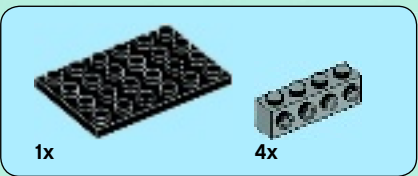
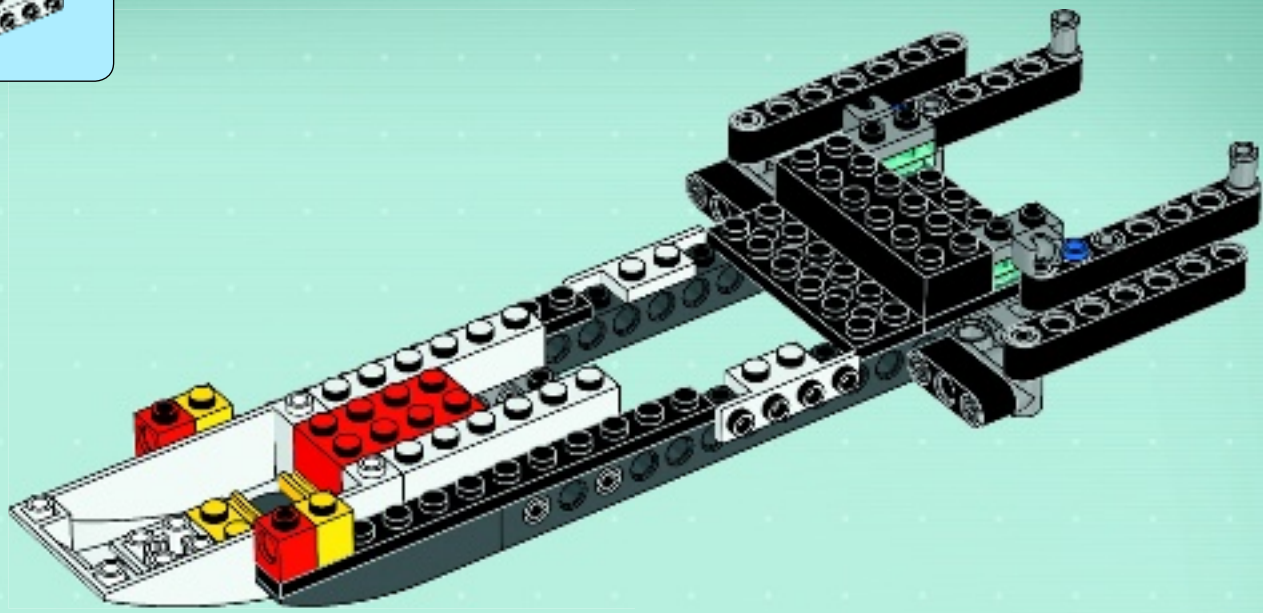

# 15

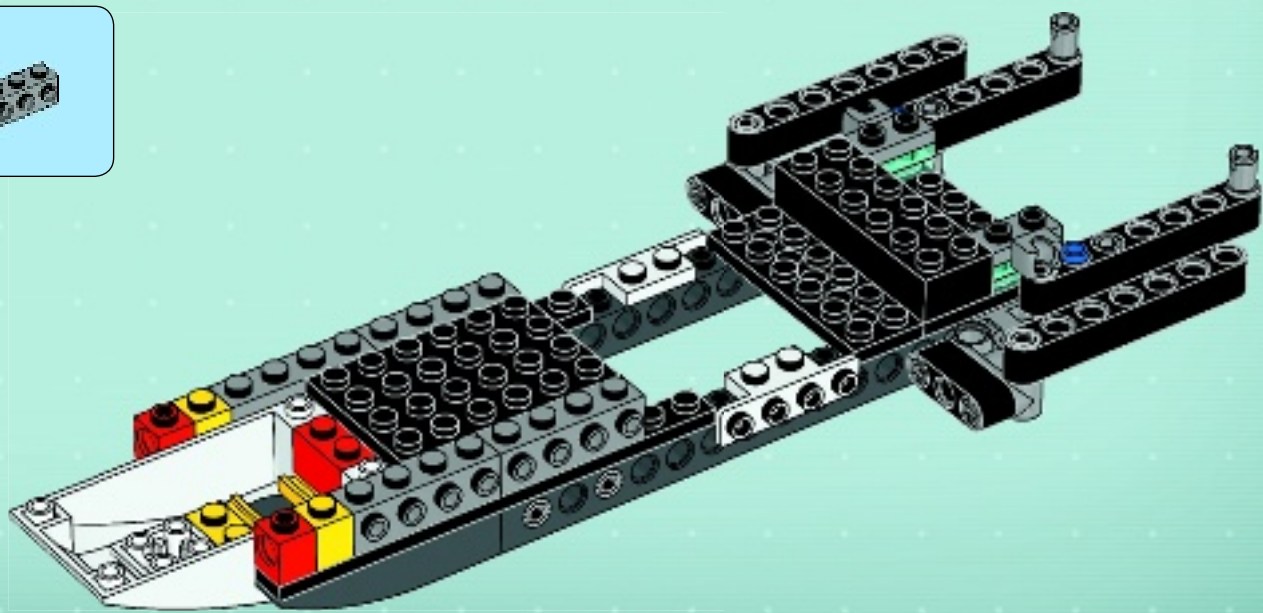

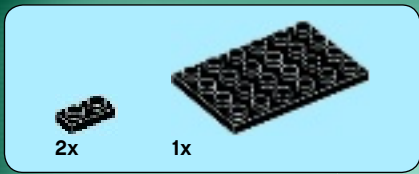

16

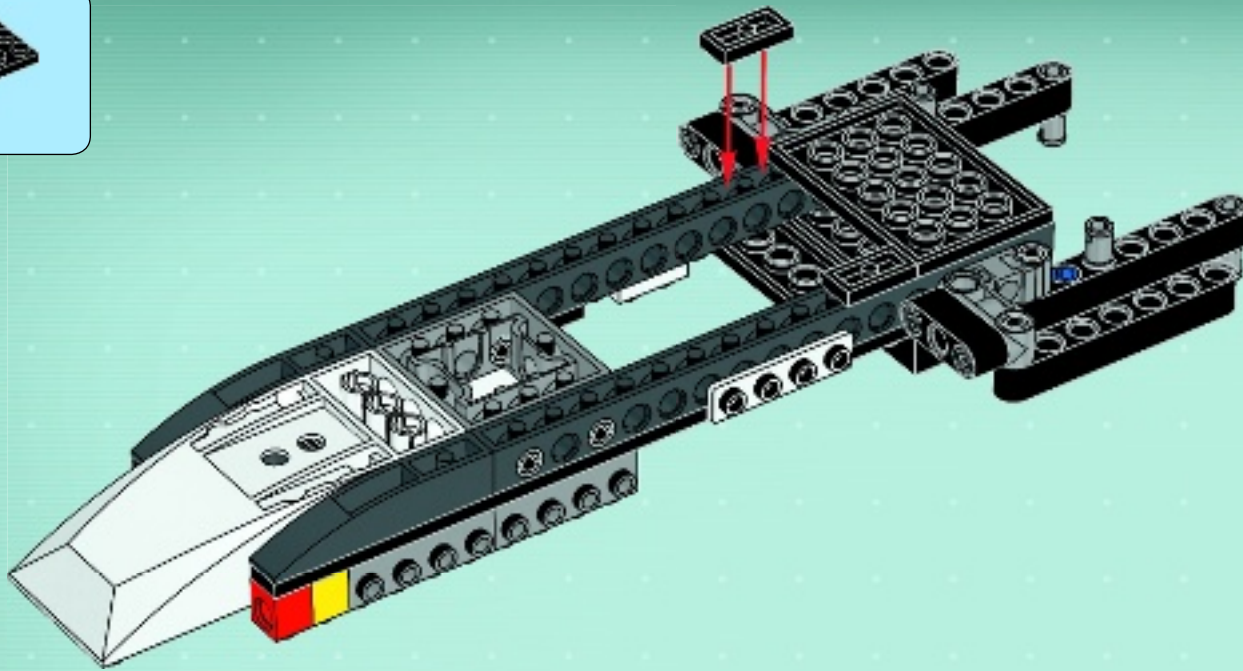

17

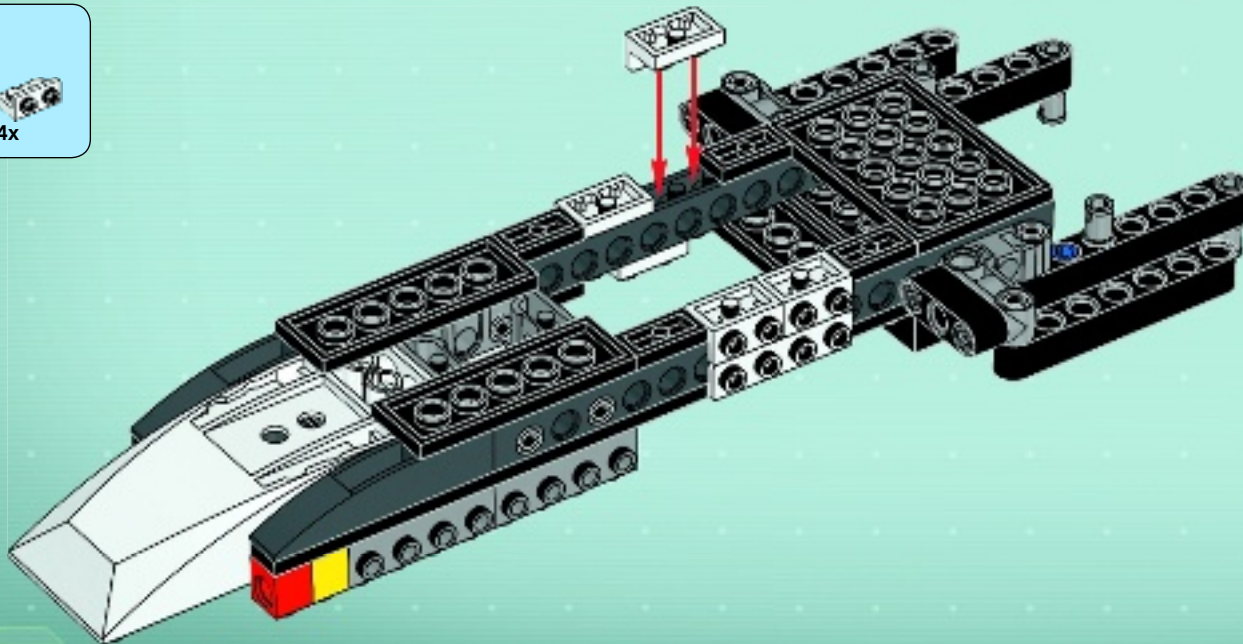



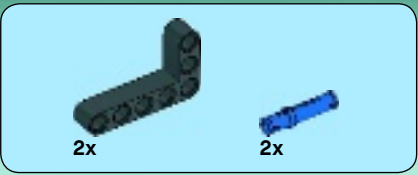

18

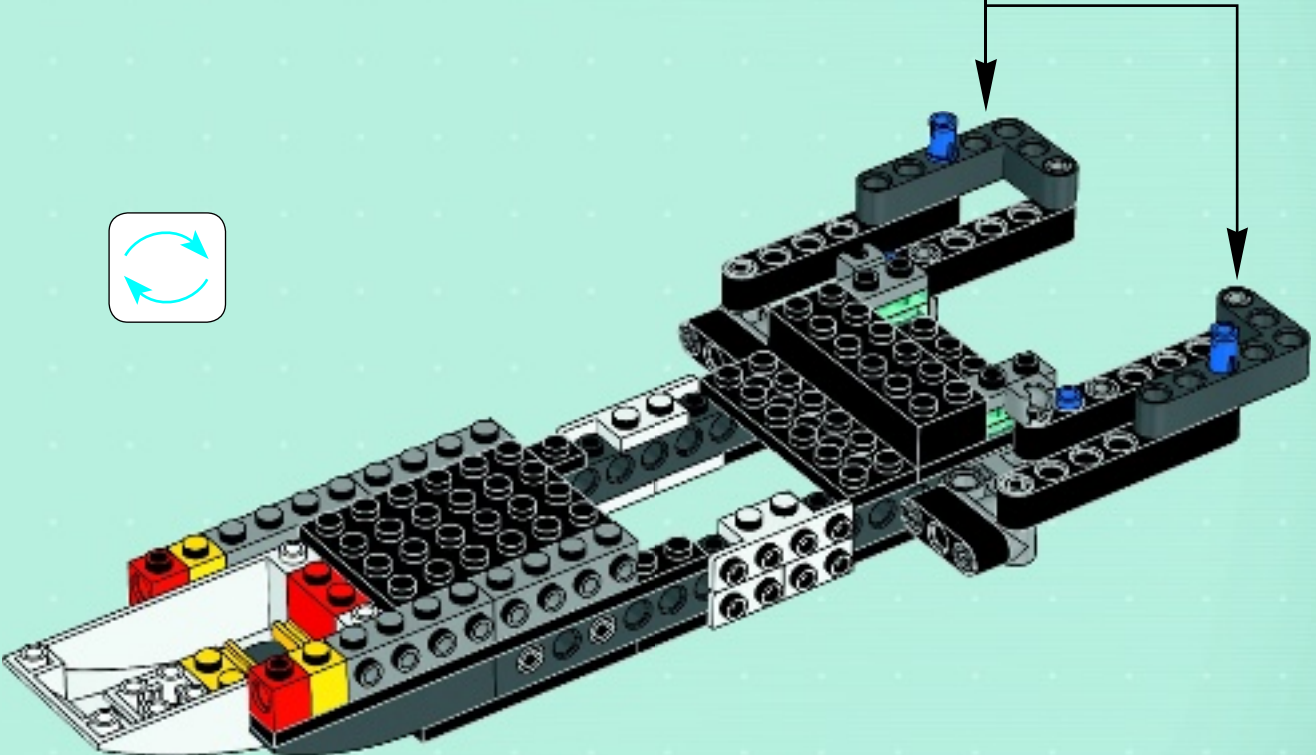
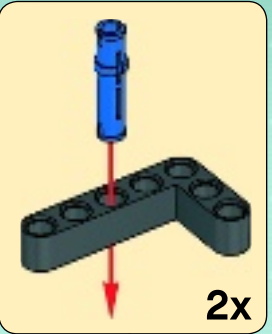

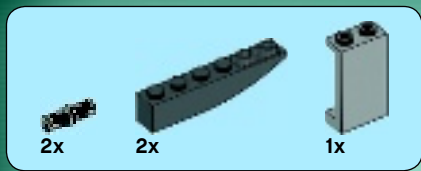

19

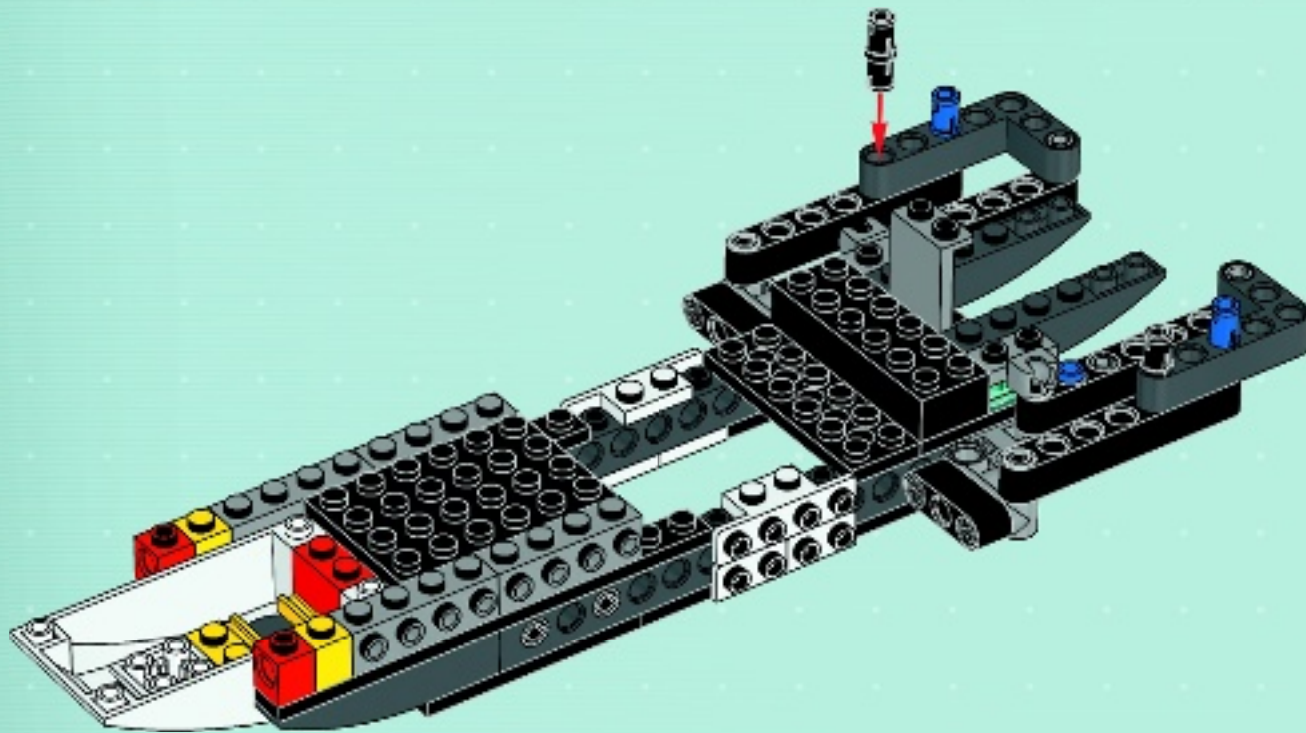

4x 4x 2x

# 20

1 2 2x

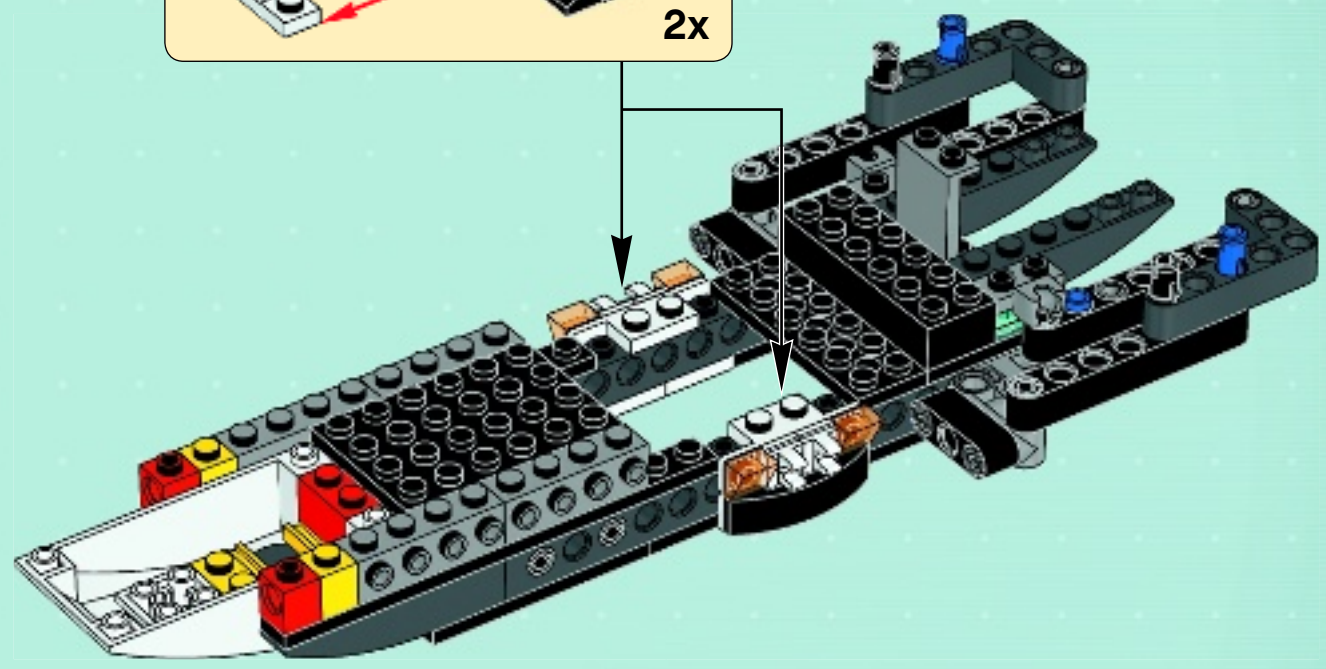



# 21

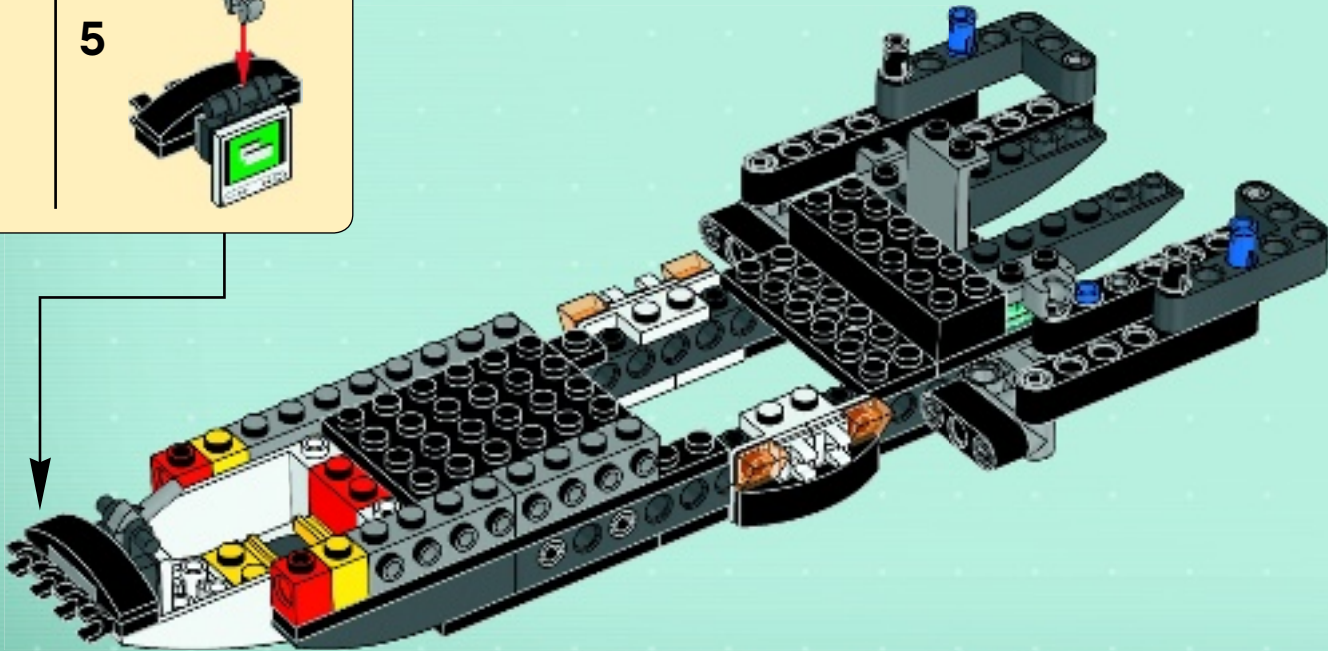
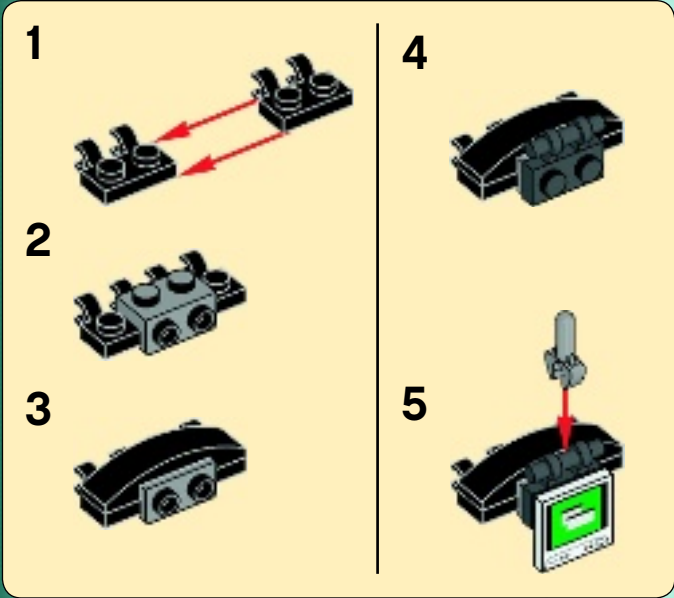

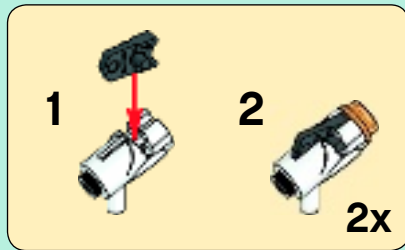
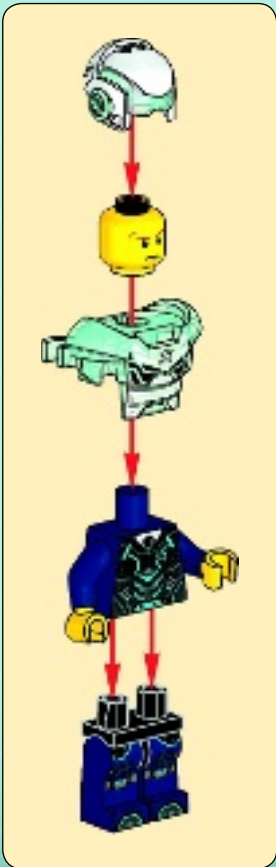
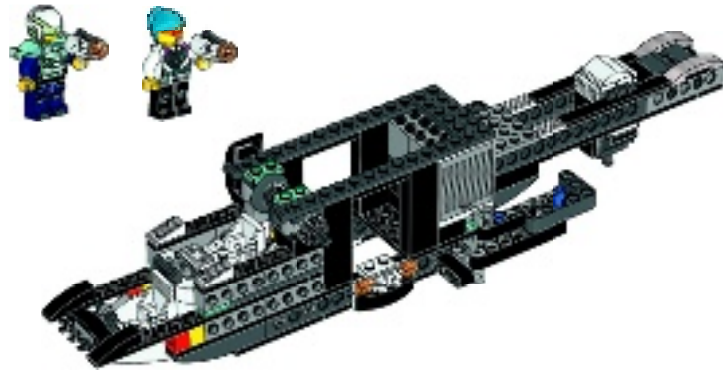



1

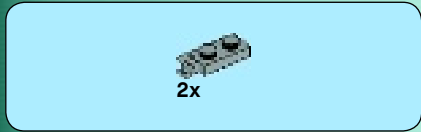

2

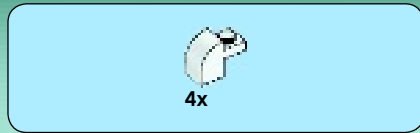

3

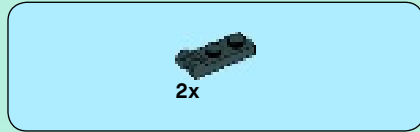
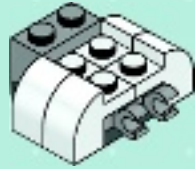

4



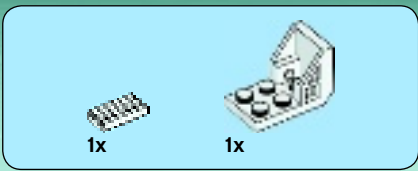

5

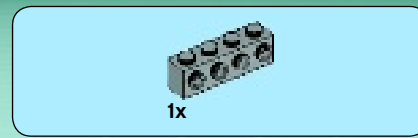

6

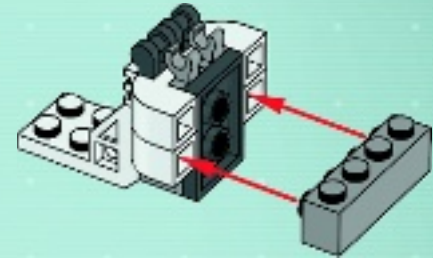
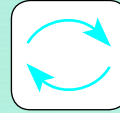

22

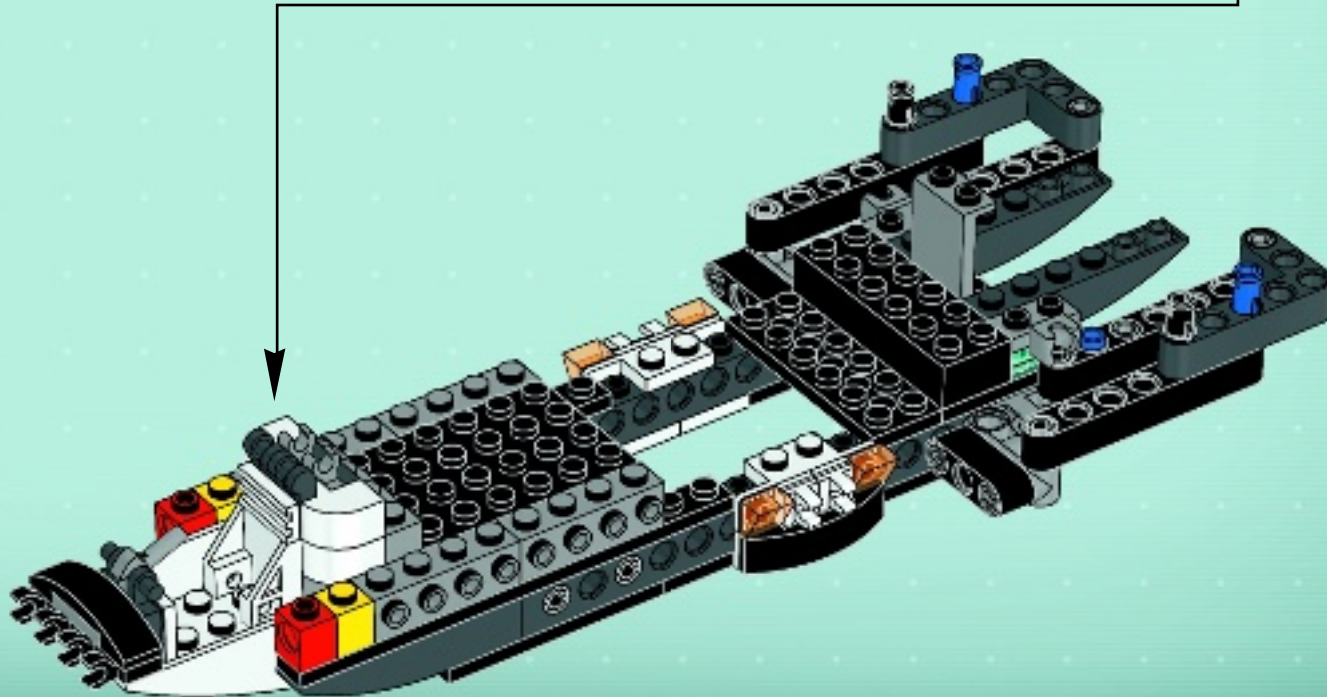

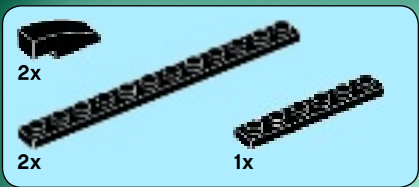

# 23

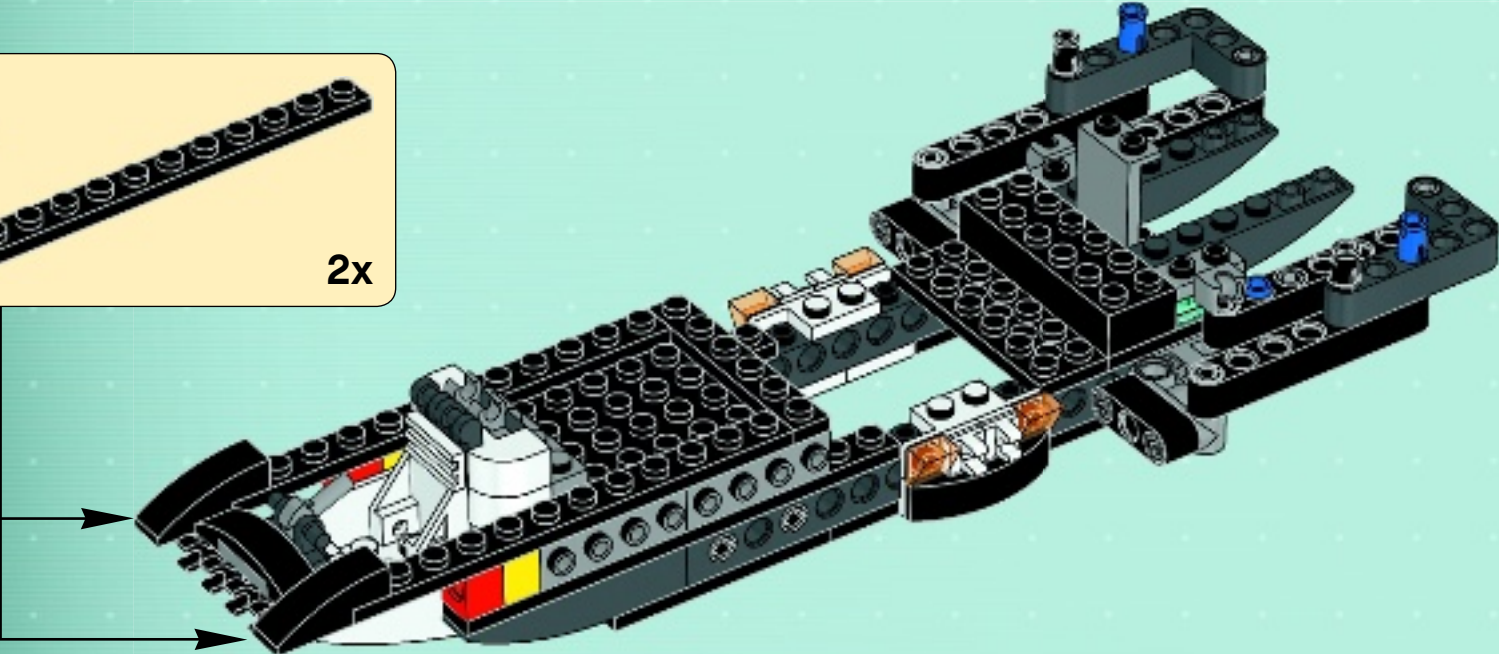
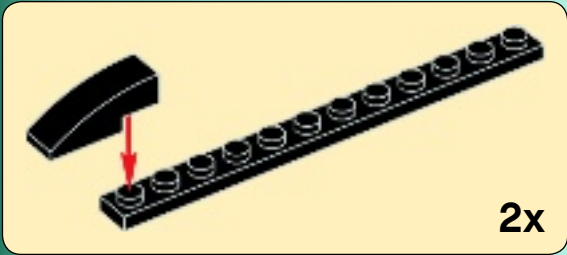





# 24

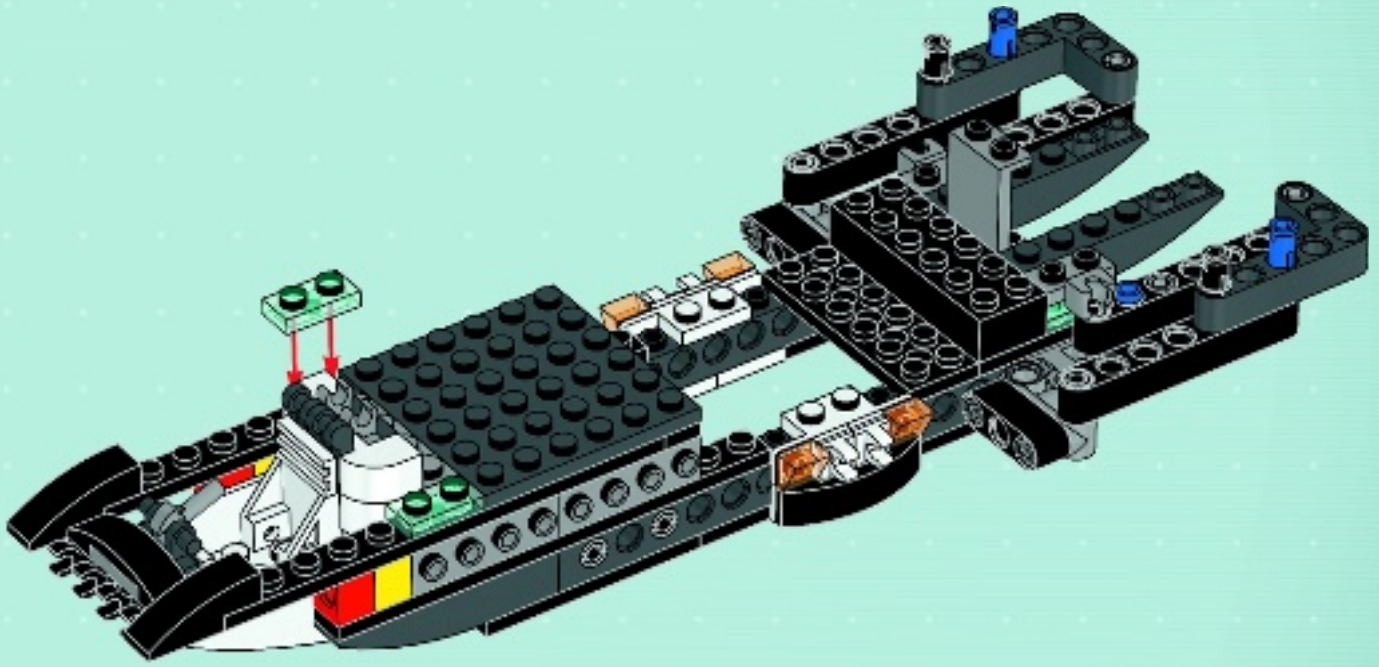



1x



2x



1x

# 25



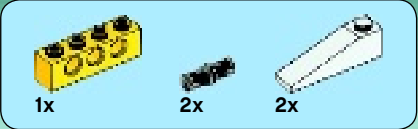

# 26

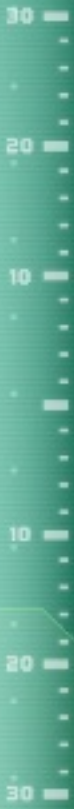
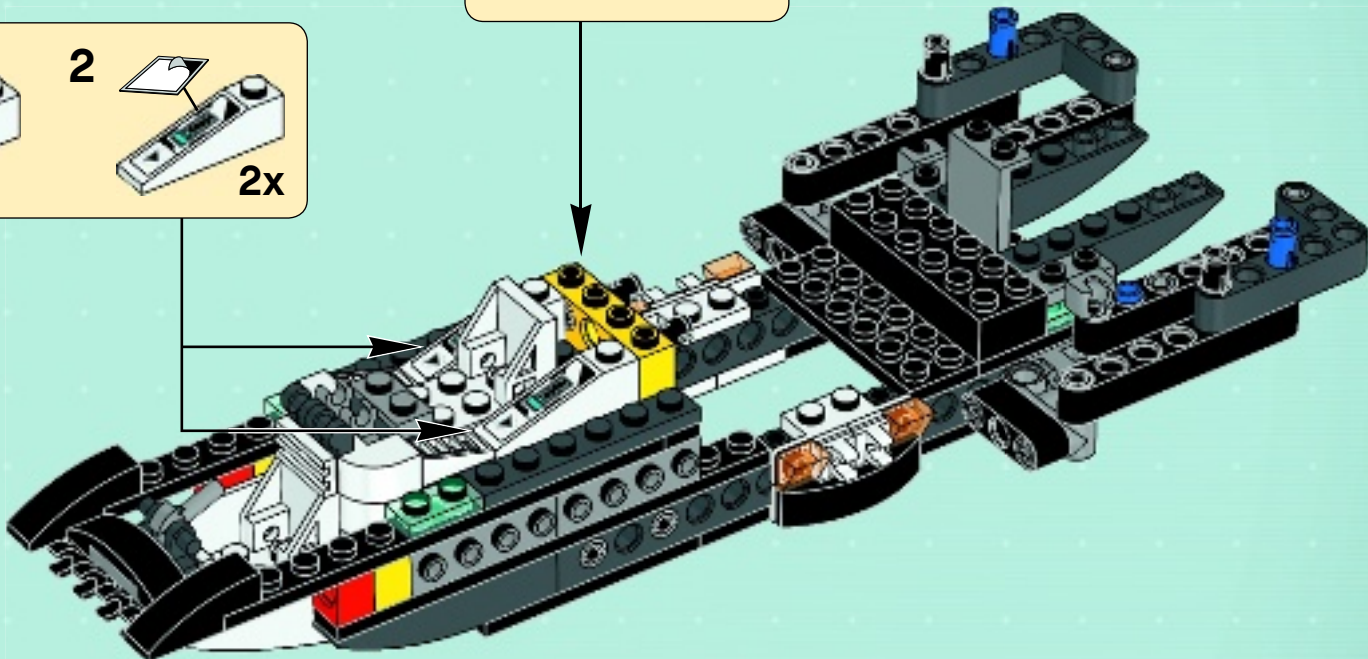
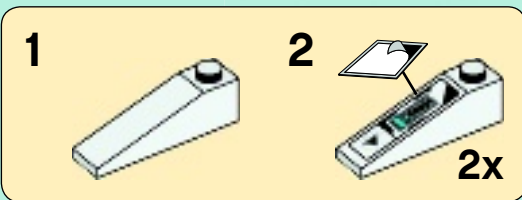
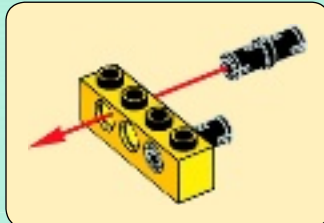



4x

27

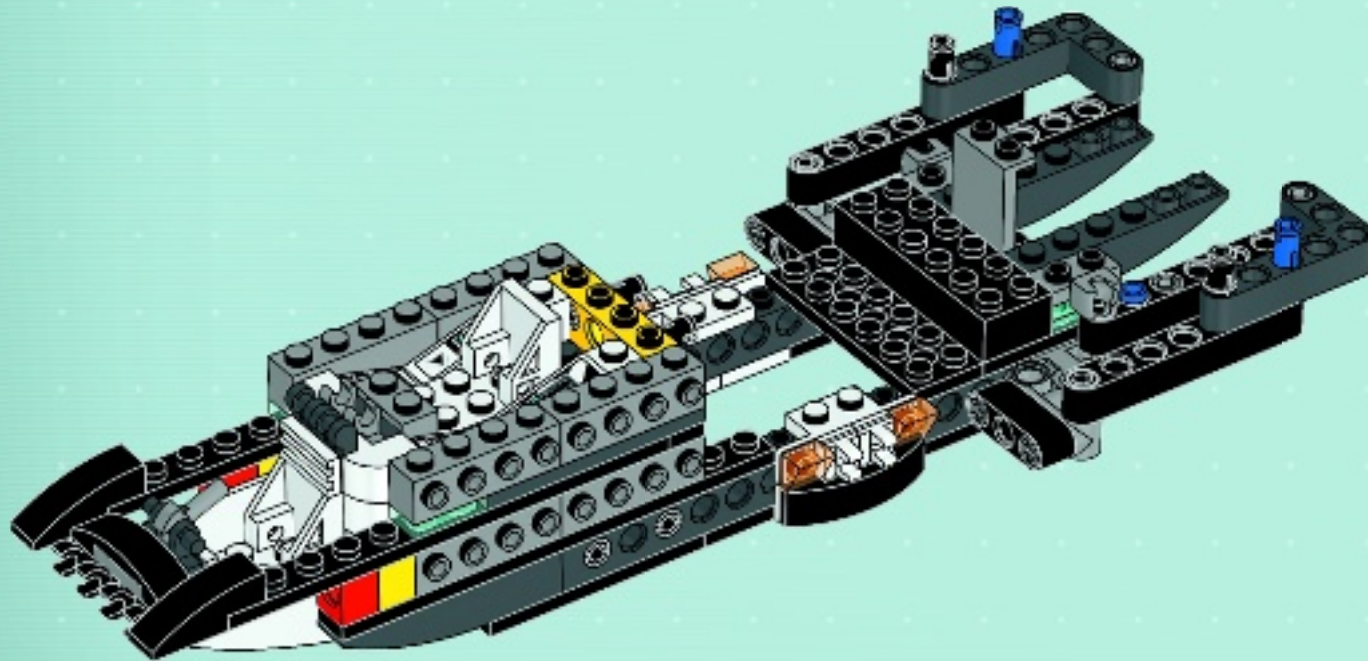

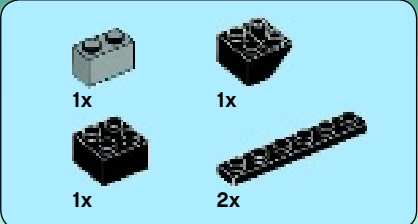

# 28

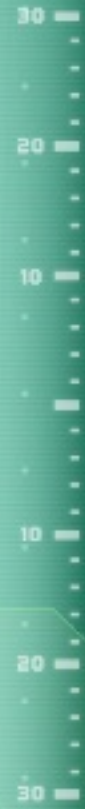
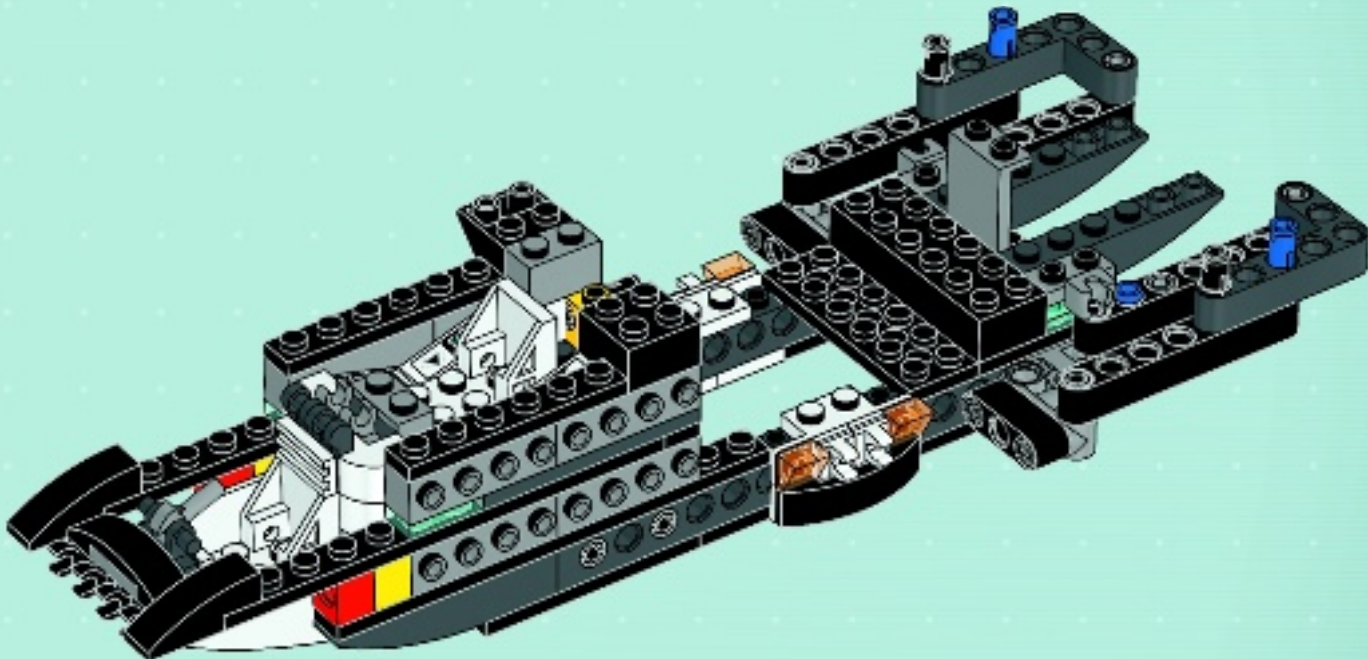



1x



2x

# 29

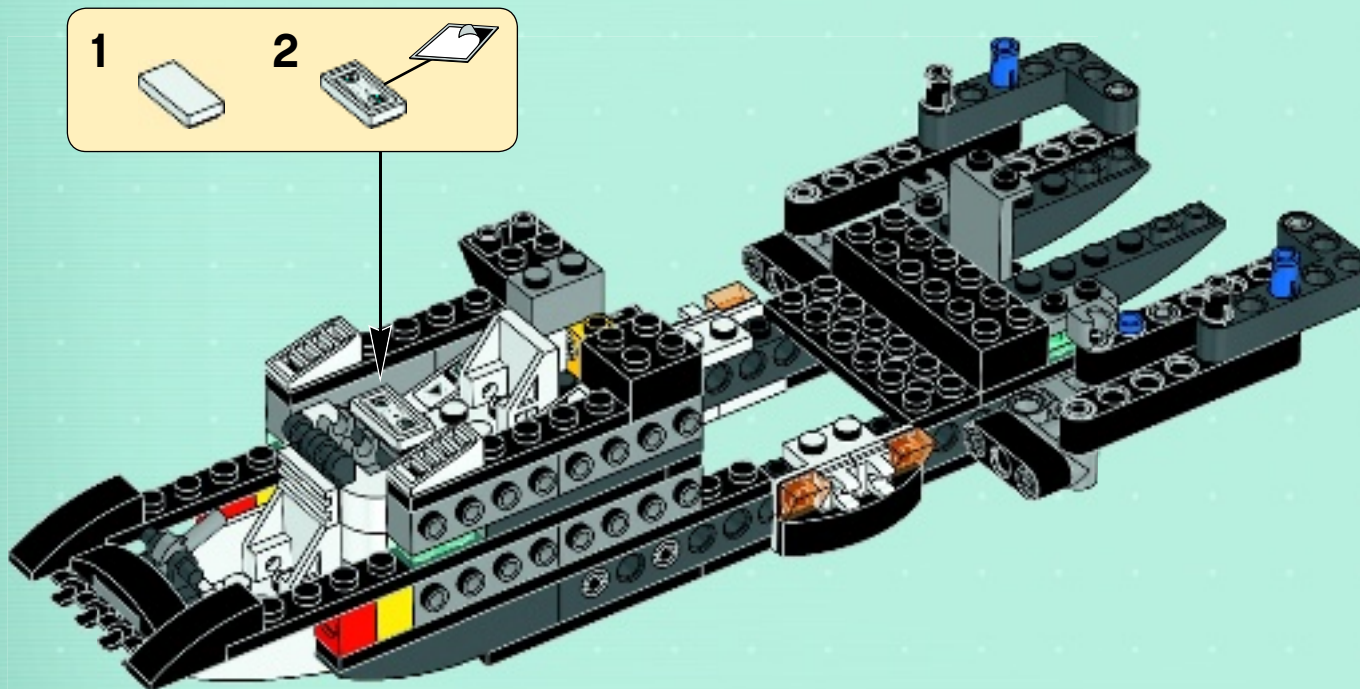

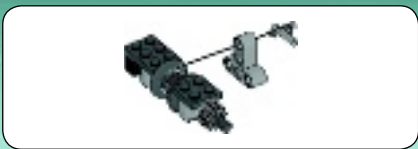

1



2

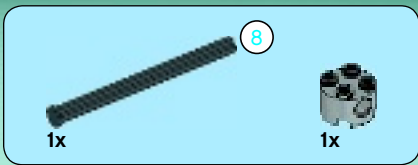

3

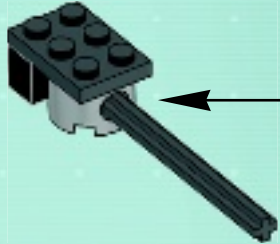
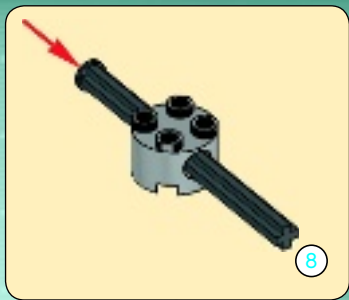

4

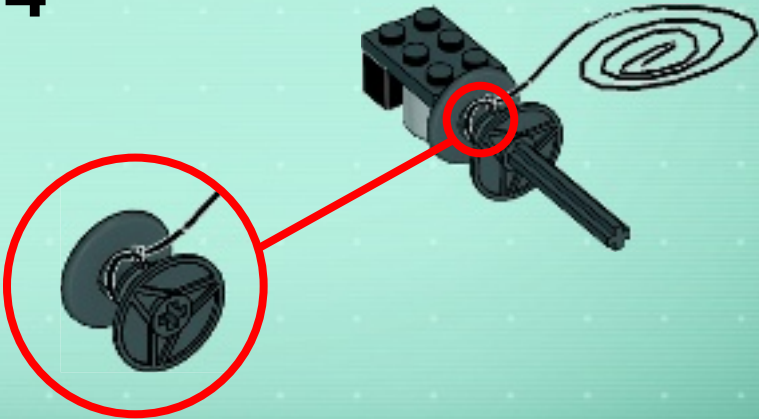



1x

5



1x



1x

6



1x



1x

7

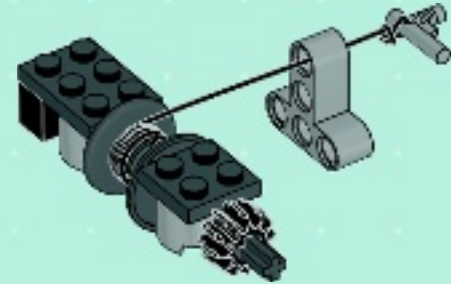



# 30

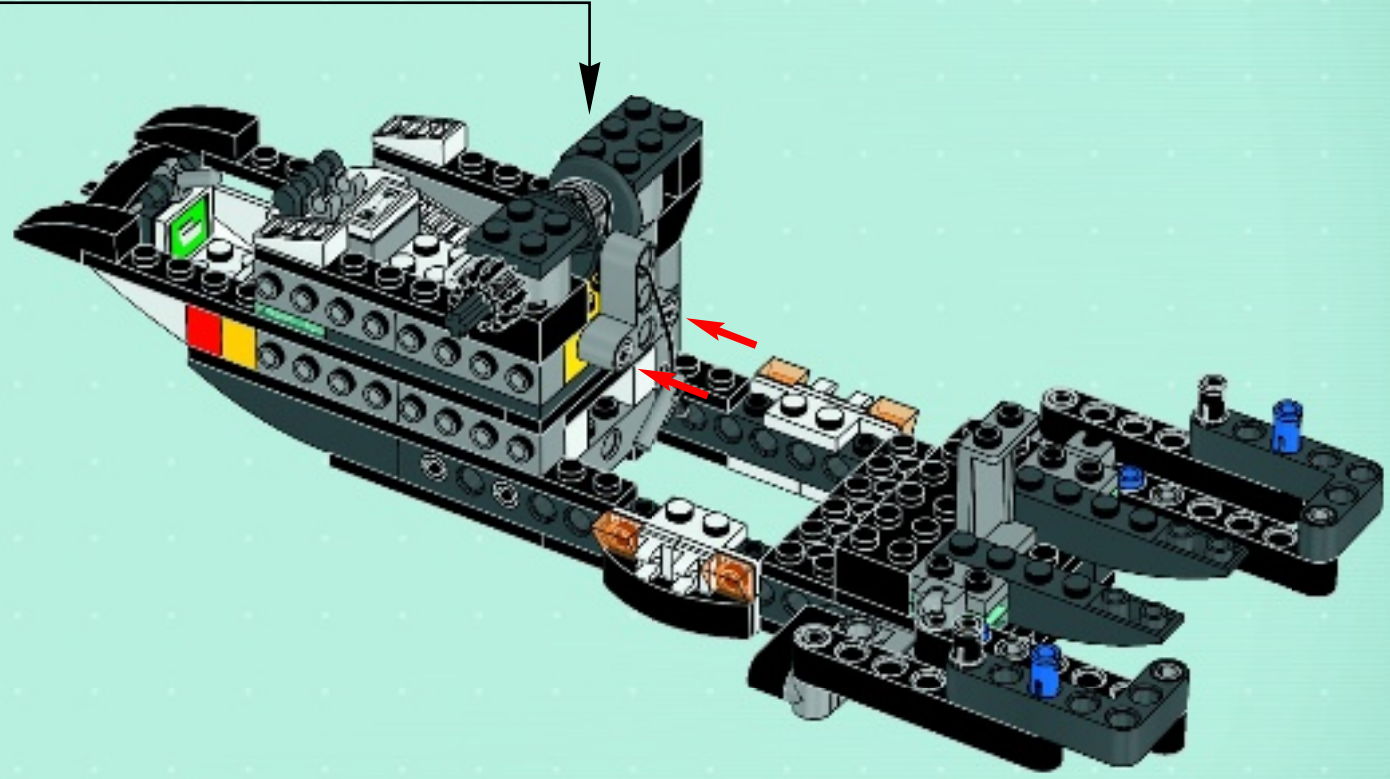
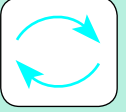



1x



2x



2x

# 31

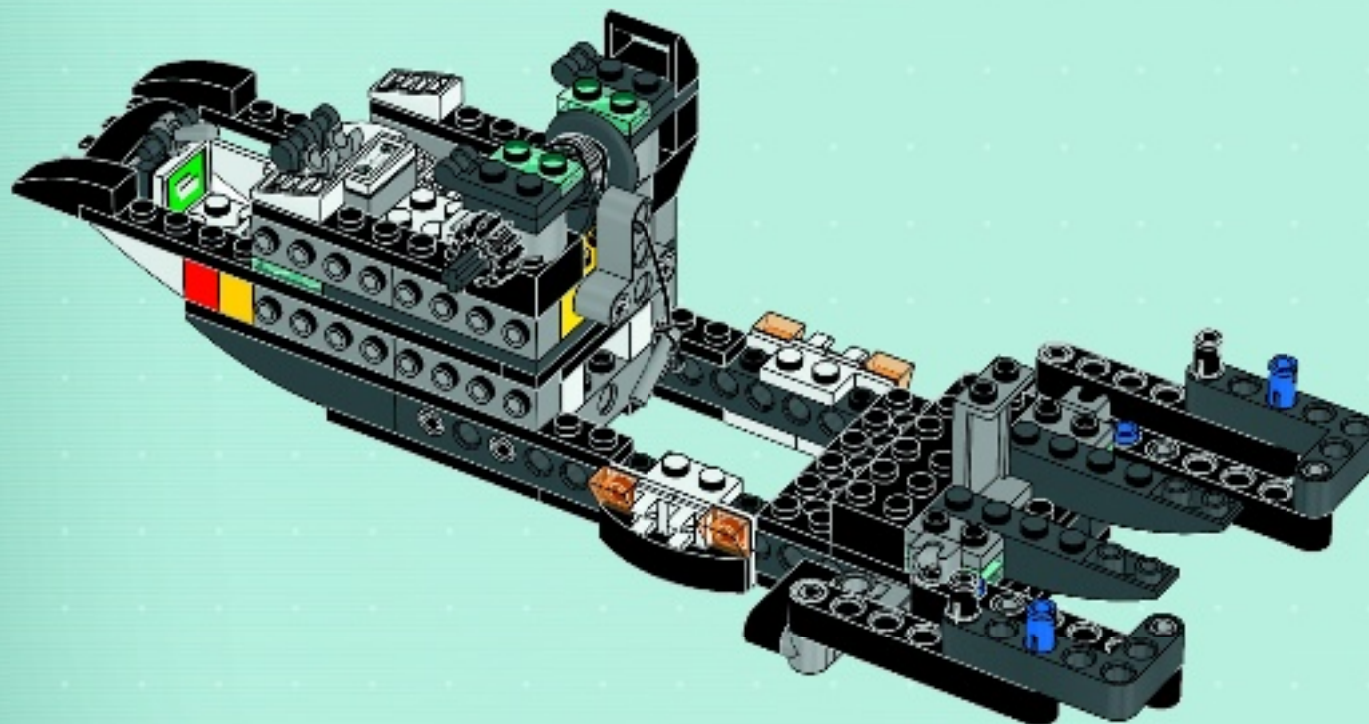



# 32

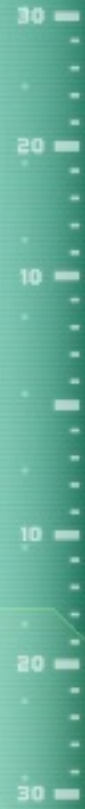
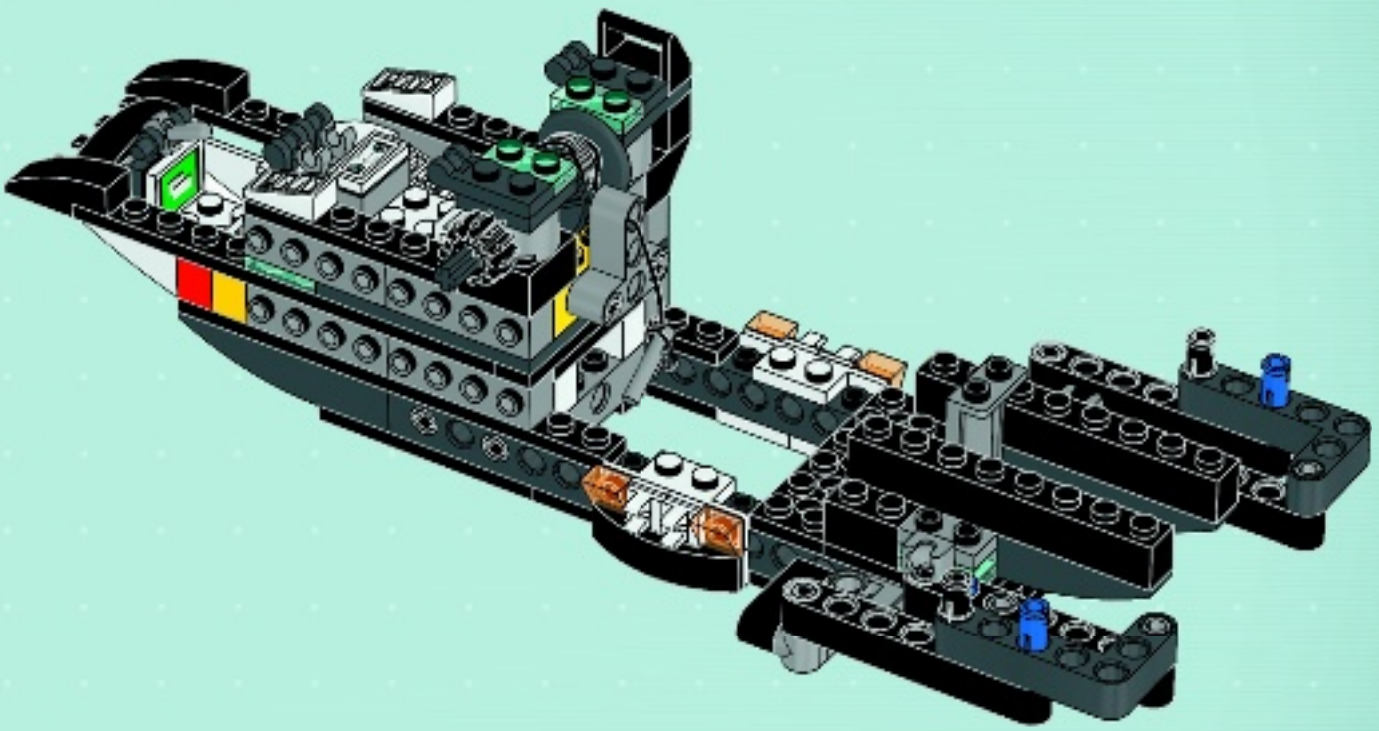



1



2



3



4

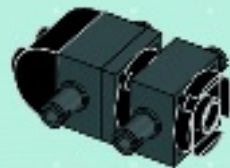
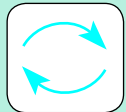

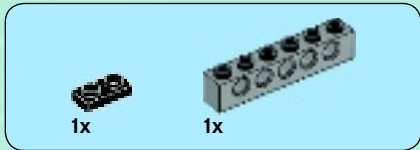

1



2



3

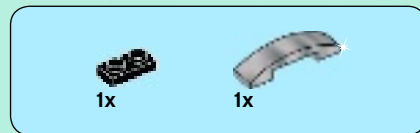
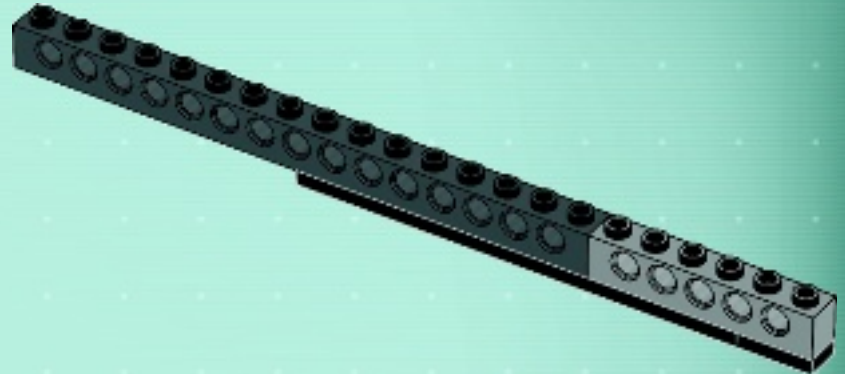

4

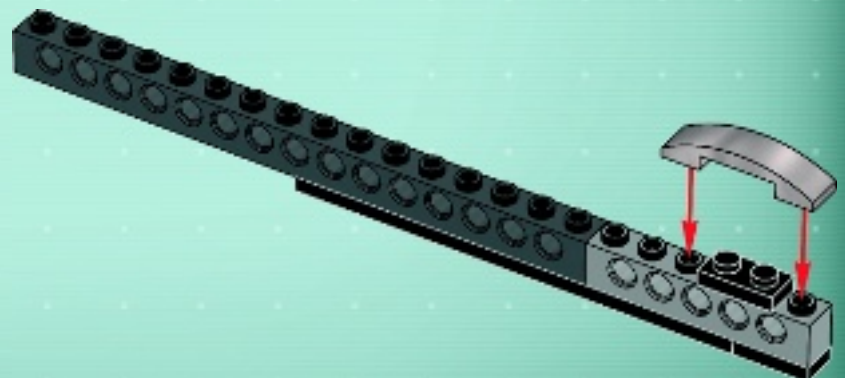

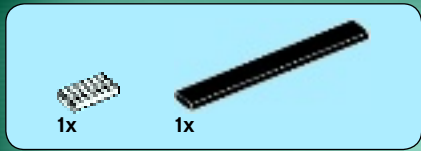

5

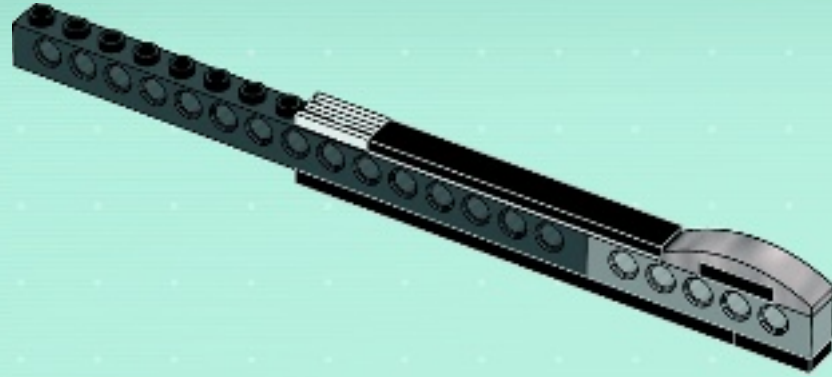

2x

6

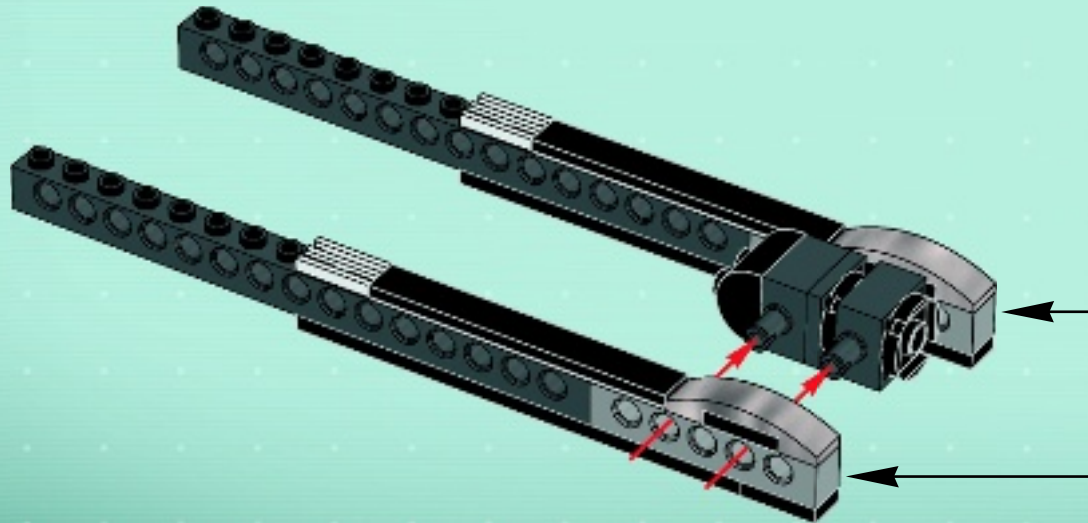



1x

1

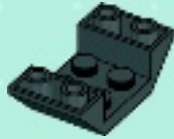

2x

2



2x

3



1x

4





2x

5



2x

6



2x

7



2x



1x

8





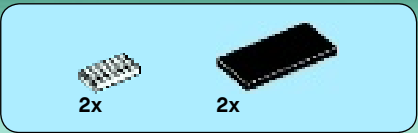

9

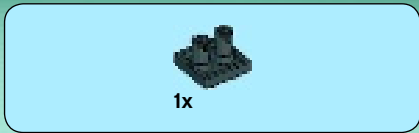
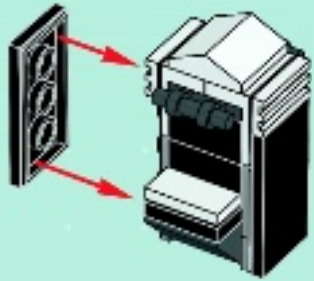

10



11

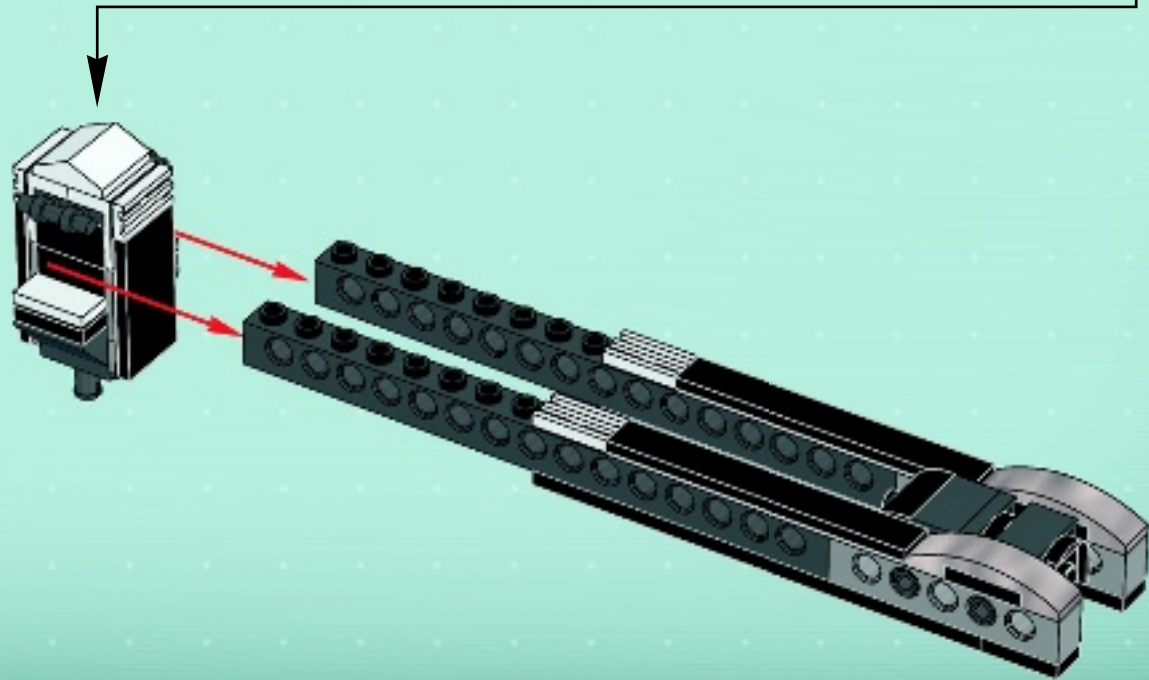

33

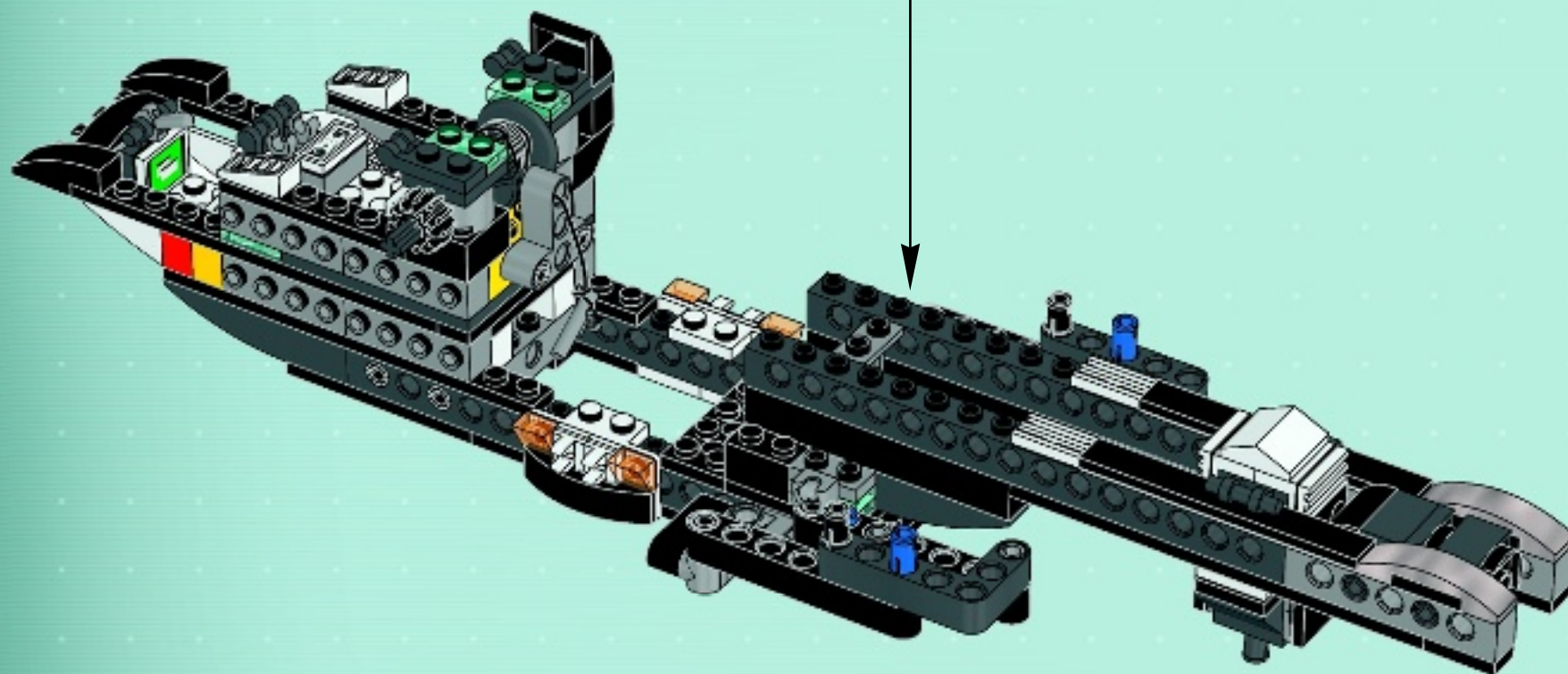

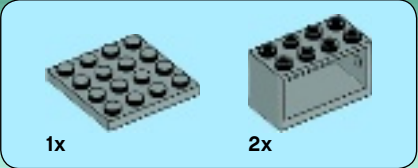

# 34

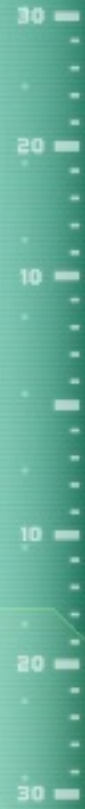
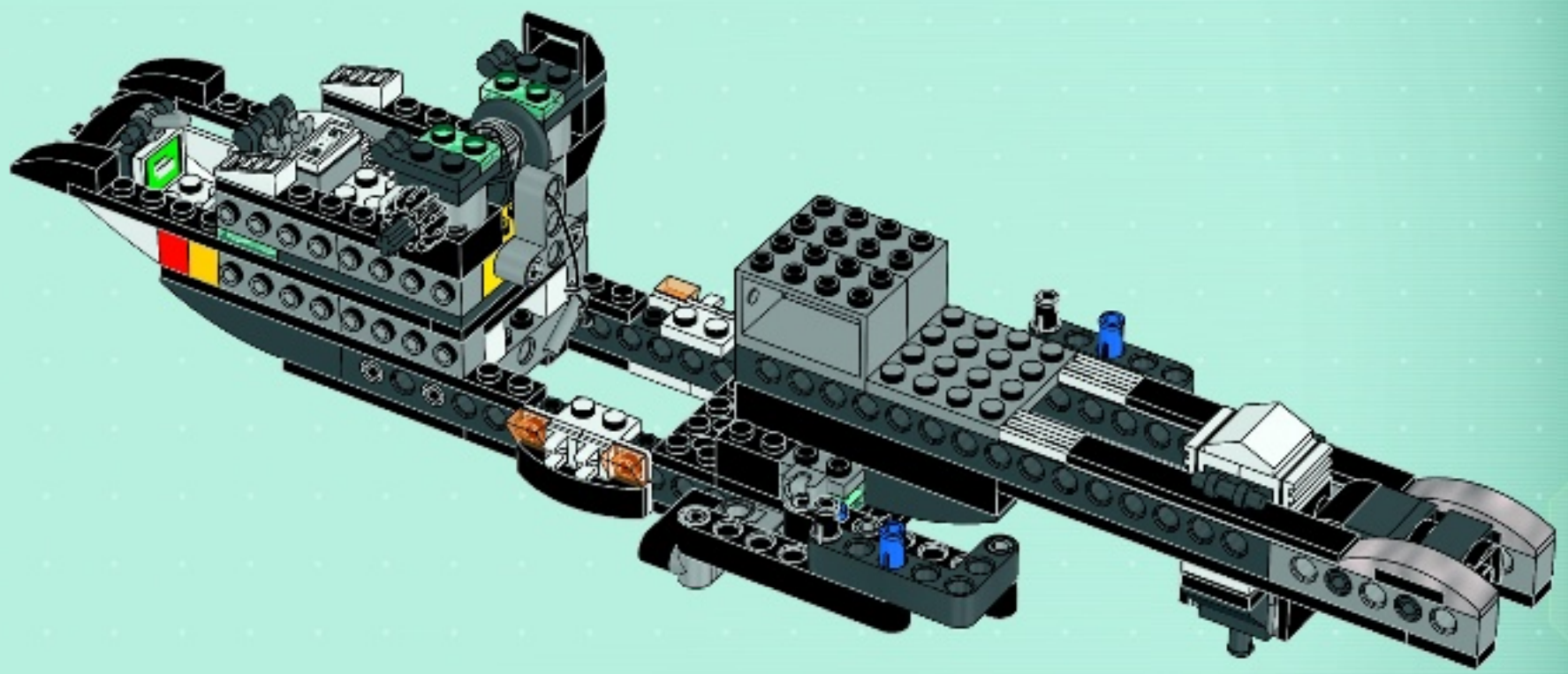

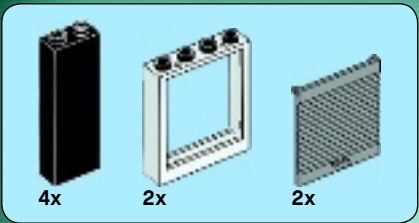

35

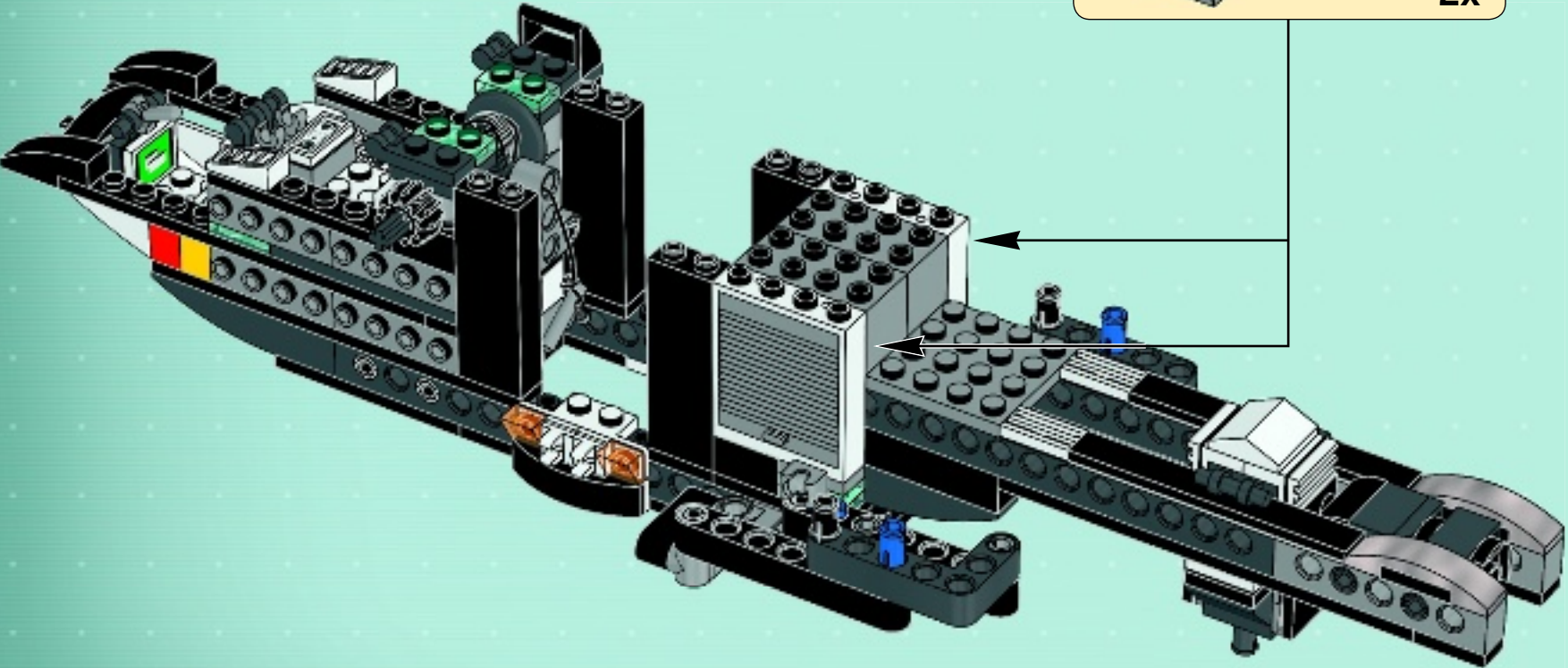
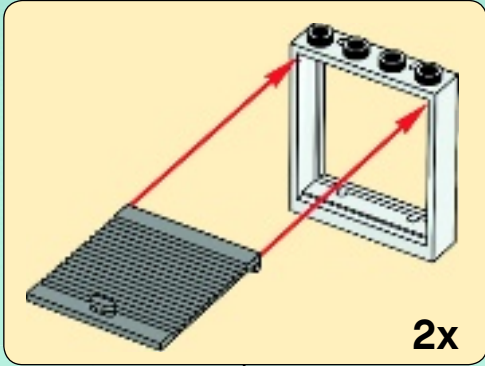

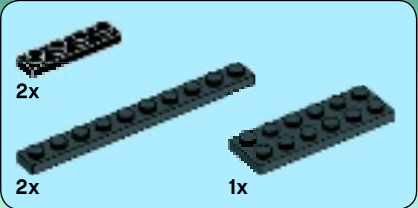

# 36

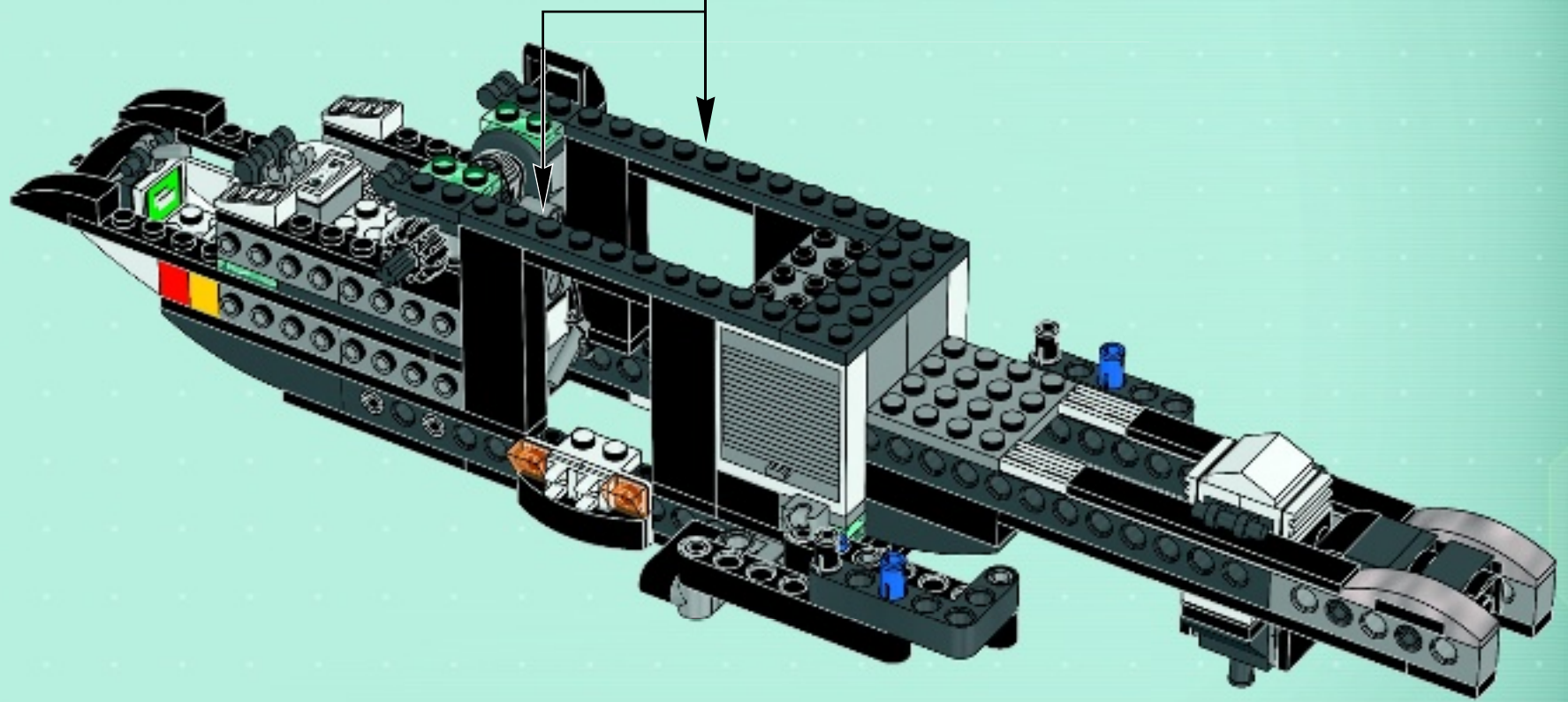
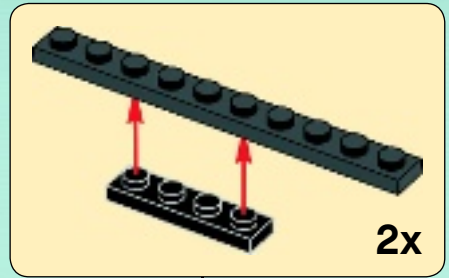

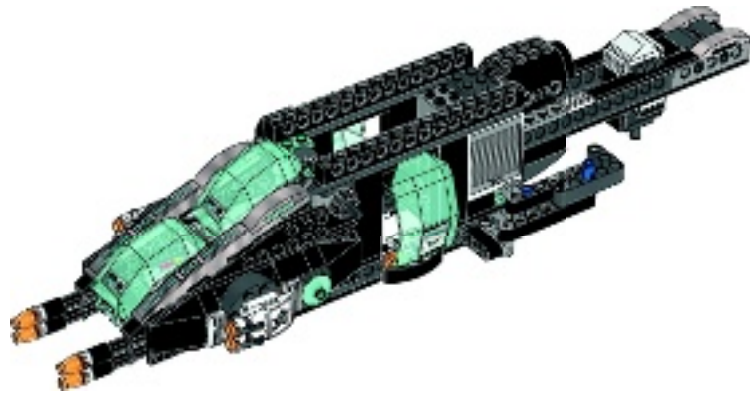

2x

37

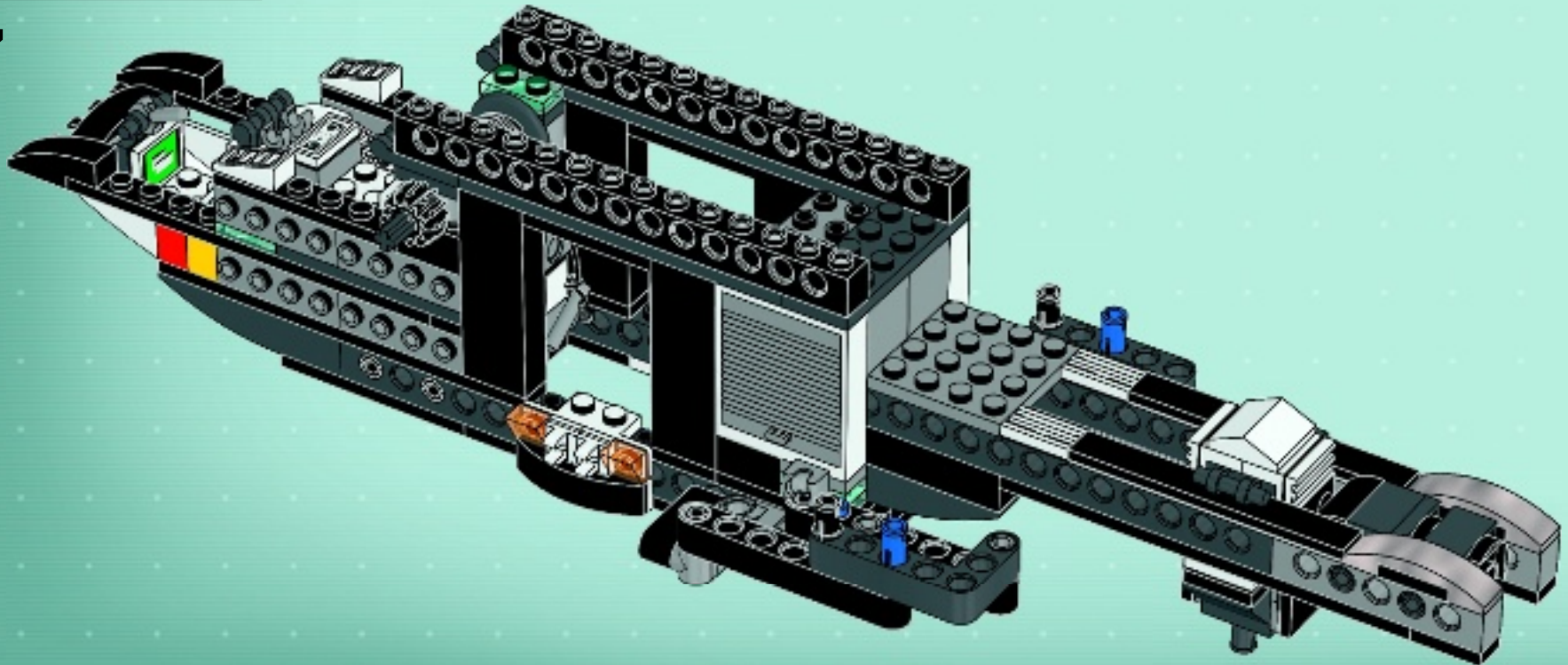

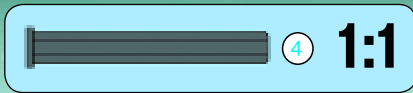

38

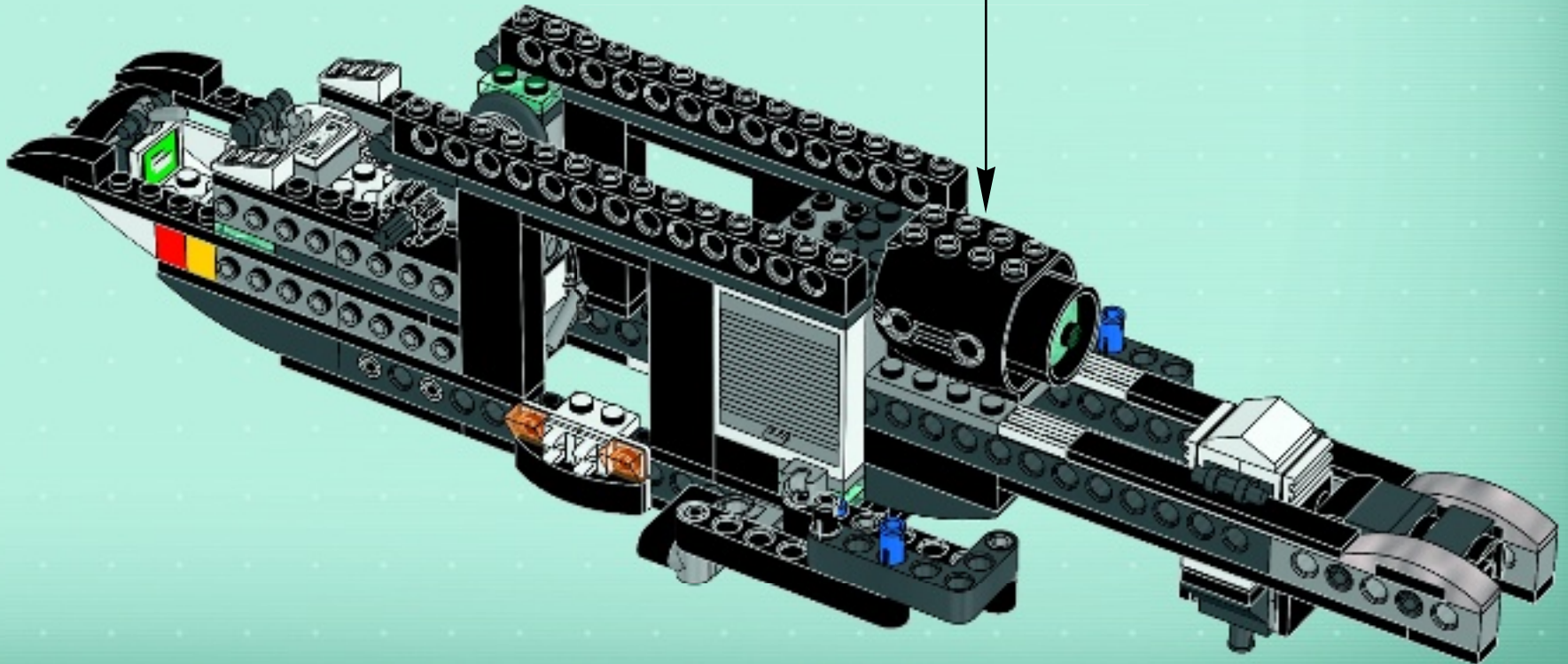
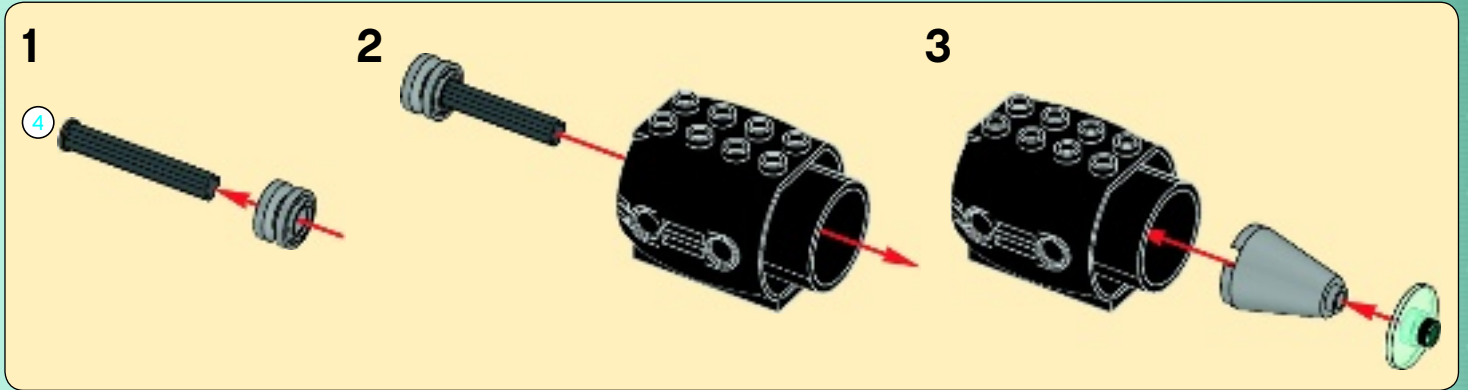

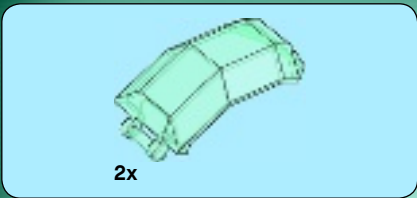

# 39

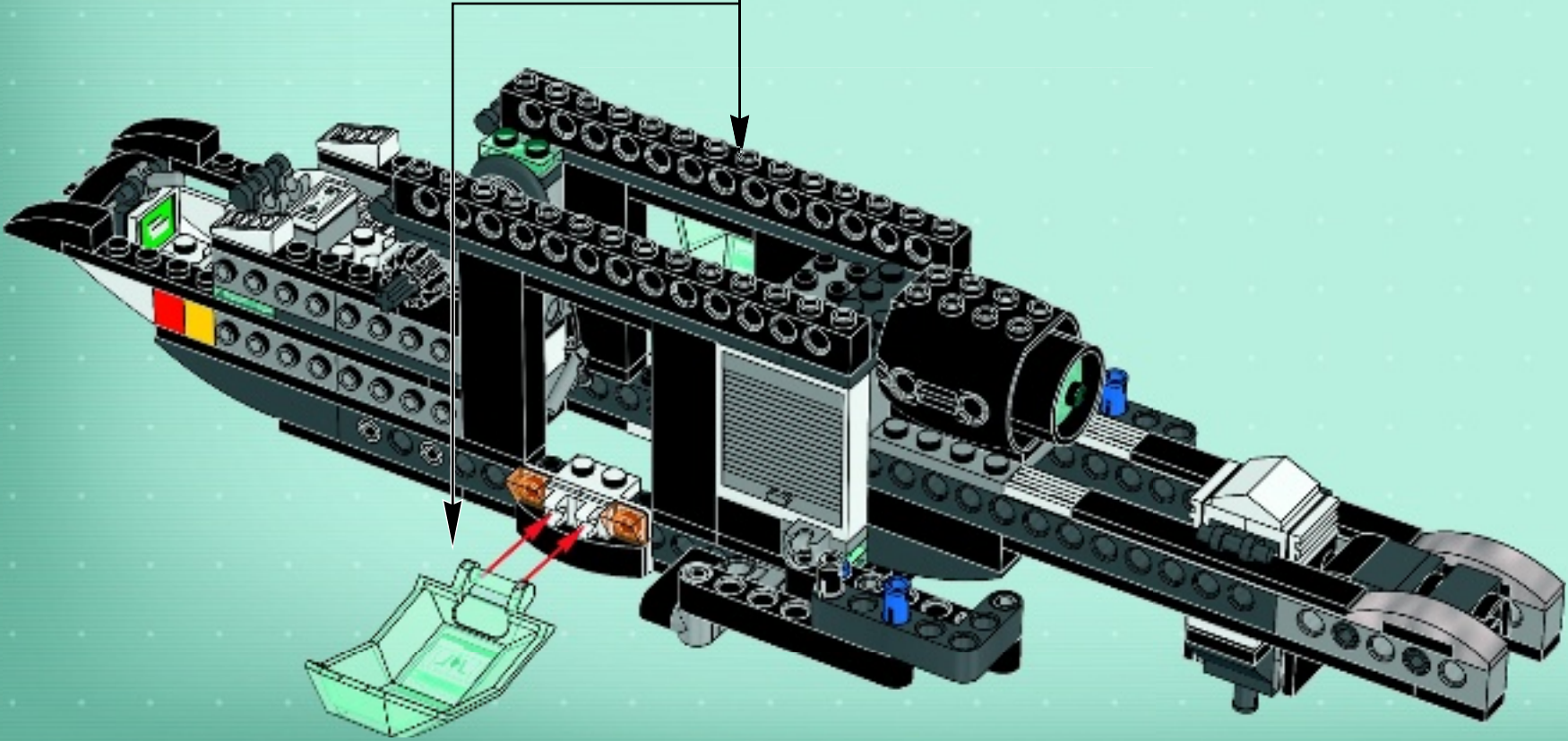
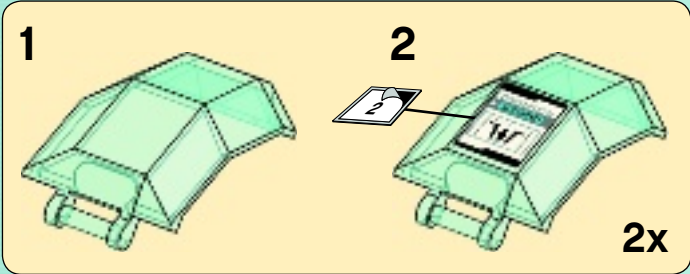





# 40

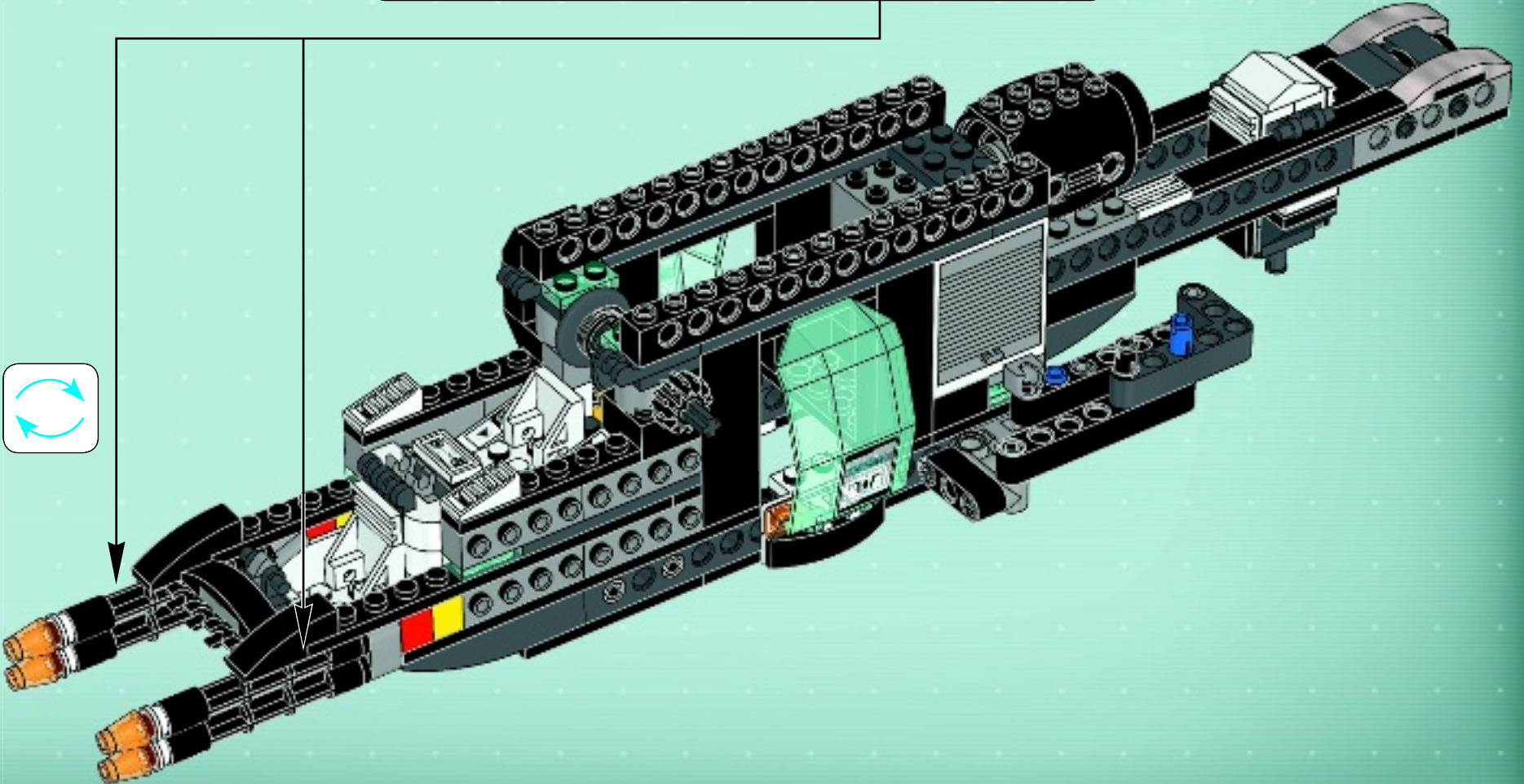
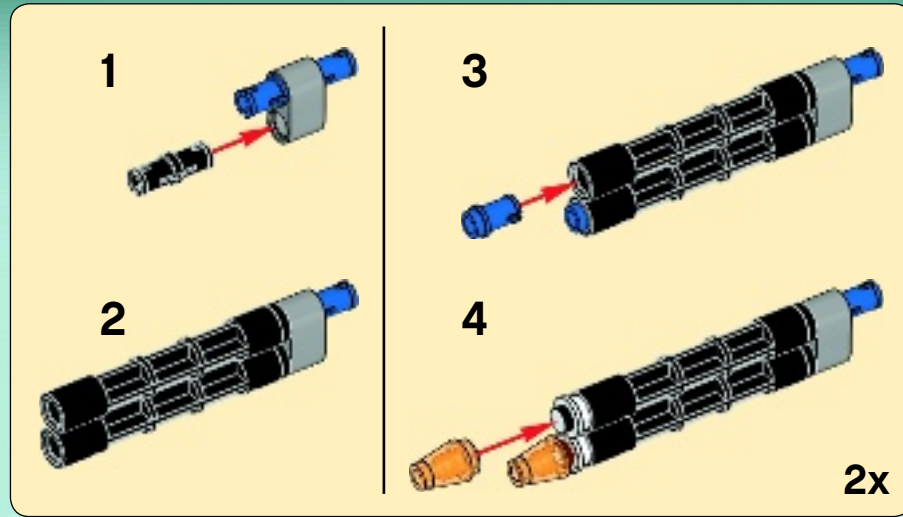

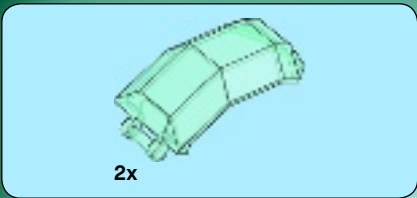

# 41

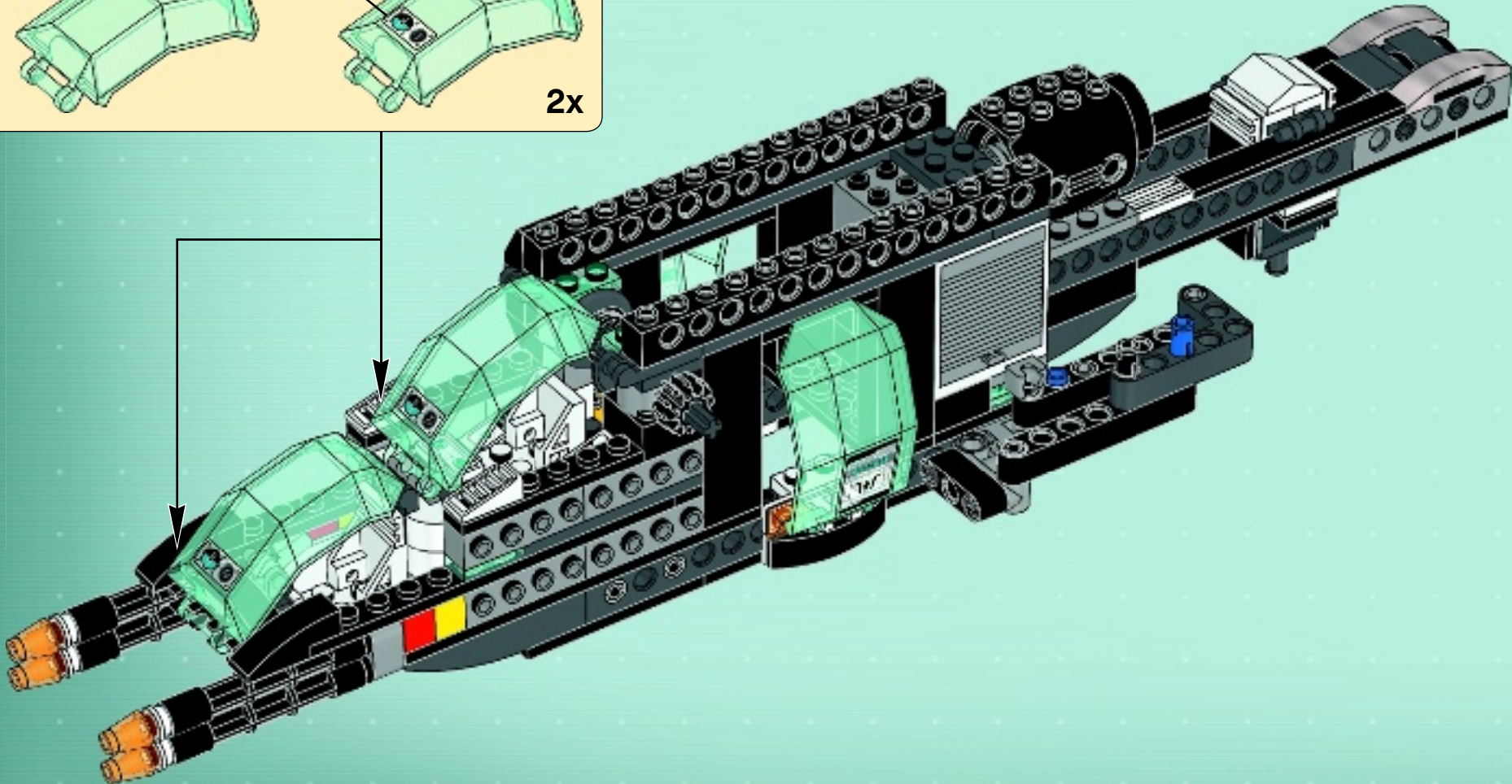
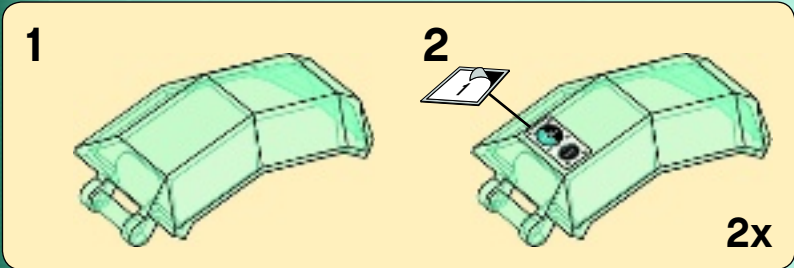

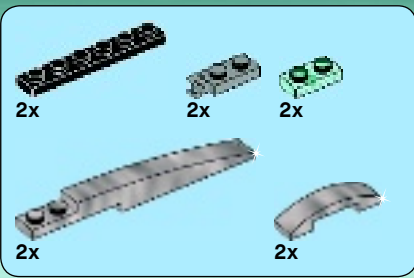

42

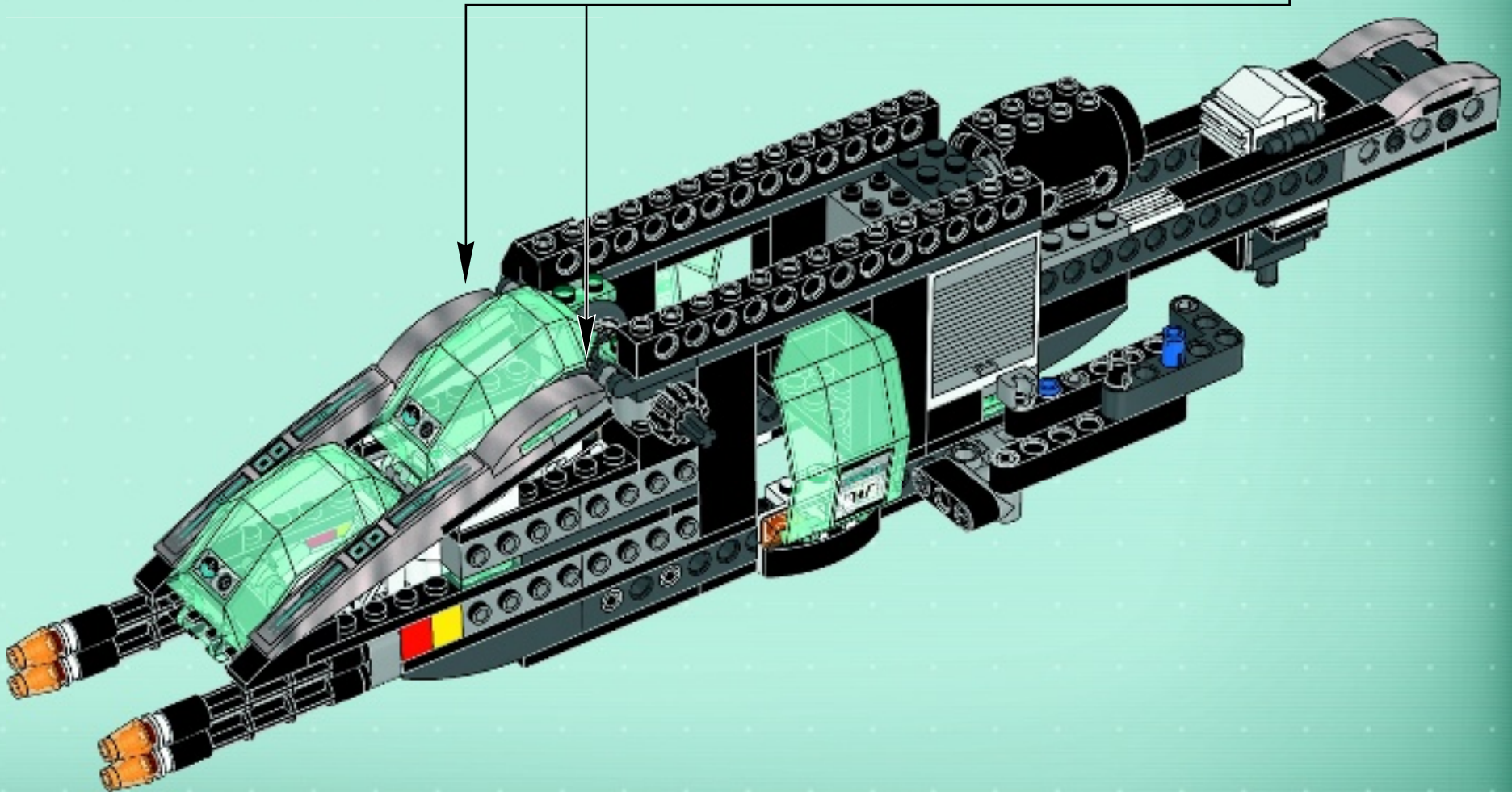
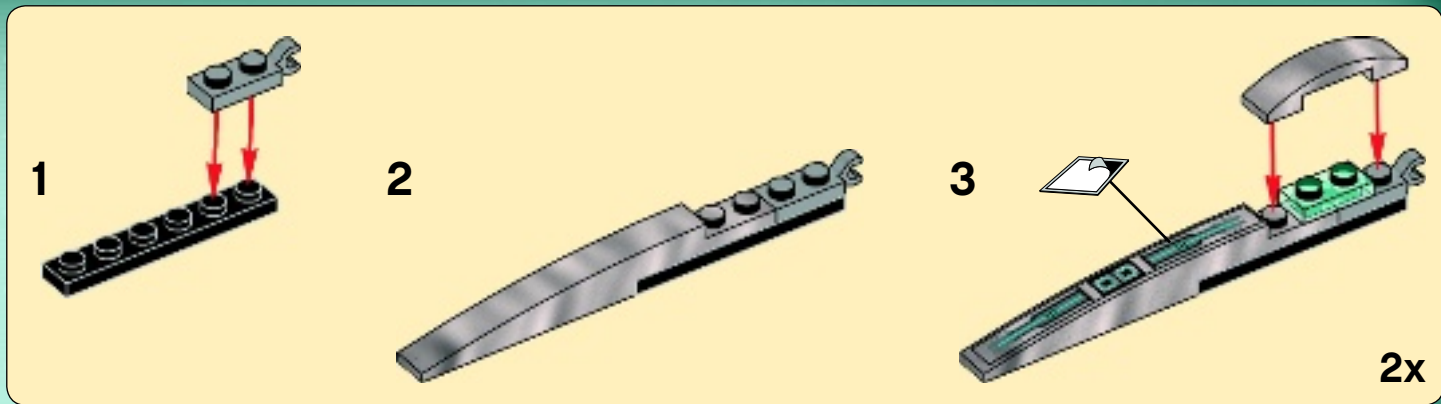

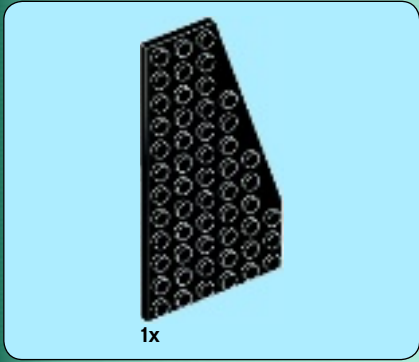
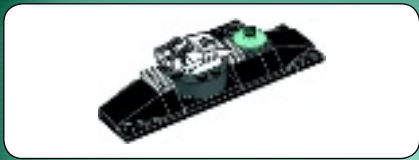

1

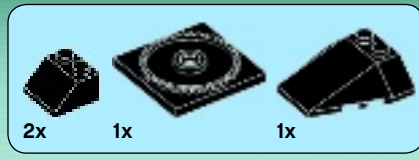
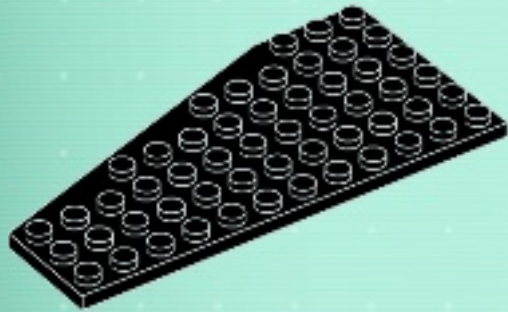

2

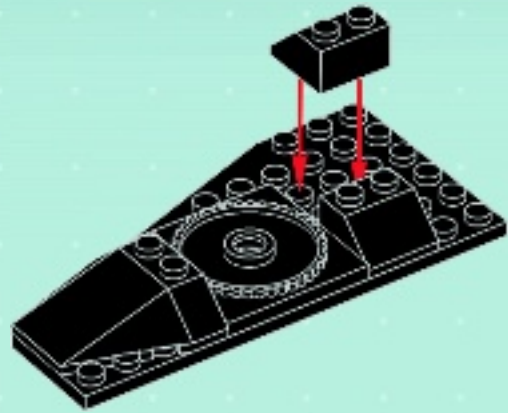

3





4



5

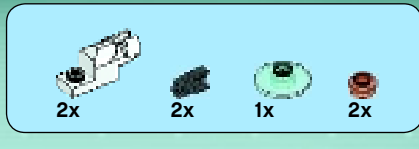

6

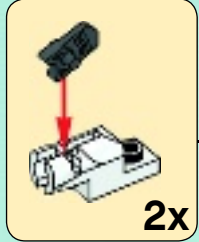

7

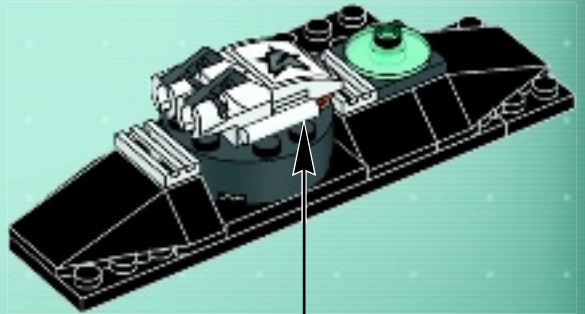
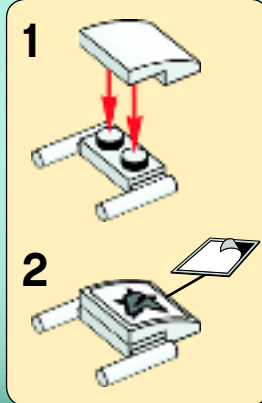

43

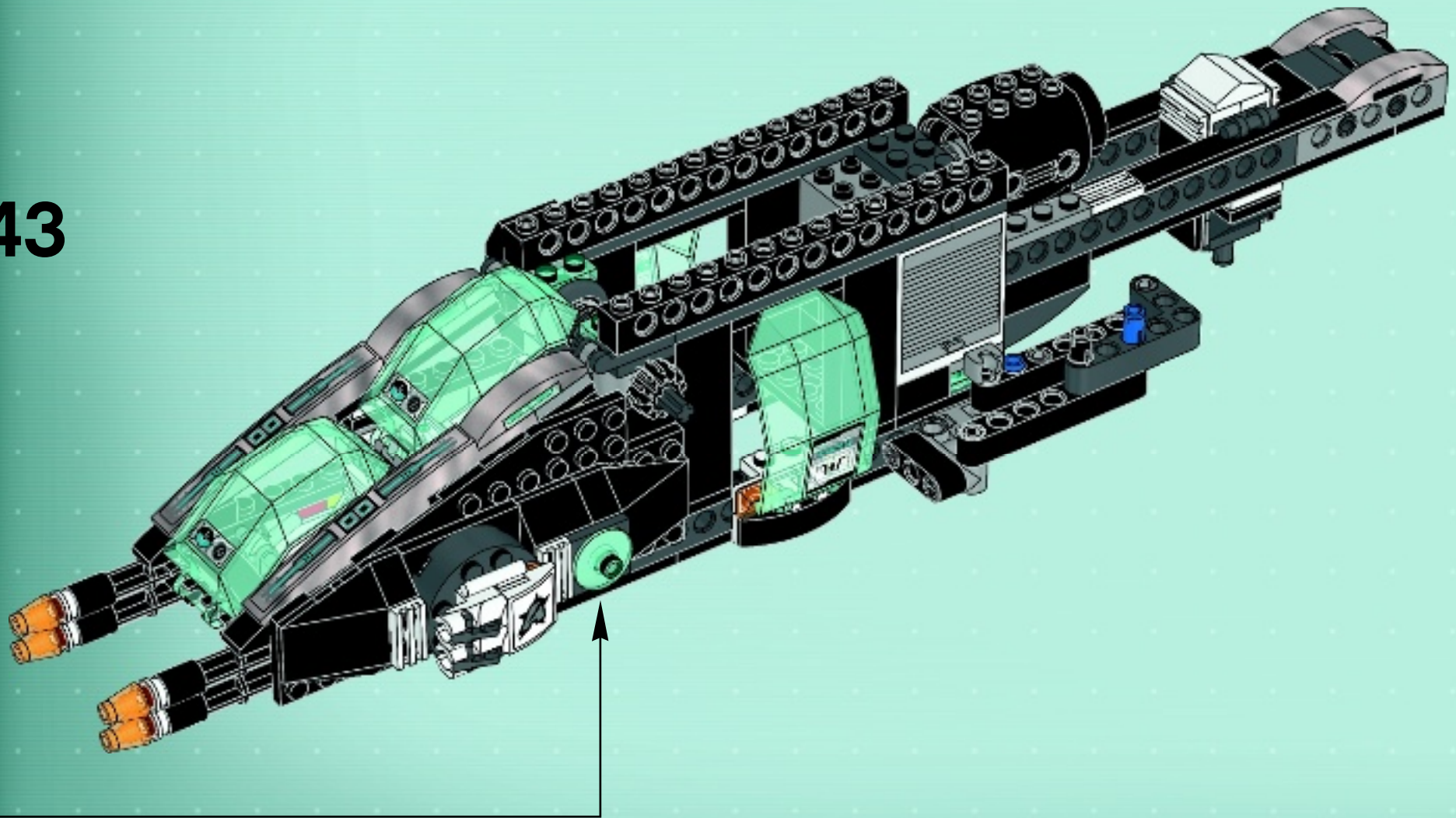

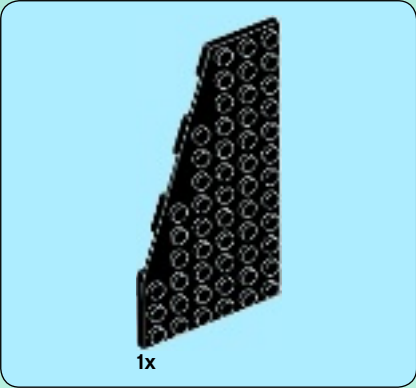
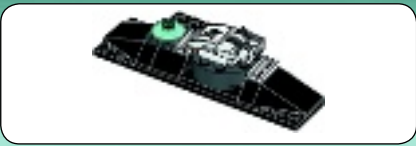

1



2

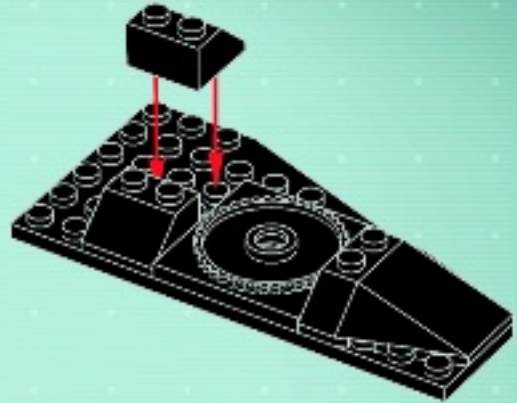

3

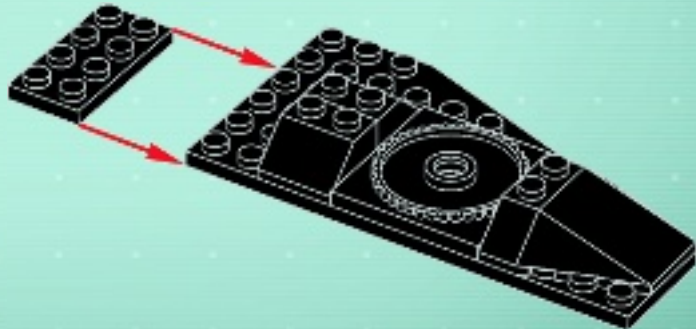



1x

4

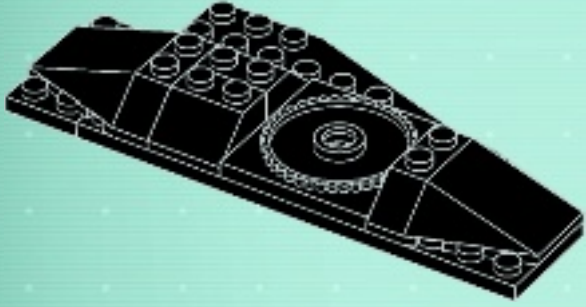

2x



1x



1x

5



2x



2x



1x



2x



6

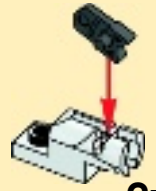

2x



1x



1x

7

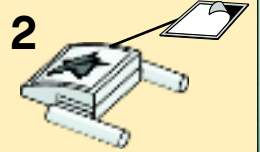
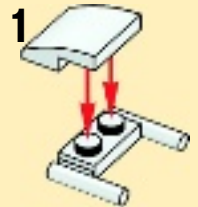



44

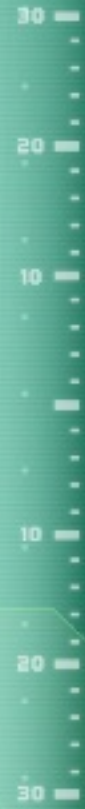
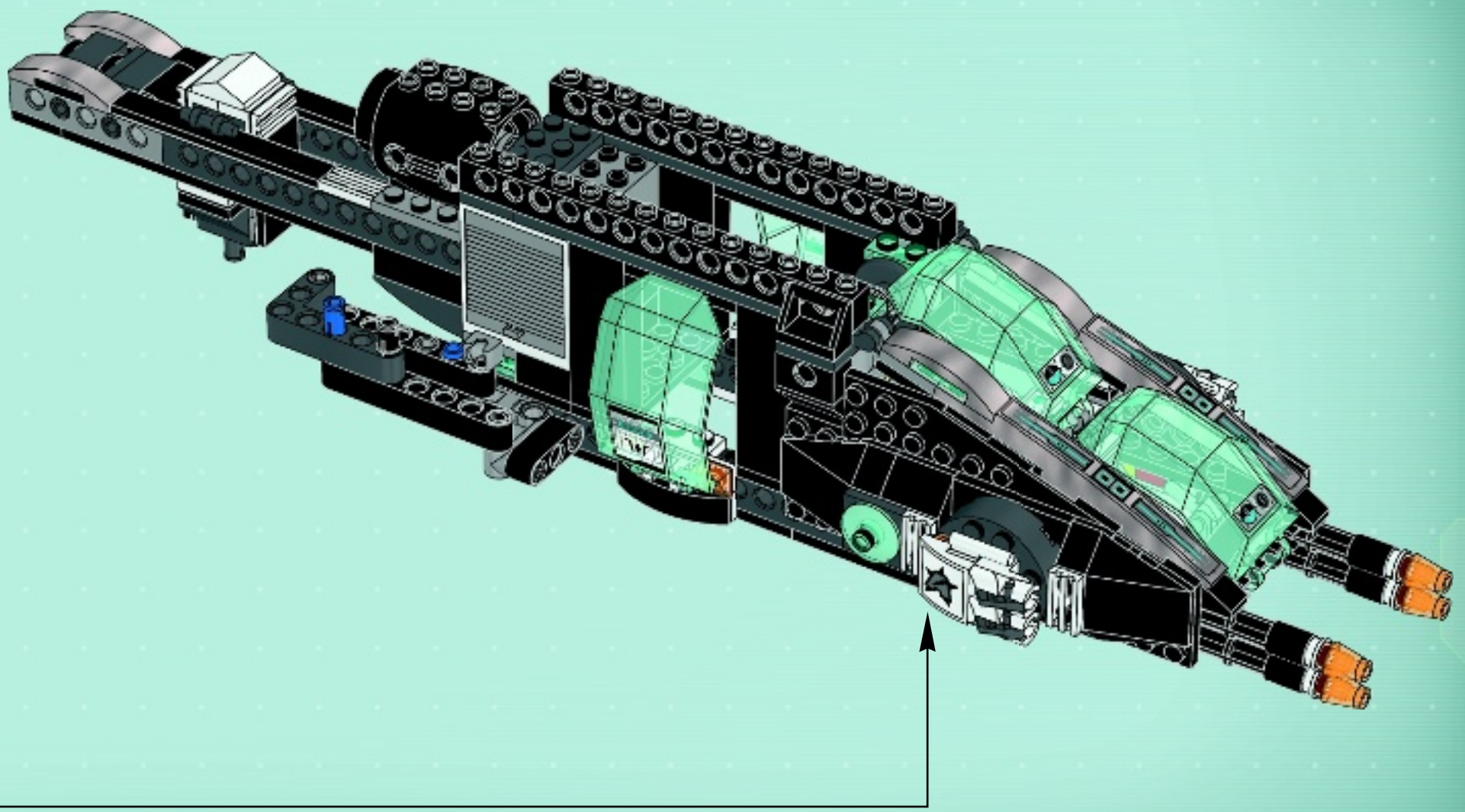
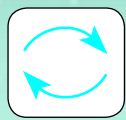



4x



45

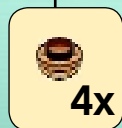
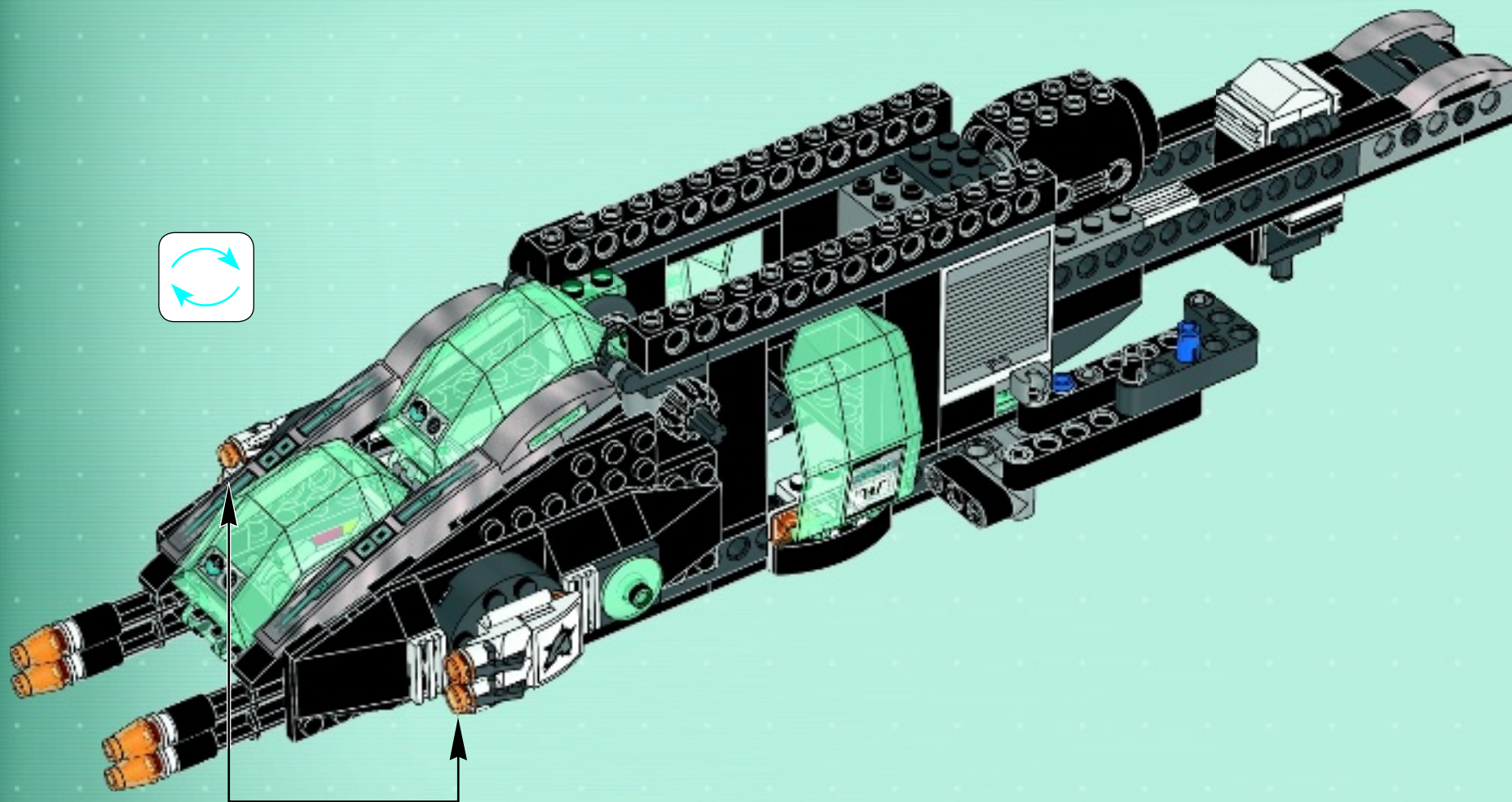
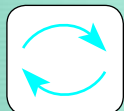

4x



4

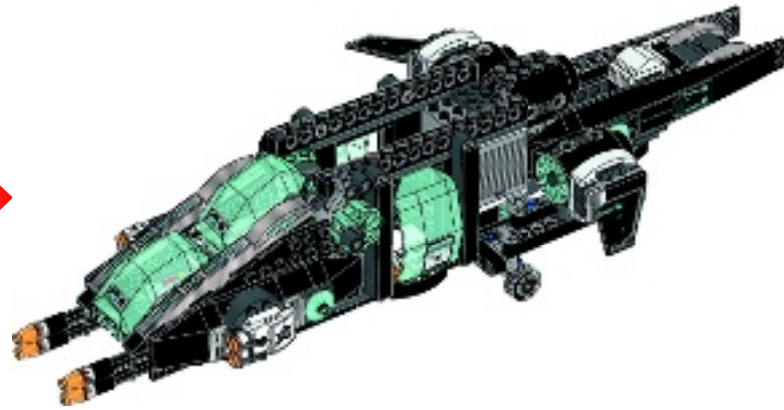

46

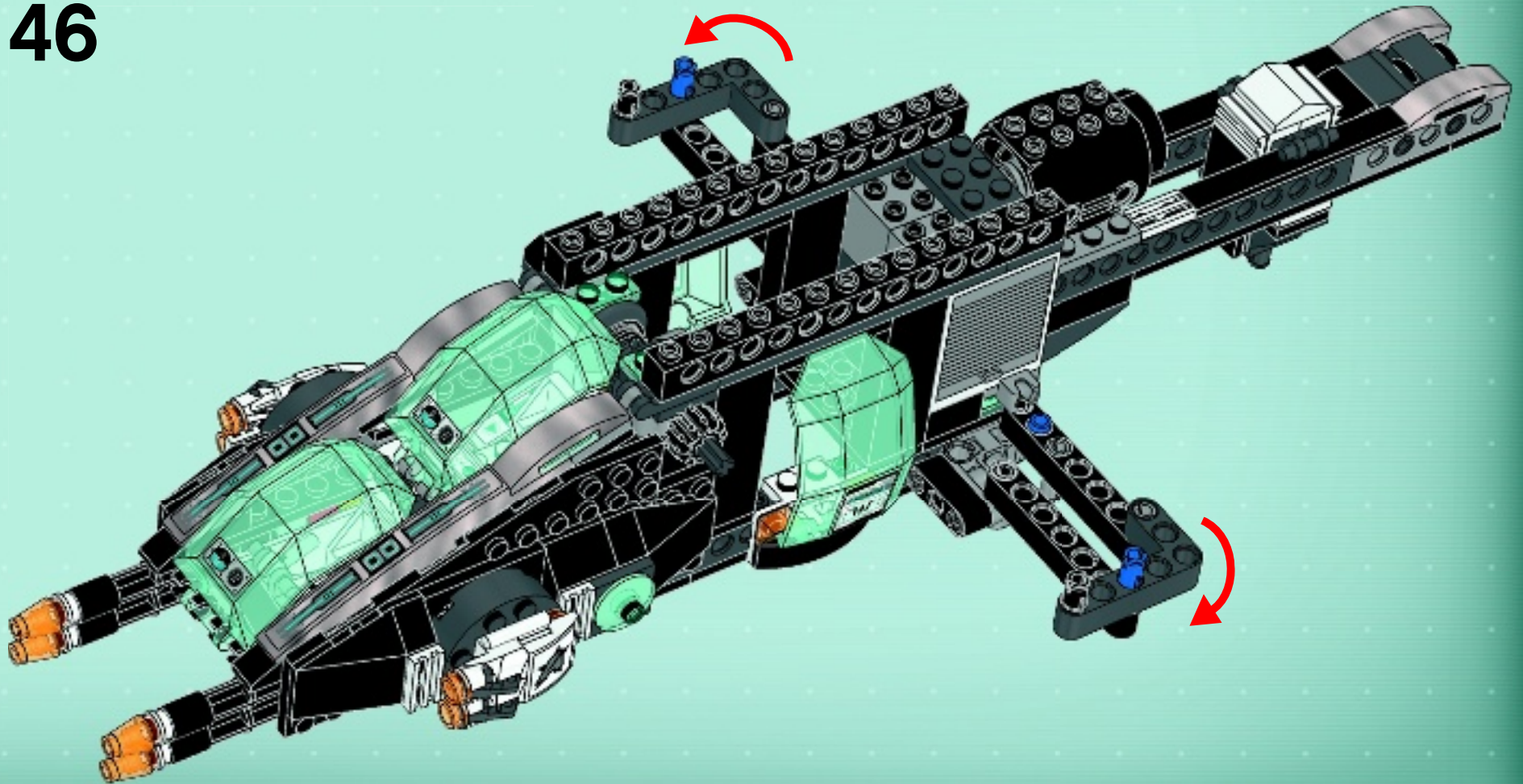

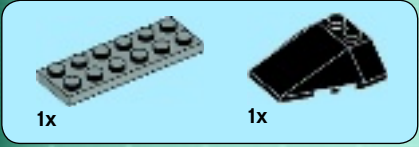

1

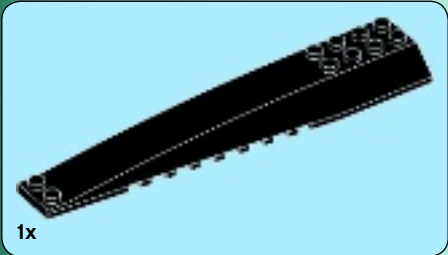
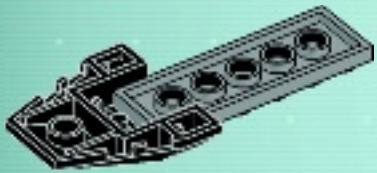

2

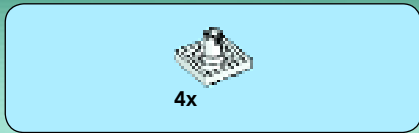
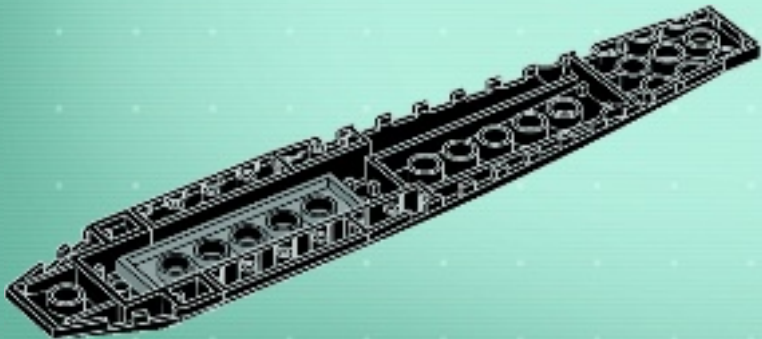

3

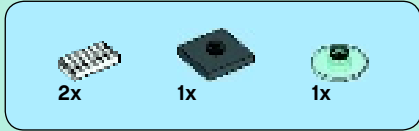
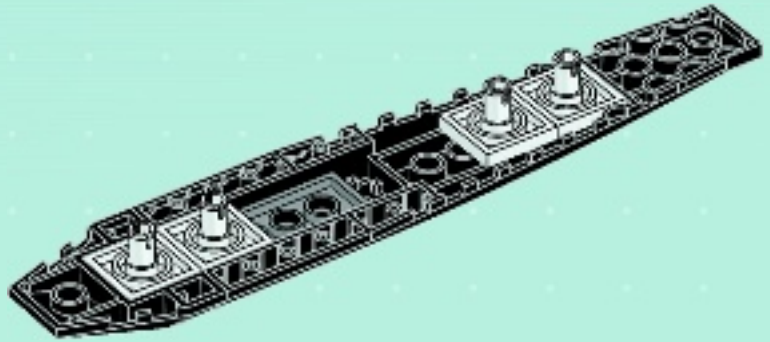

4

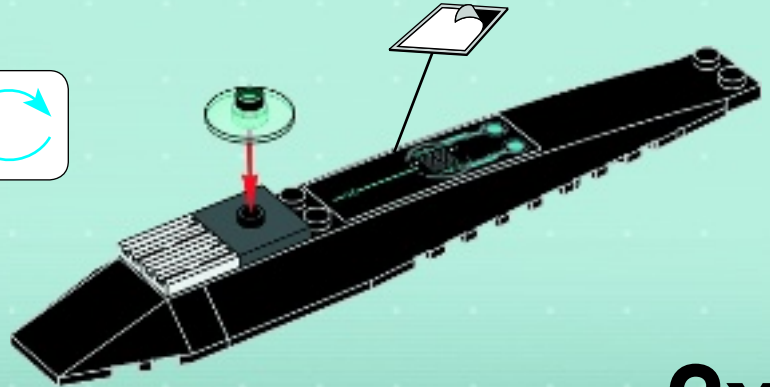
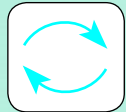

2x

47

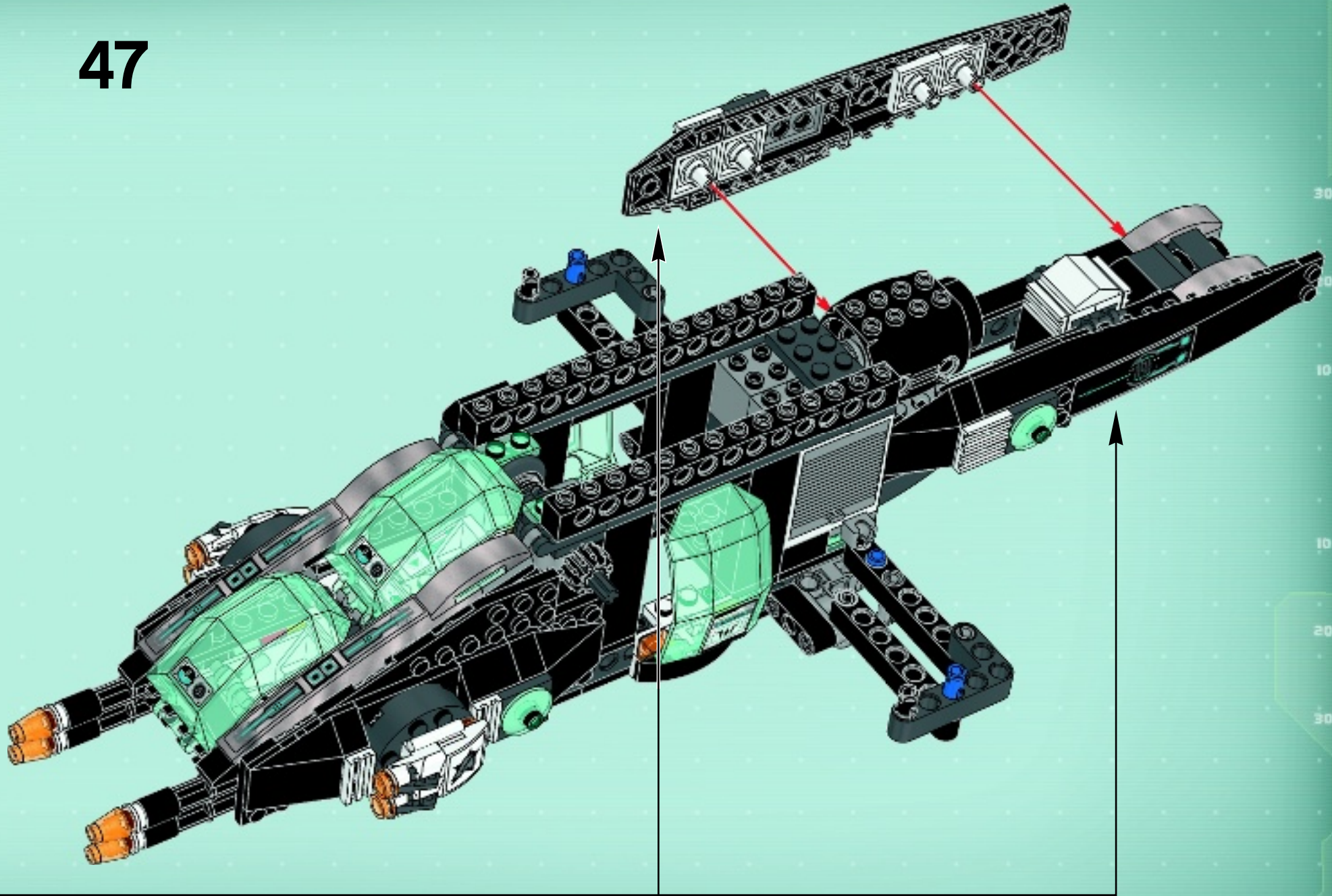

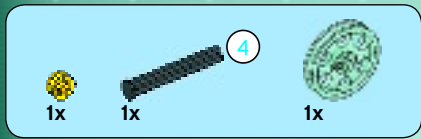
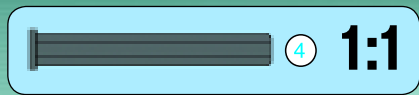

1

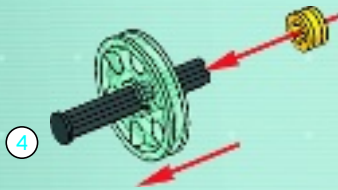

2

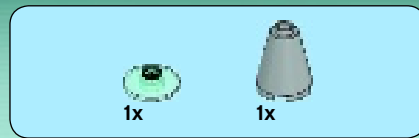

3

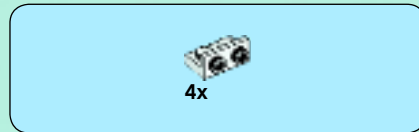
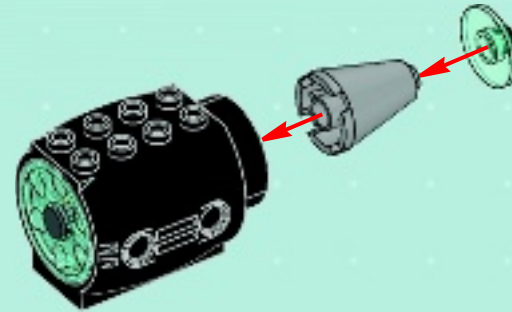

4





5



6

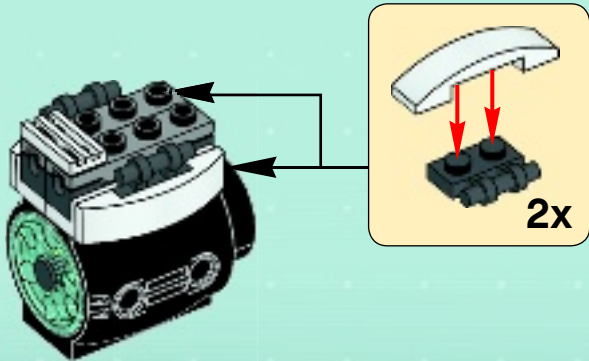

7



2x

48

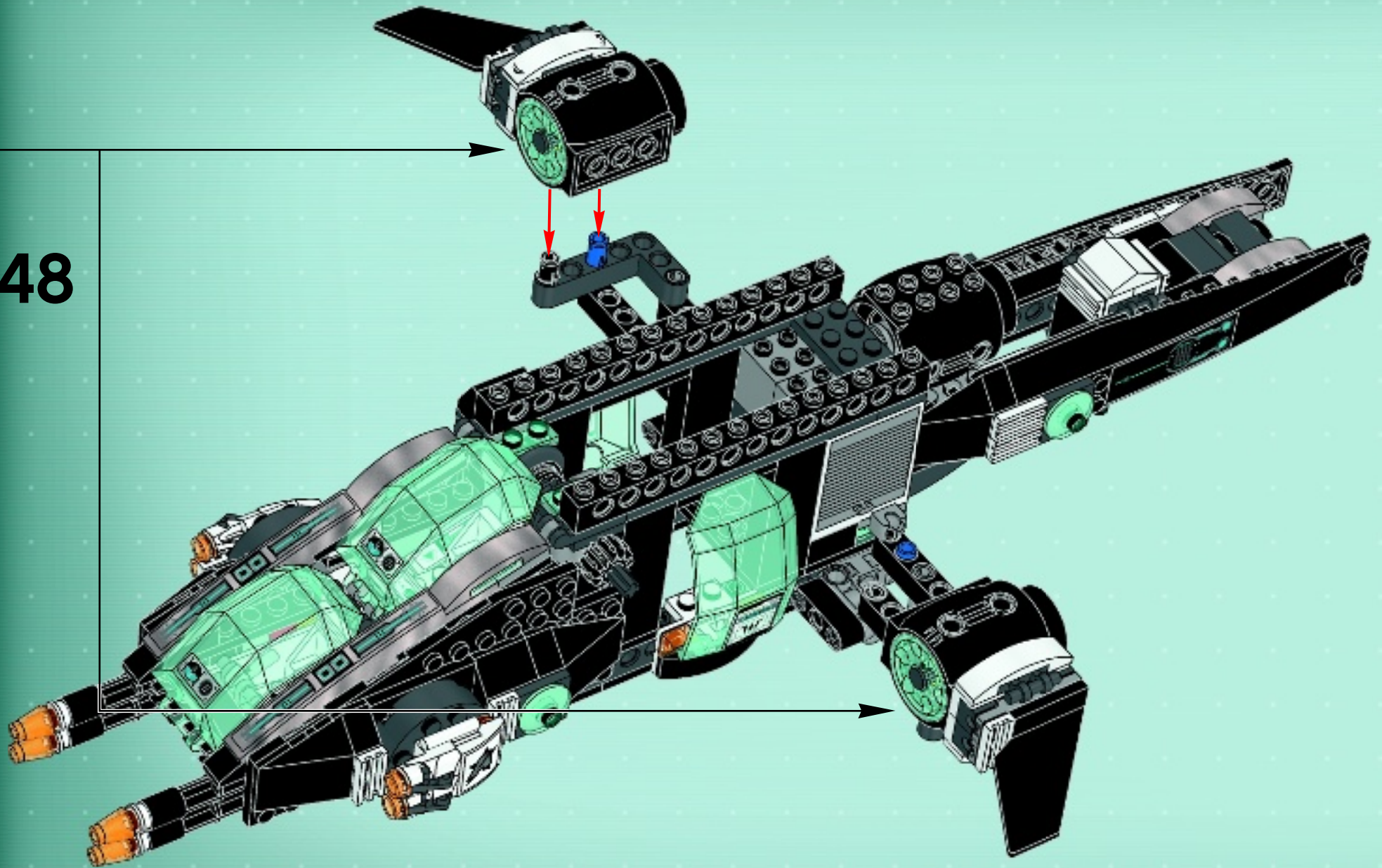



49

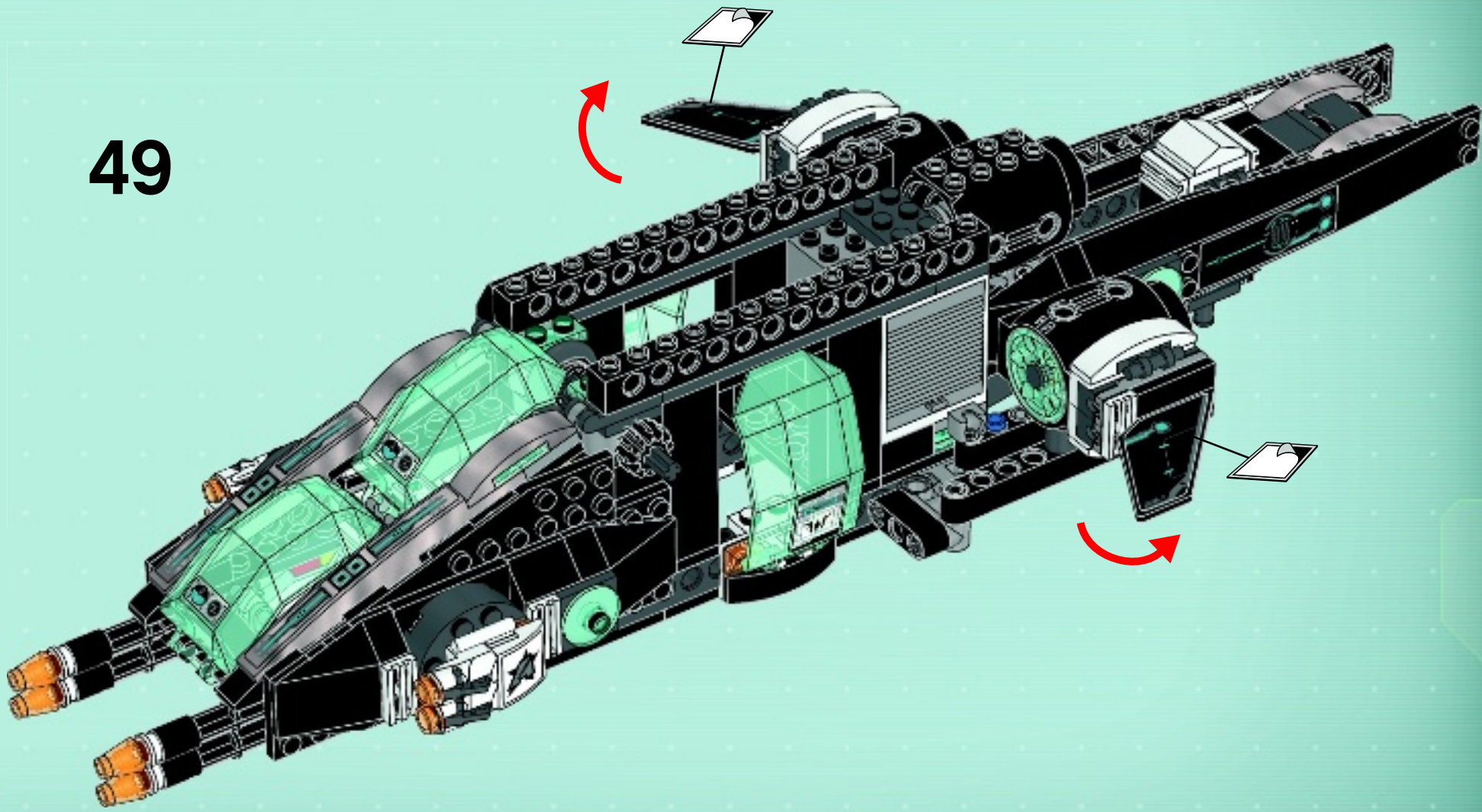

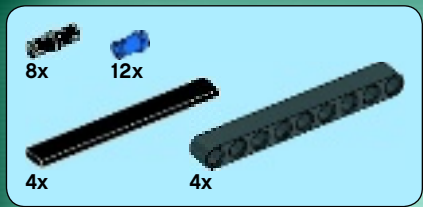

50

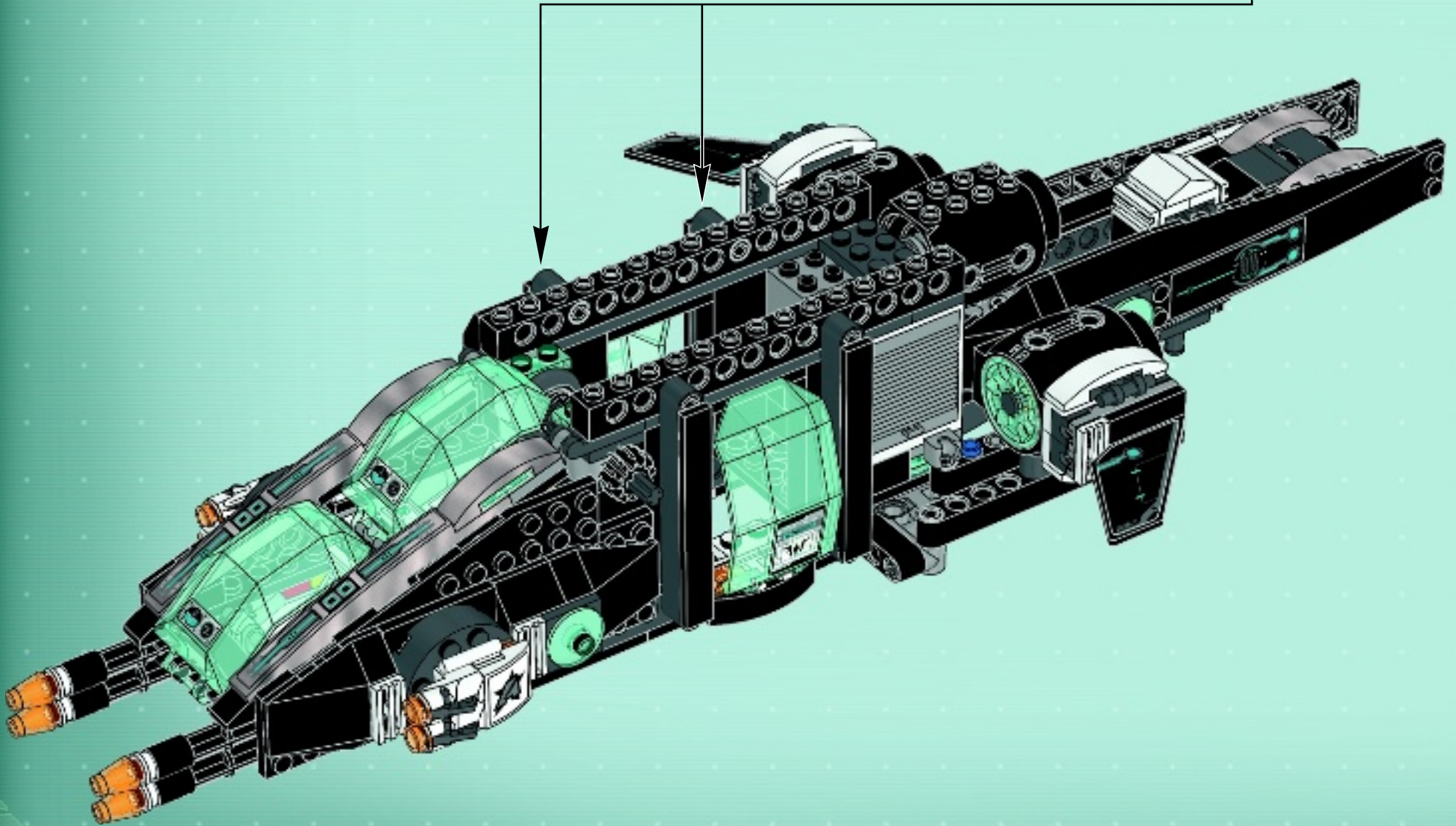
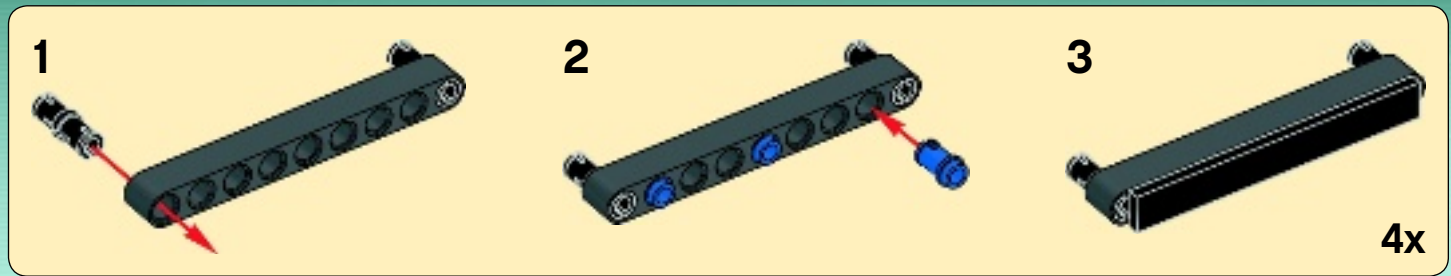



# 51

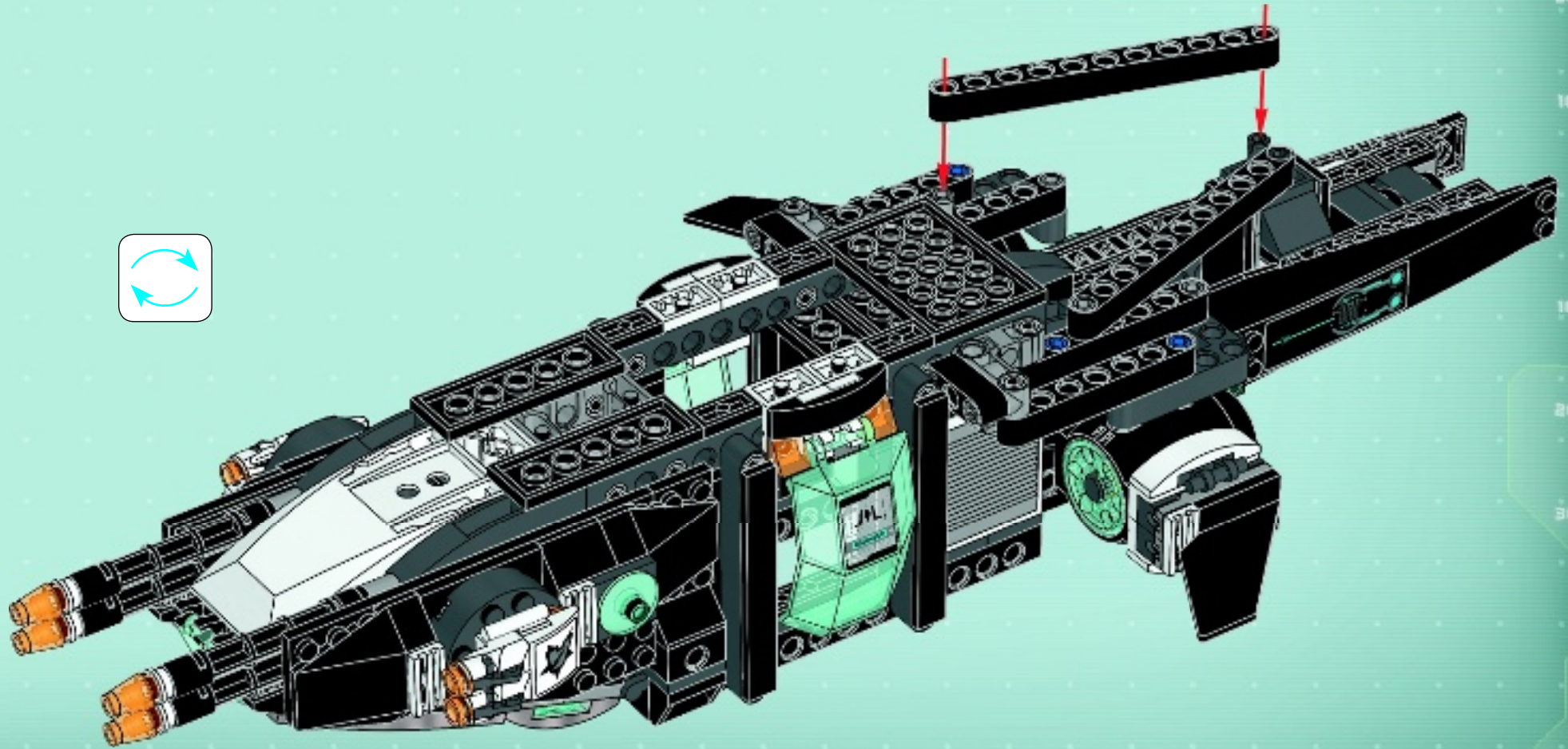
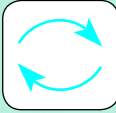



2x



2x

# 52

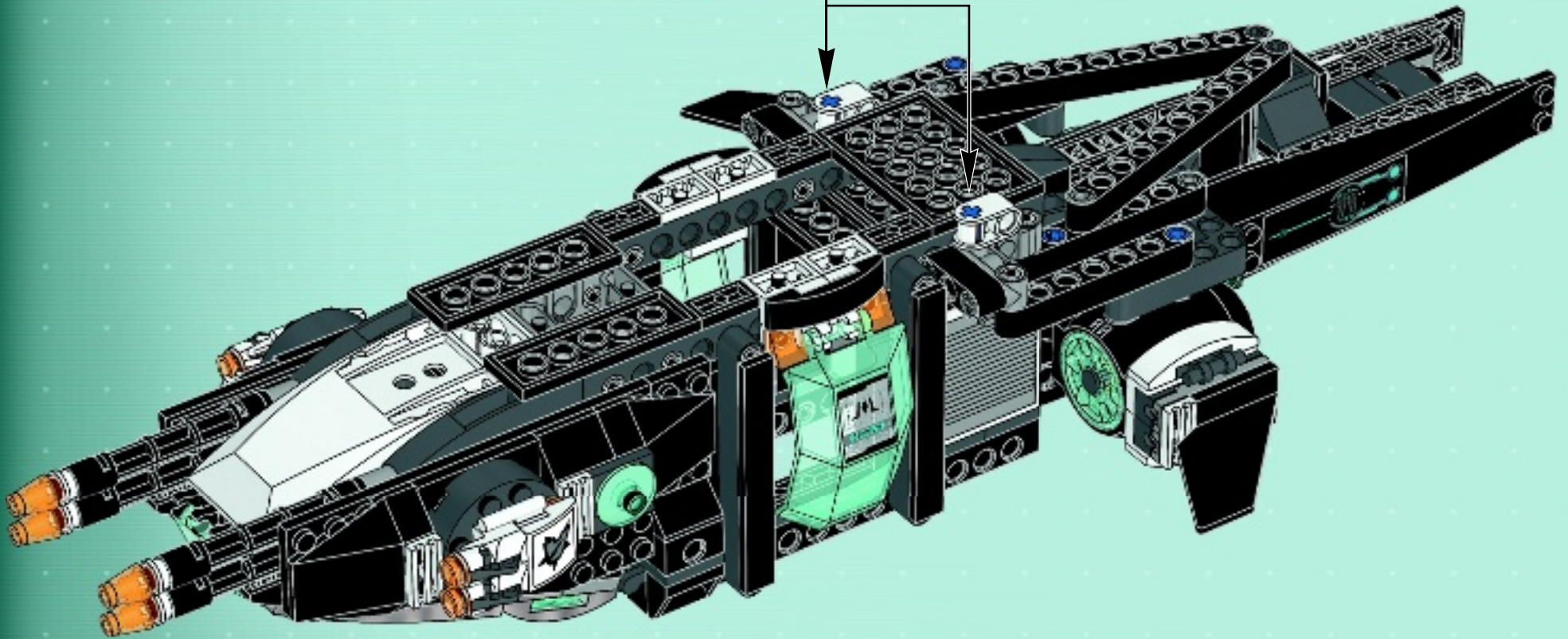
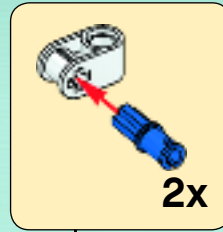



# 53

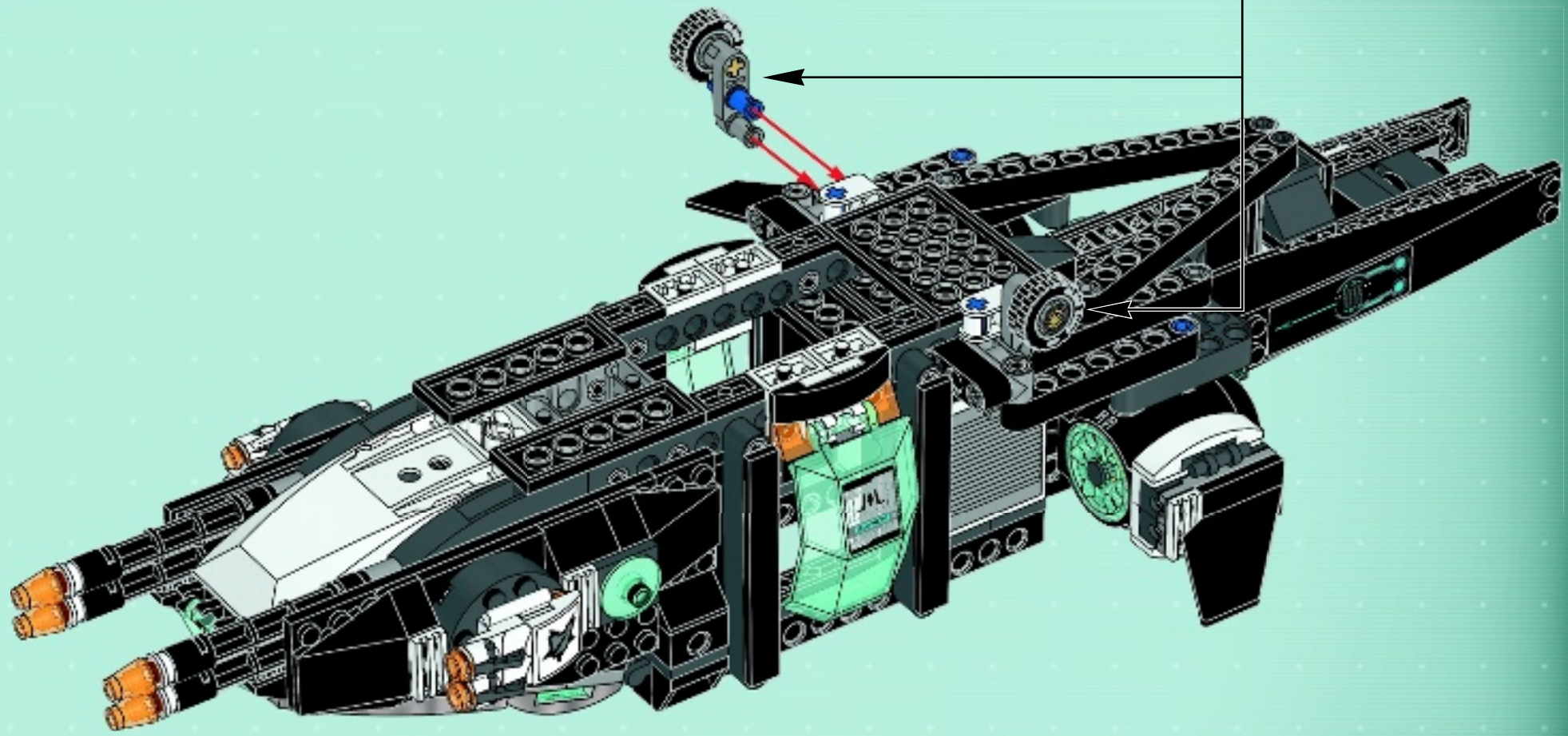
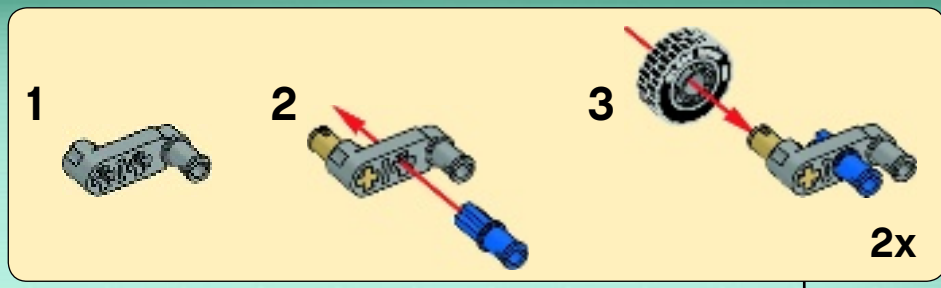





2x

2x

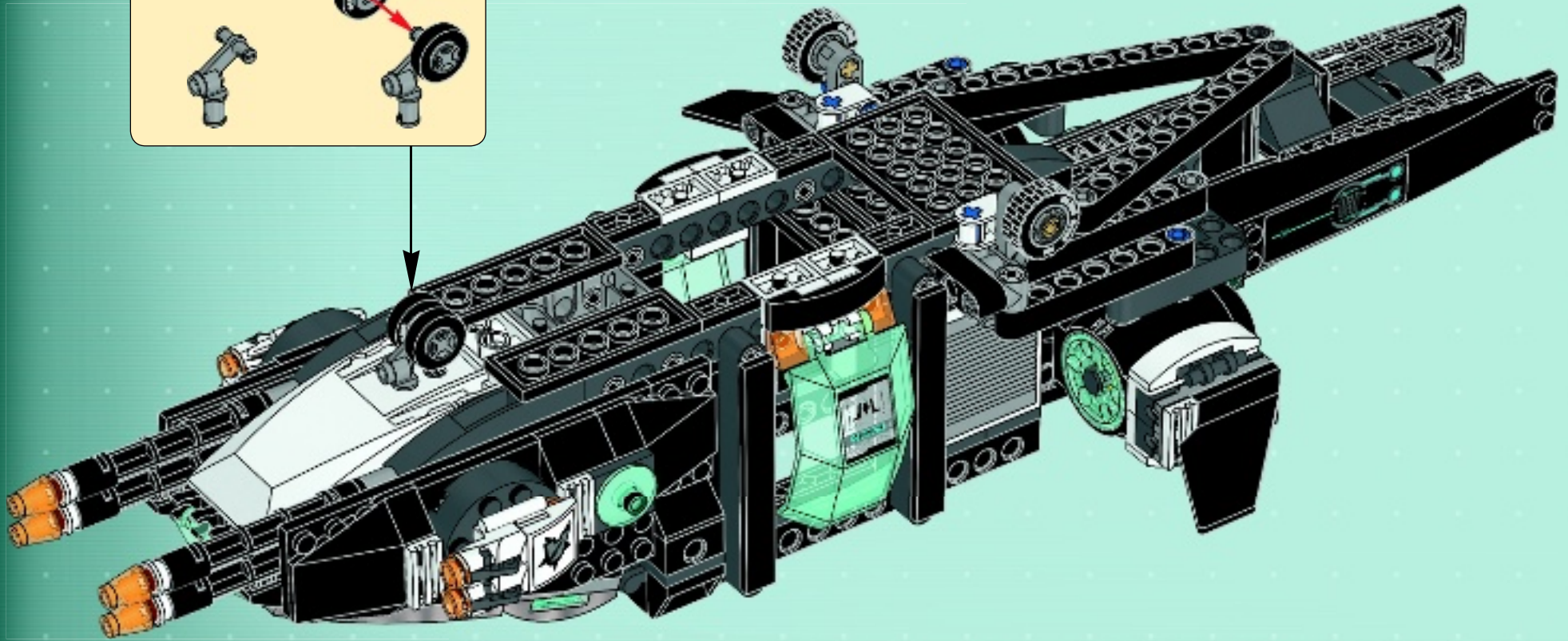
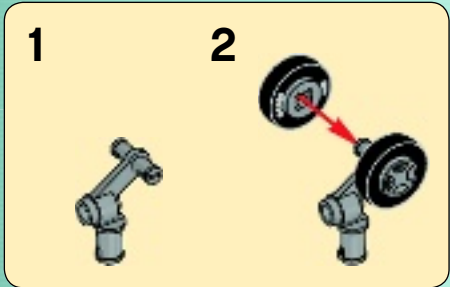
1x

# 54



- 1x 
- 2x 
- 1x 

# 55

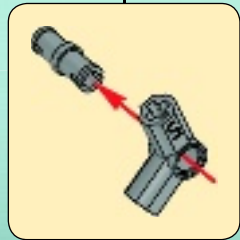
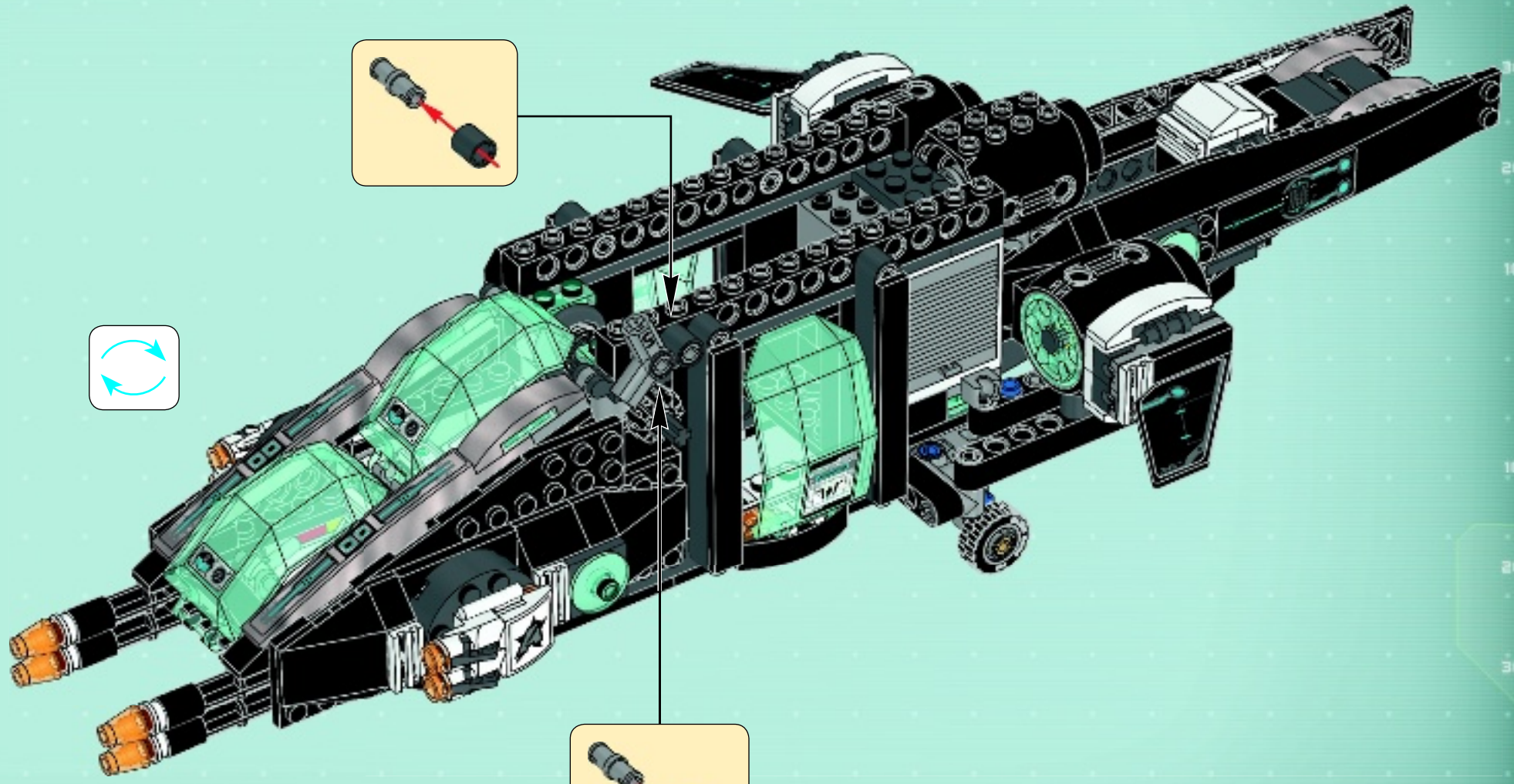
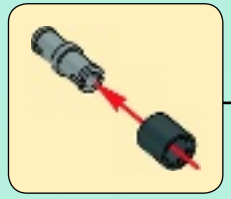
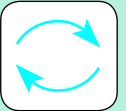

1x

1x

1x

# 56

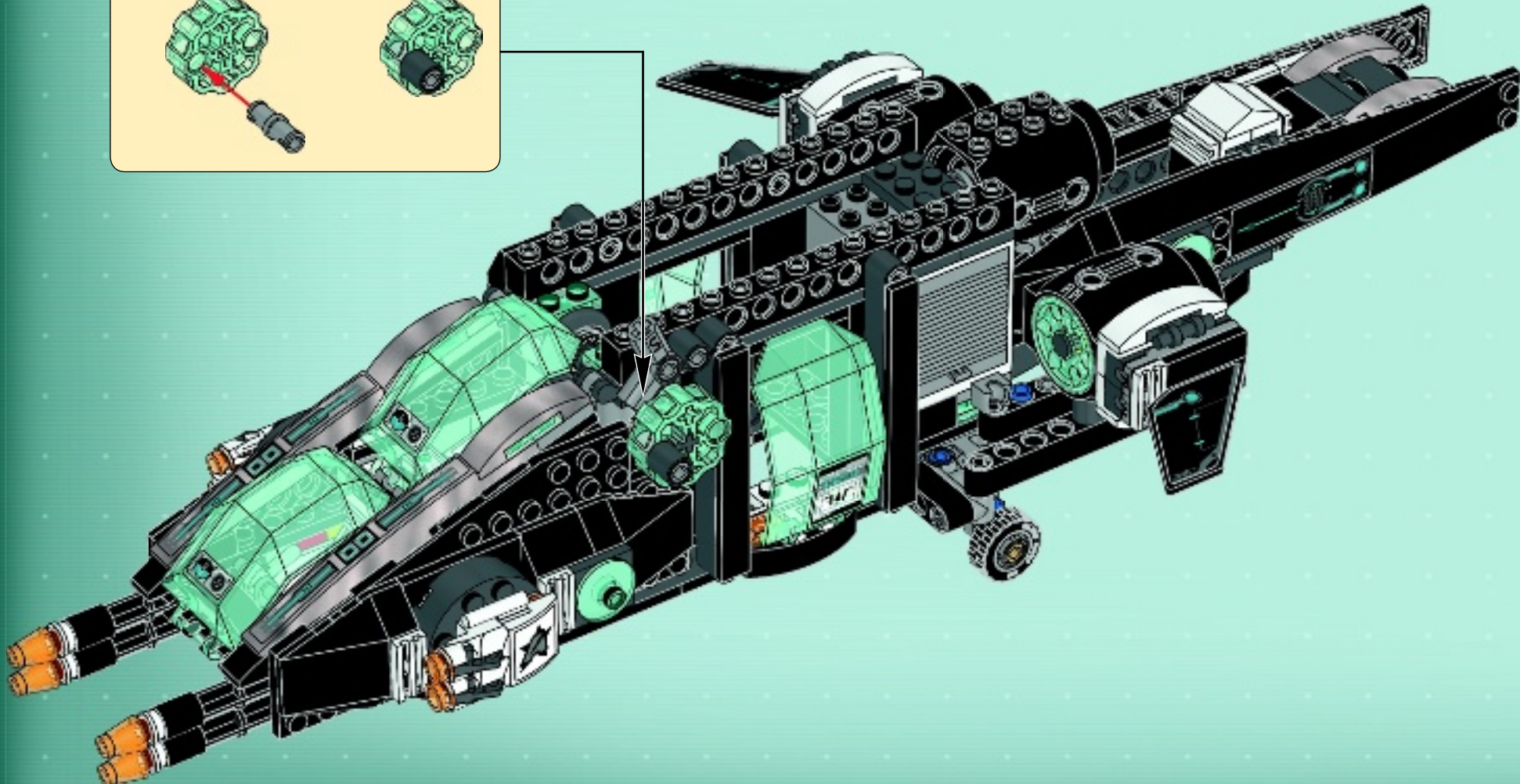
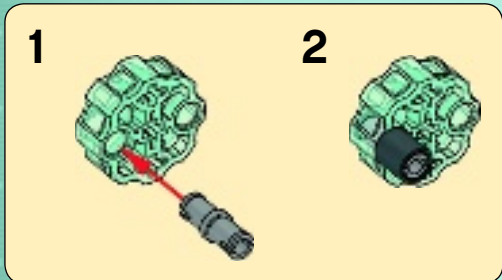



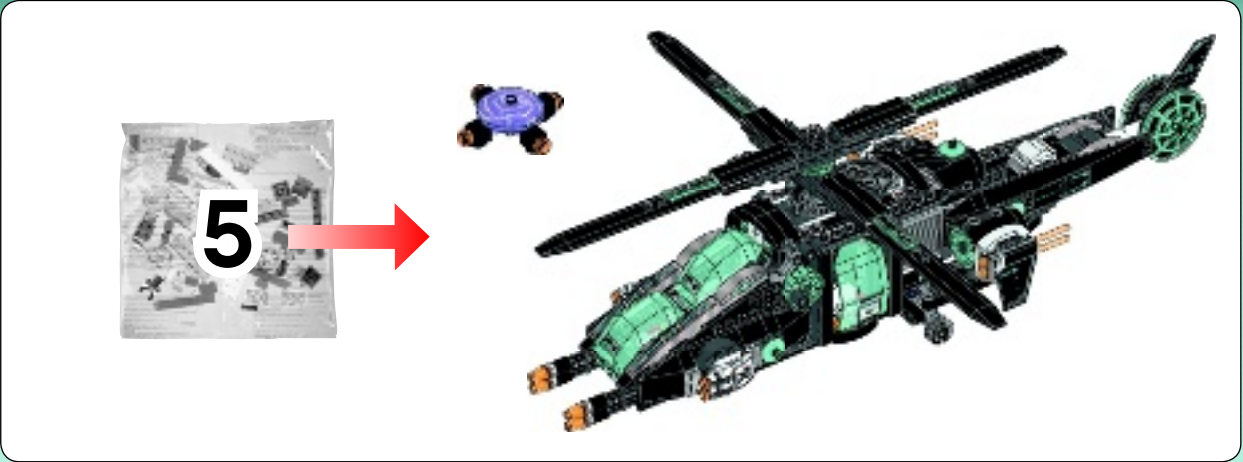

57

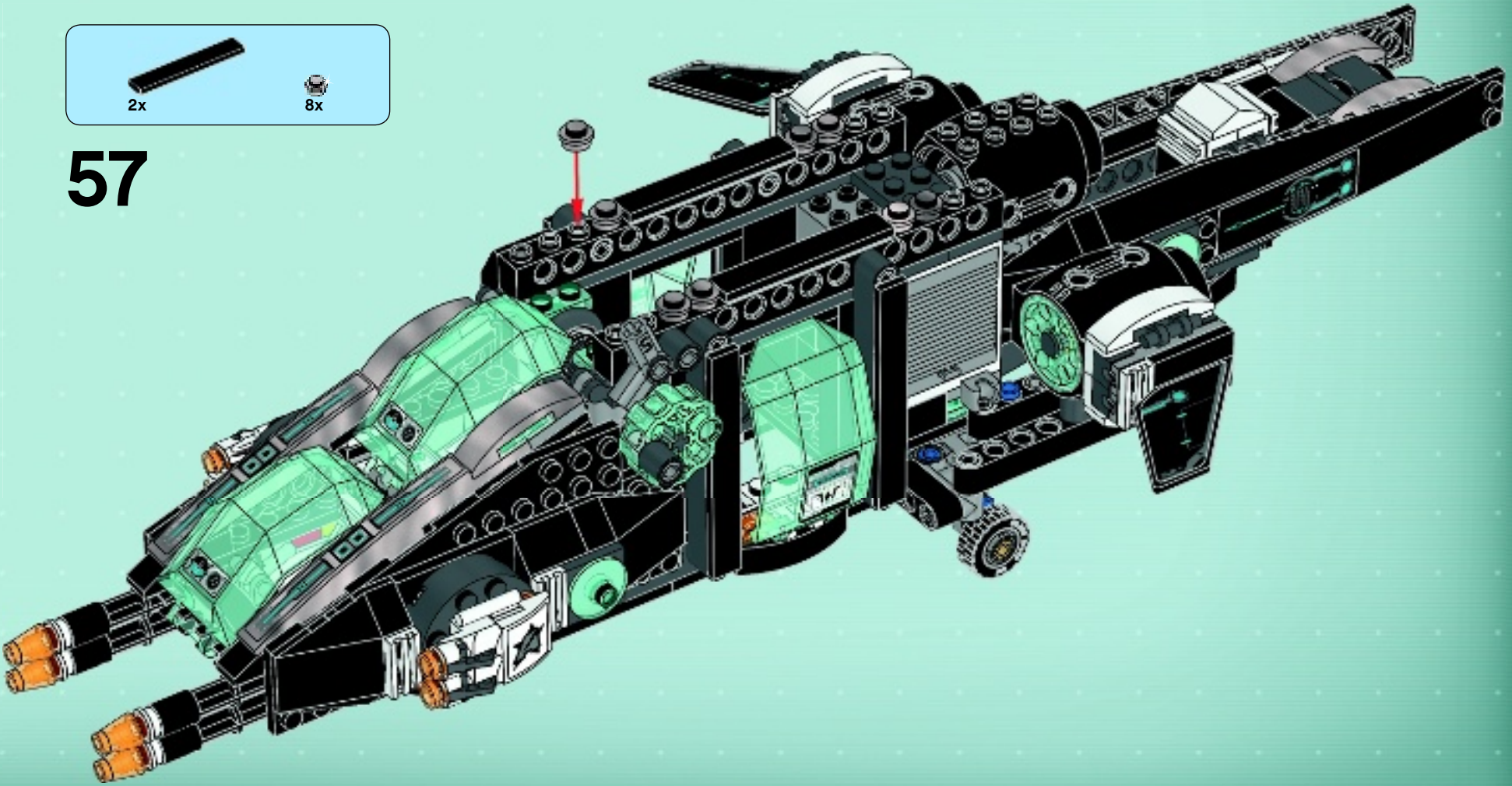



1

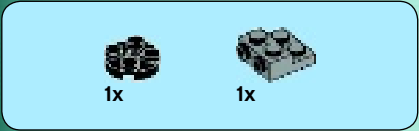

2

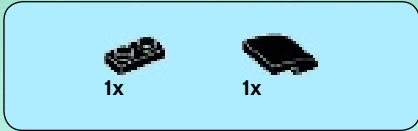

3

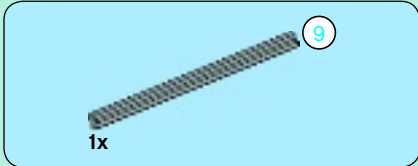
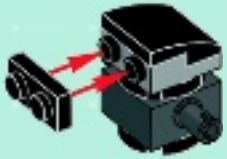

4



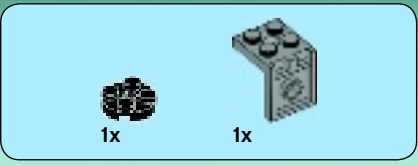

5

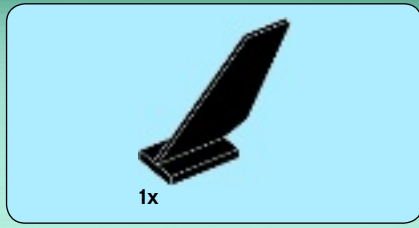
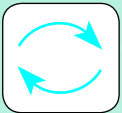

6

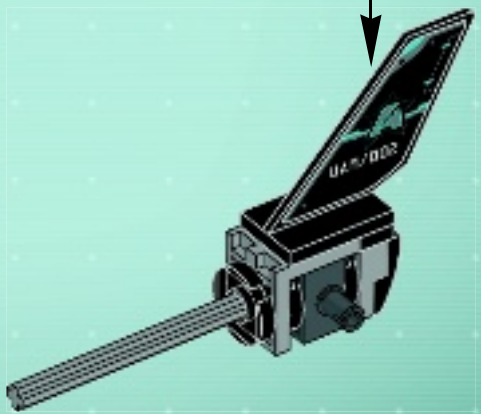
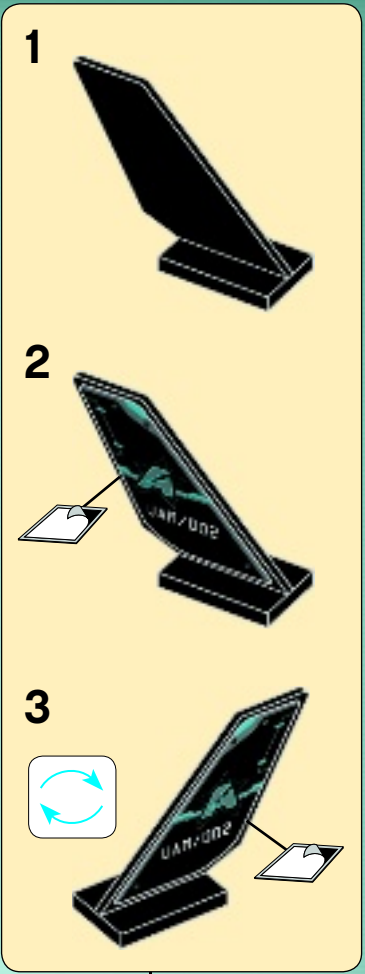



7

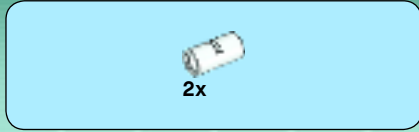
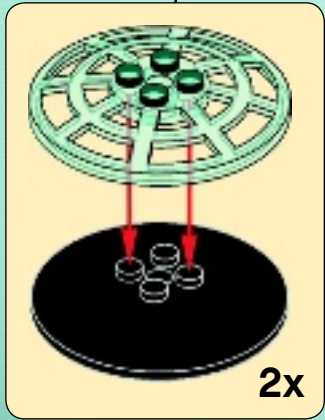
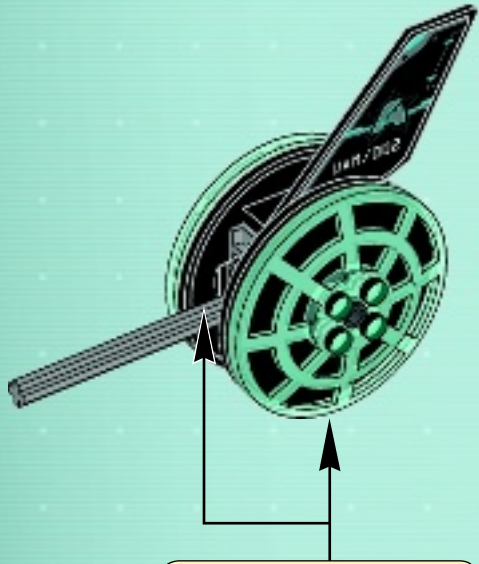

8

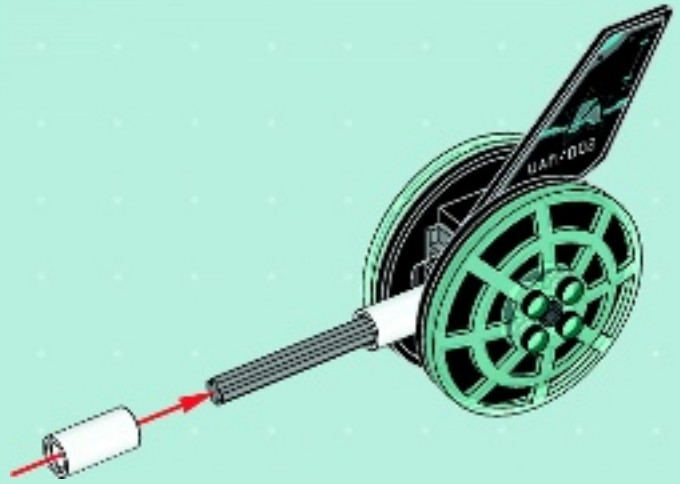

# 58

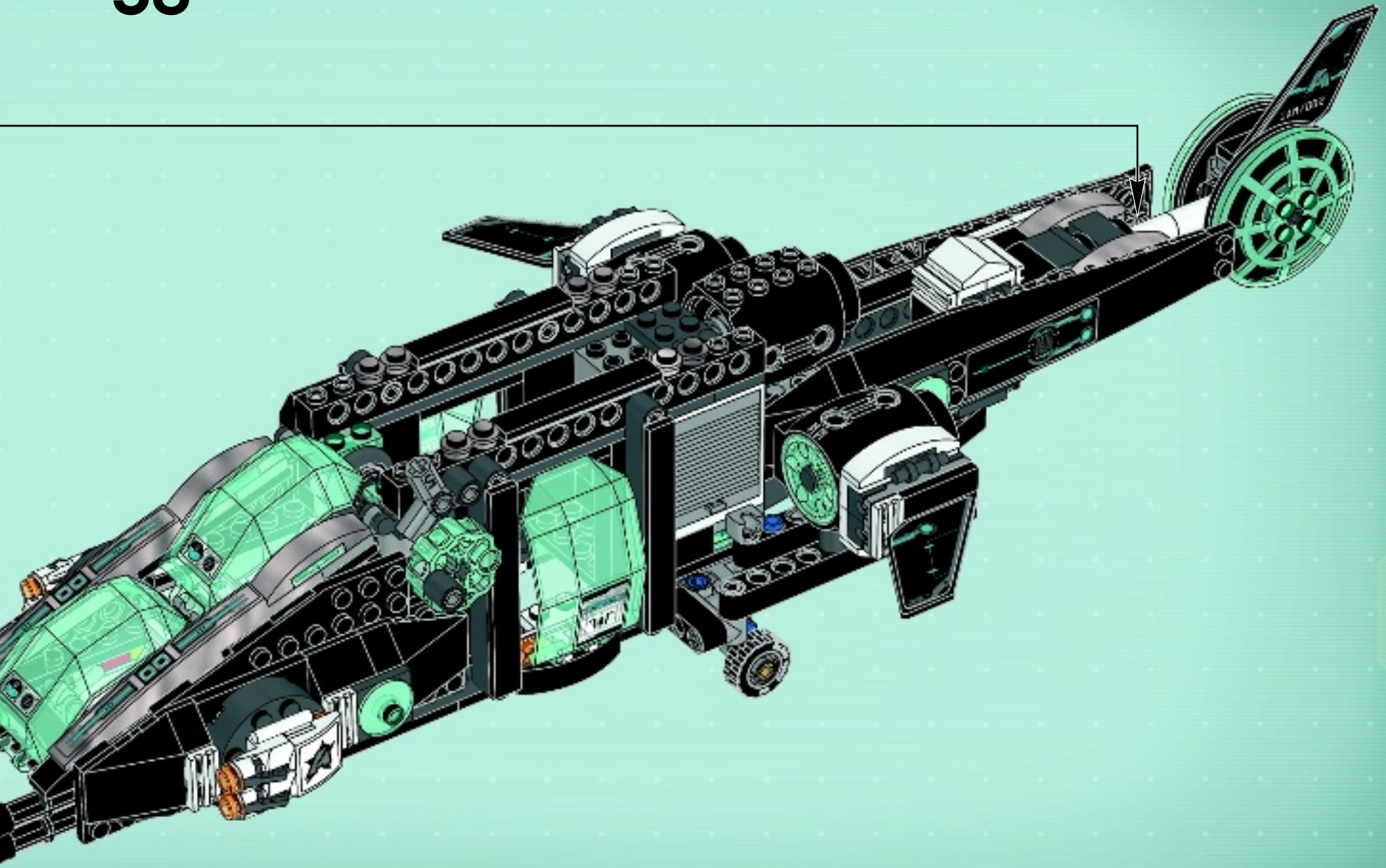

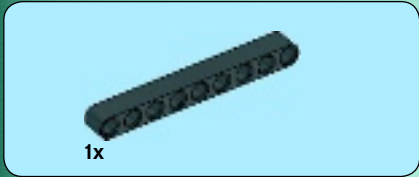
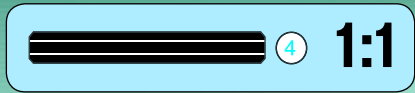
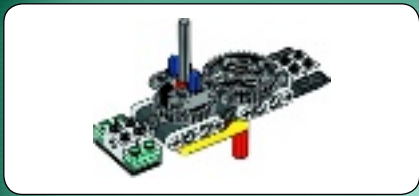

1



2

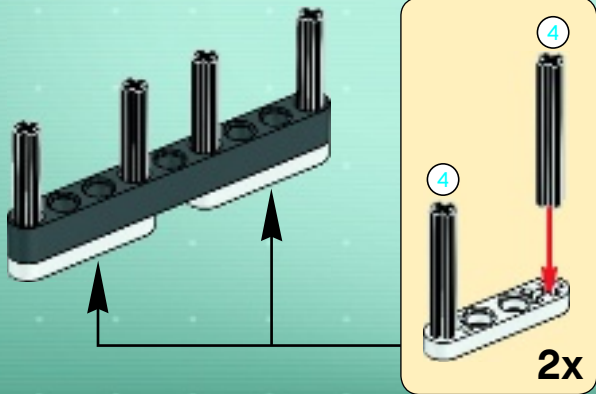

3

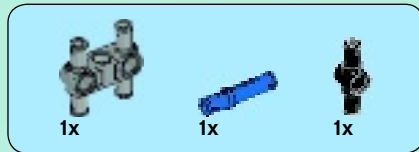
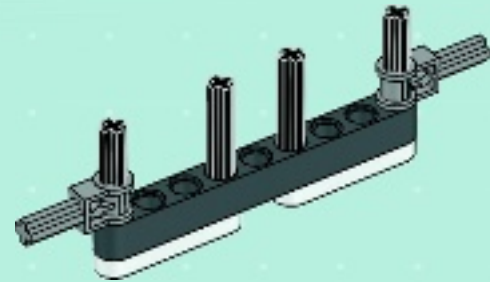

4





5

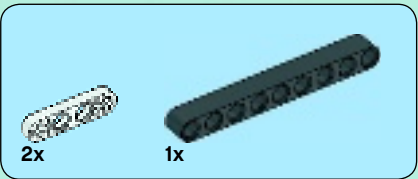
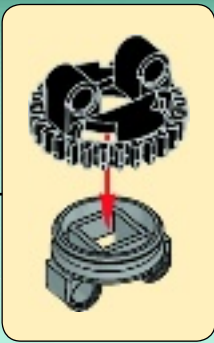
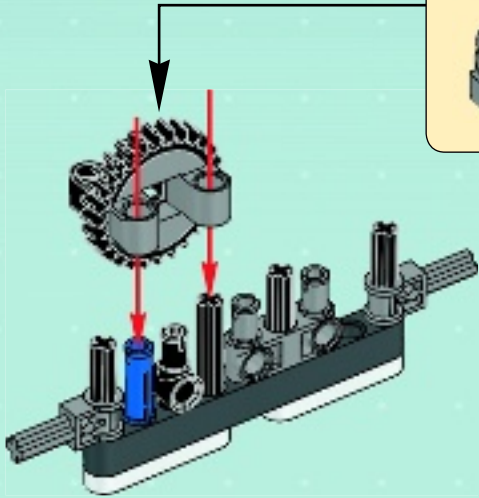

6

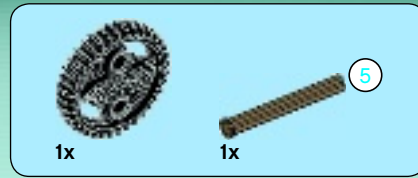
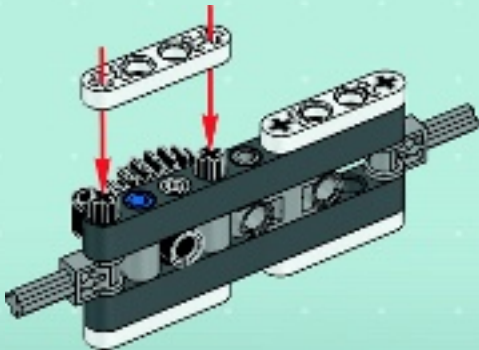

7

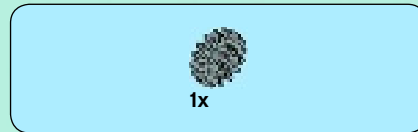
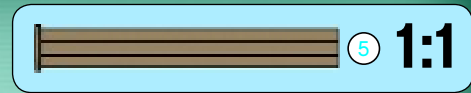
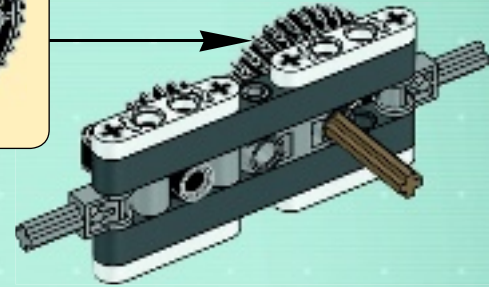
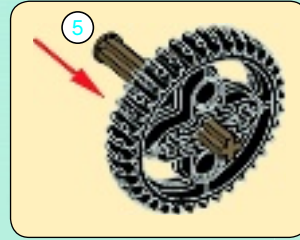

8



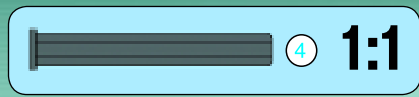
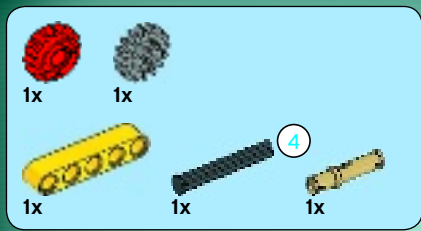

9

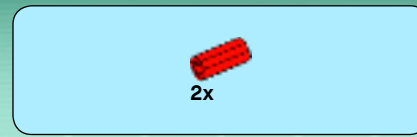
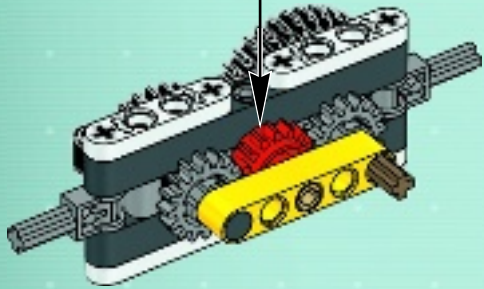
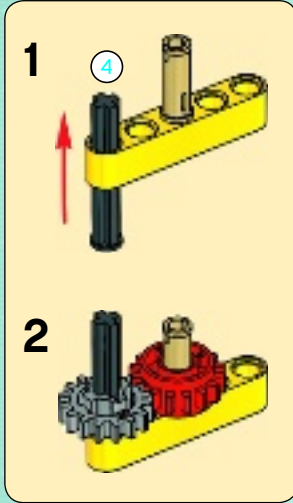

10

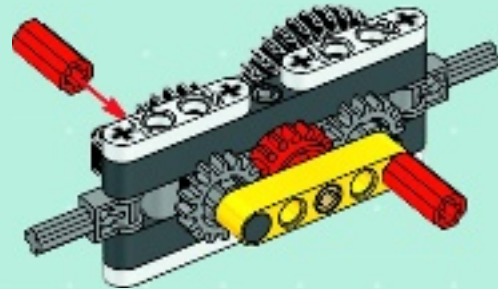





11

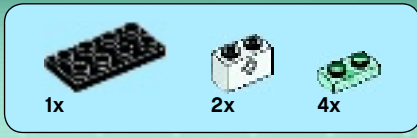
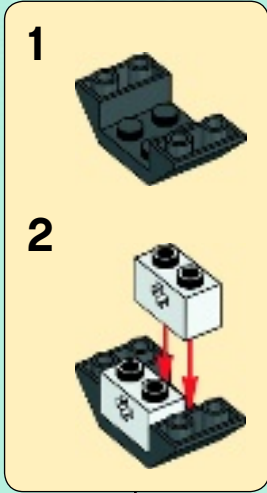

12

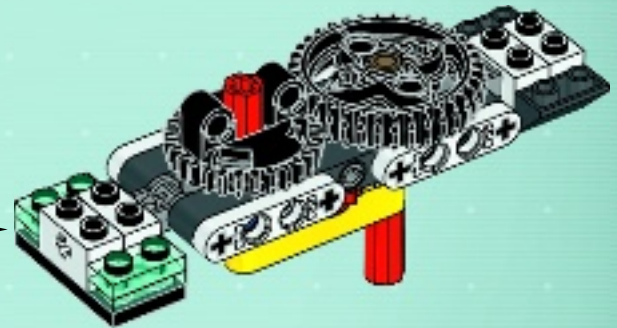
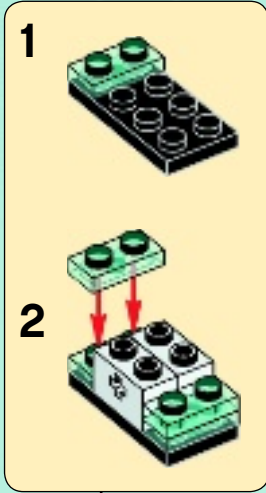

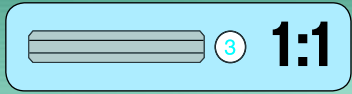
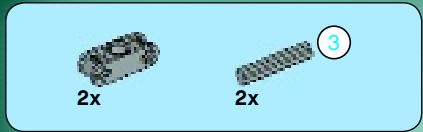

13

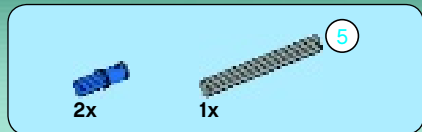
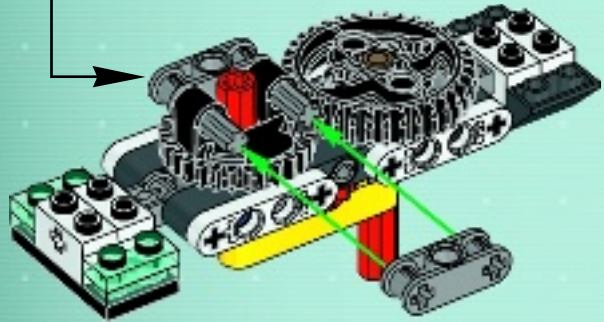
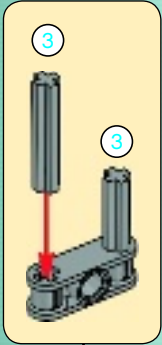

14

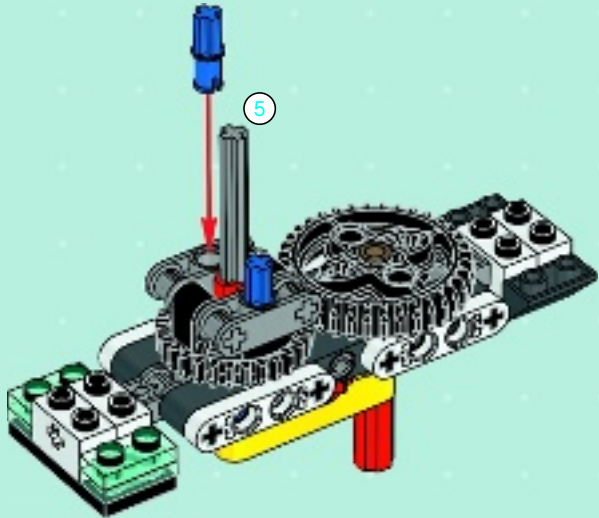

59

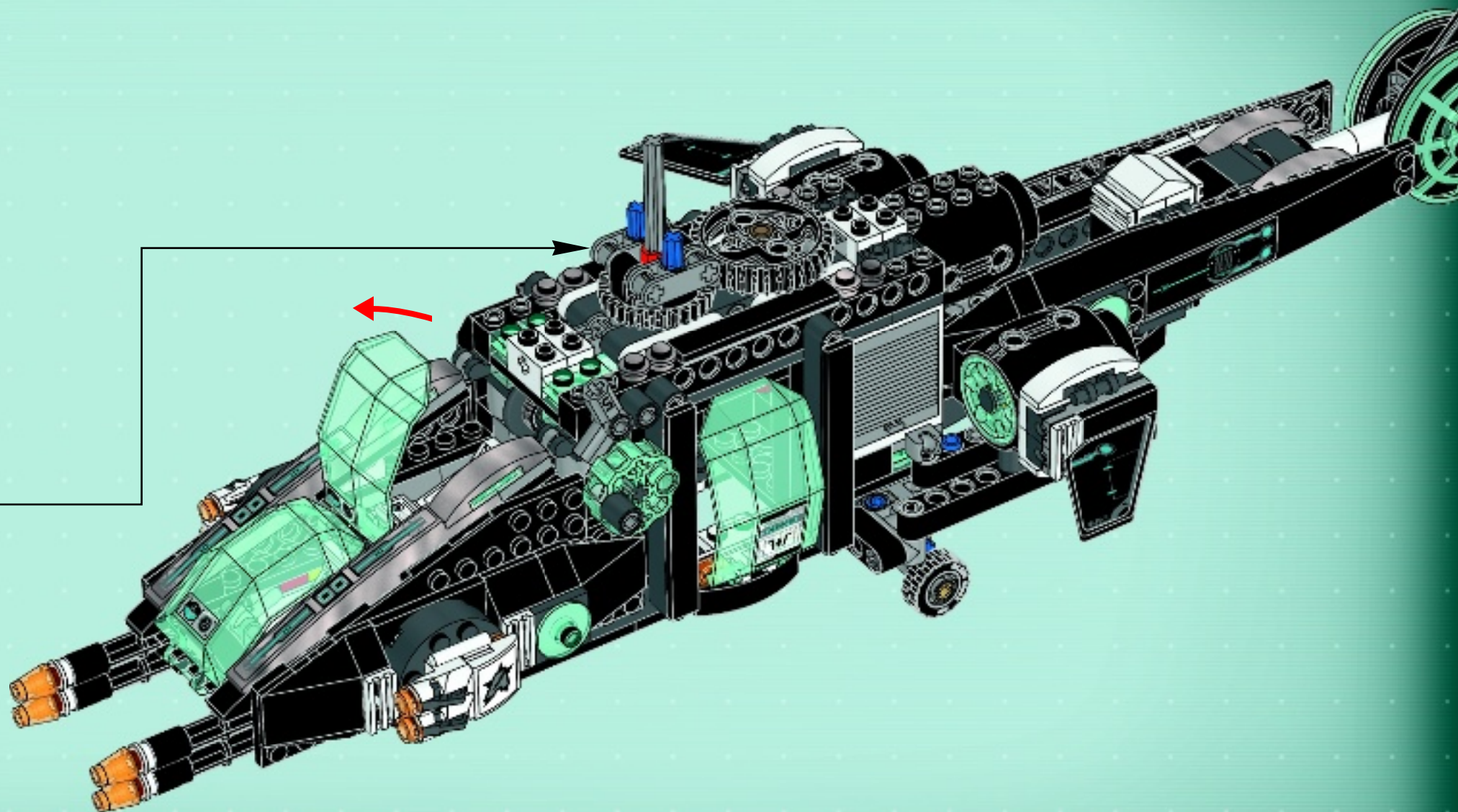



2x



1x



2x

# 60

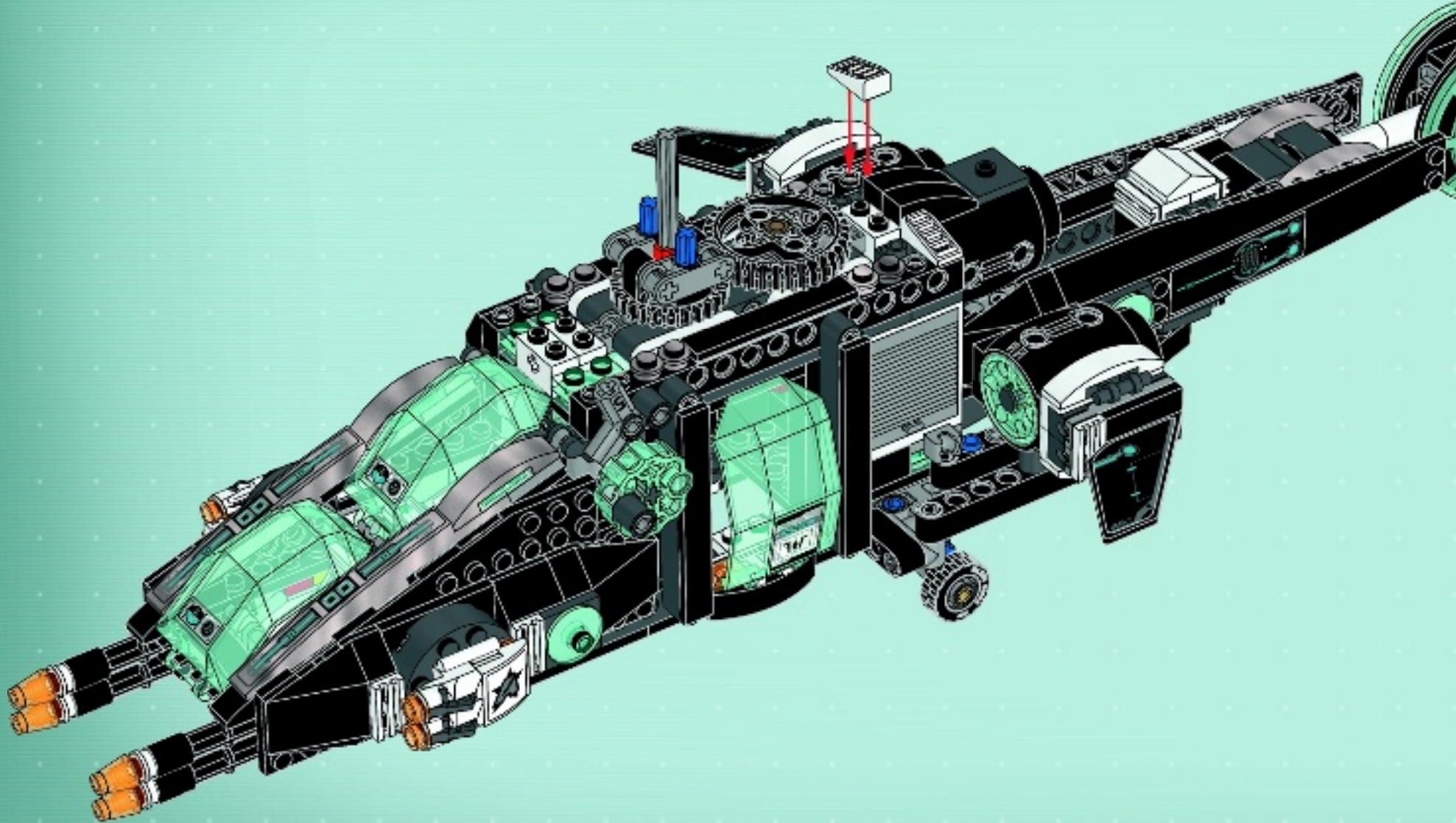



6x



1x

# 61

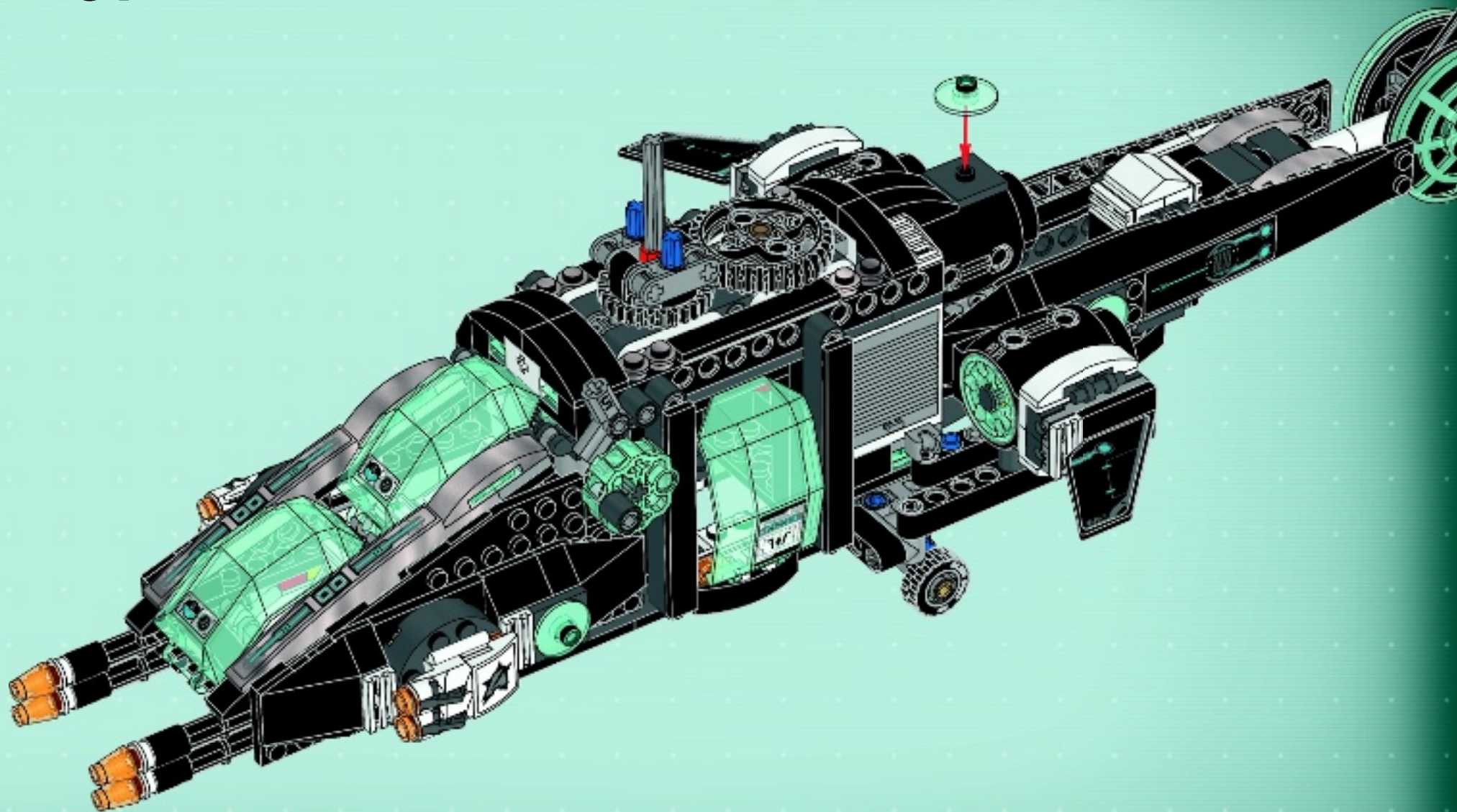

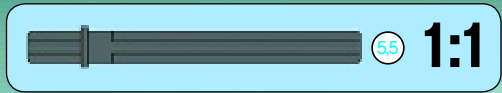
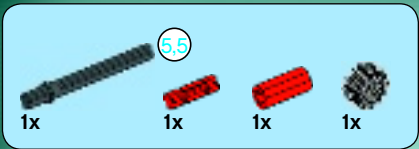

62

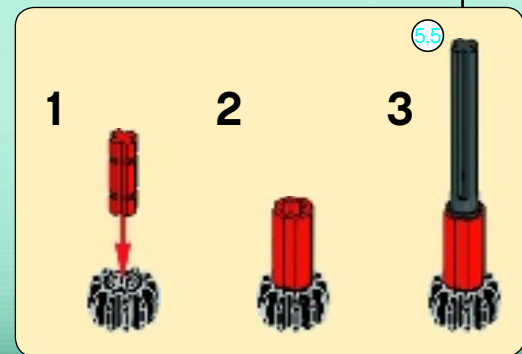
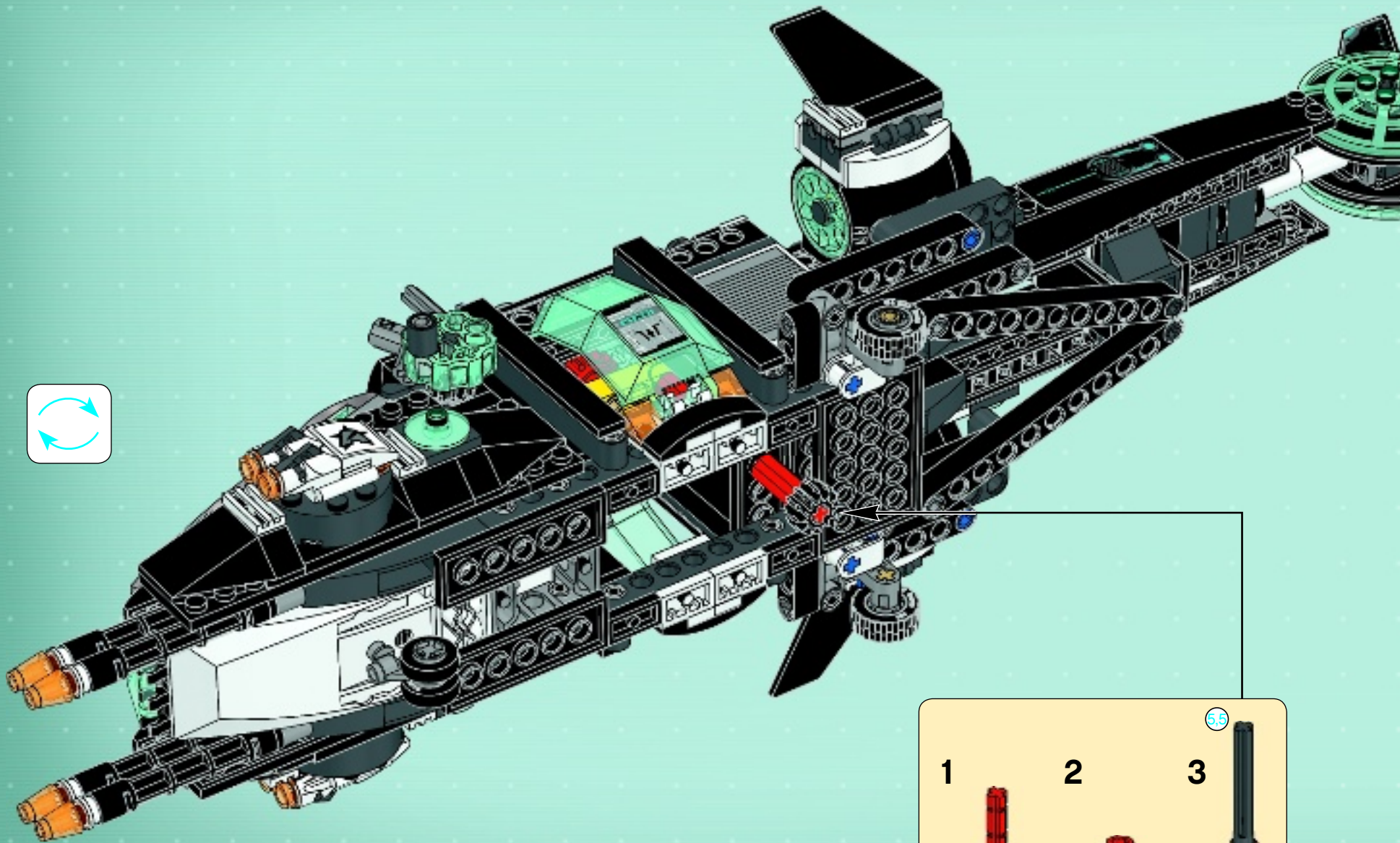

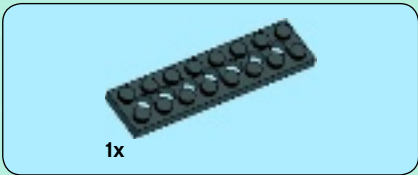
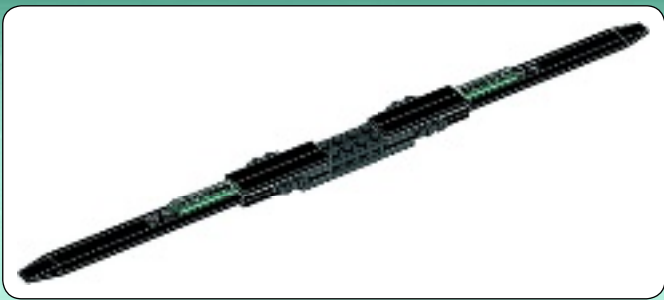

1



2

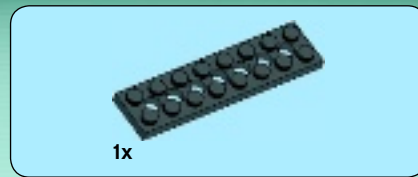

3

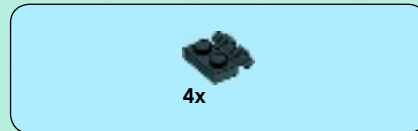

4

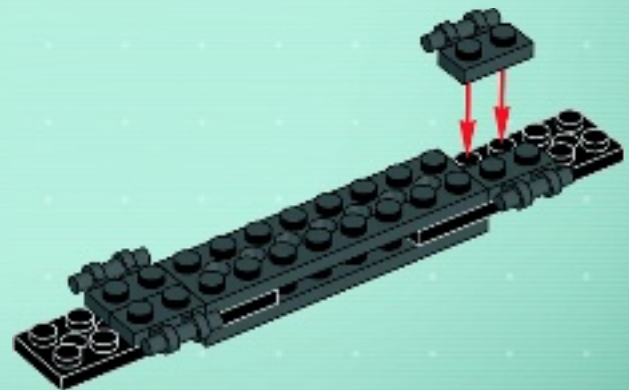

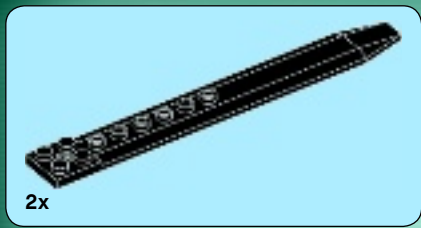

5

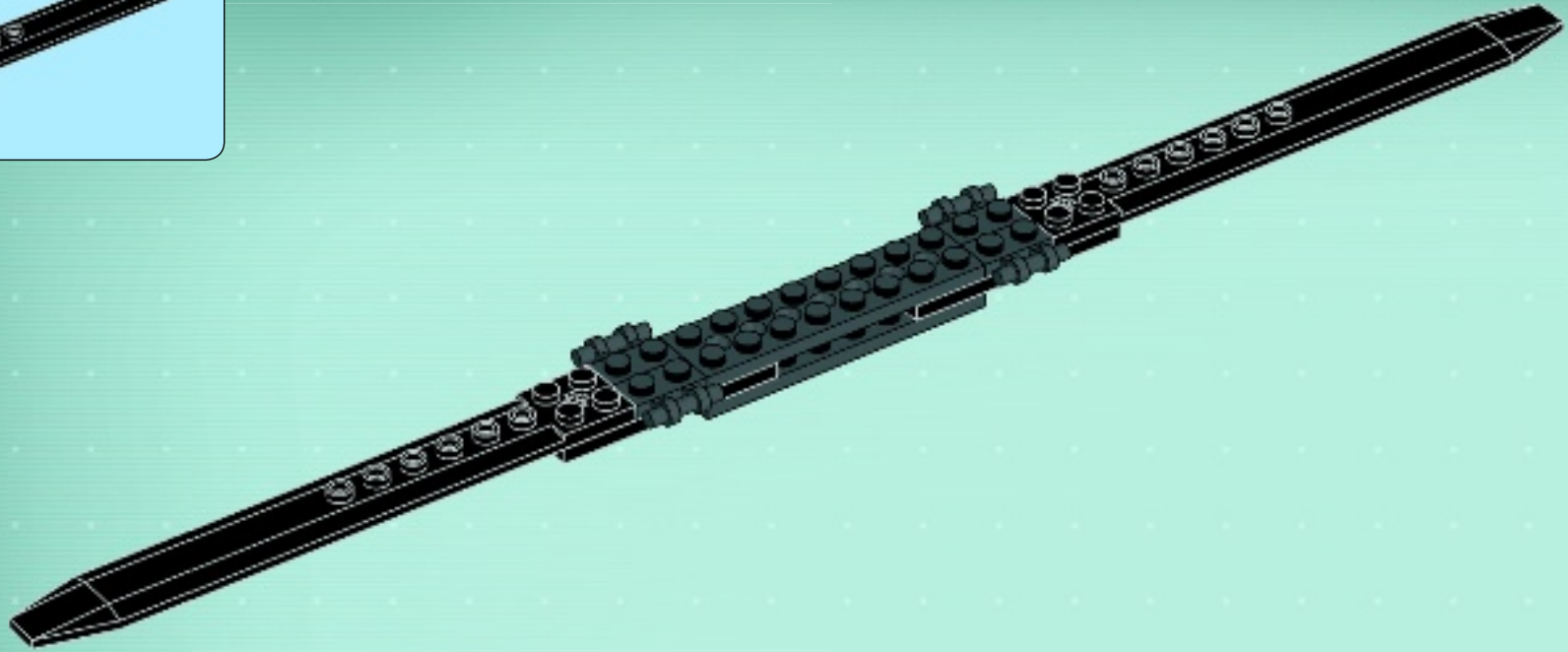

6

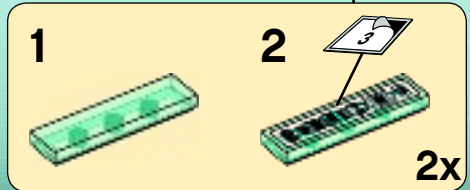
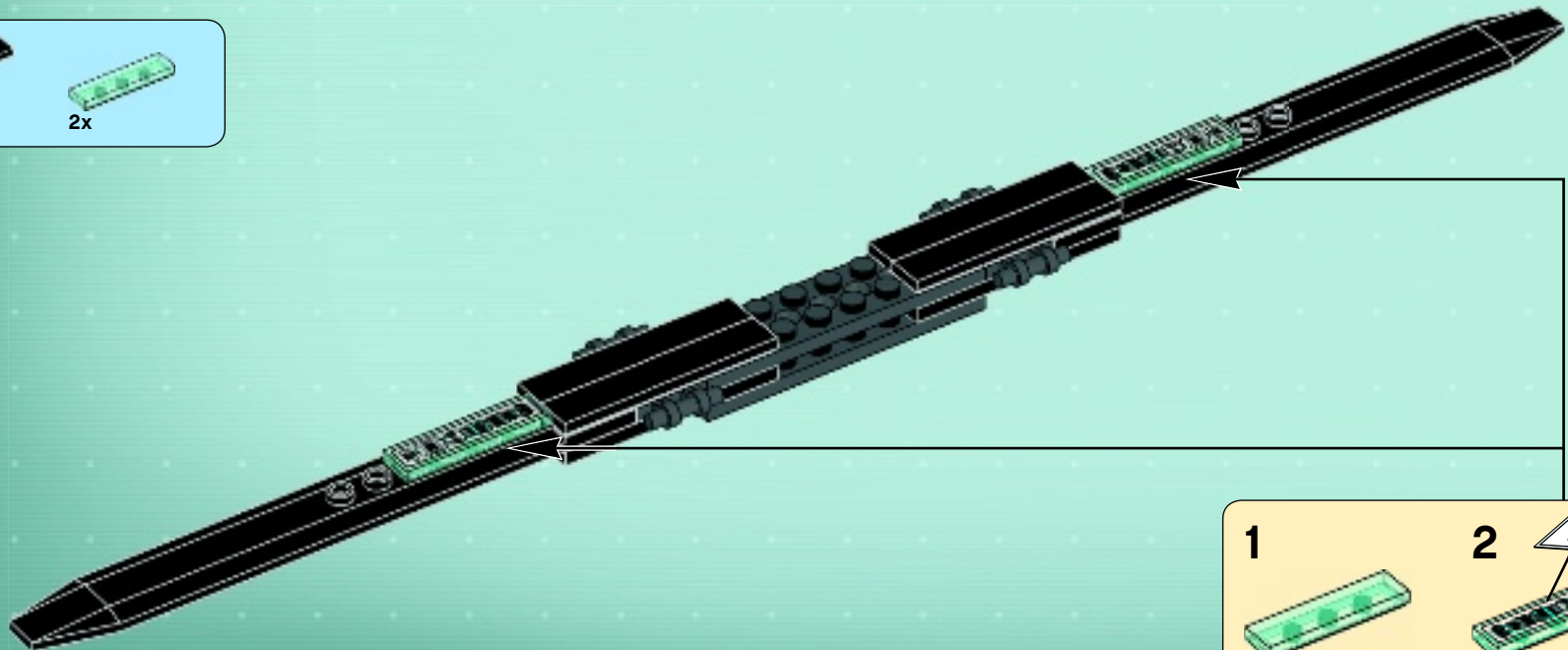



63

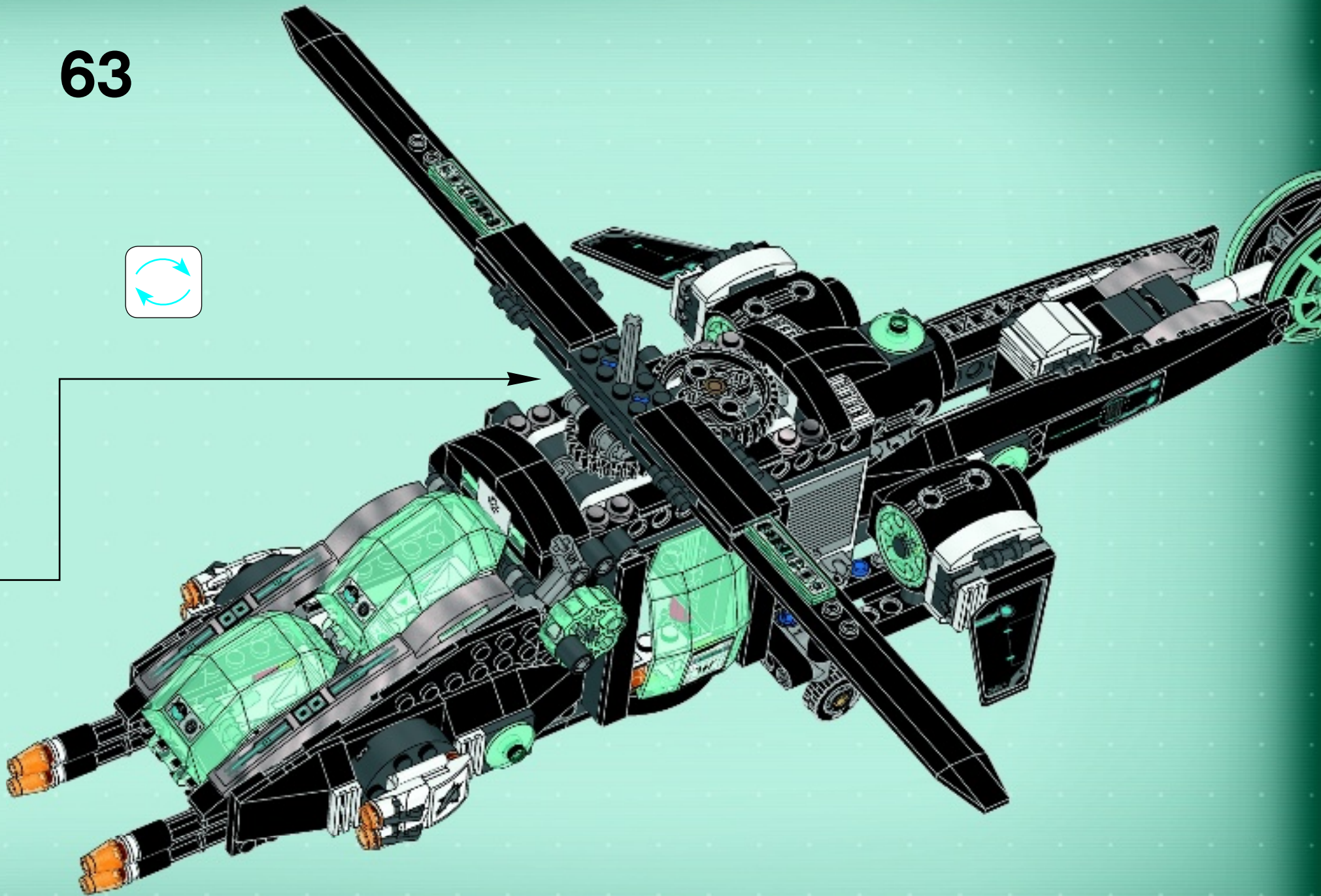
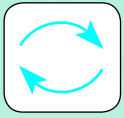



1x

64



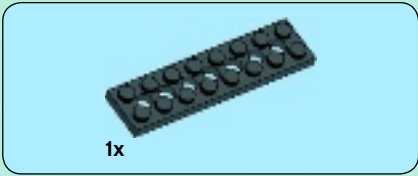
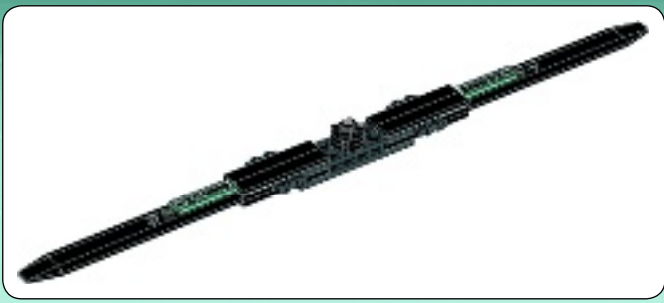

1



2

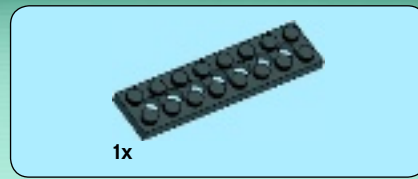

3

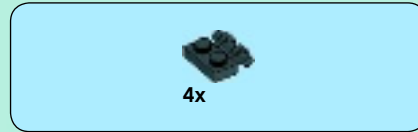

4

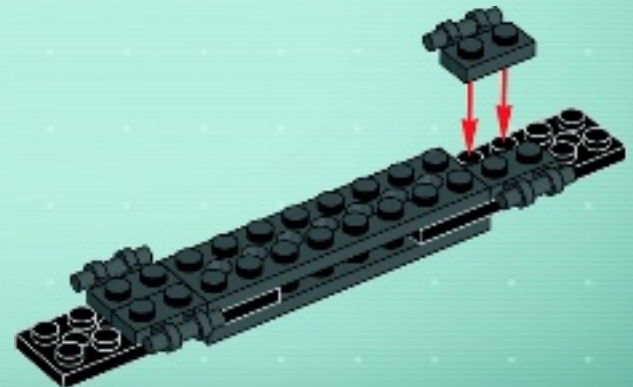

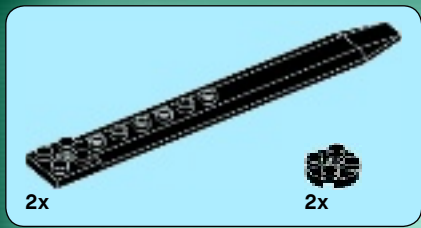

5

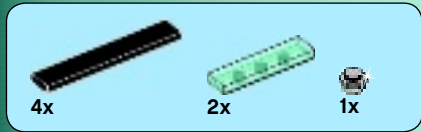
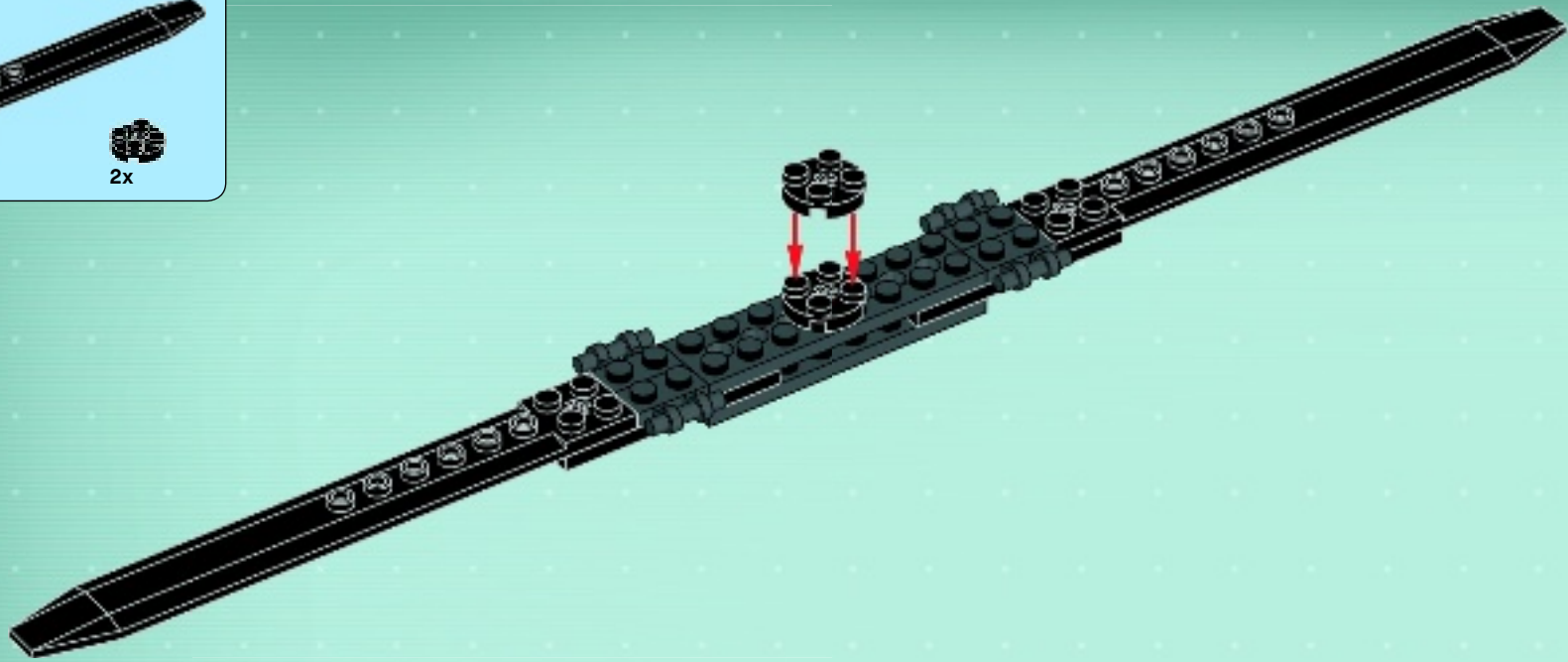

6

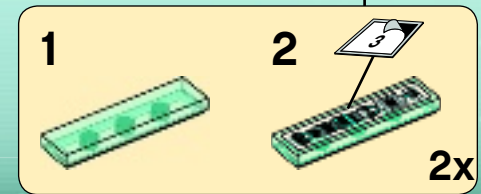
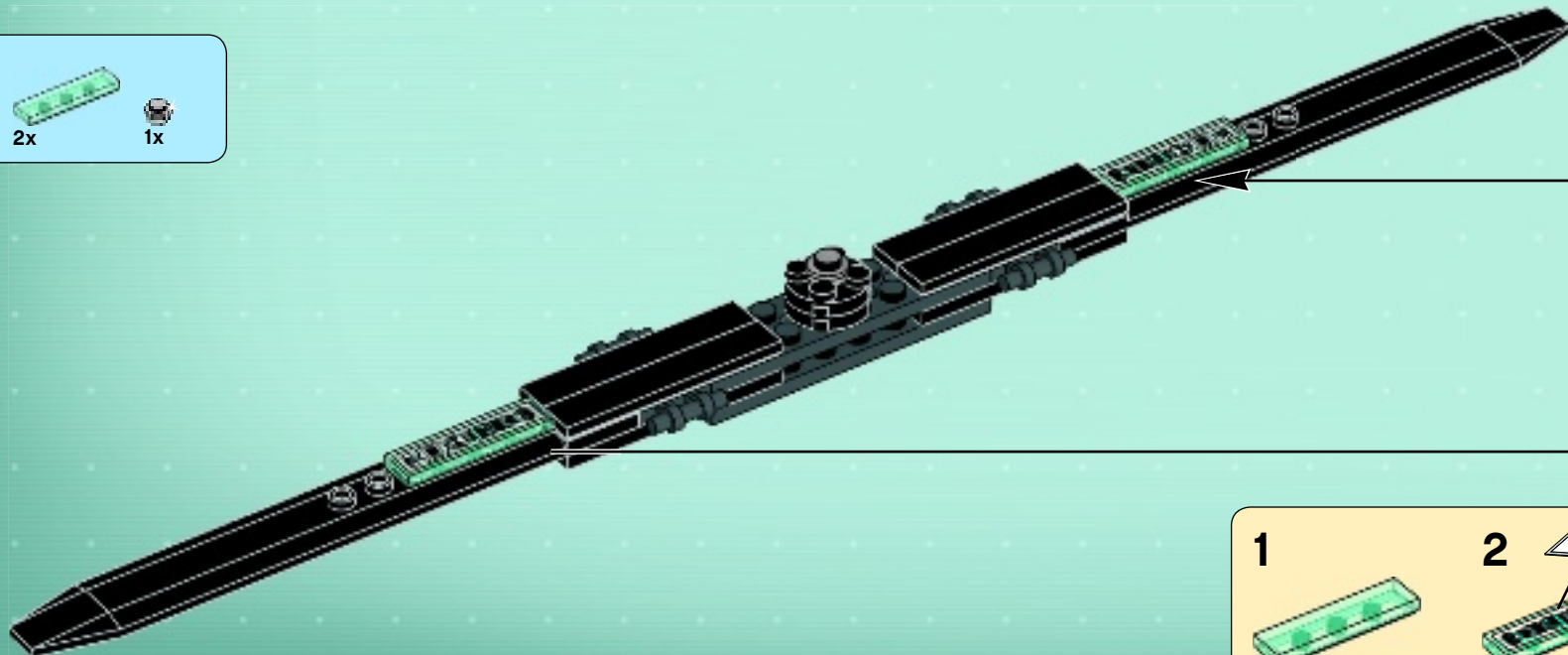

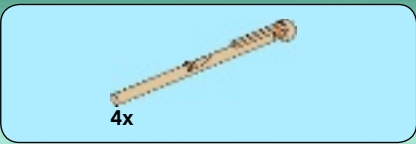

# 65

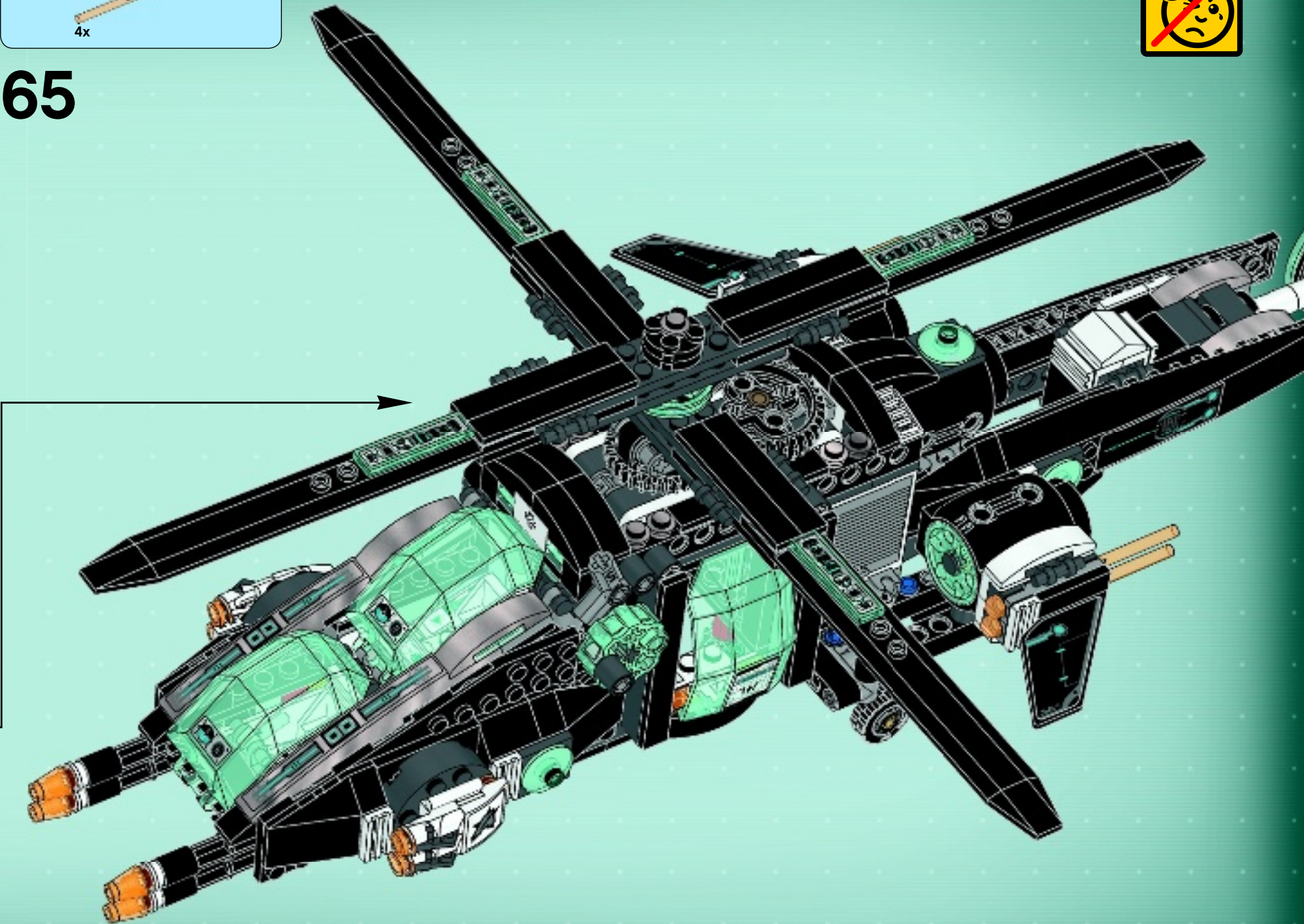



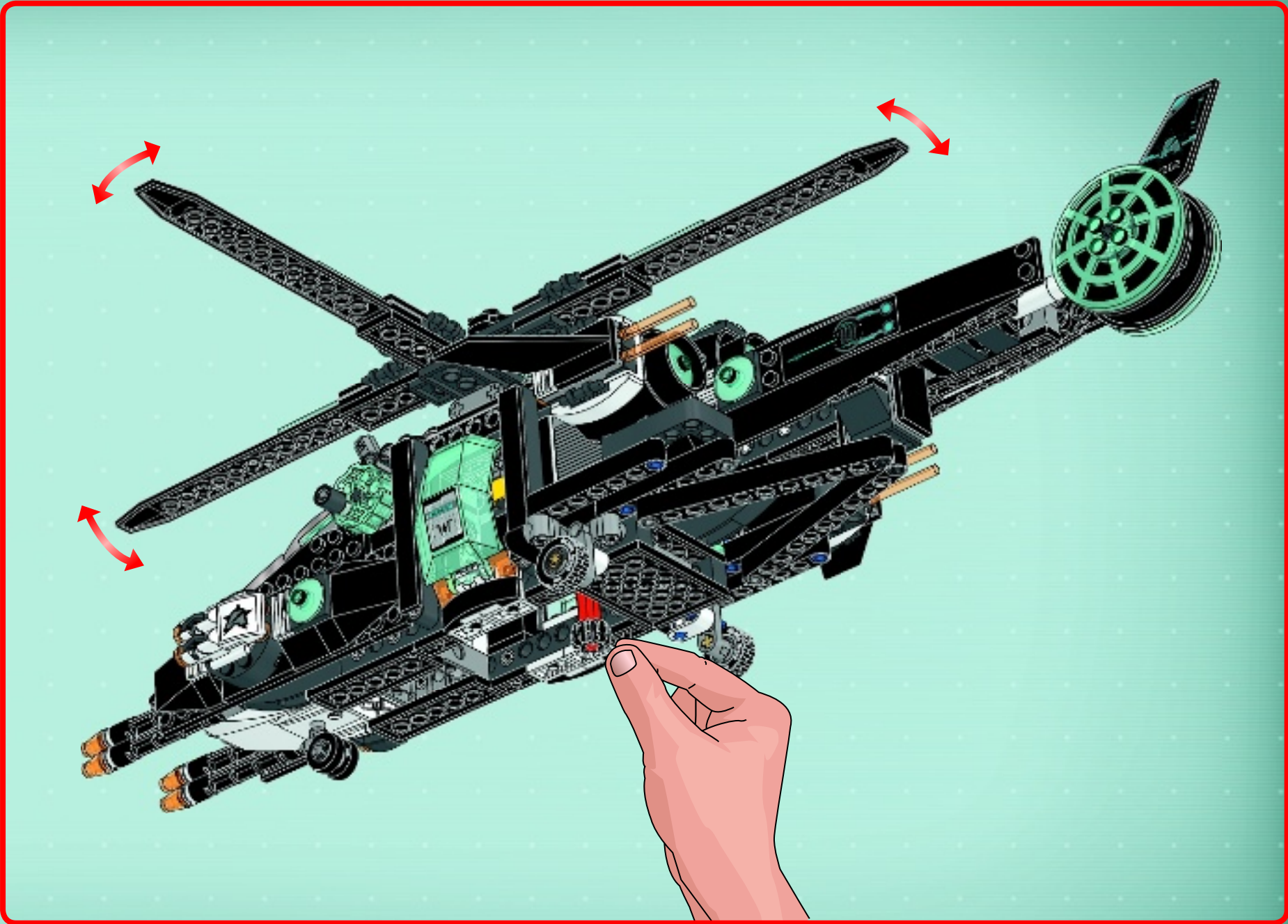



1



2



3

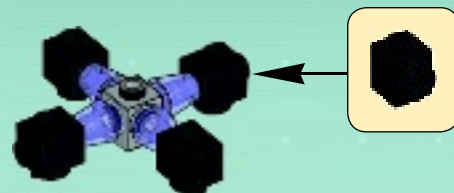

4



5





**Download the app and use the AppBrick  
Gadget to complete the mission!**

**Télécharge l'appli et utilise le gadget  
AppliBrique pour réussir la mission !**

**¡Descarga la app y usa el AppBrick  
para completar la misión!**



Apple, the Apple logo, iPad, iPhone and iPod touch are trademarks of Apple Inc., registered in the U.S. and other countries. App Store is a service mark of Apple Inc. Apple, le logo Apple, iPad, iPhone et iPod touch sont des marques de commerce d'Apple Inc., déposées aux Etats-Unis et dans d'autres pays. App Store est une marque de service d'Apple Inc. Apple, el logotipo de Apple, iPad, iPhone e iPod touch son marcas comerciales de Apple Inc. registradas en EE. UU. y otros países. App Store es una marca de servicio de Apple Inc. Google Play is a trademark of Google Inc. Google Play est une marque de commerce de Google Inc. Google Play es una marca comercial de Google Inc.

***Unlock the secrets with the new AppBrick Gadgets***

***Découvre les secrets avec les nouveaux gadgets AppliBrique***

***Descubre los secretos con los nuevos AppBricks***





# ULTRA AGENTS



70168



70169



70166



70167



70170



42037

42038





42039

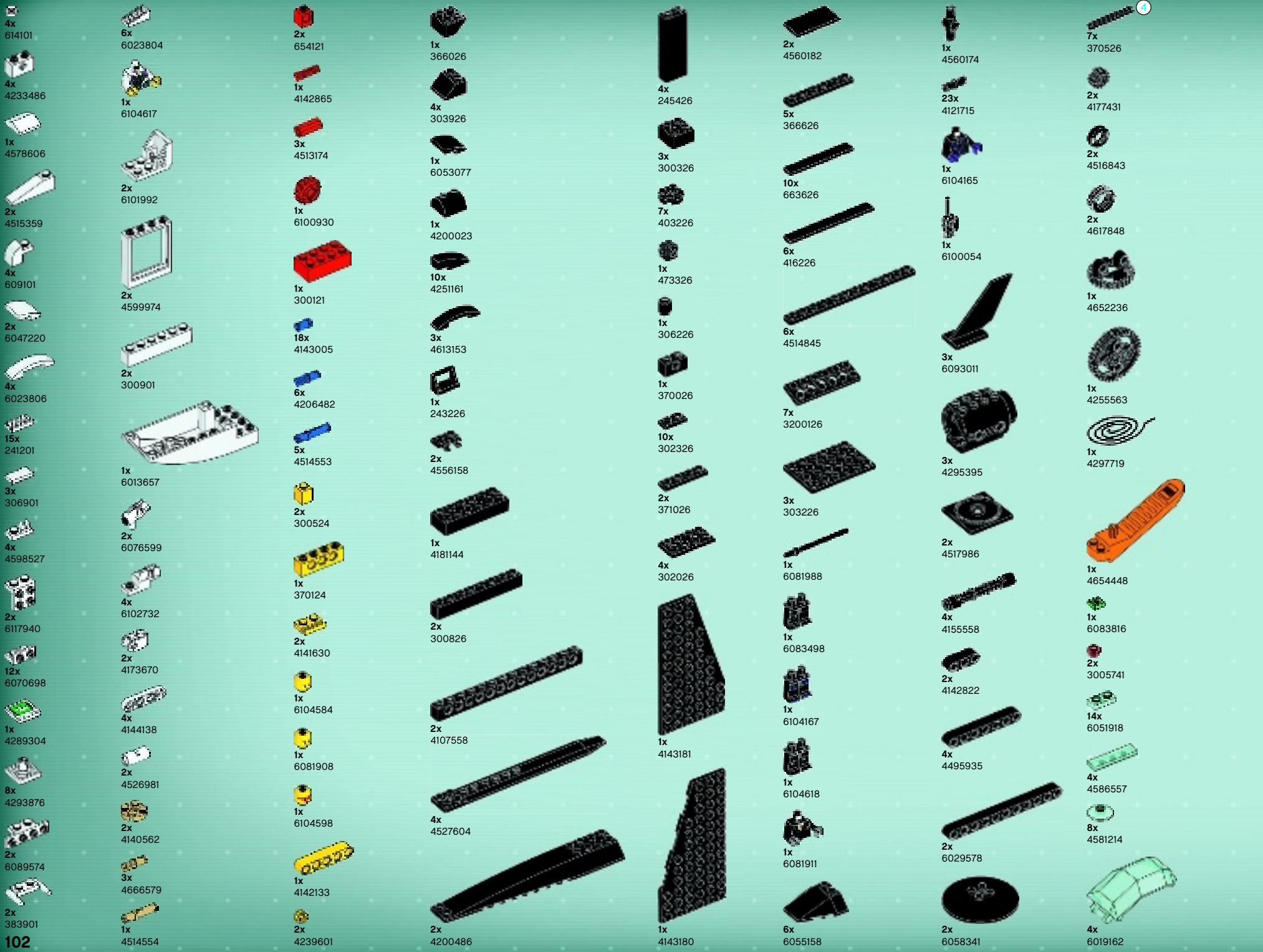

4x 614101  
 4x 4233486  
 1x 4578606  
 2x 4515359  
 4x 609101  
 2x 6047220  
 4x 6023806  
 15x 241201  
 3x 306901  
 4x 4598527  
 2x 6117940  
 12x 6070698  
 1x 4289304  
 8x 4293876  
 2x 6089574  
 2x 383901

6x 6023804  
 1x 6104617  
 2x 6101992  
 2x 4599974  
 2x 300901  
 1x 6013657  
 2x 6076599  
 4x 6102732  
 2x 4173670  
 4x 4144138  
 2x 4526981  
 2x 4140562  
 3x 4666579  
 1x 4514554

2x 654121  
 1x 4142865  
 3x 4513174  
 1x 6100930  
 1x 300121  
 18x 4143005  
 6x 4206482  
 5x 4514553  
 2x 300524  
 1x 370124  
 2x 4141630  
 1x 6104584  
 1x 6081908  
 1x 6104598  
 1x 4142133  
 2x 4239601

1x 366026  
 4x 303926  
 1x 6053077  
 1x 4200023  
 10x 4251161  
 3x 4613153  
 1x 243226  
 2x 4556158  
 1x 4181144  
 2x 300826  
 2x 4107558  
 4x 4527604  
 2x 4200486

4x 245426  
 3x 300326  
 7x 403226  
 1x 473326  
 1x 306226  
 1x 370026  
 10x 302326  
 2x 371026  
 4x 302026  
 1x 4143181  
 1x 4143180

2x 4560182  
 5x 366626  
 10x 663626  
 6x 416226  
 6x 4514845  
 7x 3200126  
 3x 303226  
 1x 6081988  
 1x 6083498  
 1x 6104167  
 1x 6104618  
 1x 6081911  
 6x 6055158

1x 4560174  
 23x 4121715  
 1x 6104165  
 1x 6100054  
 3x 6093011  
 3x 4295395  
 2x 4517986  
 4x 4155558  
 2x 4142822  
 4x 4495935  
 2x 6029578  
 2x 6058341

7x 370526  
 2x 4177431  
 2x 4516843  
 2x 4617848  
 1x 4652236  
 1x 4255563  
 1x 4297719  
 1x 4654448  
 1x 6083816  
 2x 3005741  
 14x 6051918  
 4x 4586557  
 8x 4581214  
 4x 6019162

1x 6097145  
 1x 6103865  
 1x 4654432  
 3x 6096296  
 2x 6081809  
 6x 4567340  
 1x 6104175  
 1x 6106812  
 1x 6101092  
 1x 6104171  
 1x 6103301  
 3x 6101100  
 10x 4222960  
 4x 4567338  
 4x 4244369

5x 6072635  
 1x 4625528  
 1x 6102608  
 1x 6102607  
 1x 6055631  
 3x 4211388  
 1x 4211511  
 9x 4211636  
 3x 6057616  
 2x 6078985  
 1x 4211676  
 2x 4211466  
 1x 4211640  
 1x 6075237

5

1x 4243797  
 2x 4211452  
 2x 6043656  
 2x 4654580  
 3x 4654582  
 4x 4535738  
 1x 4654577  
 1x 6019212  
 1x 4585429  
 2x 4618324  
 1x 4514195  
 2x 4211506  
 1x 4519013  
 1x 4542590

2x 6101993  
 2x 4520320  
 2x 4211862  
 1x 4552348  
 2x 4211621  
 1x 4225033  
 2x 4296059  
 2x 4563045  
 3x 4211758  
 7x 4211807  
 1x 4211551  
 2x 4211815  
 2x 4211536  
 1x 4211639  
 1x 4535768

3

5

9

1x 4652235  
 2x 4640536  
 2x 4558959  
 3x 4211024  
 2x 4211076  
 4x 4210779  
 2x 4211094  
 5x 4565322  
 2x 4211043  
 1x 4211002  
 1x 4211134  
 2x 4257526  
 4x 4256828

4x 4260707  
 1x 6055313  
 6x 6051334  
 1x 4239891  
 4x 6048898  
 2x 6100030  
 2x 4210753  
 6x 4645730  
 4x 6083620  
 1x 4508553  
 1x 4499858  
 2x 6019987  
 16x 4210660

4

5.5

8

1x 6066952  
 4x 4521187  
 2x 6092604  
 4x 4523159  
 1x 6005755  
 4x 6092500  
 2x 6092499  
 9x 4633691  
 1x 6101923  
 2x 6103924  
 1x 6108536  
 1x 6006525  
 4x 6103777