



CITY

60257



WARNING: CHOKING HAZARD.
Small parts. Not for children under 3 years.

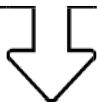
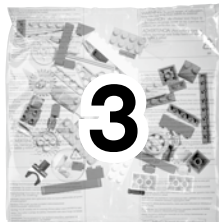
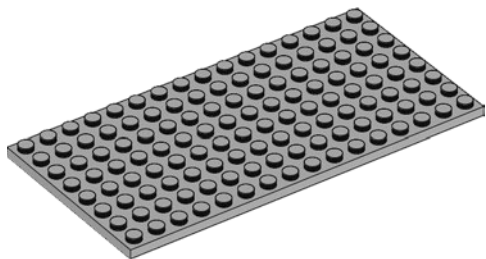

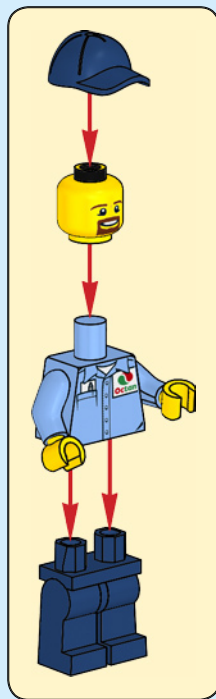

AVERTISSEMENT :
RISQUE D'ÉTOUFFEMENT.
Contient des petites pièces.
Ne convient pas aux enfants
de moins de 3 ans.



ADVERTENCIA:
PELIGRO DE ASFIXIA.
No recomendado para
niños menores de 3 años.
Contiene piezas pequeñas.



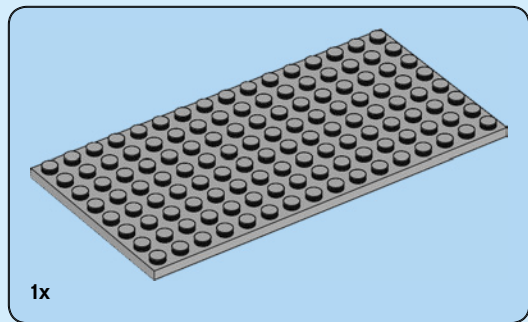

1

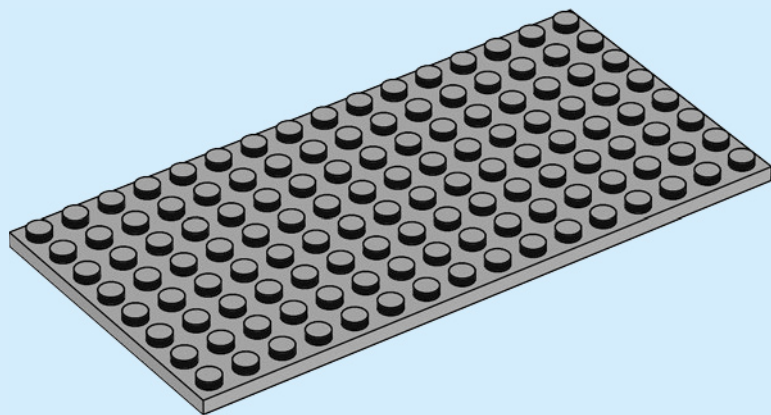

4

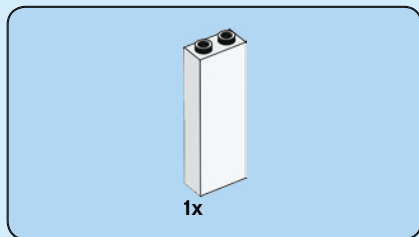

2

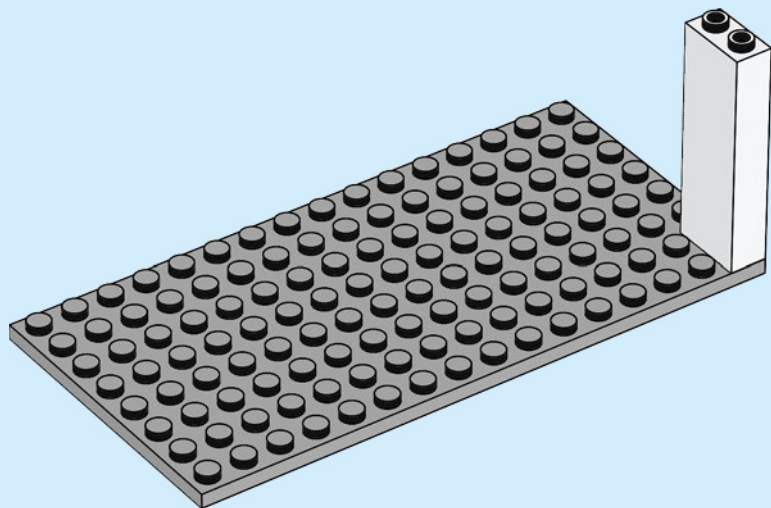

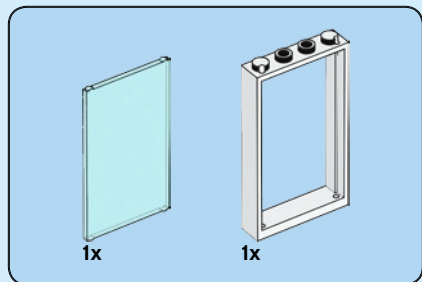

3

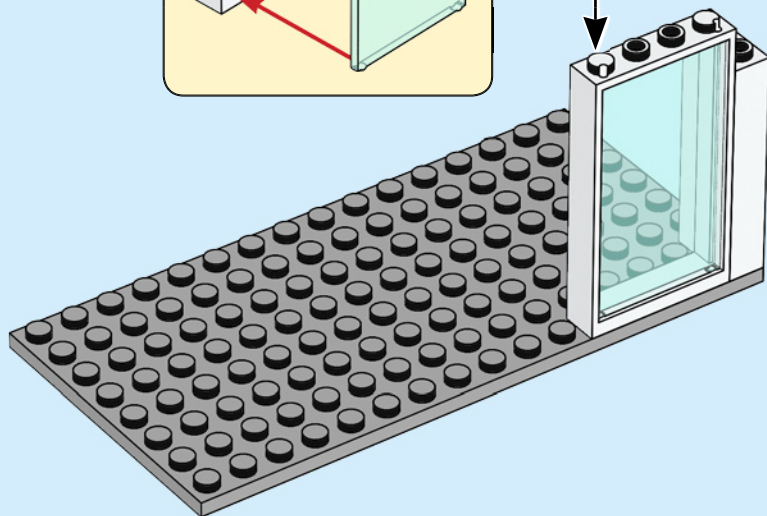
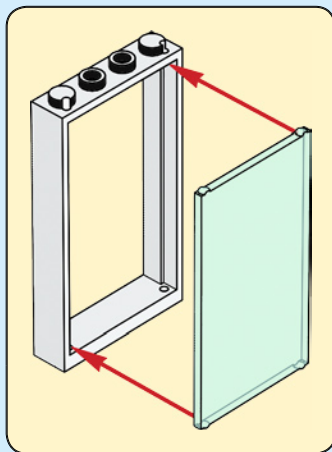

6

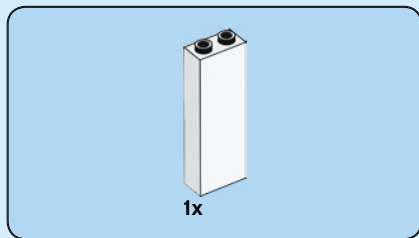

4

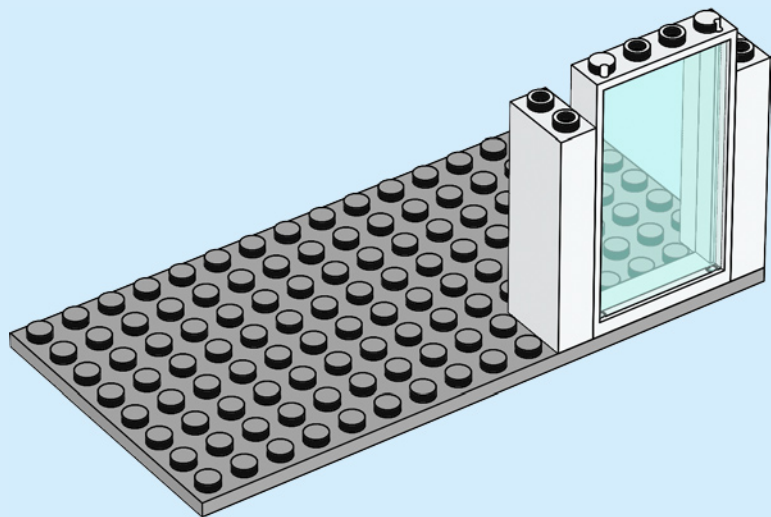

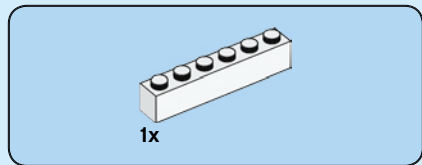

5

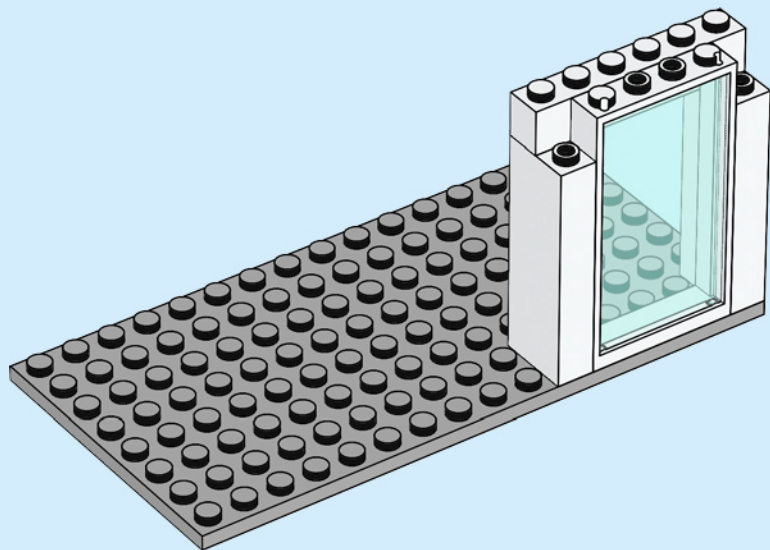

8



2x

6

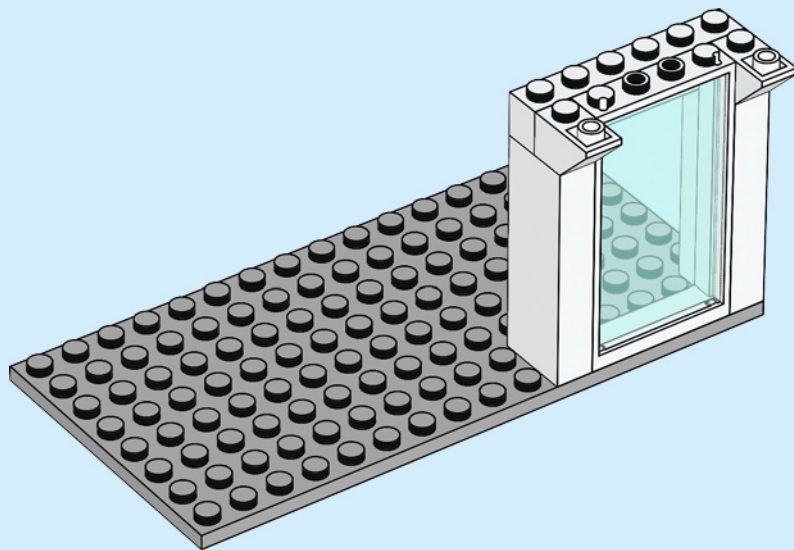

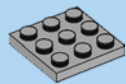

2x

7

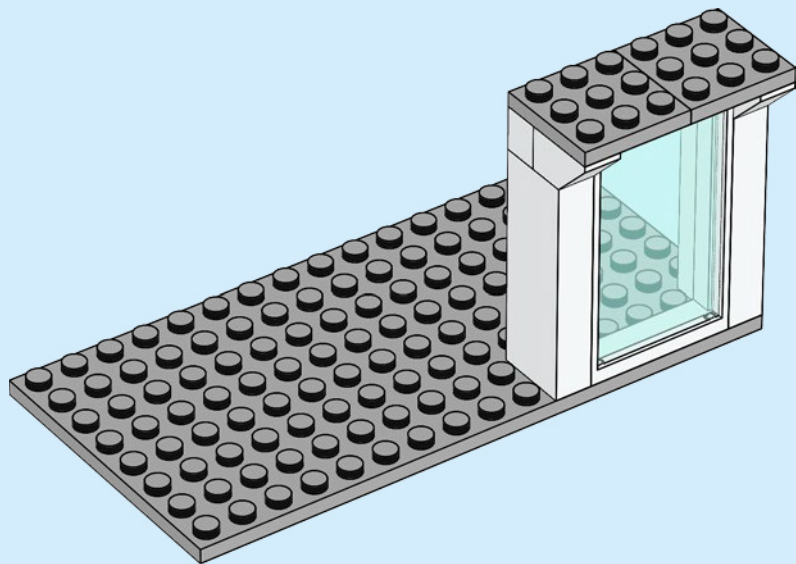

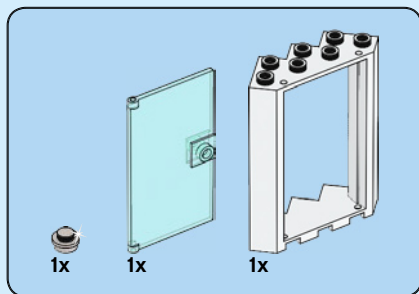

8

1

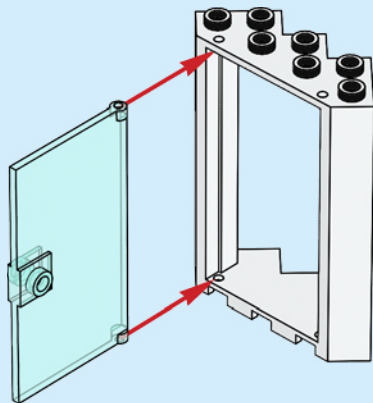

2

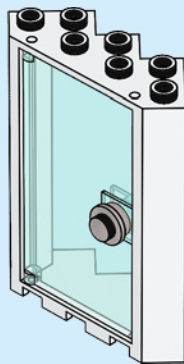

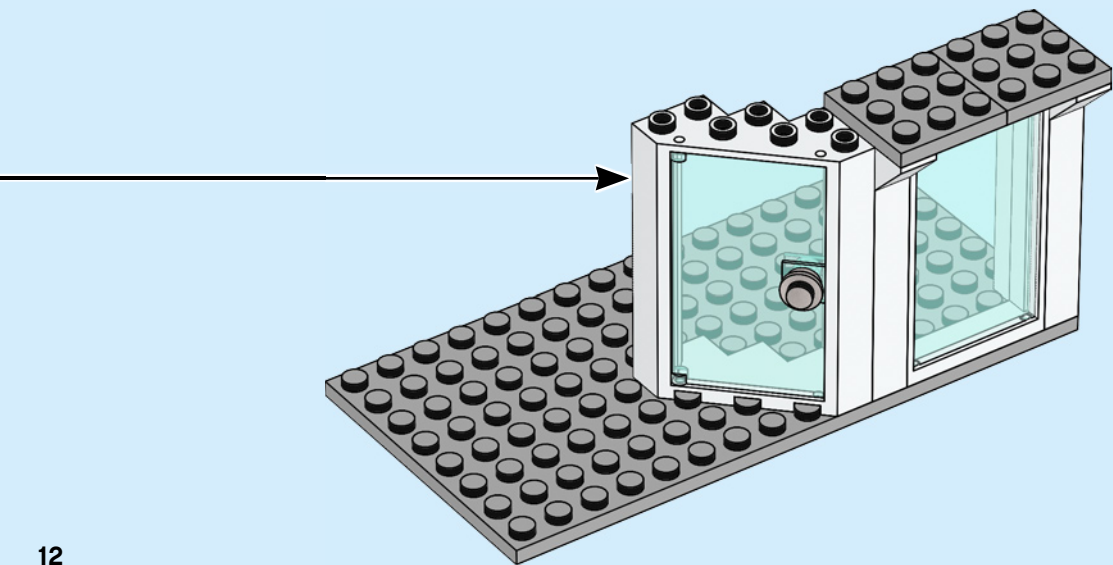

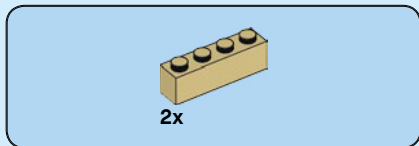

9

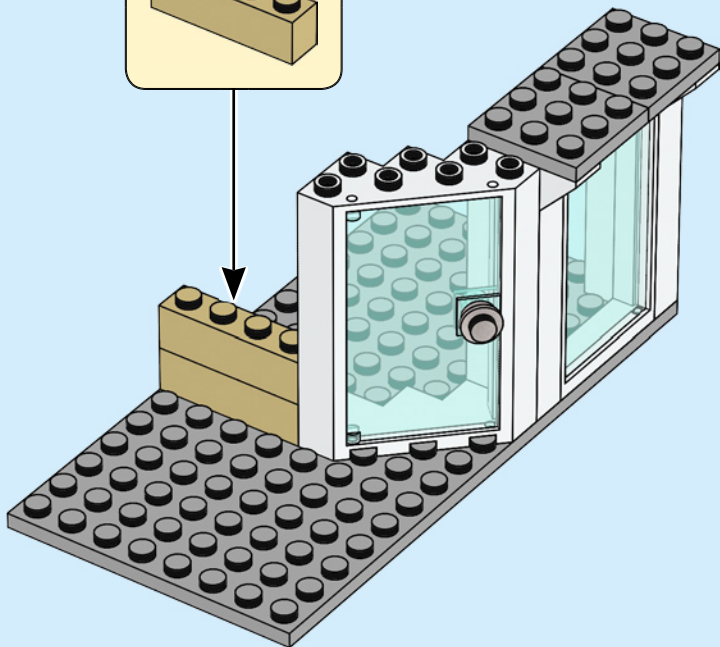
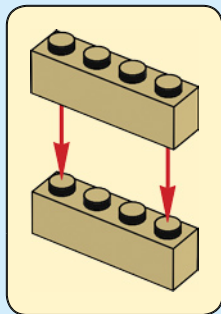

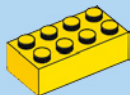

2x

10

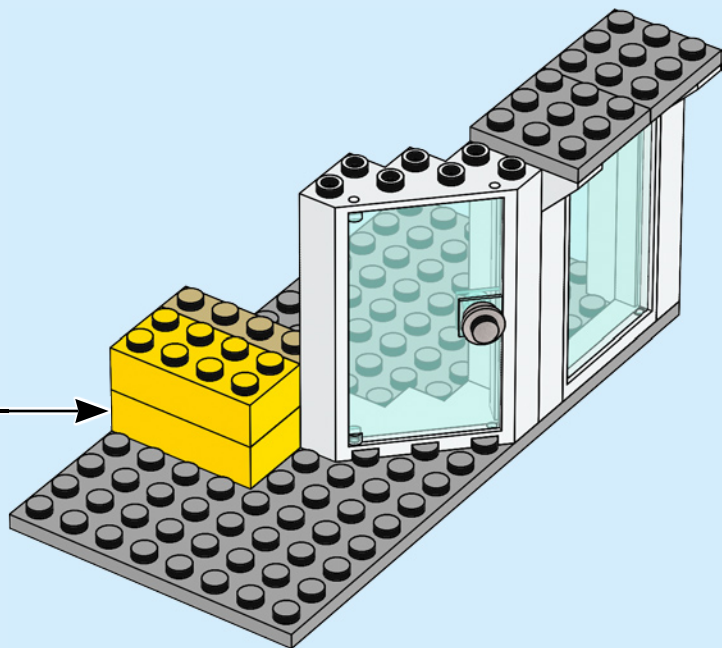
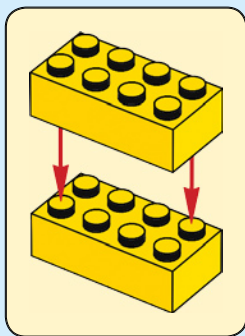



1x



1x

11

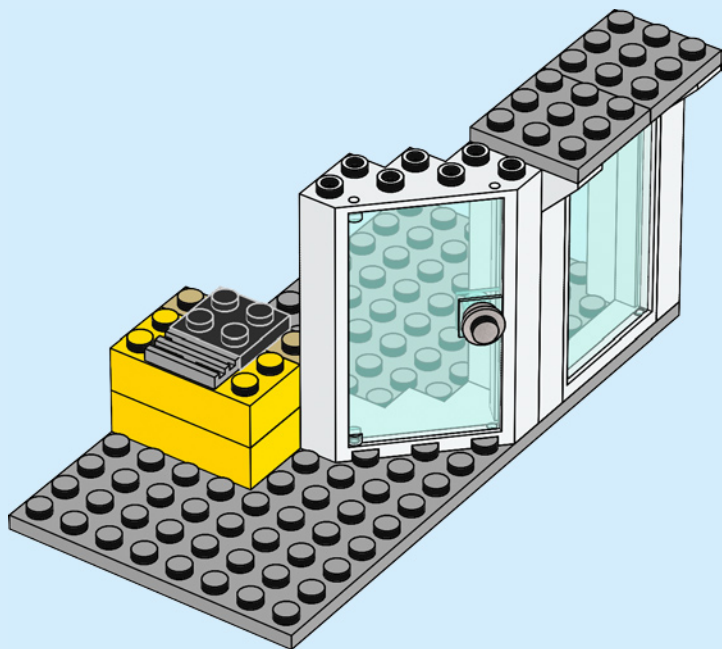



1x

12

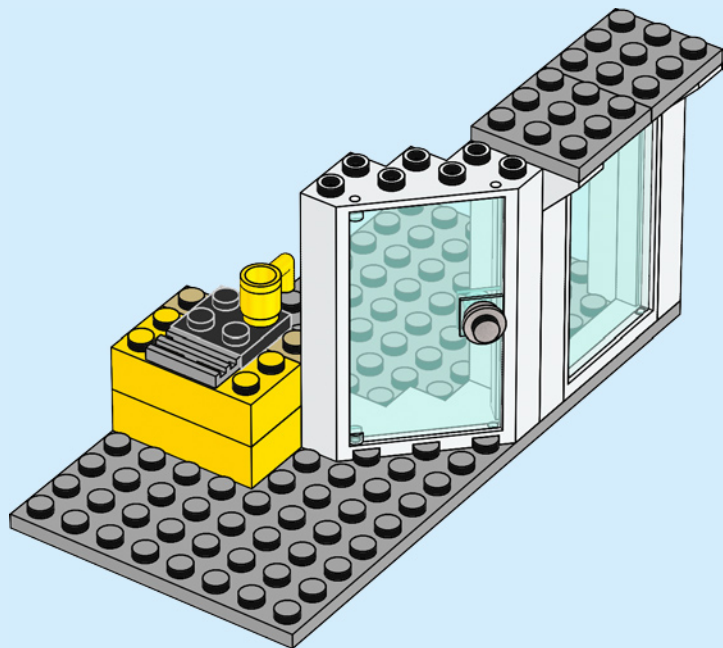



13

1

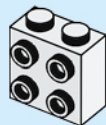

2

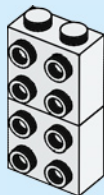

3

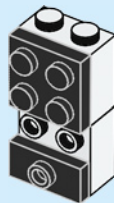

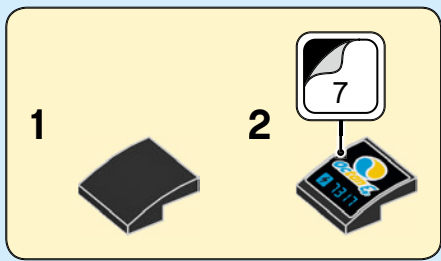

4



5

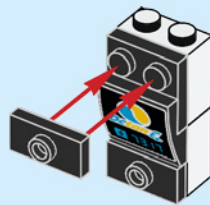

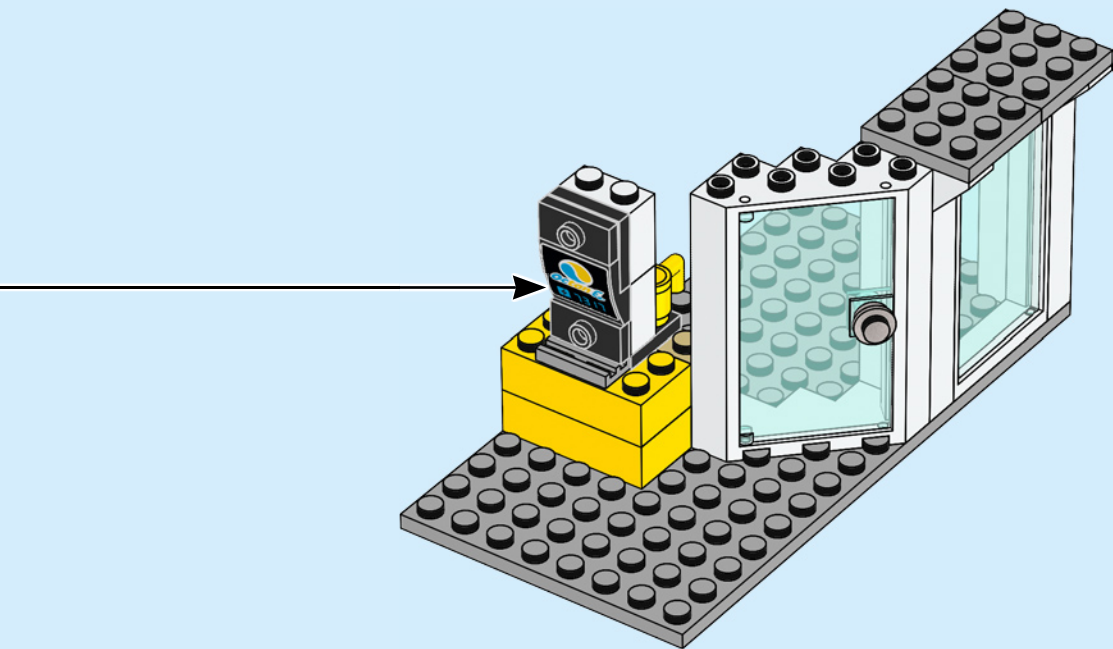

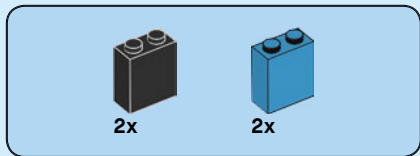

14

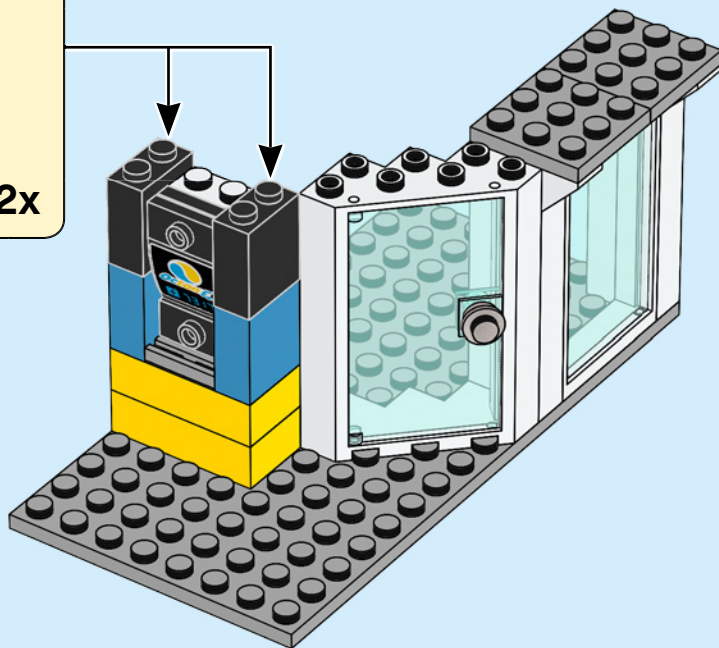
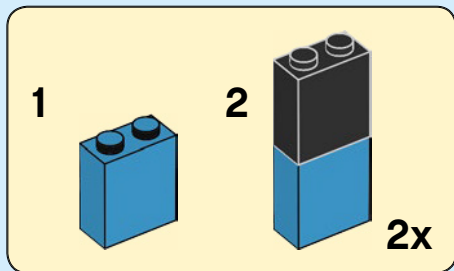



15

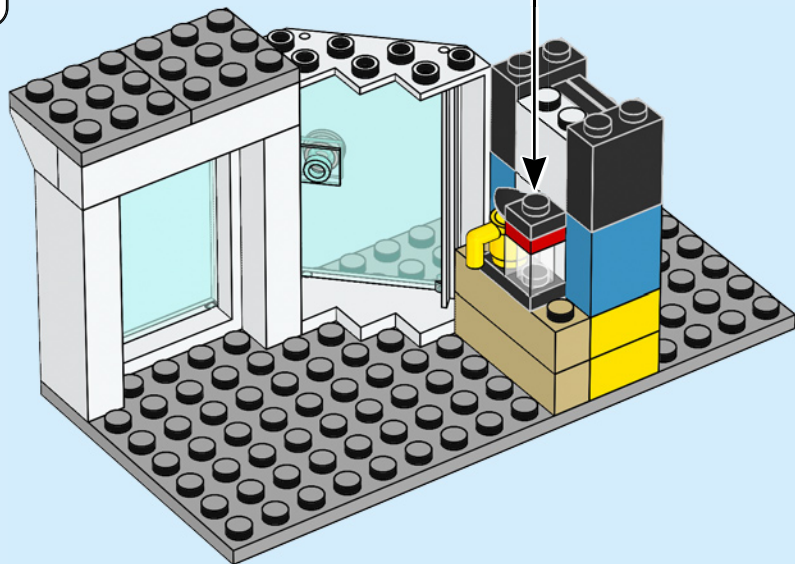
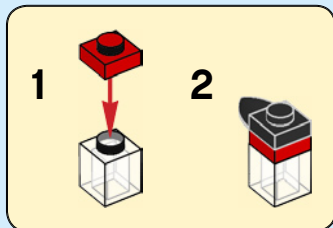

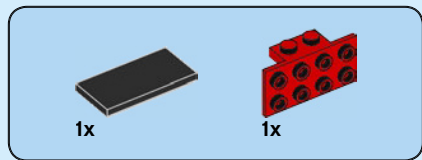

16

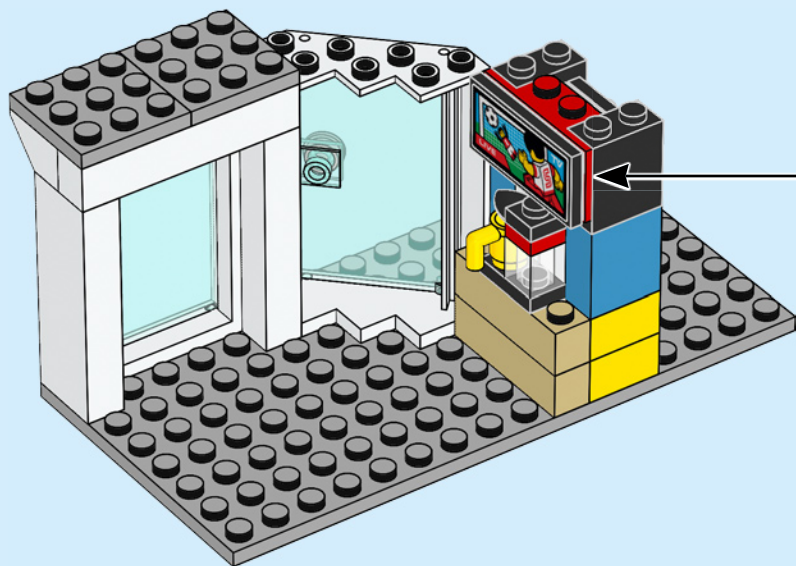
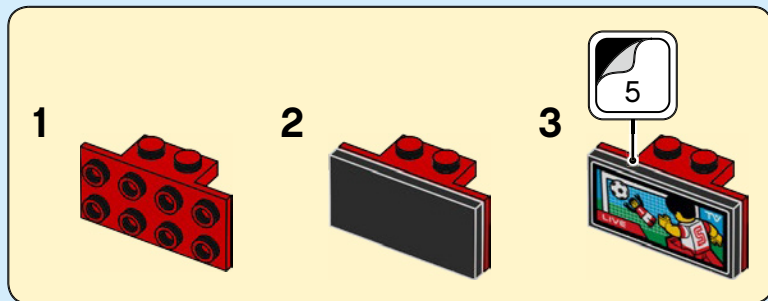

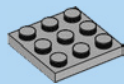

1x

17

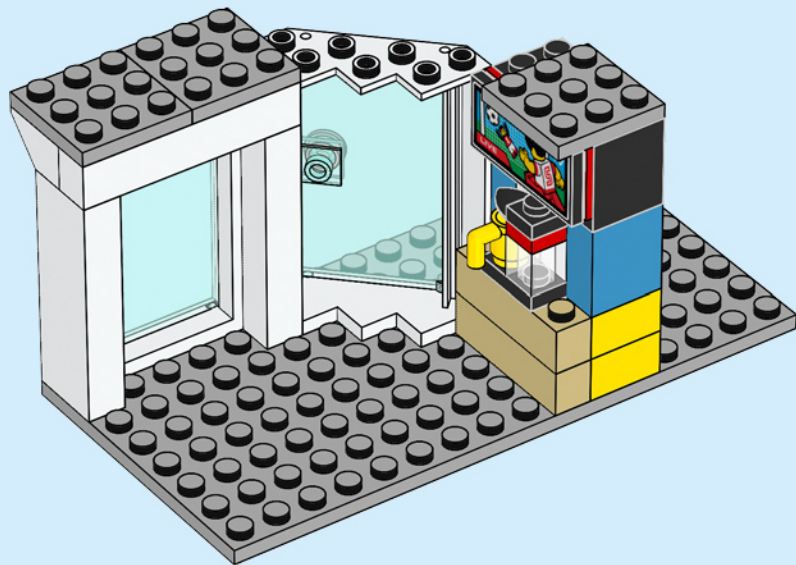

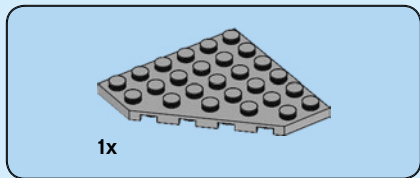

18

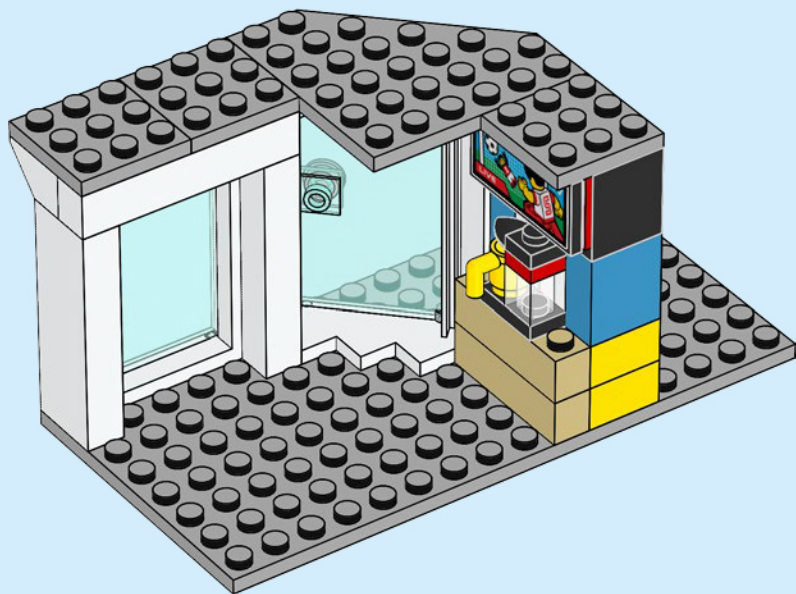



2x

19

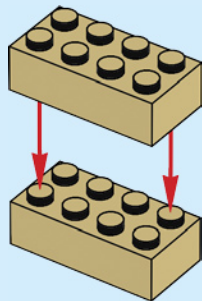

1x



1x

20

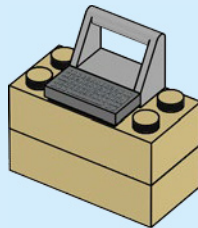



1x

21

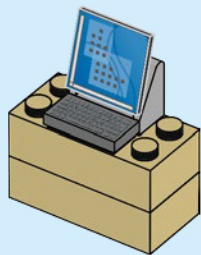

26



1x



1x

22

1



2



23

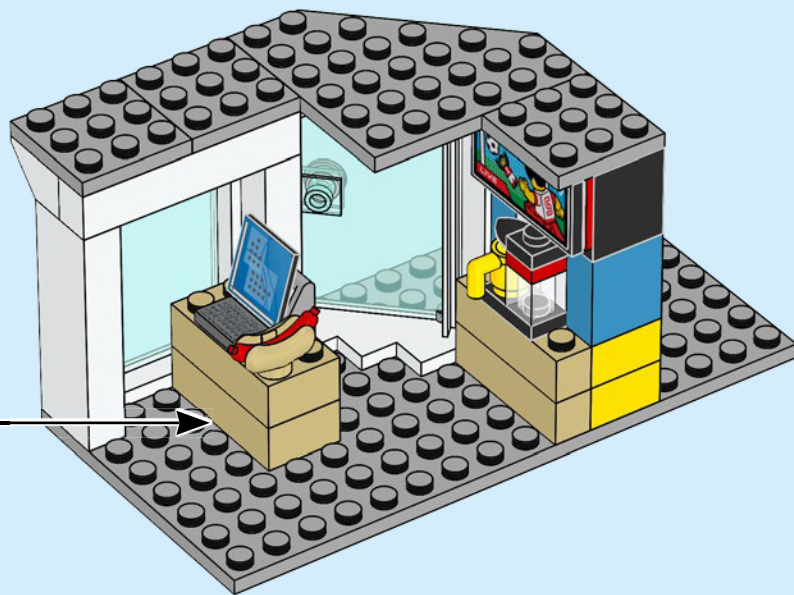

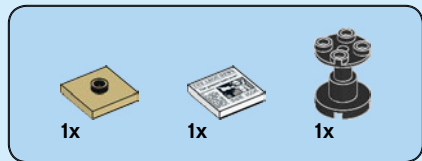

24

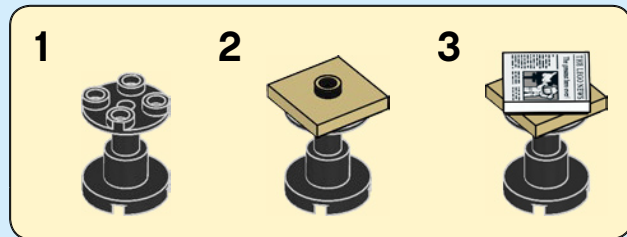

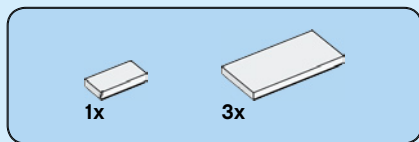

25

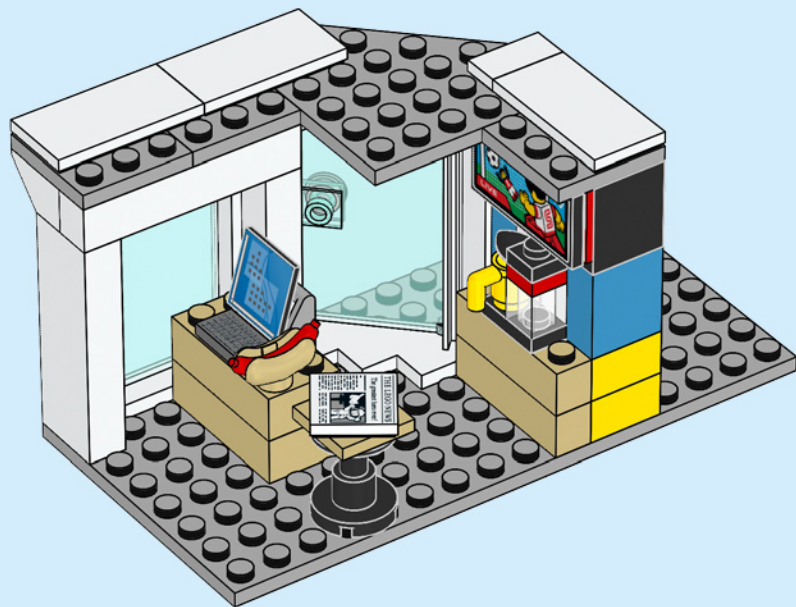



2x

26

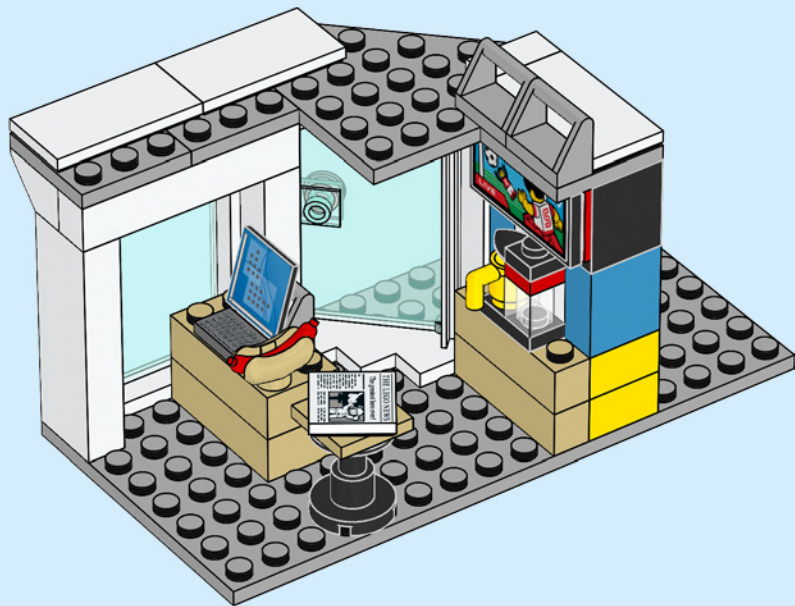

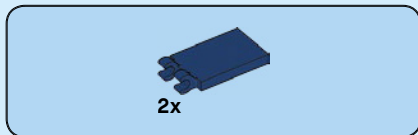

27

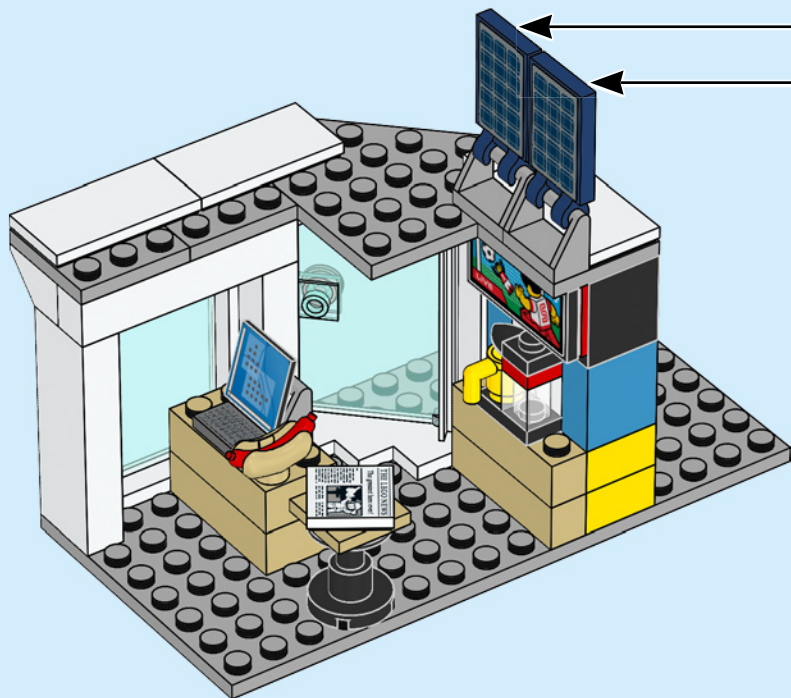
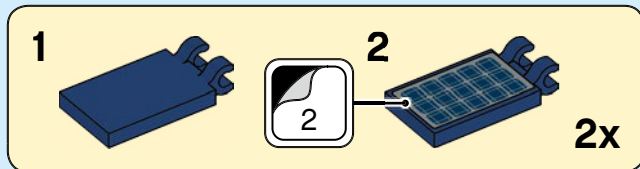



1x



2x

28

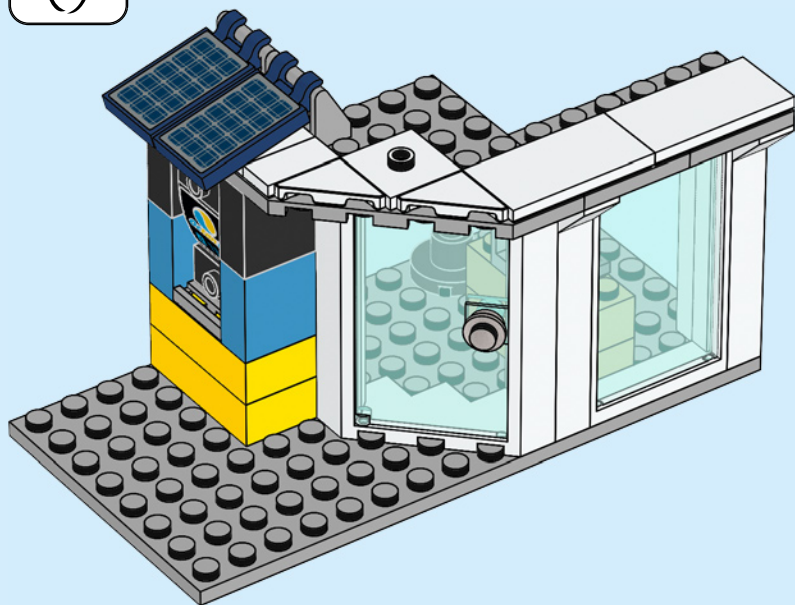
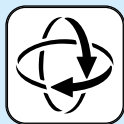

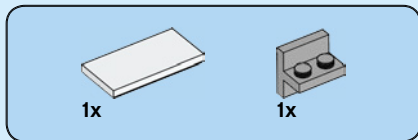

29

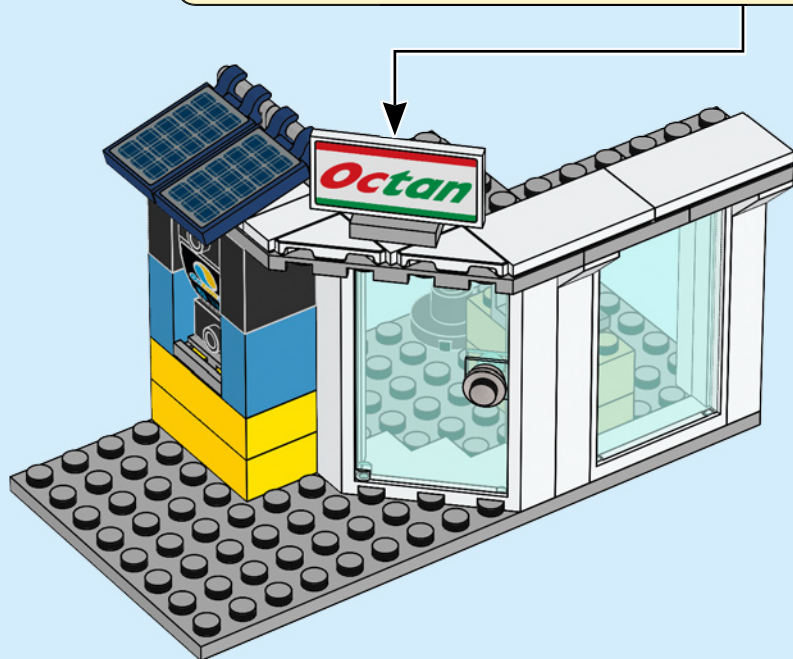
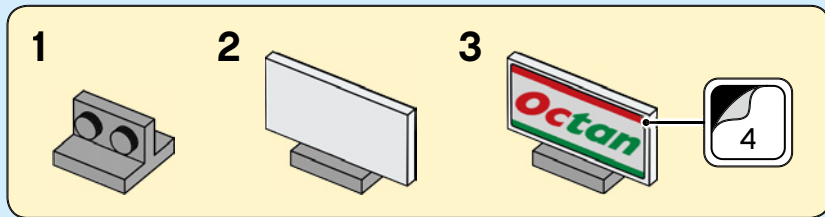

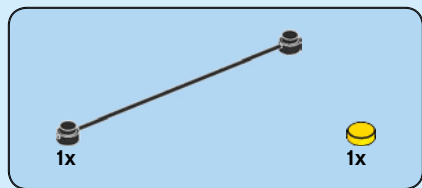

30

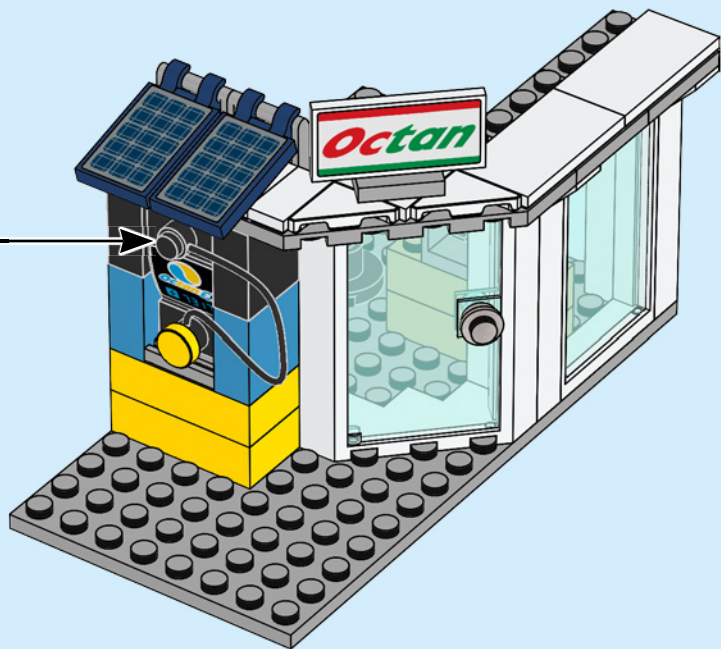
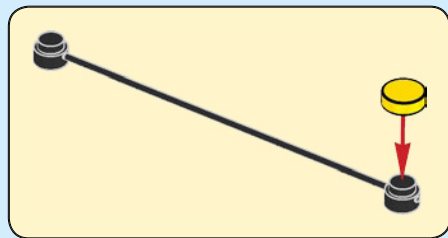



2x



2x

31

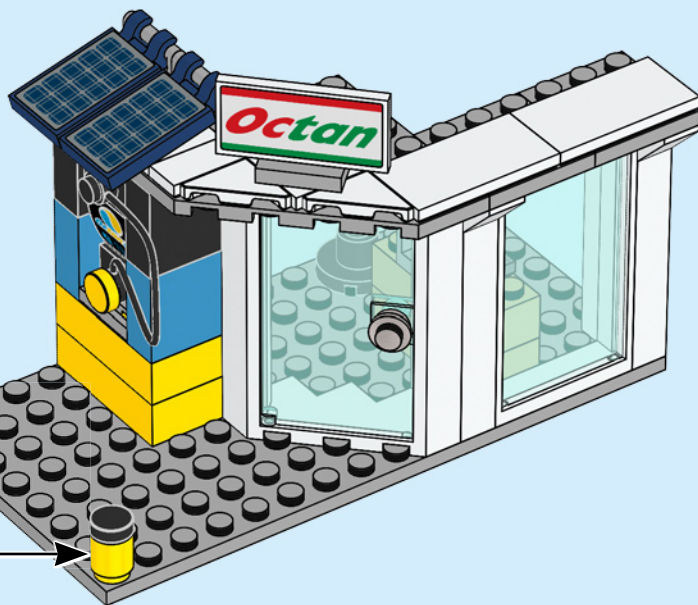
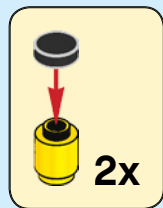



ManagerExcellentCrocodile

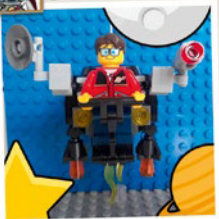

KingYummyCheeiah



PrincessBossyRooster

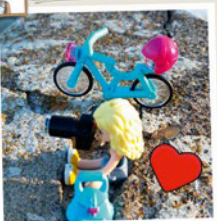

LEGO.com/apps



LEGO and the LEGO logo are trademarks of the/son des marques de commerce du/son marcas registradas de LEGO Group.
©2020 The LEGO Group. 6310795