

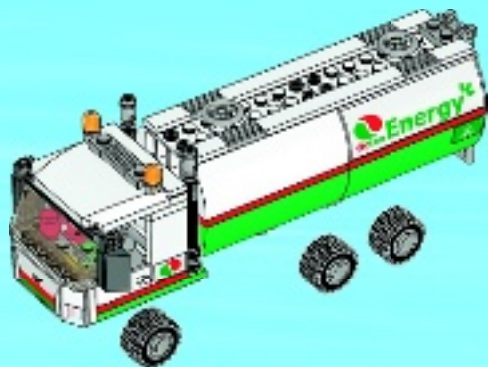

CITY

60016

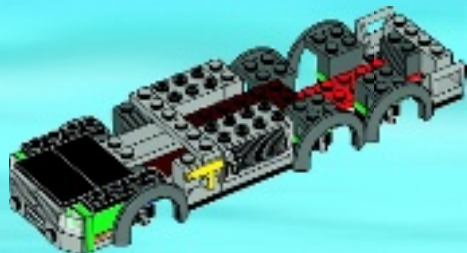

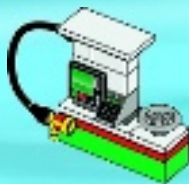

1

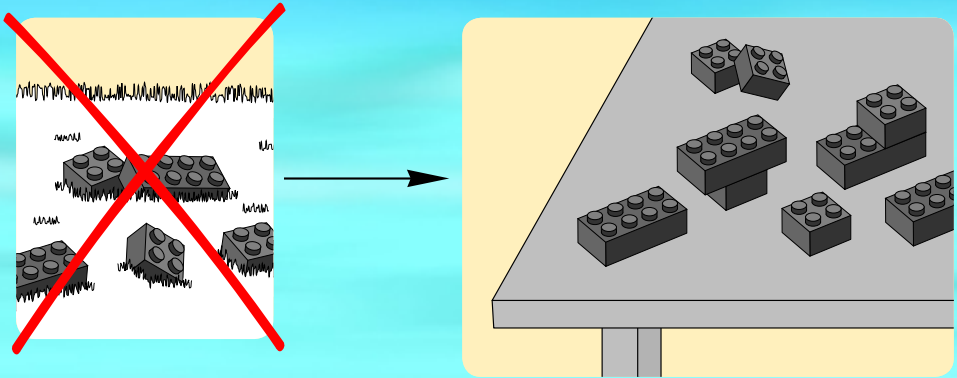

2

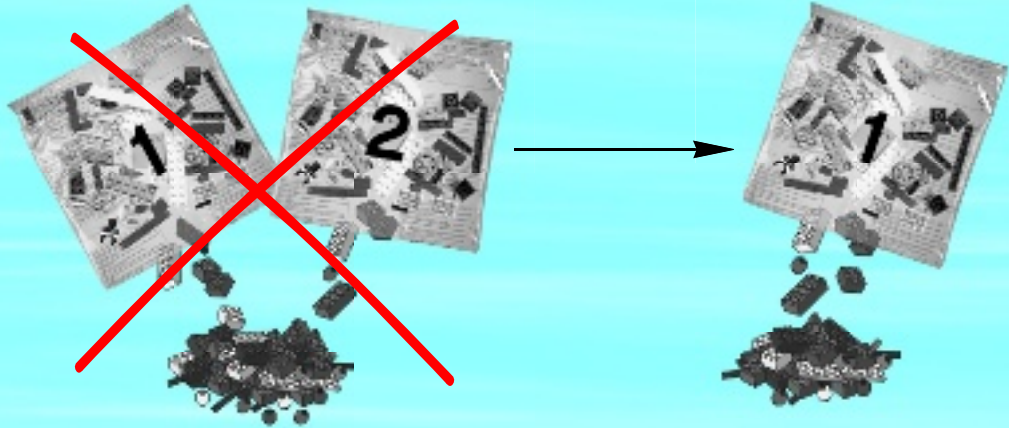

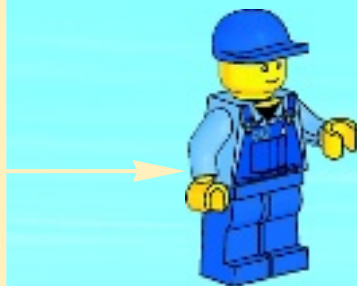
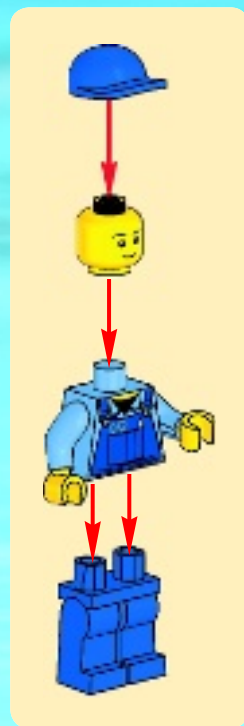
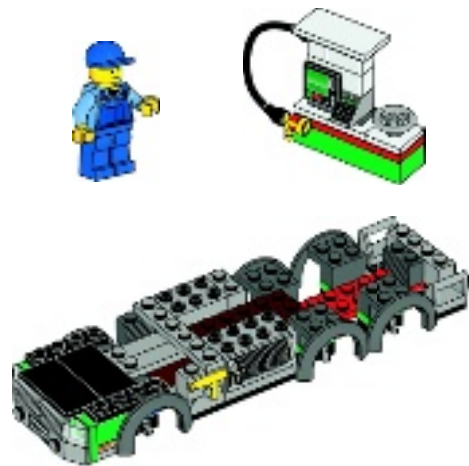

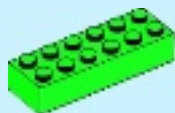

1x

1

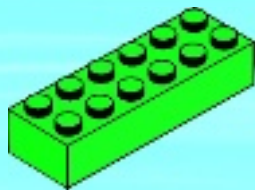

1x



1x



1x

2

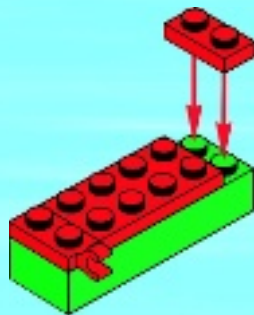



3x

3

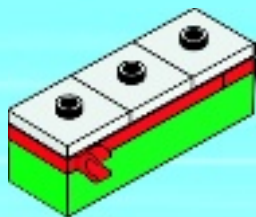

1x



1x

4

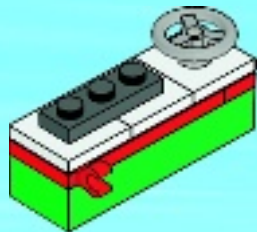



1x



2x

5



1x

6





1x



1x

7

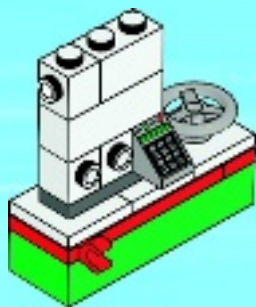

8



1x

8





1x

9

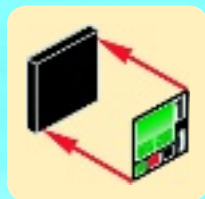



1x



1x

10

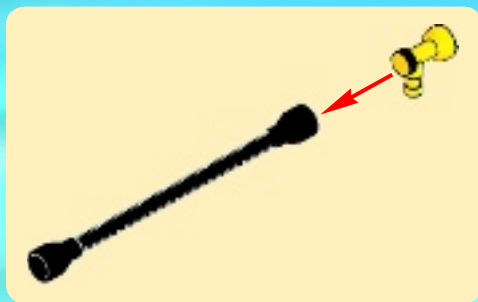

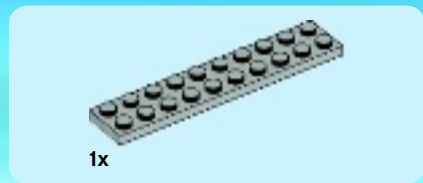

1

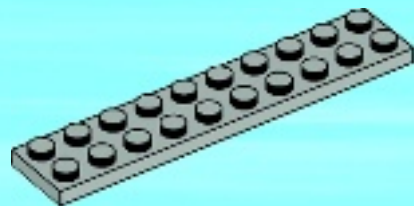



1x



1x

2

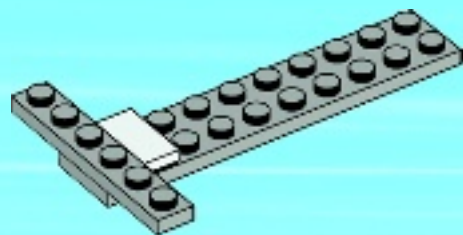

1x



2x

3

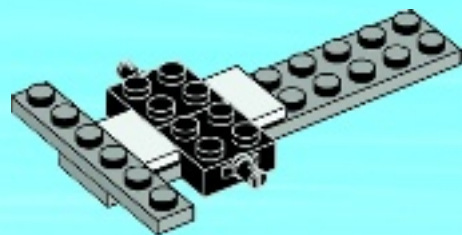

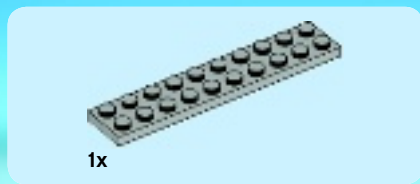

4

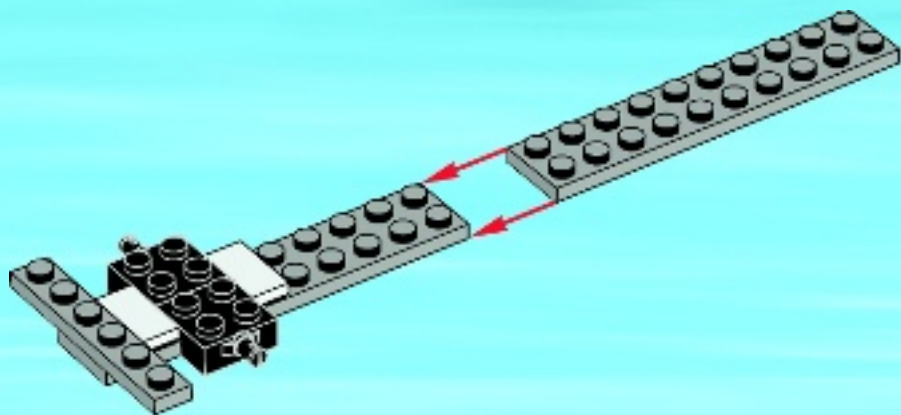



1x

5

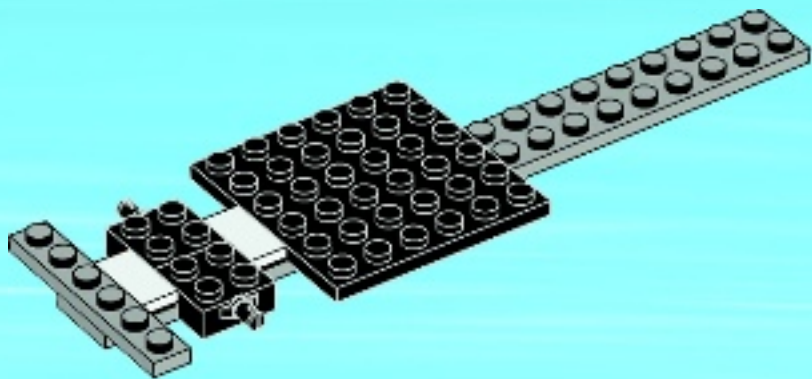



1x



2x



1x

6

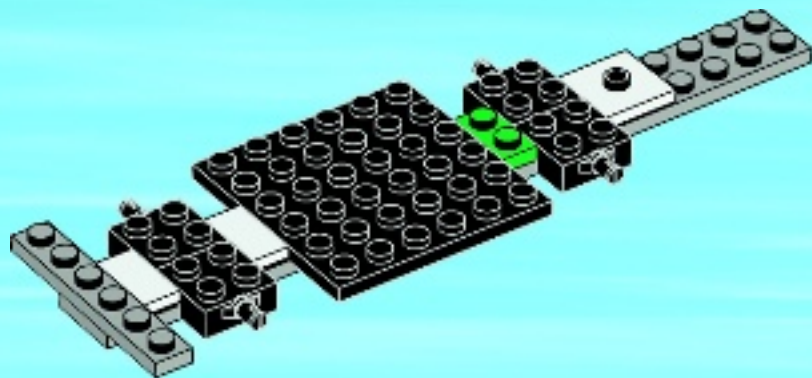



7

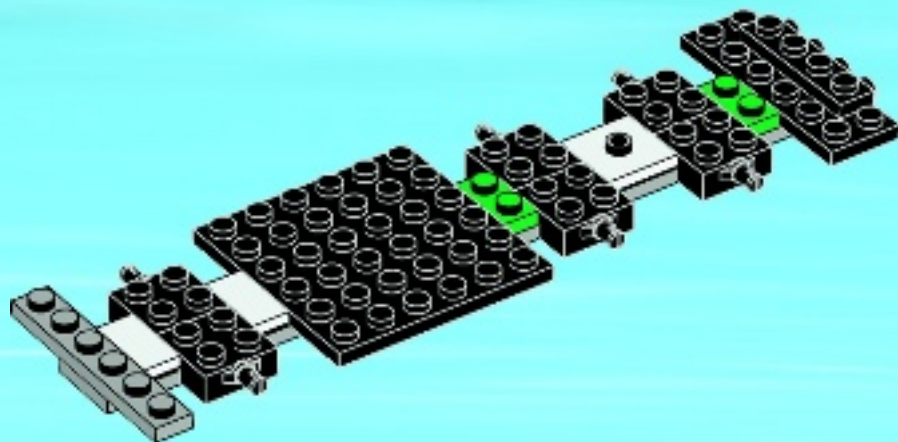



1x



2x

8

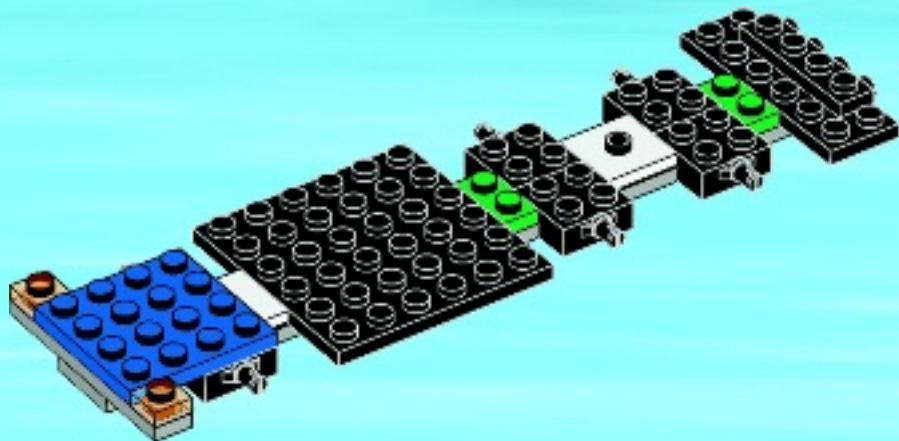

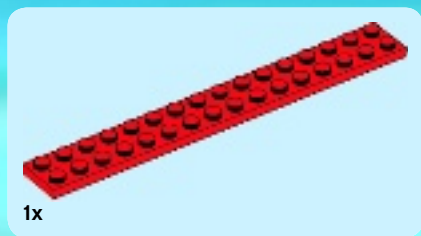

9

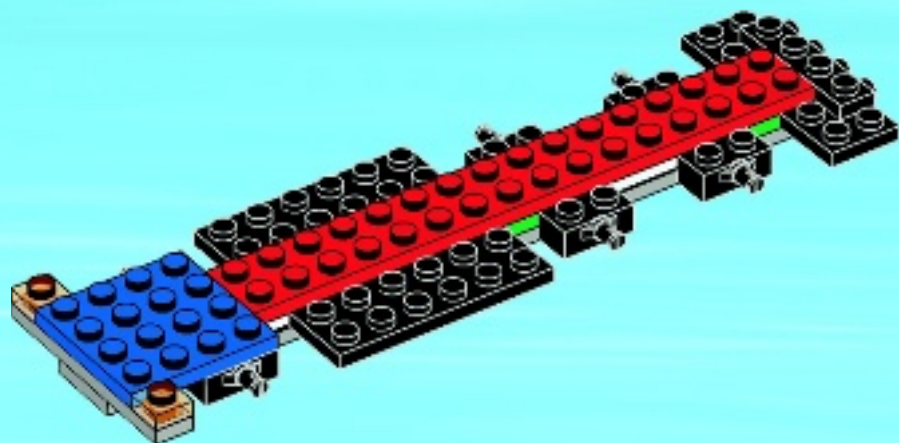



2x



1x

10

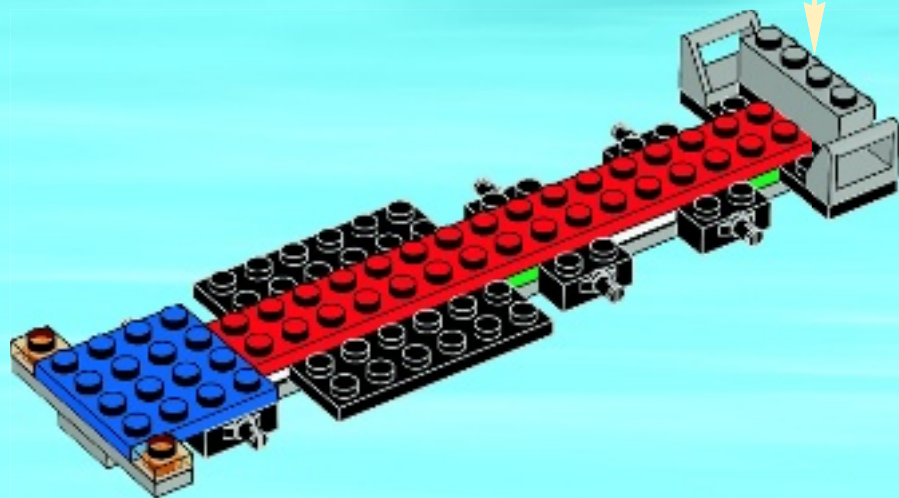
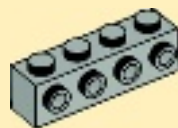



4x

11

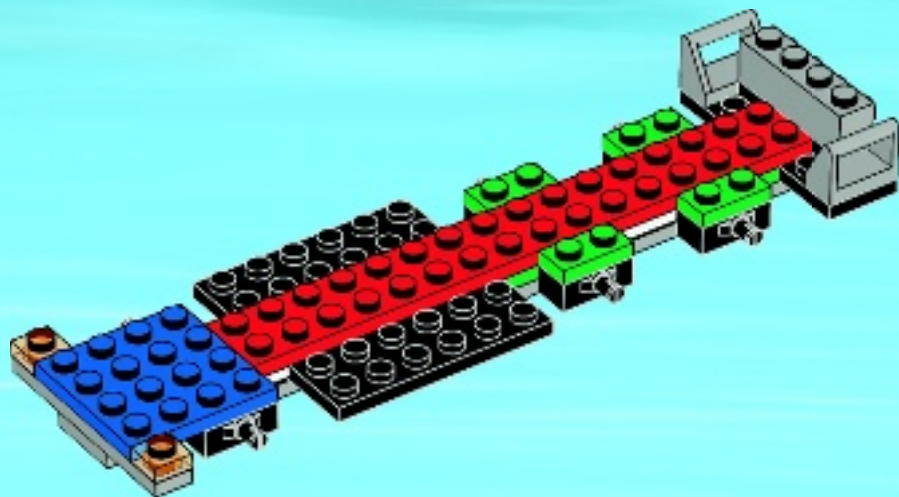



4x



1x

12

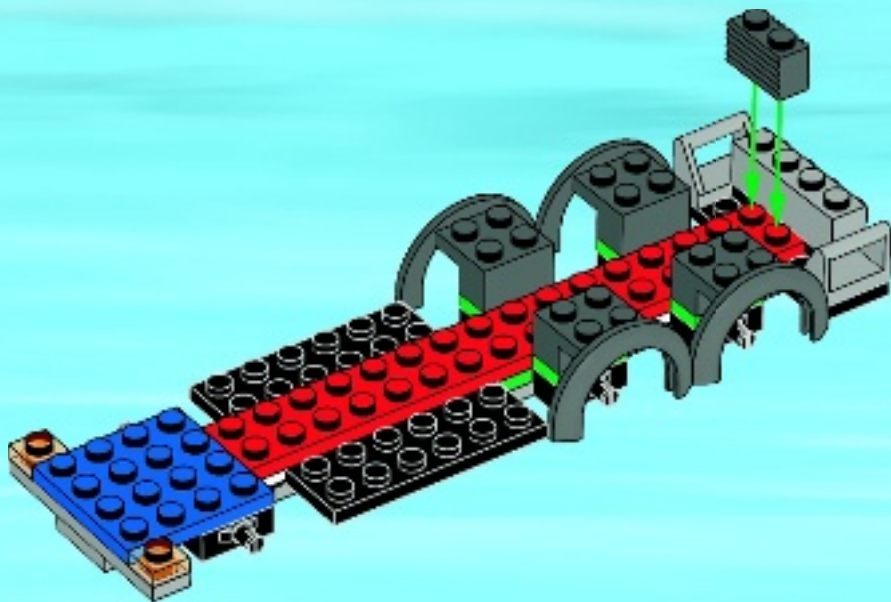



1x

13

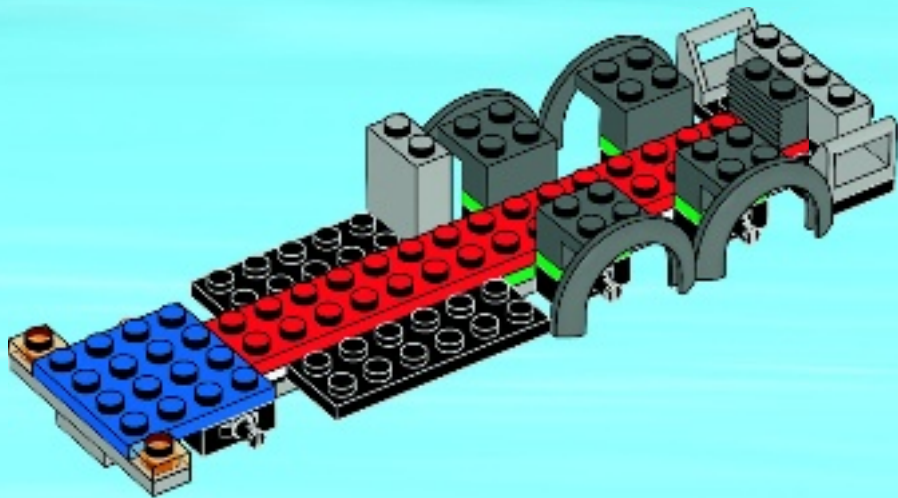



2x

14

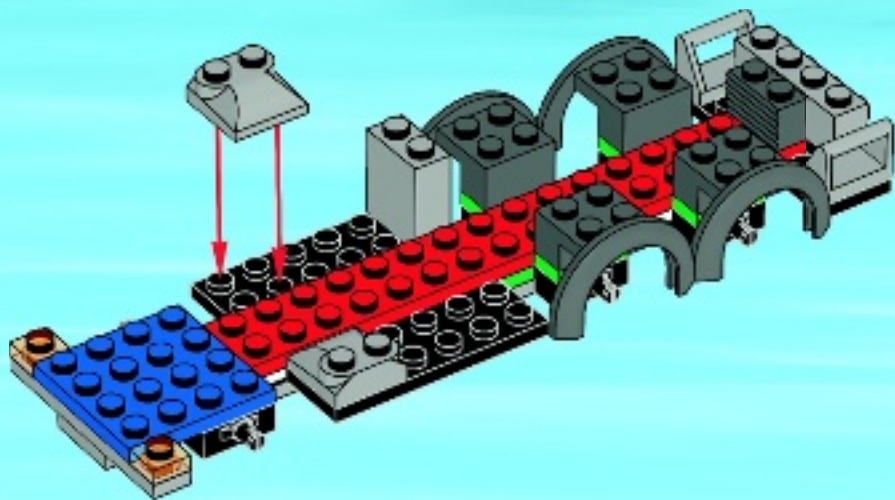



1x



1x



1x



1x

15

1



2



3

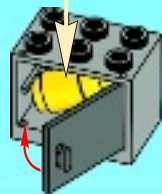

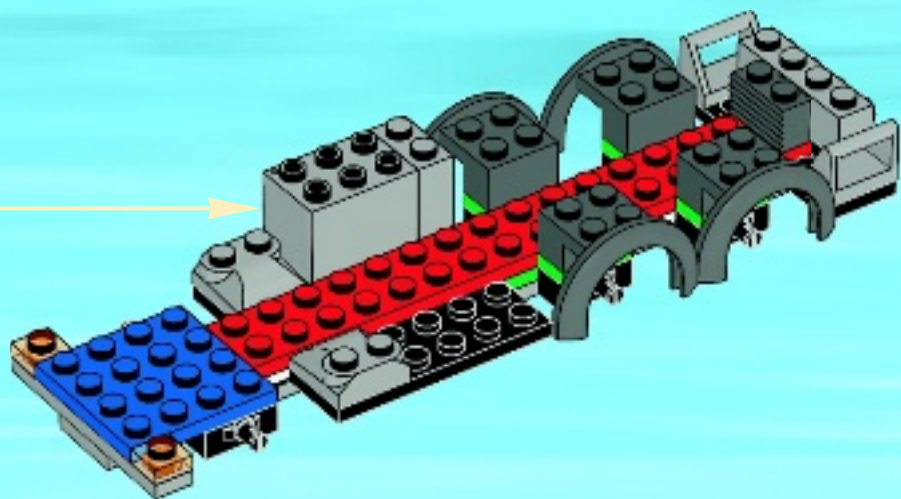



2x



1x

16

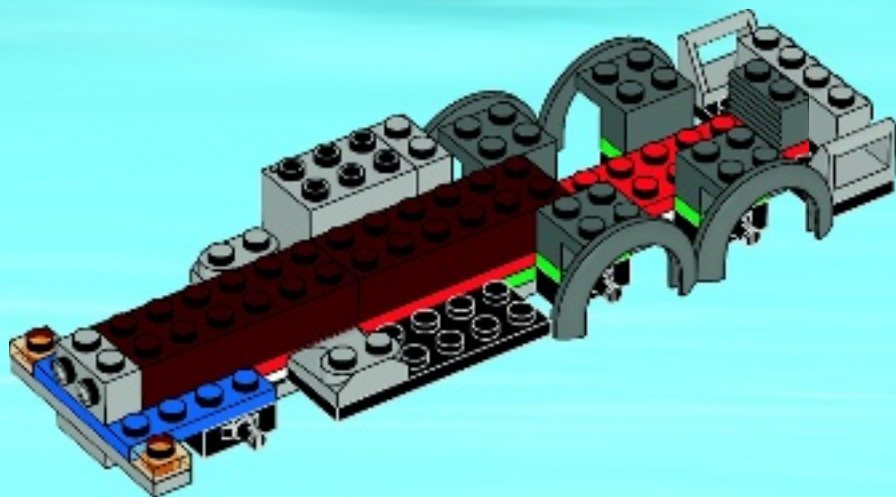



1x



1x

17

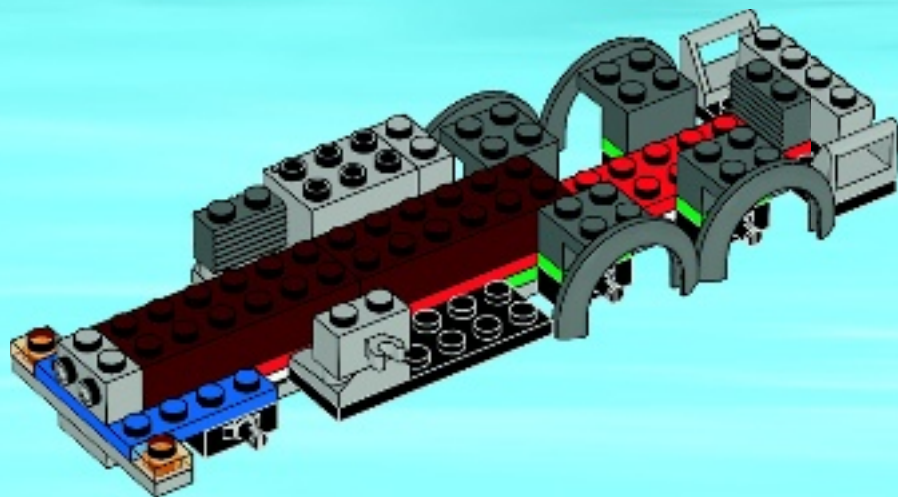

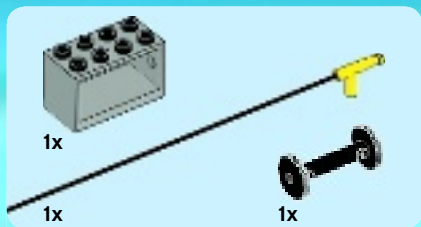

18

1



2

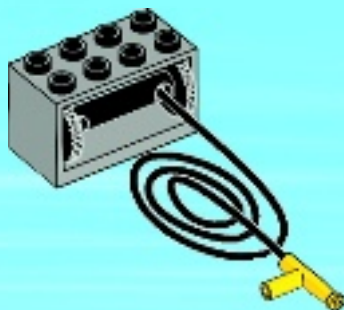

3

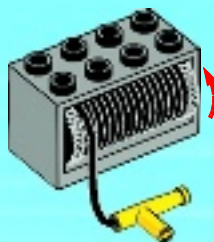

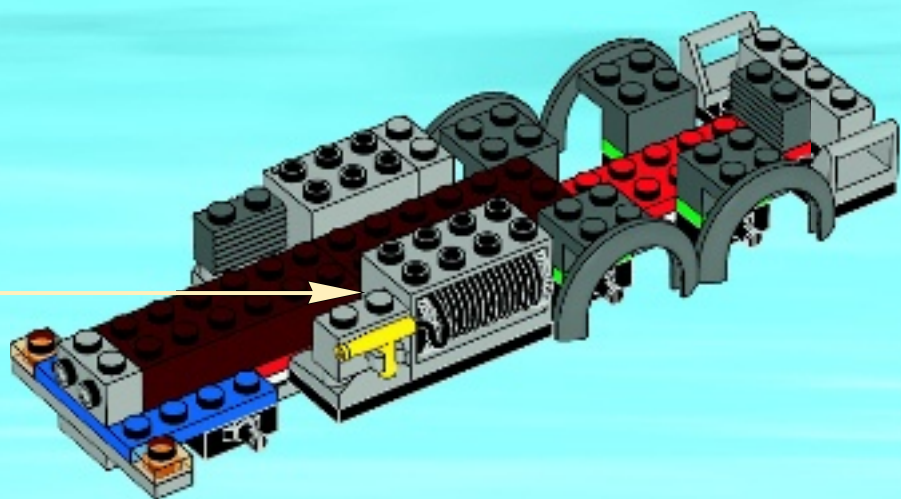



2x

19

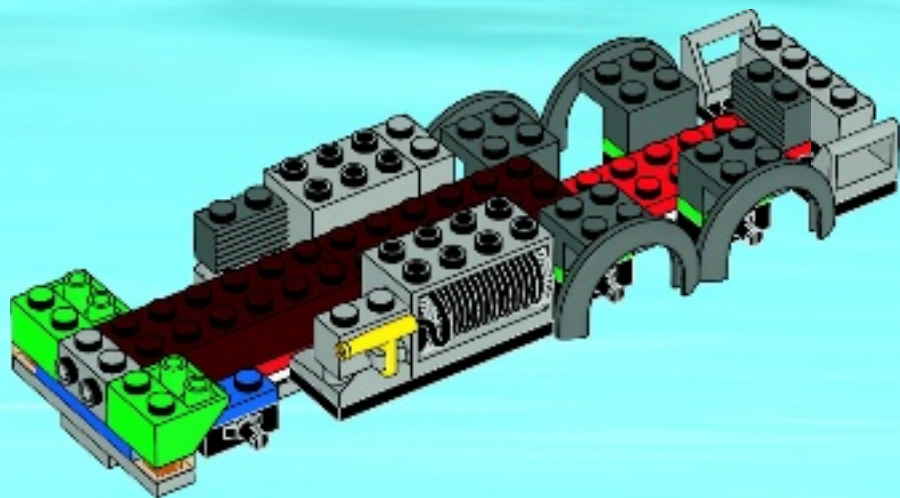



2x

20

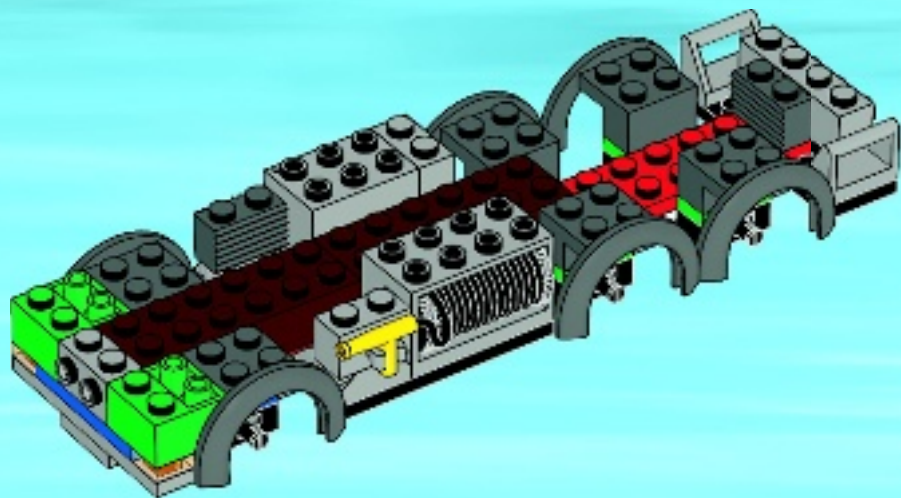



2x

21

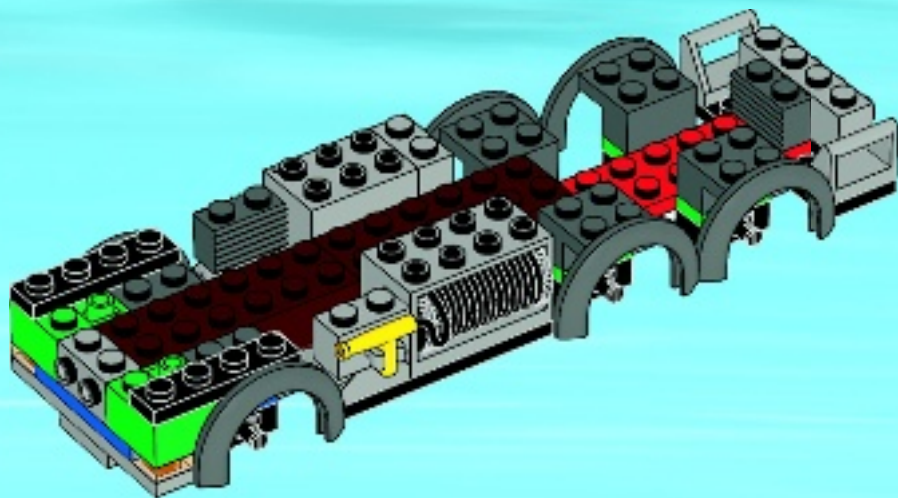

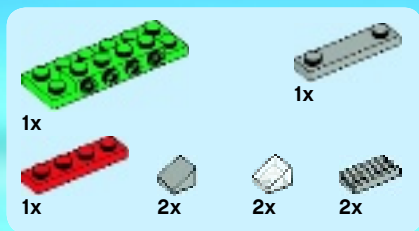

22

1

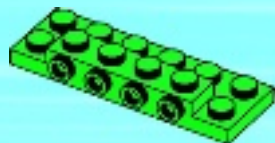

2

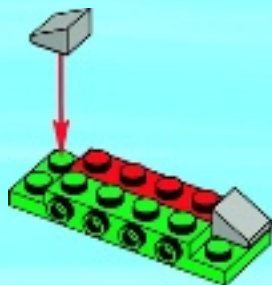

3

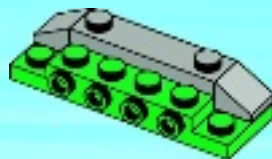

4

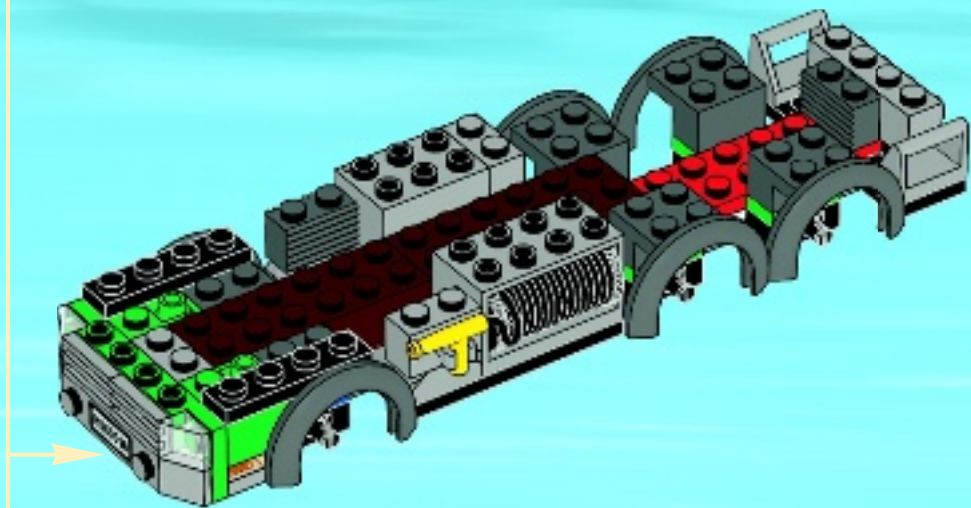
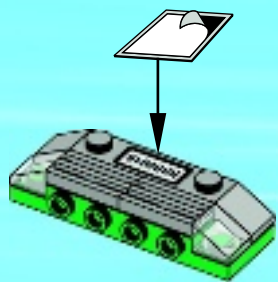



2x



2x

23

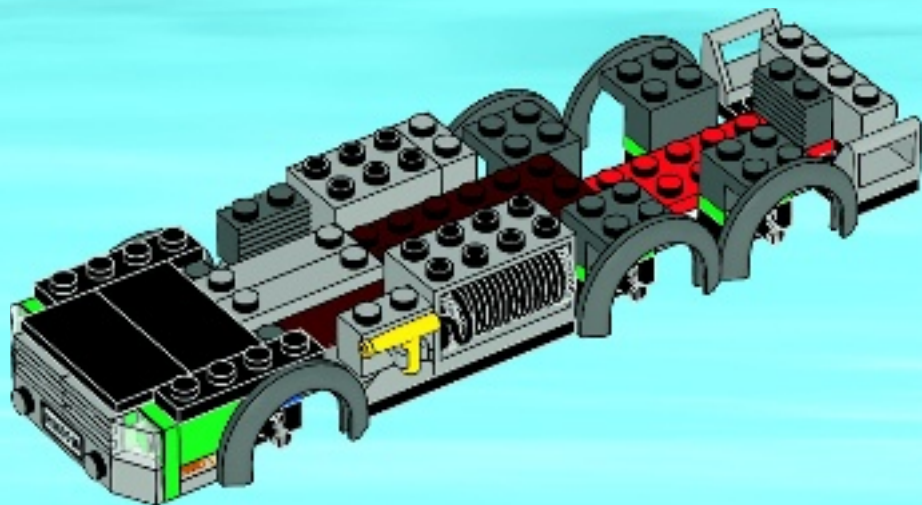



1x

24

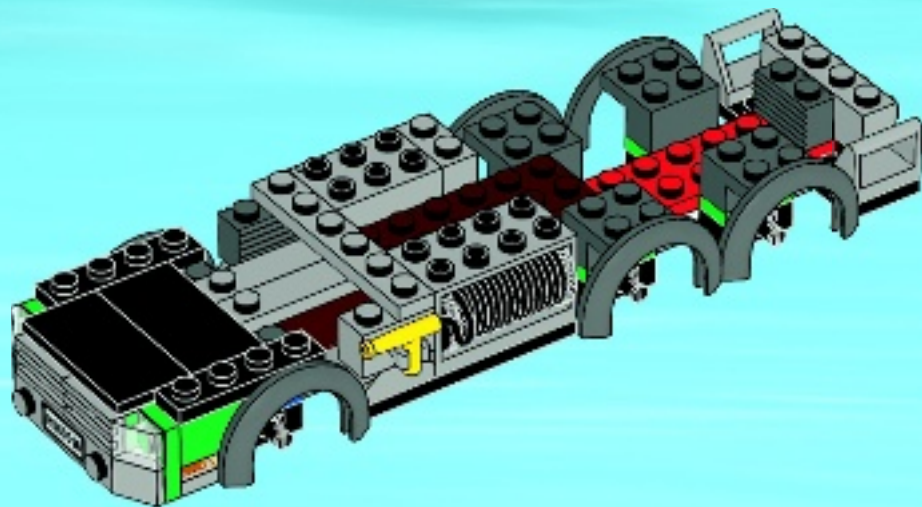

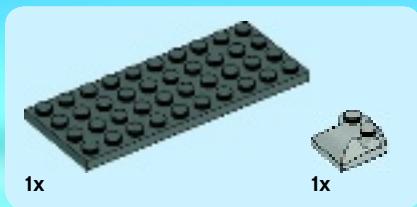

25

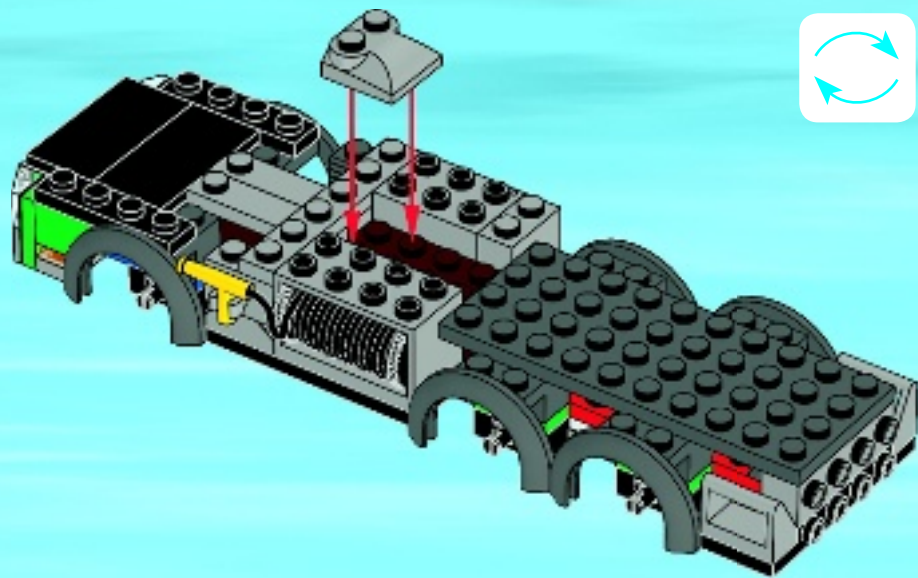

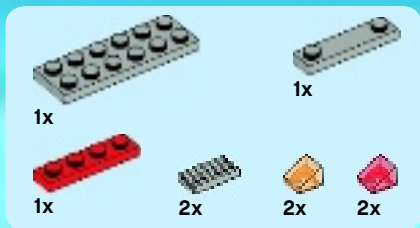

26

1

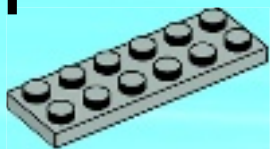

2

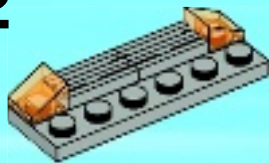

3

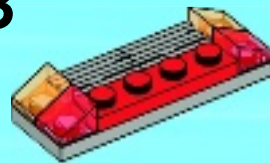

4

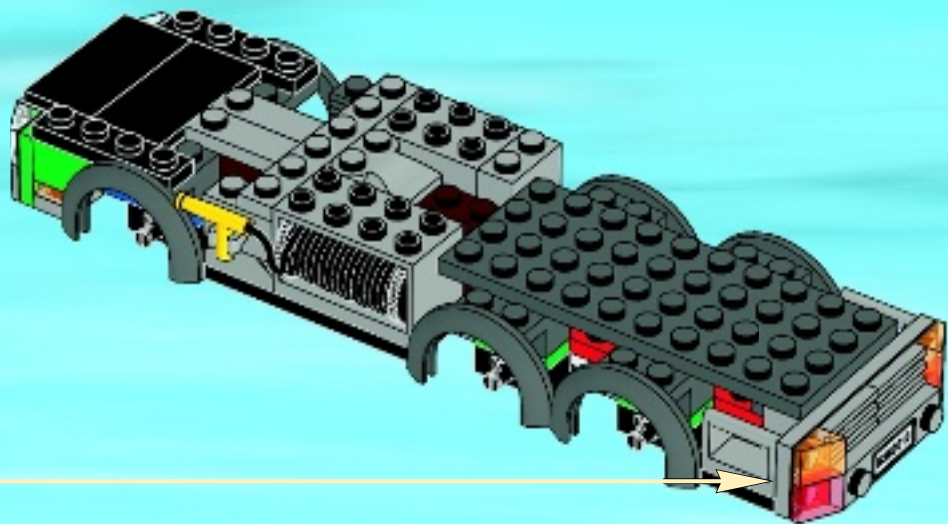
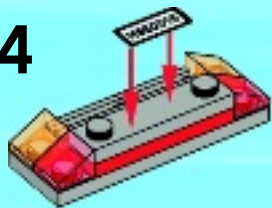



2x



2x

27

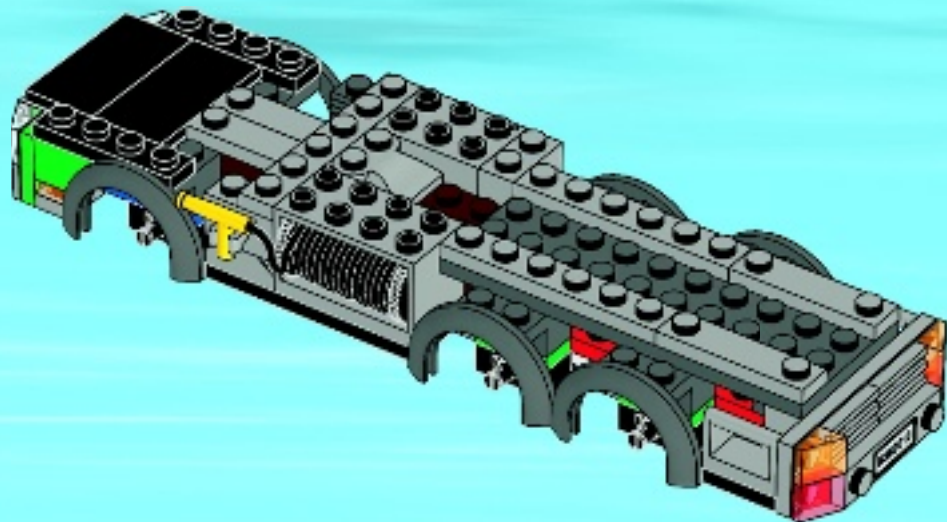

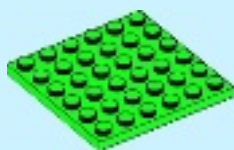
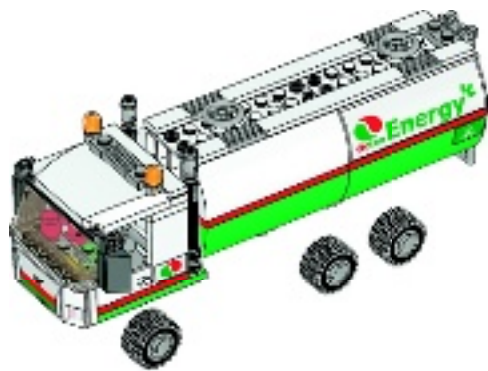

1x

1

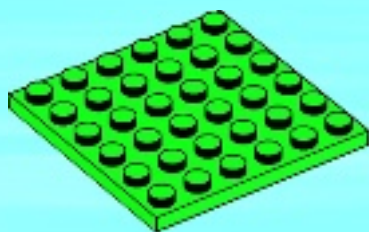



1x



2x

2

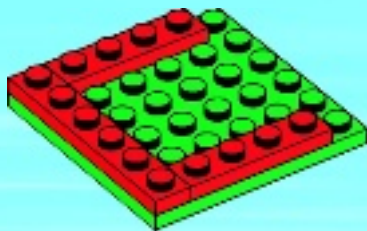



2x

3

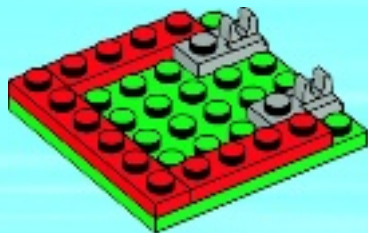

1x

4





2x



2x

5



2x

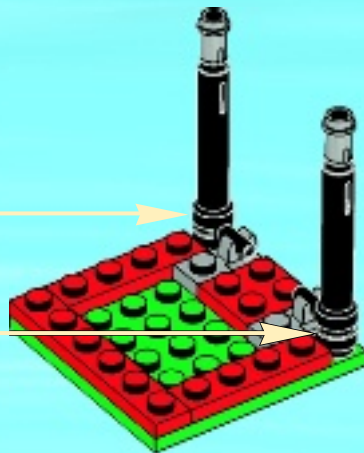



1x

6

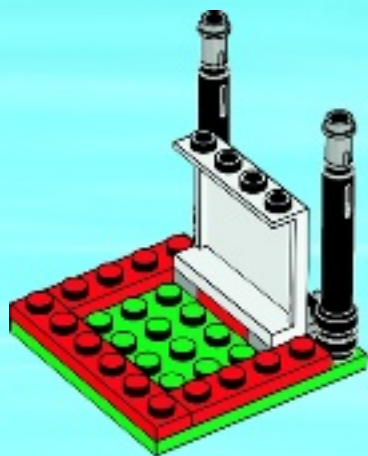

2x

7

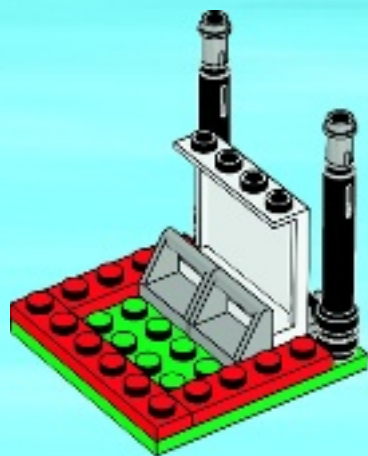



2x

8

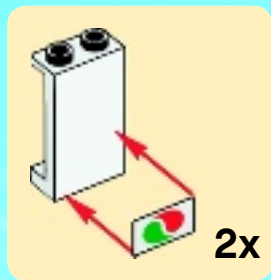

2x

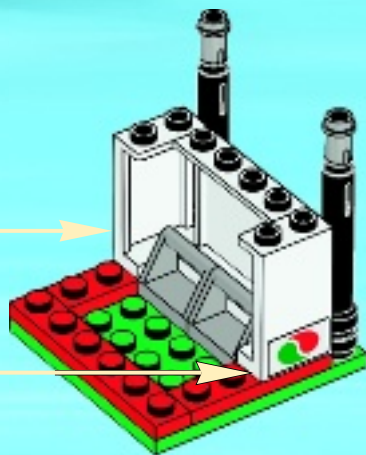



1x



1x

9

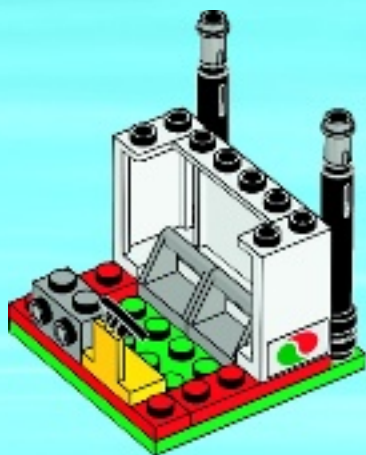

1x



1x



1x

10

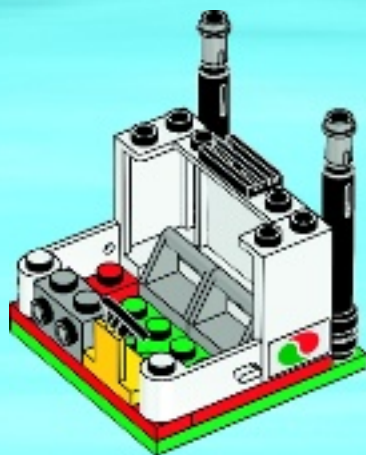

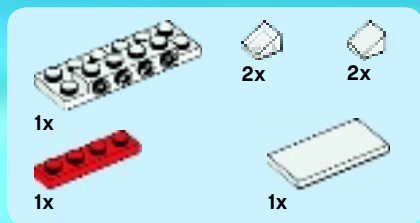

11

1

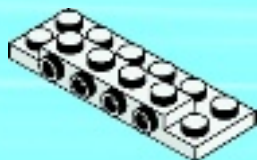

2

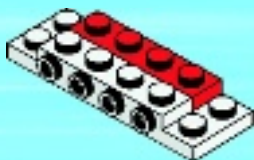

3

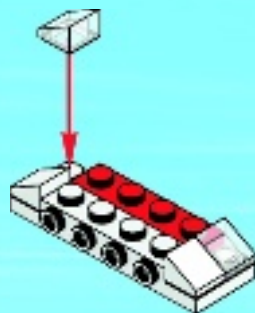

4

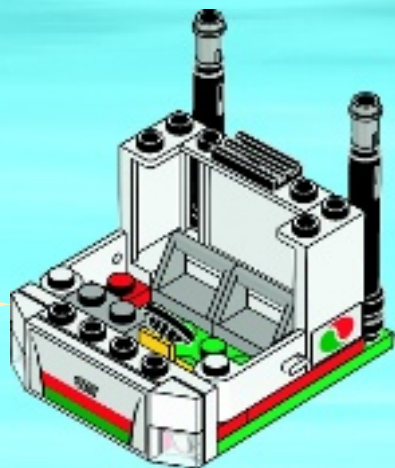
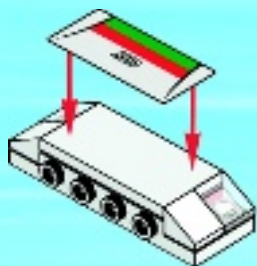



2x



1x

12



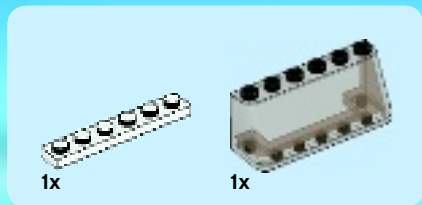

13

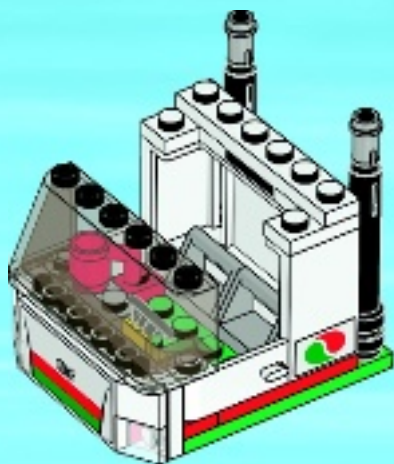

14





1x

15





1x



2x

16

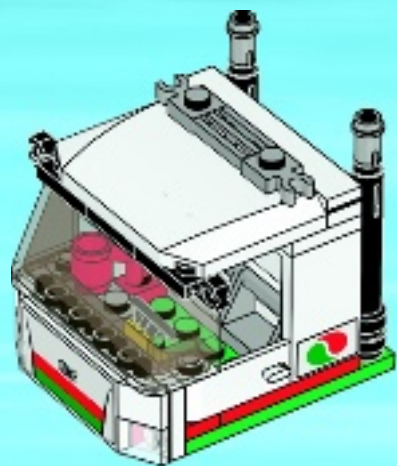

2x

17





2x



2x

18

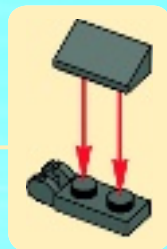
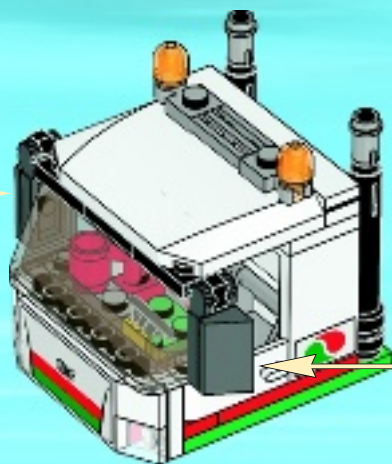
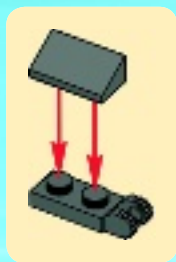

19

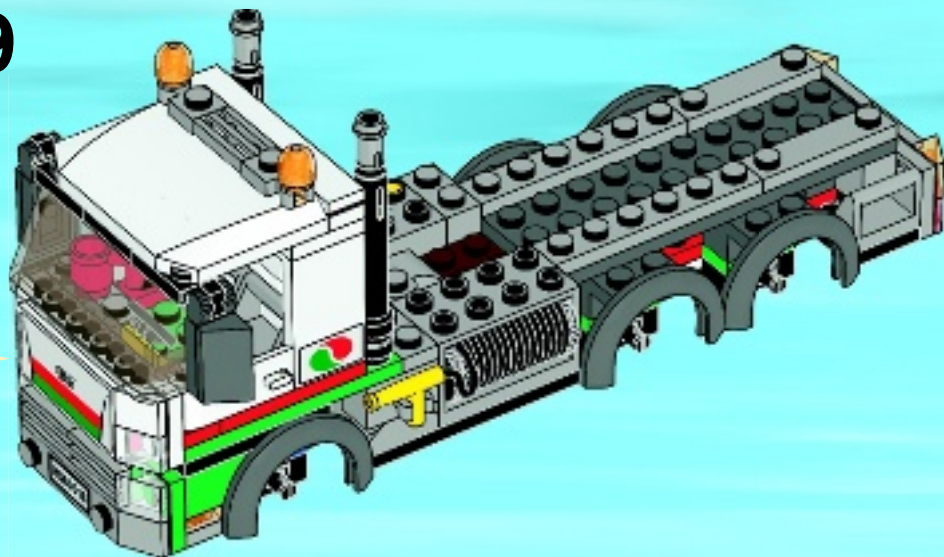

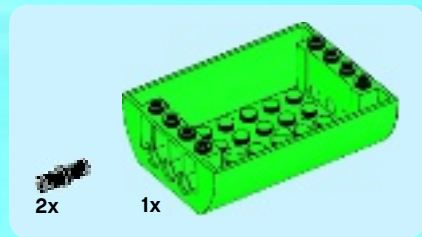

1

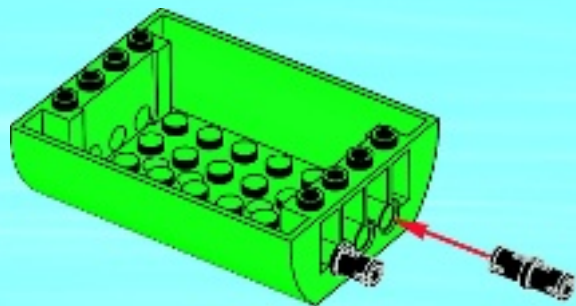

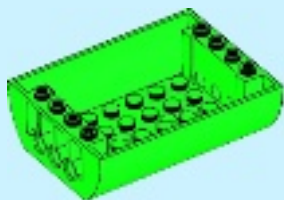

1x

2

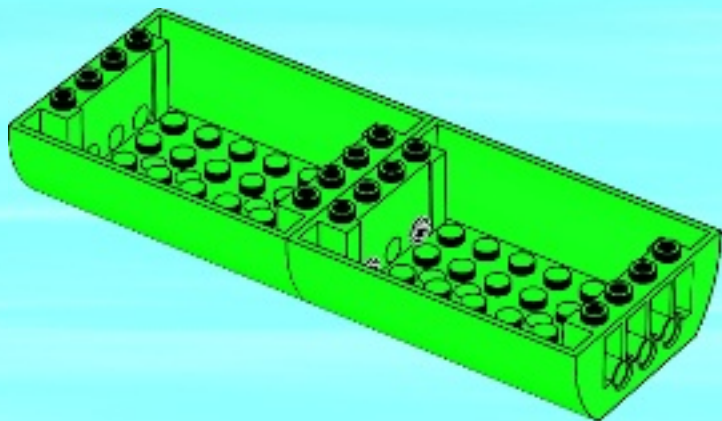



4x



2x

3

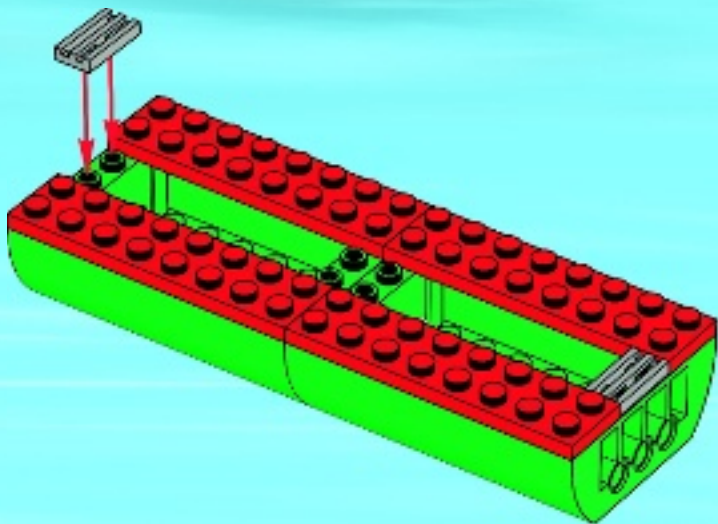



4

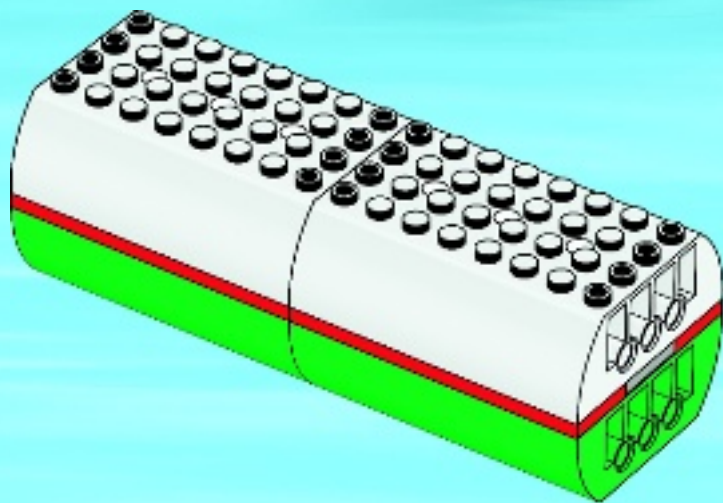



5

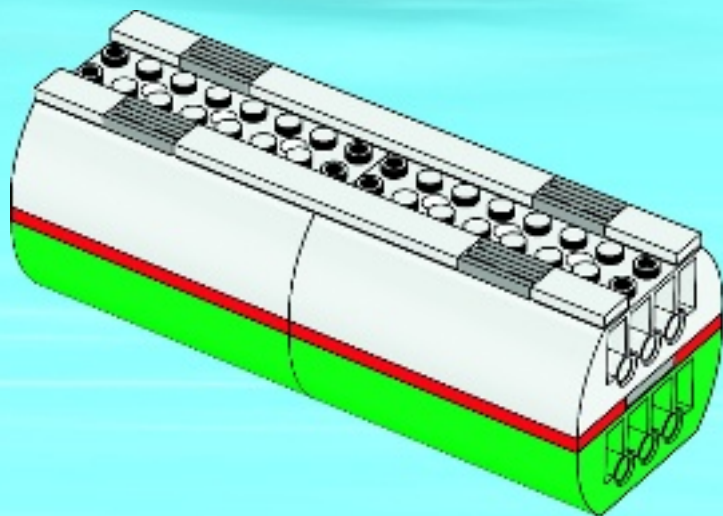



1x



2x

6

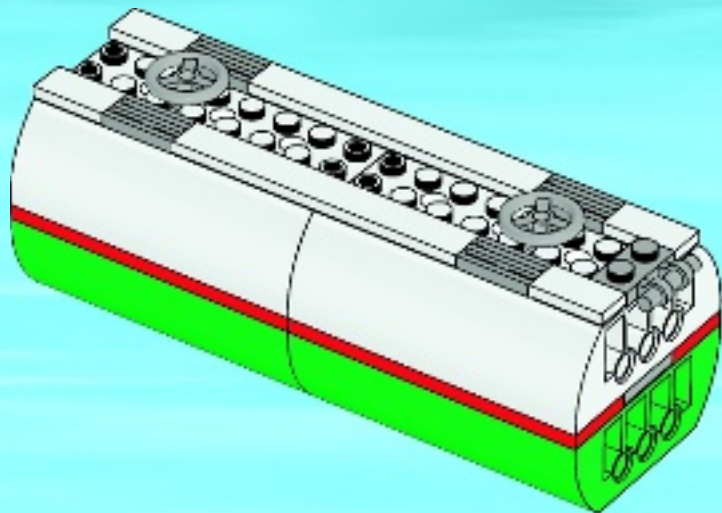

7

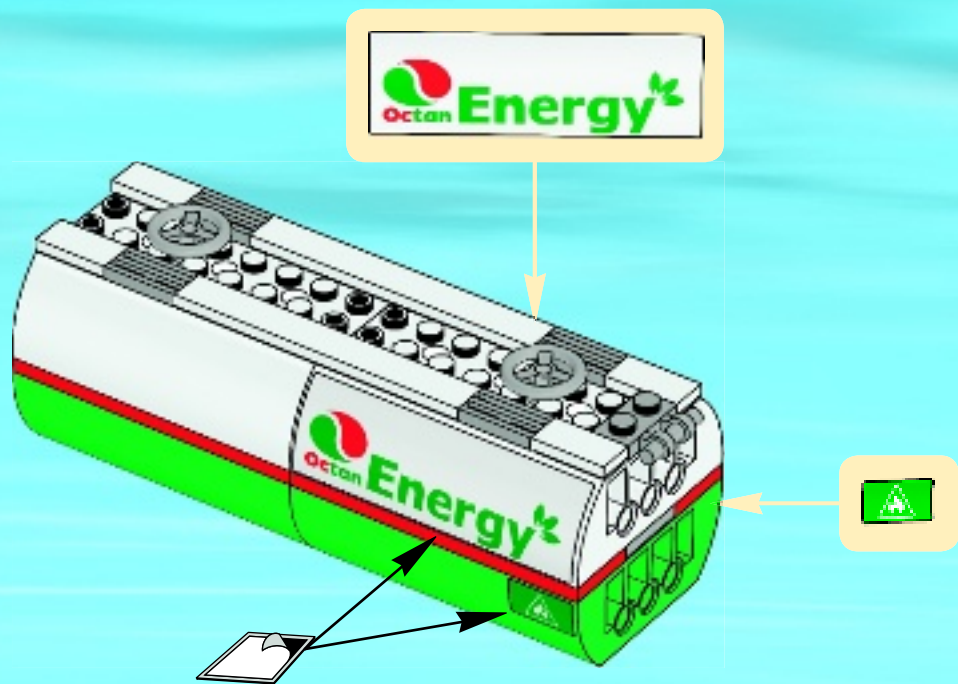

8

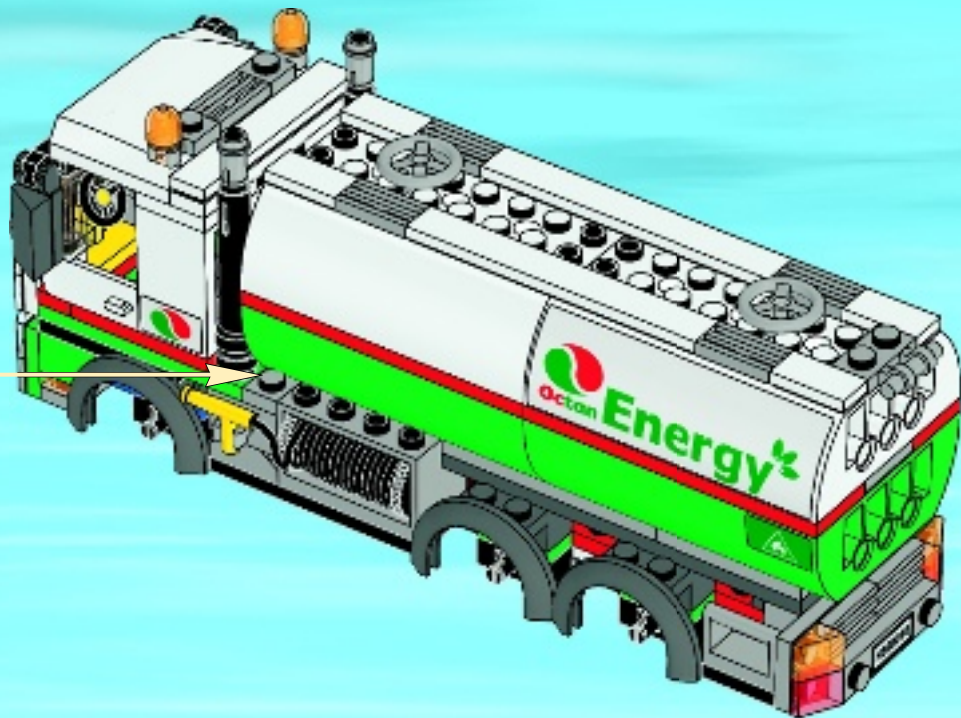

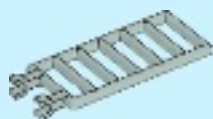

1x

9

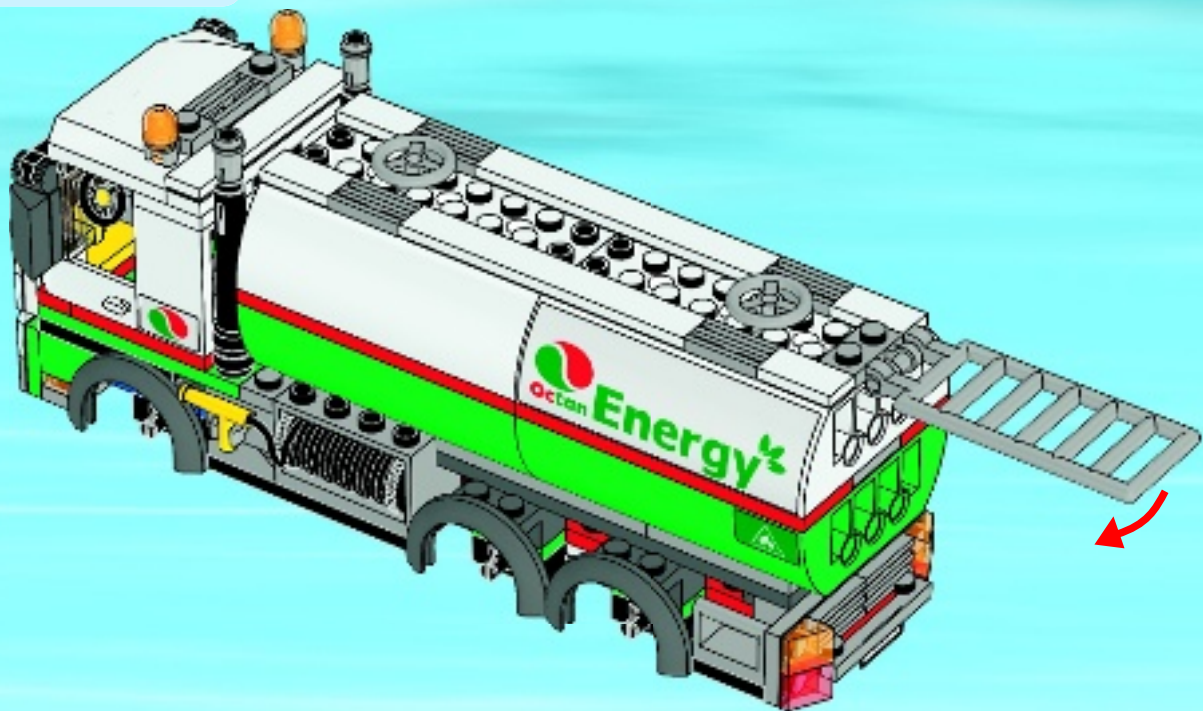



6x



6x

10

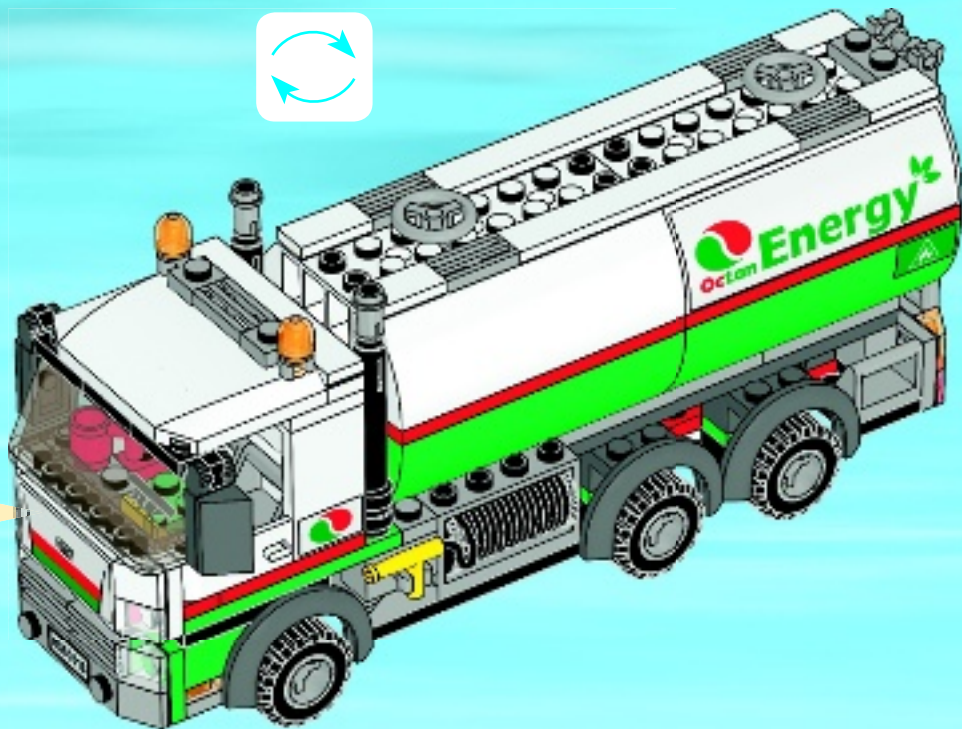
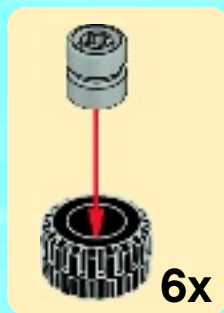



LEGO CITY



60016



60017



60018



4432



4433



CITY



60004



60003



60002



60001



60000



CITY

LEGO.com/city

**EXPLORE TONS OF GAMES,
MOVIES AND FUN CHALLENGES**



Entdecken viele Spiele, Filme und spannende Herausforderungen
Découvrez de nombreux films, jeux et défis amusants
Explora abundantos xogos, películas e desafíos divertidos
Explora una inmensidade de xogos, filmes e oportunidades de divertimento
Pudete tal ochotek (filmy, filmy, a hry) odpočítat



1x
300401



1x
362201



3x
4558952



2x
4504369



4x
4565324



2x
242001



1x
366601



6x
306901



2x
4560178



1x
663601



2x
416201



2x
4585448



1x
4558208

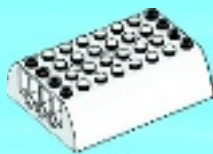

2x
6021716



1x
4527637



1x
4261565



1x
4537987



1x
4560929



1x
302321



1x
302221



5x
371021



1x
302021



1x
366621



4x
303421



1x
428221



1x
4534648



1x
389921



1x
4262022



1x
9553



1x
306224



2x
4256320



1x
4651441



1x
4243815



1x
9341



1x
4567909



2x
371026



1x
395826



2x
241226



2x
4183043



1x
306826



2x
4560182



1x
4653049



6x
4568644



6x
448826



2x
4569407



1x
4262023



1x
4558850



2x
4121715



1x
4181135



2x
4142717

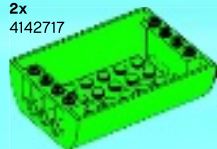

2x
6021714



6x
302328



1x
4626001



1x
6000070



1x
4173328



2x
4244369



2x
4542673



2x
4524365



2x
4216615



1x
4211564



1x
4641682



1x
4610112



1x
4211636



2x
4521921



1x
4228198



6x
4599498



4x
4211438



2x
6015344



2x
4598526



1x
4211632



2x
4594238



1x
4211452



2x
4211462

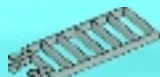

1x
4275673



11x
4211350



3x
4494475



2x
4520320



1x
6021710



4x
4211357



6x
4211764



3x
4211701



4x
4244362



2x
4244363



1x
4288003



2x
4210636



2x
4567887



1x
4211133



1x
4211122



2x
4210884



1x
4210811



6x
4260124



Customer Service

Kundenservice

Service Consommateurs

Servicio Al Consumidor

LEGO.com/service or dial



: 00800 5346 5555

: 1-800-422-5346



WIN!

Go to www.LEGOsurvey.com/product to fill out a survey for a chance to win a cool LEGO® Product.

No purchase necessary.

Open to all residents where not prohibited.



www.LEGOsurvey.com/product

GEWINNE!

Nimm an der Umfrage auf www.LEGOsurvey.com/product teil und hab die Chance ein cooles LEGO® Produkt zu gewinnen!

Die Teilnahme am Gewinnspiel führt zu keinerlei Kaufverpflichtungen. Teilnahme in allen nicht ausgeschlossenen Ländern möglich.

WIN!

Ga naar www.LEGOsurvey.com/product, vul een enquêteformulier in en maak kans op een cool LEGO® product.

Geen aankoopverplichting. Iedereen mag deelnemen, uitgezonderd ingezetenden van landen waar een enquêteverbod geldt.

GAGNE!

Visite www.LEGOsurvey.com/product pour répondre à un questionnaire et avoir une chance de gagner un produit LEGO® très cool!

Aucune obligation d'achat. Ouvert à tous les résidents des pays autorisés.

当てよう!

www.LEGOsurvey.com/product にアクセスして、アンケートにご記入ください。当選者にはレゴ®製品を差し上げます。

お買い上げの必要はありません。禁止されていない限り、すべての皆様にご利用いただけます。



LEGO.com

6033600

LEGO and the LEGO logo are trademarks of the LEGO Group. ©2013 The LEGO Group.