

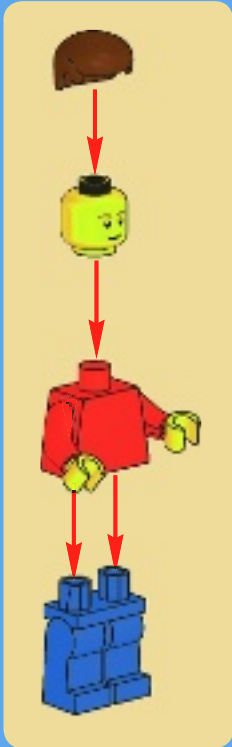

# CREATOR

5771





1

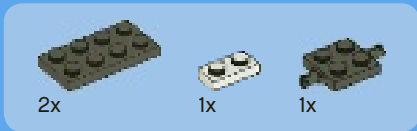
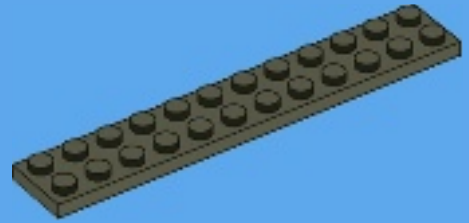

2

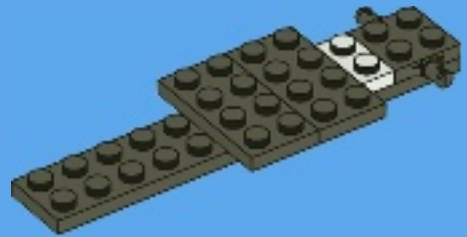

3



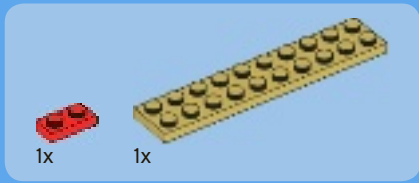

4

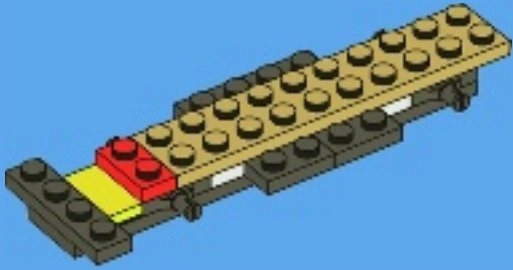

5

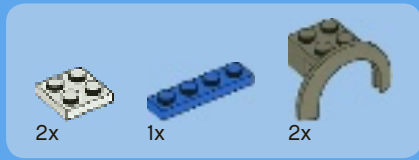
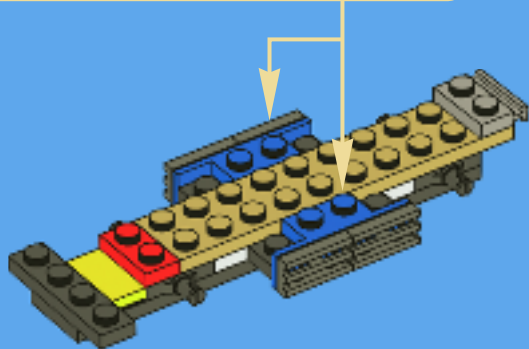
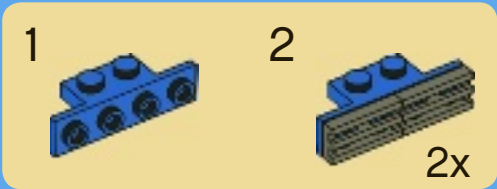

6

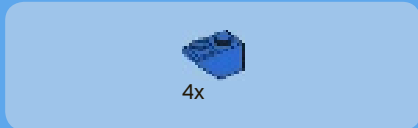
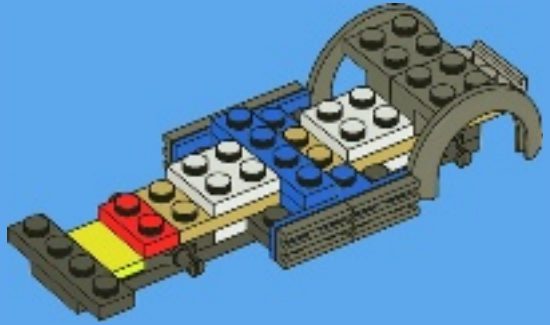

7

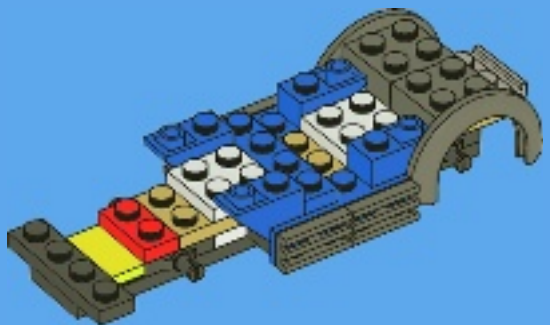



1x



1x



2x

# 8

1

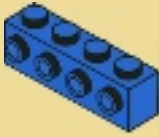

2

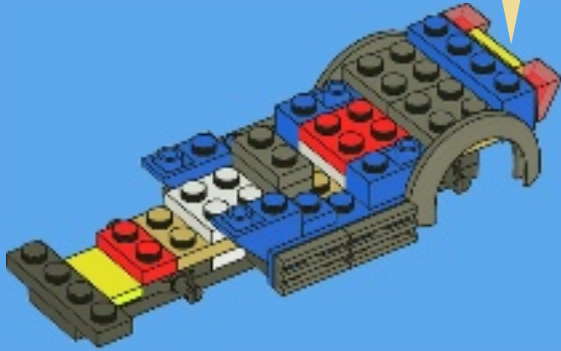
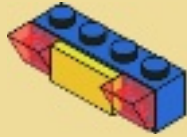

2x



1x



2x

# 10

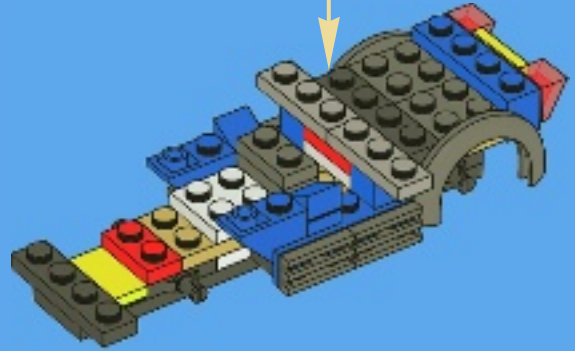
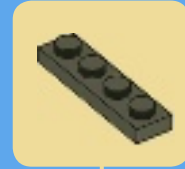

1x



2x

# 9

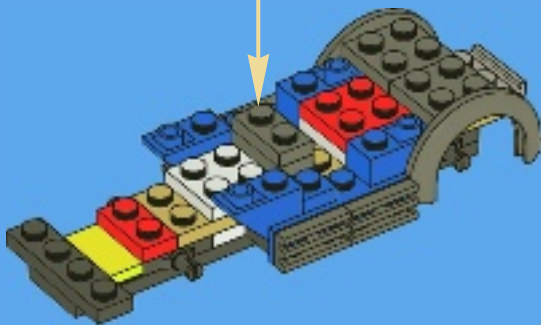
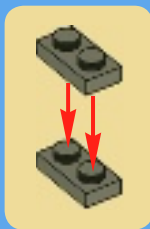

1x



2x

# 11

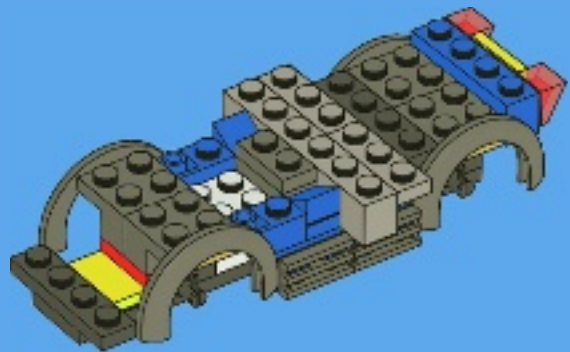



2x

# 12

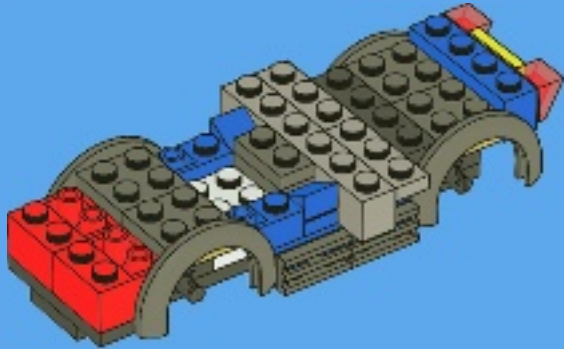

2x



2x

# 14

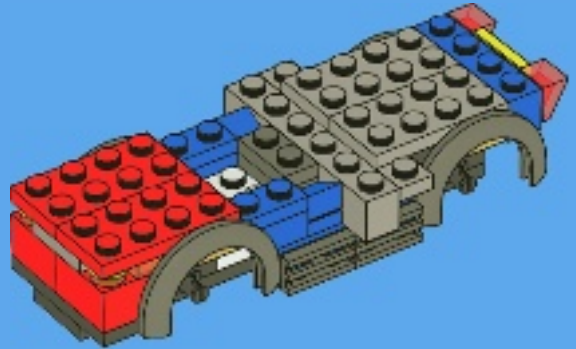

2x



2x



1x



2x

# 13

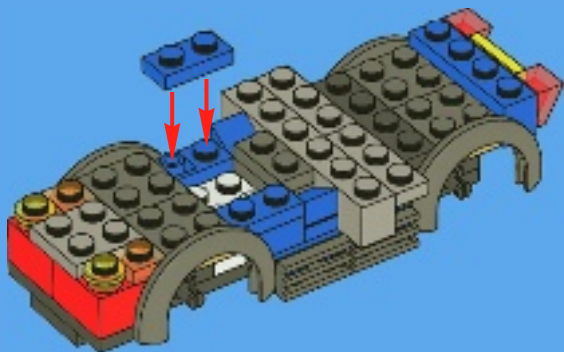

1x



1x



1x

# 15

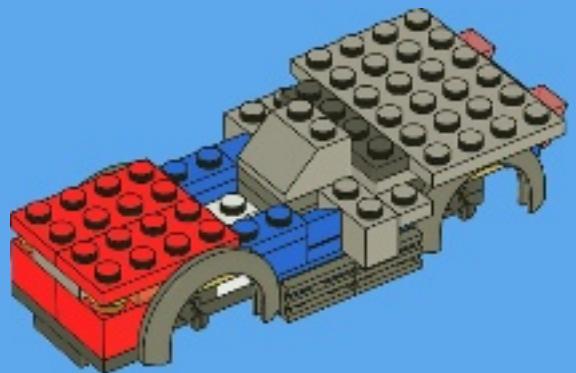



1x



1x



2x

# 16

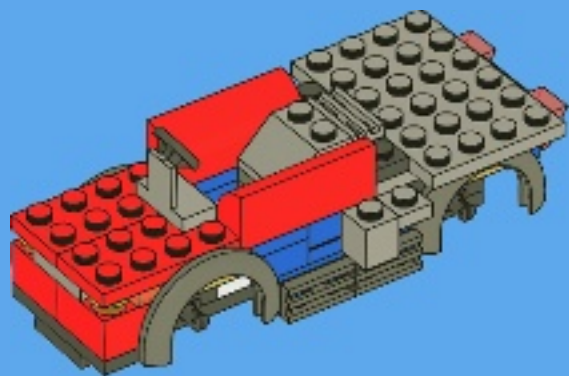

1x



2x

# 17

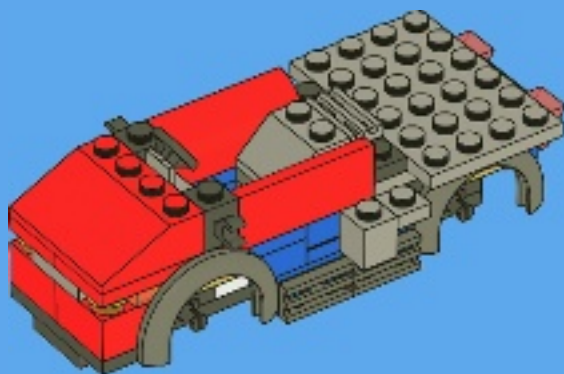

2x



2x

# 18

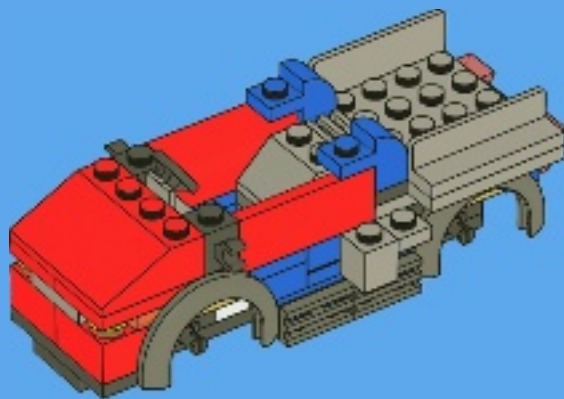

2x



1x



1x

# 19

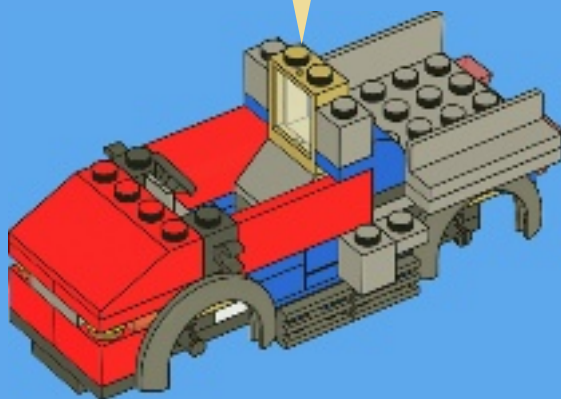
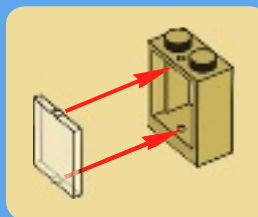



20

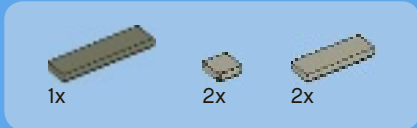
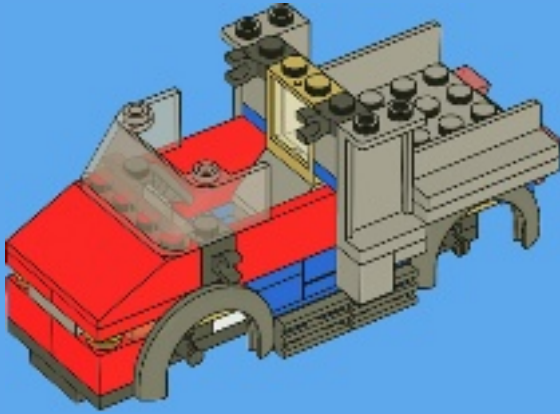

21

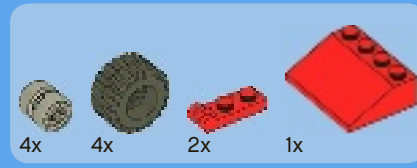
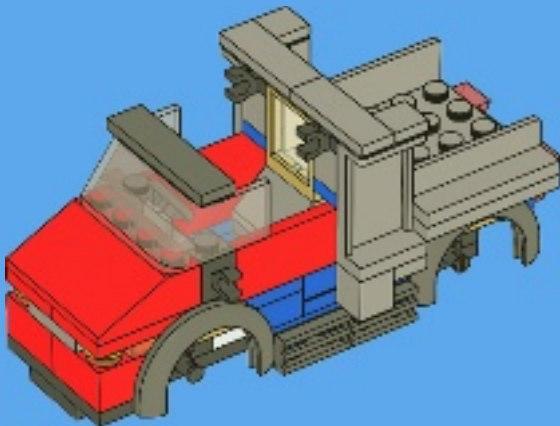

22

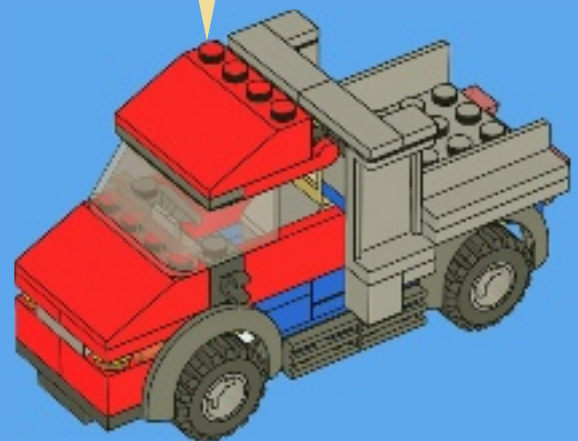
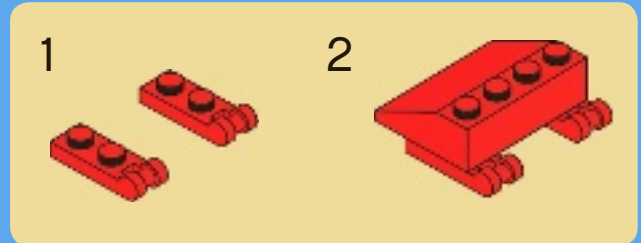

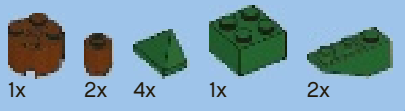

# 23

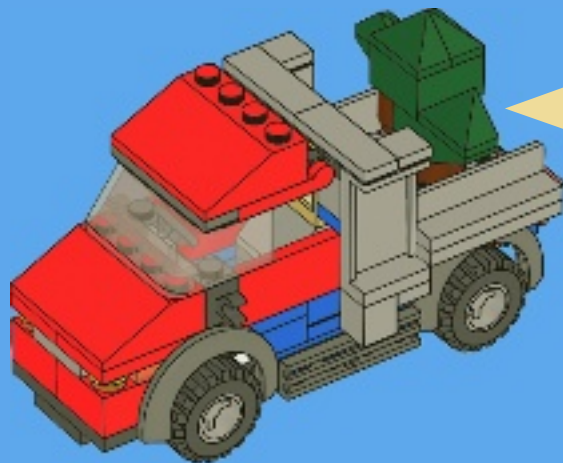
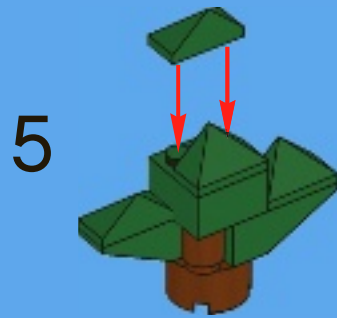
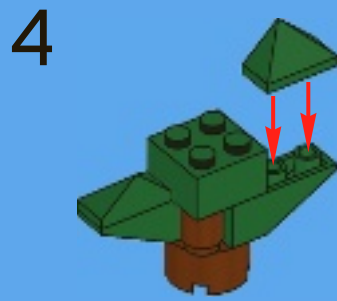



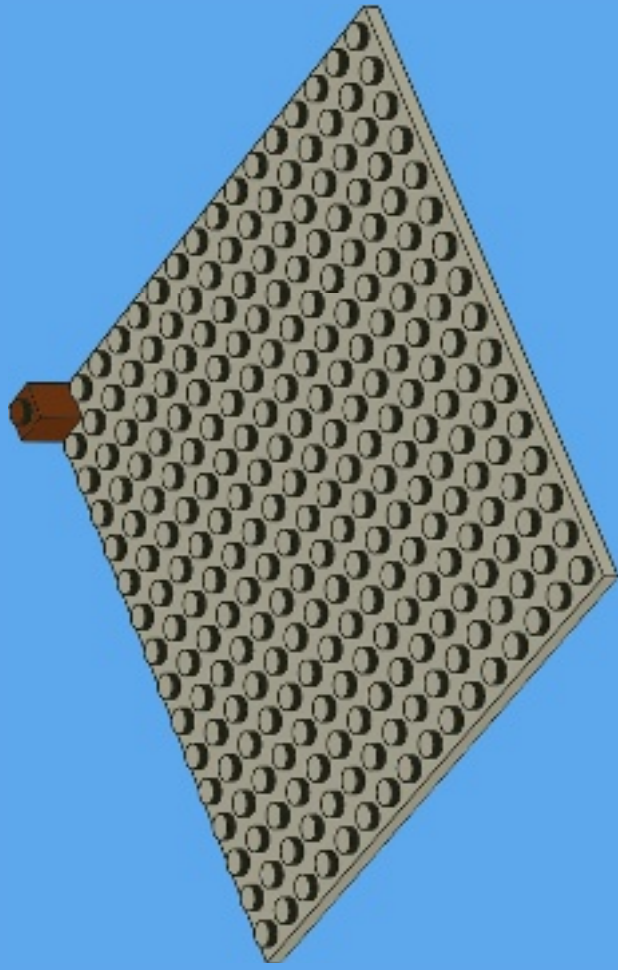

1

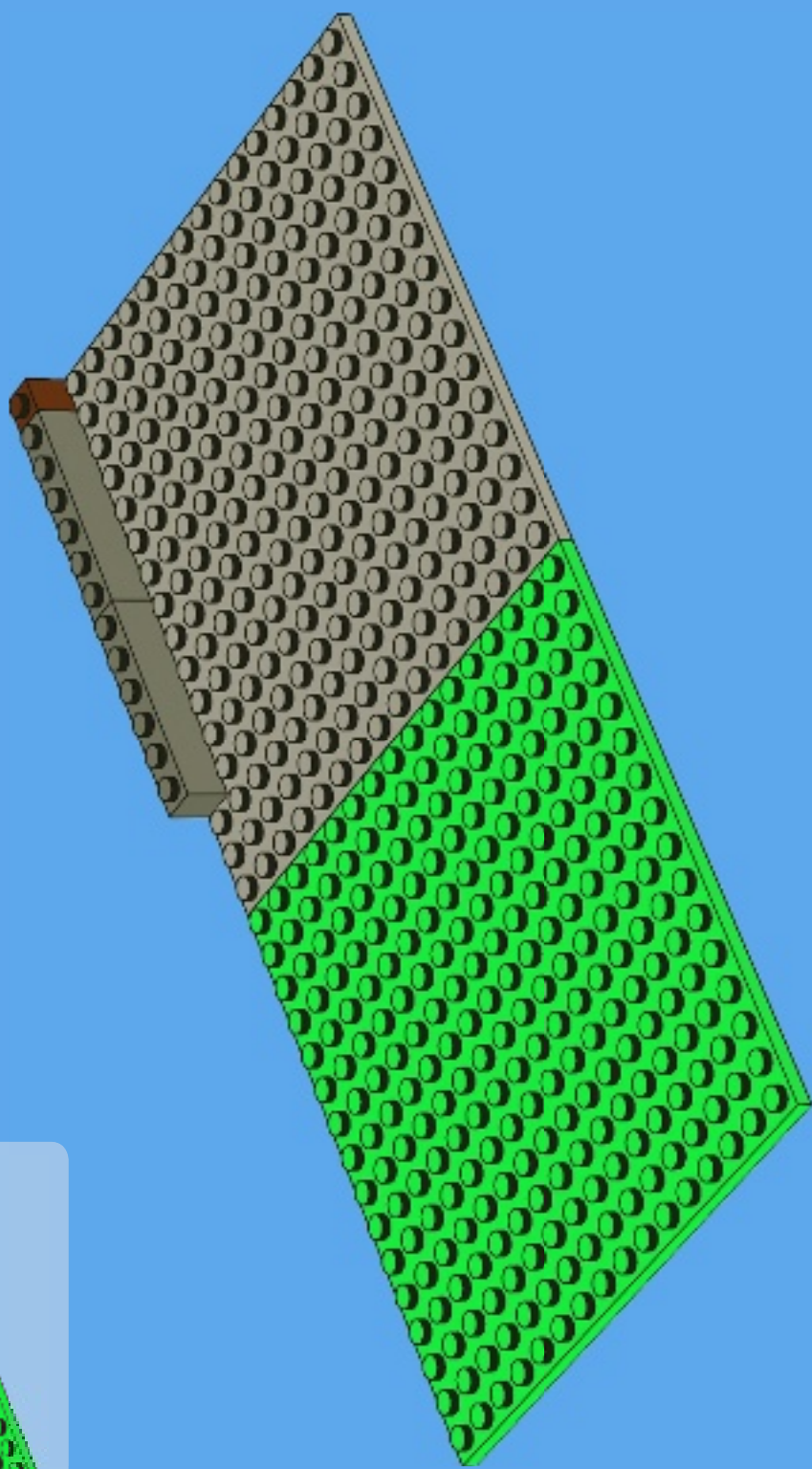
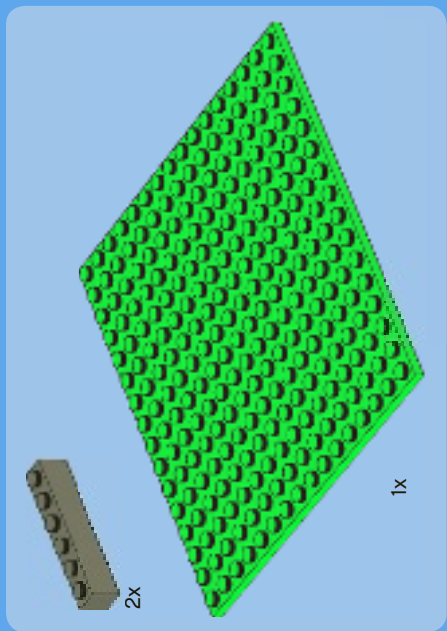

2

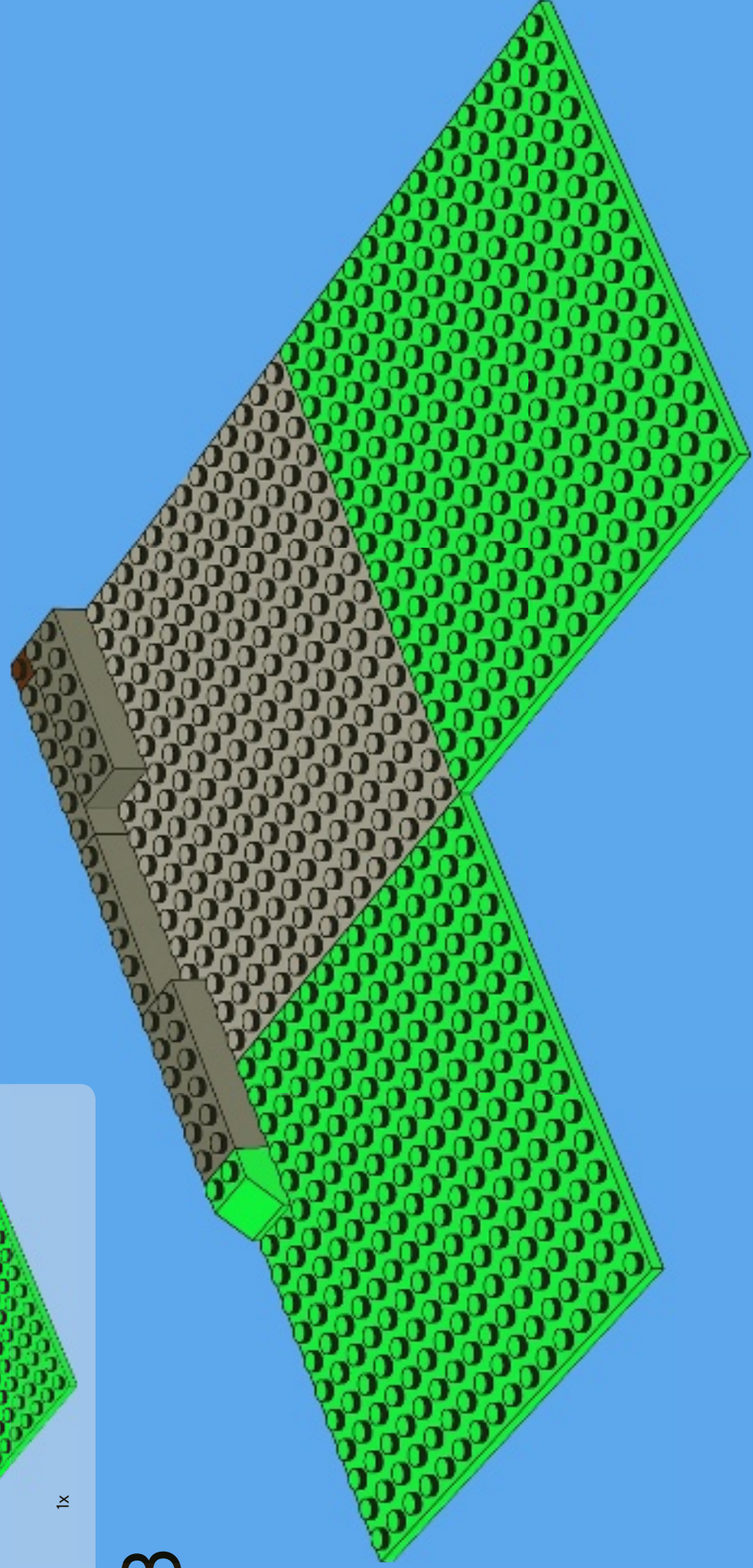
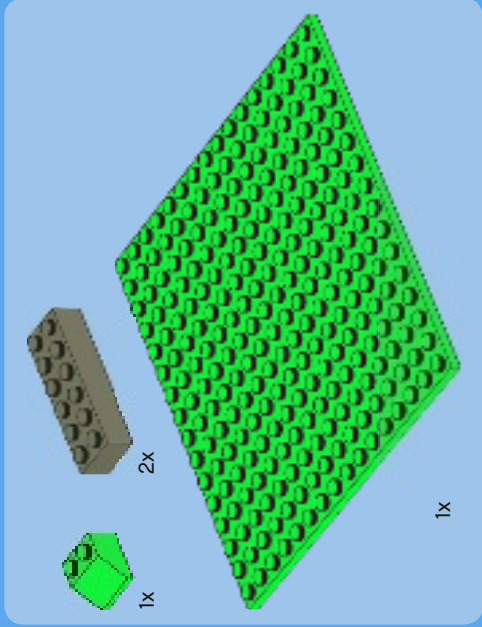

3

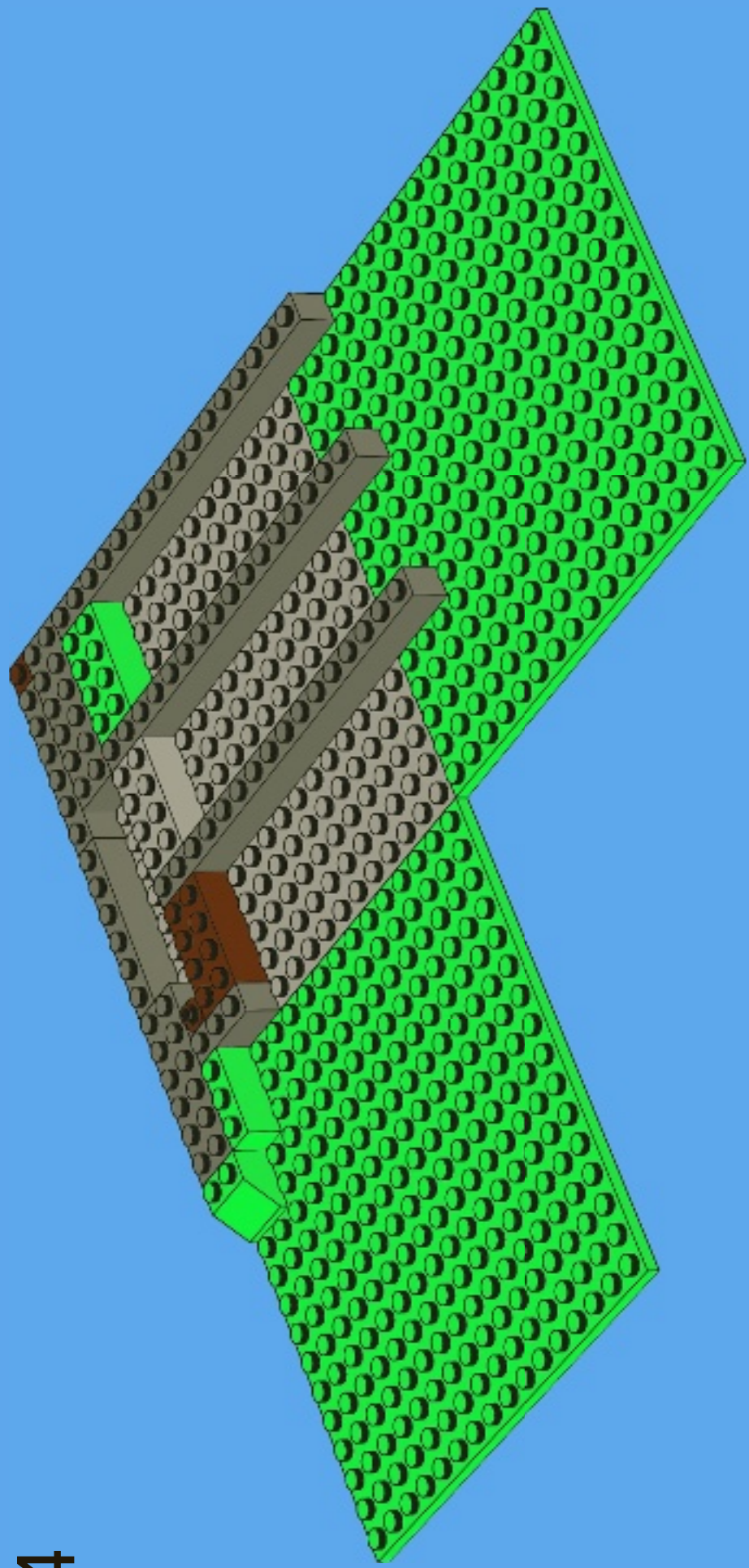
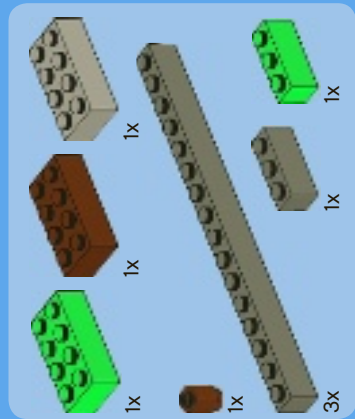

4

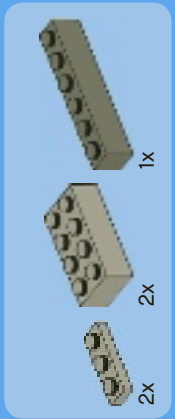

5

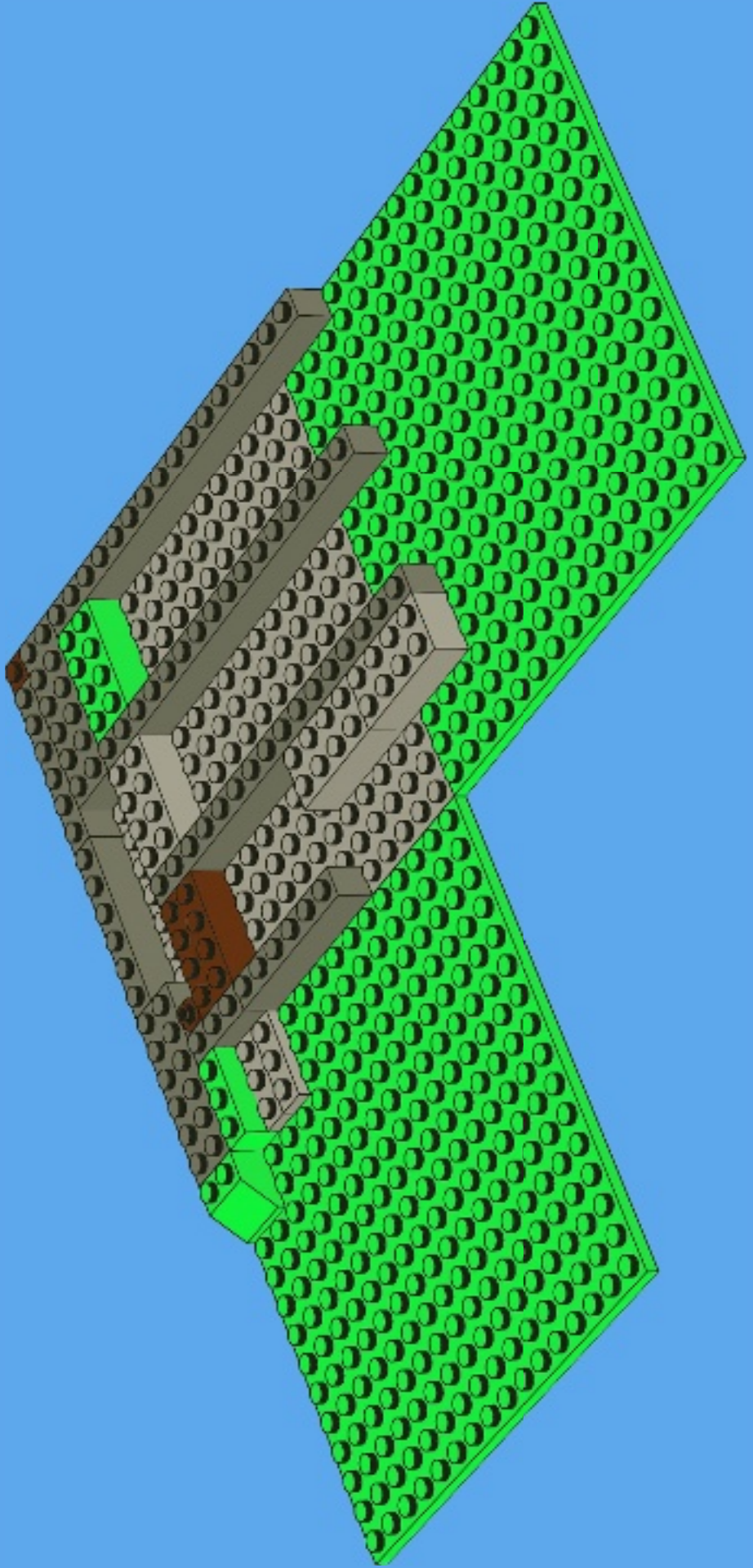

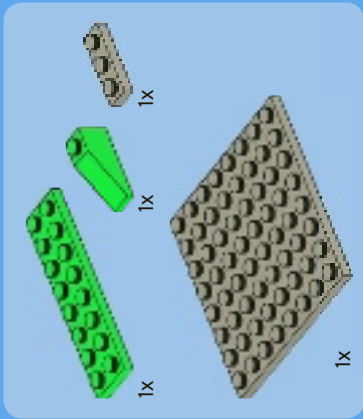
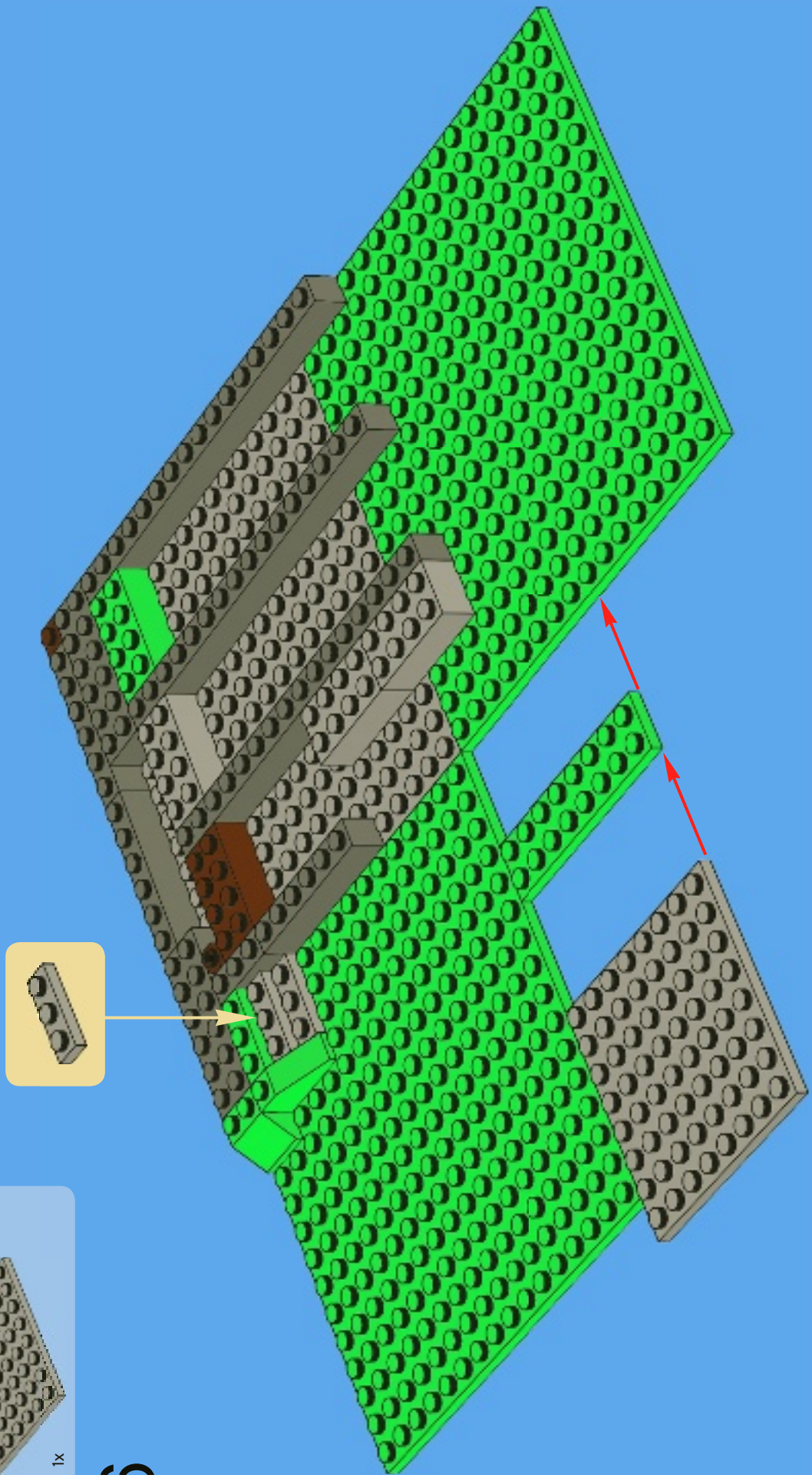

6

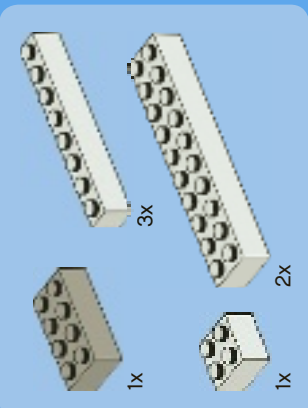
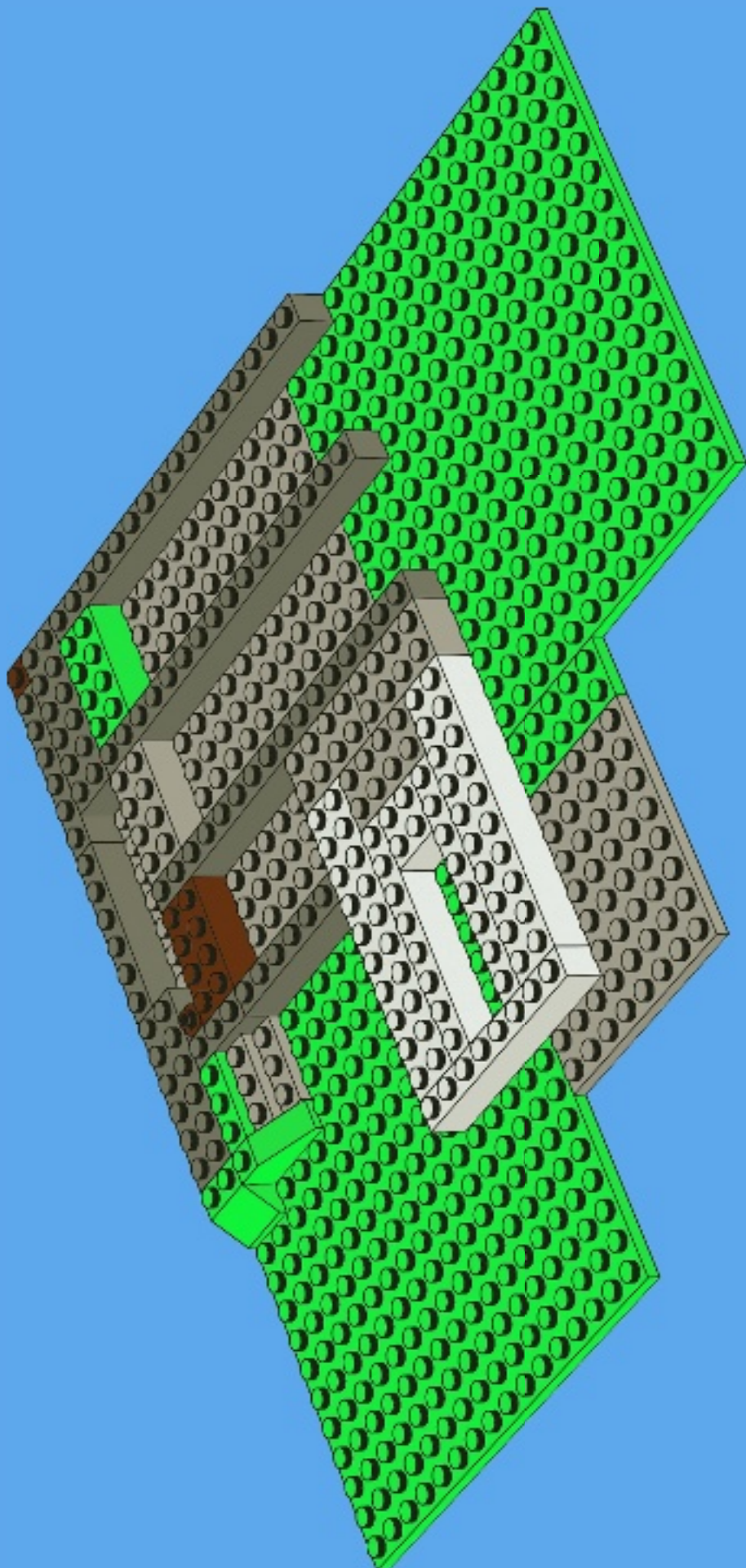

7

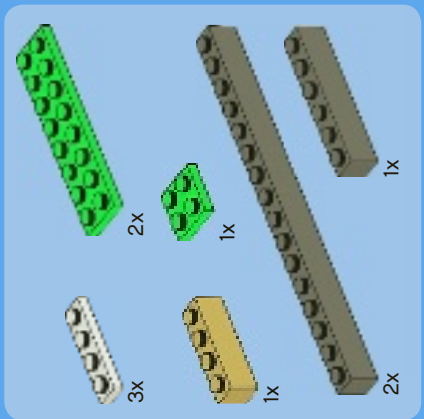
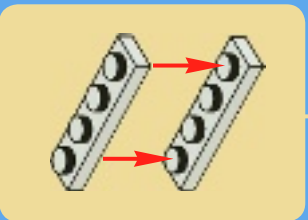
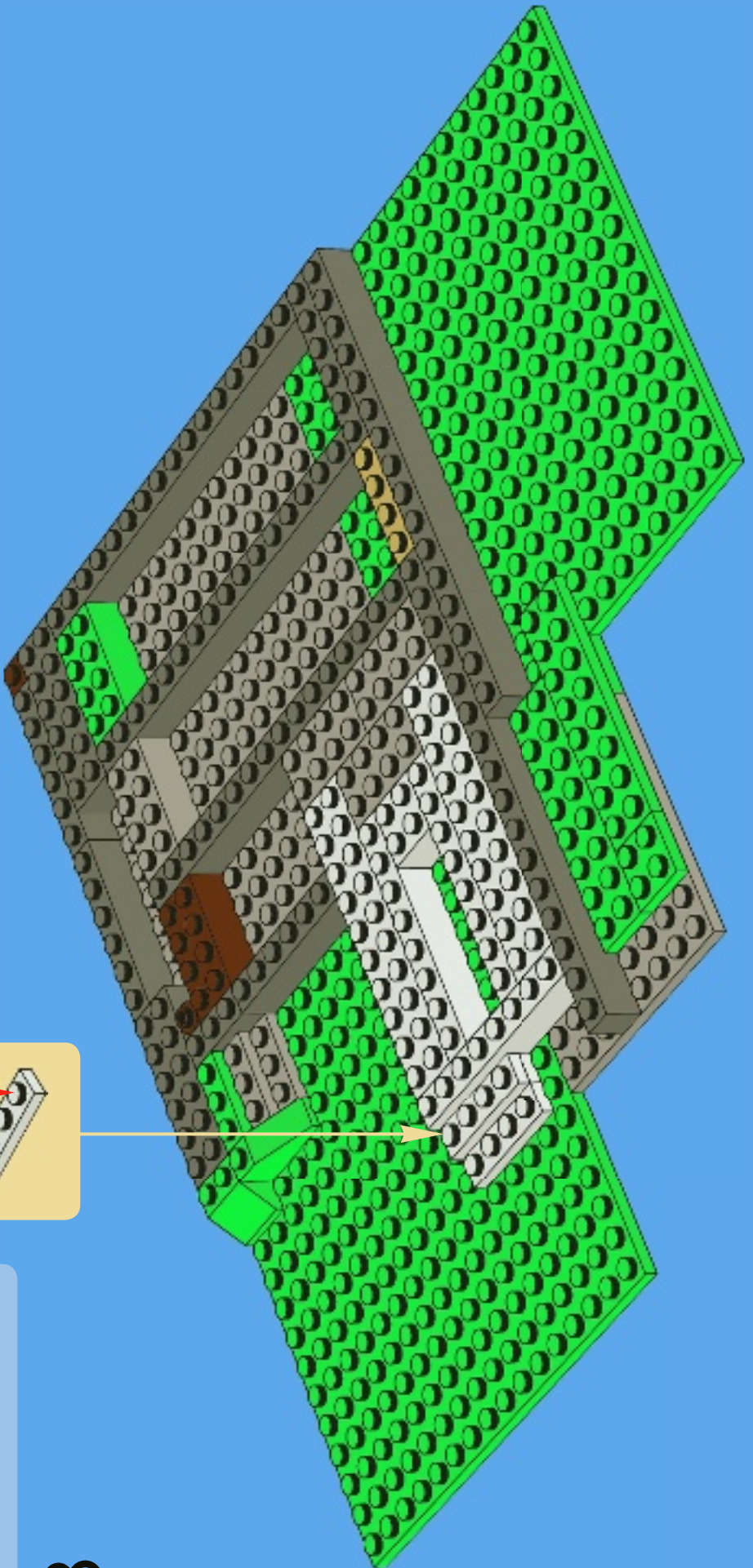





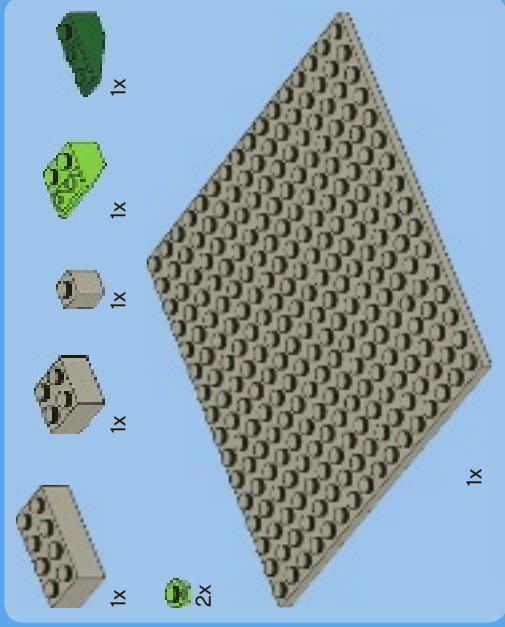

8

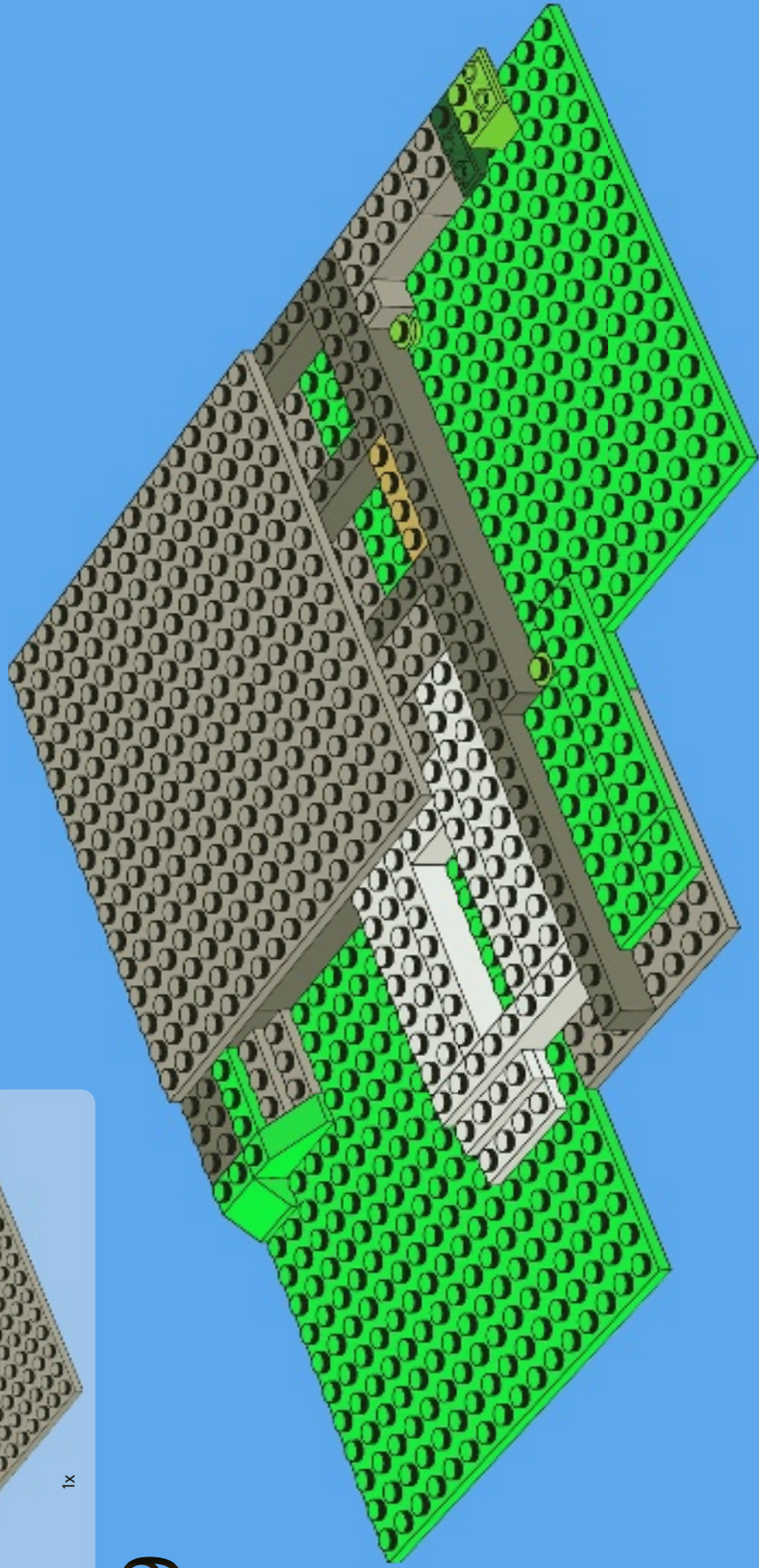



9



-  4x
-  2x
-  1x
-  1x
-  3x

# 10

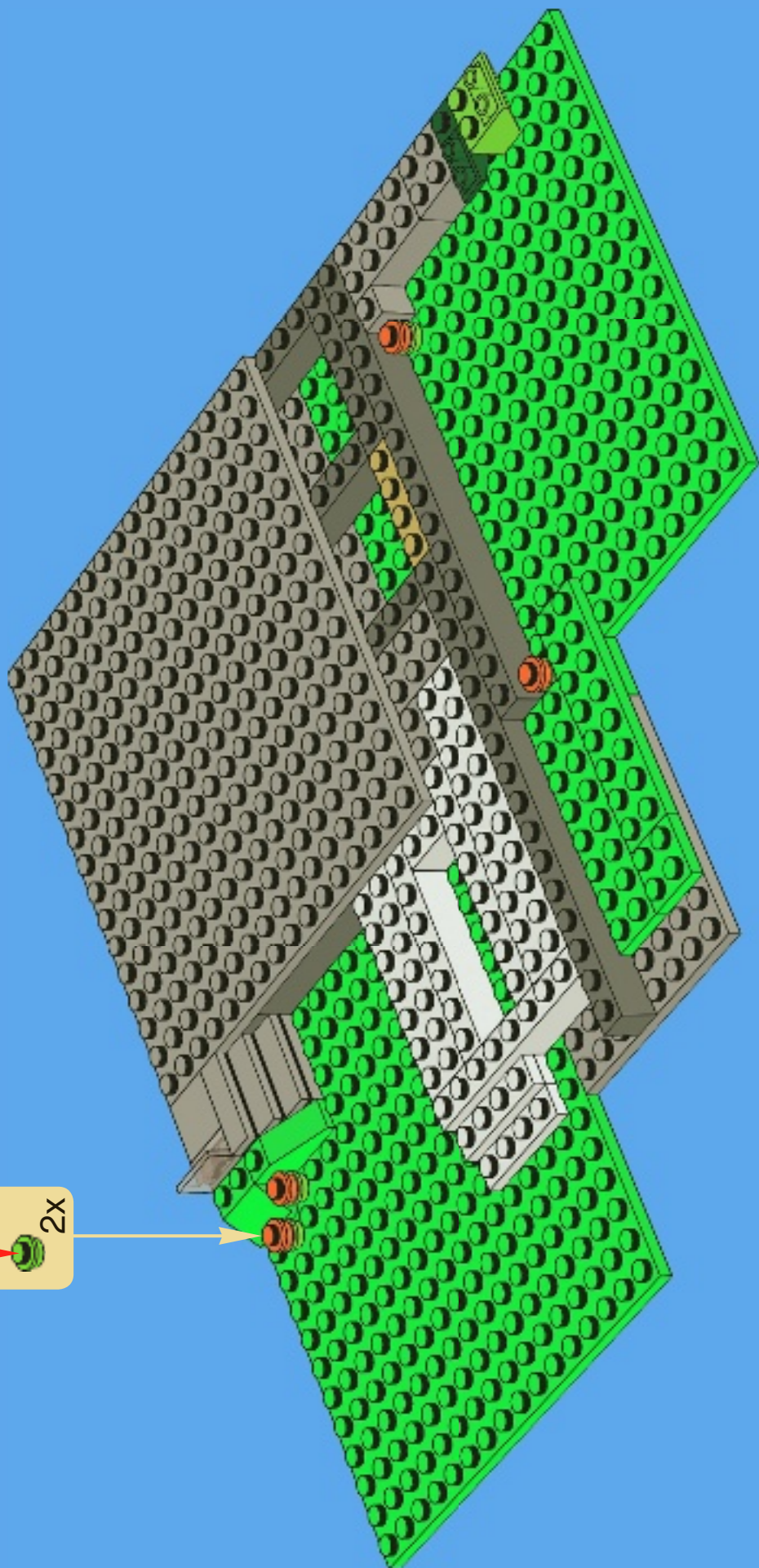

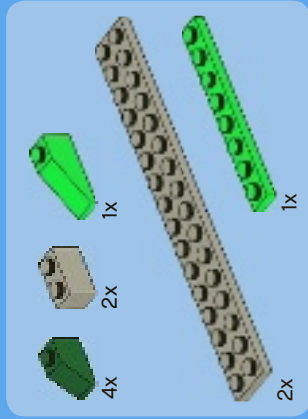

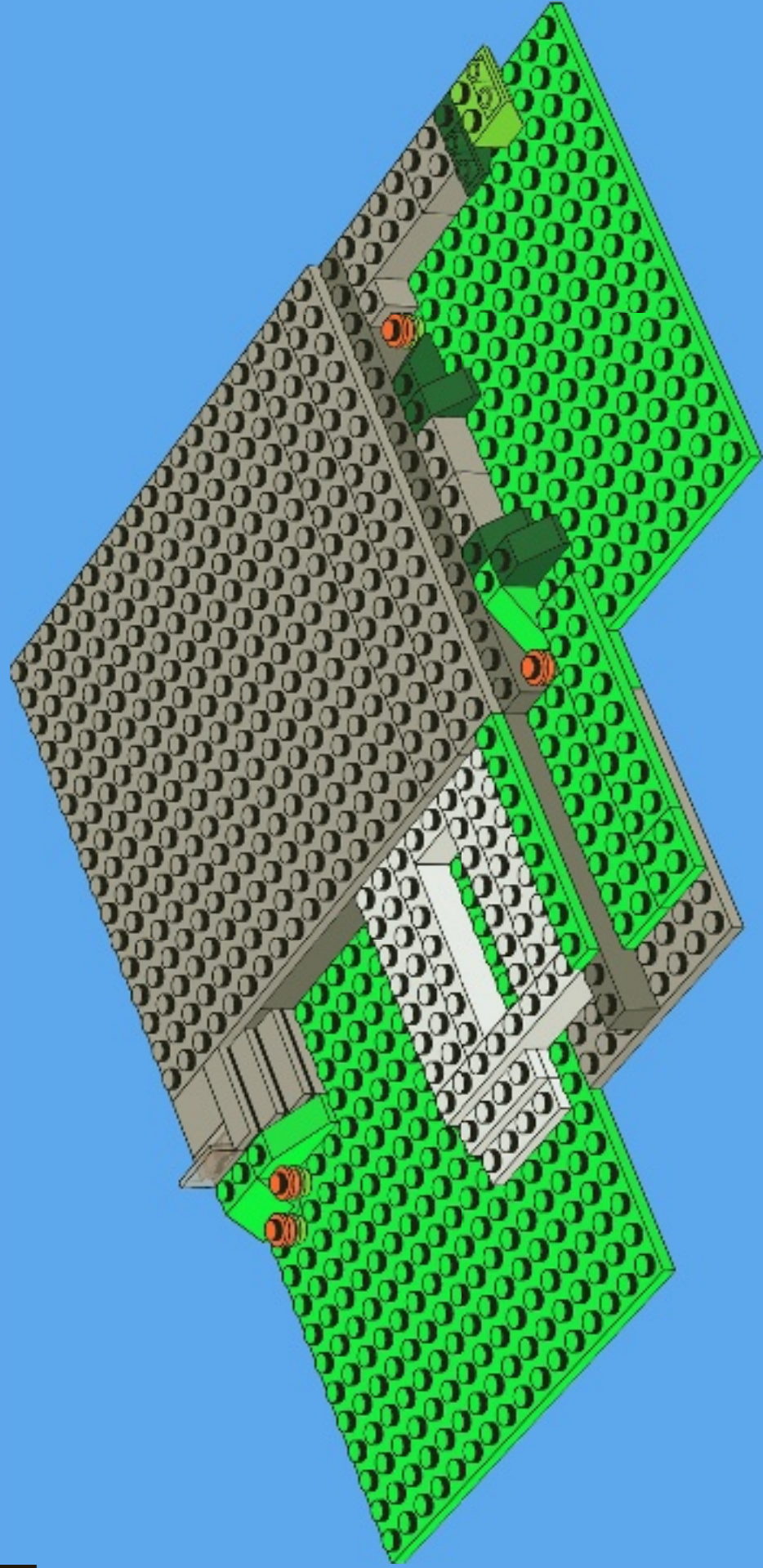

11



- 3x  3x 
- 2x  2x 
- 3x  2x 

# 12

- 3x  

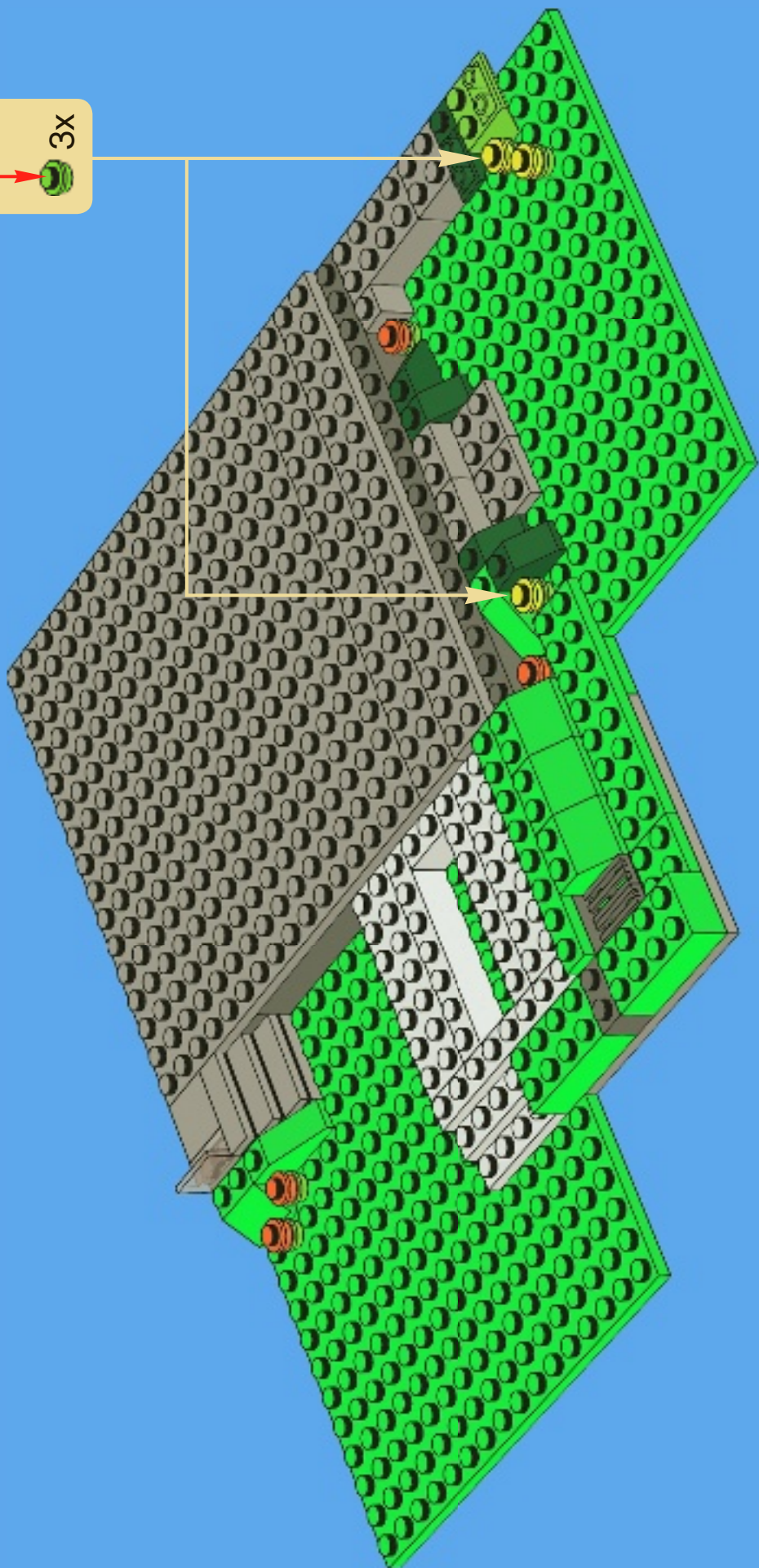

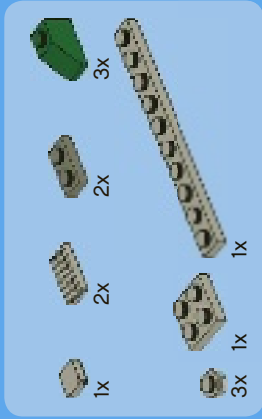

13

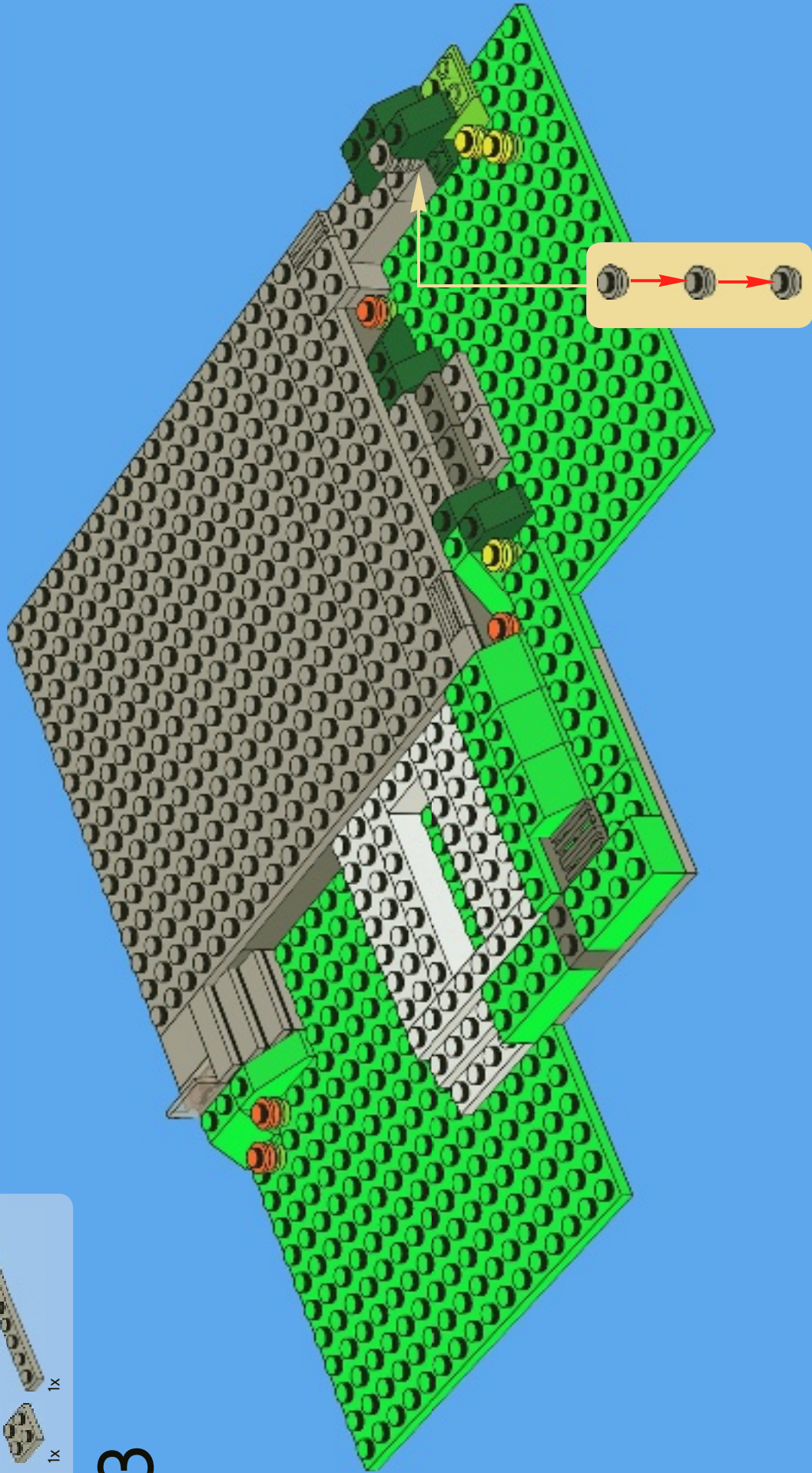

-  1x
-  2x
-  1x
-  4x
-  2x

# 14

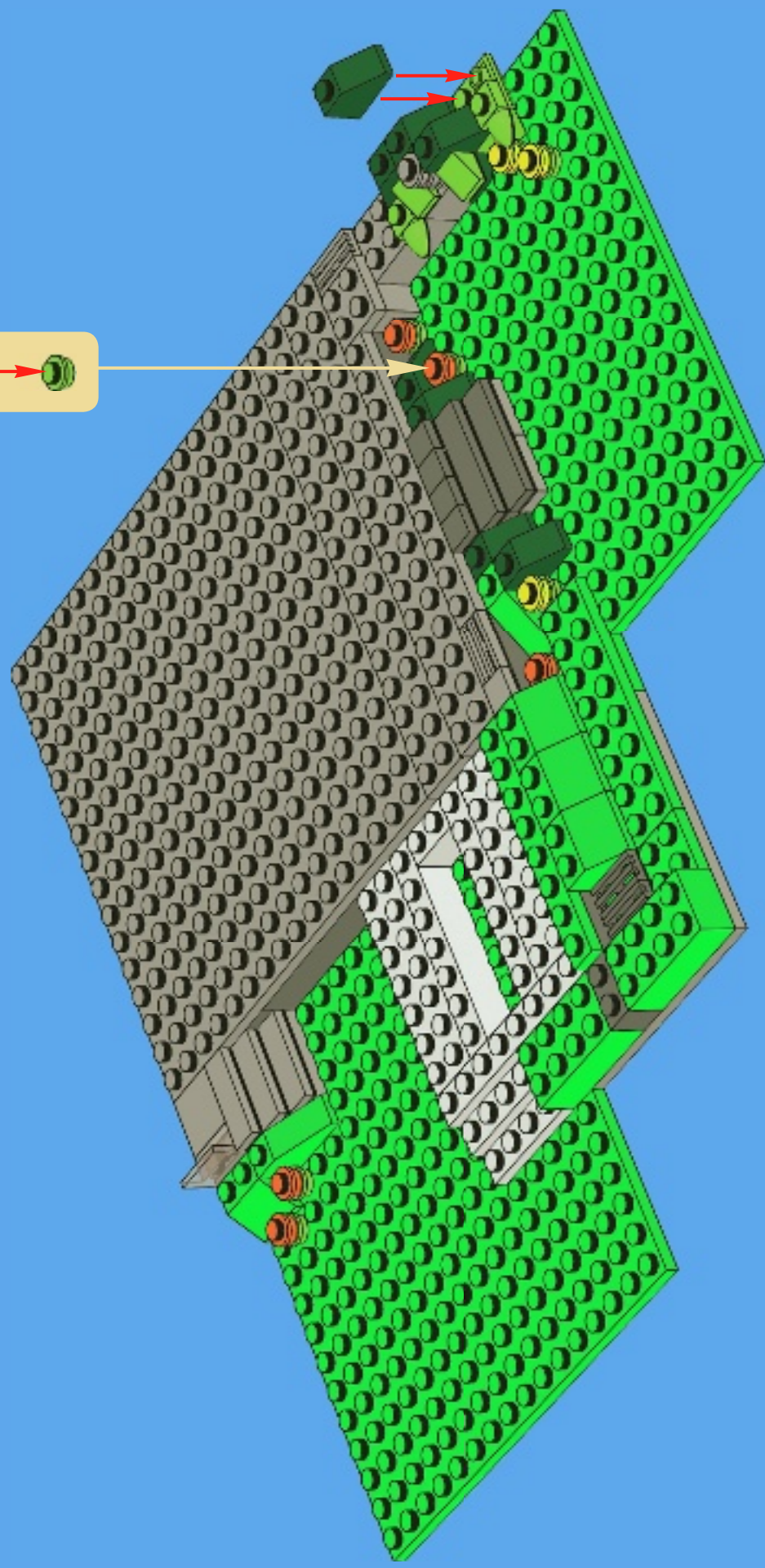



15

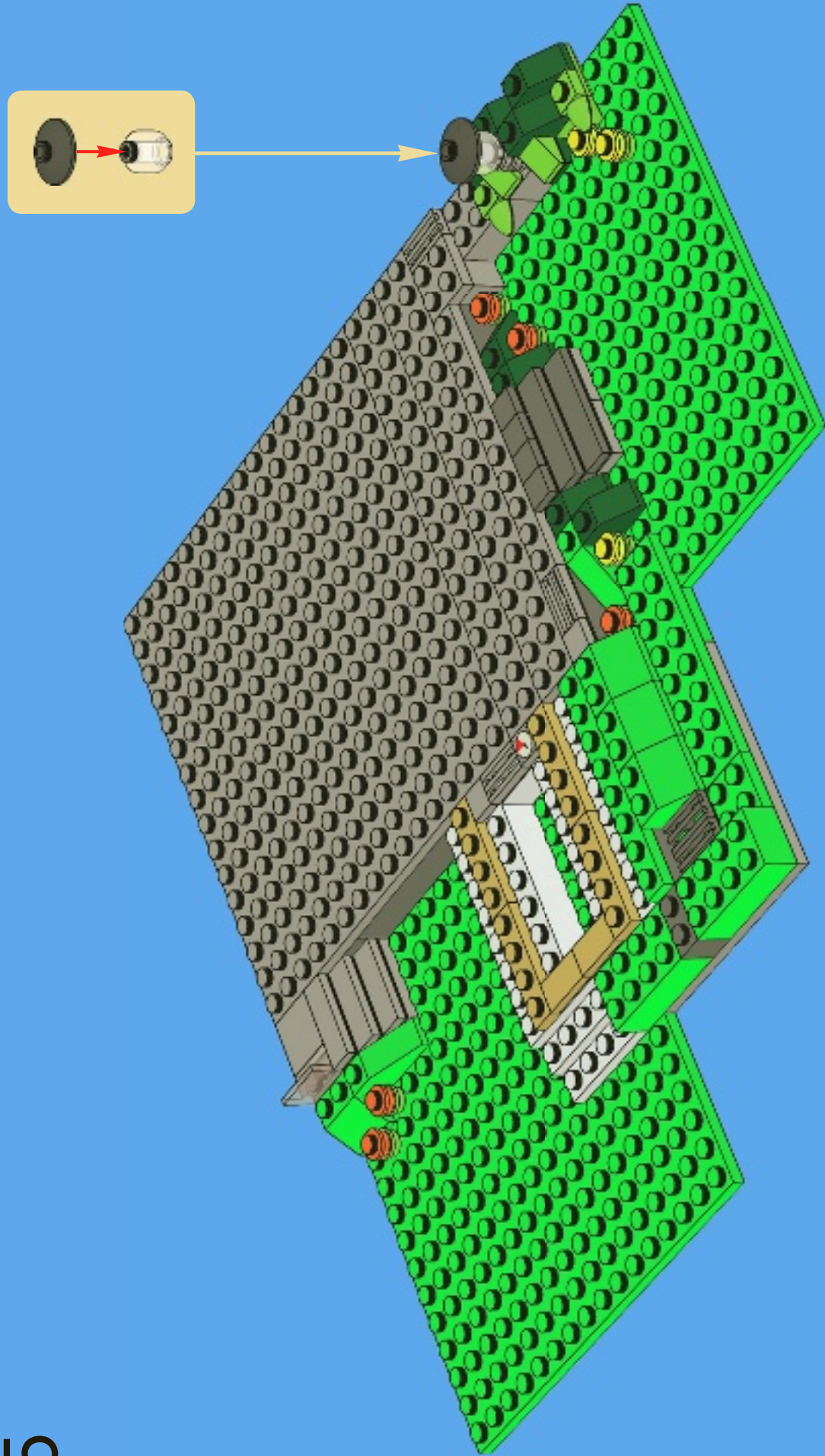



16

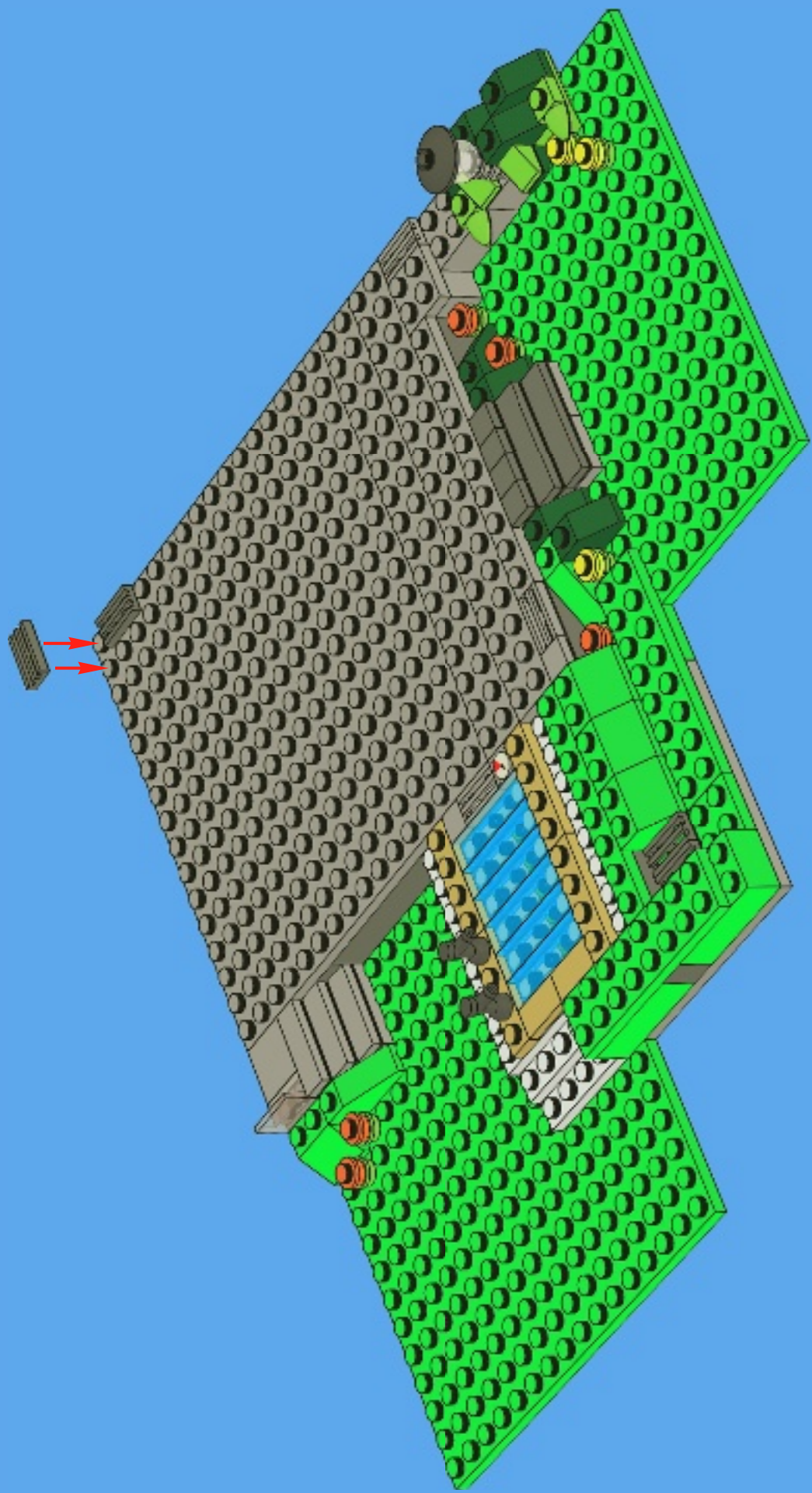





1x



1x



1x



1x



1x

# 17

1



2



3

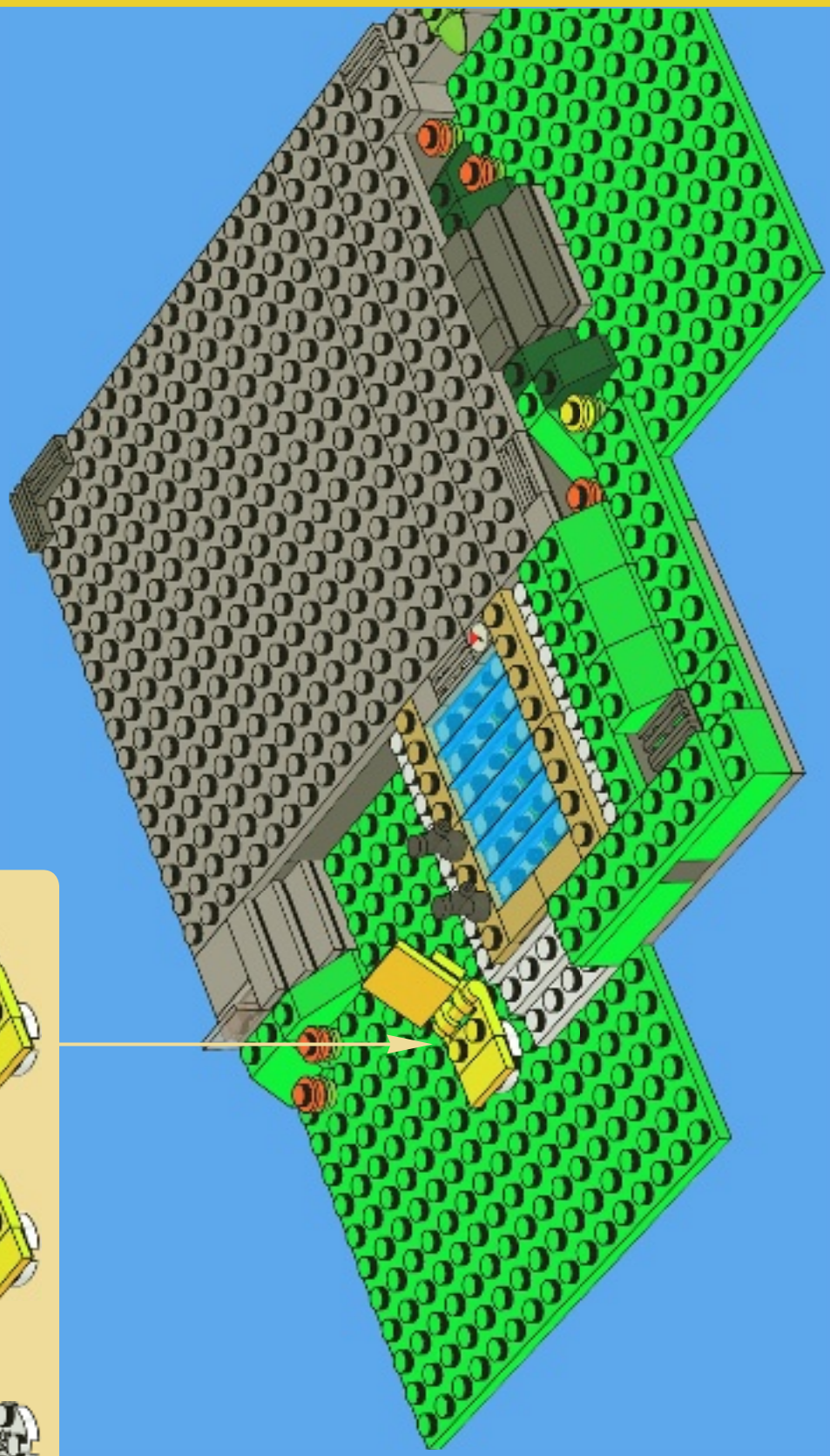
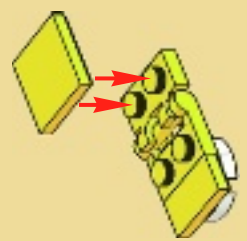

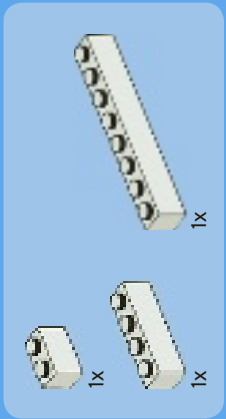



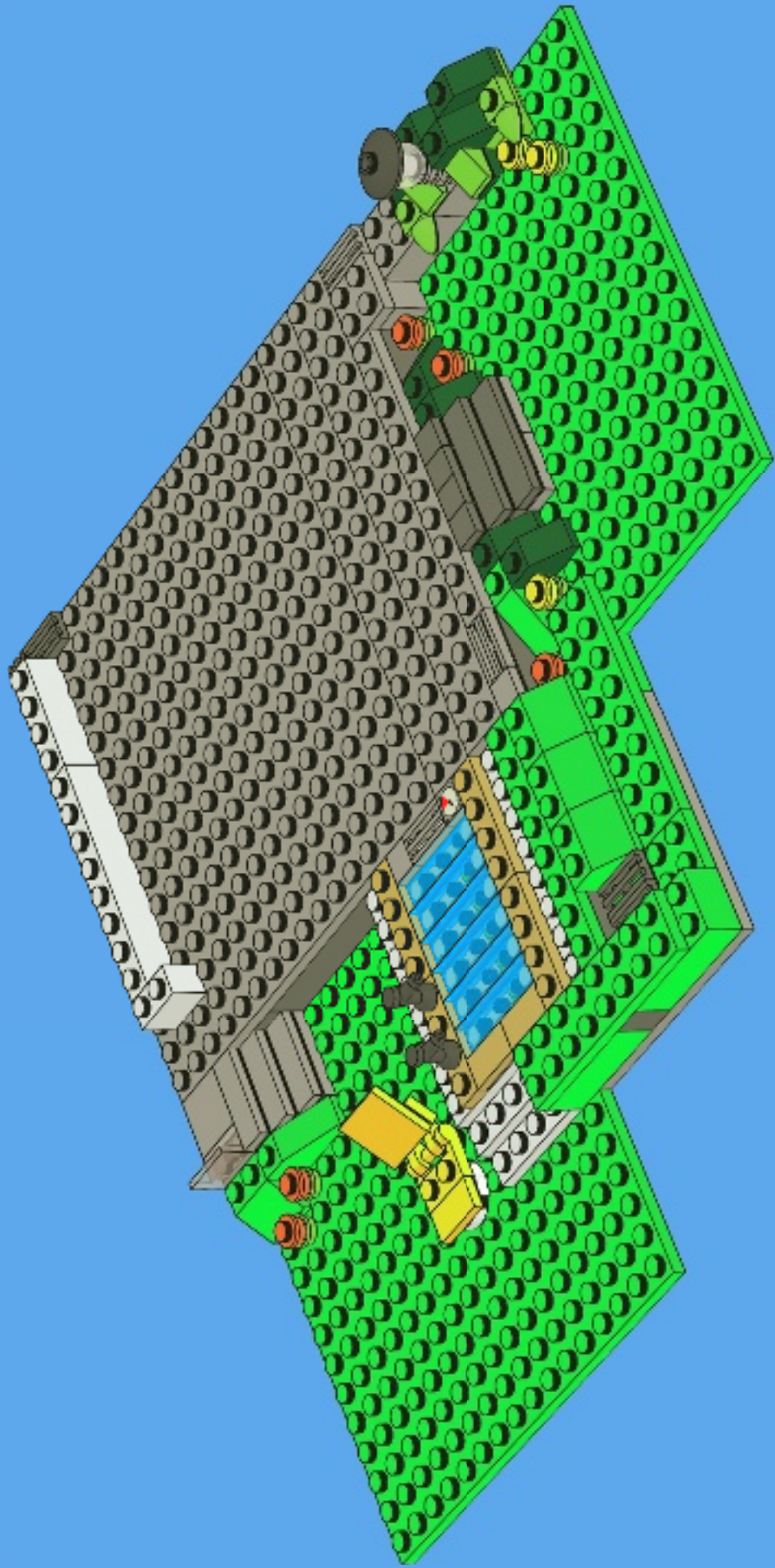

18



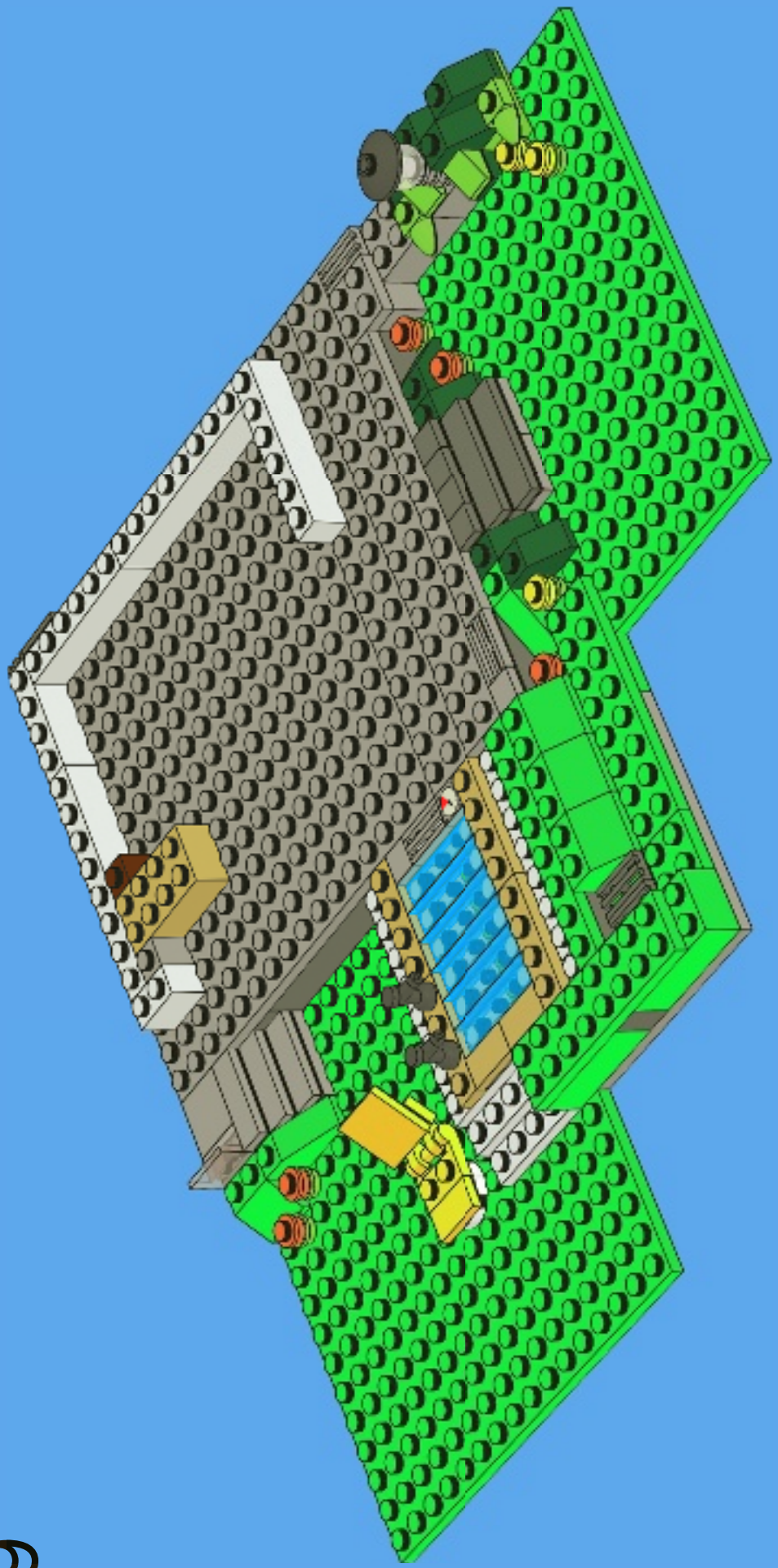

19



-  2x
-  1x
-  2x

20

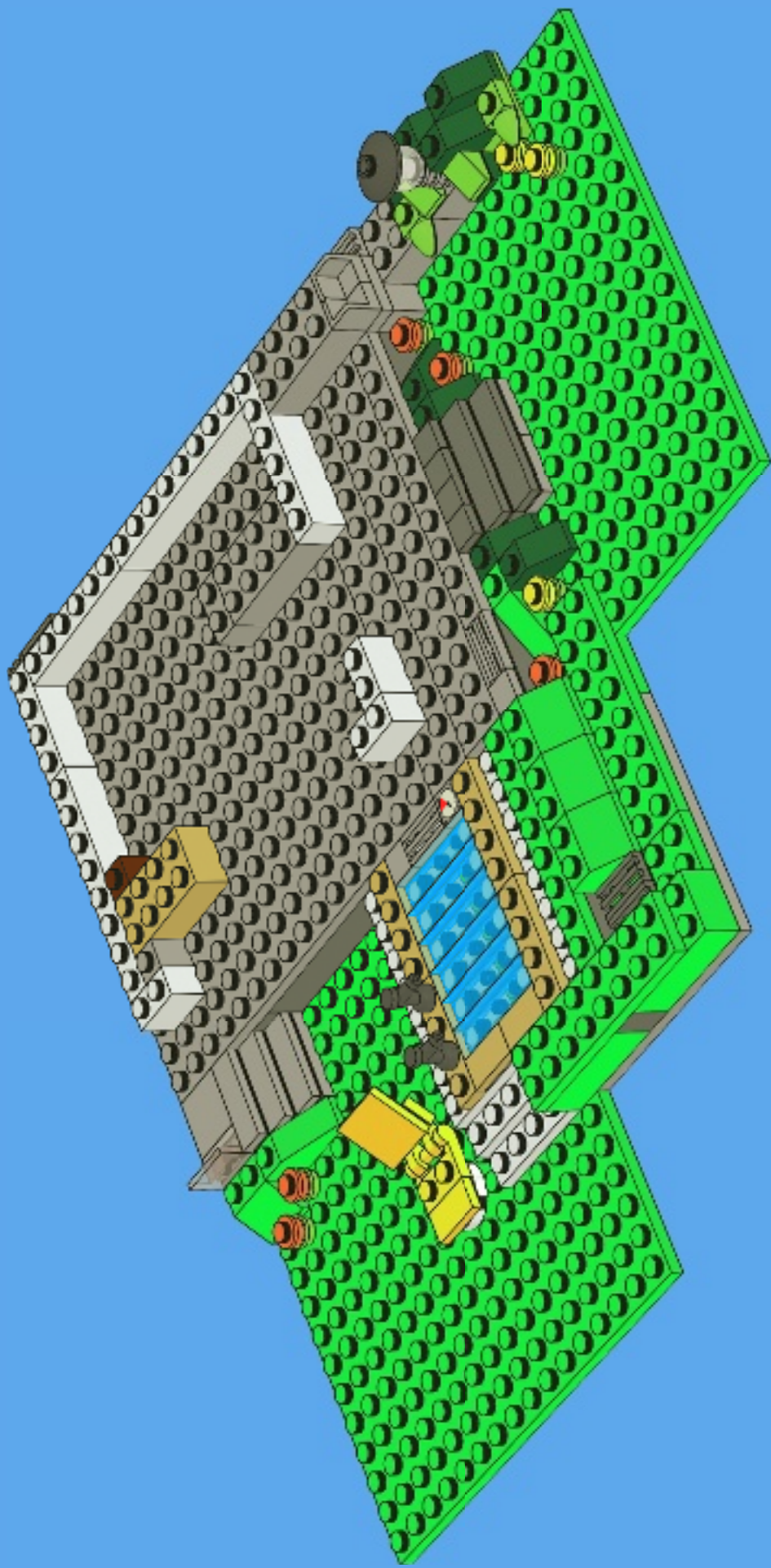

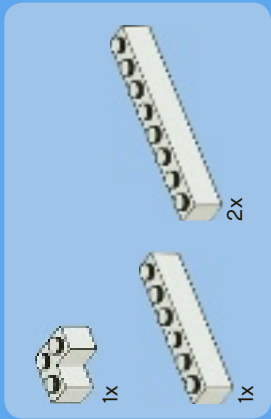

21

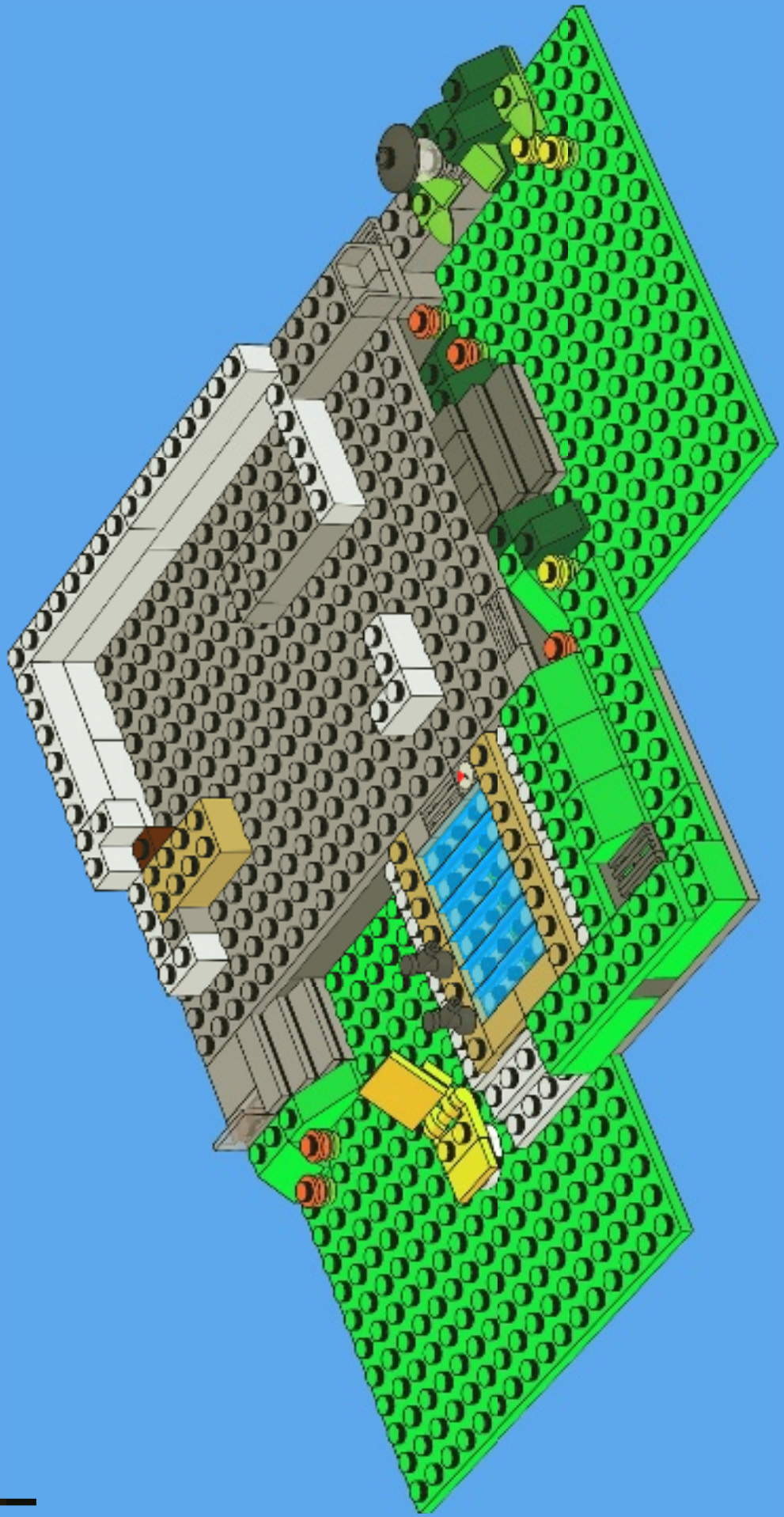

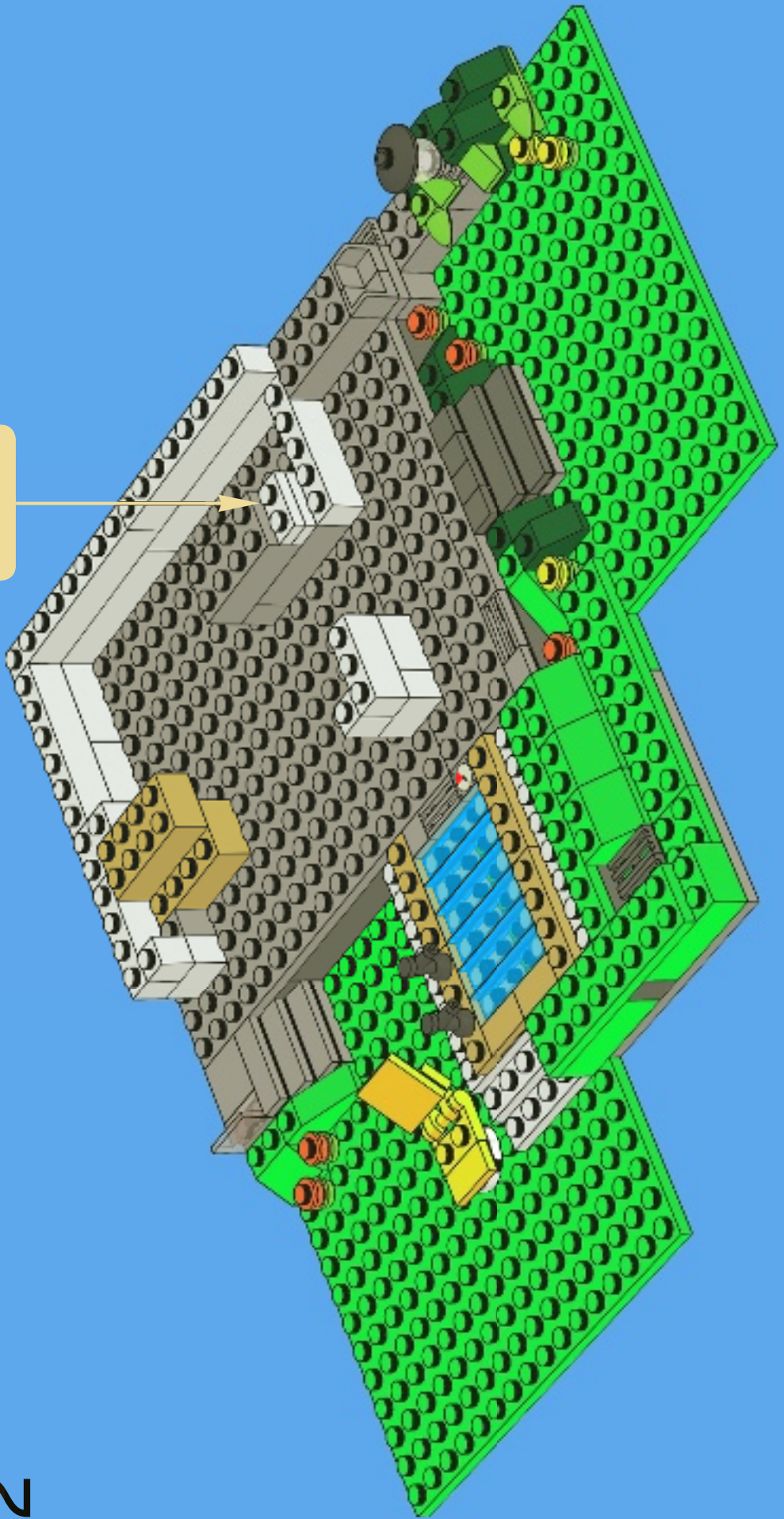
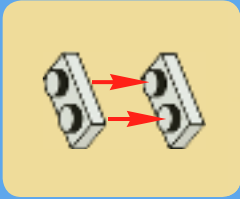

22



23

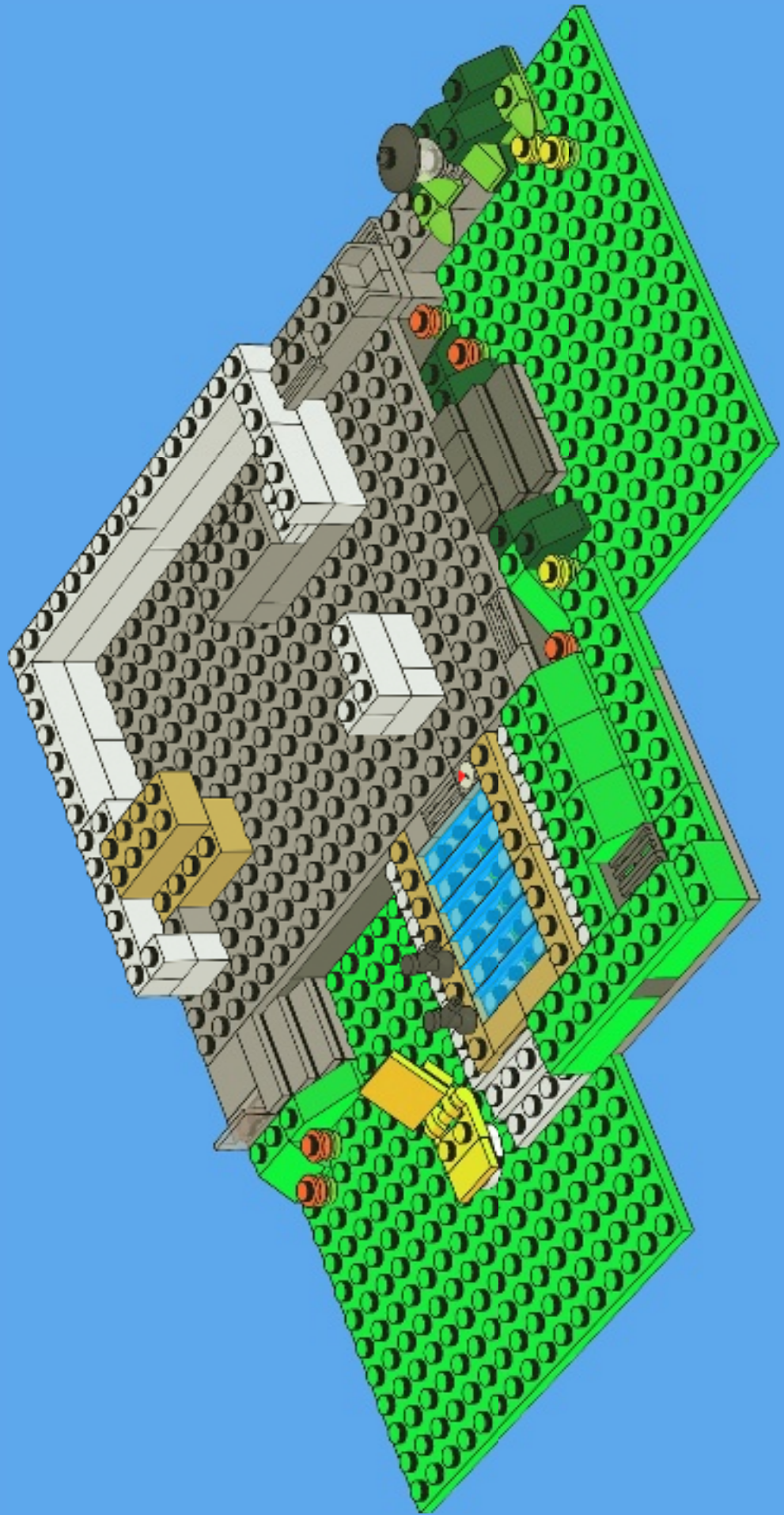

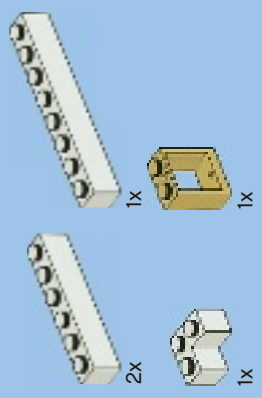
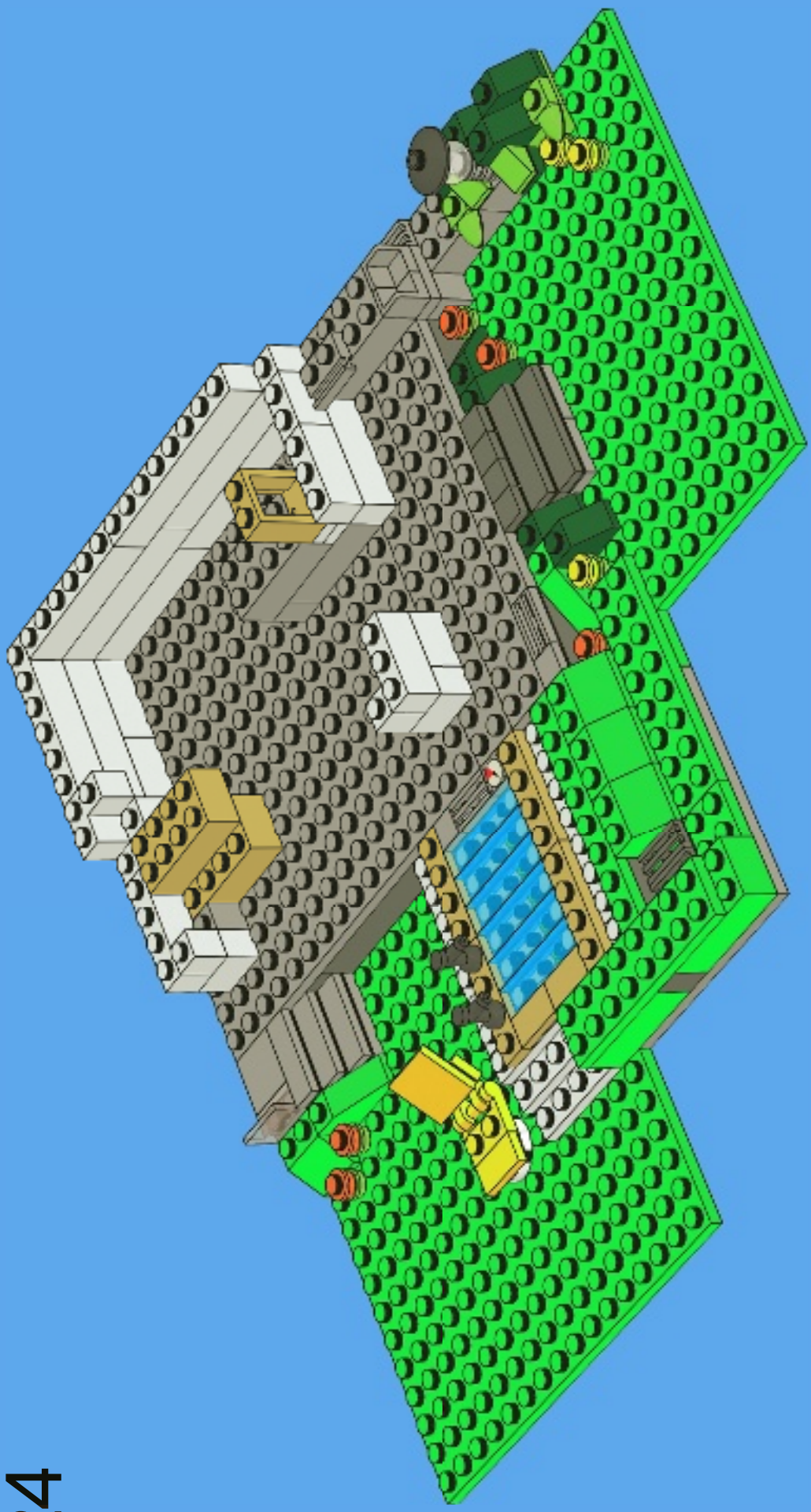

24



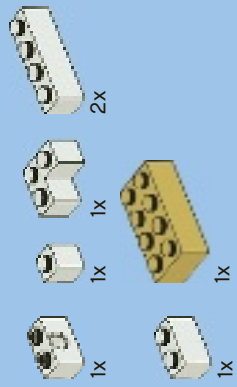

25

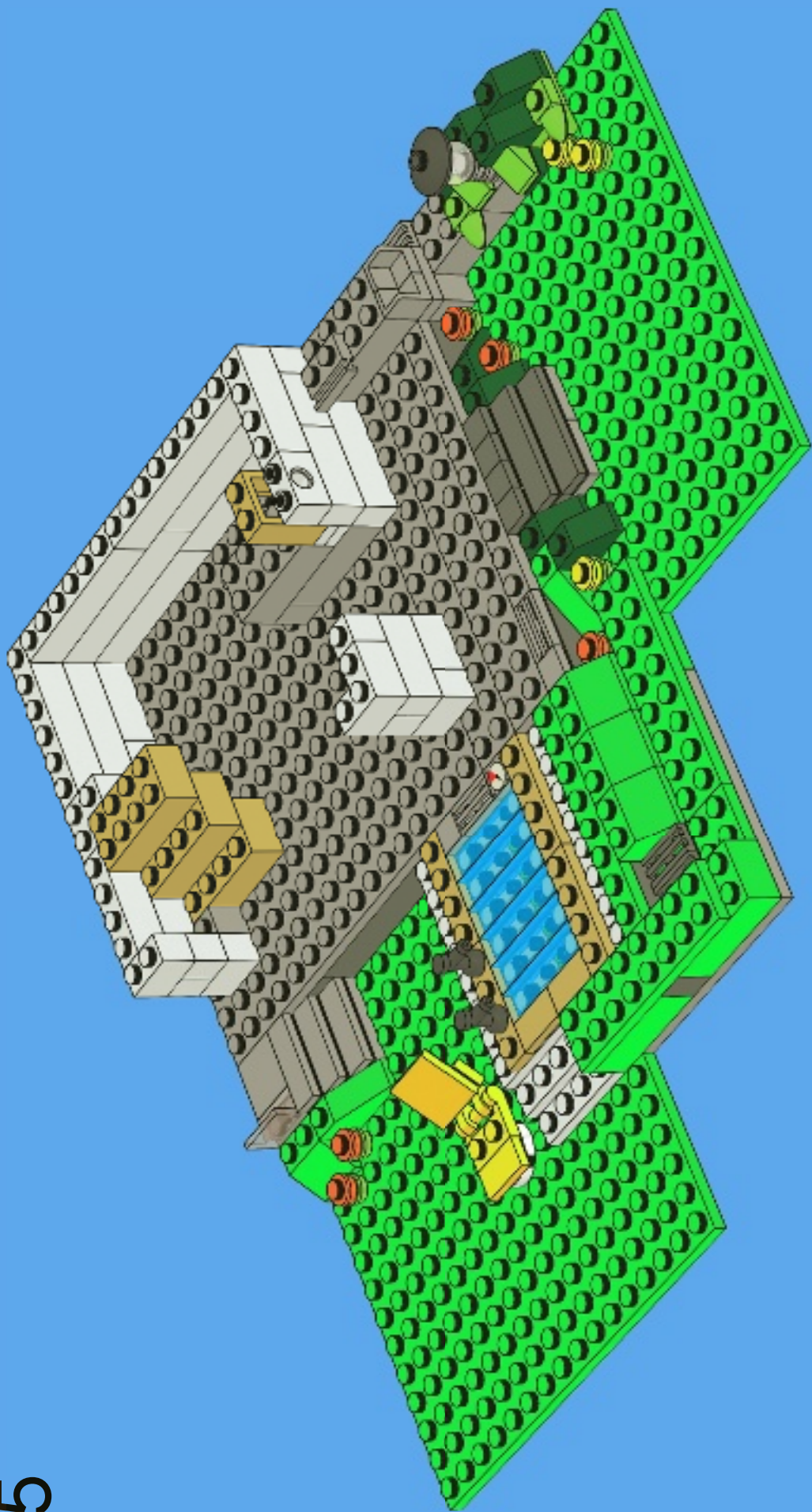

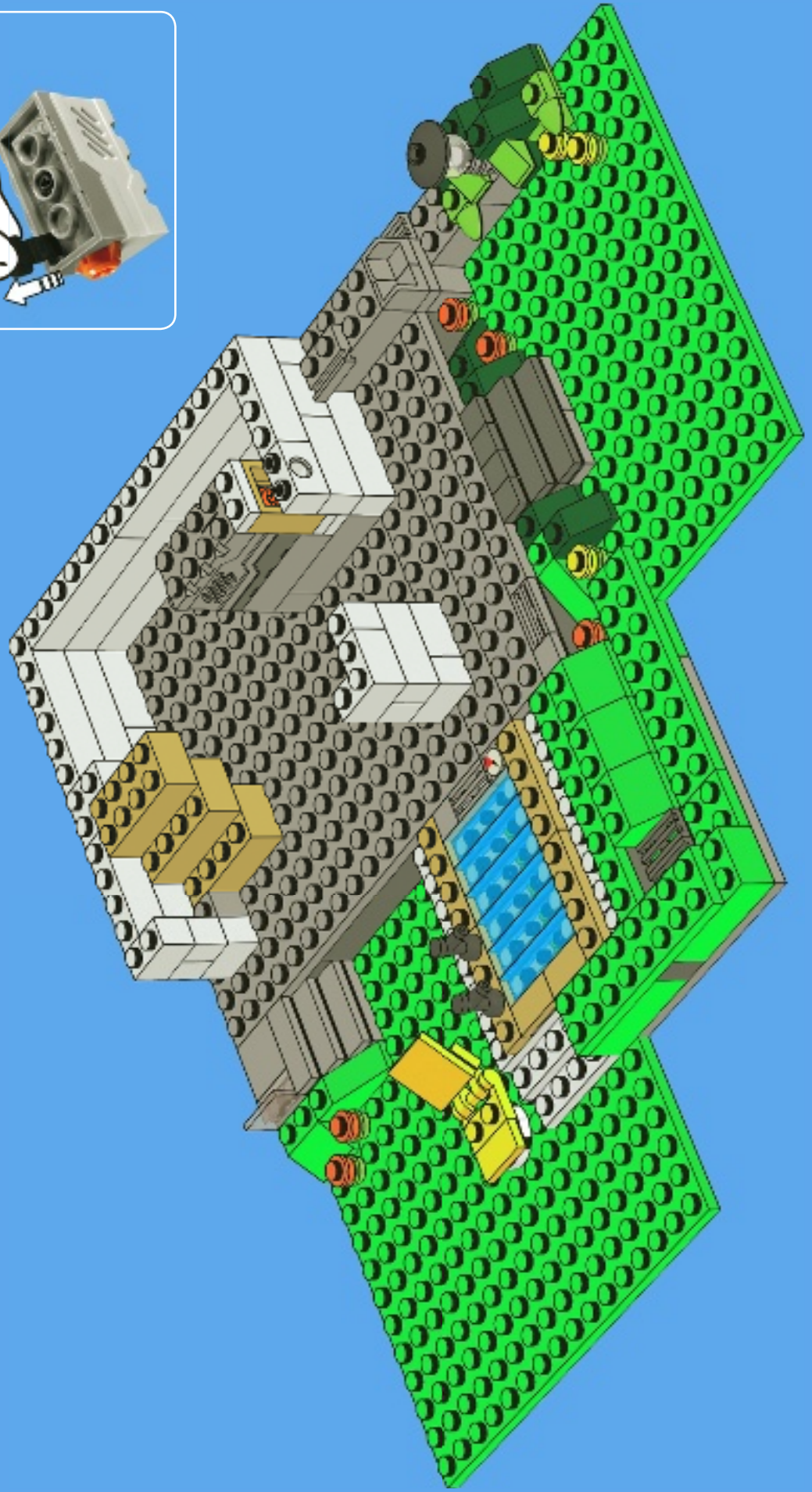
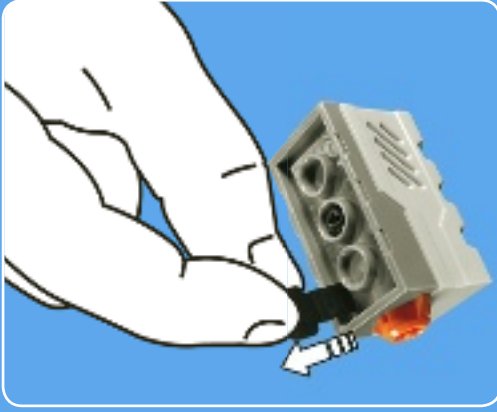

1x



1x

26

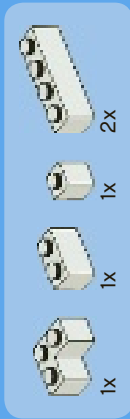

27

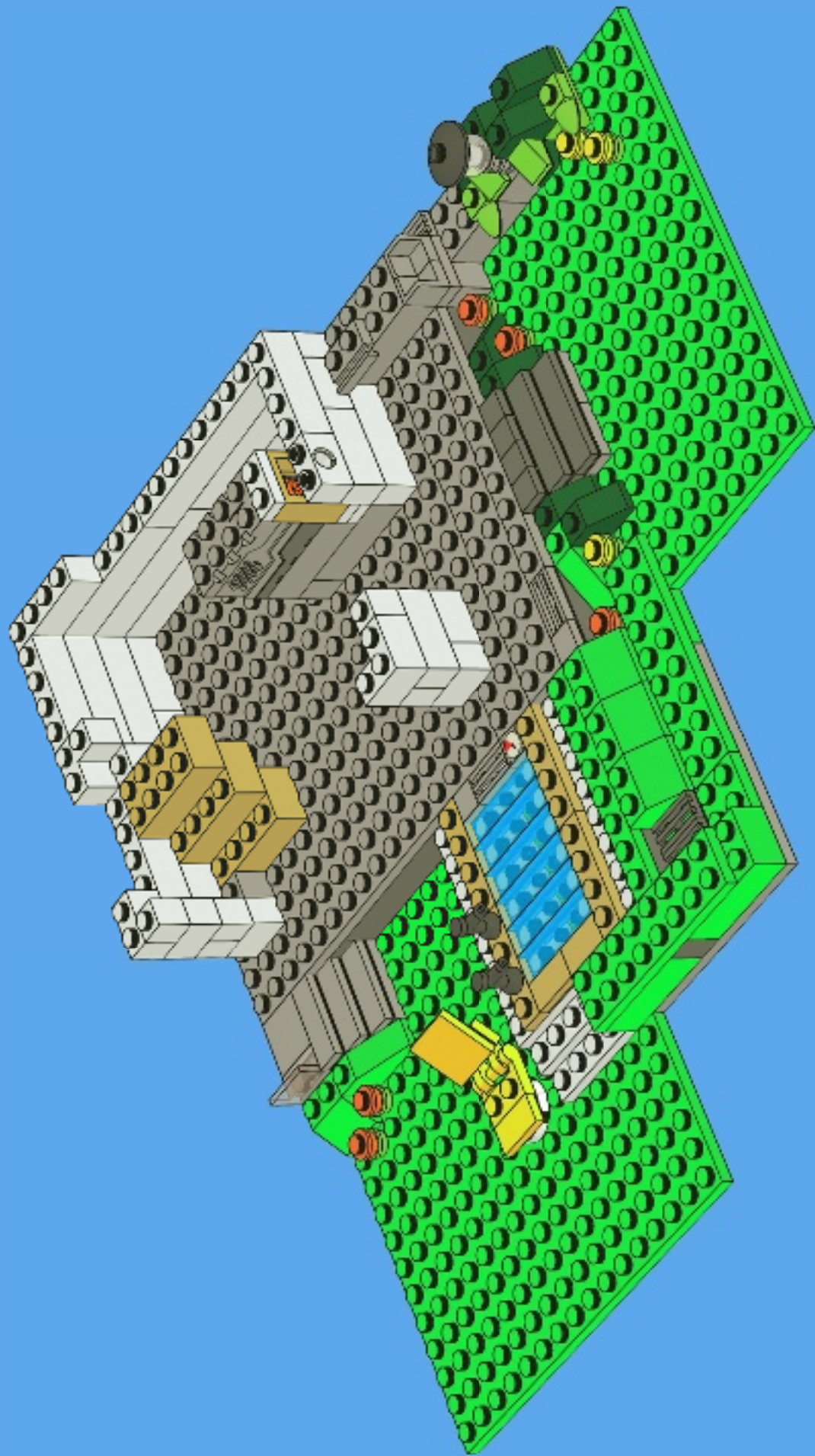

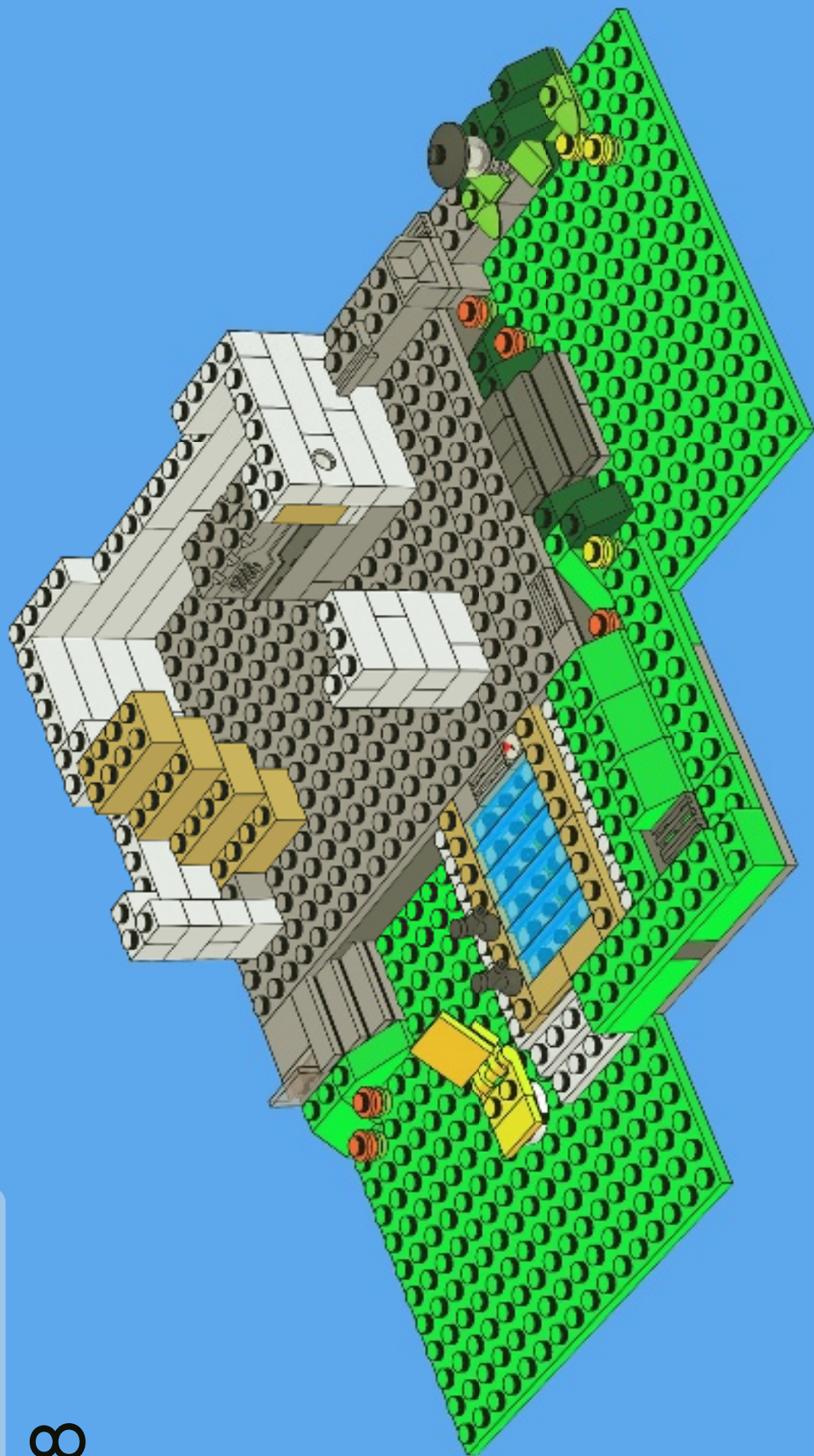

- 
2x
- 
1x
- 
1x
- 
1x
- 
1x

28

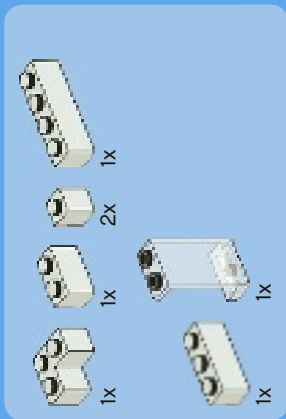
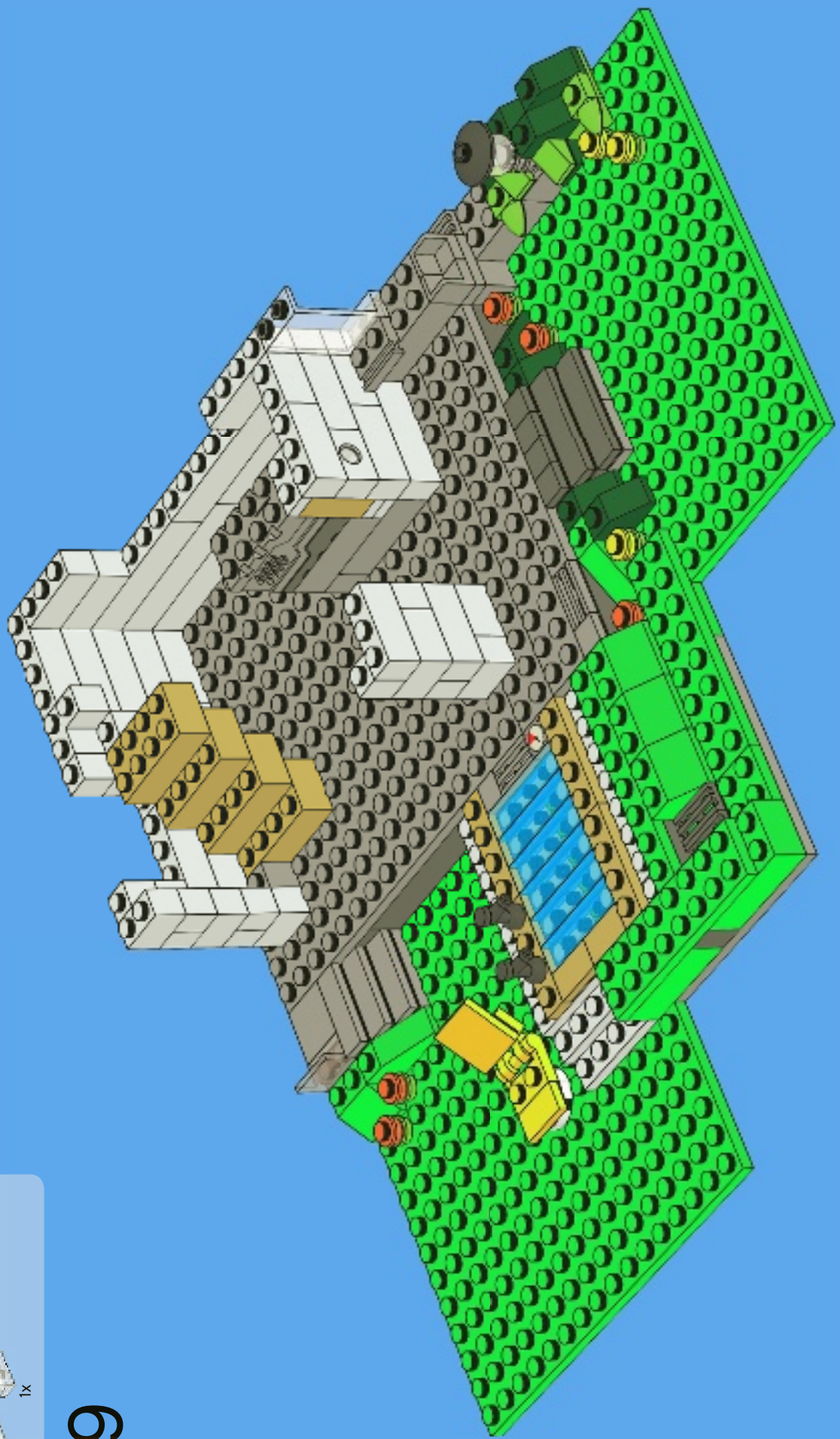

29

-  1x
-  1x
-  1x
-  1x

30

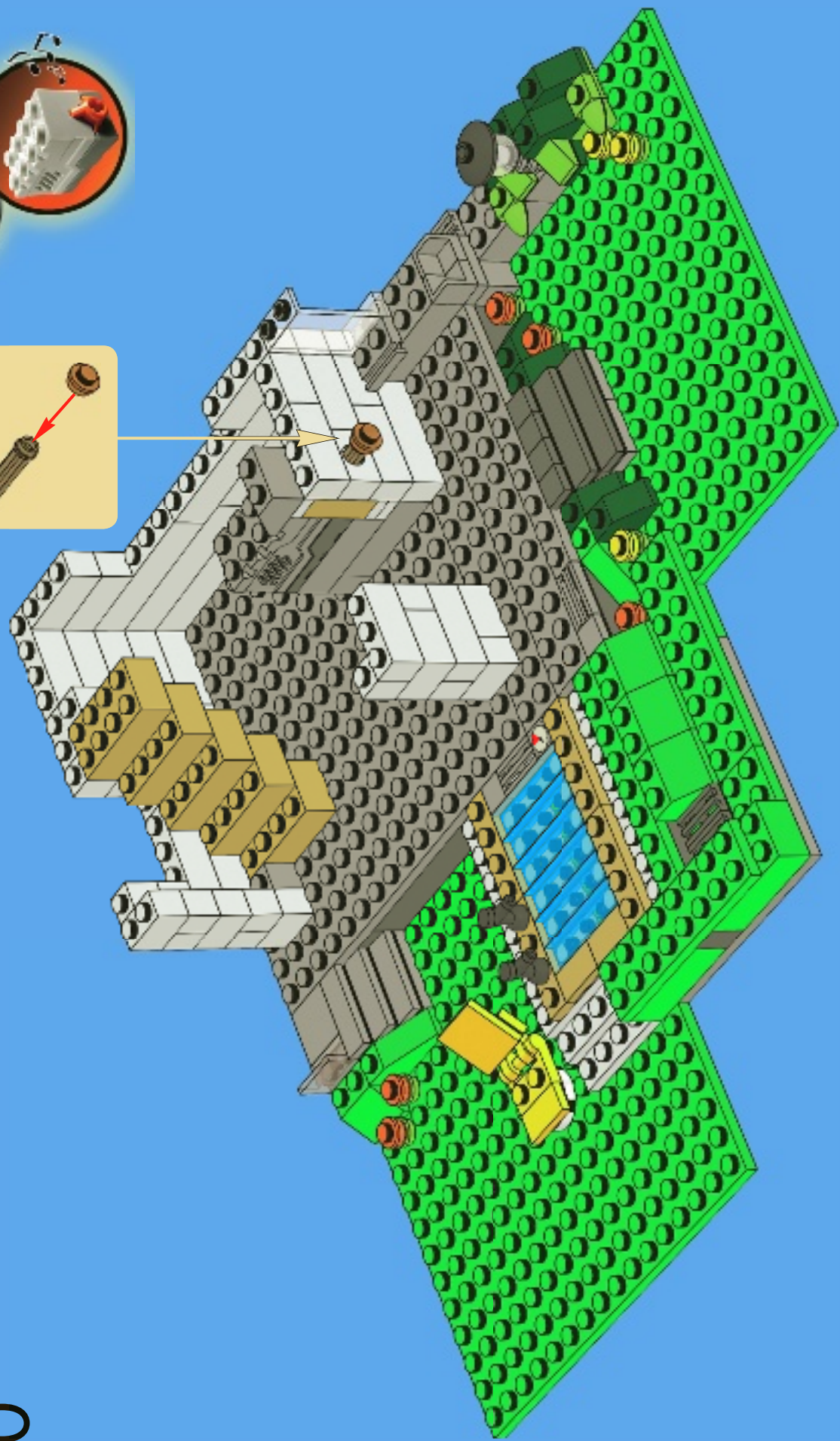

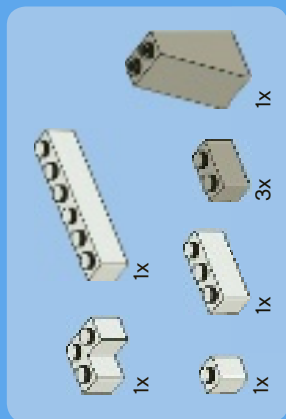
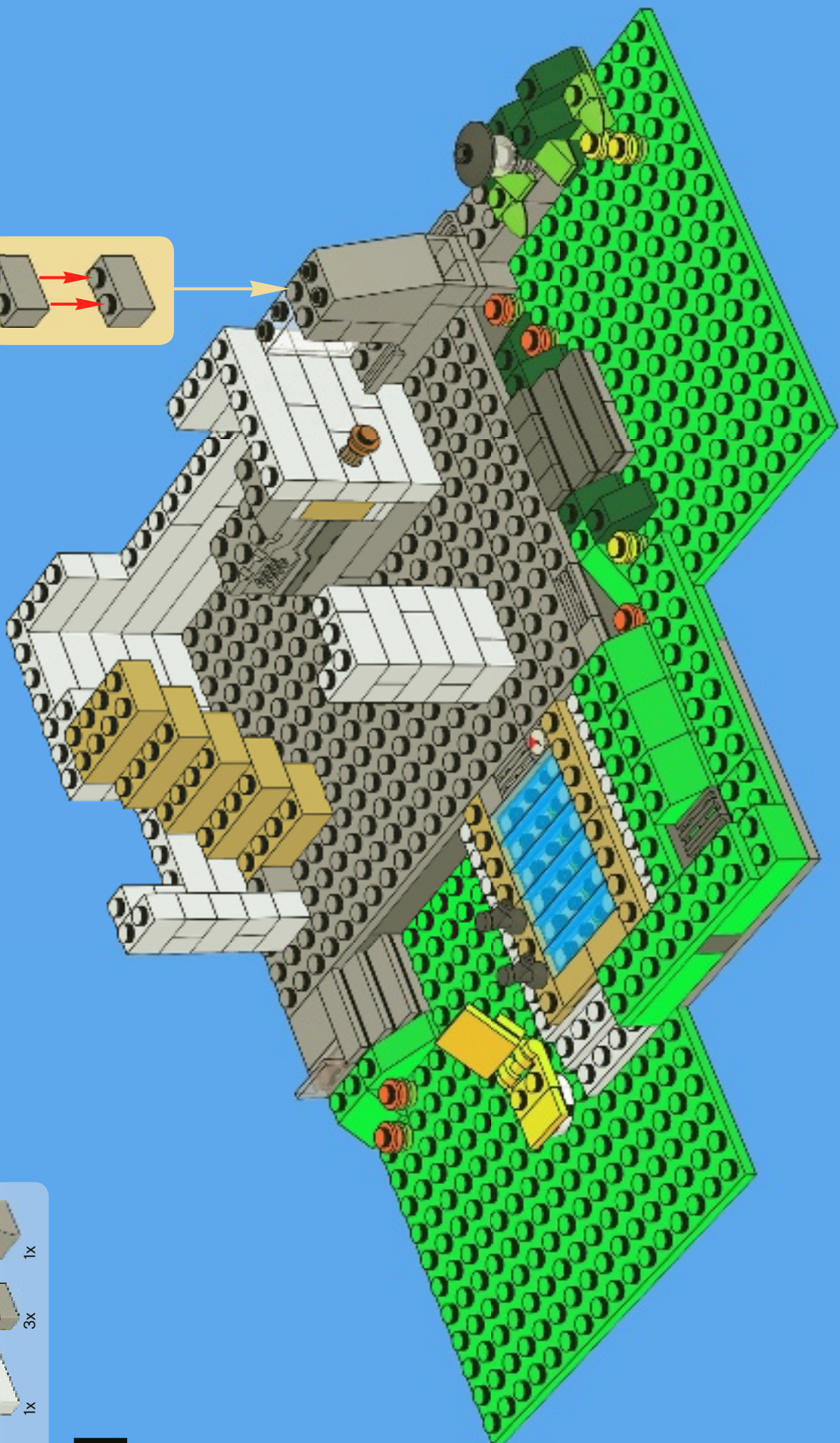
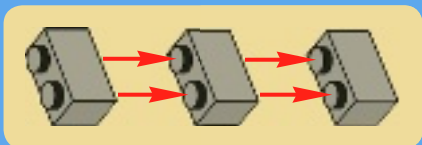

31

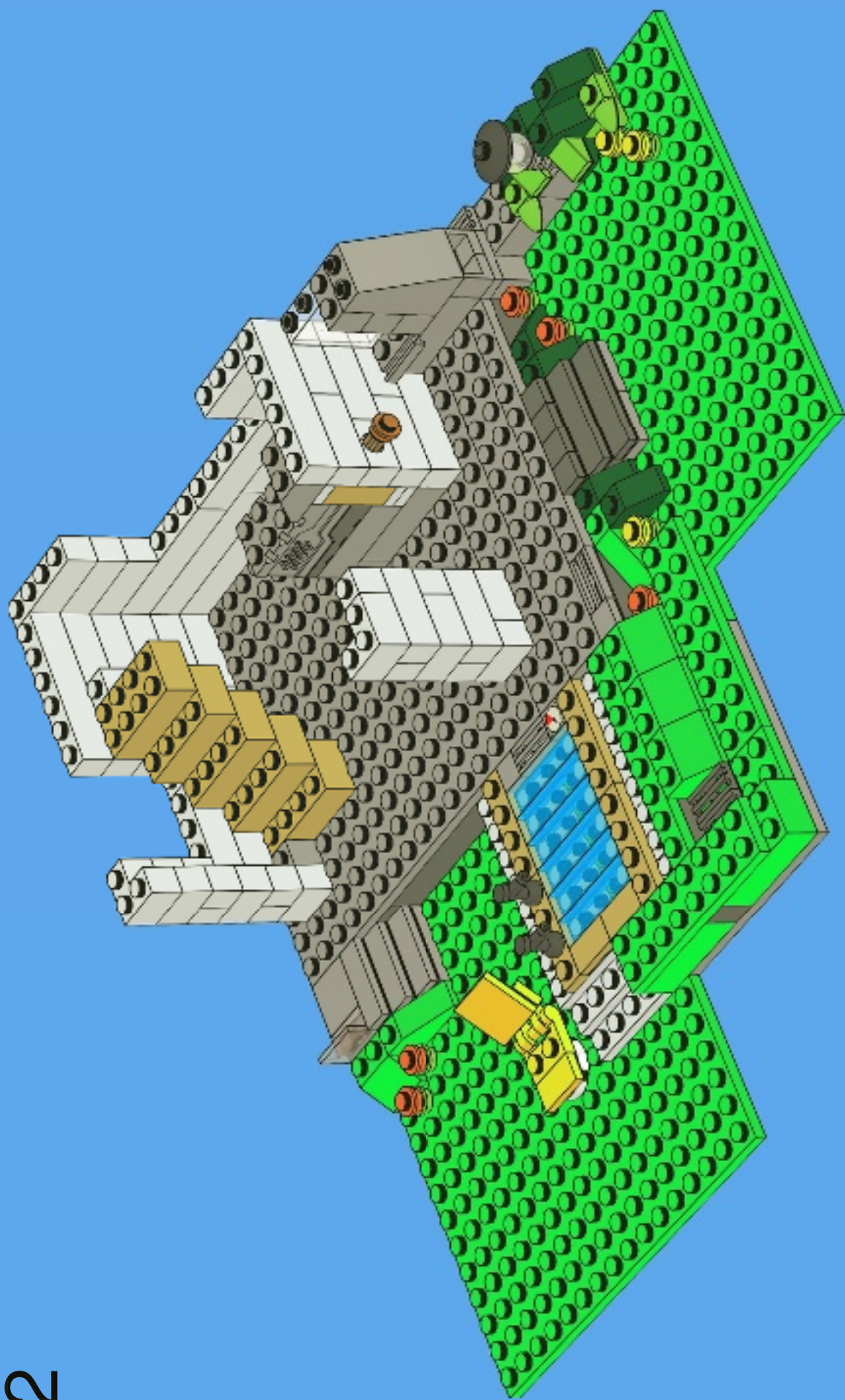

32



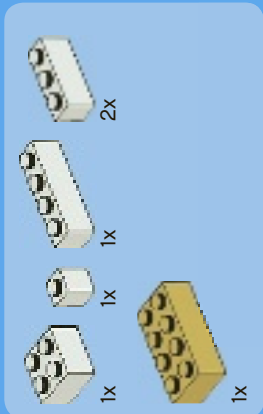
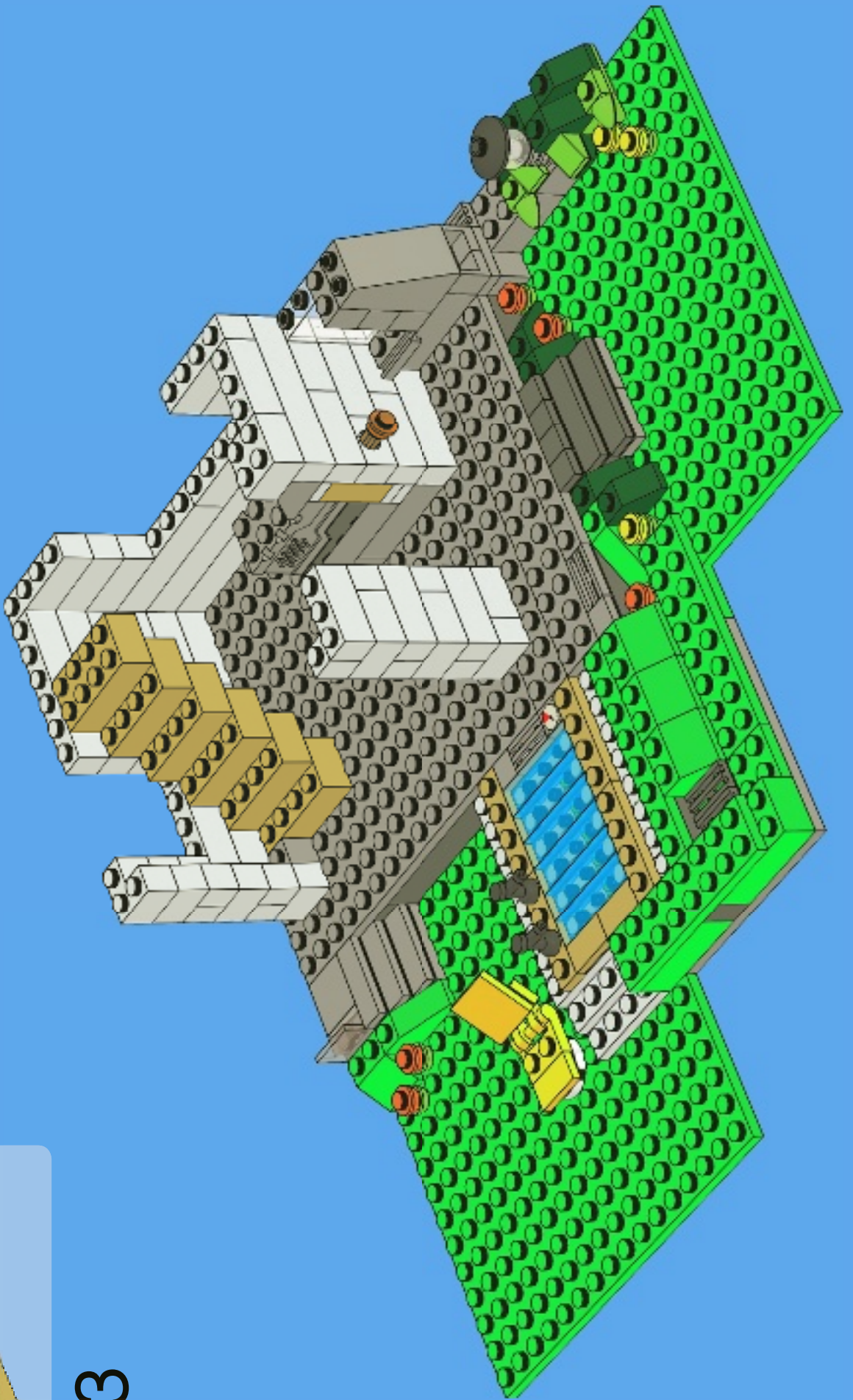

33

34



3x



3x

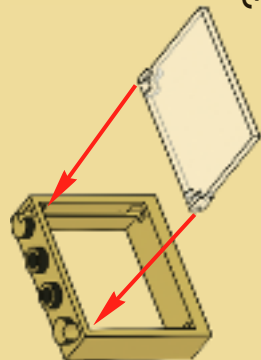

3x





35

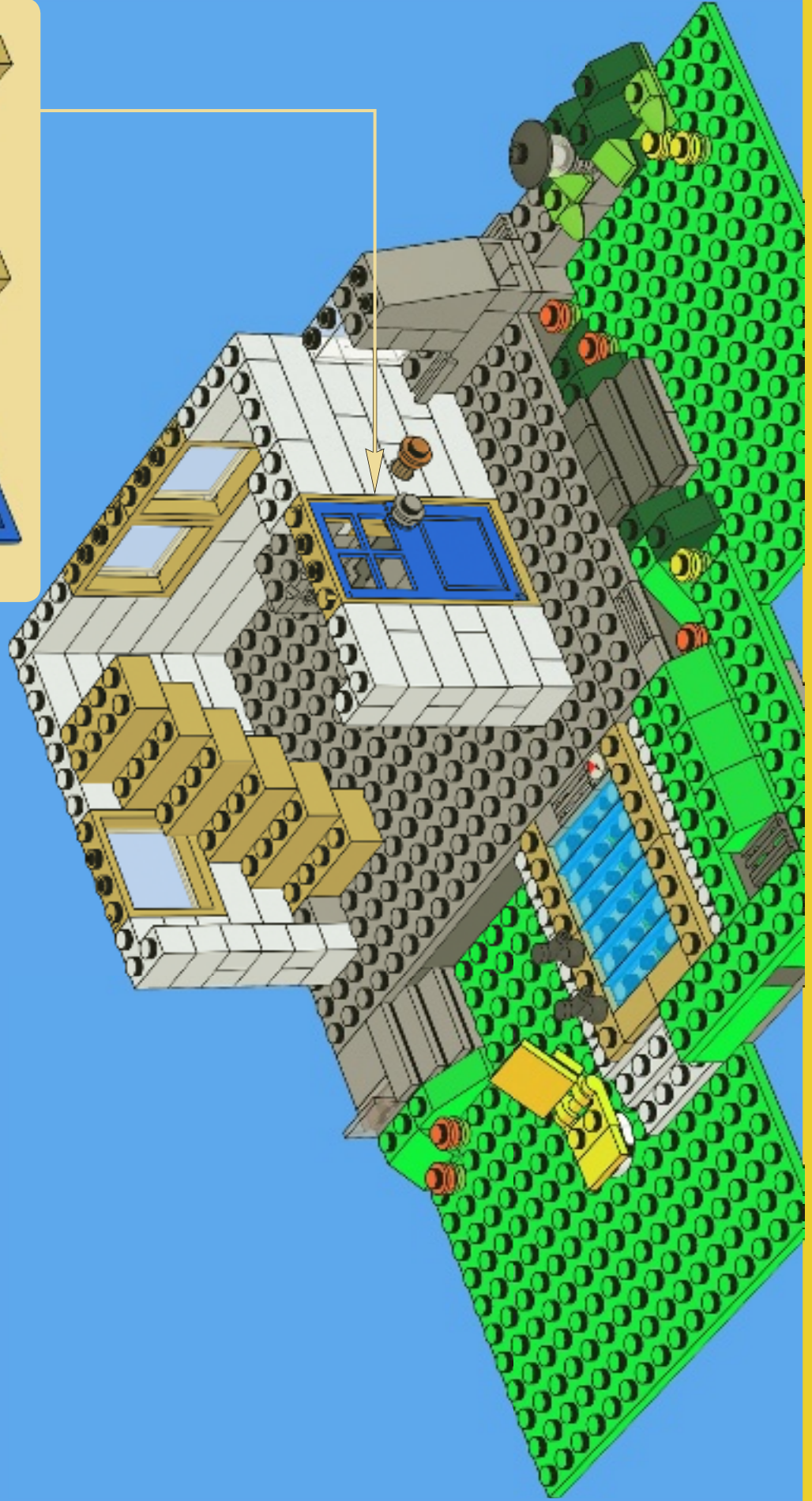
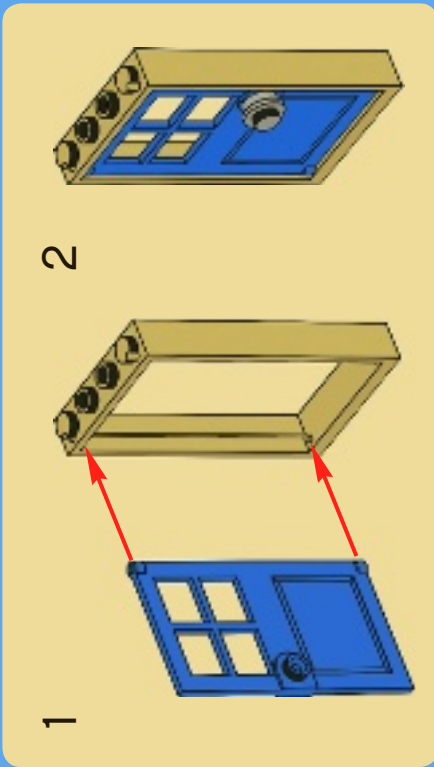

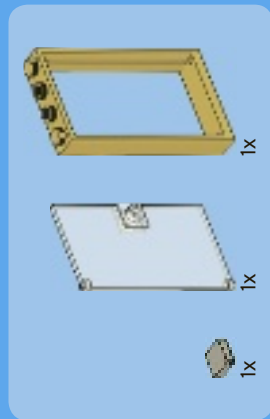
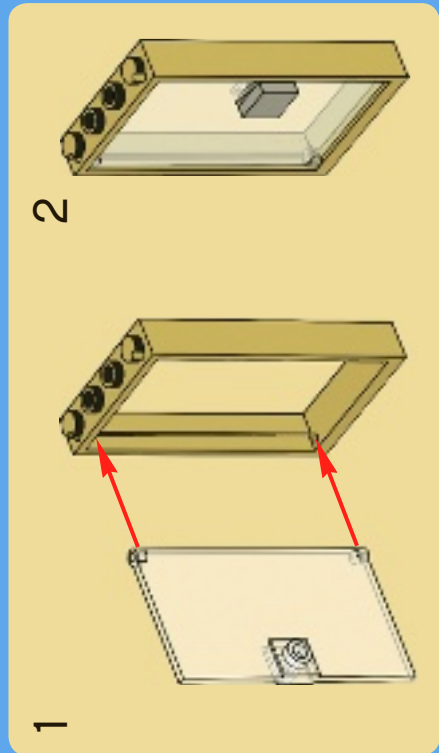
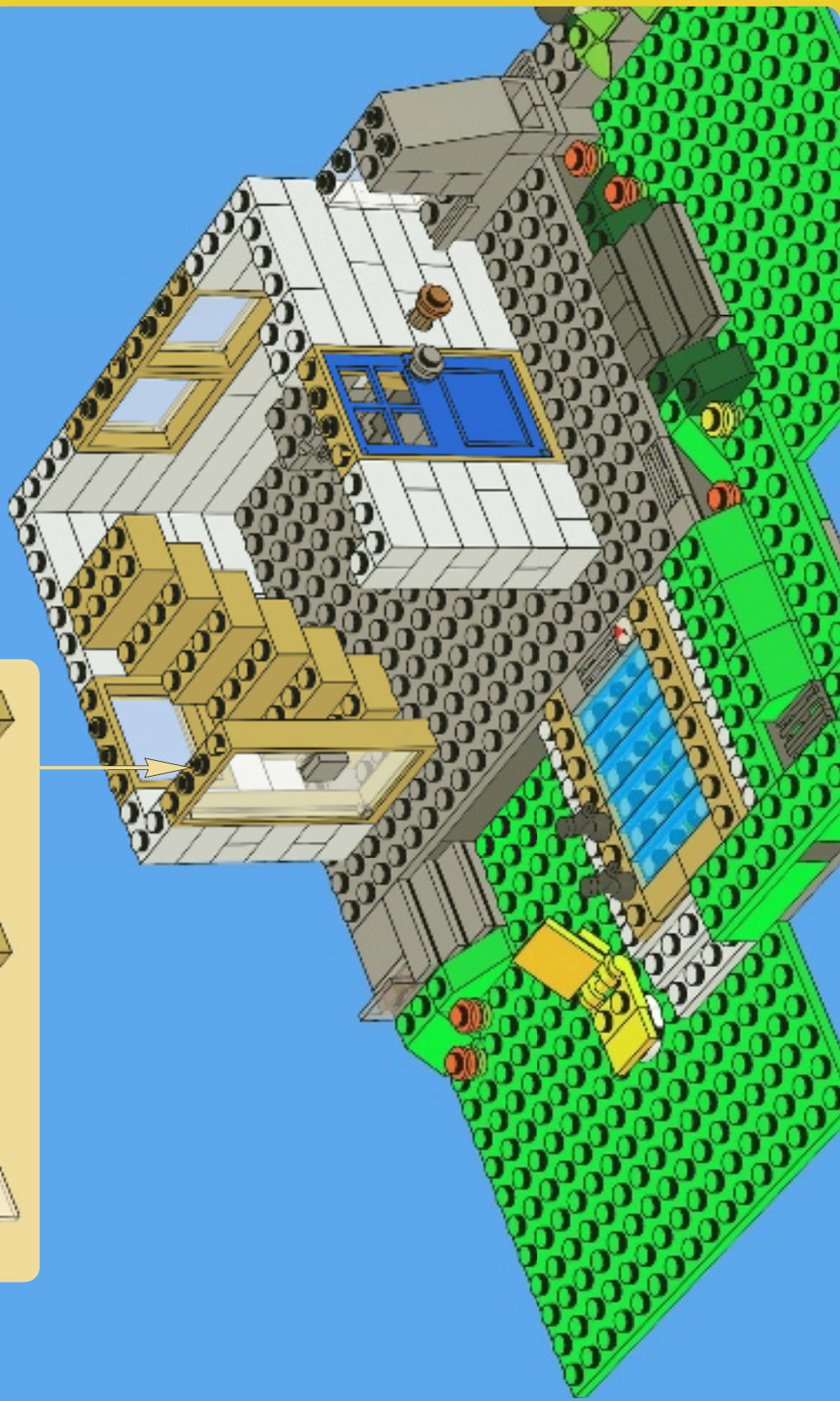

36

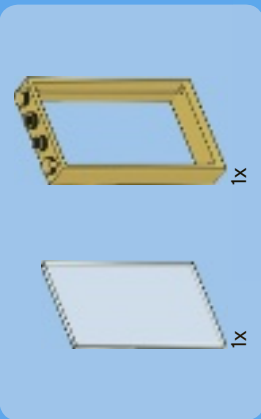
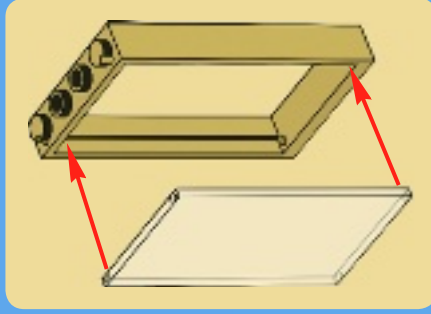
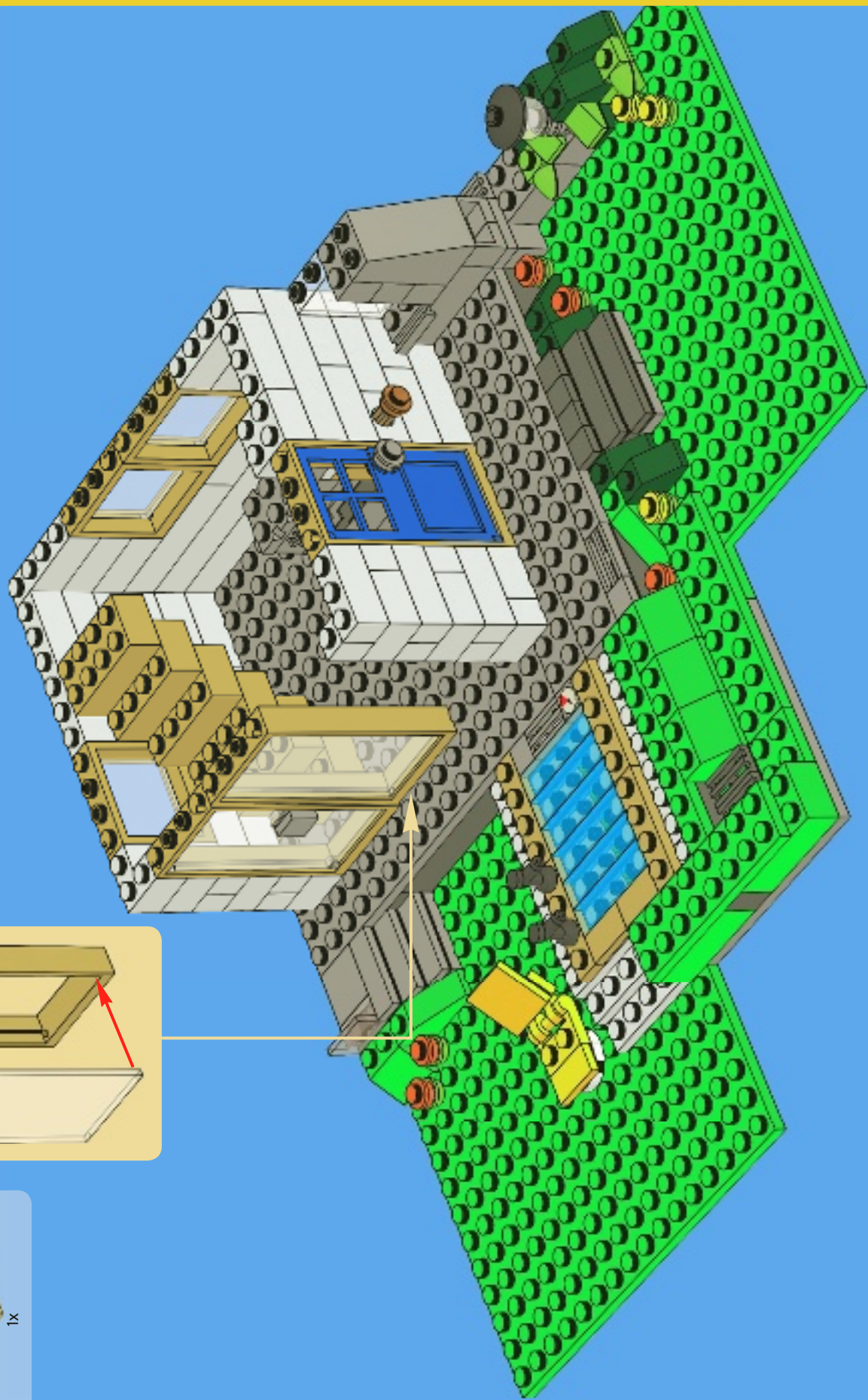

37



38

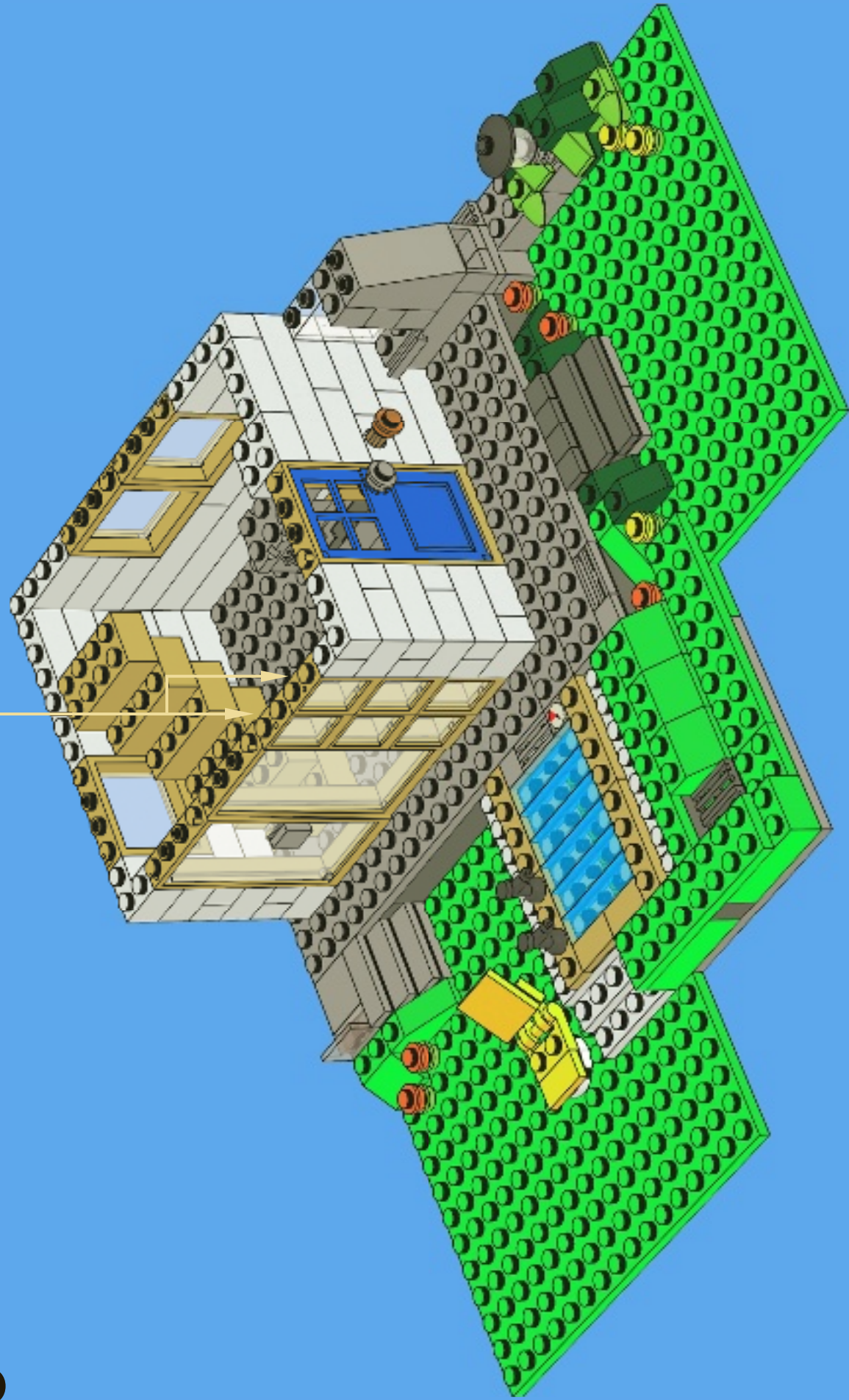
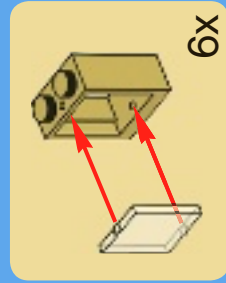

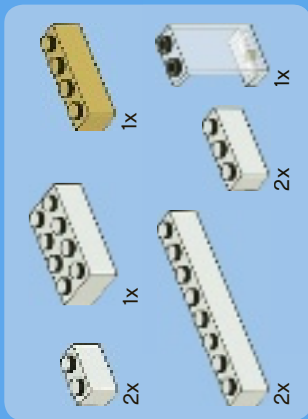

# 39

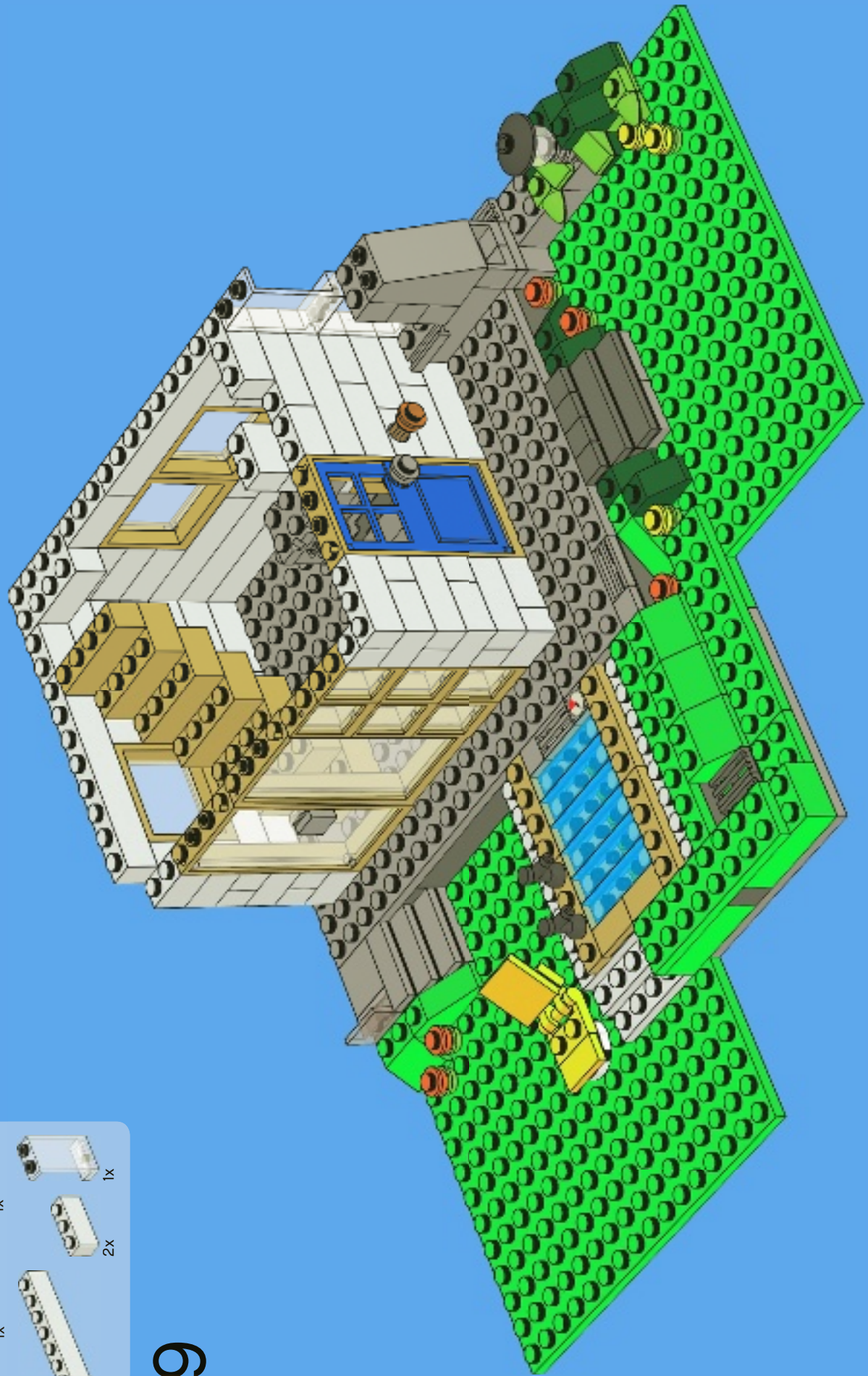

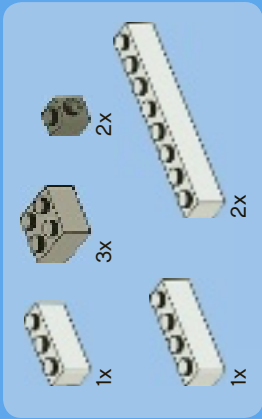
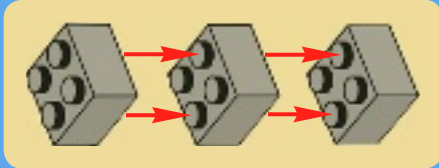





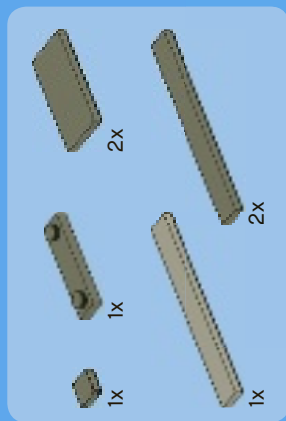
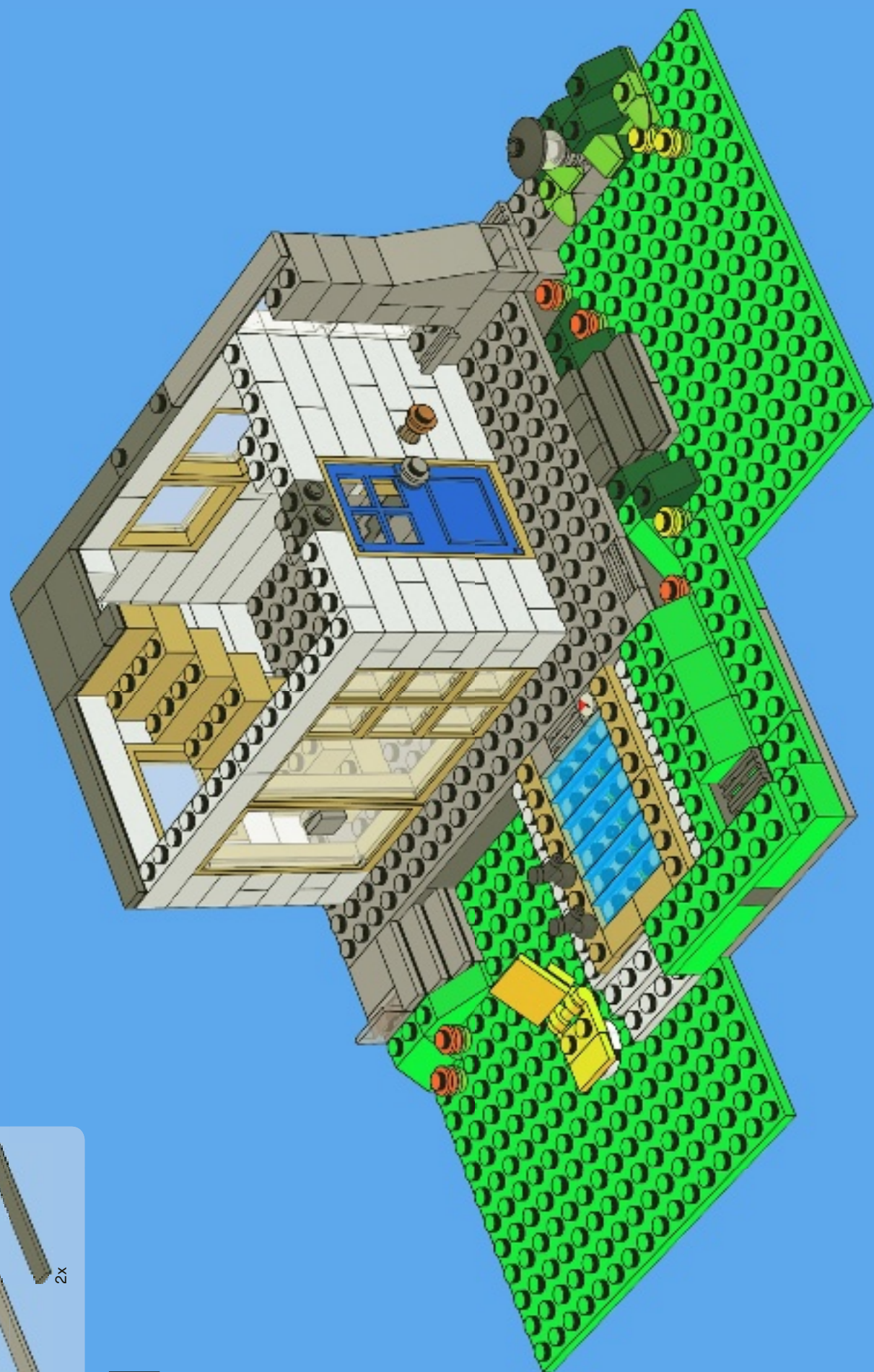

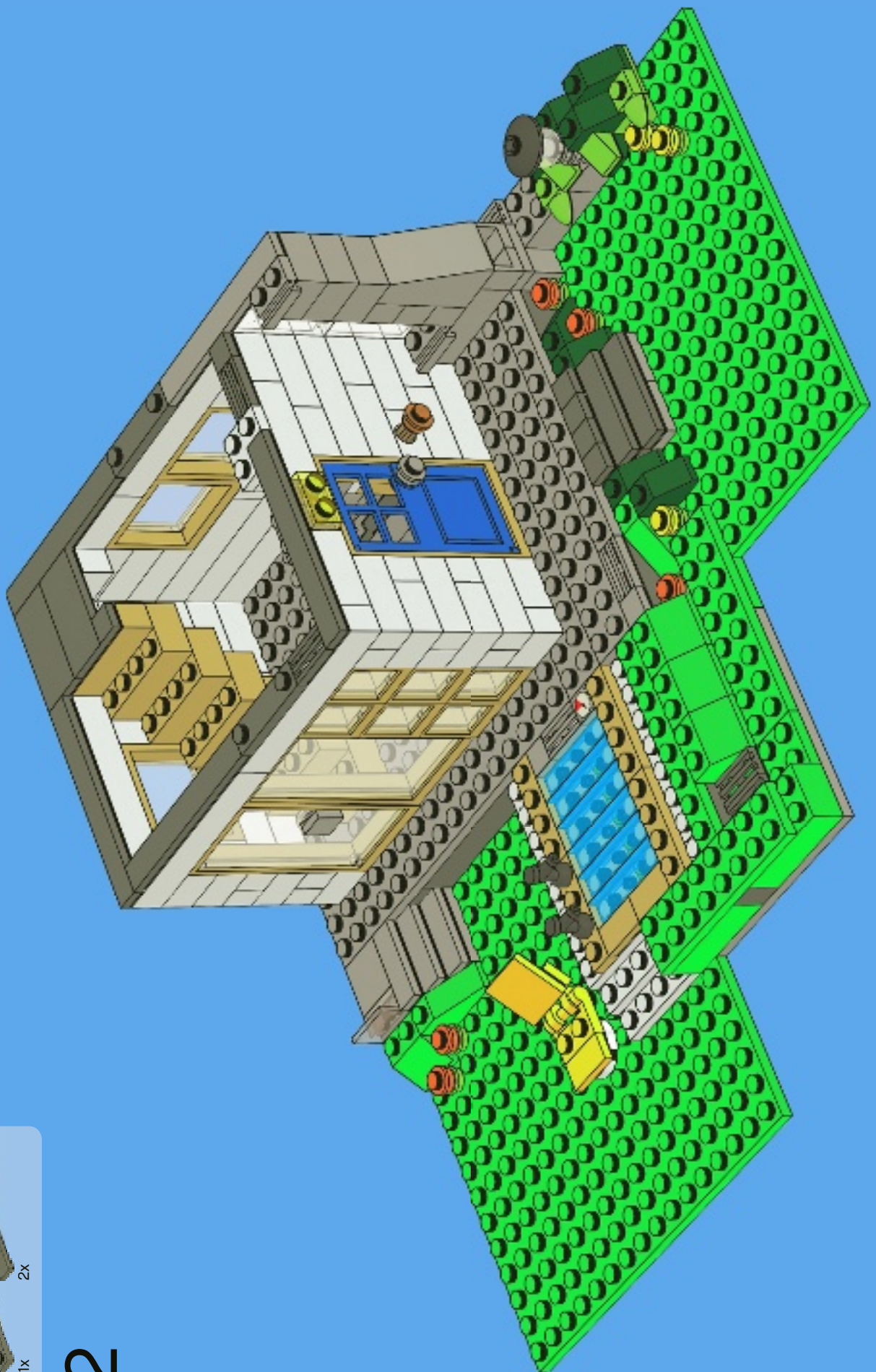

40





41



-  1x
-  1x
-  1x
-  2x
-  2x
-  1x
-  1x
-  1x

42



2x

1

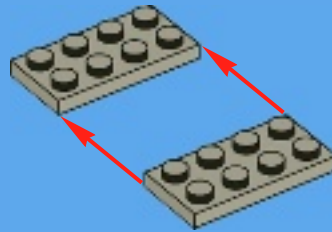

1x



1x

2

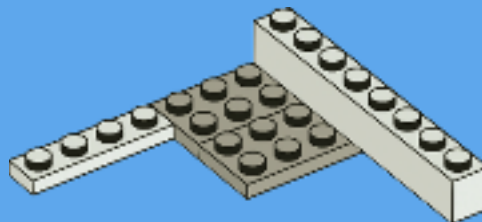



1x

3

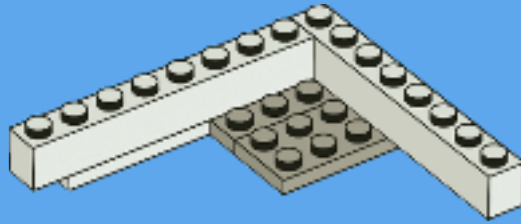

1x

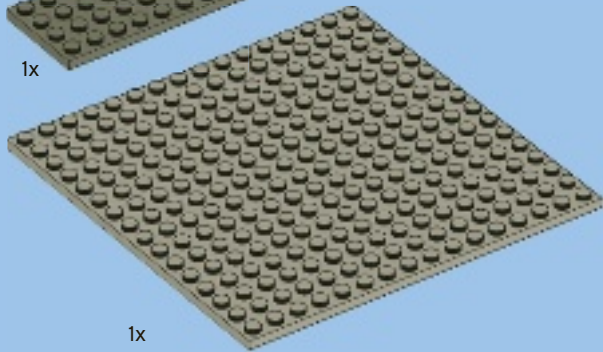

1x

4

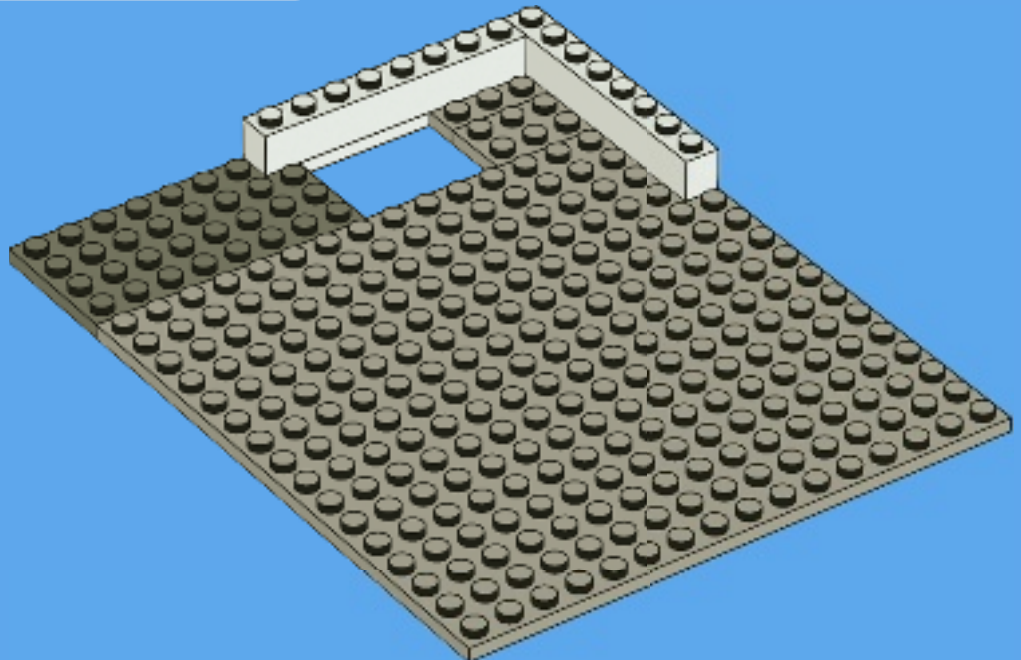

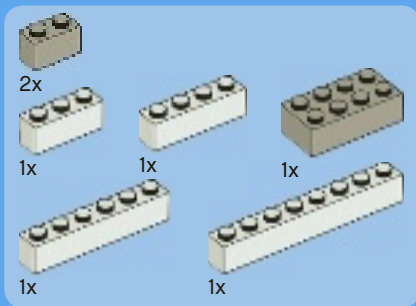

5

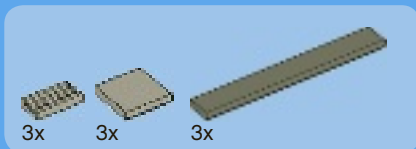
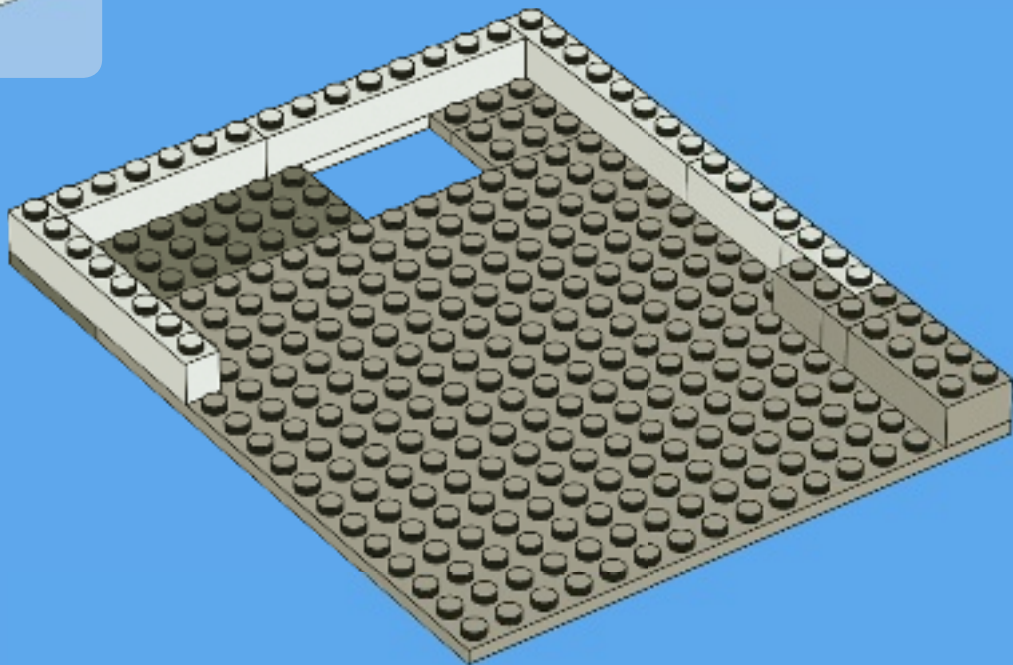

6

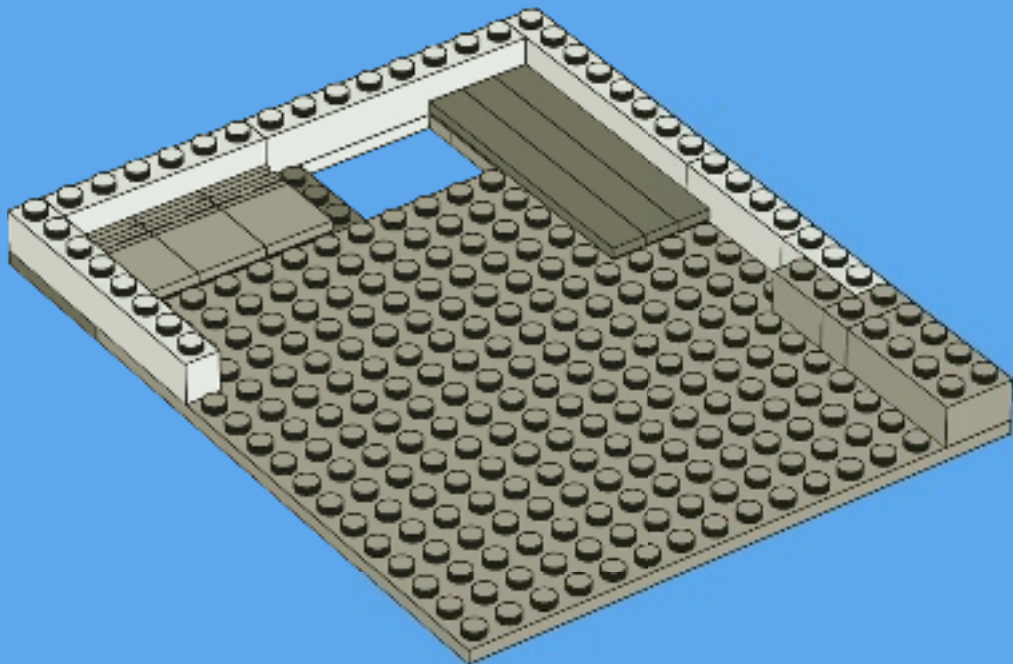

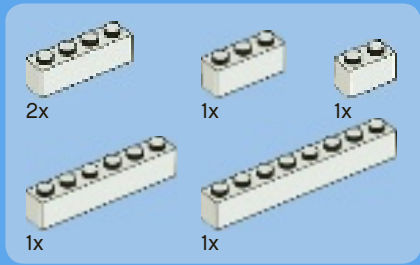

7

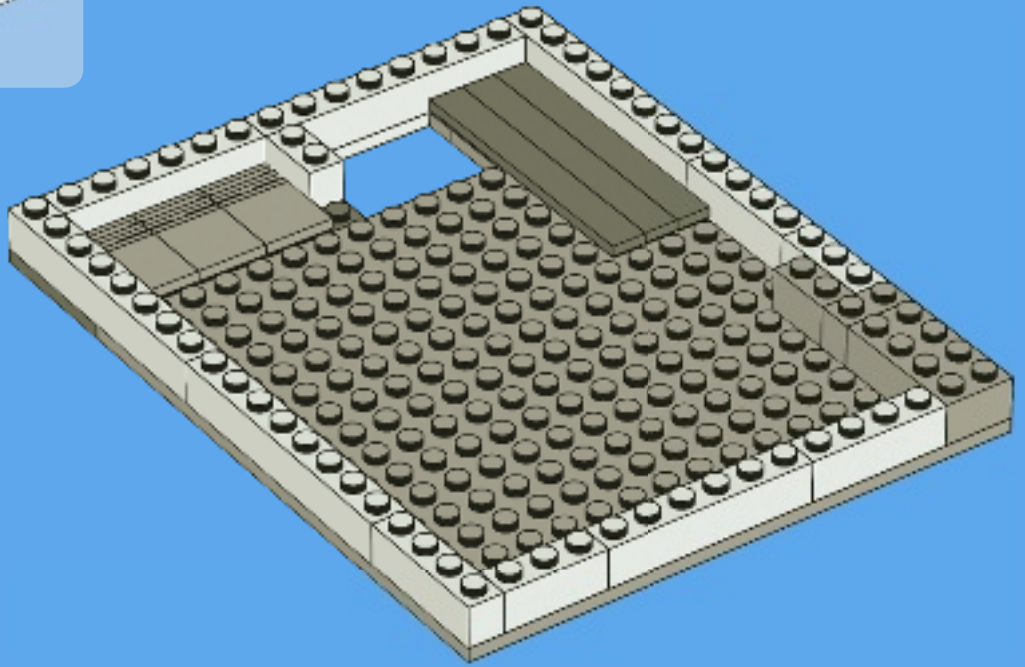

8

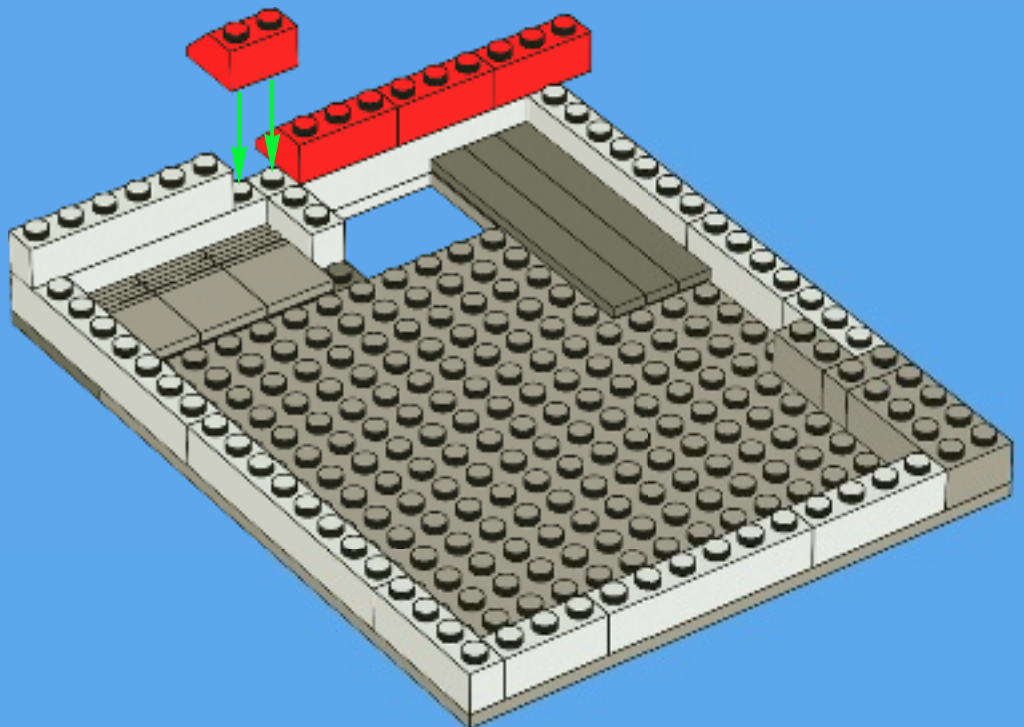

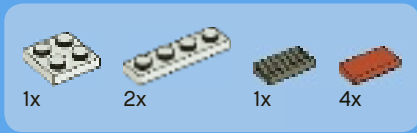

9

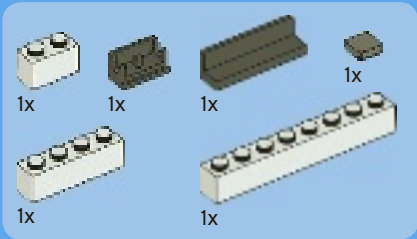
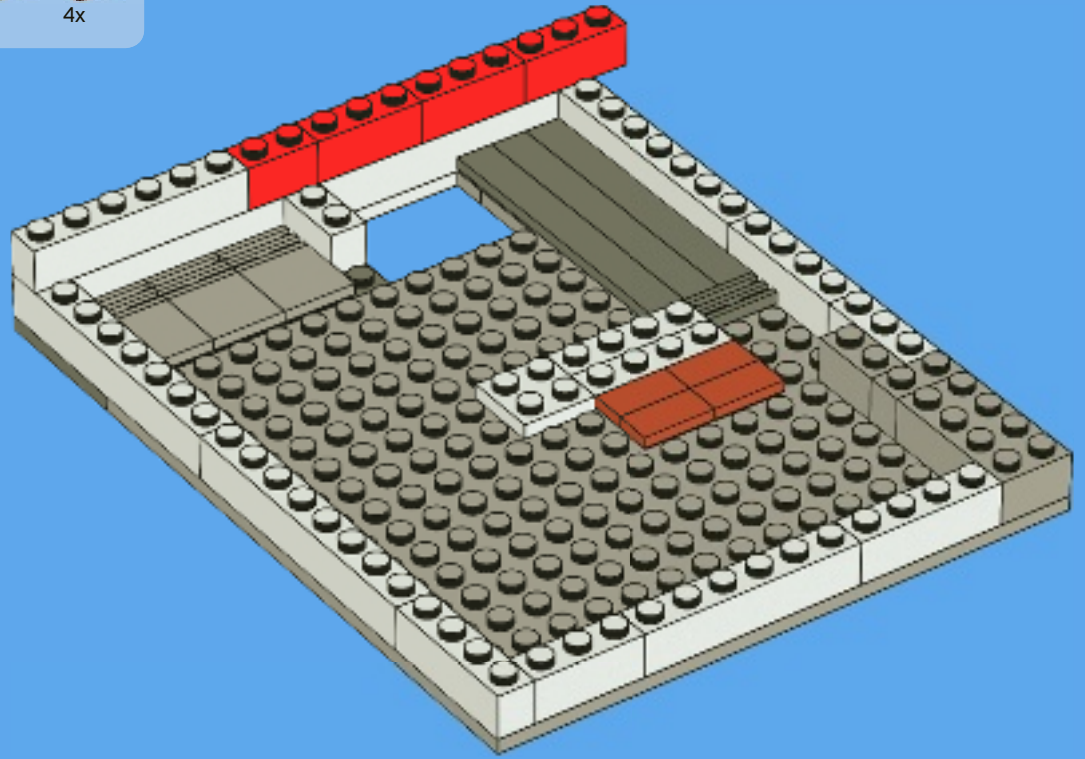

10

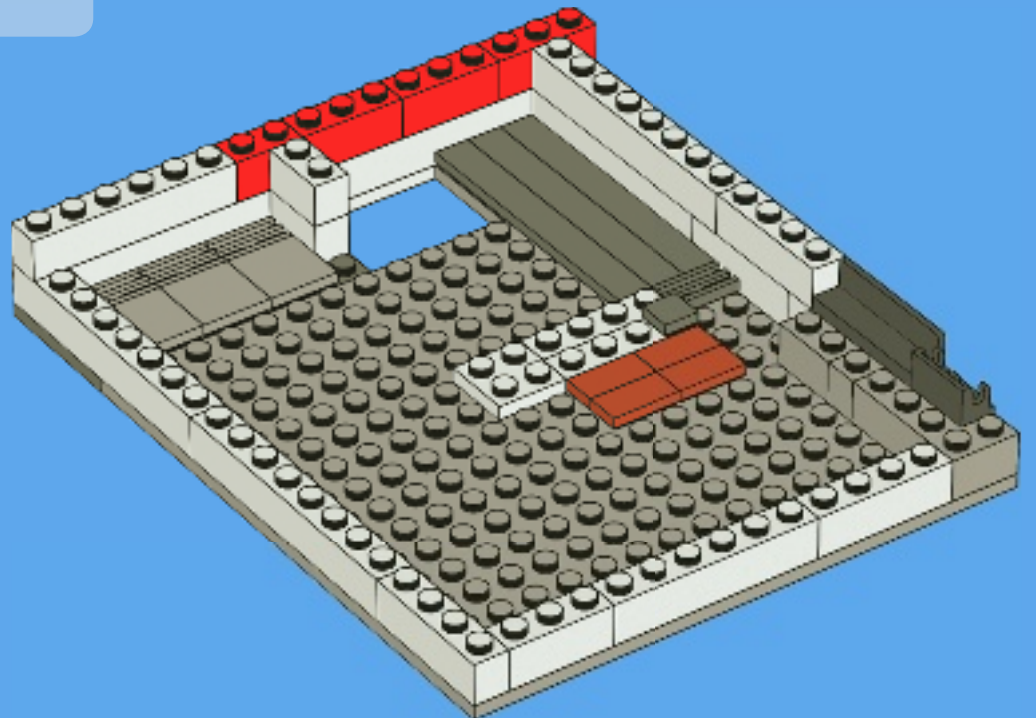

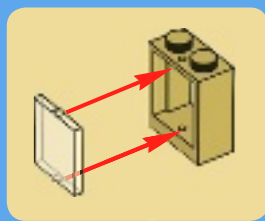

11

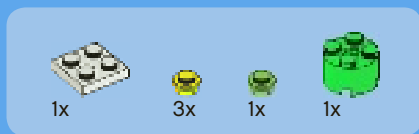
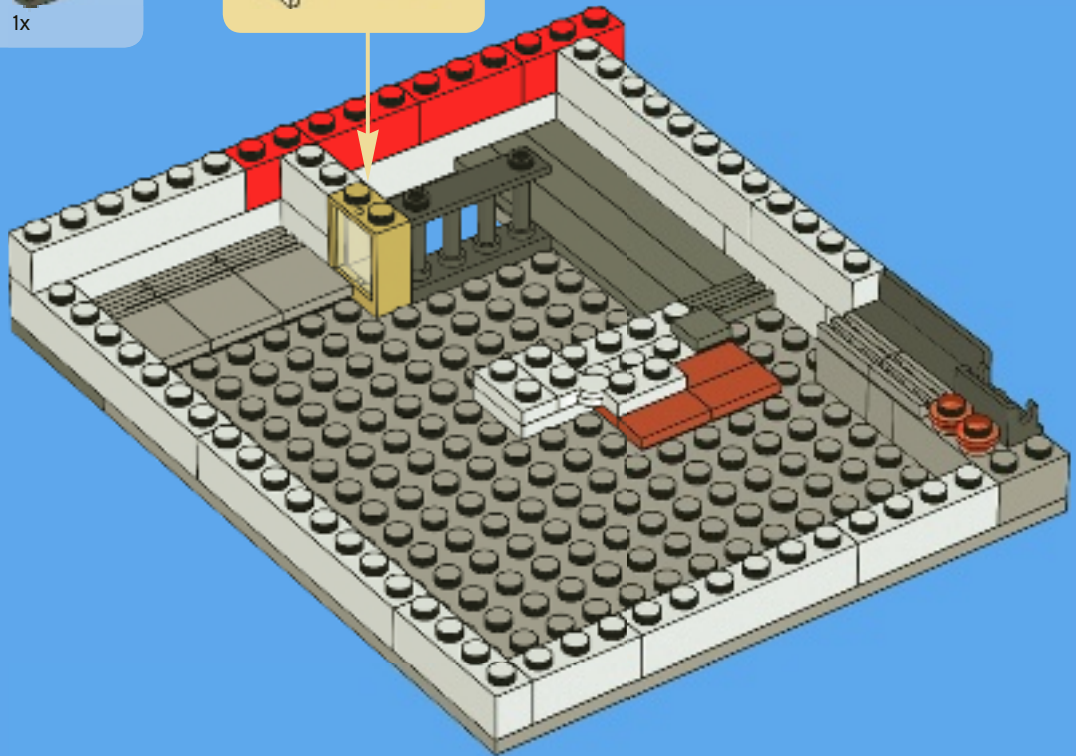

12

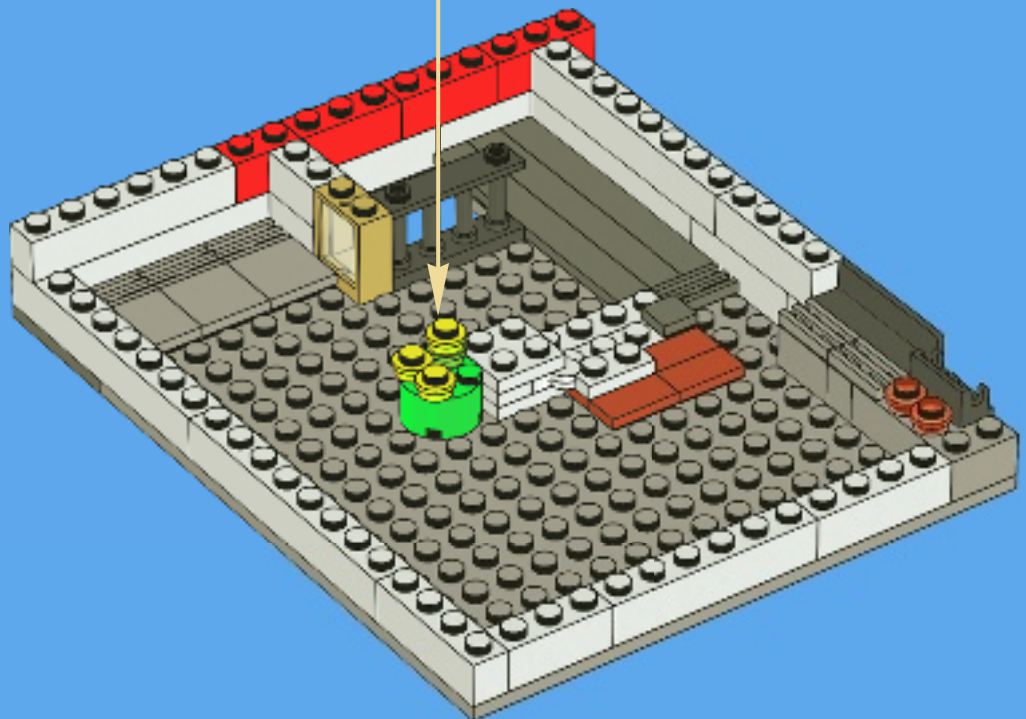



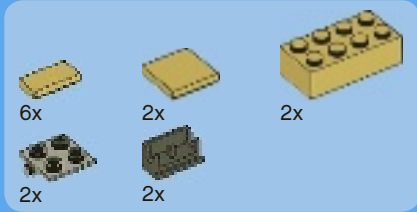

# 13

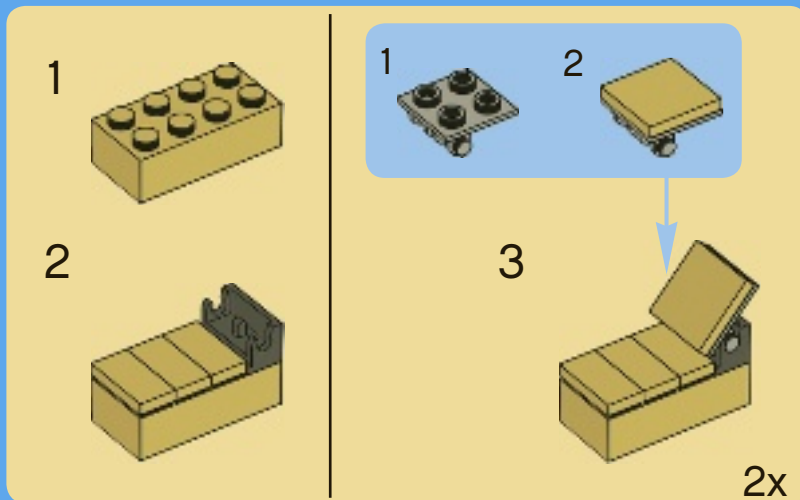



1x



1x



1x

# 14



1



2



# 15



1x



1x



1x



1



2



3



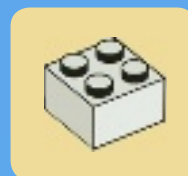
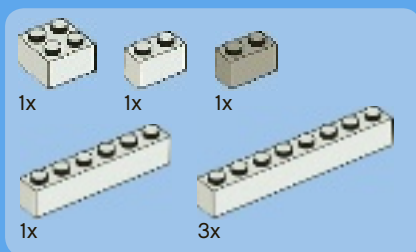

16

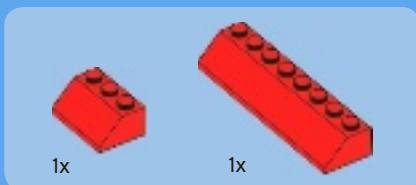

17

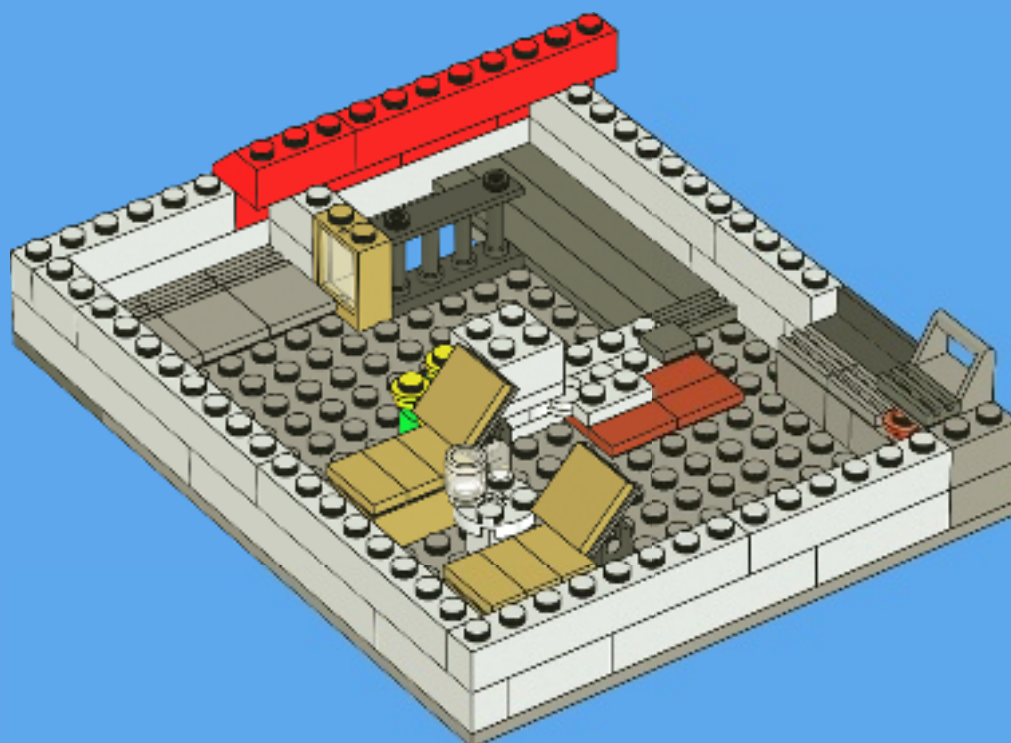

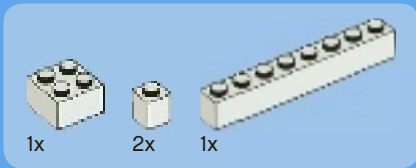

18

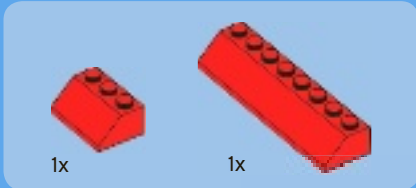
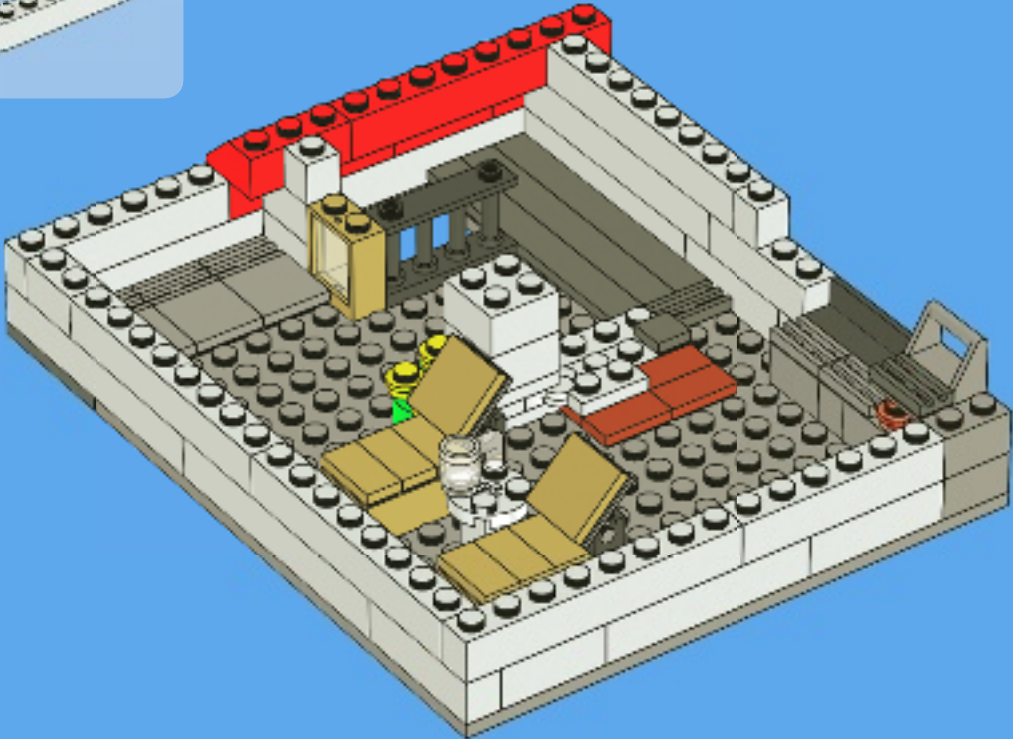

19



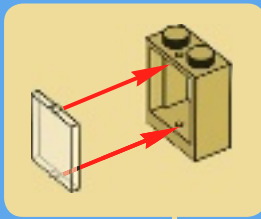
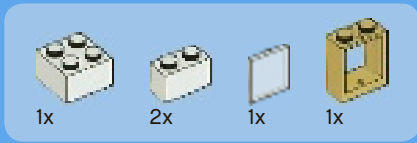

20

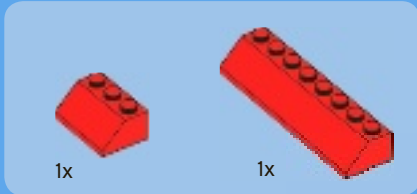
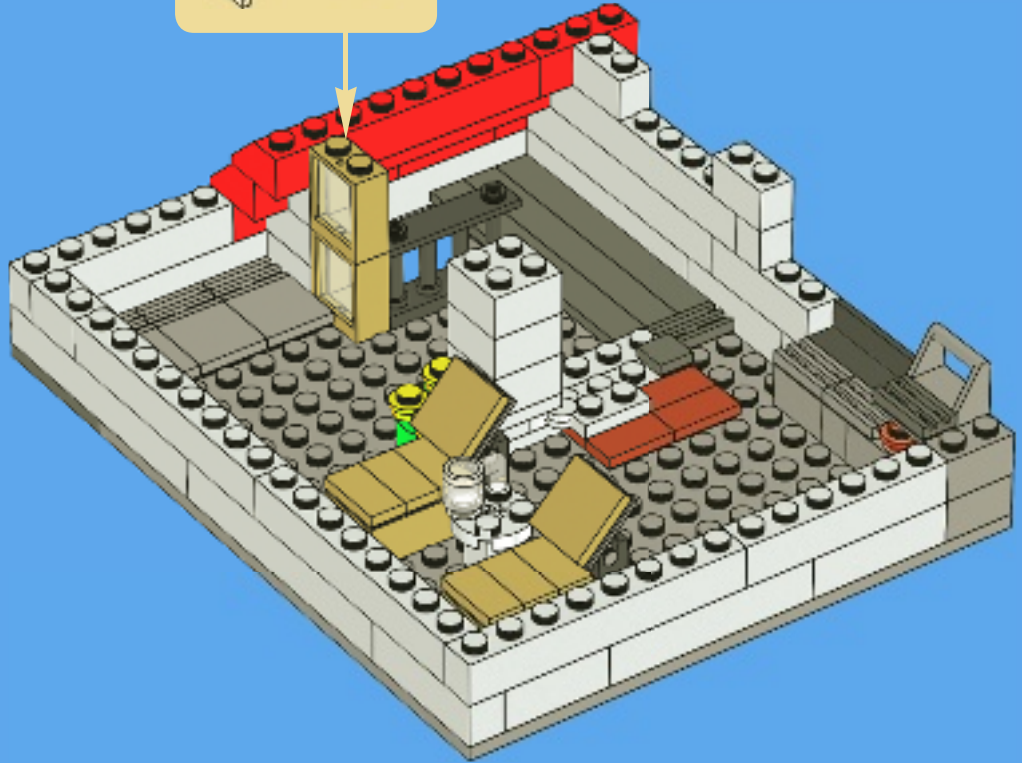

21

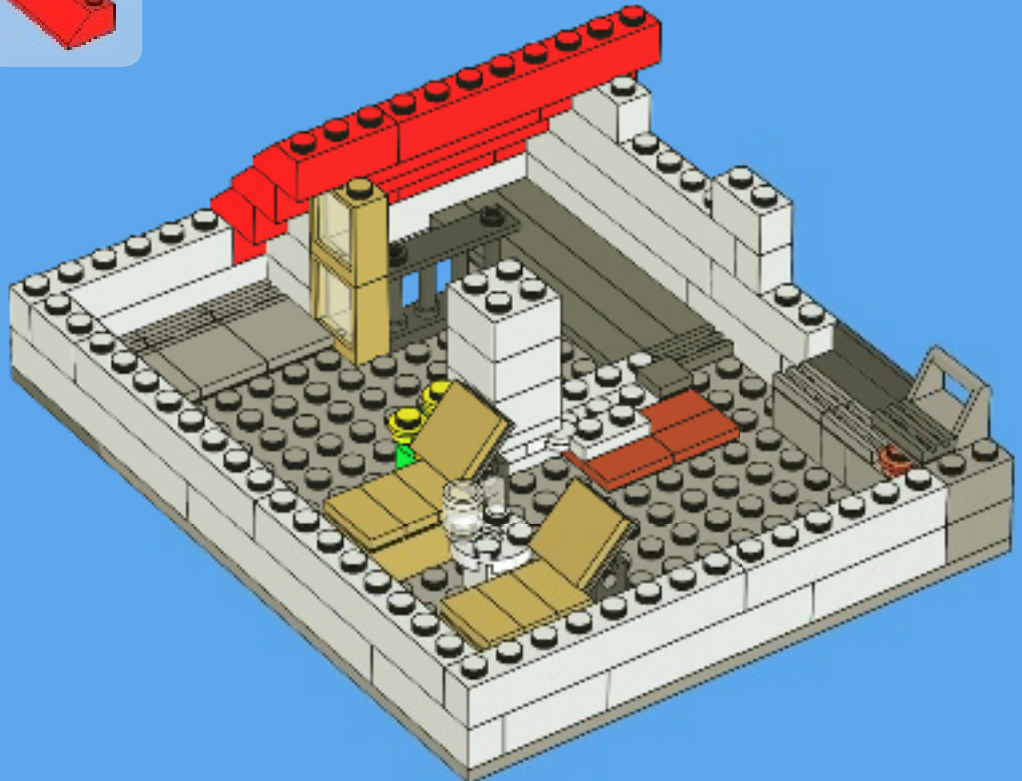



2x



1x



1x



1x

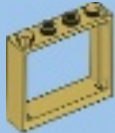

1x

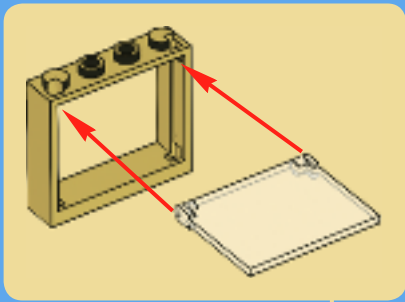

# 22

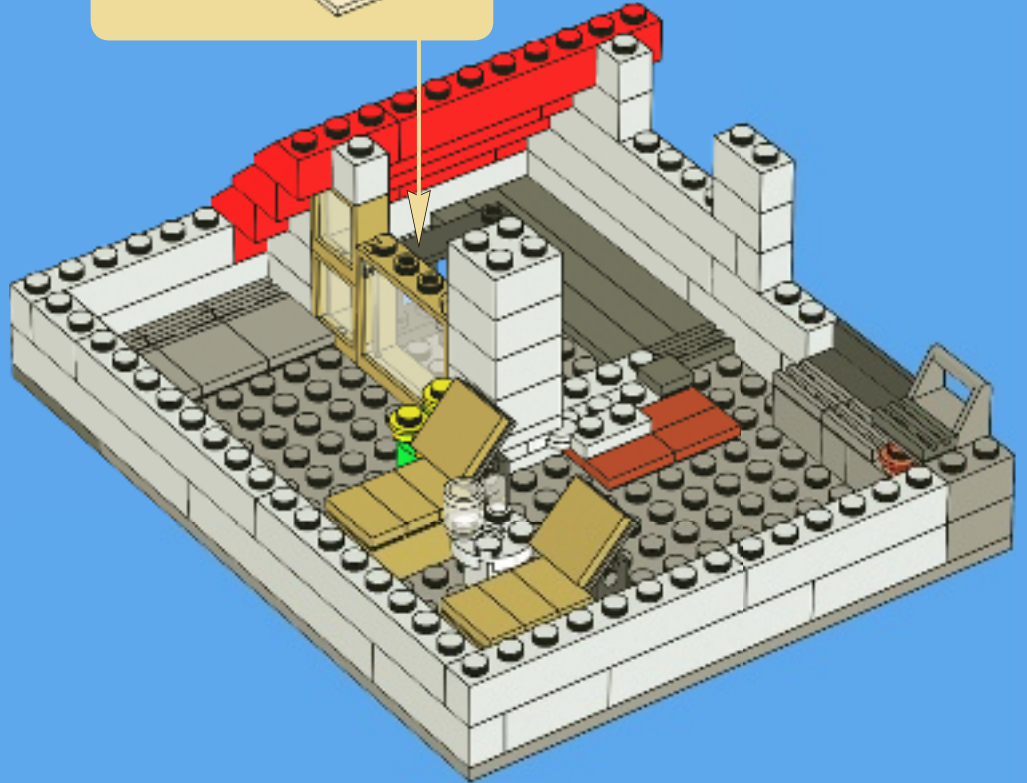

1x

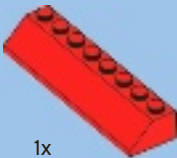

1x

# 23

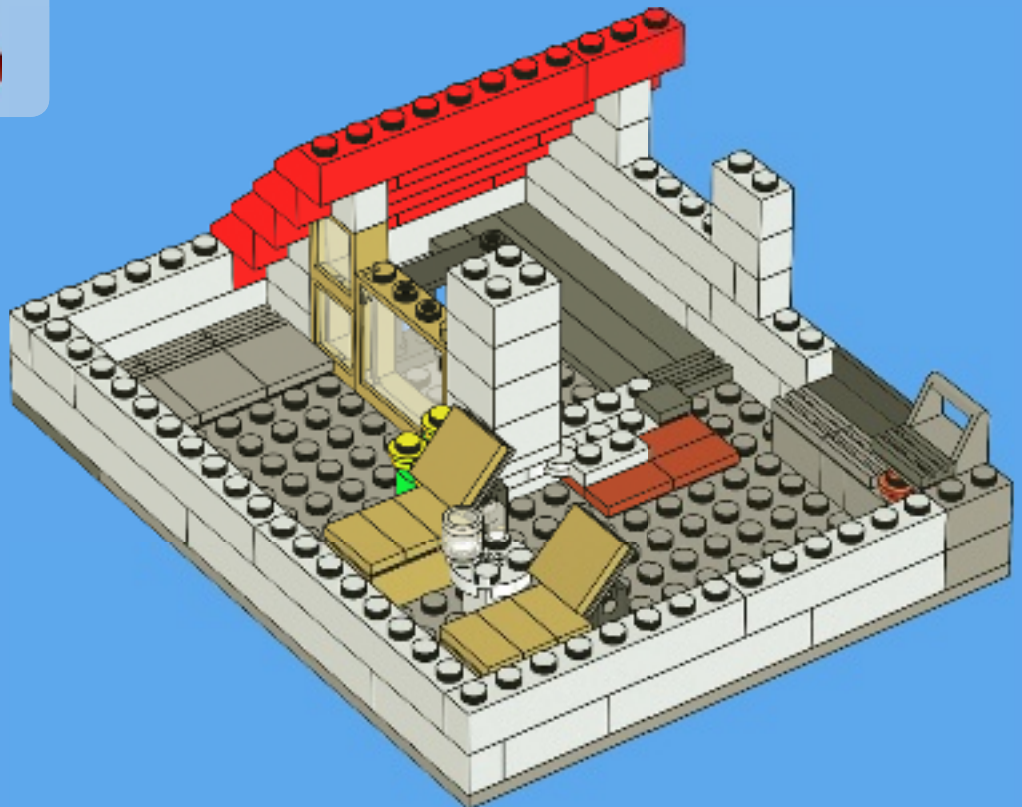

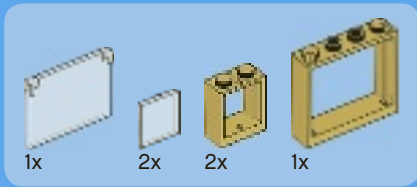

24

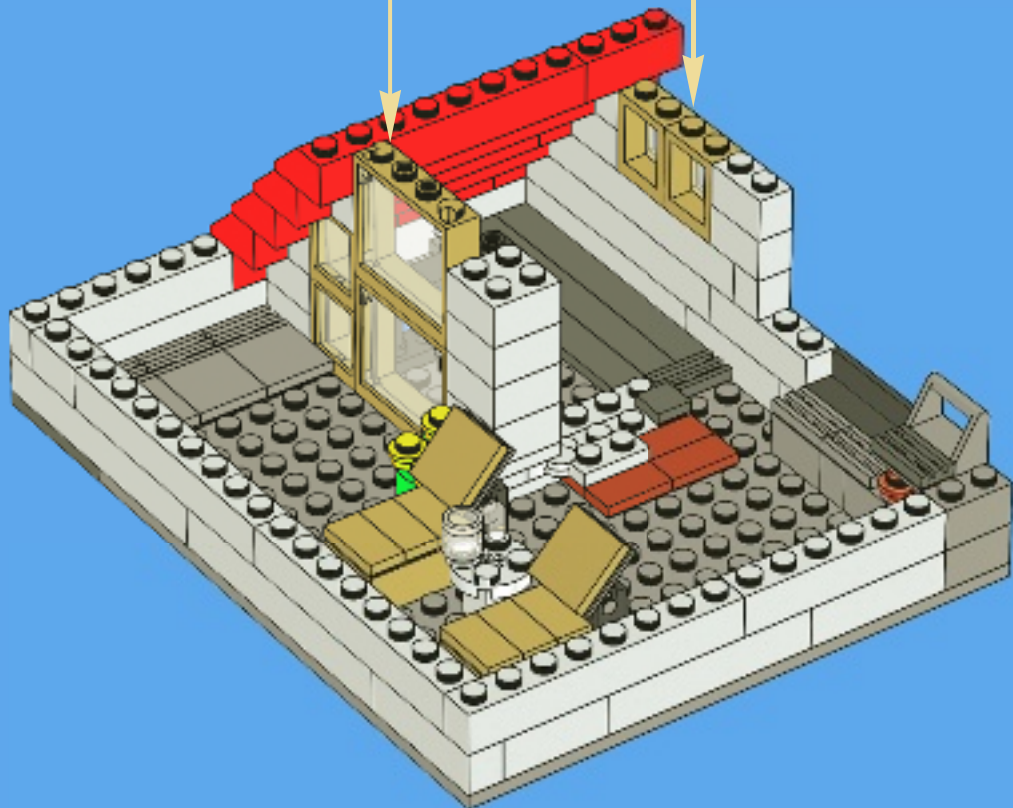
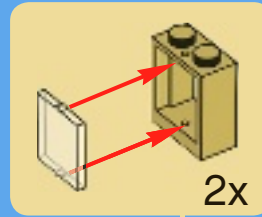
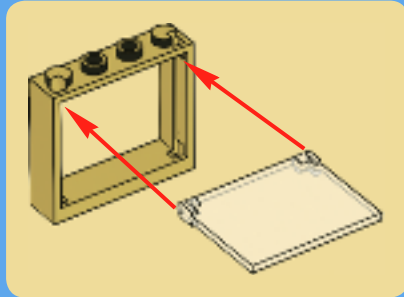

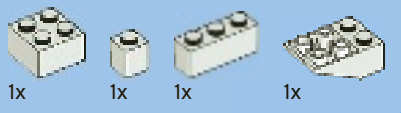

25

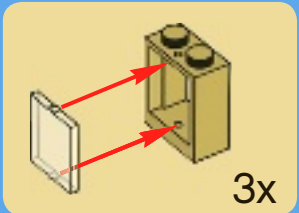
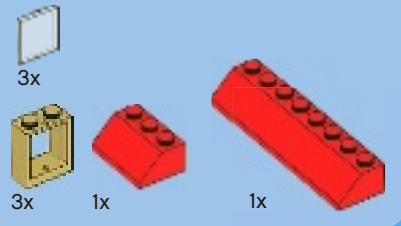
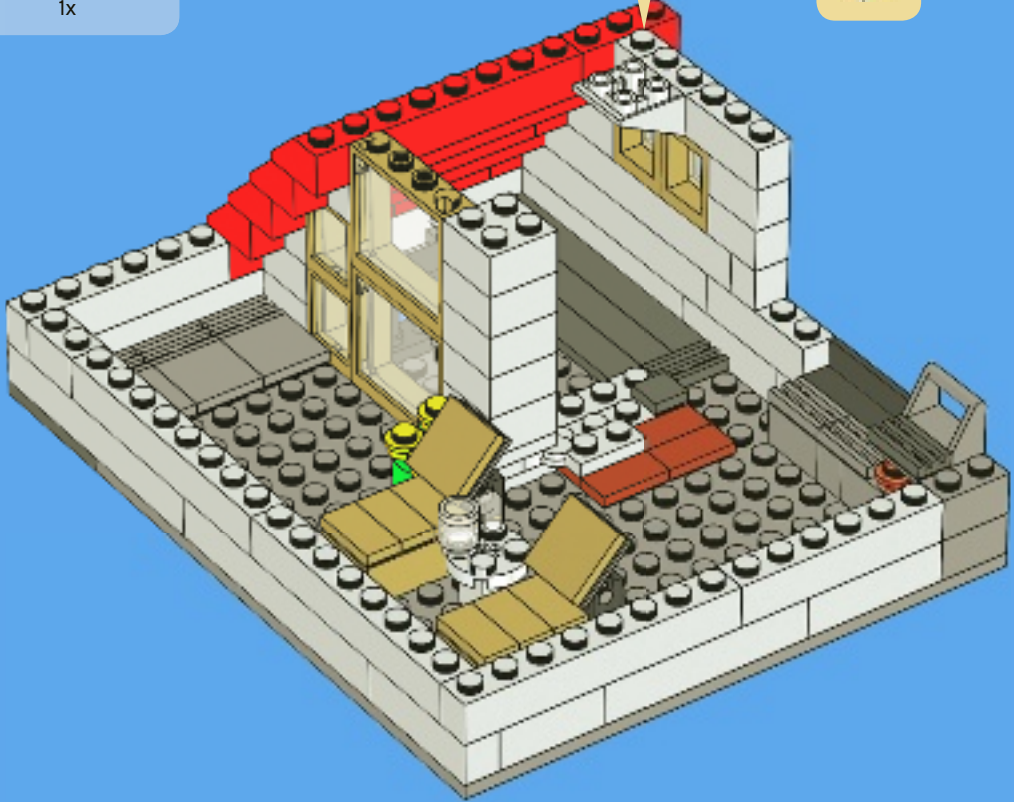

26

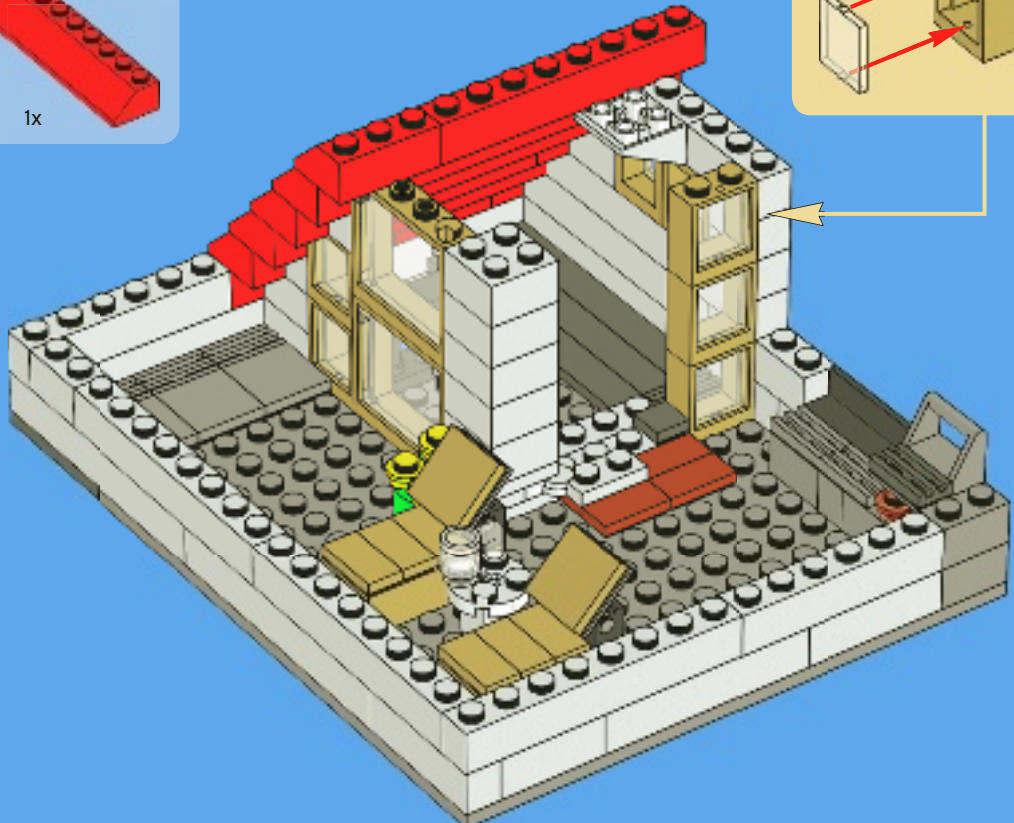





1x



2x



1x

# 27

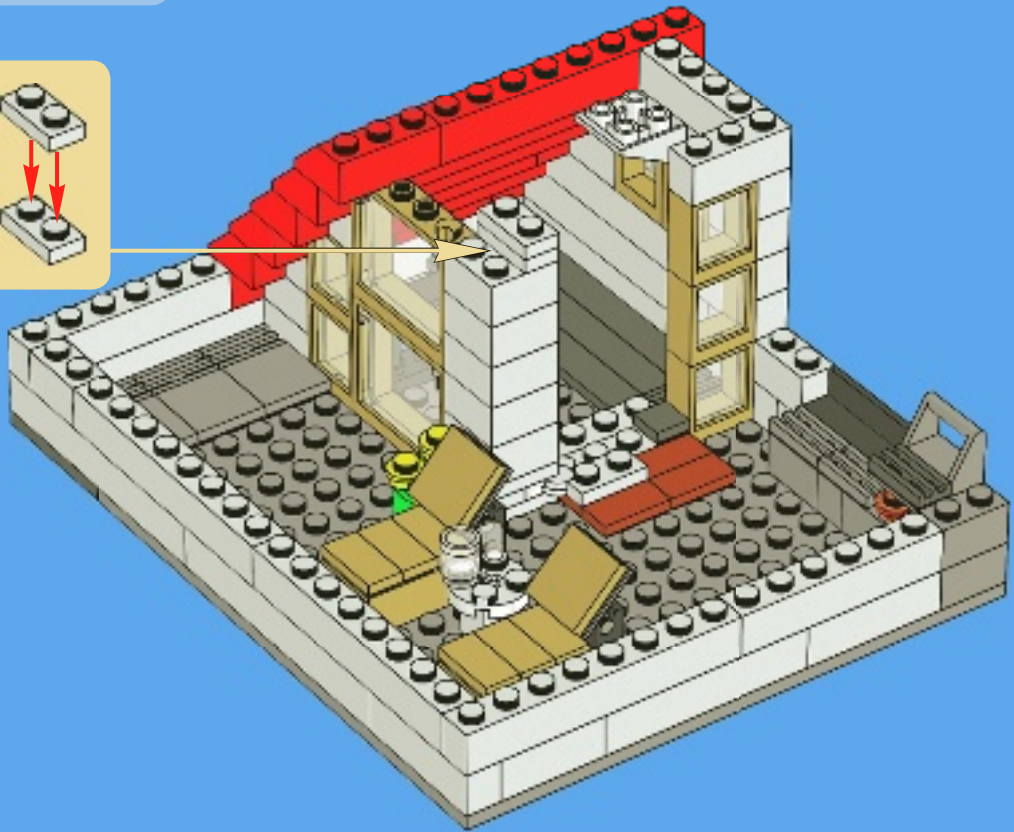
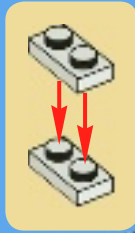

2x



1x

# 28



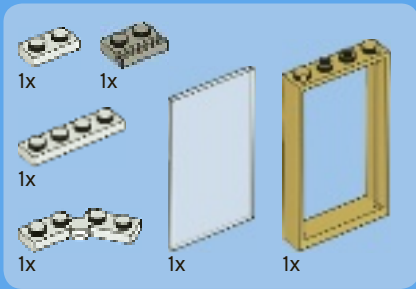

29

1

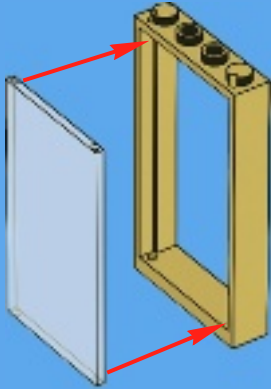

2

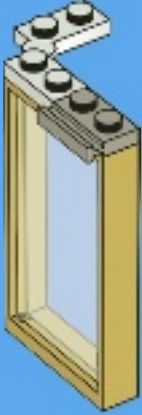

3

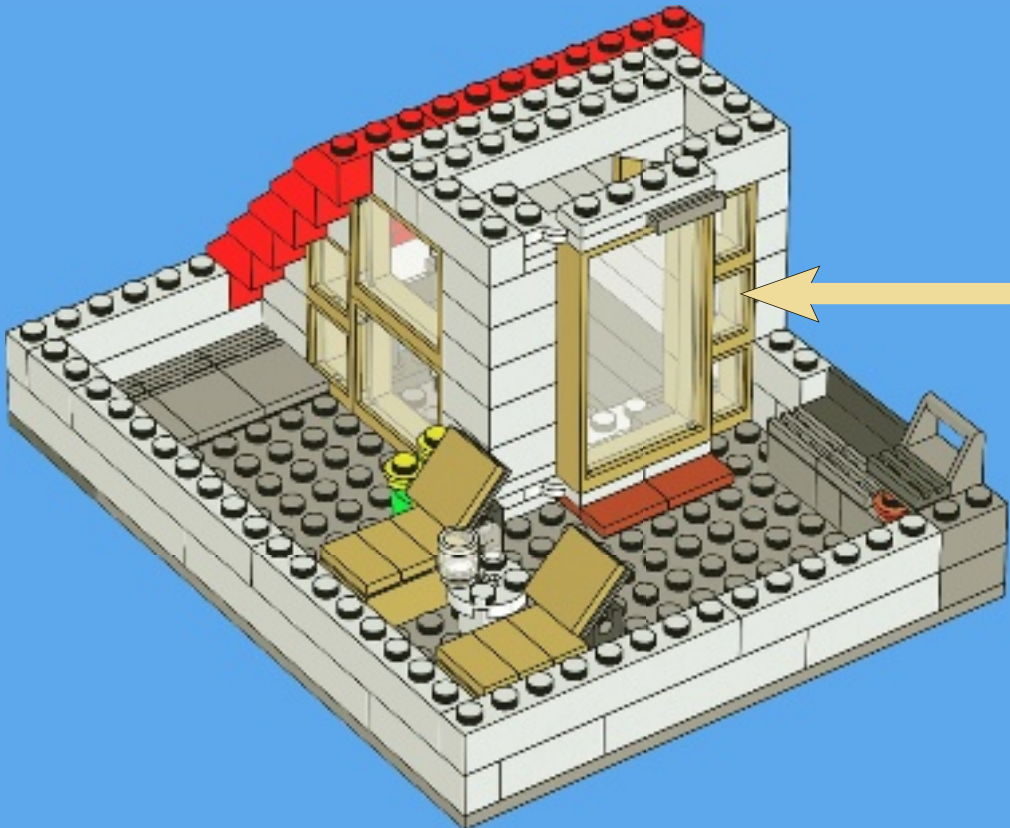
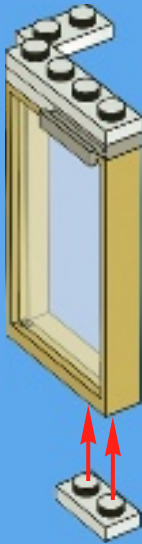



1x



3x

# 30

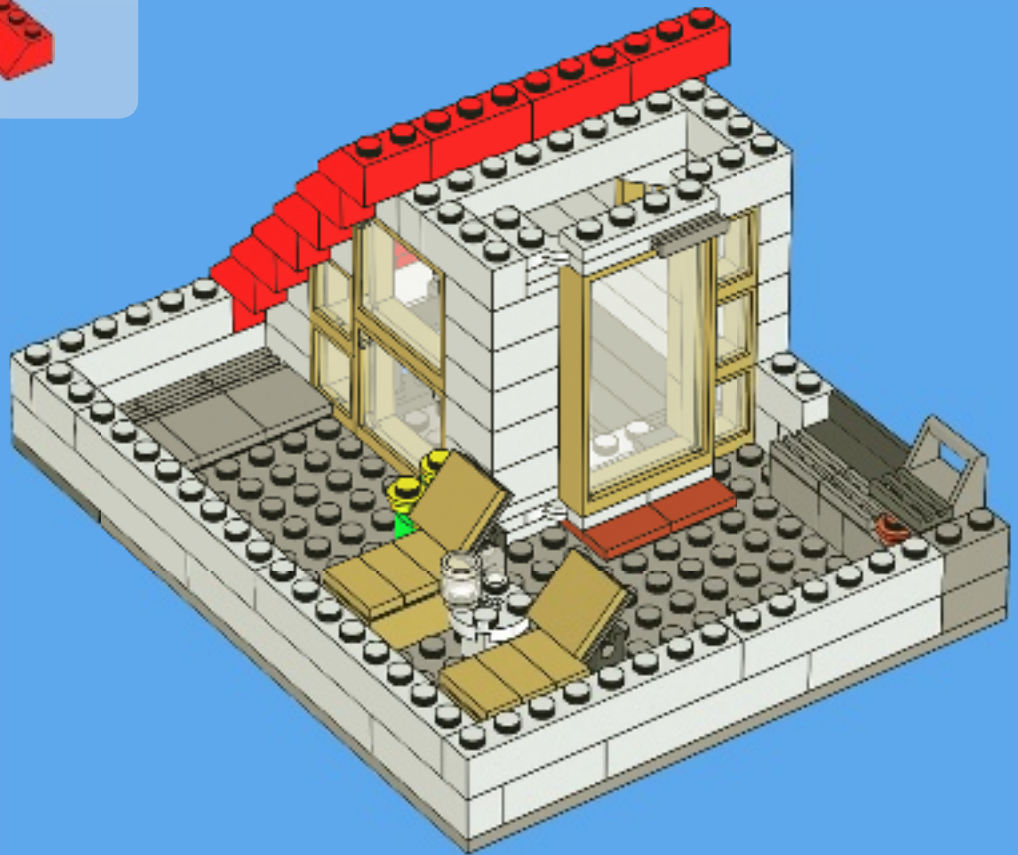

1x



2x



1x

# 31

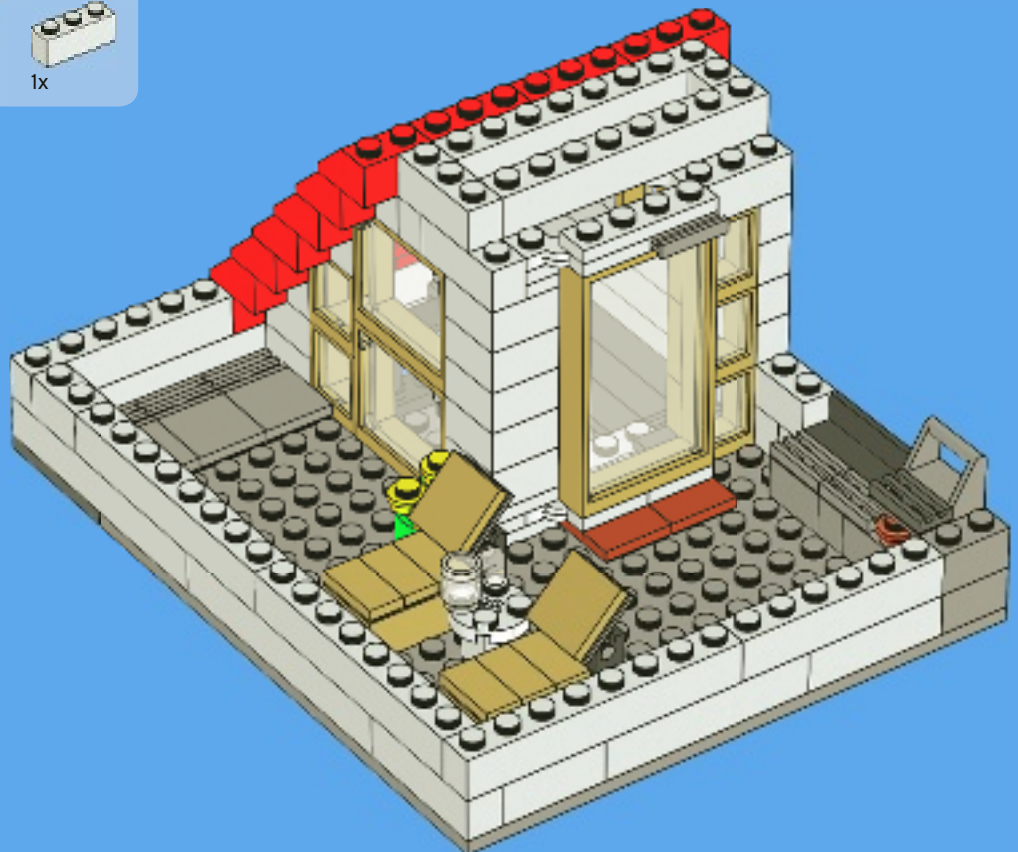

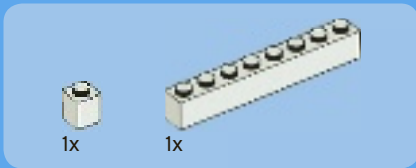

32

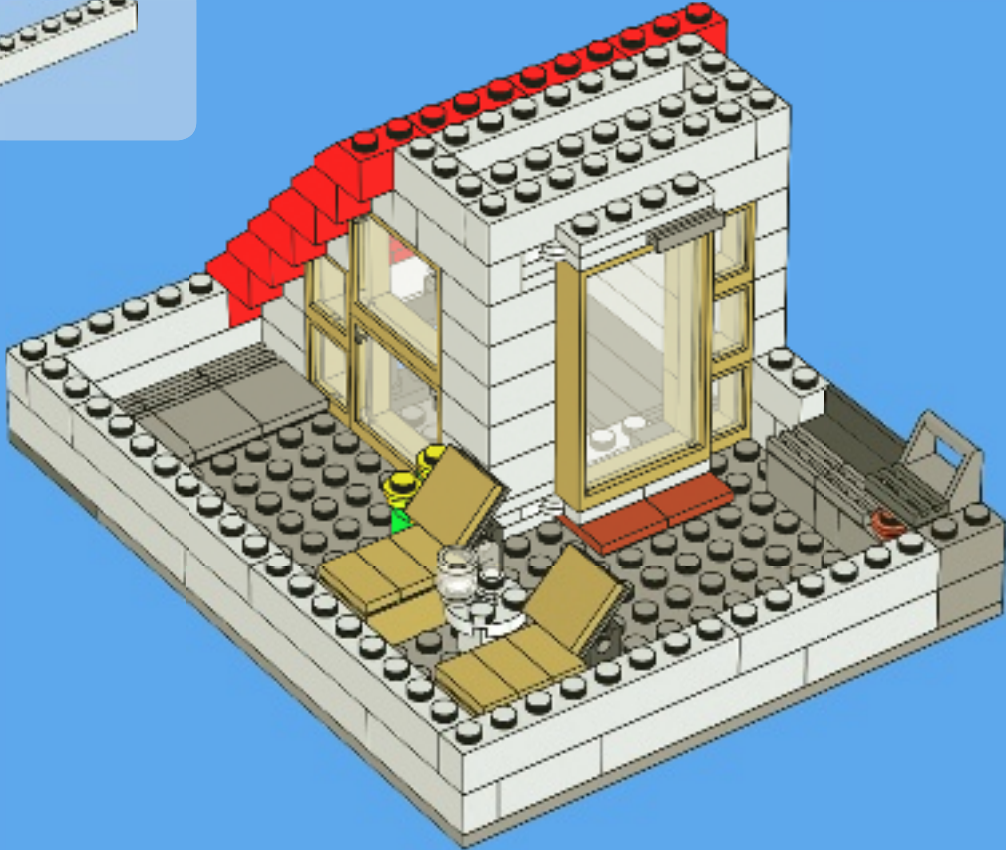

33

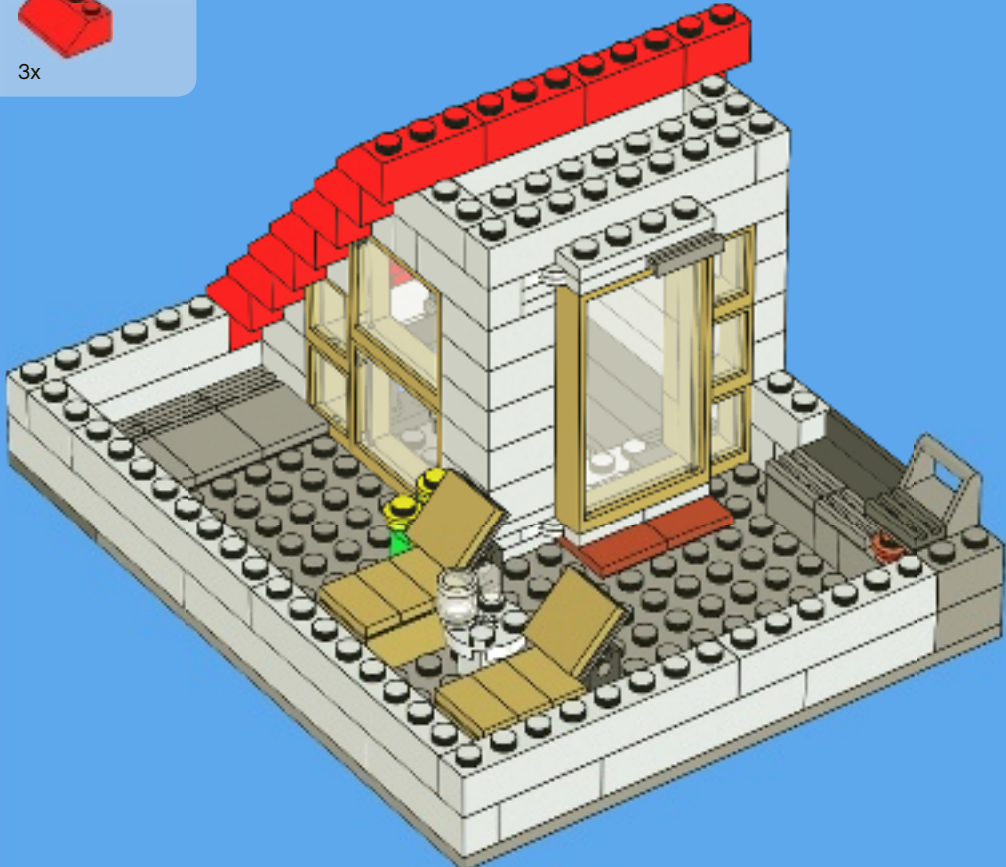



2x



1x



2x

# 34

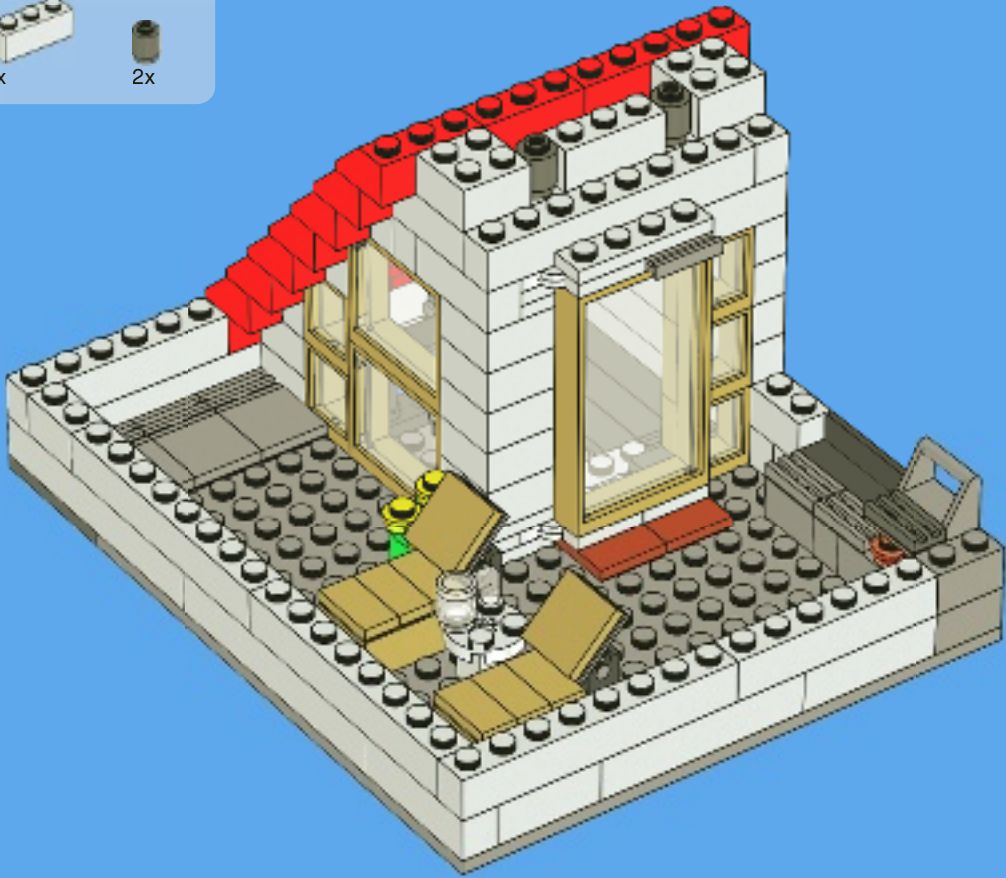

1x



3x

# 35

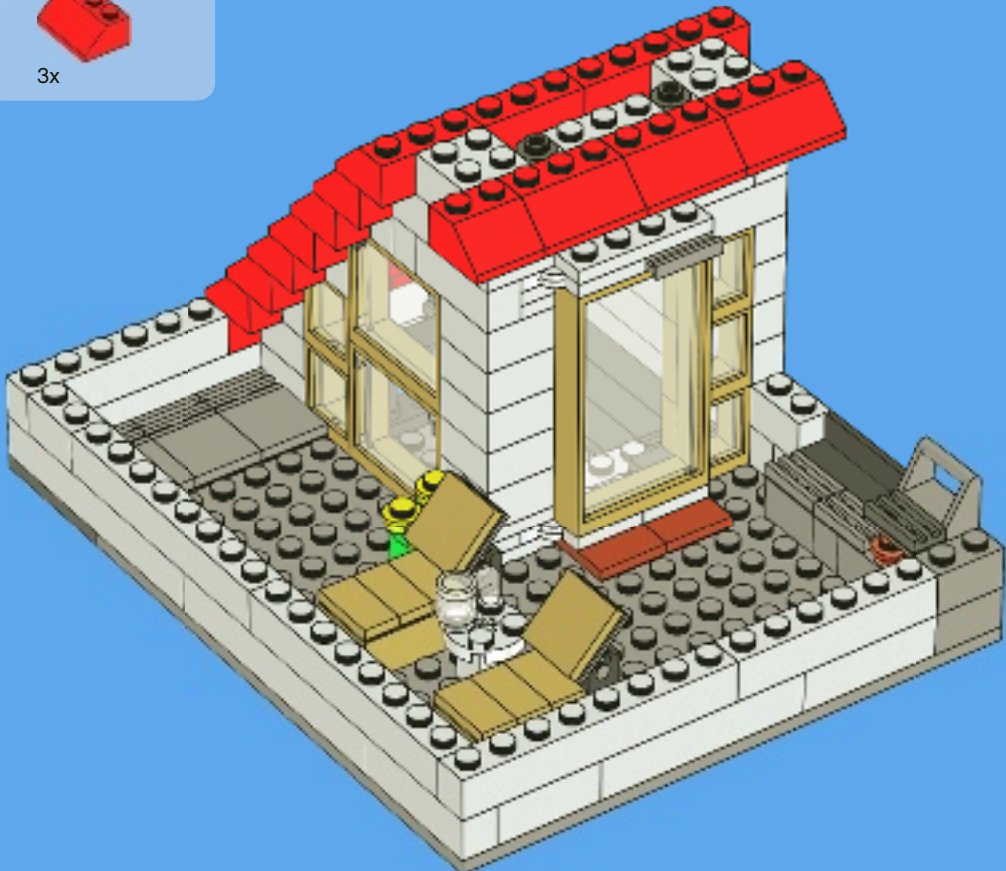



1x

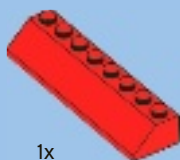

1x

# 36

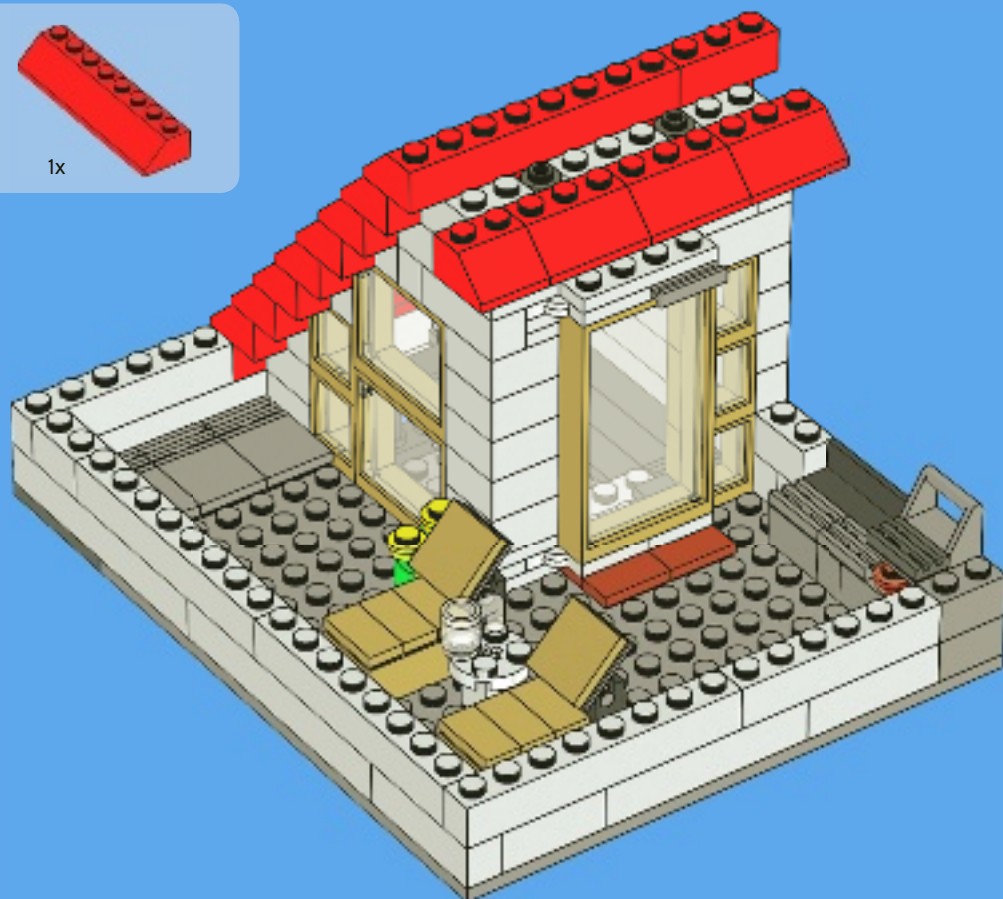

1x



3x

# 37

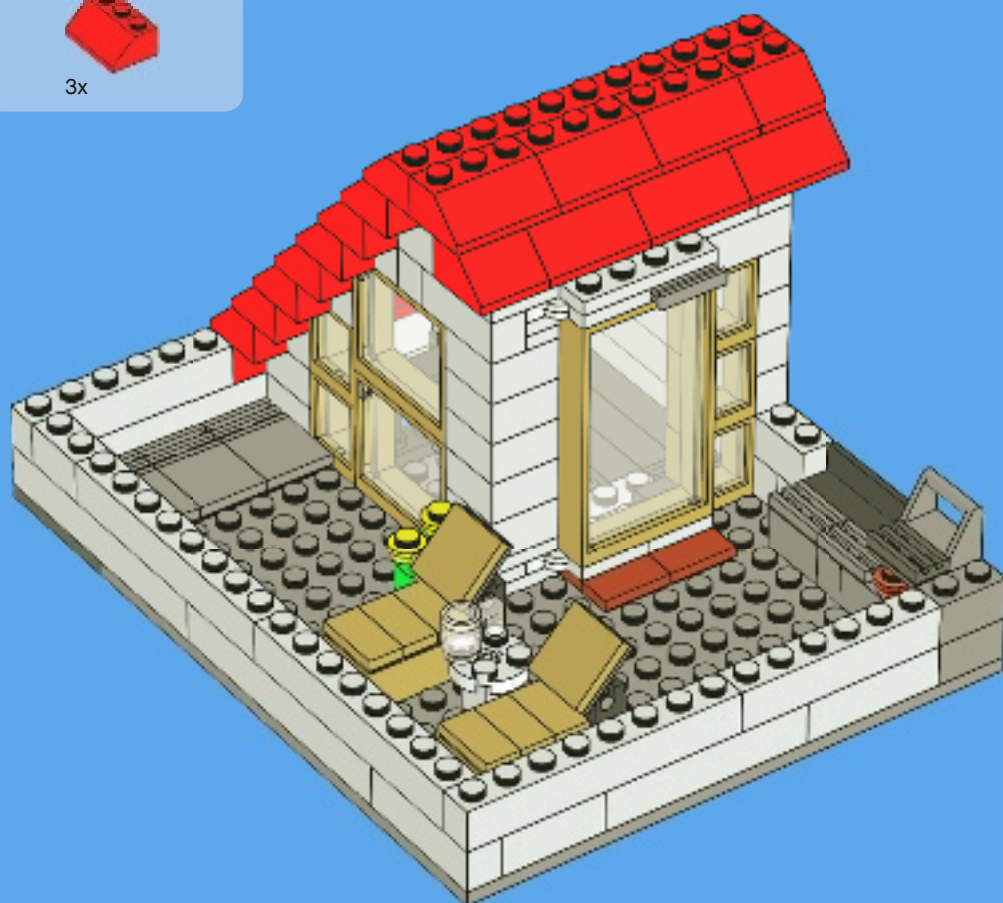



38

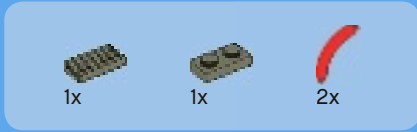

39

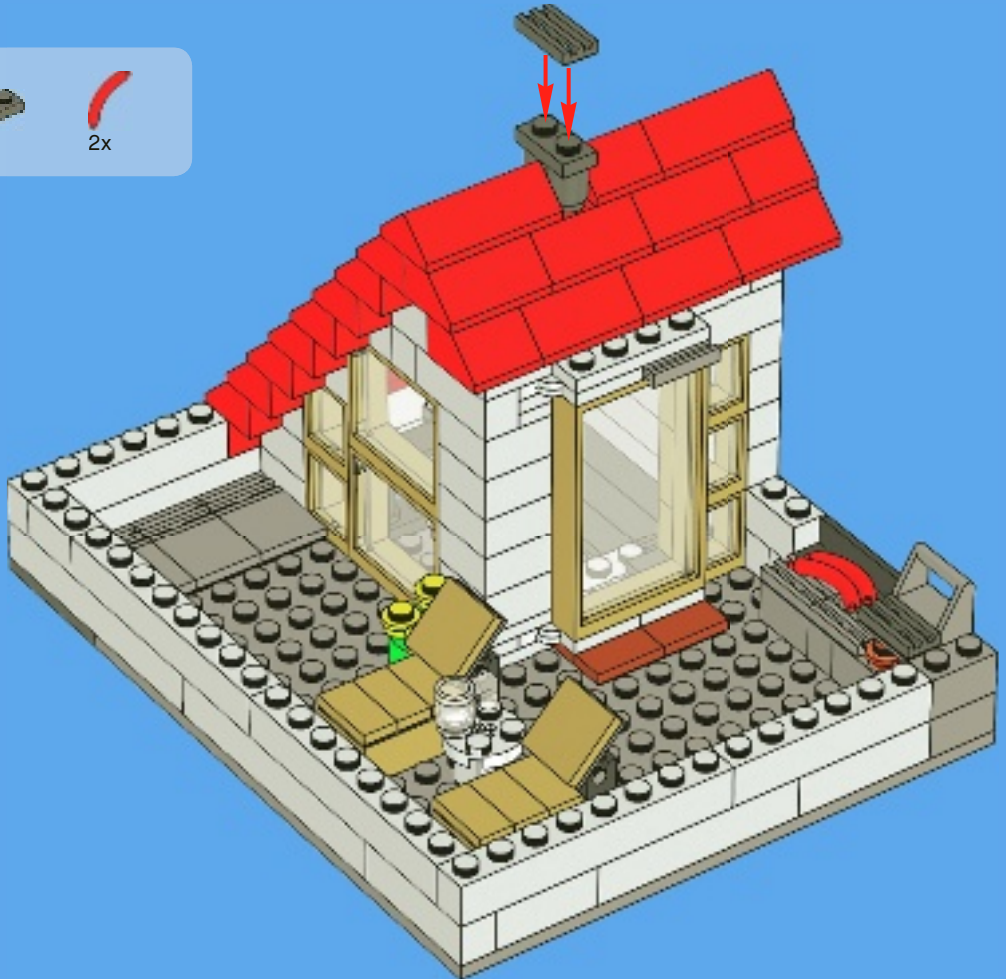

40







41

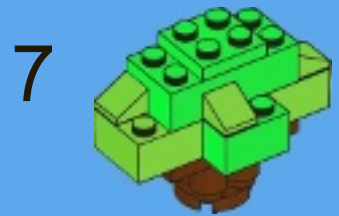
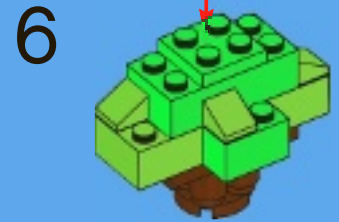
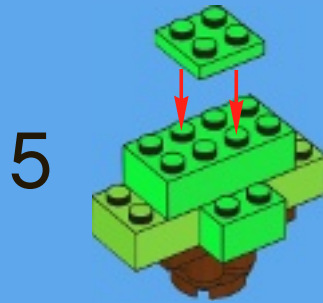
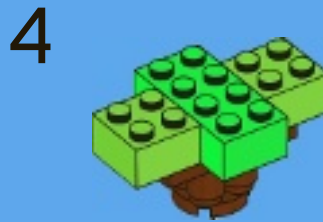

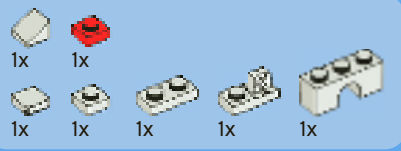

42

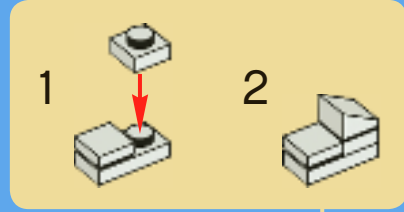



# CITY



7279



7285



7286



7287



7288



7498



# WIN!

Go to [www.LEGOsurvey.com/product](http://www.LEGOsurvey.com/product) to fill out a survey for a chance to win a cool LEGO® Product. No purchase necessary. Open to all residents where not prohibited.

 [www.LEGO.com](http://www.LEGO.com)



## [www.LEGOsurvey.com/product](http://www.LEGOsurvey.com/product)

### GEWINNE!

Nimm an der Umfrage auf [www.LEGOsurvey.com/product](http://www.LEGOsurvey.com/product) teil und hab die Chance ein cooles LEGO® Produkt zu gewinnen!

Die Teilnahme am Gewinnspiel führt zu keinerlei Kaufverpflichtungen. Teilnahme in allen nicht ausgeschlossenen Ländern möglich.

### WIN!

Ga naar [www.LEGOsurvey.com/product](http://www.LEGOsurvey.com/product), vul een enquêteformulier in en maak kans op een cool LEGO® product.

Geen aankoopverplichting. Iedereen mag deelnemen, uitgezonderd ingezetenden van landen waar een enquêteverbod geldt.

### GAGNE!

Visite [www.LEGOsurvey.com/product](http://www.LEGOsurvey.com/product) pour répondre à un questionnaire et avoir une chance de gagner un produit LEGO® très cool!

Aucune obligation d'achat. Ouvert à tous les résidents des pays autorisés.

### 当てよう!

[www.LEGOsurvey.com/product](http://www.LEGOsurvey.com/product) にアクセスして、アンケートにご記入ください。当選者にはレゴ®製品を差し上げます。

お買い上げの必要はありません。

禁止されていない限り、すべての皆様にご利用いただけます。