

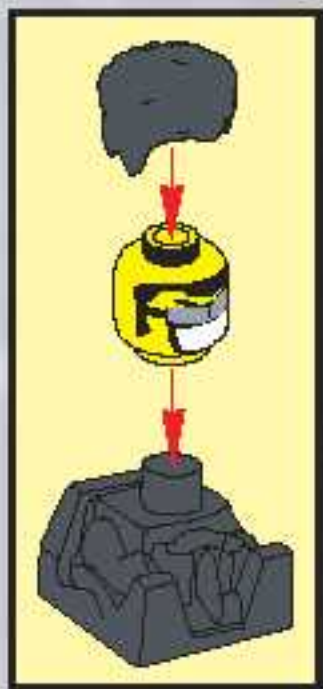

4301

4181838



1

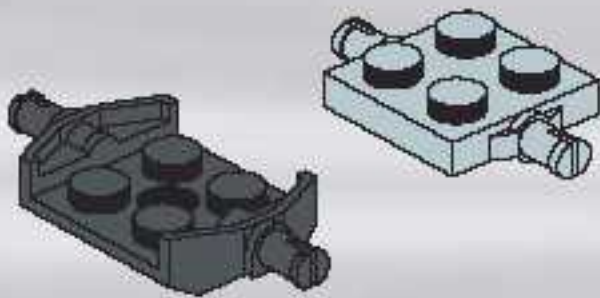

2

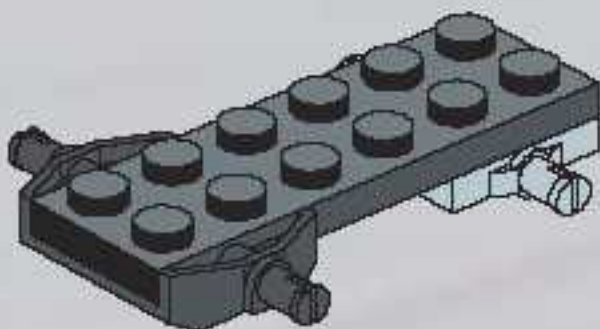

3

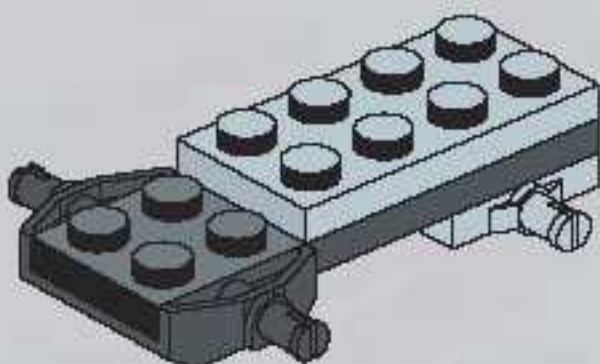

4

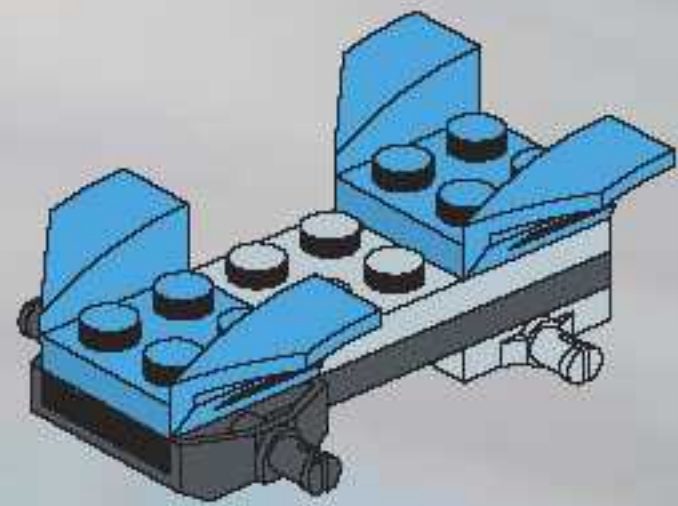

5

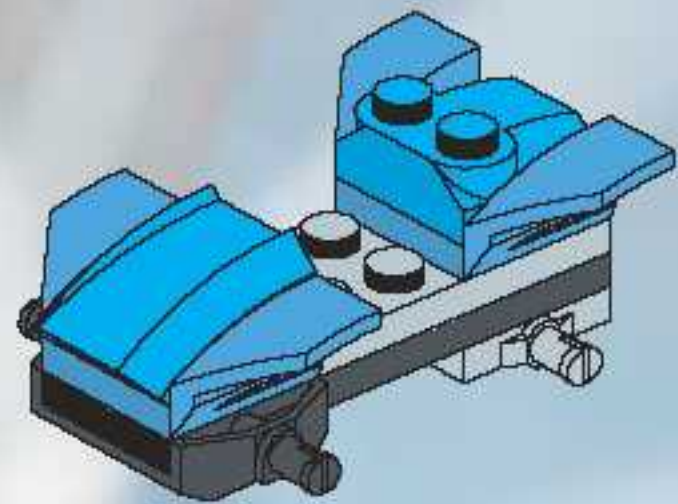

6

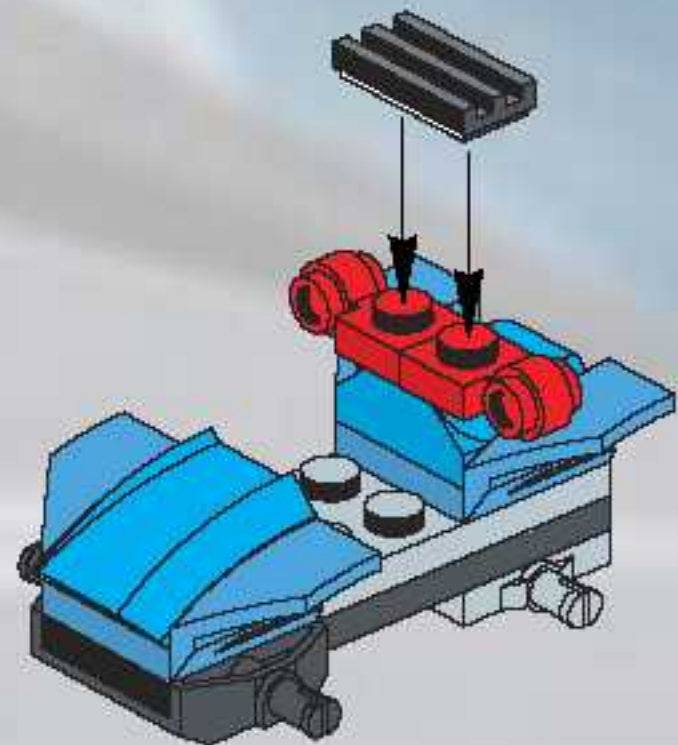

7

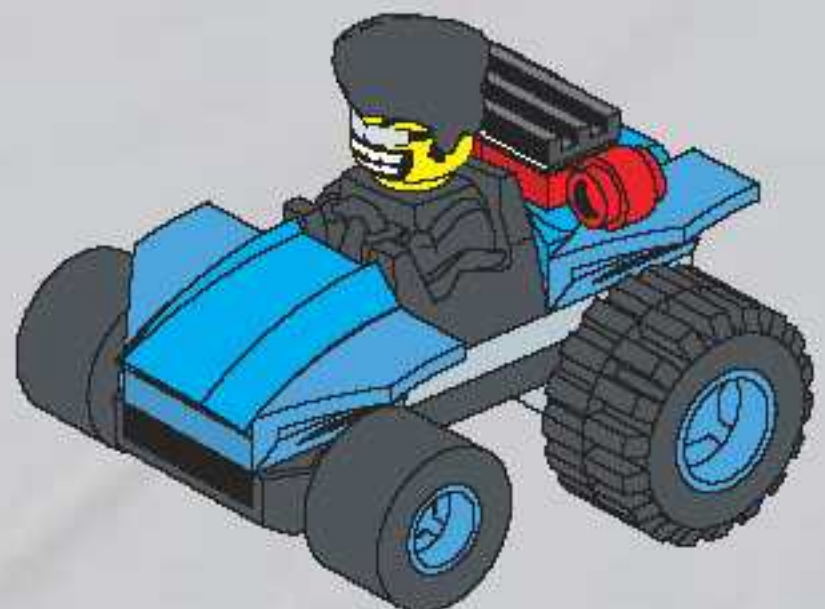





# RACERS



4584



**PULLBACK  
MOTOR**



4585



**PULLBACK  
MOTOR**



4586



**PULLBACK  
MOTOR**



4589



**IR  
RC**  
REMOTE CONTROL



[www.LEGO.com/racers](http://www.LEGO.com/racers)

LEGO, the LEGO logo and LEGO Racers are trademarks of the LEGO Group. Here used with special permission. ©2002 The LEGO Group. 4181638.