

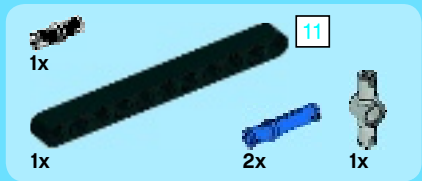

TECHNIC

42004





2

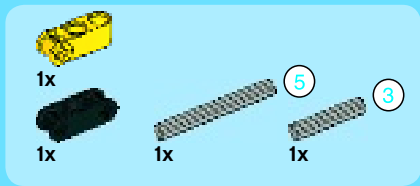
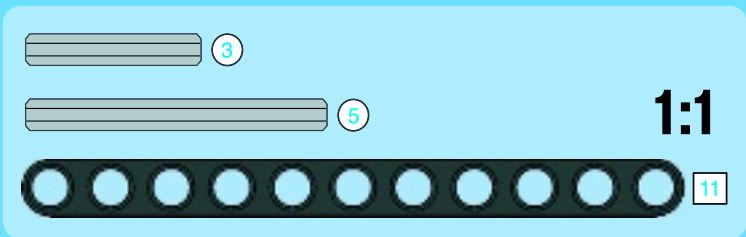

2

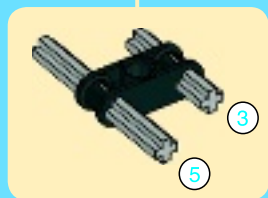
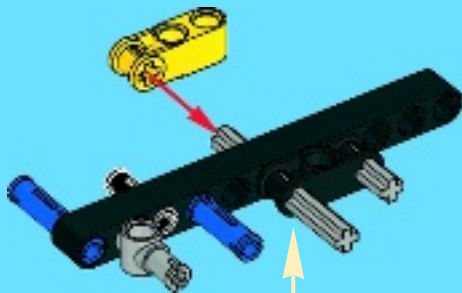



3

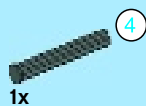
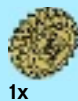
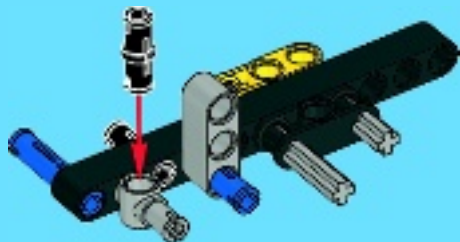

4

1

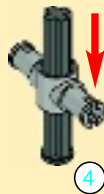

2

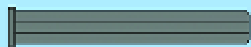

1:1



5

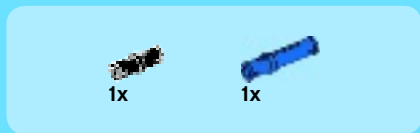
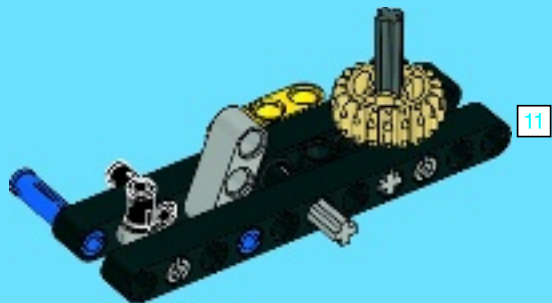

6

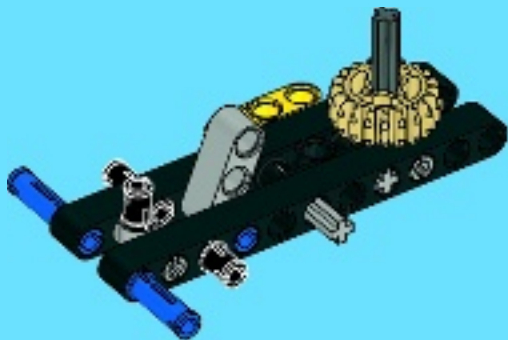

4



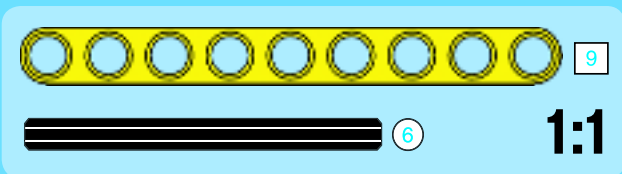
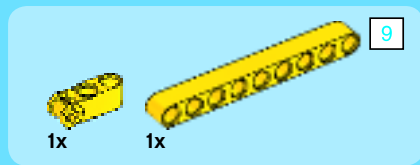

7

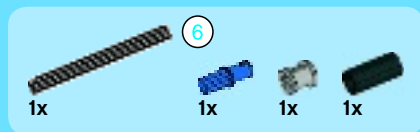
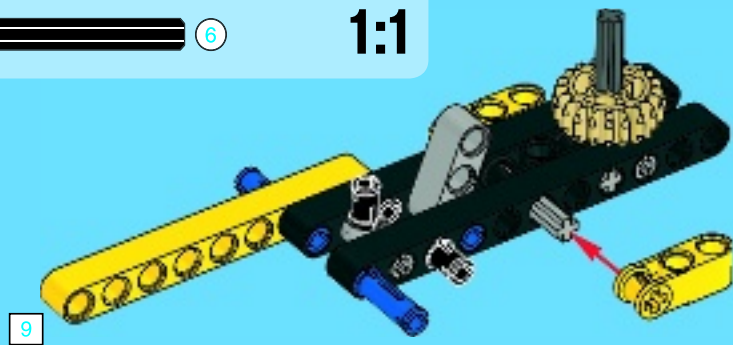

8

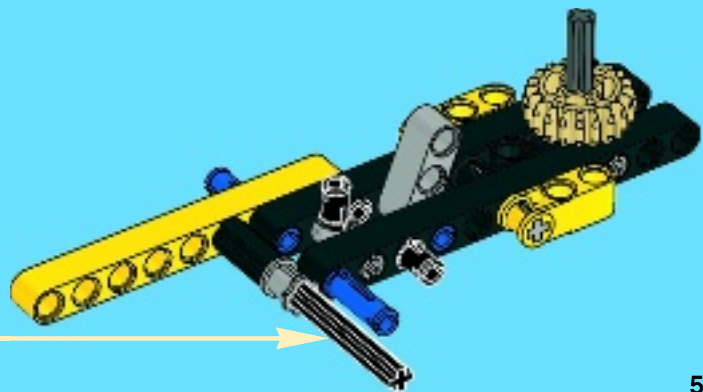
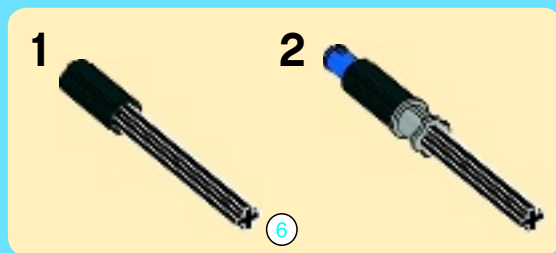

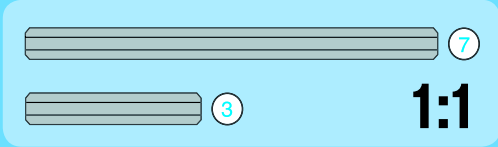
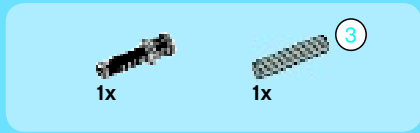

1

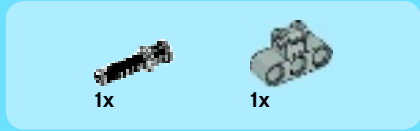

2



6

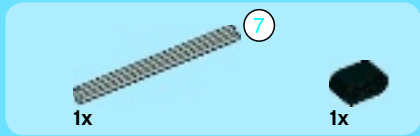

3

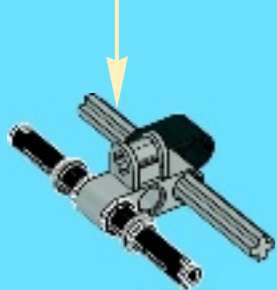
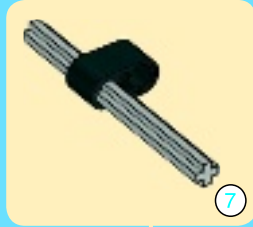



4

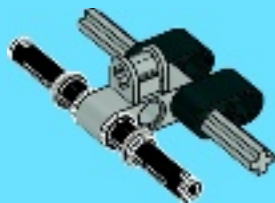

5



6



9

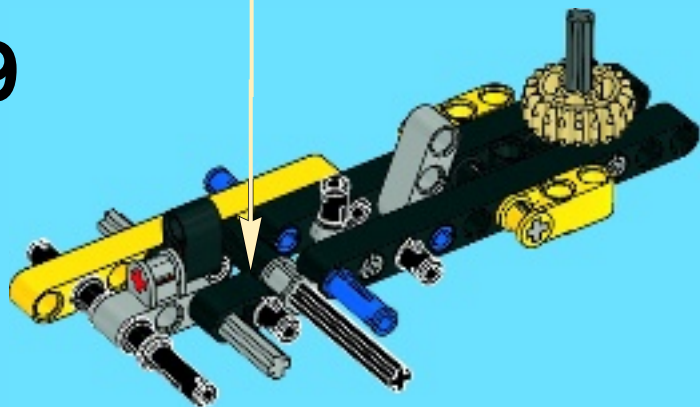



1x



9

1:1

10

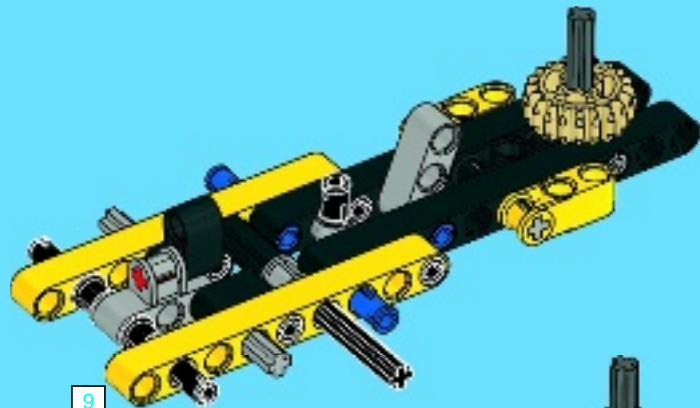

9



2x



1x

11

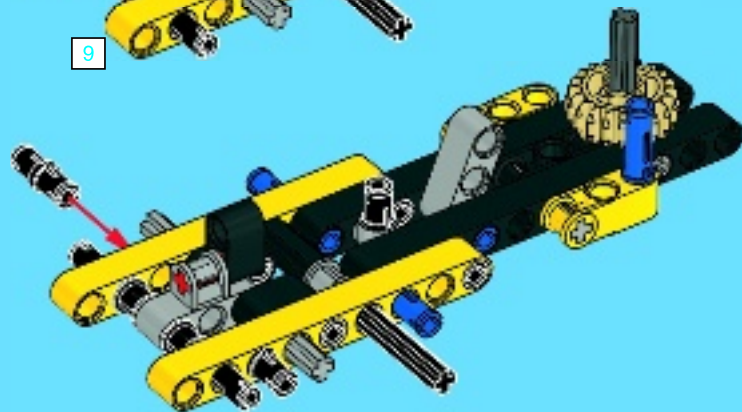

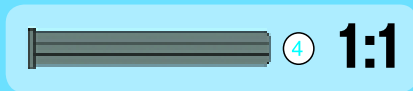
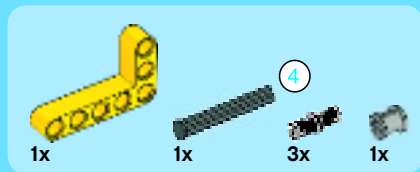

12

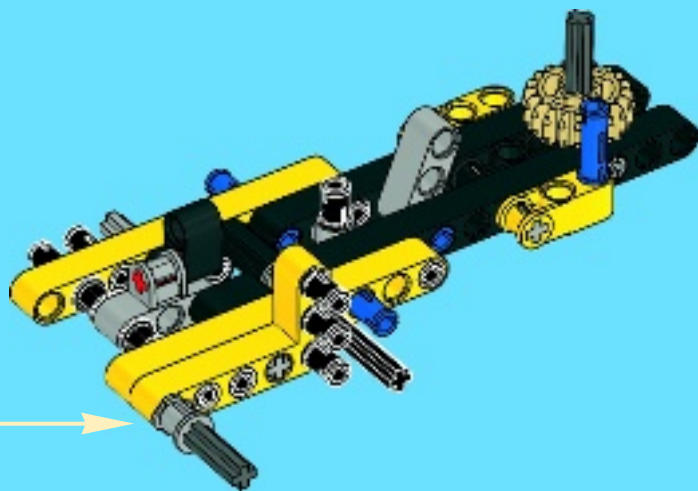
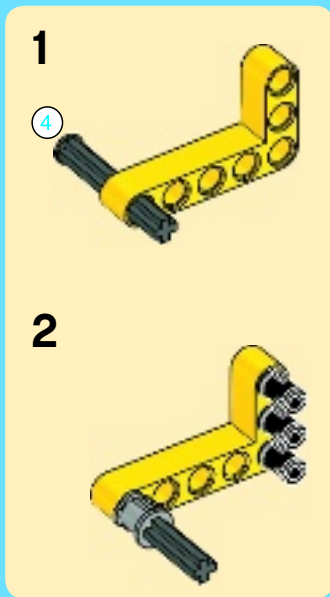

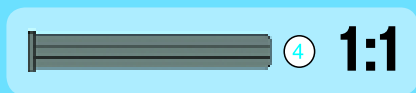
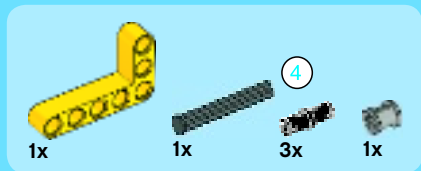

13

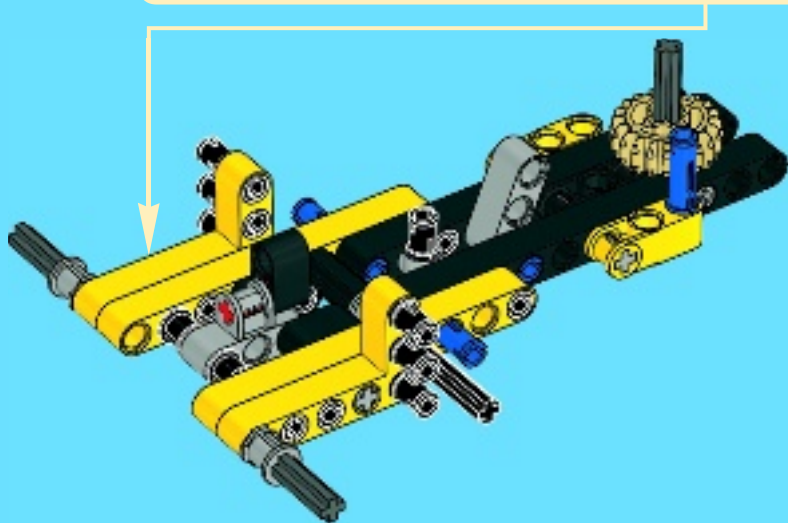
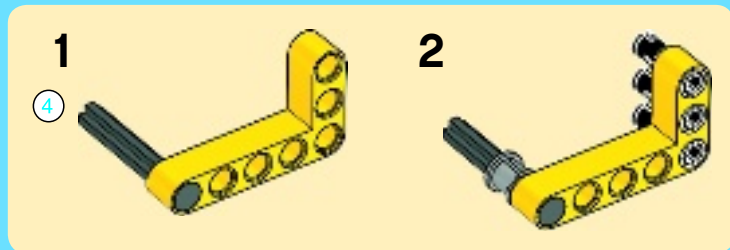

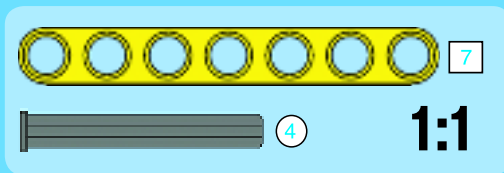

1

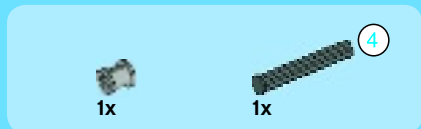
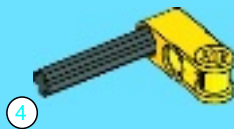

2

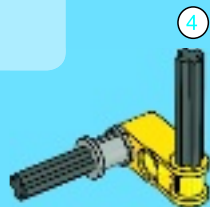

3

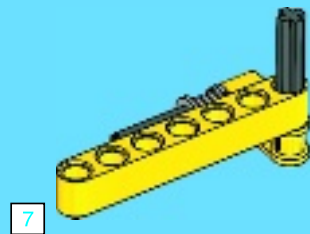



4

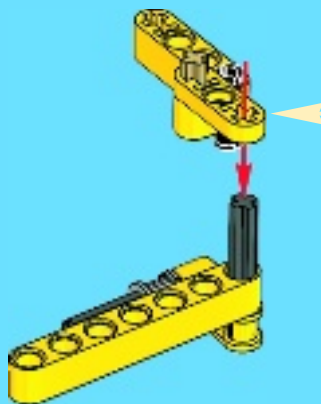



1x



1x



2x

4



4

1:1

5

1

4

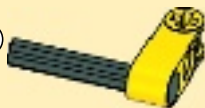

2

4

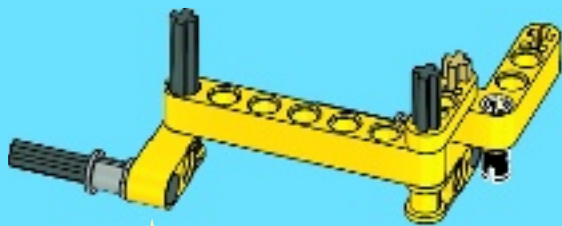

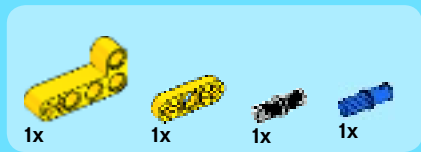

6

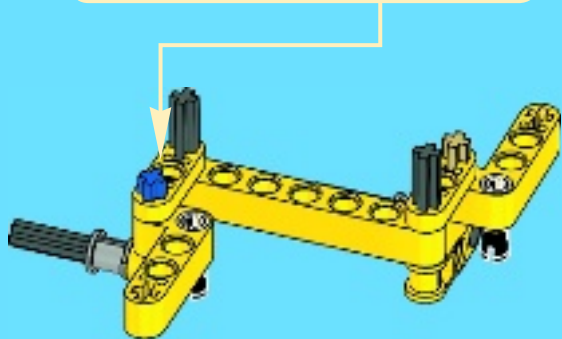
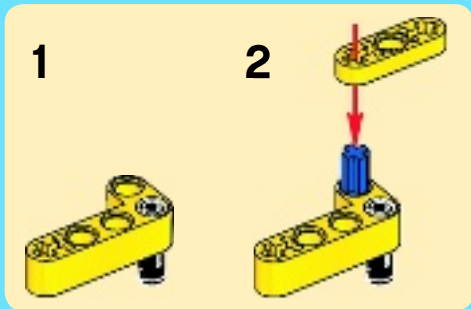

14

14

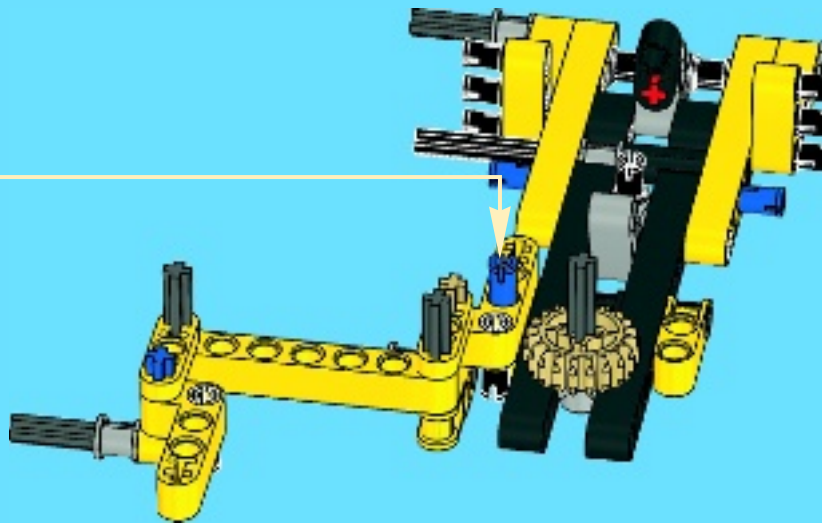

15

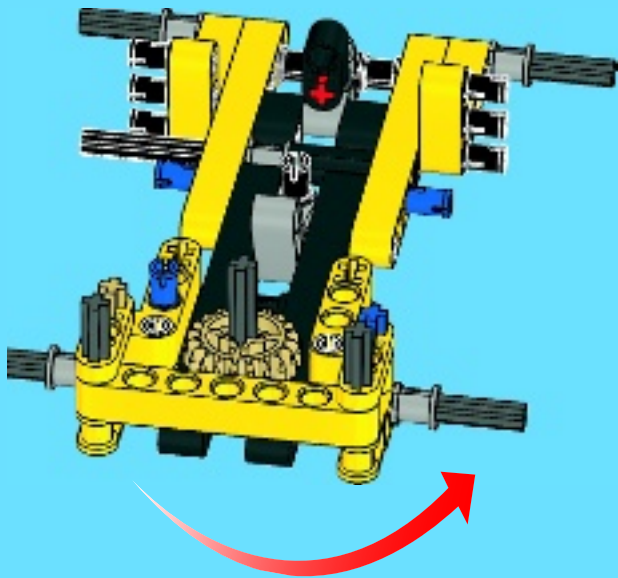

16

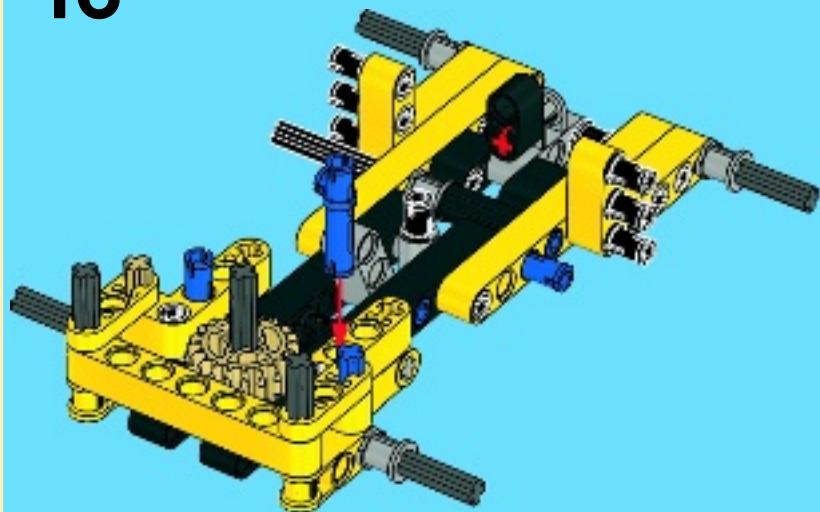

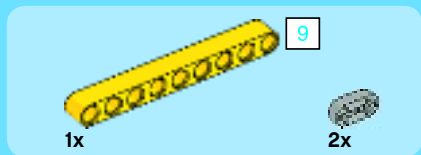

17

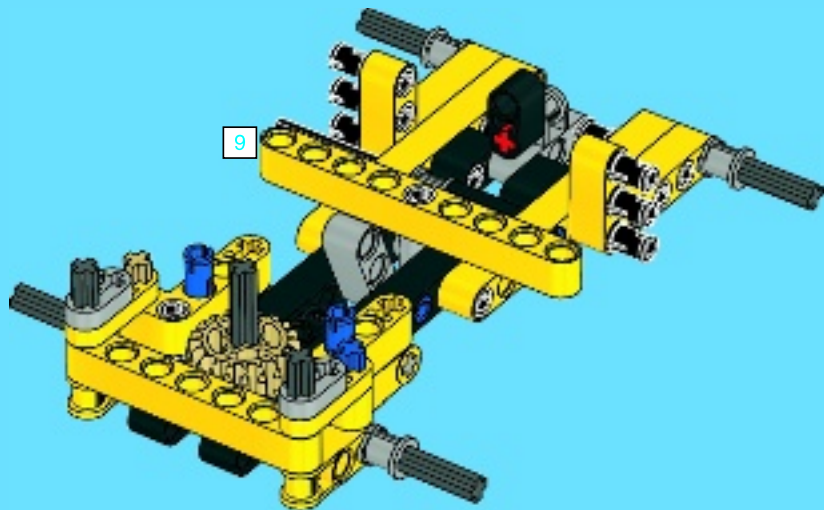



1x



2x

18

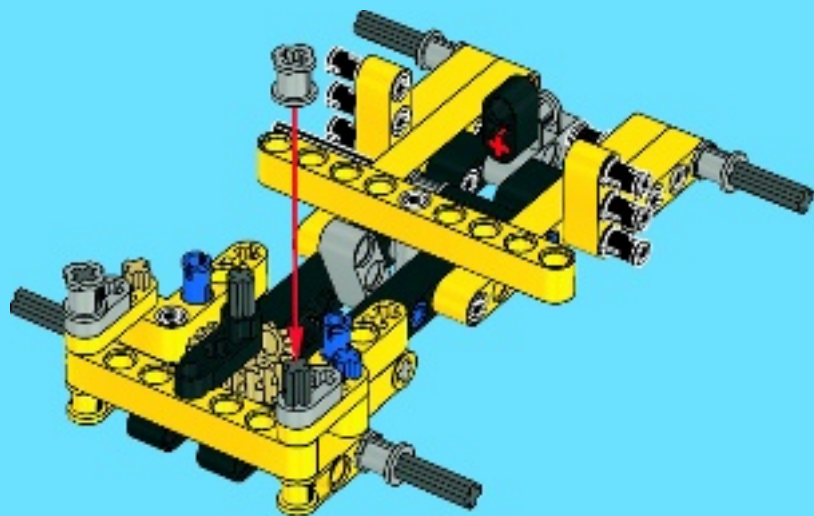



2x

19

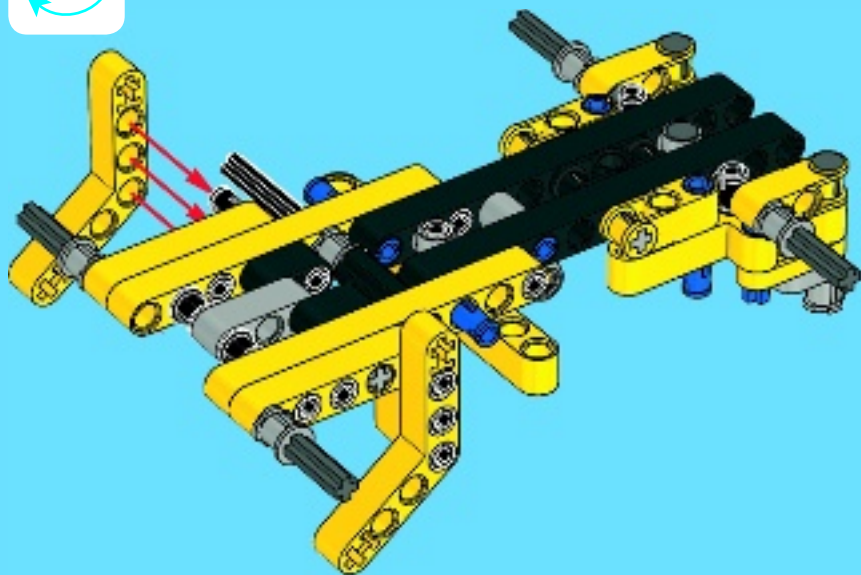



2x

20

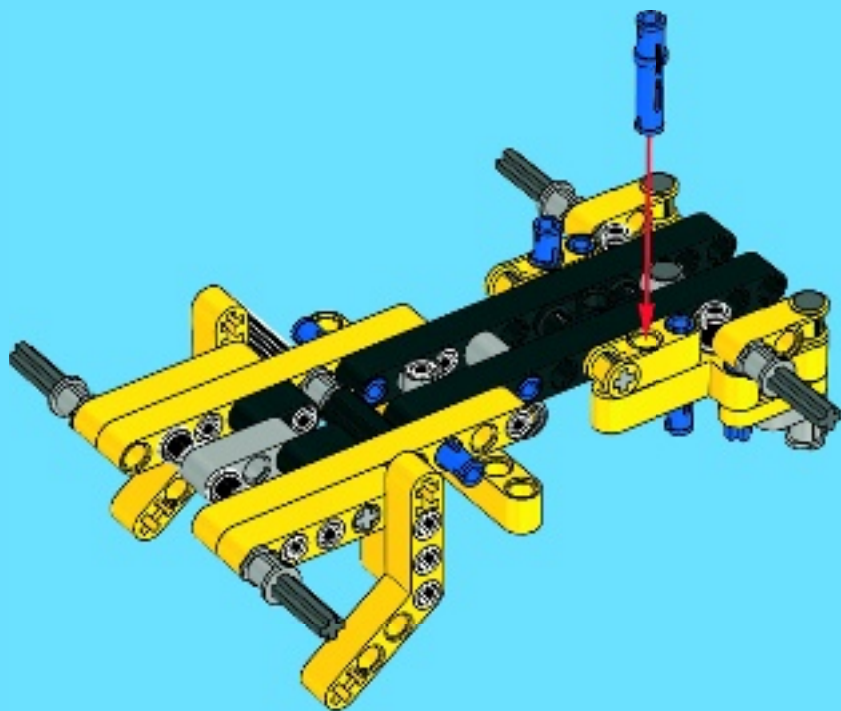

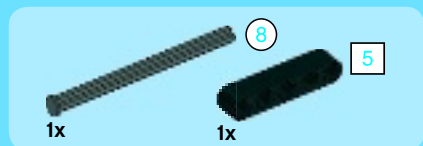

21

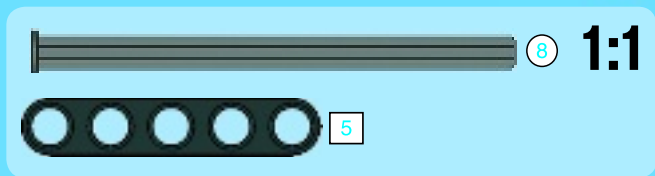
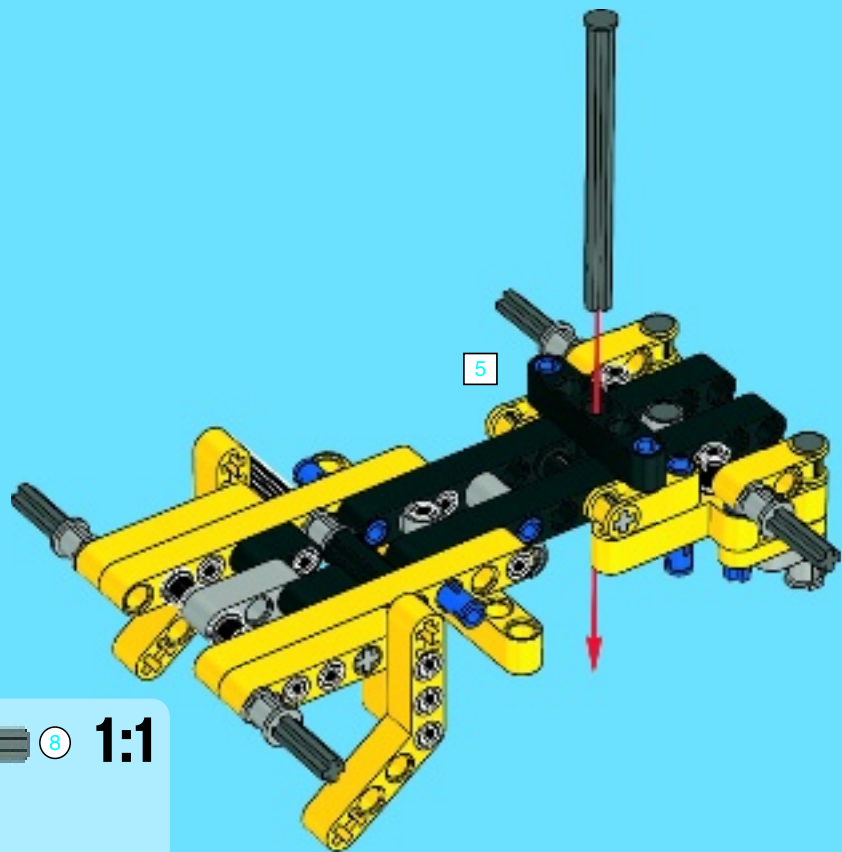

20



1x

22

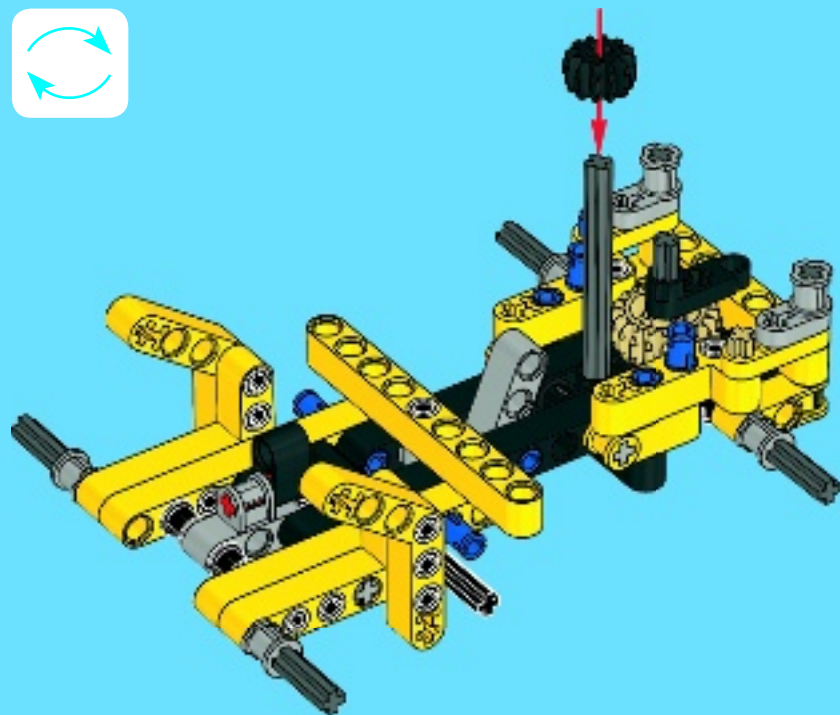

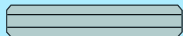

3



6

1:1



1x



1x

3

1



3



1x



1x

2



22



6

1x

3



6



2x



4

23

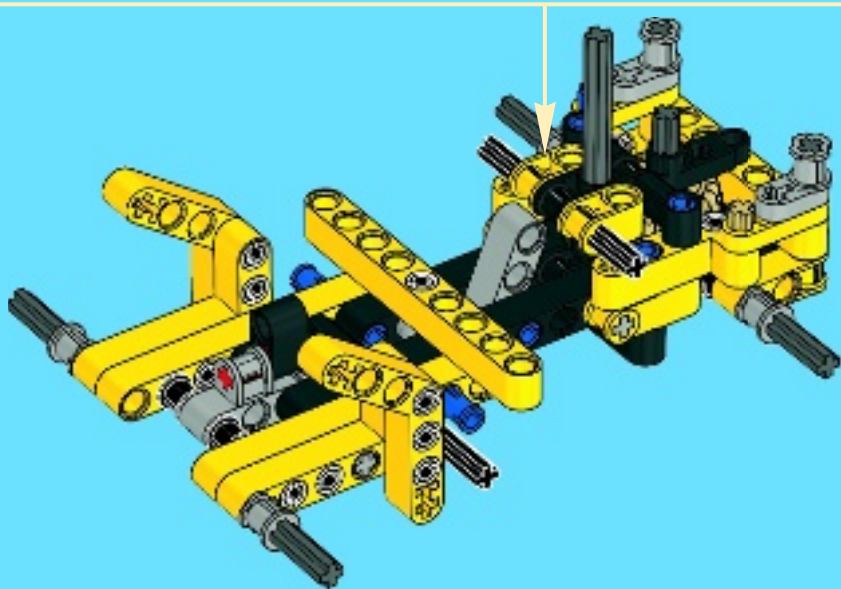



1x

24

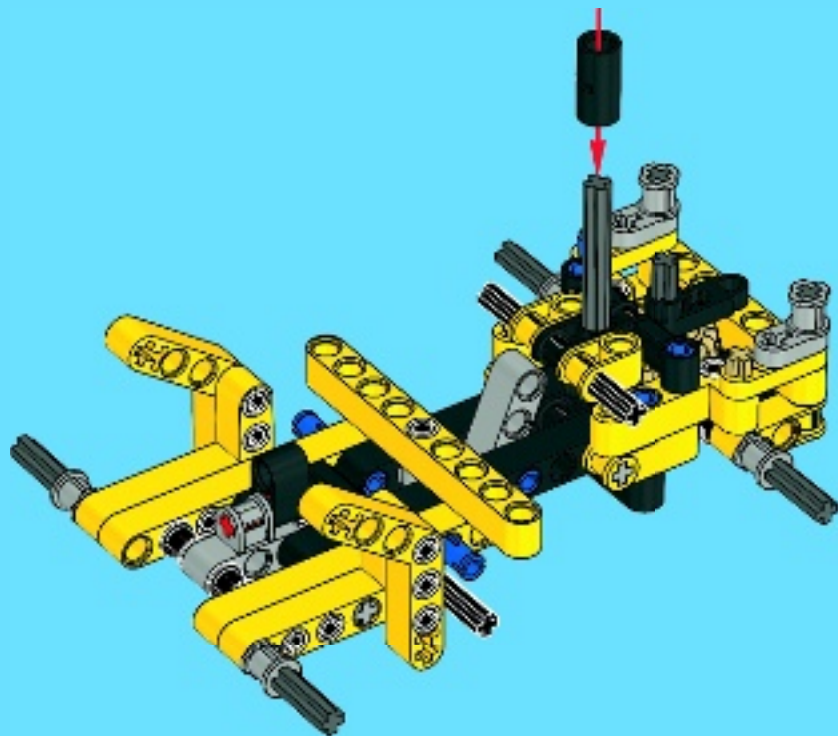



1x



1x

25

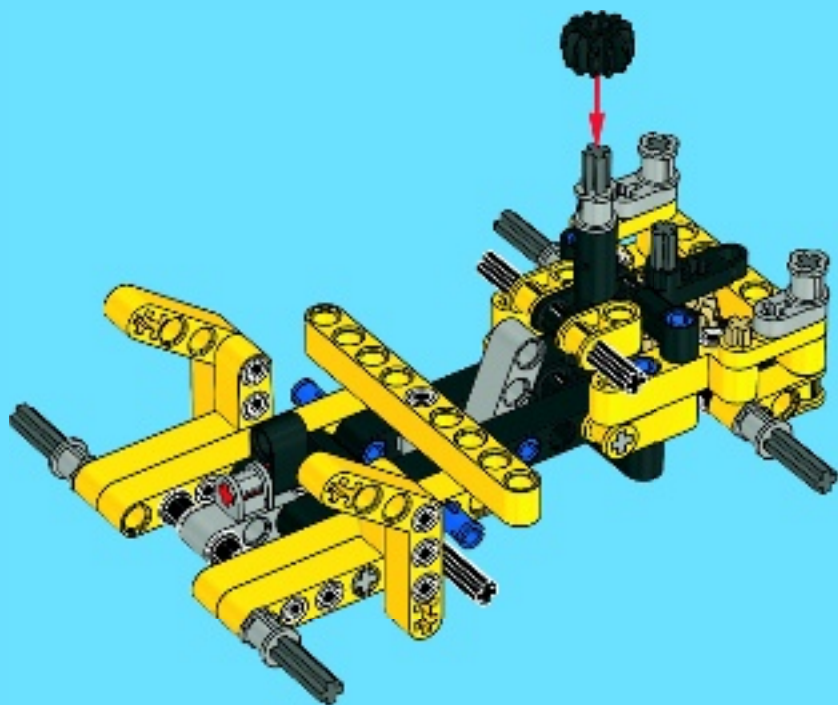

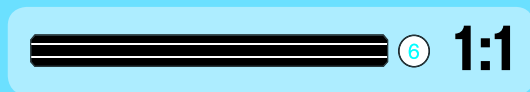
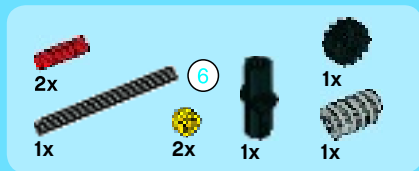

26

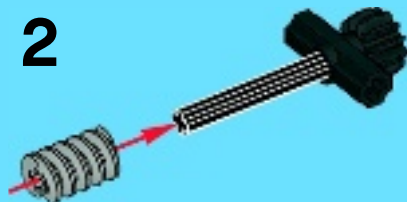
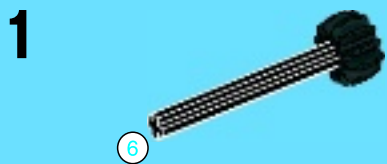

3

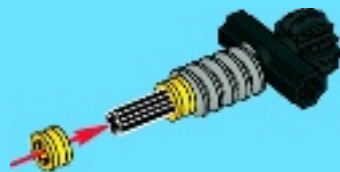

4

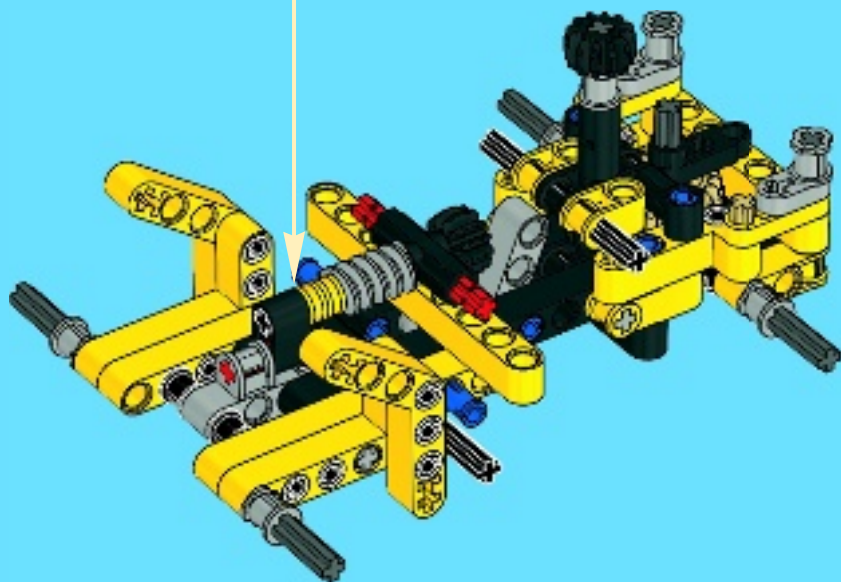

27

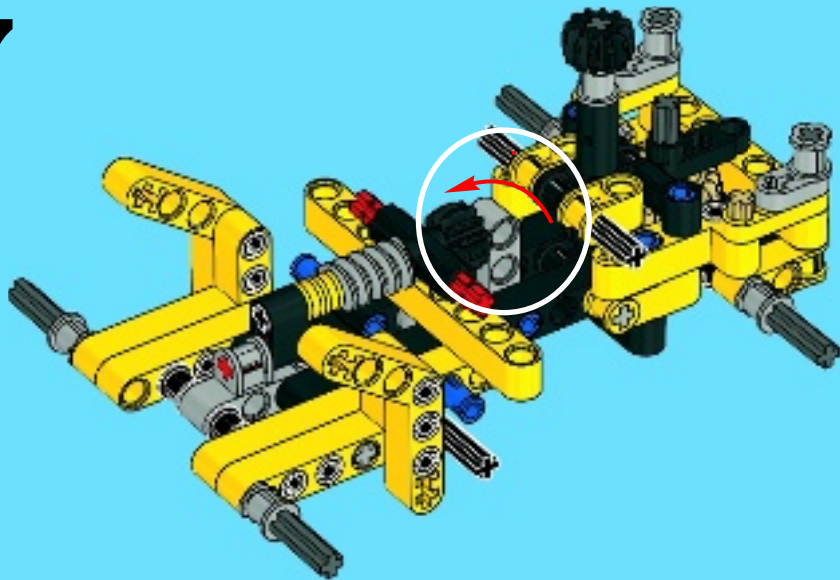

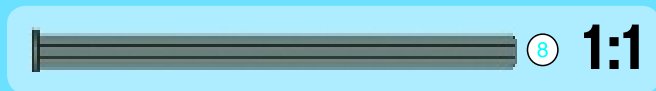
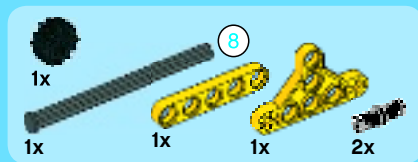

28

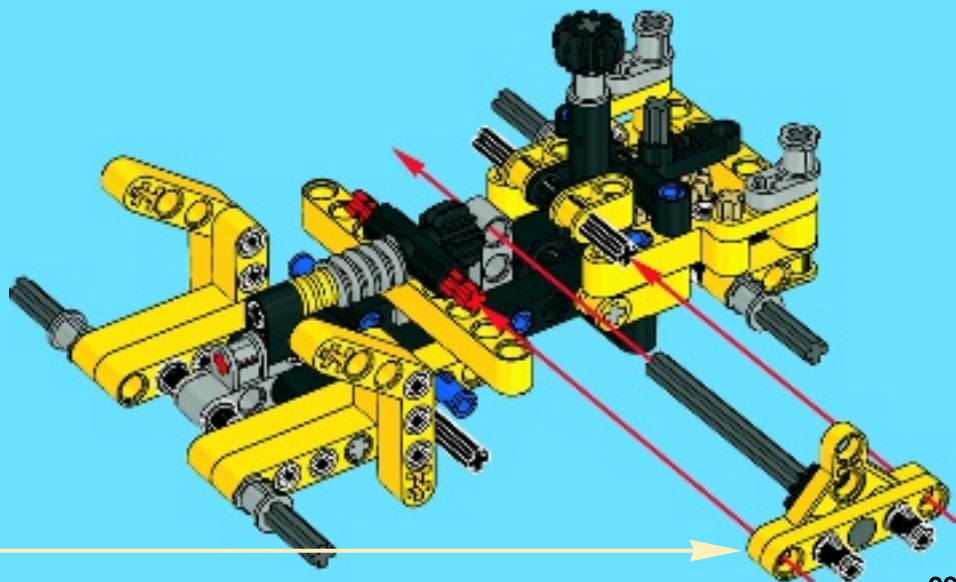
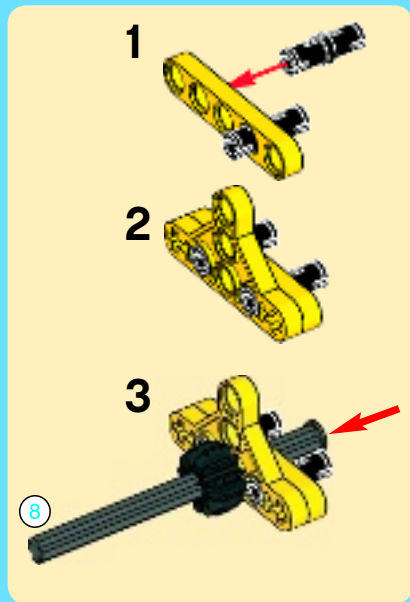



29

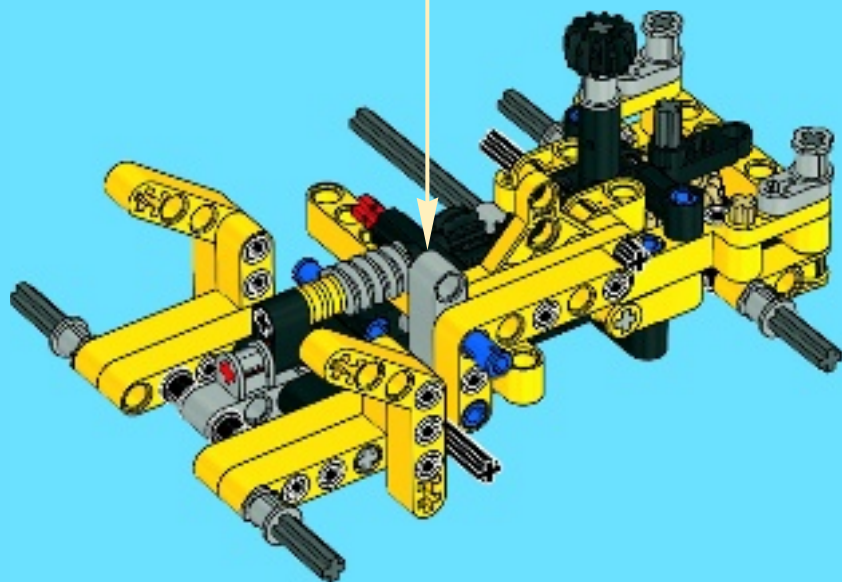
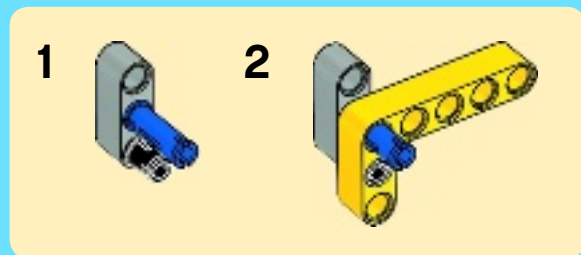

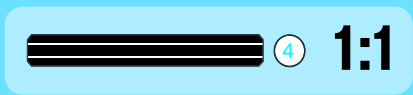
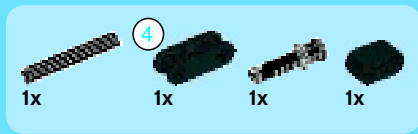

30

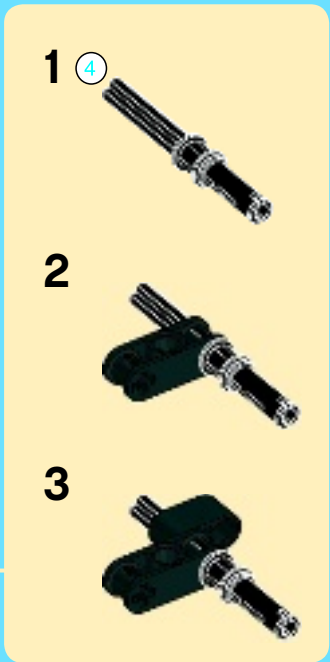
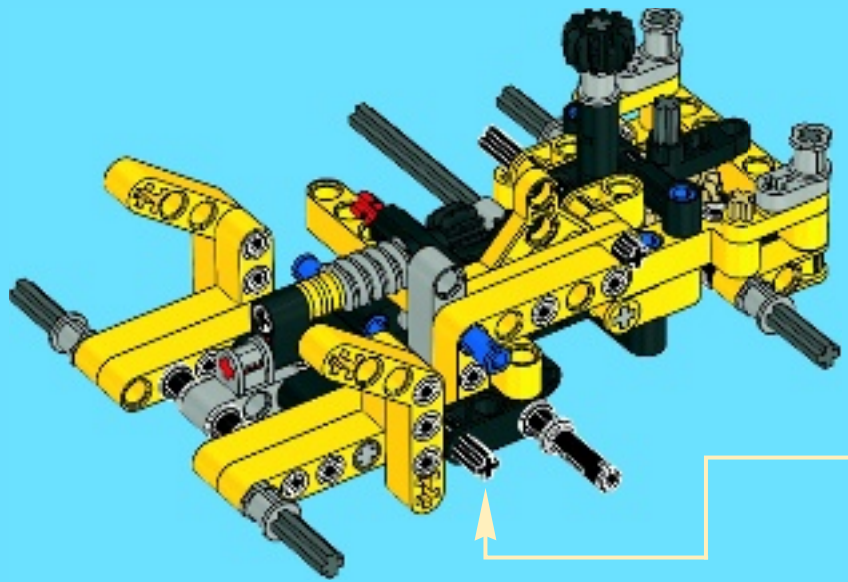



1x



1x

31

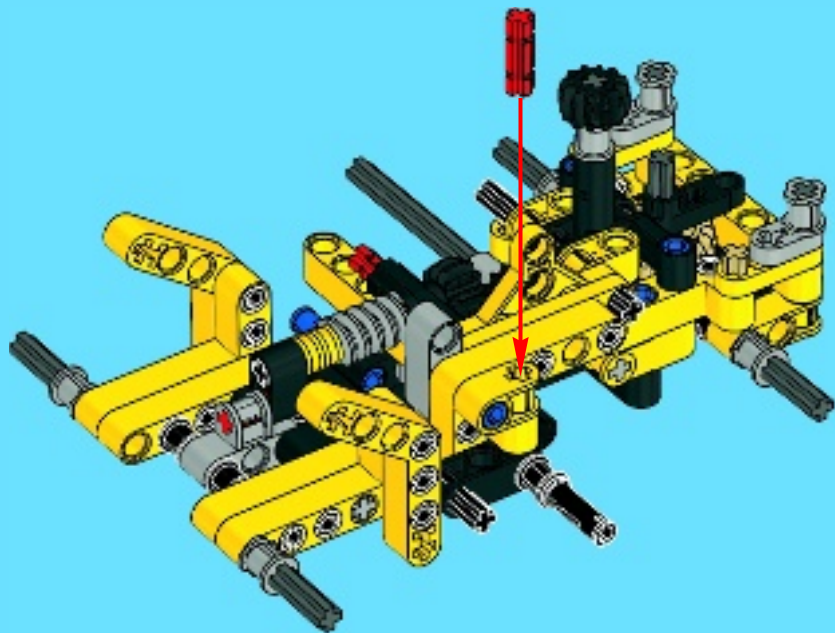

32

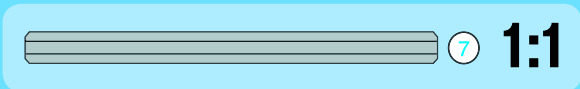
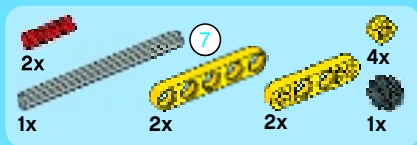

1

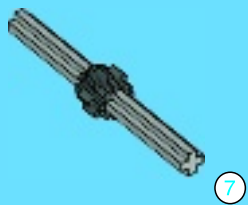

2



3

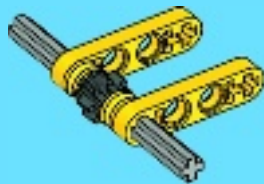

4

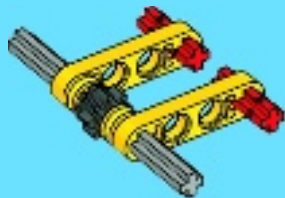

5

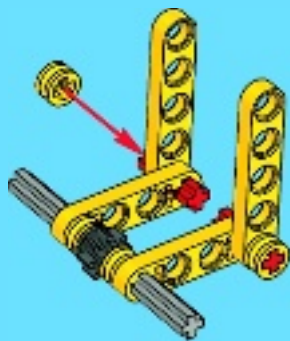

32

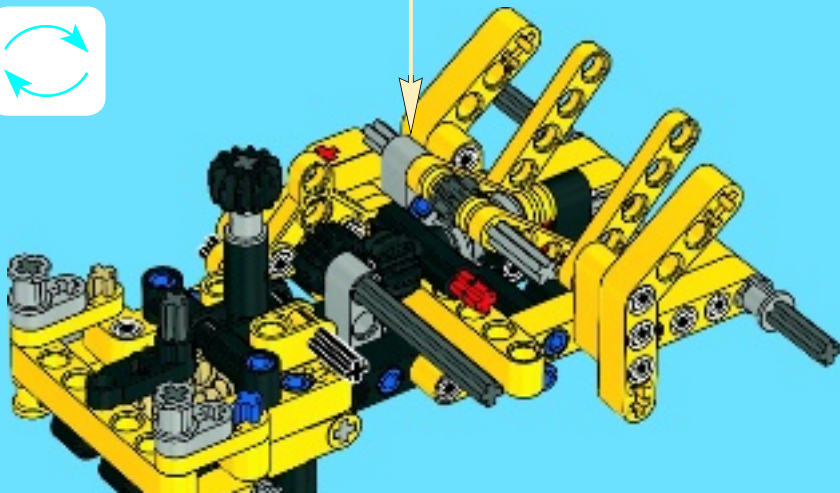

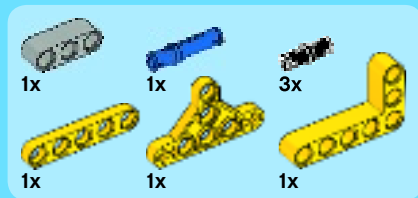

33

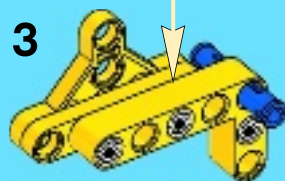

4

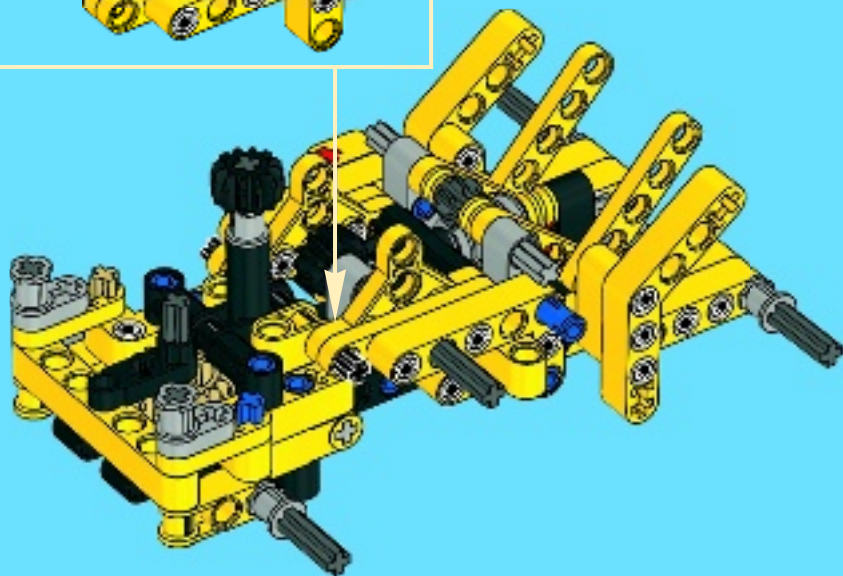
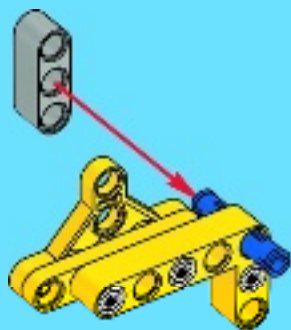



1x



1x

34

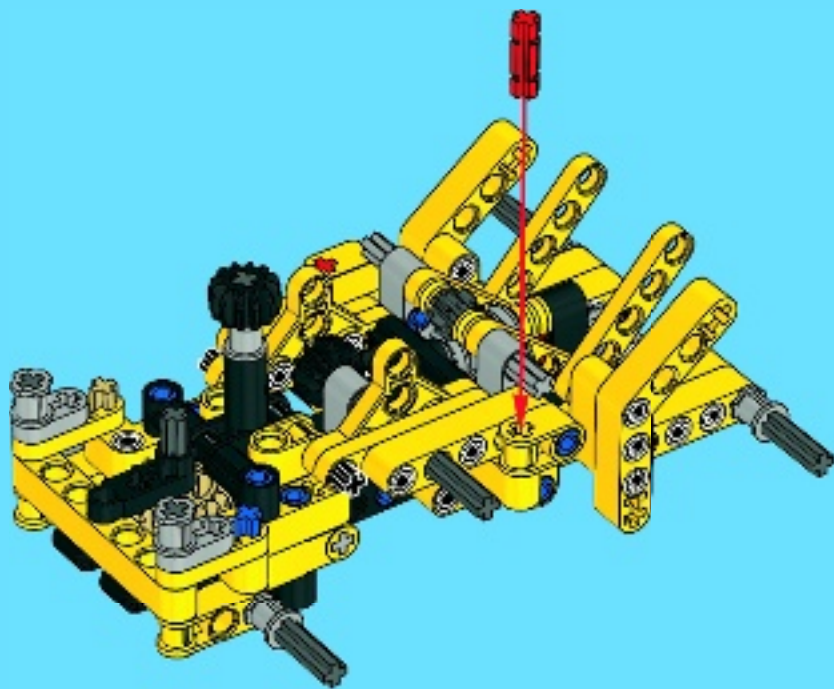



1x



1x

35

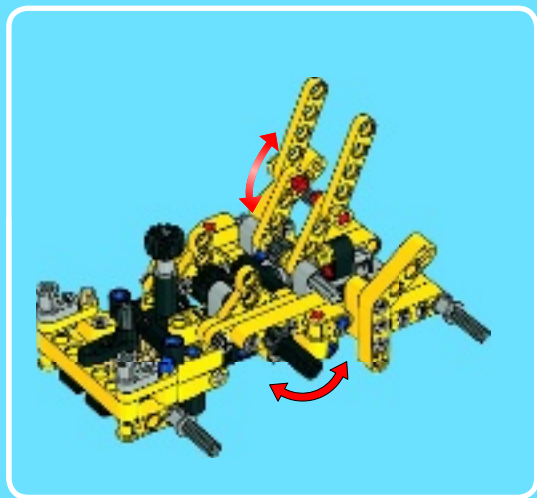
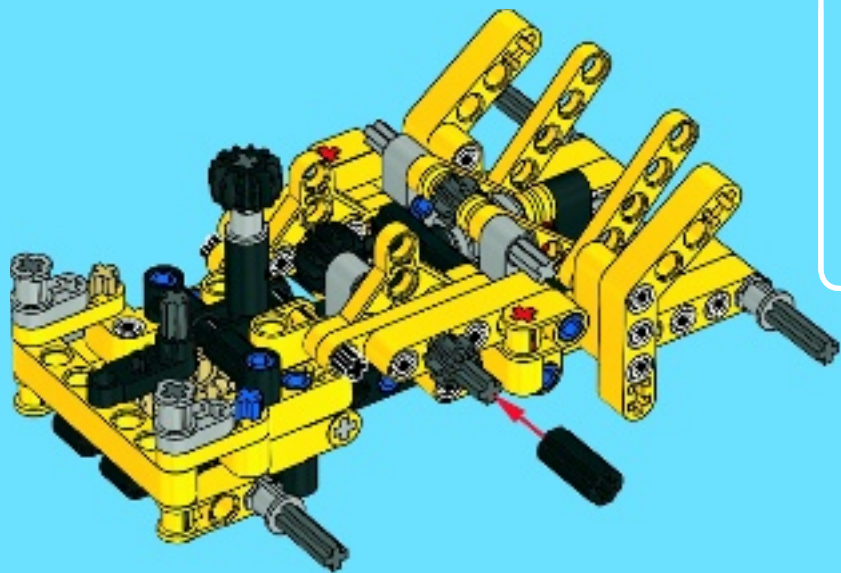



1x



1x



1x



1x

36

1



2

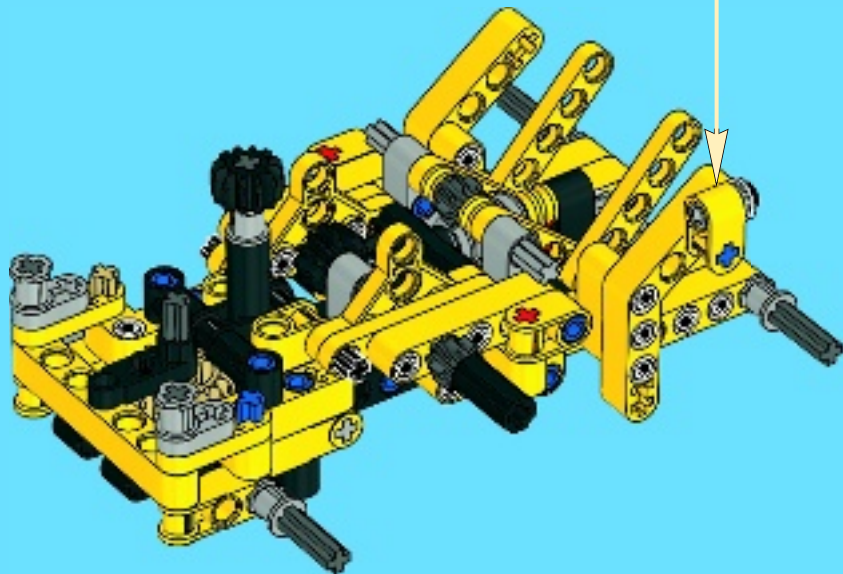
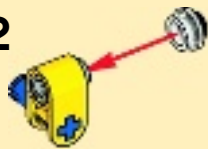



1

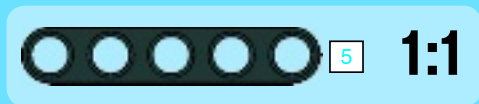
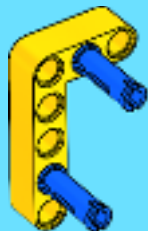

2



3





1x



1x

4

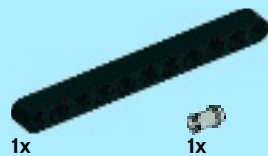
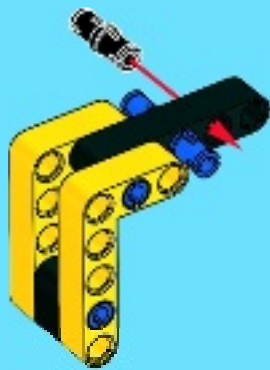

1x

11



1x



1x

5

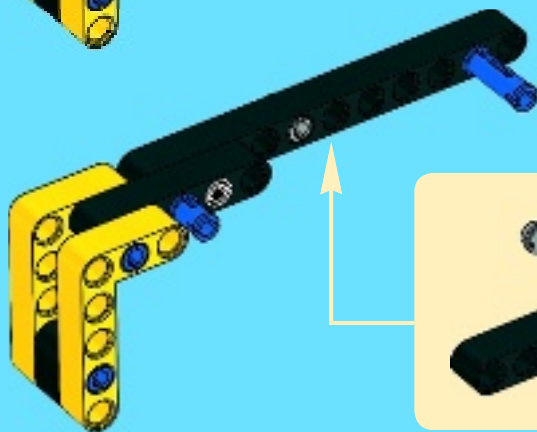

11



11

1:1



1x

6



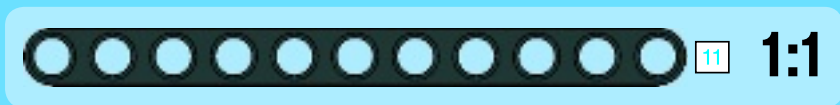

7

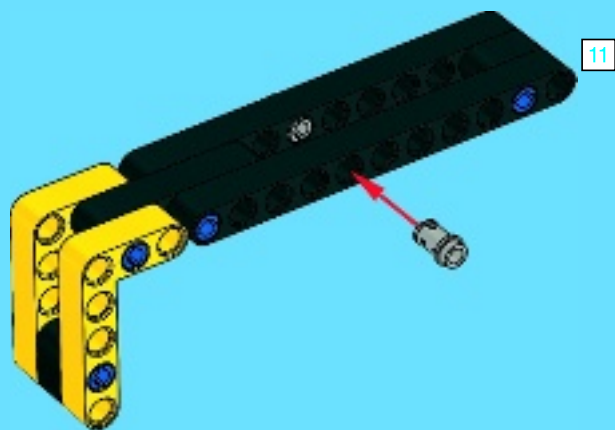

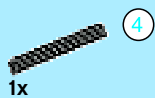

37

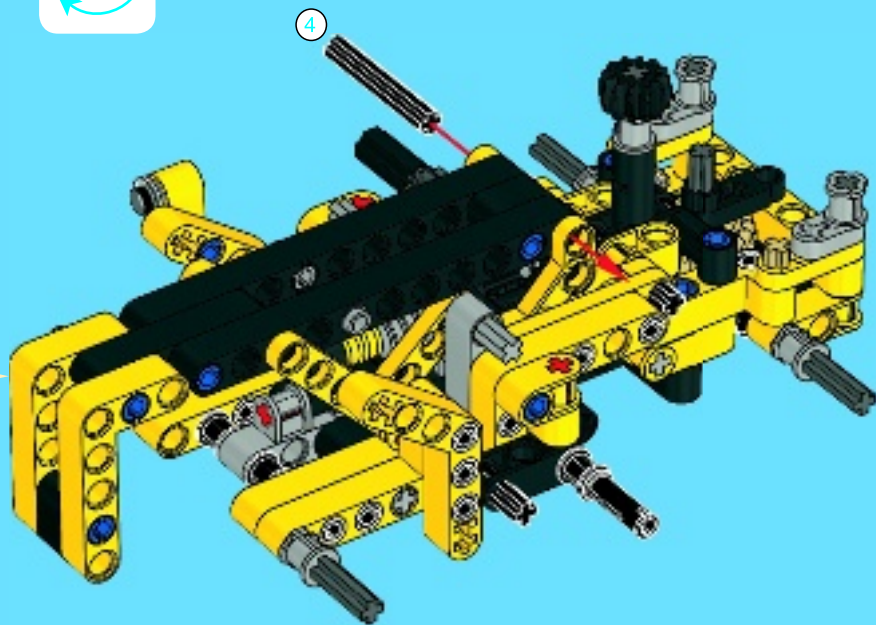



38

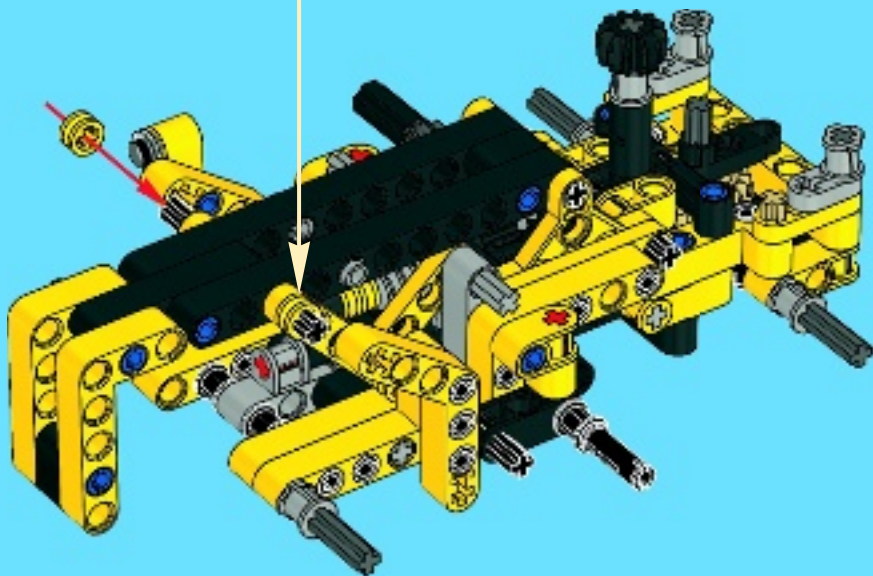

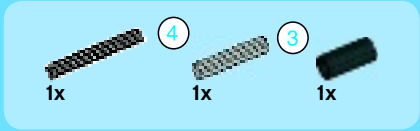
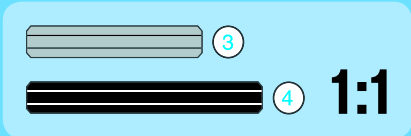

1



2



3

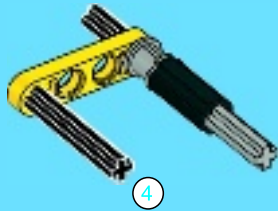

39

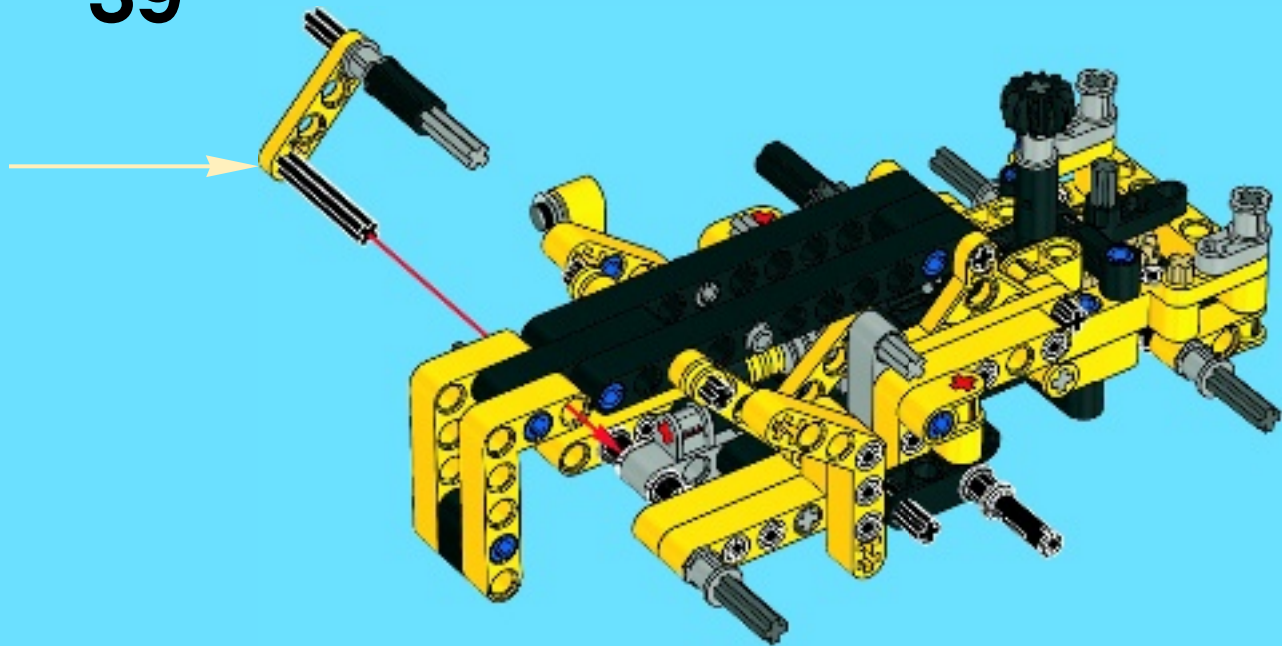



1x

40

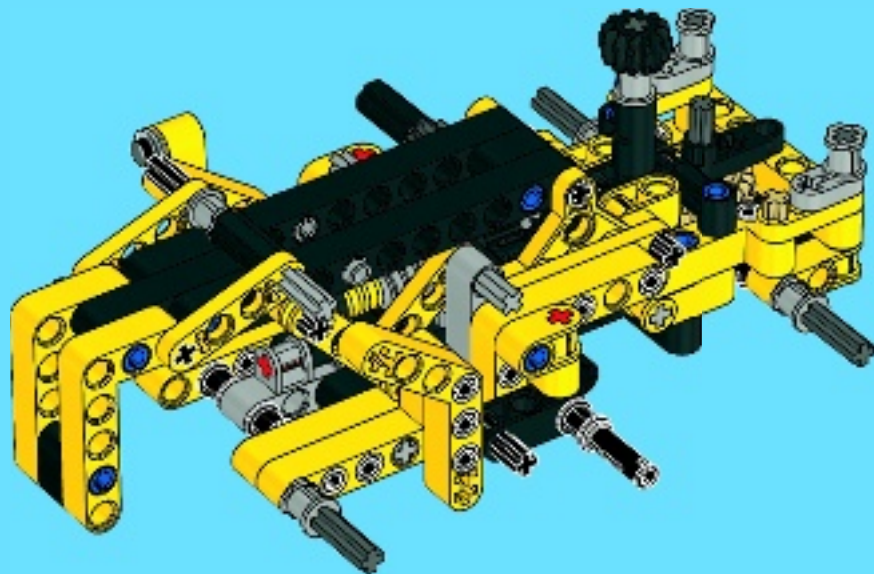



2x

41

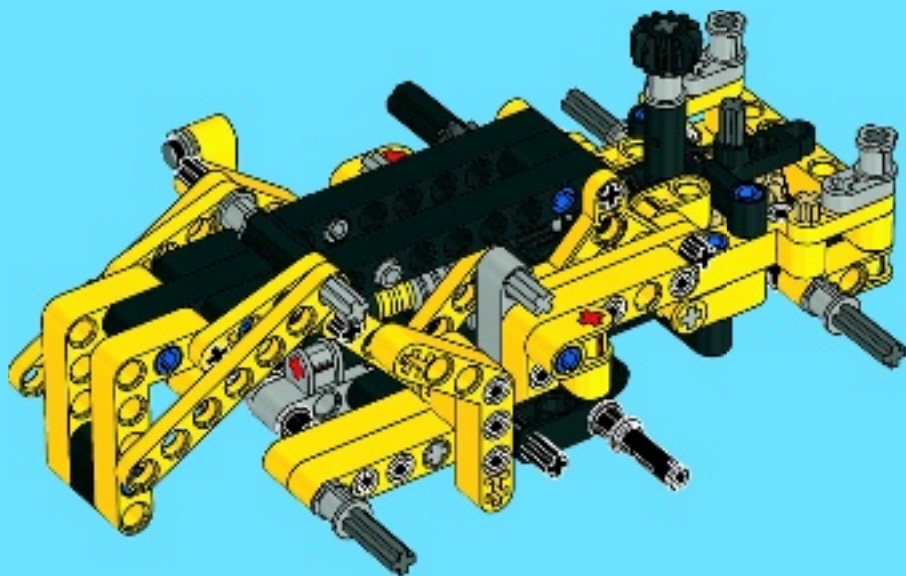



1x



1x

42

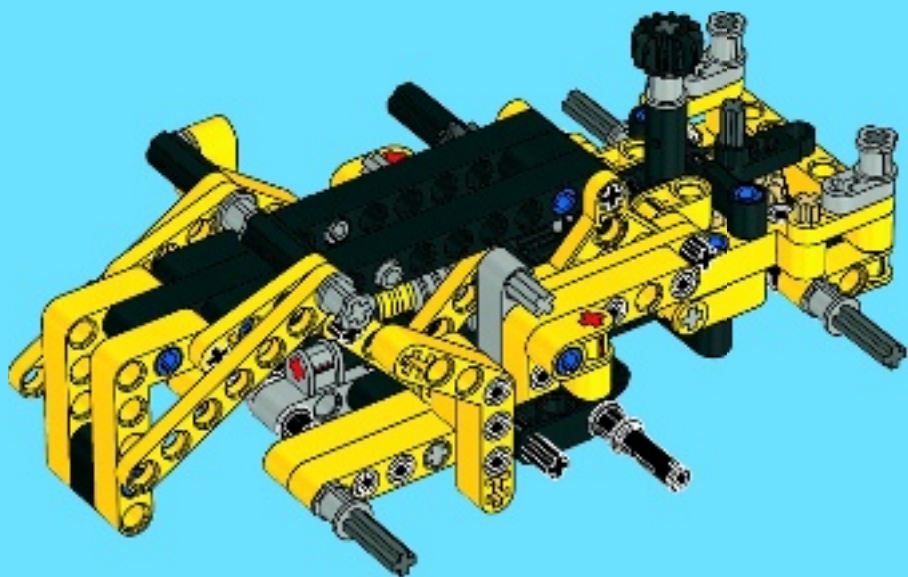



1x



1x



1x



1x



1x

1



2

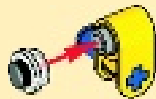

43

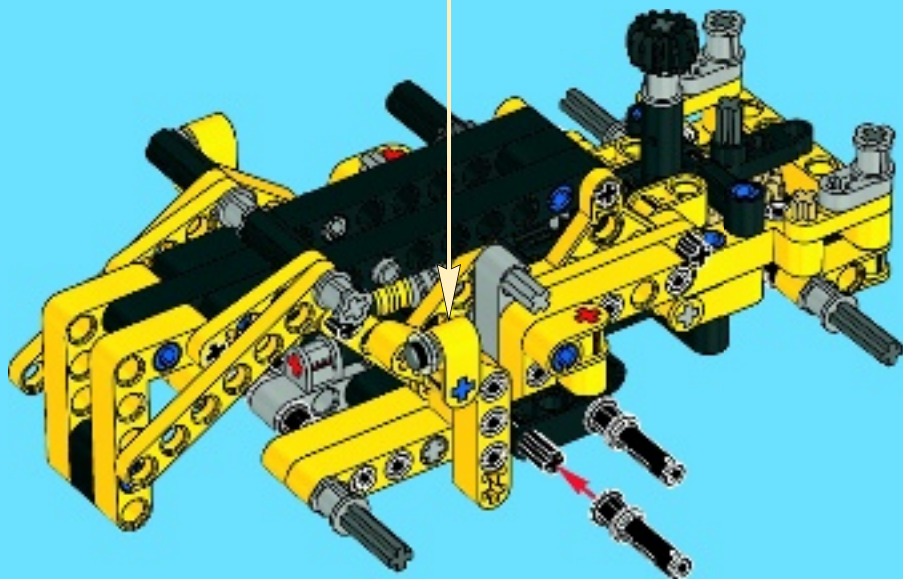

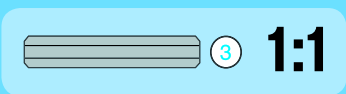

1

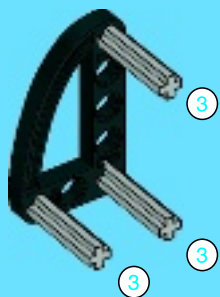

2





3

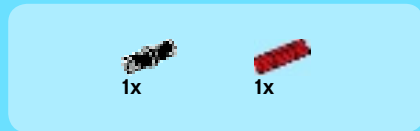
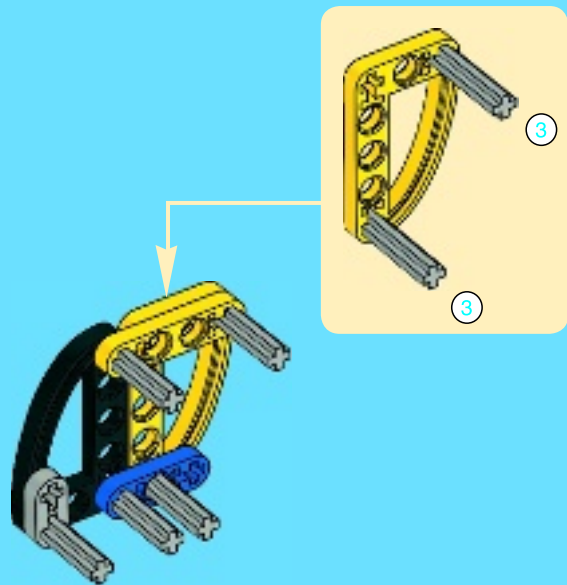

4

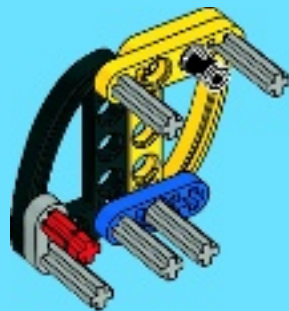



2x

5



1x



1x

6

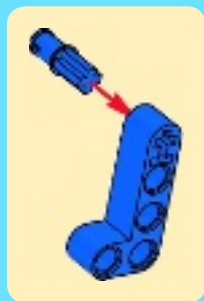
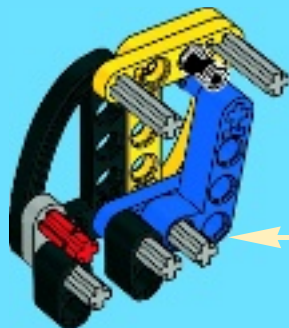



1x



1x



1x

7

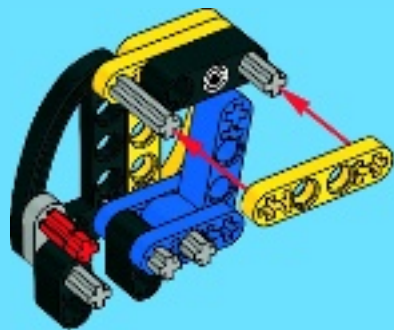

1x



1x



1x

8

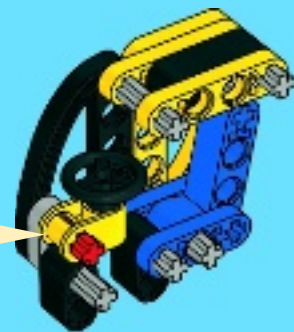
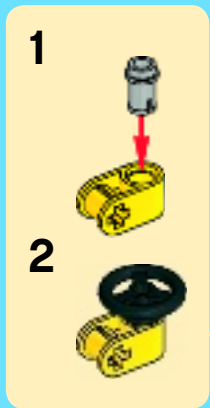



1x

9



1x



1x

10



44

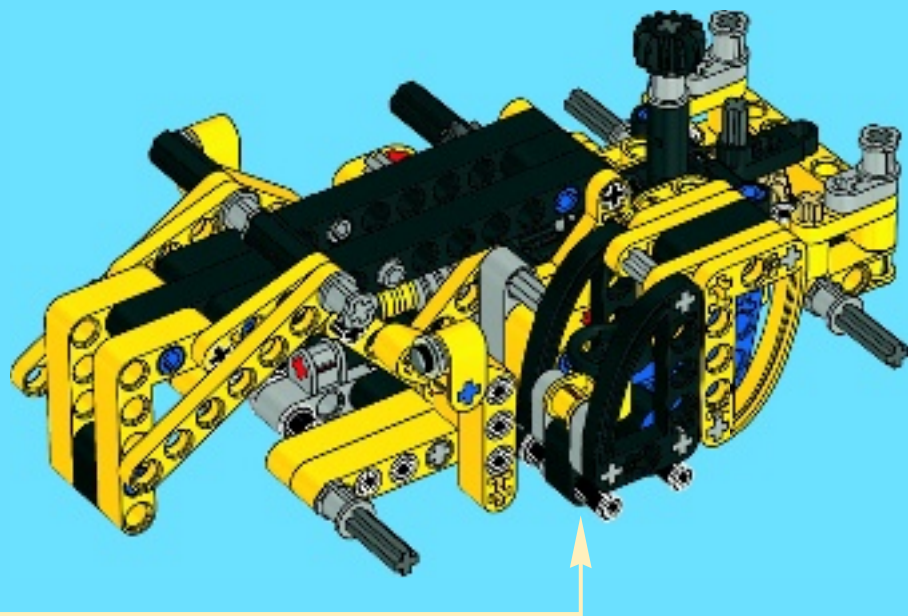



1x

45

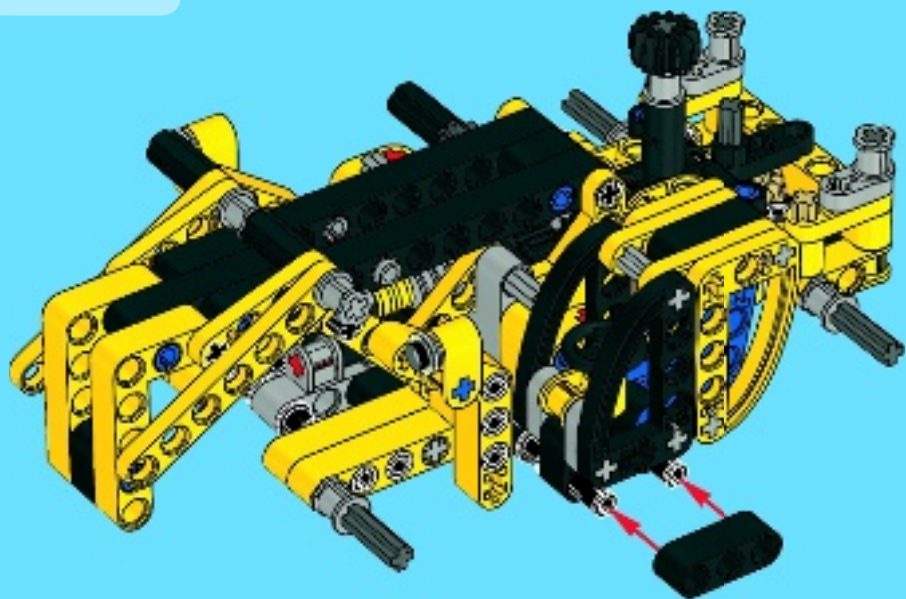



4x



4x

46

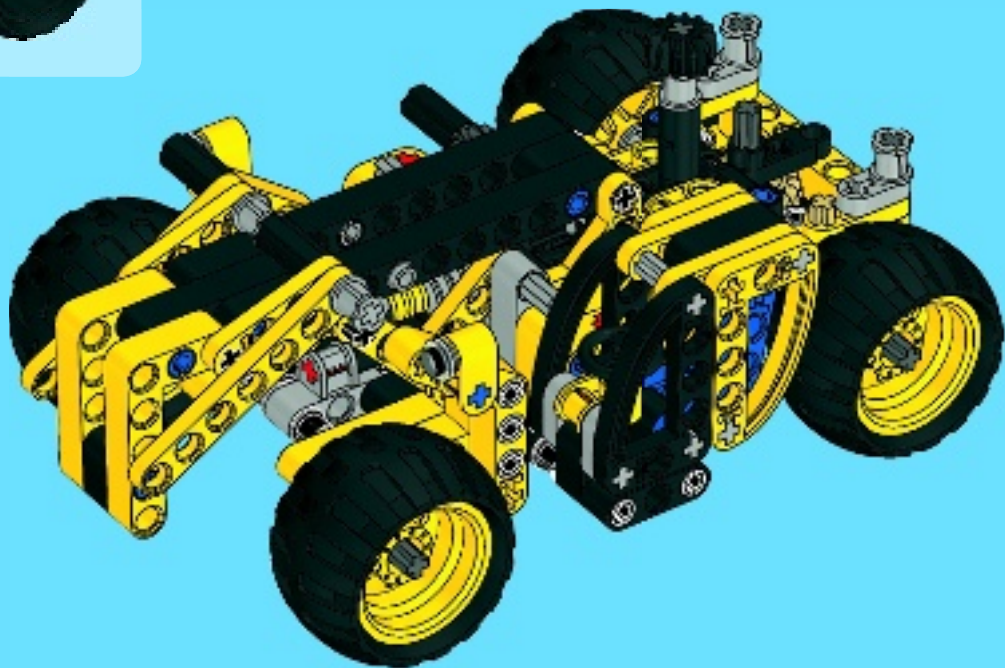

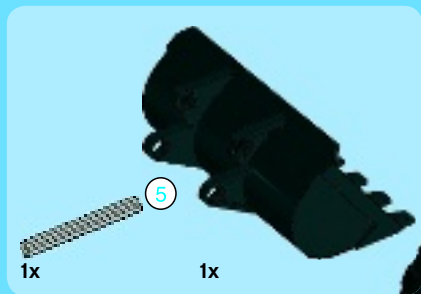

47

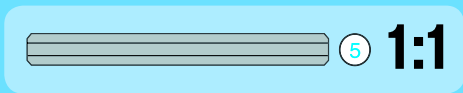



2x

48

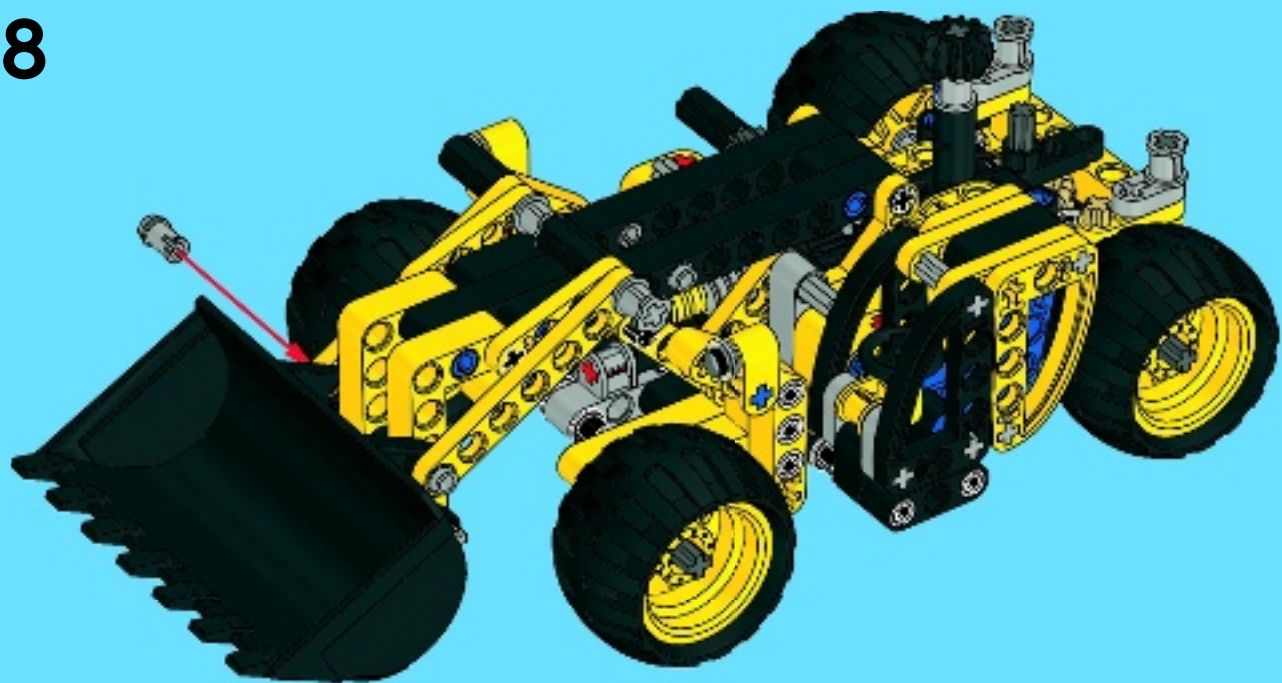



TECHNIC





TECHNIC



LEGO.com/technic



TECHNIC



42011



42004



42010



42002



42007



42006



42000



Customer Service
Kundenservice
Service Consommateurs
Servicio Al Consumidor

LEGO.com/service or dial

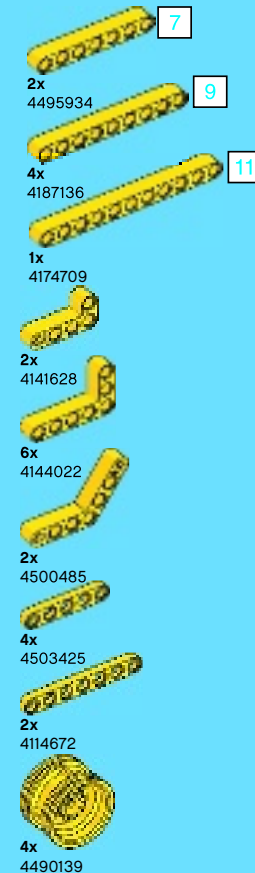
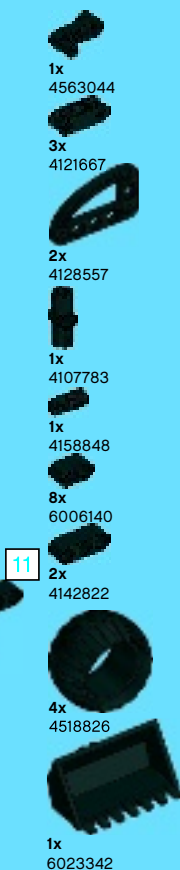



3



www.LEGOclub.com/Max

LEGO club™

FREE*! GRATIS! GRATUIT!

*Paid subscription in Australia and New Zealand.
*Abonnement payant en Australie et Nouvelle-Zélande.

©2013 The LEGO Group.





WIN!

Go to www.LEGOsurvey.com/product to fill out a survey for a chance to win a cool LEGO® Product.

No purchase necessary.

Open to all residents where not prohibited.



www.LEGOsurvey.com/product

GEWINNE!

Nimm an der Umfrage auf www.LEGOsurvey.com/product teil und hab die Chance ein cooles LEGO® Produkt zu gewinnen!

Die Teilnahme am Gewinnspiel führt zu keinerlei Kaufverpflichtungen. Teilnahme in allen nicht ausgeschlossenen Ländern möglich.

WIN!

Ga naar www.LEGOsurvey.com/product, vul een enquêteformulier in en maak kans op een cool LEGO® product.

Geen aankoopverplichting. Iedereen mag deelnemen, uitgezonderd ingezetenden van landen waar een enquêteverbod geldt.

GAGNE!

Visite www.LEGOsurvey.com/product pour répondre à un questionnaire et avoir une chance de gagner un produit LEGO® très cool!

Aucune obligation d'achat. Ouvert à tous les résidents des pays autorisés.

当てよう!

www.LEGOsurvey.com/product にアクセスして、アンケートにご記入ください。当選者にはレゴ®製品を差し上げます。

お買い上げの必要はありません。禁止されていない限り、すべての皆様にご利用いただけます。



LEGO.com

6033742 / 6033743

LEGO and the LEGO logo are trademarks of the/son des marques de commerce de/son marcas registradas de LEGO Group. ©2013 The LEGO Group.